

ELECTROMAGNETIC EMISSION COMPLIANCE REPORT FOR LOW-POWER, NON-LICENSED TRANSMITTER

Test Report No. : W164R-D021
AGR No. : A161A-258
Applicant : BLUEBIRD INC.
Address : (Dogok-dong, SEI Tower13,14)39, Eonjuro30-gil, Gangnam-gu, Seoul, South Korea
Manufacturer : BLUEBIRD INC.
Address : (Dogok-dong, SEI Tower13,14)39, Eonjuro30-gil, Gangnam-gu, Seoul, South Korea
Type of Equipment : Premium Tablet
FCC ID. : SS4RT100
Model Name : RT100
Serial number : N/A
Total page of Report : 122 pages (including this page)
Date of Incoming : February 01, 2016
Date of issue : April 06, 2016

SUMMARY

The equipment complies with the regulation; *FCC PART 15 SUBPART E Section 15.407*

This test report only contains the result of a single test of the sample supplied for the examination.

It is not a generally valid assessment of the features of the respective products of the mass-production.

Reviewed by: 

Jae-Ho, Lee / Chief Engineer
ONETECH Corp.

Approved by: 

Sung-Ik, Han / Managing Director
ONETECH Corp.

CONTENTS

	PAGE
1. VERIFICATION OF COMPLIANCE	7
2. TEST SUMMARY.....	8
2.1 TEST ITEMS AND RESULTS	8
2.2 ADDITIONS, DEVIATIONS, EXCLUSIONS FROM STANDARDS.....	8
2.3 RELATED SUBMITTAL(S) / GRANT(S)	8
2.4 PURPOSE OF THE TEST	8
2.5 TEST METHODOLOGY.....	8
2.6 TEST FACILITY.....	8
3. GENERAL INFORMATION.....	9
3.1 PRODUCT DESCRIPTION.....	9
3.2 ALTERNATIVE TYPE(S)/MODEL(S); ALSO COVERED BY THIS TEST REPORT.....	10
4. EUT MODIFICATIONS.....	10
5. SYSTEM TEST CONFIGURATION	11
5.1 JUSTIFICATION.....	11
5.2 PERIPHERAL EQUIPMENT	11
5.3 MODE OF OPERATION DURING THE TEST	12
5.4 CONFIGURATION OF TEST SYSTEM.....	16
5.5 ANTENNA REQUIREMENT	16
6. PRELIMINARY TEST	17
6.1 AC POWER LINE CONDUCTED EMISSIONS TESTS.....	17
6.2 GENERAL RADIATED EMISSIONS TESTS	17
7. MINIMUM 26 DB BANDWIDTH.....	18
7.1 OPERATING ENVIRONMENT	18
7.2 TEST SET-UP	18
7.3 TEST EQUIPMENT USED.....	18
7.4.1 Test data for 802.11a RLAN Mode	19
7.4.2 Test data for 802.11n_HT20 RLAN Mode.....	28
8. MAXIMUM PEAK OUTPUT POWER.....	37
8.1 OPERATING ENVIRONMENT	37
8.2 TEST SET-UP	37
8.3 TEST EQUIPMENT USED.....	37
8.4 TEST DATA FOR 802.11A RLAN MODE.....	38
8.5 TEST DATA FOR 802.11N_HT20 RLAN MODE.....	47

9. PEAK POWER SPECTRUL DENSITY	56
9.1 OPERATING ENVIRONMENT	56
9.2 TEST SET-UP	56
9.3 TEST EQUIPMENT USED	56
9.4 TEST DATA FOR 802.11A RLAN MODE.....	57
9.5 TEST DATA FOR 802.11N_HT20 RLAN MODE	66
10. FREQUENCY STABILITY WITH TEMPERATURE VARIATION.....	75
10.1 OPERATING ENVIRONMENT	75
10.2 TEST SET-UP	75
10.3 TEST EQUIPMENT USED	75
10.4 TEST DATA FOR 5 150 MHz ~ 5 250 MHz BAND.....	76
10.5 TEST DATA FOR 5 250 MHz ~ 5 350 MHz BAND.....	77
10.6 TEST DATA FOR 5 470 MHz ~ 5 725 MHz BAND.....	78
10.7 TEST DATA FOR 5 725 MHz ~ 5 850 MHz BAND.....	79
11. FREQUENCY STABILITY WITH VOLTAGE VARIATION.....	80
11.1 OPERATING ENVIRONMENT	80
11.2 TEST SET-UP	80
11.3 TEST EQUIPMENT USED	80
11.4 TEST DATA FOR 5 150 MHz ~ 5 250 MHz BAND.....	81
11.5 TEST DATA FOR 5 250 MHz ~ 5 350 MHz BAND.....	81
11.6 TEST DATA FOR 5 470 MHz ~ 5 725 MHz BAND.....	82
11.7 TEST DATA FOR 5 725 MHz ~ 5 850 MHz BAND.....	82
12. RADIATED SPURIOUS EMISSIONS	83
12.1 OPERATING ENVIRONMENT	83
12.2 TEST SET-UP FOR CONDUCTED MEASUREMENT	83
12.3 TEST EQUIPMENT USED	83
12.4 TEST DATA FOR 5 150 MHz ~ 5 250 MHz BAND	84
12.4.1 Test data for 30 MHz ~ 1 000 MHz.....	84
12.4.2 Test data for Below 30 MHz.....	85
12.4.3 Test data for above 1 GHz	86
12.5 TEST DATA FOR 5 250 MHz ~ 5 350 MHz BAND	87
12.5.1 Test data for 30 MHz ~ 1 000 MHz.....	87
12.5.2 Test data for Below 30 MHz.....	88
12.5.3 Test data for above 1 GHz	89
12.6 TEST DATA FOR 5 470 MHz ~ 5 725 MHz BAND	90
12.6.1 Test data for 30 MHz ~ 1 000 MHz.....	90
12.6.2 Test data for Below 30 MHz.....	91

12.6.3 Test data for above 1 GHz	92
12.7 TEST DATA FOR 5 725 MHz ~ 5 850 MHz BAND	93
12.7.1 Test data for 30 MHz ~ 1 000 MHz.....	93
12.7.2 Test data for Below 30 MHz.....	94
12.7.3 Test data for above 1 GHz	95
13. RADIATED RESTRICTED BAND EDGE MEASUREMENTS	96
13.1 OPERATING ENVIRONMENT	96
13.2 TEST SET-UP FOR CONDUCTED MEASUREMENT	96
13.3 TEST EQUIPMENT USED	96
13.4 TEST DATA FOR 5 150 MHz ~ 5 250 MHz BAND	97
13.4.1 Test data for 802.11a RLAN Mode	97
13.4.2 Test data for 802.11n_HT20 RLAN Mode	98
13.5 TEST DATA FOR 5 250 MHz ~ 5 350 MHz BAND	99
13.5.1 Test data for 802.11a RLAN Mode	99
13.5.2 Test data for 802.11n_HT20 RLAN Mode	100
13.6 TEST DATA FOR 5 725 MHz ~ 5 850 MHz BAND	101
13.6.1 Test data for 802.11a RLAN Mode	101
15.6.2 Test data for 802.11n_HT20 RLAN Mode.....	102
14. CONDUCTED EMISSION TEST.....	103
14.1 OPERATING ENVIRONMENT	103
14.2 TEST SET-UP	103
14.3 TEST EQUIPMENT USED	103
14.4 TEST DATA	104
14.4.1 Test data for 5 150 MHz ~ 5 250 MHz Band	104
14.4.2 Test data for 5 250 MHz ~ 5 350 MHz Band	106
14.4.3 Test data for 5 470 MHz ~ 5 725 MHz Band	108
14.4.4 Test data for 5 725 MHz ~ 5 850 MHz Band	110
15 DYNAMIC FREQUENCY SELECTION (DFS)	112
15.1 OPERATING ENVIRONMENT	112
15.2 TEST SET-UPS	112
15.3 DFS TEST SIGNALS	113
15.4 TECHNICAL REQUIREMENT SPECIFICATION	114
15.5 TEST EQUIPMENT USED	114
15.6 TEST DATA FOR 5 250 MHz ~ 5 350 MHz BAND	115
15.6.1 Plot of Radar waveform type1	115
15.6.2 No traffic signal(master signal).....	116
15.6.3 Client(EUT) Data Traiifc Signal.....	117

<i>15.6.4 Channel move and Channel Closing transmission time</i>	118
15.7 TEST DATA FOR 5 470 MHZ ~ 5 725 MHZ BAND	119
<i>15.7.1 Plot of Radar waveform type1</i>	119
<i>15.7.2 No traffic signal(master signal)</i>	120
<i>15.7.3 Client(EUT) Data Traiifc Signal</i>	121
<i>15.7.4 Channel move and Channel Closing transmission time</i>	122

Revision History

Issued Report No.	Issued Date	Revisions	Effect Section
W164R-D021	April 06, 2016	Initial Issue	All

1. VERIFICATION OF COMPLIANCE

Applicant : BLUEBIRD INC.
 Address : (Dogok-dong, SEI Tower13,14)39, Eonjuro30-gil, Gangnam-gu, Seoul, South Korea
 Contact Person : Jae-ho, Lee / Assistant Manager
 Telephone No. : +82-70-7730-8210
 FCC ID : SS4RT100
 Model Name : RT100
 Serial Number : N/A
 Date : April 06, 2016

EQUIPMENT CLASS	Unlicensed National Information infrastructure(UNII)
E.U.T. DESCRIPTION	Premium Tablet
THIS REPORT CONCERNS	Original Grant
MEASUREMENT PROCEDURES	ANSI C63.10: 2013
TYPE OF EQUIPMENT TESTED	Pre-Production
KIND OF EQUIPMENT AUTHORIZATION REQUESTED	Certification
EQUIPMENT WILL BE OPERATED UNDER FCC RULES PART(S)	FCC PART 15 SUBPART E Section 15.407
Modifications on the Equipment to Achieve Compliance	None
Final Test was Conducted On	3 m, Semi Anechoic Chamber

-. The above equipment was tested by ONETECH Corp. for compliance with the requirement set forth in the FCC Rules and Regulations. This said equipment in the configuration described in this report, shows the maximum emission levels emanating from equipment are within the compliance requirements.

2. TEST SUMMARY

2.1 Test items and results

SECTION	TEST ITEMS	RESULTS
15.407(a)	26 dB Bandwidth	PASS
15.407(a)	Maximum Conducted Output Power	Met the Limit / PASS
15.407(a)	Peak Power Spectral Density	Met the Limit / PASS
15.407(a)	Peak Excursion	Met the Limit / PASS
15.407(g)	Frequency Stability	Met the Limit / PASS
15.407(b)	Undesirable Emissions	Met the Limit / PASS
15.205, 15.407(b)	General Field Strength Limits (Restricted Band and Radiated Emission Limits)	Met the Limit / PASS
15.207	AC Conducted Emissions 150 kHz-30 MHz	Met the Limit / PASS
15.407(h)	Dynamic frequency Selection	Met the Limit / PASS

2.2 Additions, deviations, exclusions from standards

No additions, deviations or exclusions have been made from standard.

2.3 Related Submittal(s) / Grant(s)

Original submittal only

2.4 Purpose of the test

To determine whether the equipment under test fulfills the requirements of the regulation stated in FCC PART 15 SUBPART E Section 15.407

2.5 Test Methodology

Both conducted and radiated testing was performed according to the procedures in ANSI C63.10: 2013. Radiated testing was performed at a distance of 3 m from EUT to the antenna.

2.6 Test Facility

The Onetech Corp. has been designated to perform equipment testing in compliance with ISO/IEC 17025.

The Electromagnetic compatibility measurement facilities are located at 301-14, Daessangnyeong-ri, Chowol-eup, Gwangju-si, Gyeonggi-do, 464-862 Korea.

-. Site Filing:

VCCI (Voluntary Control Council for Interference) – Registration No. R-4112/ C-4617/ G-666/ T-1842

IC (Industry Canada) – Registration No. Site# 3736A-3

-. Site Accreditation:

KOLAS (Korea Laboratory Accreditation Scheme) - Accreditation NO. KT085

FCC (Federal Communications Commission) - Accreditation No. KR0013

RRA (Radio Research Agency) – Designation No. KR0013

3. GENERAL INFORMATION

3.1 Product Description

The BLUEBIRD INC., Model RT100 (referred to as the EUT in this report) is a Premium Tablet. Product specification information described herein was obtained from product data sheet or user’s manual.

DEVICE TYPE	Premium Tablet	
FREQUENCY RANGE	5 150 MHz ~ 5 250 MHz Band	802.11a/n(HT20): 5 180 MHz ~ 5 240 MHz
	5 250 MHz ~ 5 350 MHz Band	802.11a/n(HT20): 5 260 MHz ~ 5 320 MHz
	5 470 MHz ~ 5 725 MHz Band	802.11a/n(HT20): 5 500 MHz ~ 5 700 MHz
	5 725 MHz ~ 5 850 MHz Band	802.11a/n(HT20): 5 745 MHz ~ 5 825 MHz
MAX. RF OUTPUT POWER	5 150 MHz ~ 5 250 MHz Band	Wi-Fi 802.11a (9.66 dBm) Wi-Fi 802.11n_20 MHz (10.53 dBm)
	5 250 MHz ~ 5 350 MHz Band	Wi-Fi 802.11a (10.36 dBm) Wi-Fi 802.11n_20 MHz (10.22 dBm)
	5 470 MHz ~ 5 725 MHz Band	Wi-Fi 802.11a (8.59 dBm) Wi-Fi 802.11n_20 MHz (8.66 dBm)
	5 725 MHz ~ 5 850 MHz Band	Wi-Fi 802.11a (9.80 dBm) Wi-Fi 802.11n_20 MHz (9.93 dBm)
MODULATION TYPE	OFDM Modulation(BPSK/QPSK/16QAM/64QAM)	
Antenna Gain	5 150 MHz ~ 5 250 MHz Band	0.56 dBi
	5 250 MHz ~ 5 350 MHz Band	1.00 dBi
	5 470 MHz ~ 5 725 MHz Band	1.36 dBi
	5 725 MHz ~ 5 850 MHz Band	1.31 dBi
List of each Osc. or crystal Freq.(Freq. >= 1 MHz)	26 MHz	

3.2 Alternative type(s)/model(s); also covered by this test report.

-. None

4. EUT MODIFICATIONS

-. None

5. SYSTEM TEST CONFIGURATION

5.1 Justification

This device was configured for testing in a typical way as a normal customer is supposed to be used. During the test, the following components were installed inside of the EUT.

DEVICE TYPE	MANUFACTURER	MODEL/PART NUMBER	FCC ID
Display Controller Board	Kingdisplay	KD101N37-40NA-A1-REVB	
Display Panel	N/A	N/A	
Main Board	N/A	N/A	
Battery	GSP Limited	BAT-RT100	
SUB Board	N/A	TVE1010IRT-SUB-V1.1	
Sensor	N/A	CMK-TVE1010I-B-1-V5B1.0	
Antenna	N/A	DIT / Rev 5.0	
Camera module	N/A	CMK-TVE1010I-F-V2B2.0	
Touch sensor controller Board	N/A	101332C-Q-00	
Wireless Module	HUAWEI TECHNOLOGIES CO.,LTD.	MU739	QISMU739

5.2 Peripheral equipment

Defined as equipment needed for correct operation of the EUT, but not considered as tested:

Model	Manufacturer	Description	Connected to
N/A	N/A	N/A	N/A

5.3 Mode of operation during the test

For the testing, software used to control the EUT for staying in continuous transmitting mode is programmed.

5 150 MHz ~ 5 250 MHz Band

Modulation & Channel selected	DATA RATE	OUTPUT POWER
802.11a (High Channel)	6 Mbps	9.66
	9 Mbps	9.62
	12 Mbps	9.54
	18 Mbps	9.44
	24 Mbps	9.38
	36 Mbps	9.31
	48 Mbps	9.30
	54 Mbps	9.23
802.11n(HT20) (High Channel)	6.5 Mbps	10.53
	13 Mbps	10.47
	19.5 Mbps	10.37
	26 Mbps	10.33
	39 Mbps	10.29
	52 Mbps	10.24
	58.5 Mbps	10.20
	65 Mbps	10.17

The worse case data rate for each modulation is determined 6 Mbps for IEEE 802.11a and 6.5 Mbps for IEEE 802.11n(HT20).

- To get a maximum emission levels from the EUT, the EUT was moved throughout the XY, XZ, and YZ planes and the worst case is “XY” axis.

5 250 MHz ~ 5 350 MHz Band

Modulation & Channel selected	DATA RATE	OUTPUT POWER
802.11a (Middle Channel)	6 Mbps	10.36
	9 Mbps	10.31
	12 Mbps	10.28
	18 Mbps	10.20
	24 Mbps	10.12
	36 Mbps	10.08
	48 Mbps	9.93
	54 Mbps	9.81
802.11n(HT20) (Middle Channel)	6.5 Mbps	10.22
	13 Mbps	10.10
	19.5 Mbps	10.08
	26 Mbps	10.02
	39 Mbps	9.94
	52 Mbps	9.83
	58.5 Mbps	9.78
	65 Mbps	9.77

The worse case data rate for each modulation is determined 6 Mbps for IEEE 802.11a and 6.5 Mbps for IEEE 802.11n(HT20).

- To get a maximum emission levels from the EUT, the EUT was moved throughout the XY, XZ, and YZ planes and the worst case is “XY” axis.

5 470 MHz ~ 5 725 MHz Band

Modulation & Channel selected	DATA RATE	OUTPUT POWER
802.11a (Low Channel)	6 Mbps	8.95
	9 Mbps	8.83
	12 Mbps	8.81
	18 Mbps	8.75
	24 Mbps	8.64
	36 Mbps	8.60
	48 Mbps	8.56
	54 Mbps	8.58
802.11n(HT20) (Low Channel)	6.5 Mbps	8.66
	13 Mbps	8.61
	19.5 Mbps	8.58
	26 Mbps	8.51
	39 Mbps	8.45
	52 Mbps	8.42
	58.5 Mbps	8.42
	65 Mbps	8.40

The worse case data rate for each modulation is determined 6 Mbps for IEEE 802.11a and 6.5 Mbps for IEEE 802.11n(HT20).

- To get a maximum emission levels from the EUT, the EUT was moved throughout the XY, XZ, and YZ planes and the worst case is “XY” axis.

5 725 MHz ~ 5 850 MHz Band

Modulation & Channel selected	DATA RATE	OUTPUT POWER
802.11a (Low Channel)	6 Mbps	9.80
	9 Mbps	9.77
	12 Mbps	8.75
	18 Mbps	8.69
	24 Mbps	8.66
	36 Mbps	9.64
	48 Mbps	9.62
	54 Mbps	9.62
802.11n(HT20) (Low Channel)	6.5 Mbps	9.93
	13 Mbps	9.92
	19.5 Mbps	9.90
	26 Mbps	9.86
	39 Mbps	9.81
	52 Mbps	9.84
	58.5 Mbps	9.82
	65 Mbps	9.78

The worse case data rate for each modulation is determined 6 Mbps for IEEE 802.11a and 6.5 Mbps for IEEE 802.11n(HT20).

- To get a maximum emission levels from the EUT, the EUT was moved throughout the XY, XZ, and YZ planes and the worst case is “XY” axis.

5.4 Configuration of Test System

Line Conducted Test: The EUT was tested in a Transmitting mode. The EUT was connected to USB and the power of USB was connected to Adapter. All supporting equipments were connected to another LISN. Preliminary Power line Conducted Emission test was performed by using the procedure in ANSI C63.10: 2013 to determine the worse operating conditions.

Radiated Emission Test: Preliminary radiated emissions test were conducted using the procedure in ANSI C63.10: 2013 to determine the worse operating conditions. Final radiated emission tests were conducted at 3 meter open area test site.

The turntable was rotated through 360 degrees and the EUT was tested by positioned three orthogonal planes to obtain the highest reading on the field strength meter. Once maximum reading was determined, the search antenna was raised and lowered in both vertical and horizontal polarization.

5.5 Antenna Requirement

For intentional device, according to section 15.203, an intentional radiator shall be designed to ensure that no antenna other than that furnished by the responsible party shall be used with the device.

Antenna Construction:

The transmitter antenna of the EUT is a PIFA Antenna, so no consideration of replacement by the user.

6. PRELIMINARY TEST

6.1 AC Power line Conducted Emissions Tests

During Preliminary Test, the following operating mode was investigated.

Operation Mode	The Worse operating condition (Please check one only)
Transmitting Mode	X

6.2 General Radiated Emissions Tests

During Preliminary Test, the following operating mode was investigated.

Operation Mode	The Worse operating condition (Please check one only)
Transmitting Mode	X

7. MINIMUM 26 dB BANDWIDTH

7.1 Operating environment

Temperature : 22 °C

Relative humidity : 55 % R.H.

7.2 Test set-up

The antenna output of the EUT was connected to the spectrum analyzer. The resolution bandwidth is set to 100 kHz, and peak detection was used. The 26 dB bandwidth is defined as the total spectrum over which the power is higher than the peak power minus 26 dB.

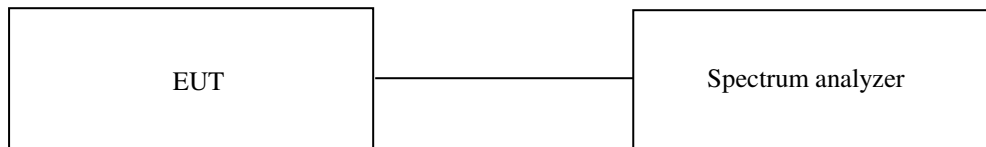

7.3 Test equipment used

Model Number	Manufacturer	Description	Serial Number	Last Cal.
■ - FSV40	Rohde & Schwarz	Signal Analyzer	101009	Jul. 22, 2015 (1Y)

All test equipment used is calibrated on a regular basis.

7.4.1 Test data for 802.11a RLAN Mode

-. Test Date : March 15, 2016

-. Test Result : Pass

FREQUENCY RANGE (MHz)	CHANNEL	FREQUENCY (MHz)	26 dB Bandwidth (MHz)
5 150 ~ 5 250	Low	5 180	18.34
	Middle	5 200	18.34
	High	5 240	18.34
5 250 ~ 5 350	Low	5 260	18.34
	Middle	5 300	18.34
	High	5 320	18.34
5 470 ~ 5 725	Low	5 500	18.34
	Middle	5 600	18.34
	High	5 700	18.34
5 725 ~ 5 850	Low	5 745	18.34
	Middle	5 785	18.34
	High	5 825	18.34



Tested by: Jun-Hui, Lee / Senior Engineer

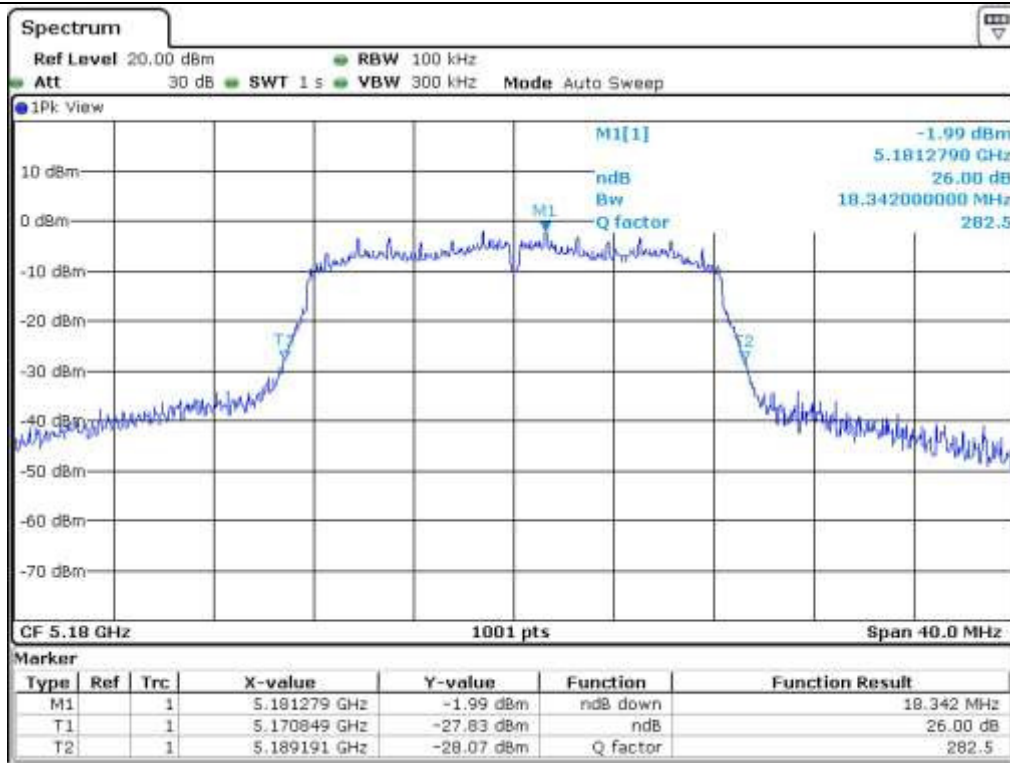

Low Channel (5 180 MHz)

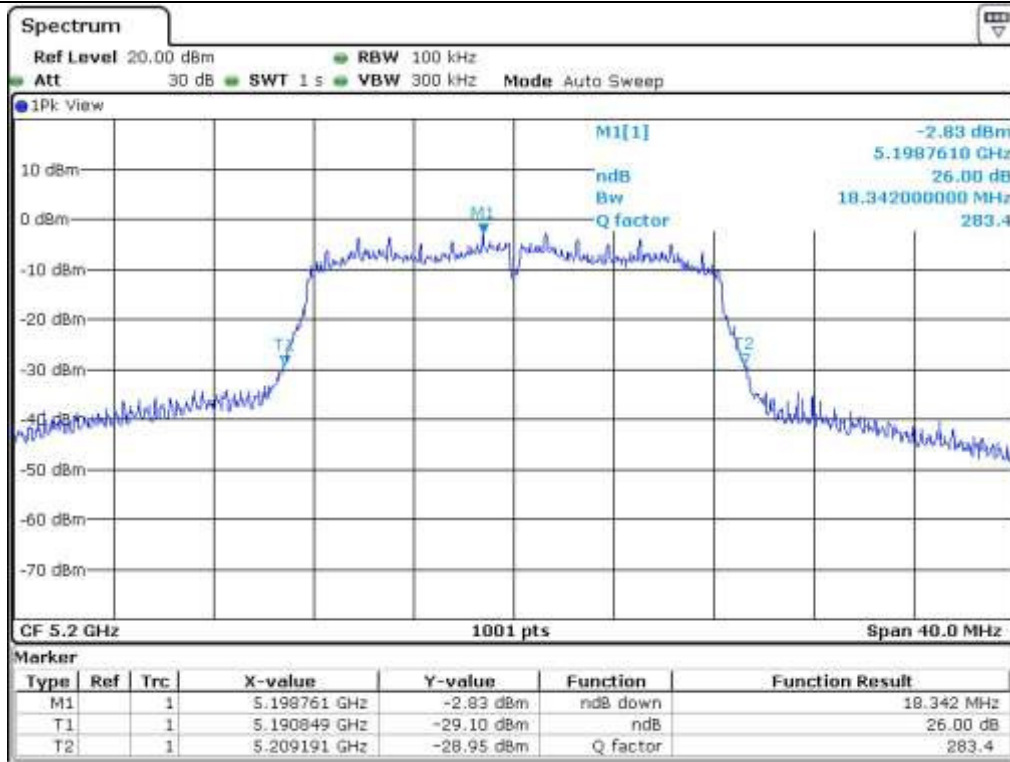

Middle Channel (5 200 MHz)

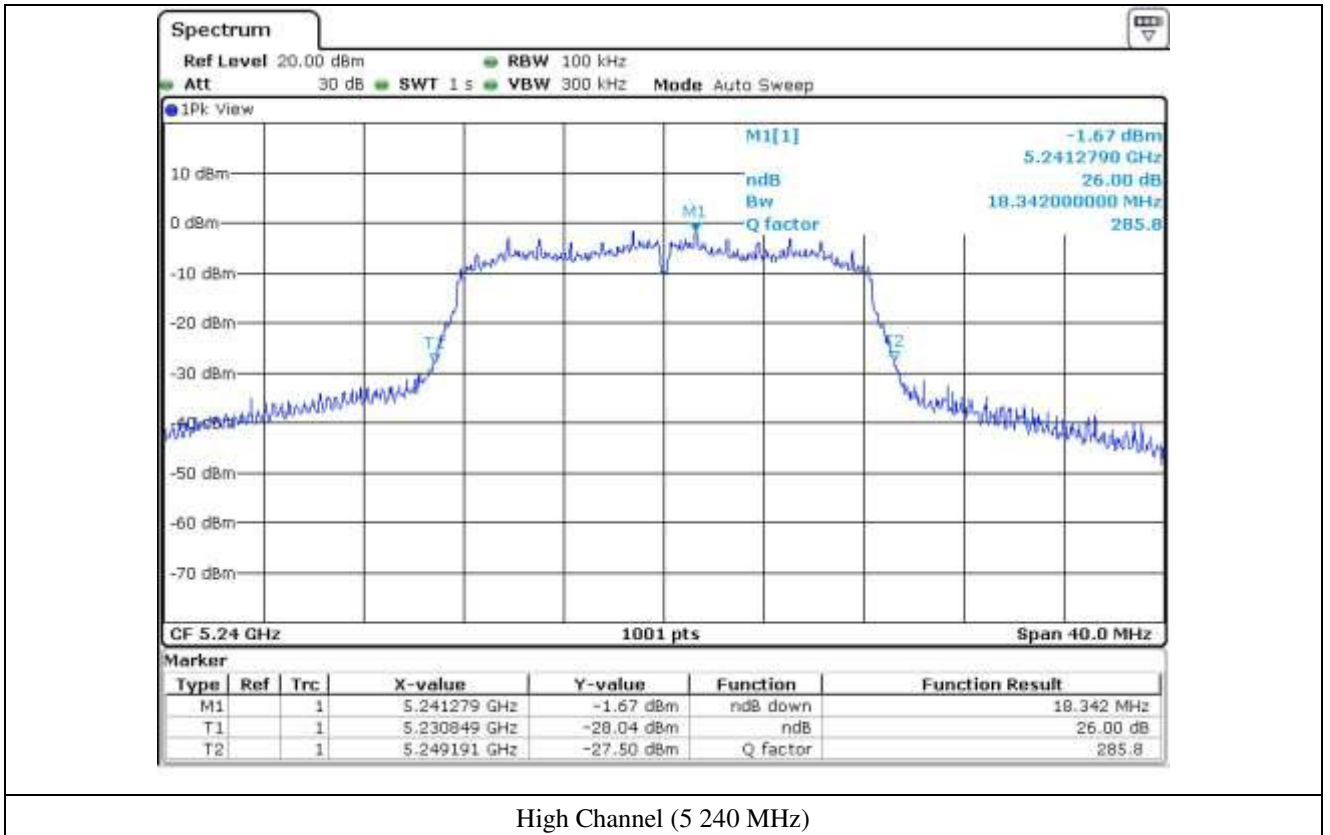

High Channel (5 240 MHz)

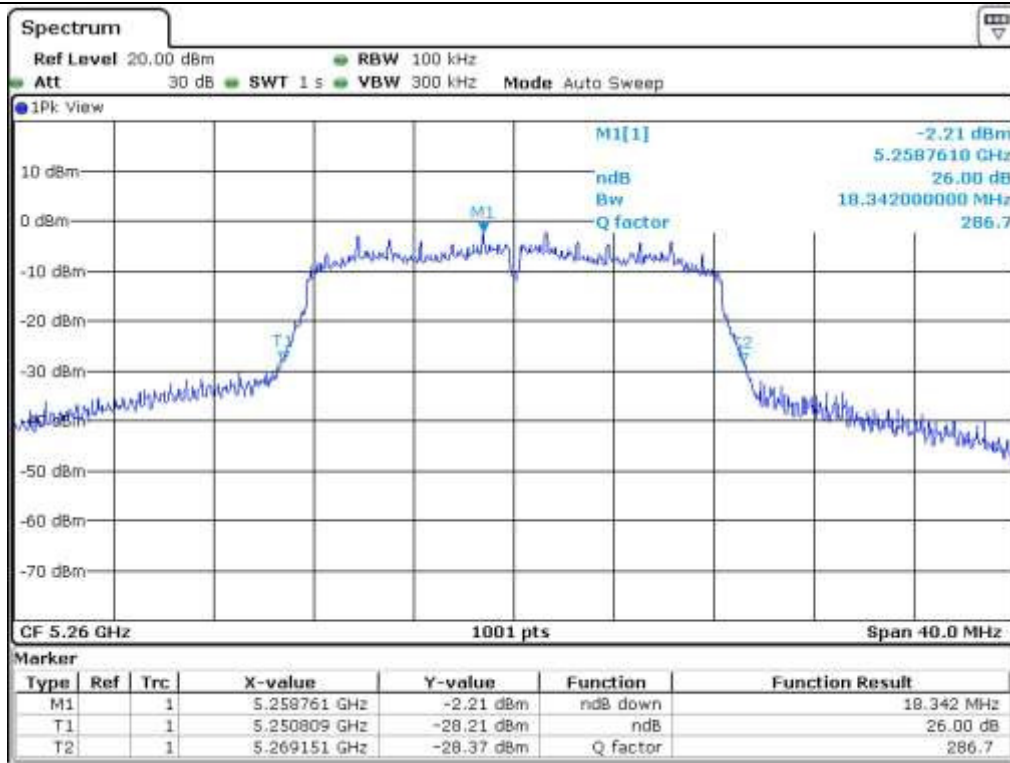

Low Channel (5 260 MHz)

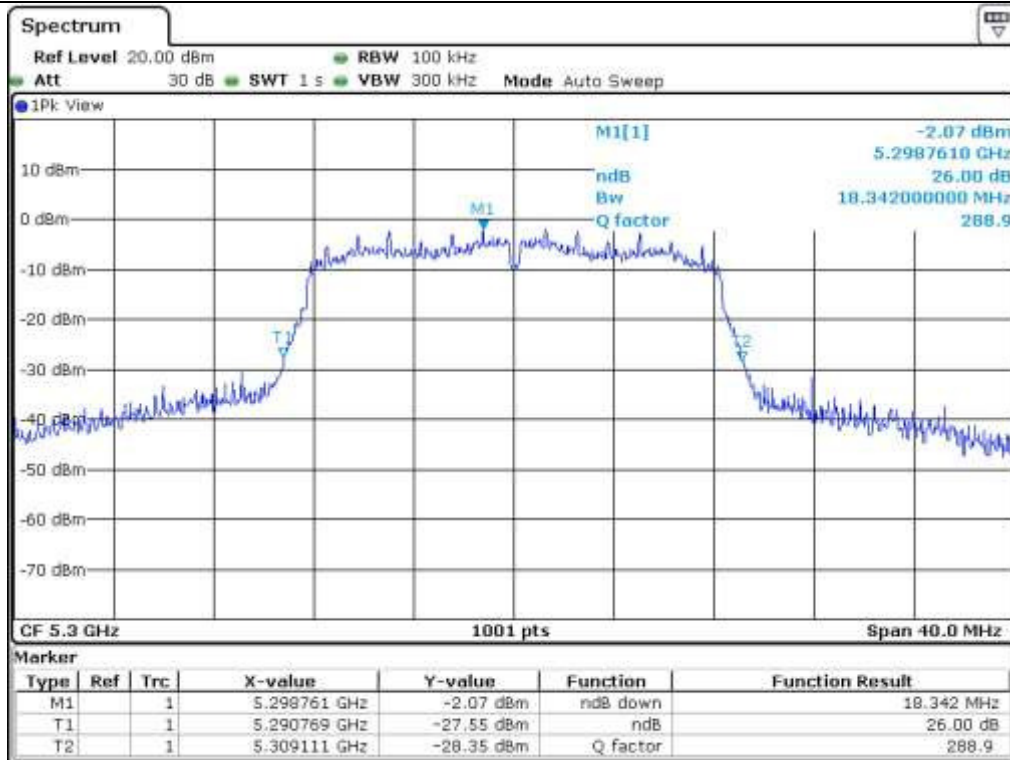

Middle Channel (5 300 MHz)

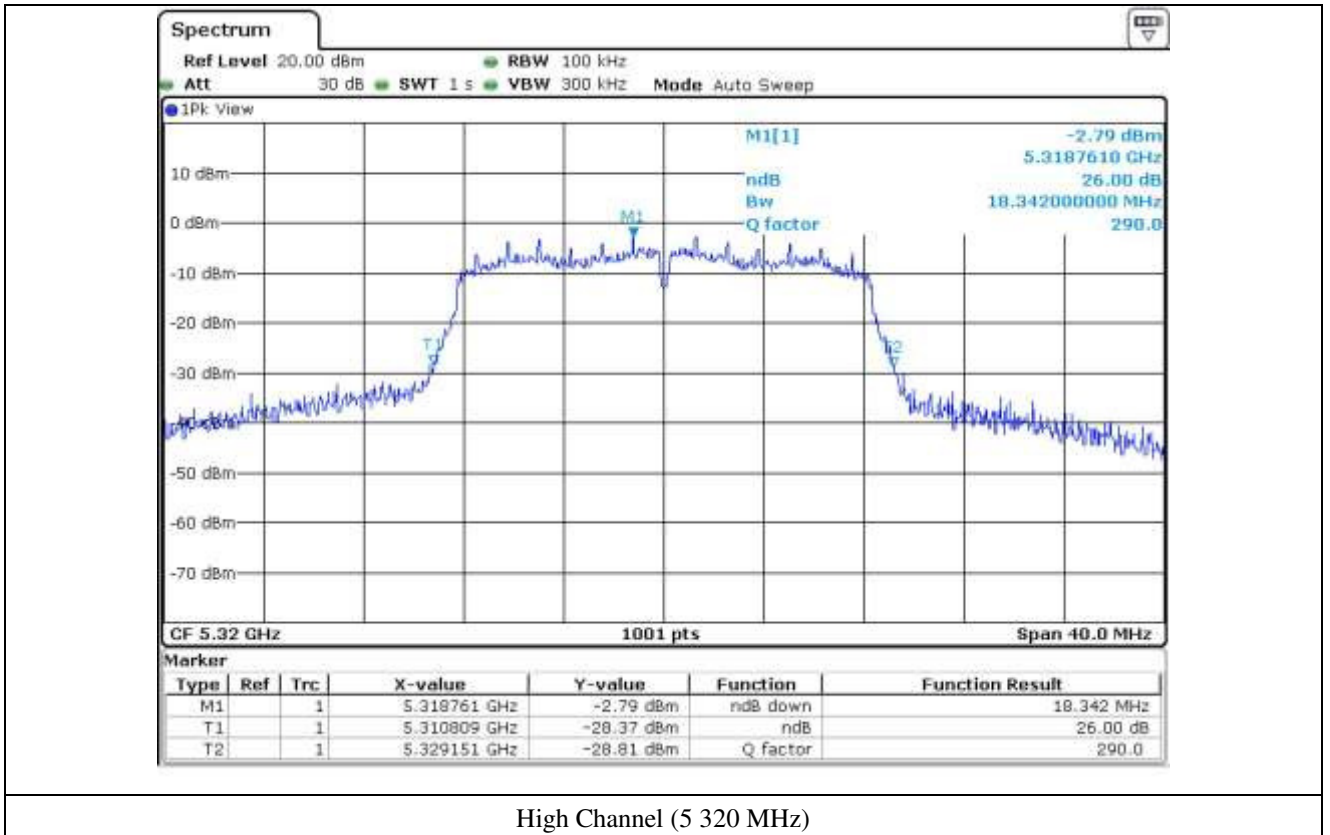

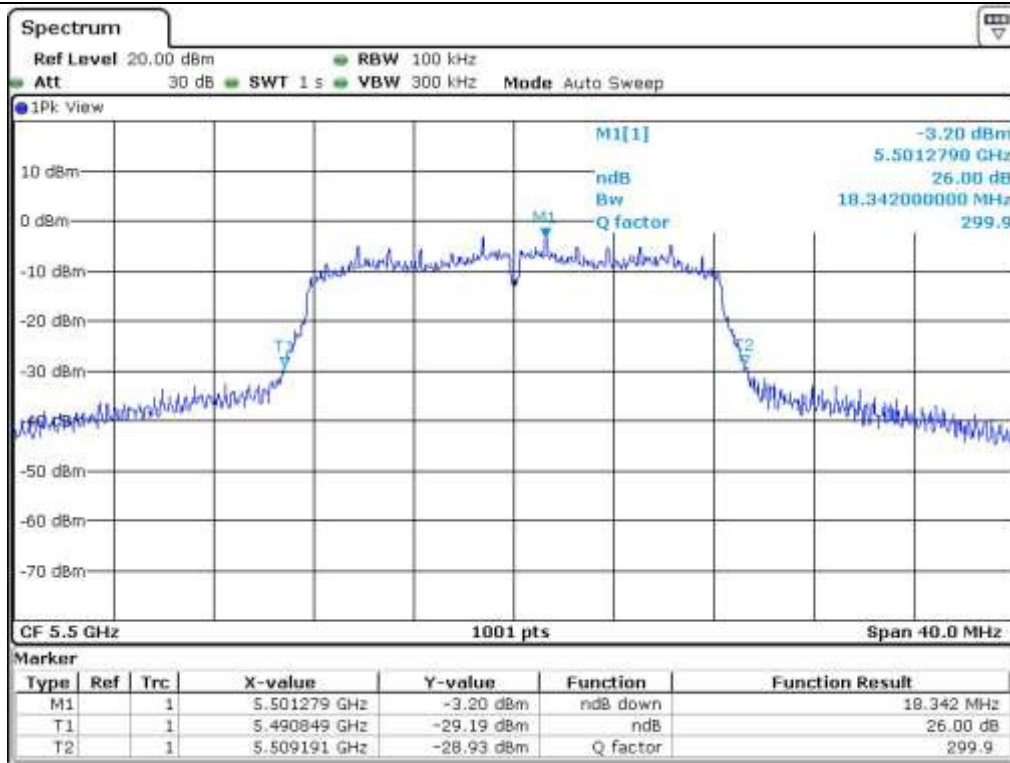

Low Channel (5 500 MHz)

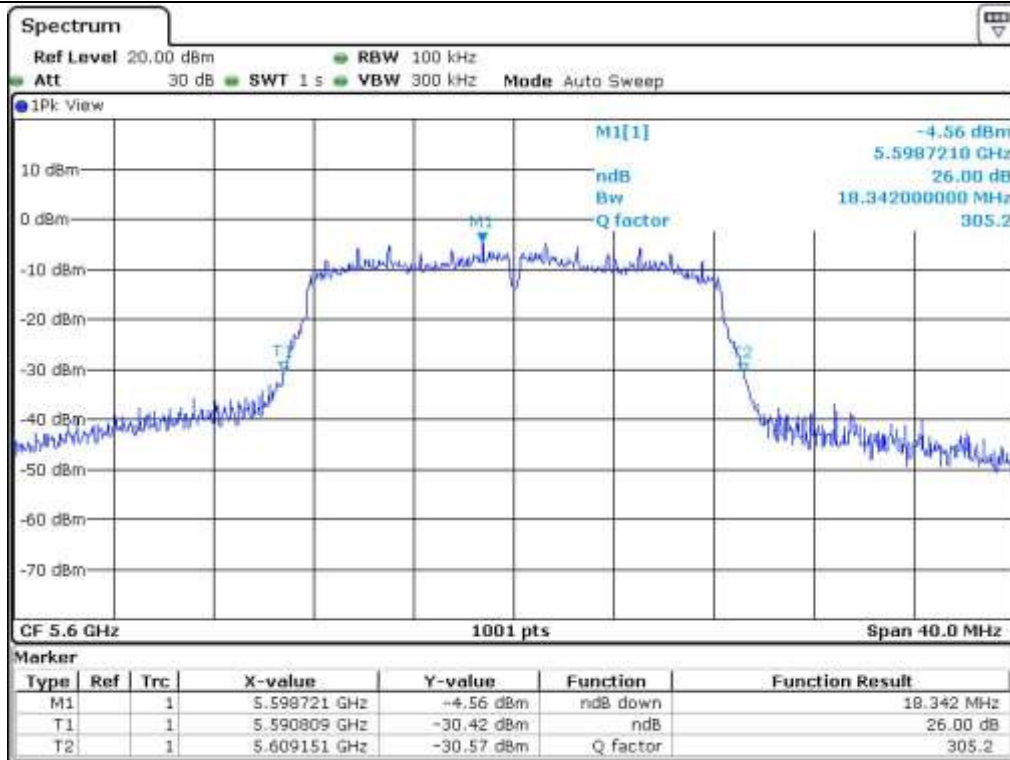

Middle Channel (5 600 MHz)

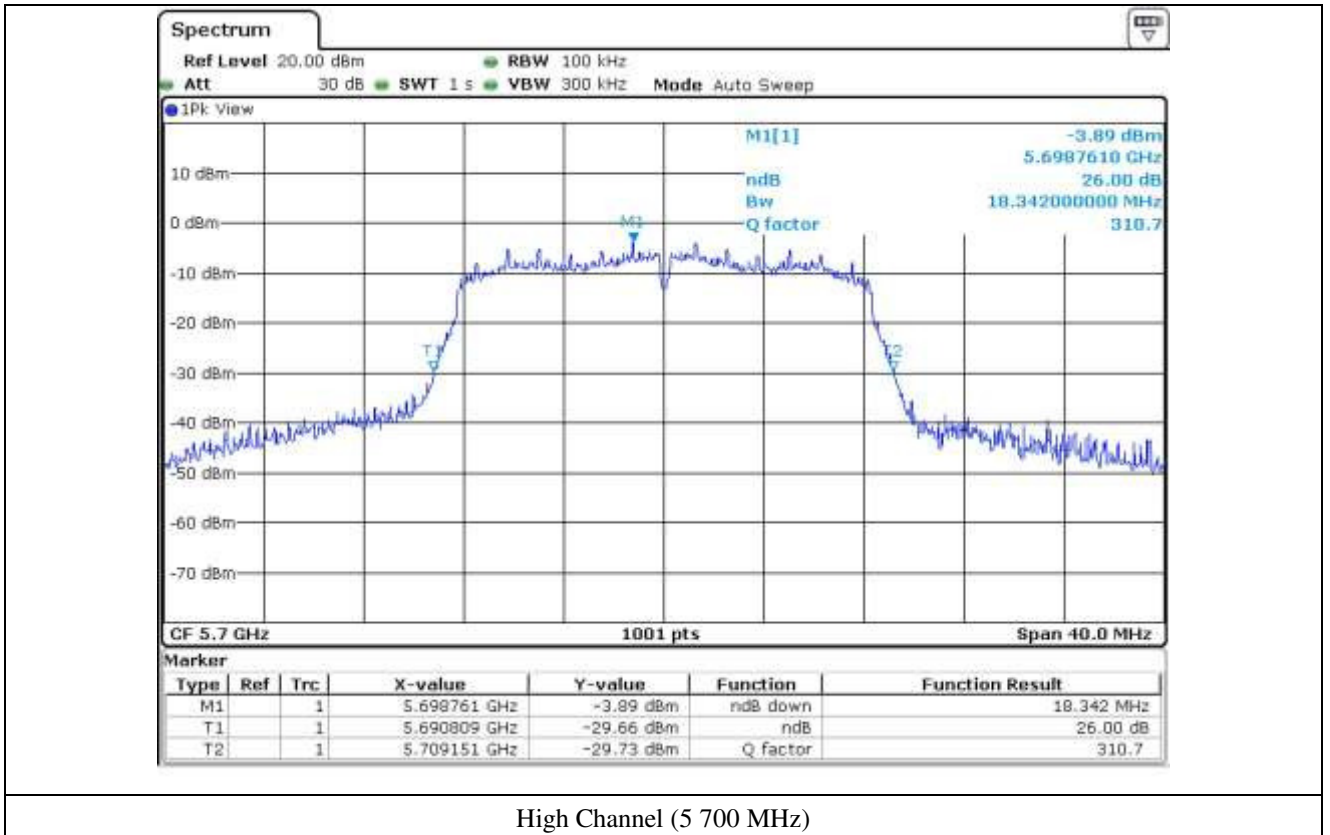

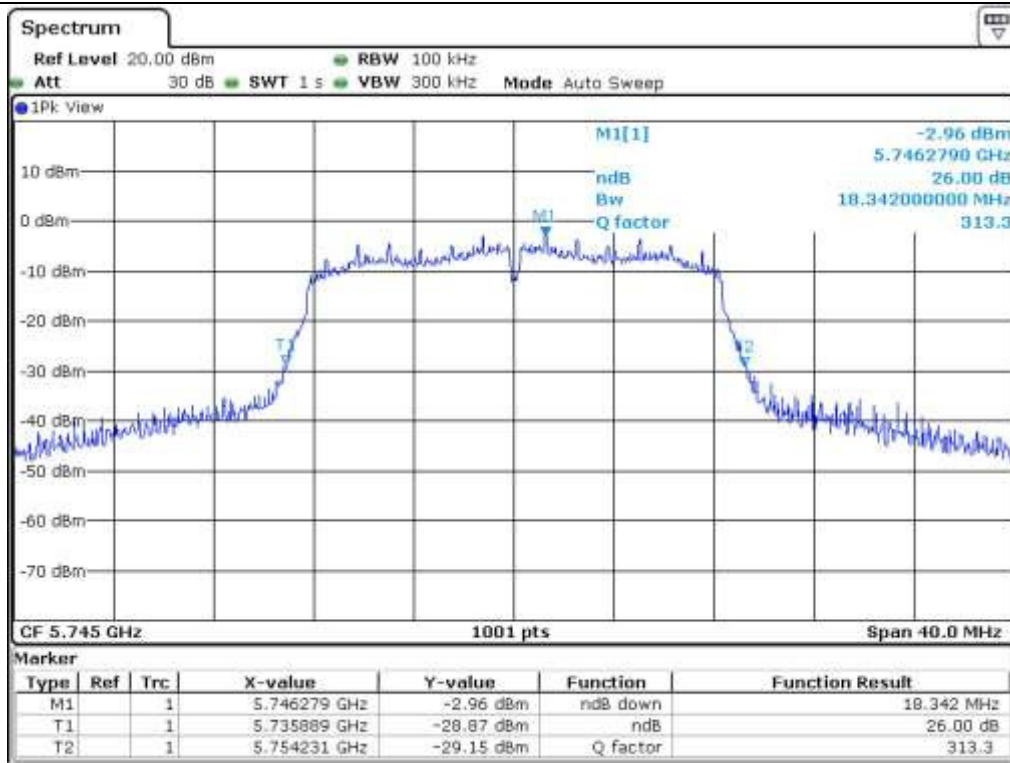

Low Channel (5.745 MHz)

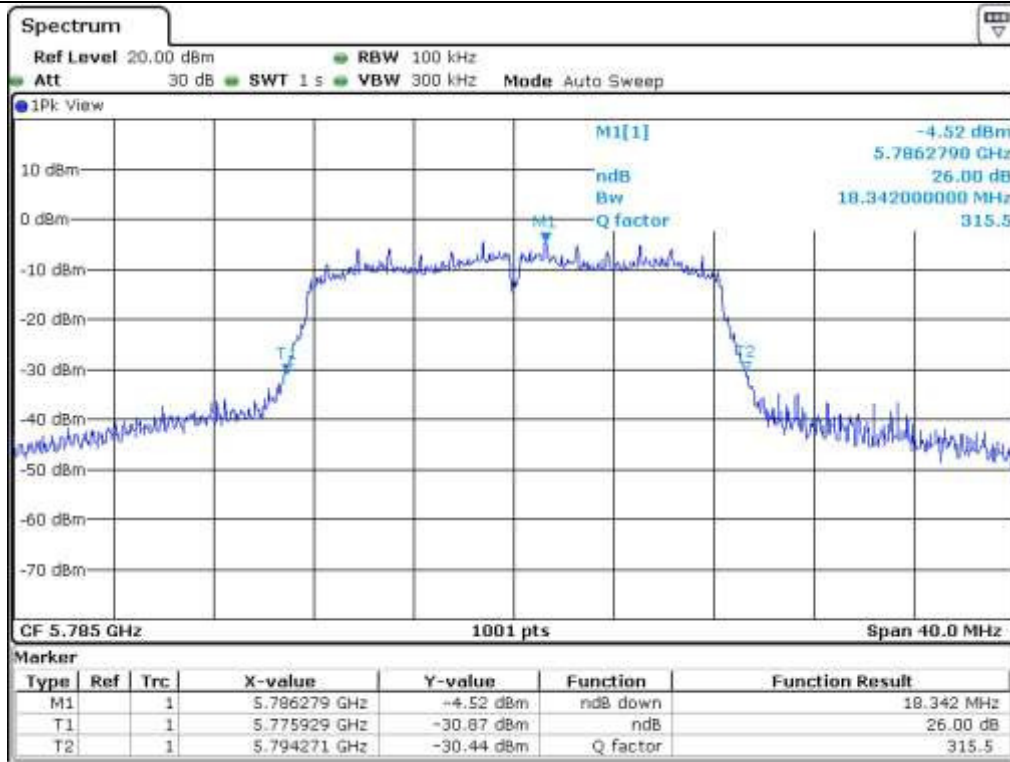

Middle Channel (5.785 MHz)

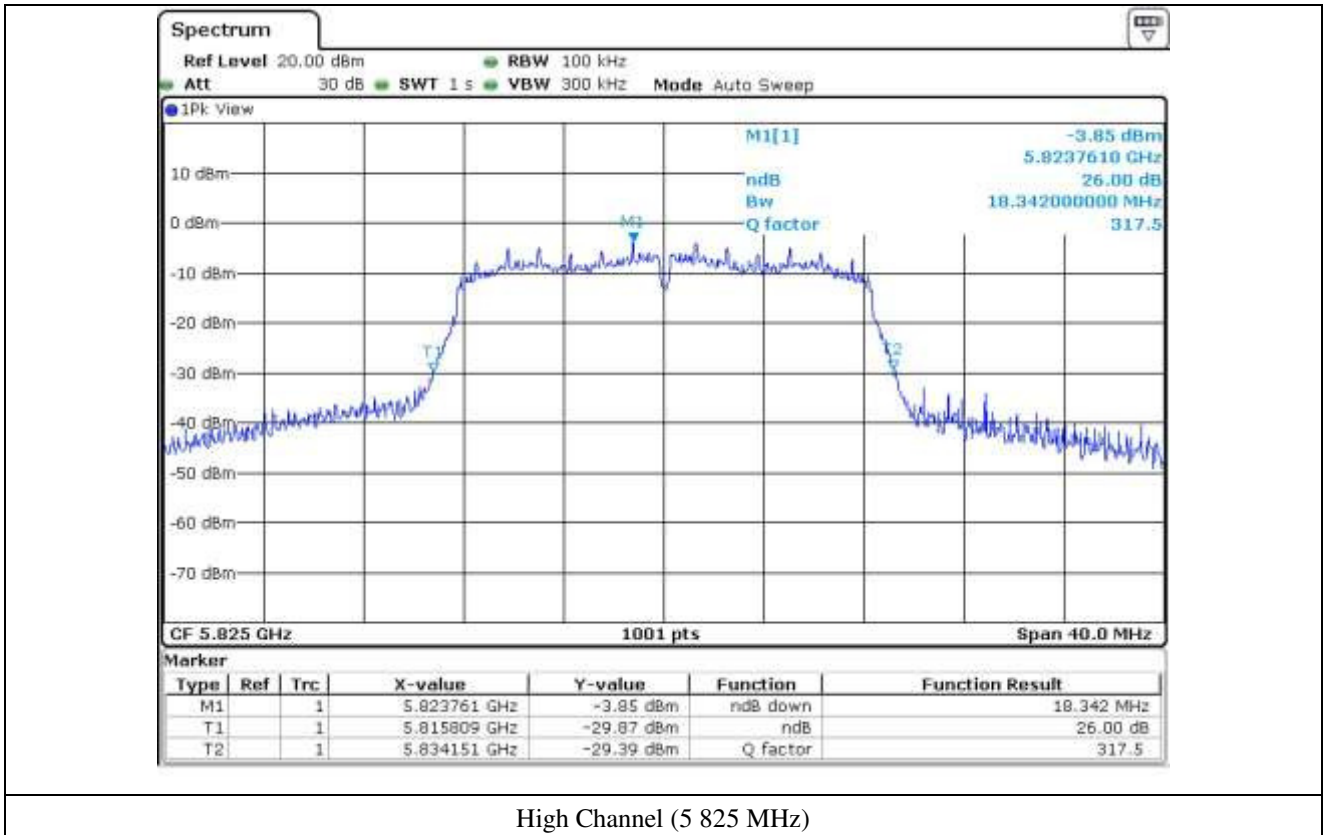

7.4.2 Test data for 802.11n_HT20 RLAN Mode

- Test Date : March 15, 2016

- Test Result : Pass

FREQUENCY RANGE (MHz)	CHANNEL	FREQUENCY (MHz)	26 dB Bandwidth (MHz)
5 150 ~ 5 250	Low	5 180	18.82
	Middle	5 200	18.82
	High	5 240	18.82
5 250 ~ 5 350	Low	5 260	18.82
	Middle	5 300	18.82
	High	5 320	18.82
5 470 ~ 5 725	Low	5 500	18.82
	Middle	5 600	18.82
	High	5 700	18.82
5 725 ~ 5 850	Low	5 745	18.82
	Middle	5 785	18.82
	High	5 825	18.82

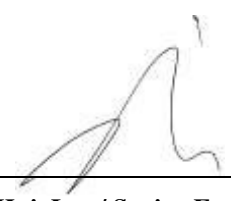

Tested by: Jun-Hui, Lee / Senior Engineer

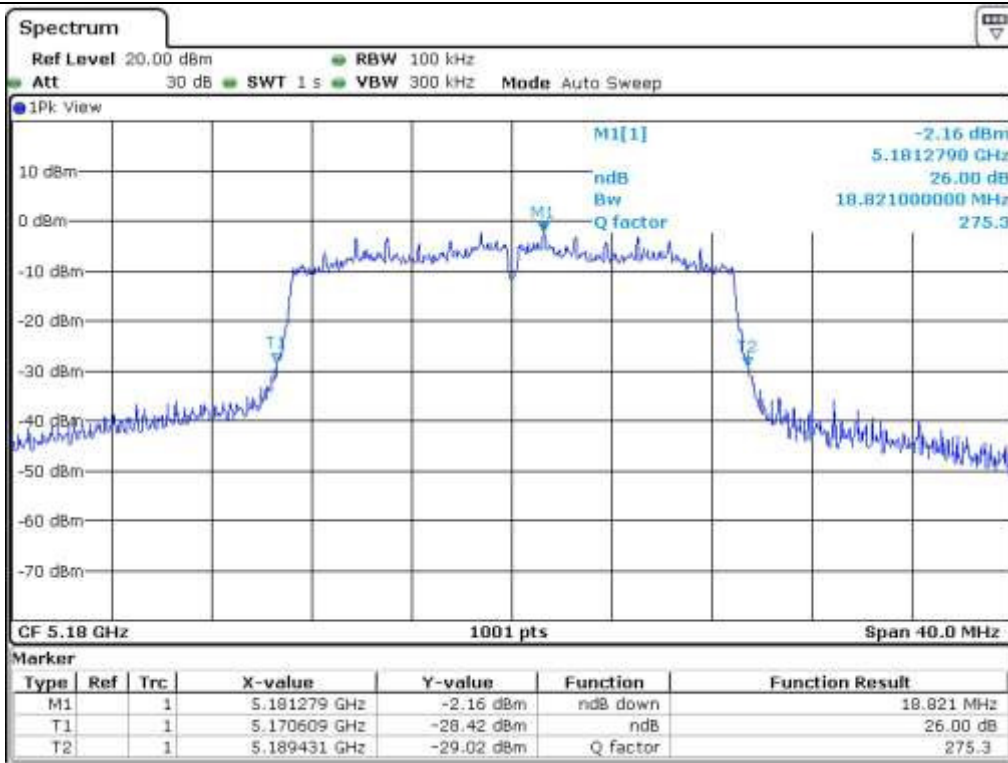

Low Channel (5 180 MHz)

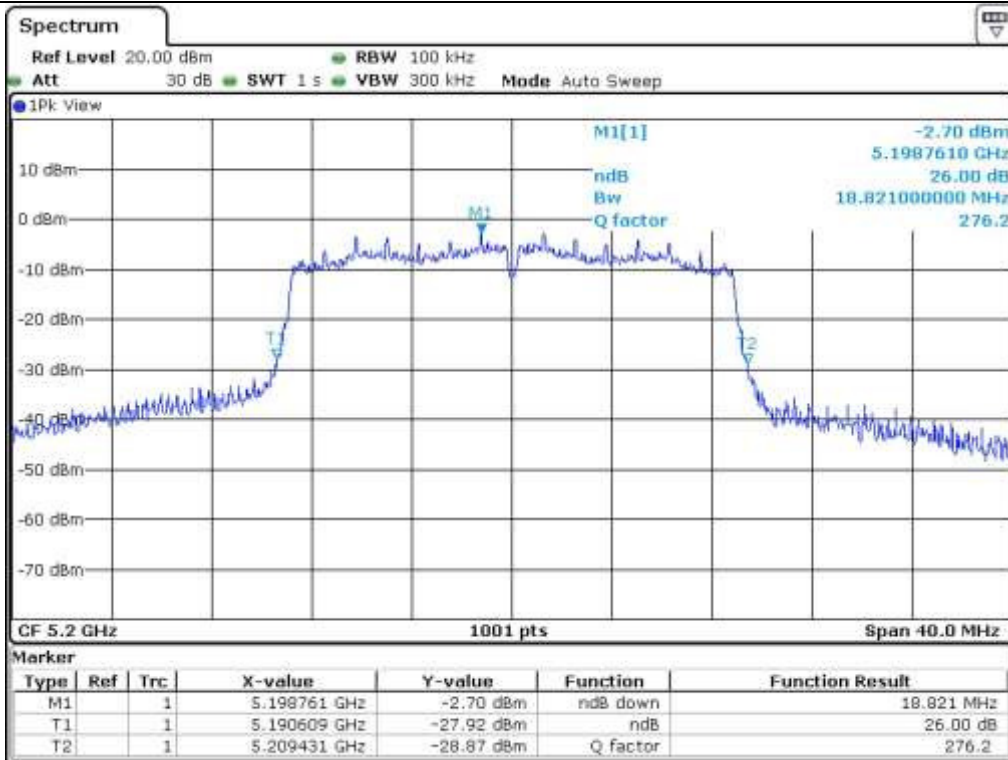

Middle Channel (5 200 MHz)

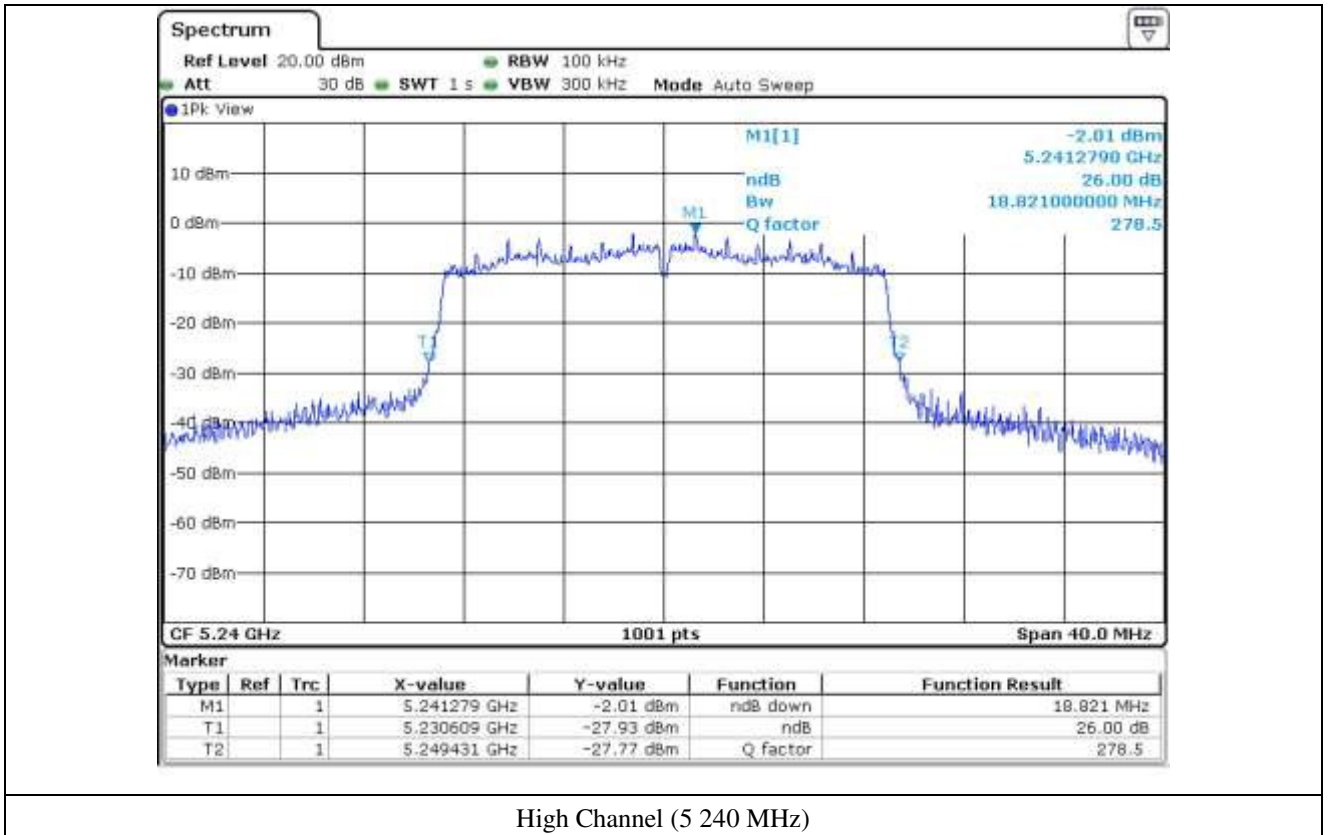

High Channel (5 240 MHz)

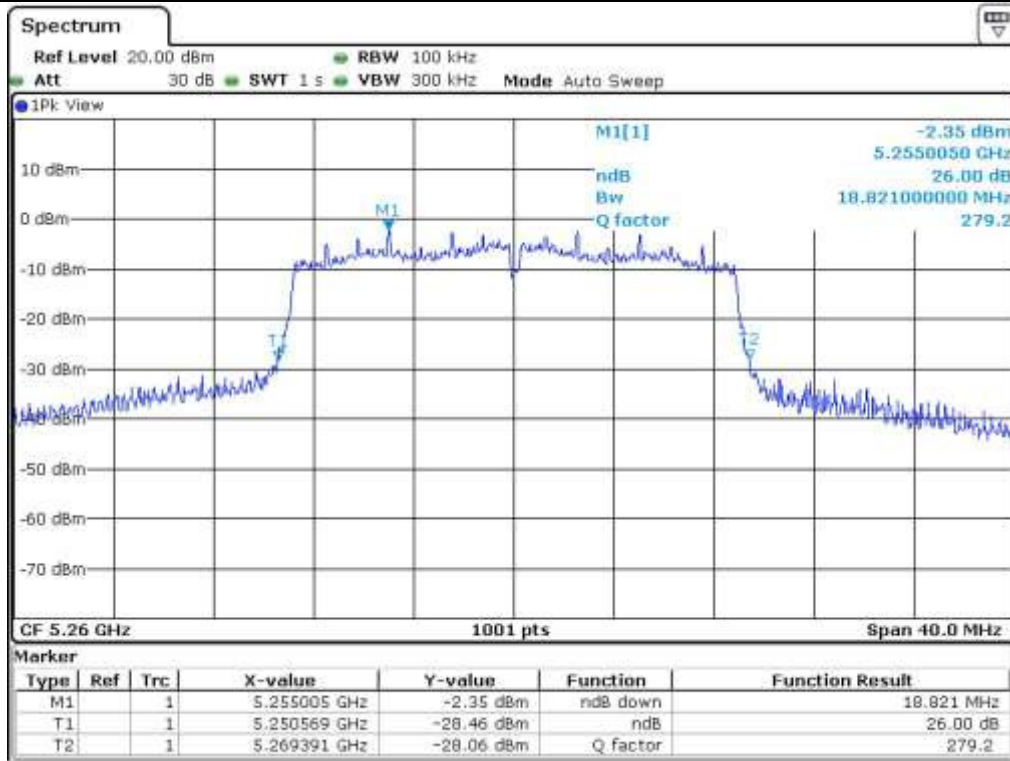

Low Channel (5 260 MHz)

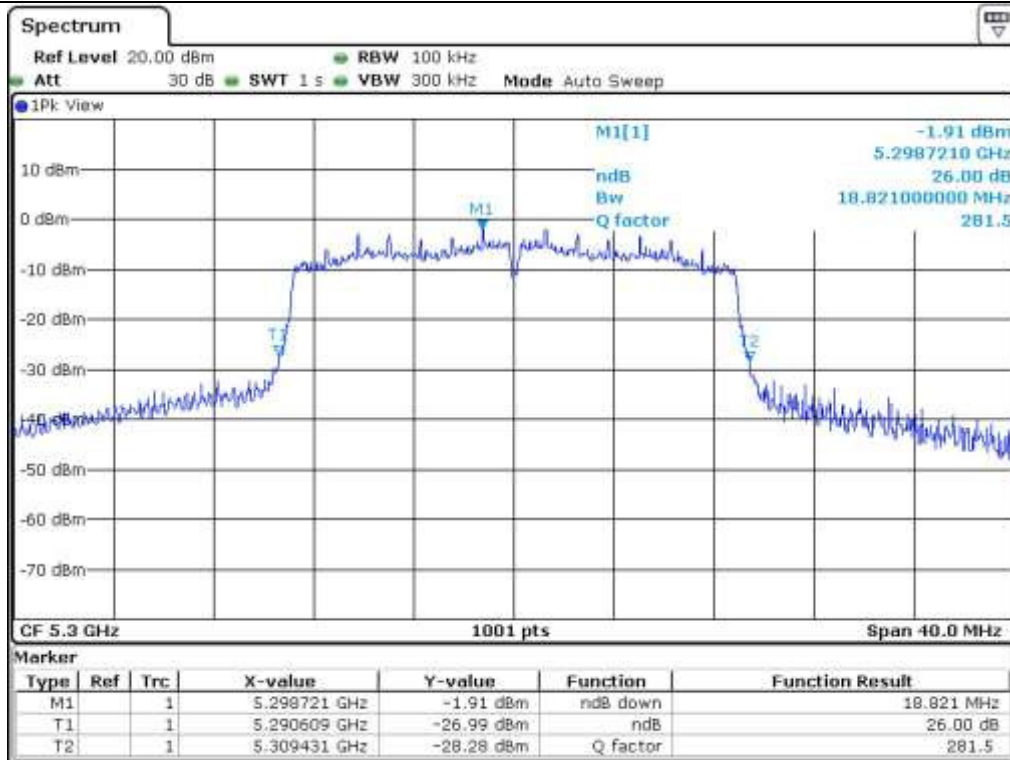

Middle Channel (5 300 MHz)

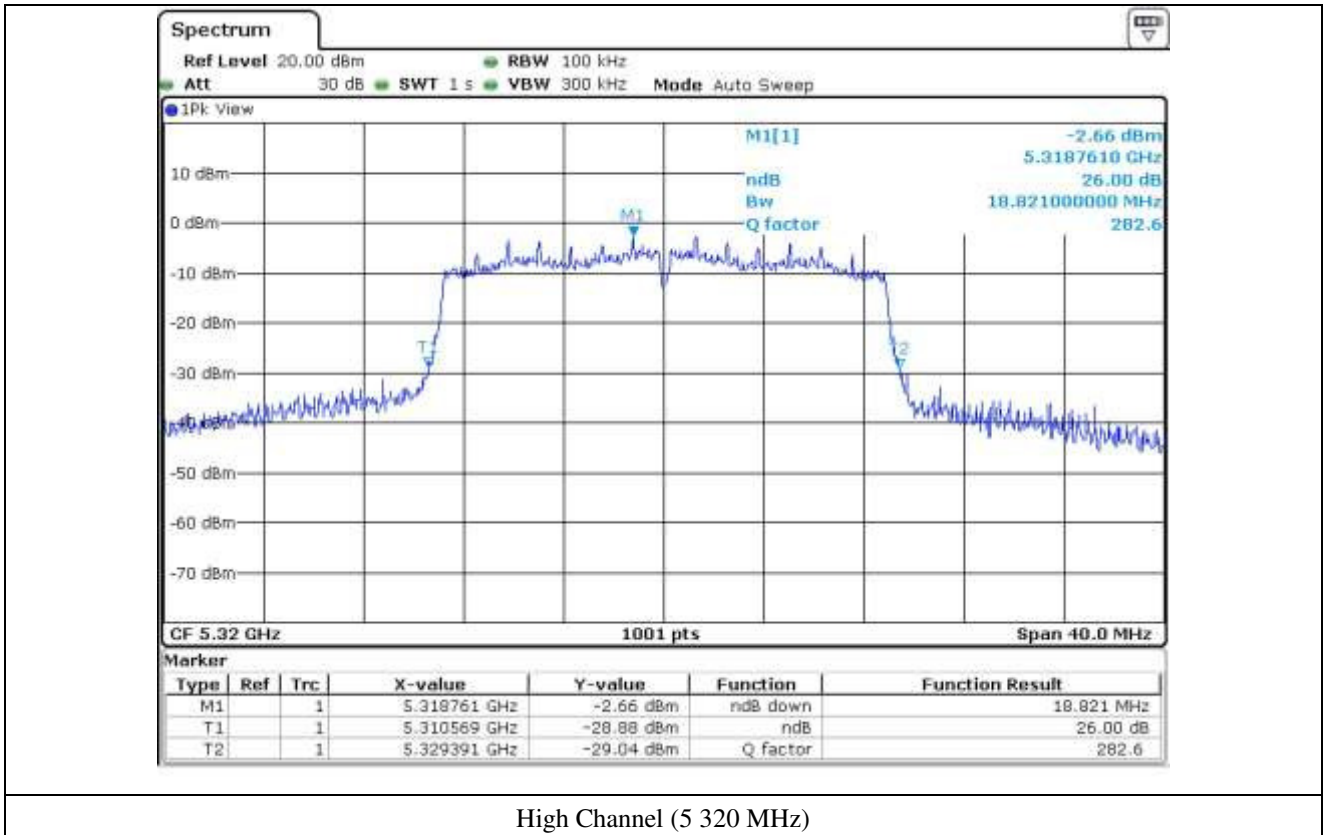

High Channel (5 320 MHz)

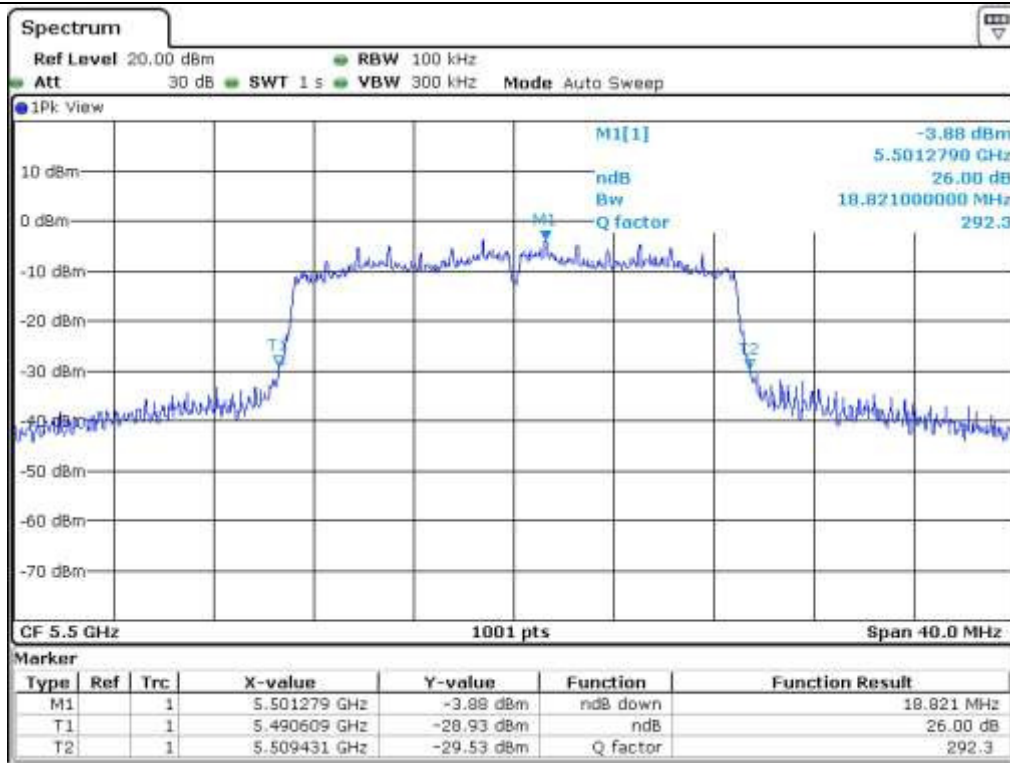

Low Channel (5 500 MHz)

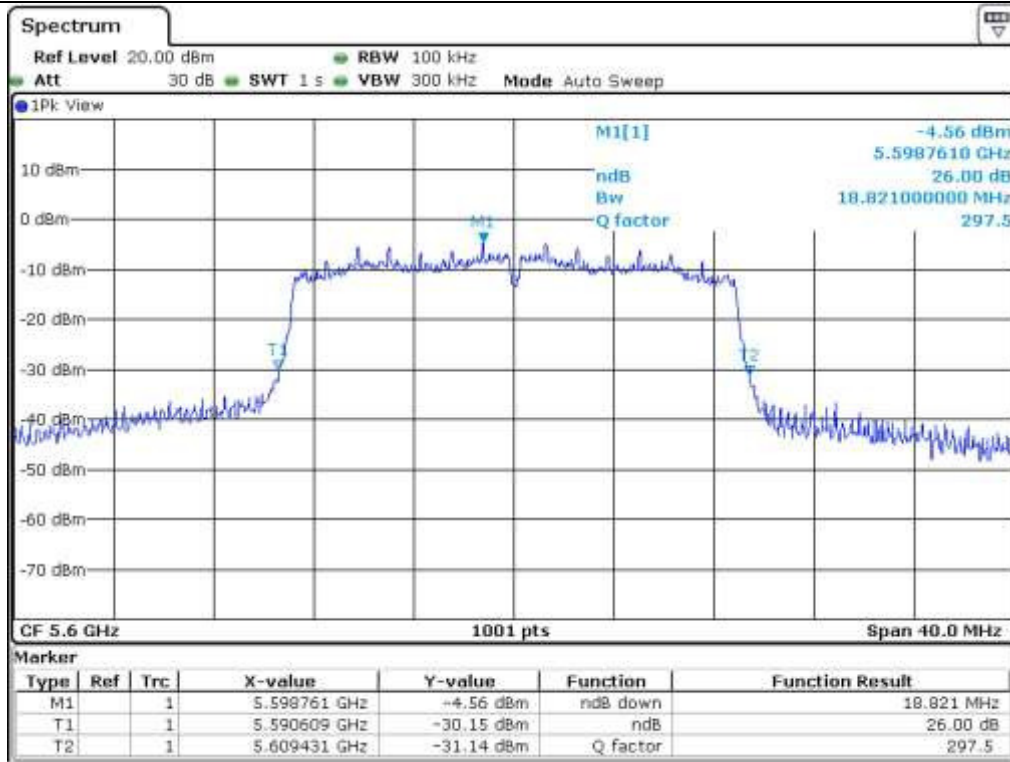

Middle Channel (5 600 MHz)

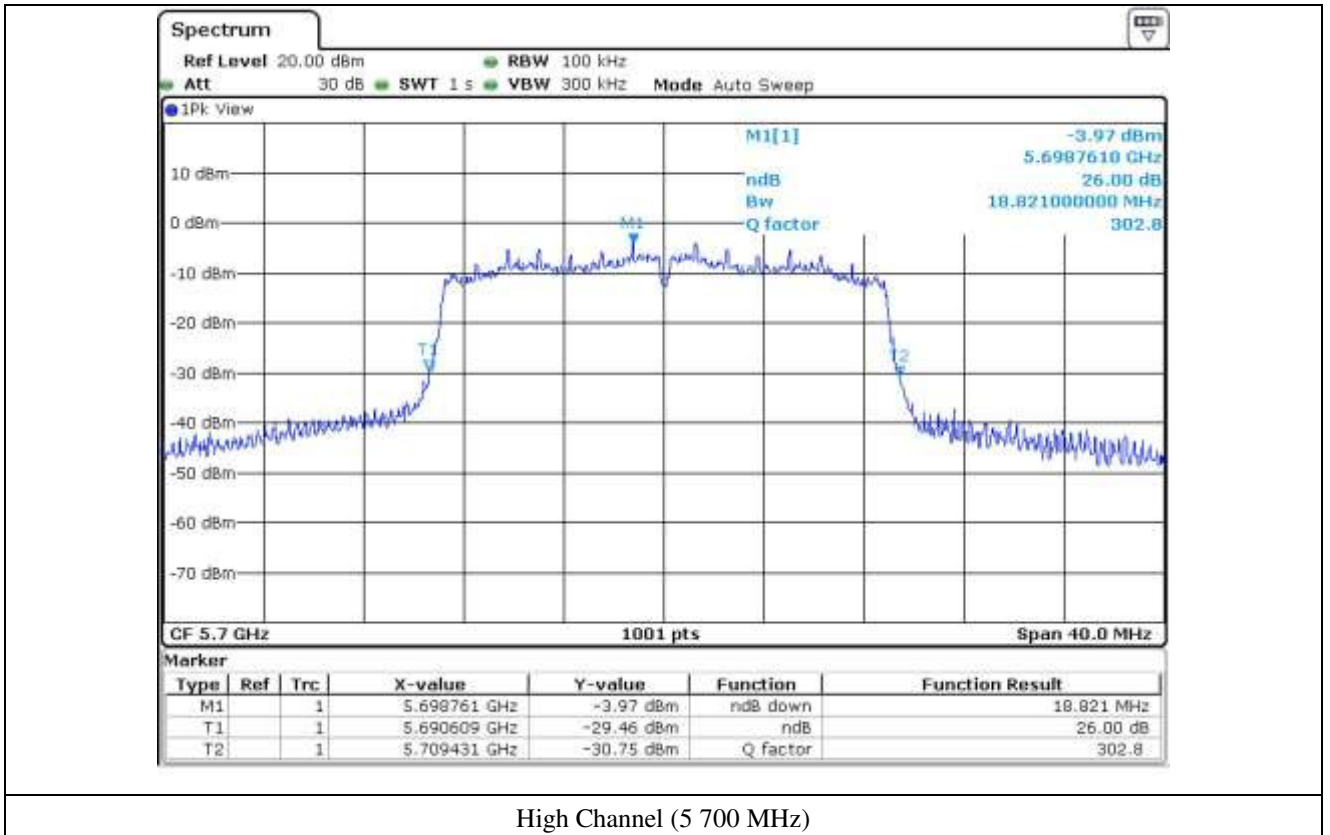

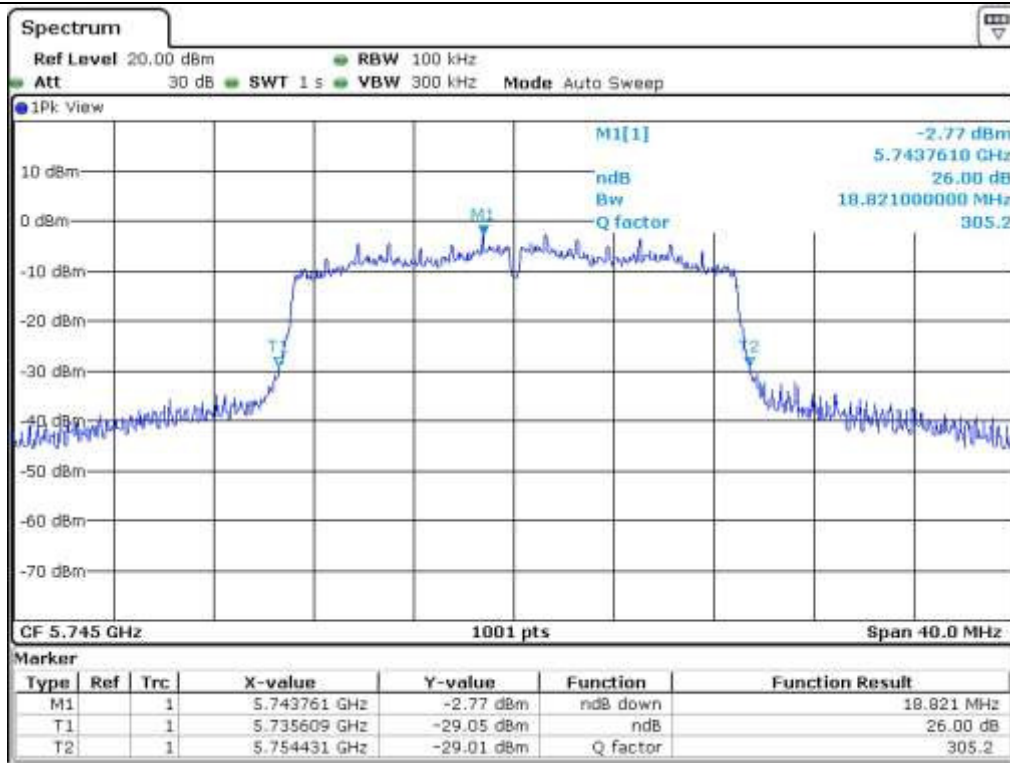

Low Channel (5.745 MHz)

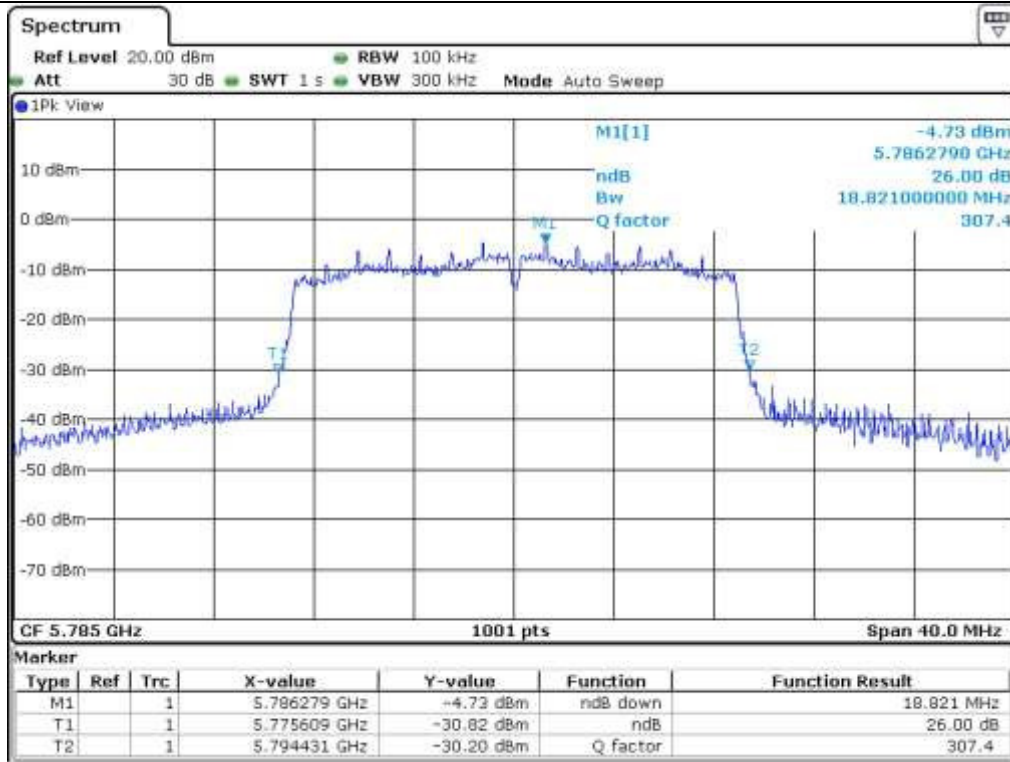

Middle Channel (5.785 MHz)

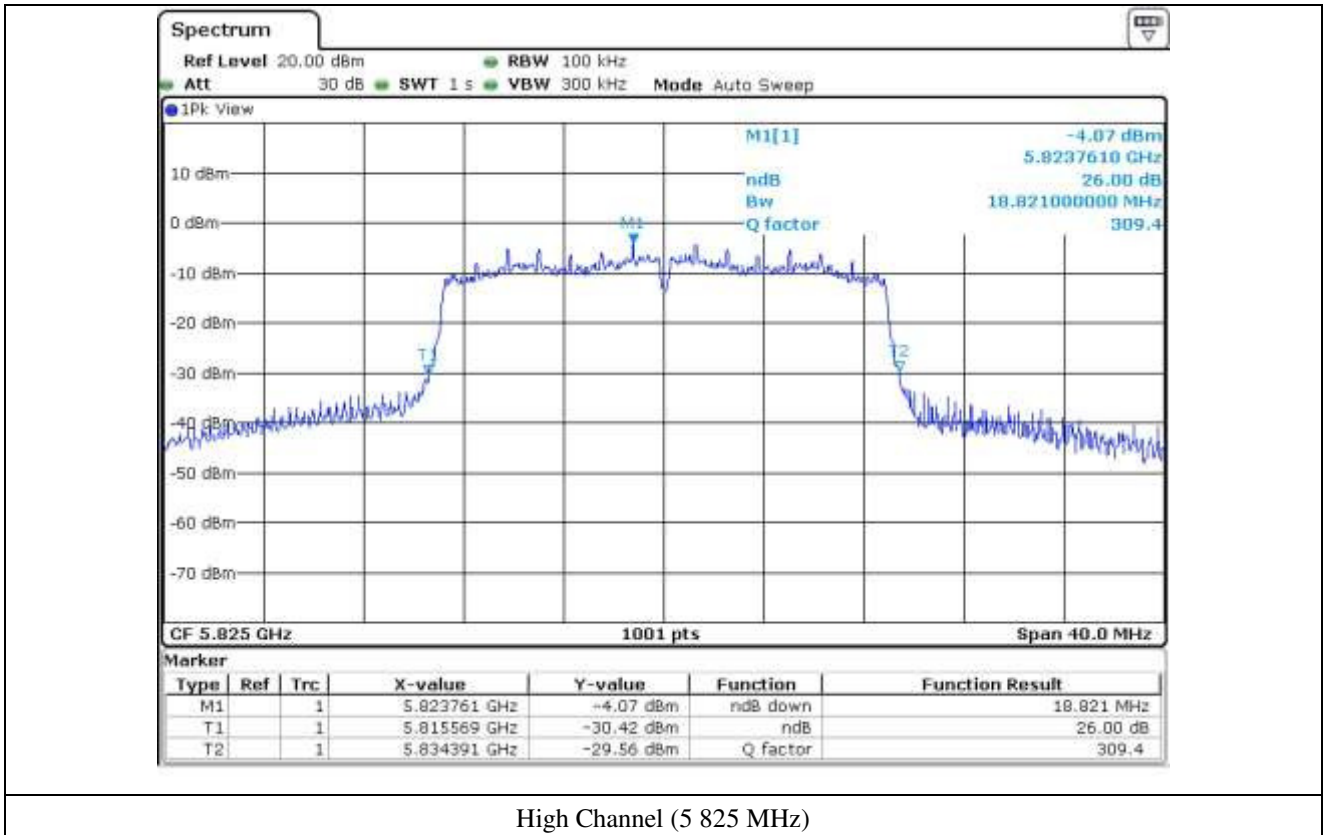

High Channel (5 825 MHz)

8. MAXIMUM PEAK OUTPUT POWER

8.1 Operating environment

Temperature : 22 °C
 Relative humidity : 55 % R.H.

8.2 Test set-up

The maximum peak output power was measured with the spectrum analyzer connected to the antenna output of the EUT. The spectrum analyzer's internal channel power integration function is used to integrate the power over a bandwidth greater than or equal to the 99 % bandwidth. The EUT was operating in transmit mode at the appropriate center frequency.

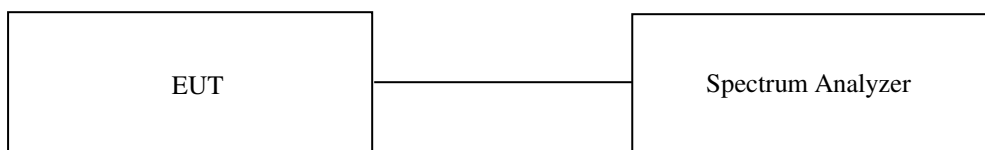

8.3 Test equipment used

Model Number	Manufacturer	Description	Serial Number	Last Cal.
■ - FSV40	Rohde & Schwarz	Signal Analyzer	101009	Jul. 22, 2015 (1Y)

All test equipment used is calibrated on a regular basis.

8.4 Test data for 802.11a RLAN Mode

- Test Date : March 15, 2016

- Test Result : Pass

FREQUENCY RANGE (MHz)	CHANNEL	FREQUENCY (MHz)	26 dB Bandwidth (MHz)	MEASURED VLAUE (dBm)	LIMIT (dBm)	MARGIN (dB)
5 150 ~ 5 250	Low	5 180	18.34	9.30	23.98	14.68
	Middle	5 200	18.34	8.76	23.98	15.22
	High	5 240	18.34	9.66	23.98	14.32
5 250 ~ 5 350	Low	5 260	18.34	9.88	23.98	14.10
	Middle	5 300	18.34	10.36	23.98	13.62
	High	5 320	18.34	9.77	23.98	14.21
5 470 ~ 5 725	Low	5 500	18.34	8.59	23.98	15.39
	Middle	5 600	18.34	7.64	23.98	16.34
	High	5 700	18.34	8.13	23.98	15.85
5 725 ~ 5 850	Low	5 745	18.34	9.80	30.00	20.20
	Middle	5 785	18.34	8.29	30.00	21.71
	High	5 825	18.34	8.75	30.00	21.25

Remark: See next page for measurement data.



Tested by: Jun-Hui, Lee / Senior Engineer



Low Channel @ 5 180 MHz (26 dB Bandwidth)



Middle Channel @ 5 200 MHz (26 dB Bandwidth)

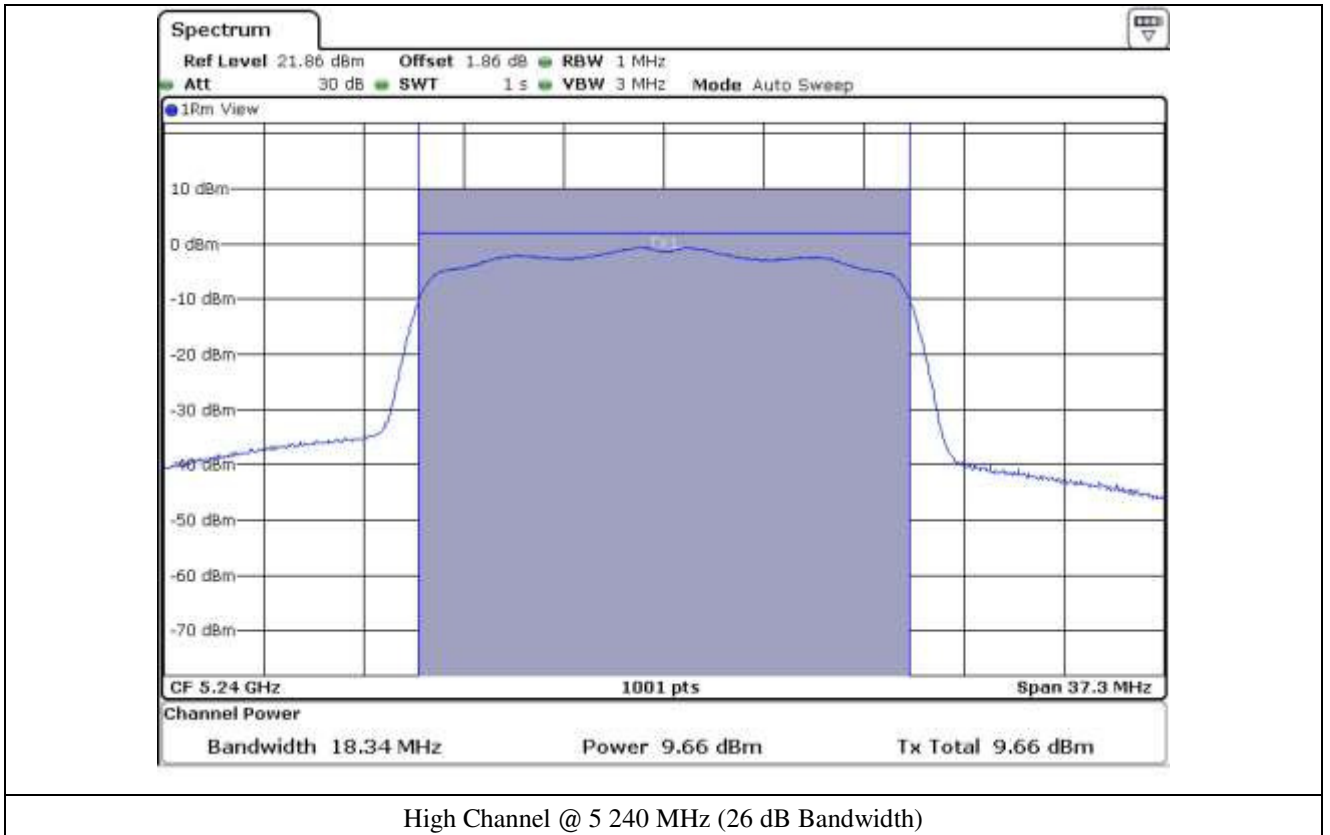



Low Channel @ 5 260 MHz (26 dB Bandwidth)



Middle Channel @ 5 300 MHz (26 dB Bandwidth)

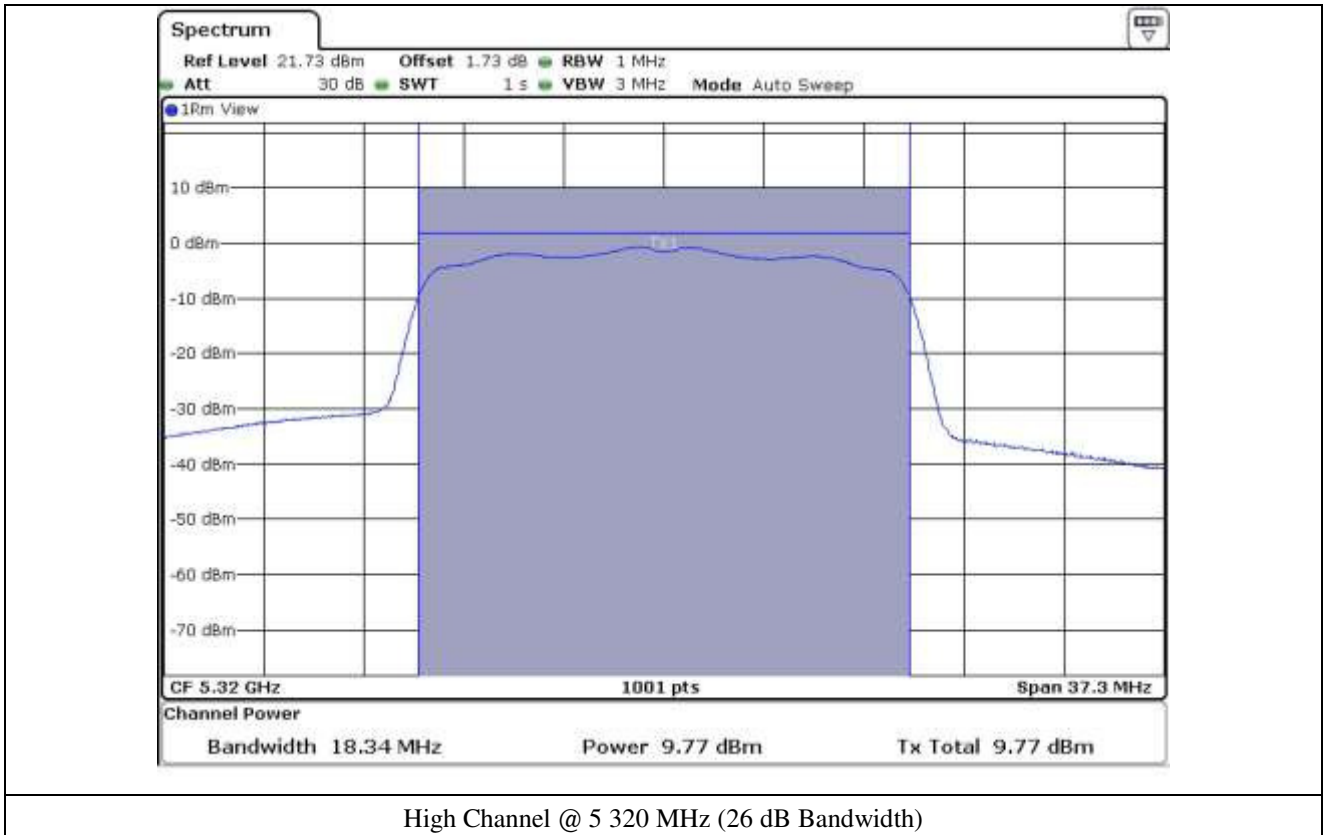

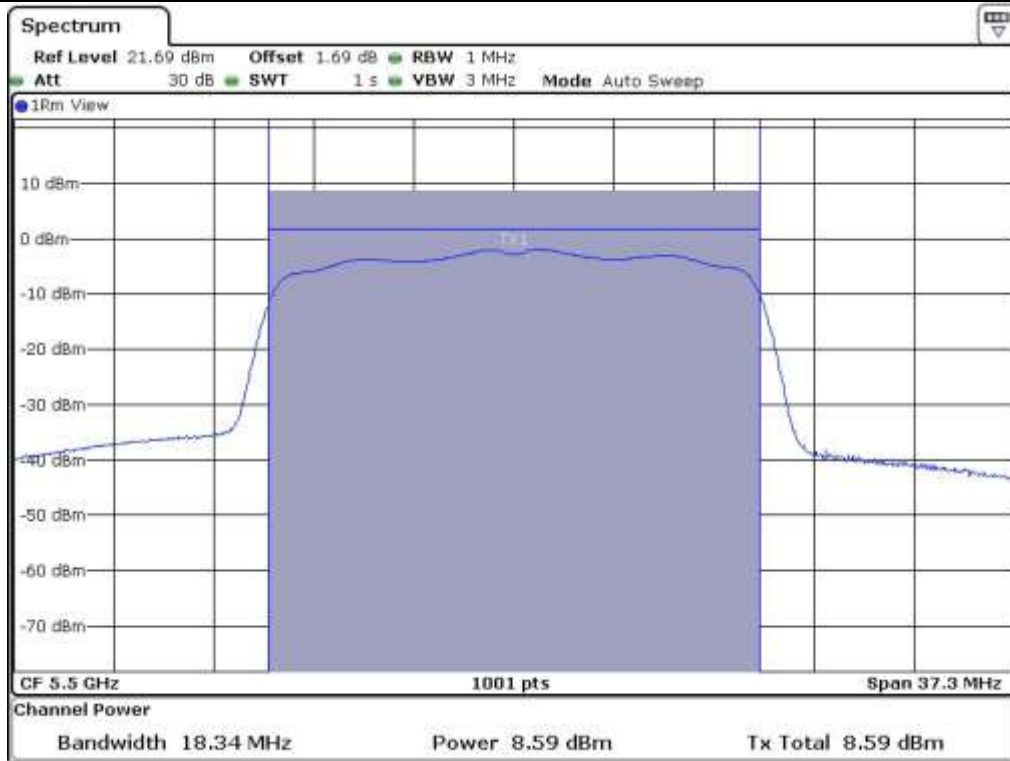

Low Channel @ 5 500 MHz (26 dB Bandwidth)

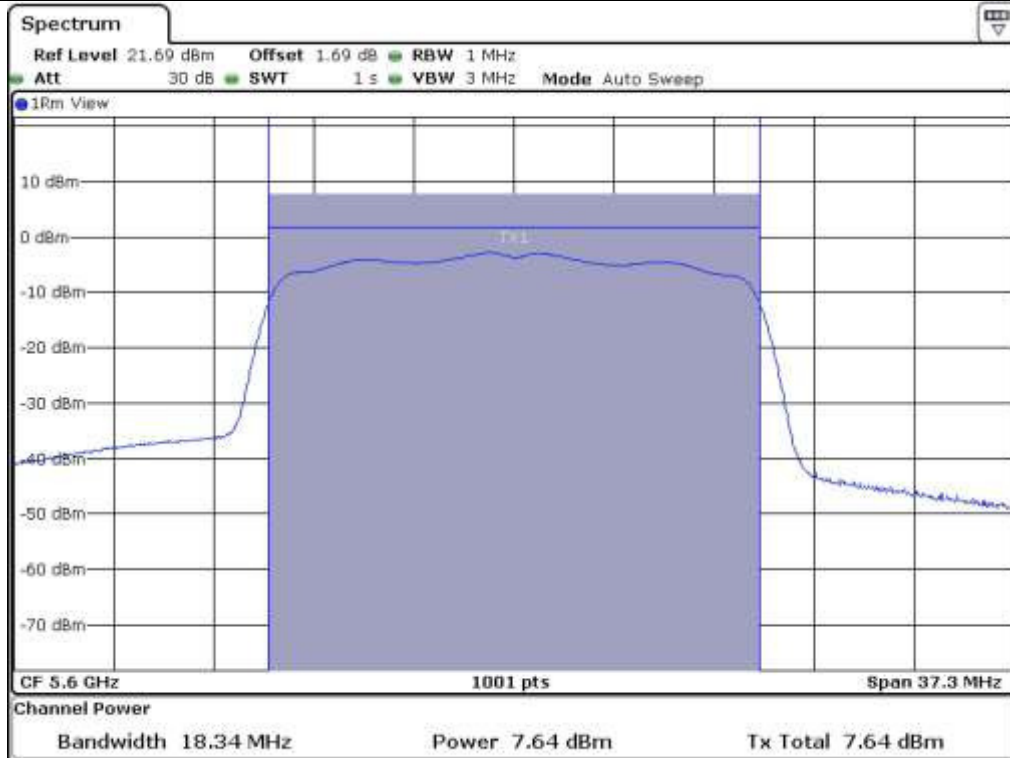

Middle Channel @ 5 600 MHz (26 dB Bandwidth)

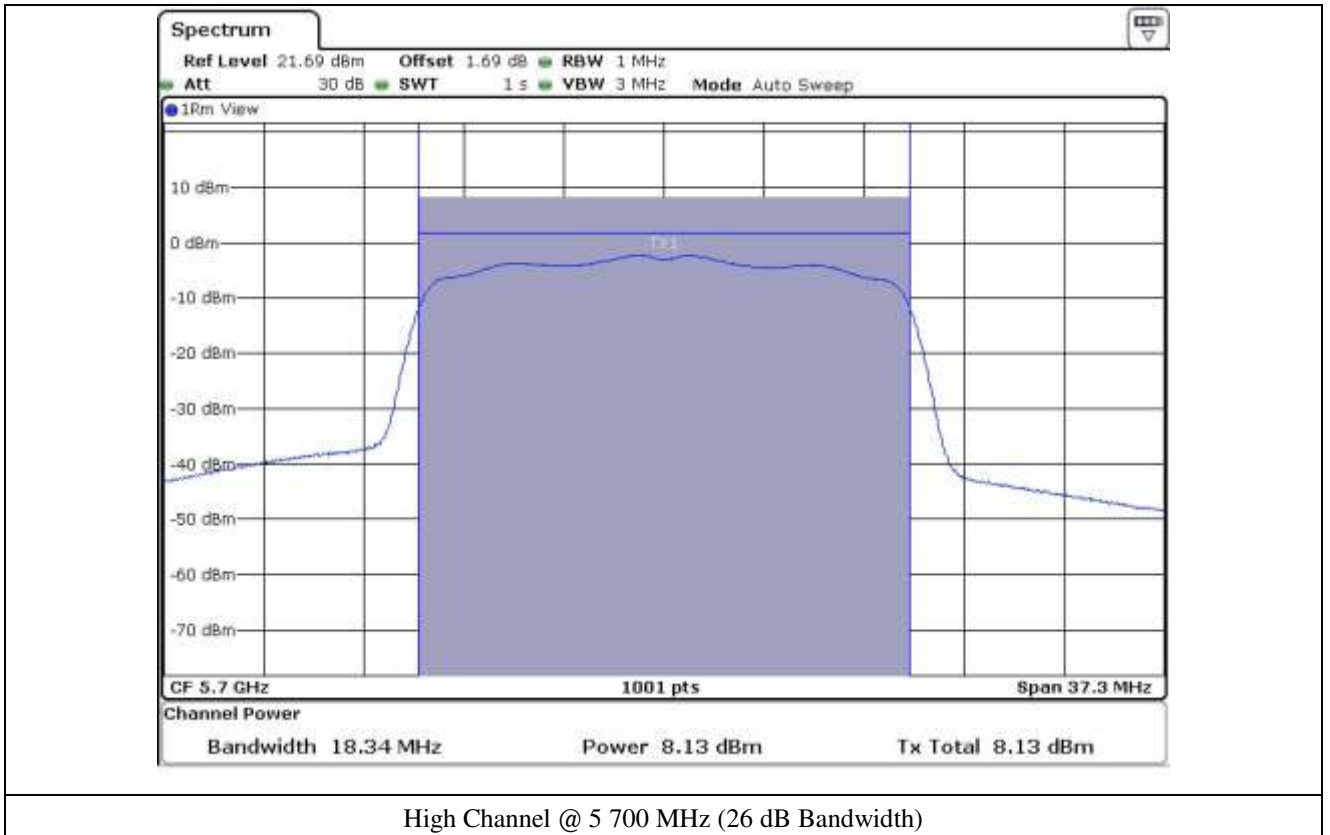

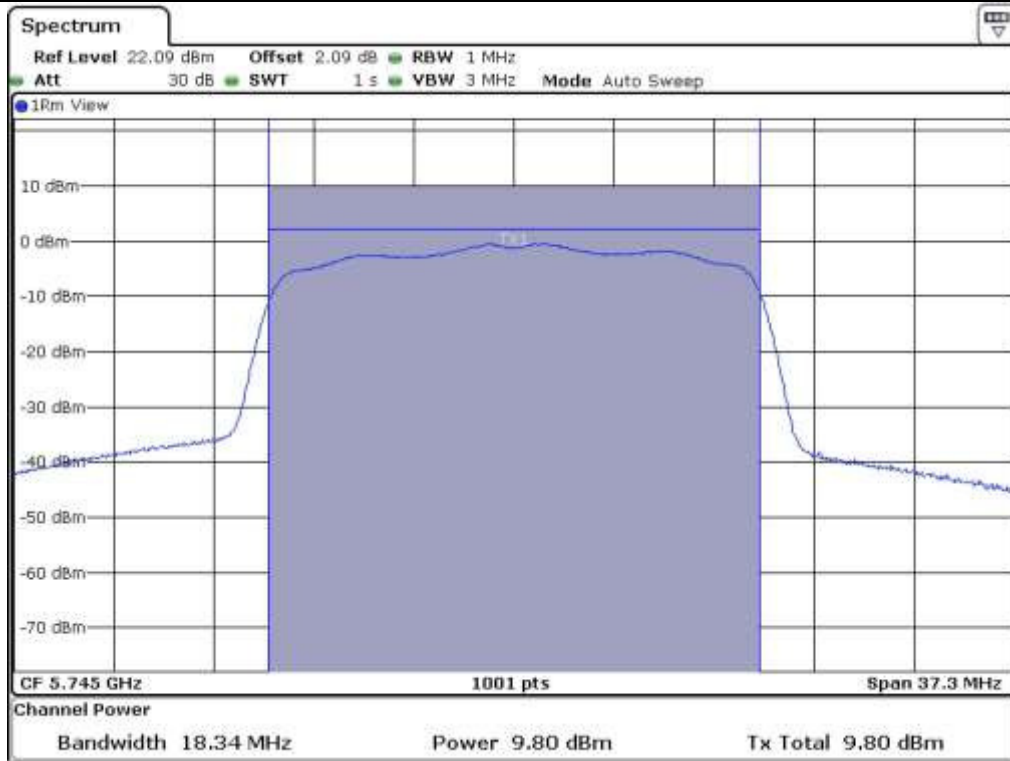

Low Channel @ 5.745 MHz (26 dB Bandwidth)

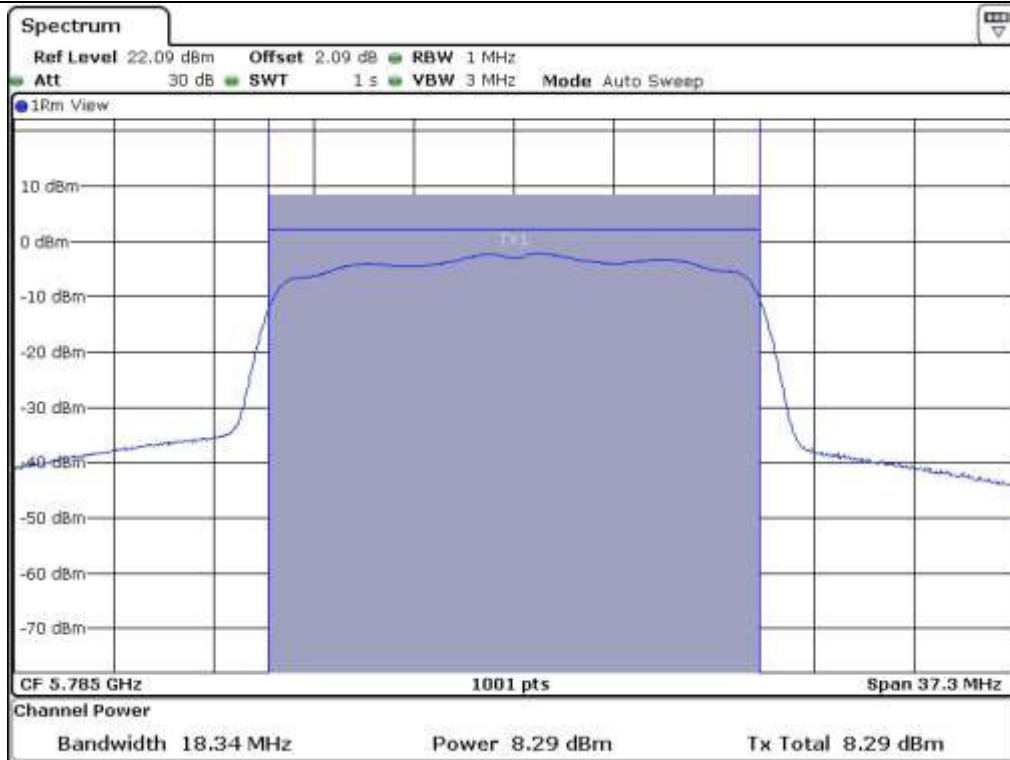

Middle Channel @ 5.785 MHz (26 dB Bandwidth)

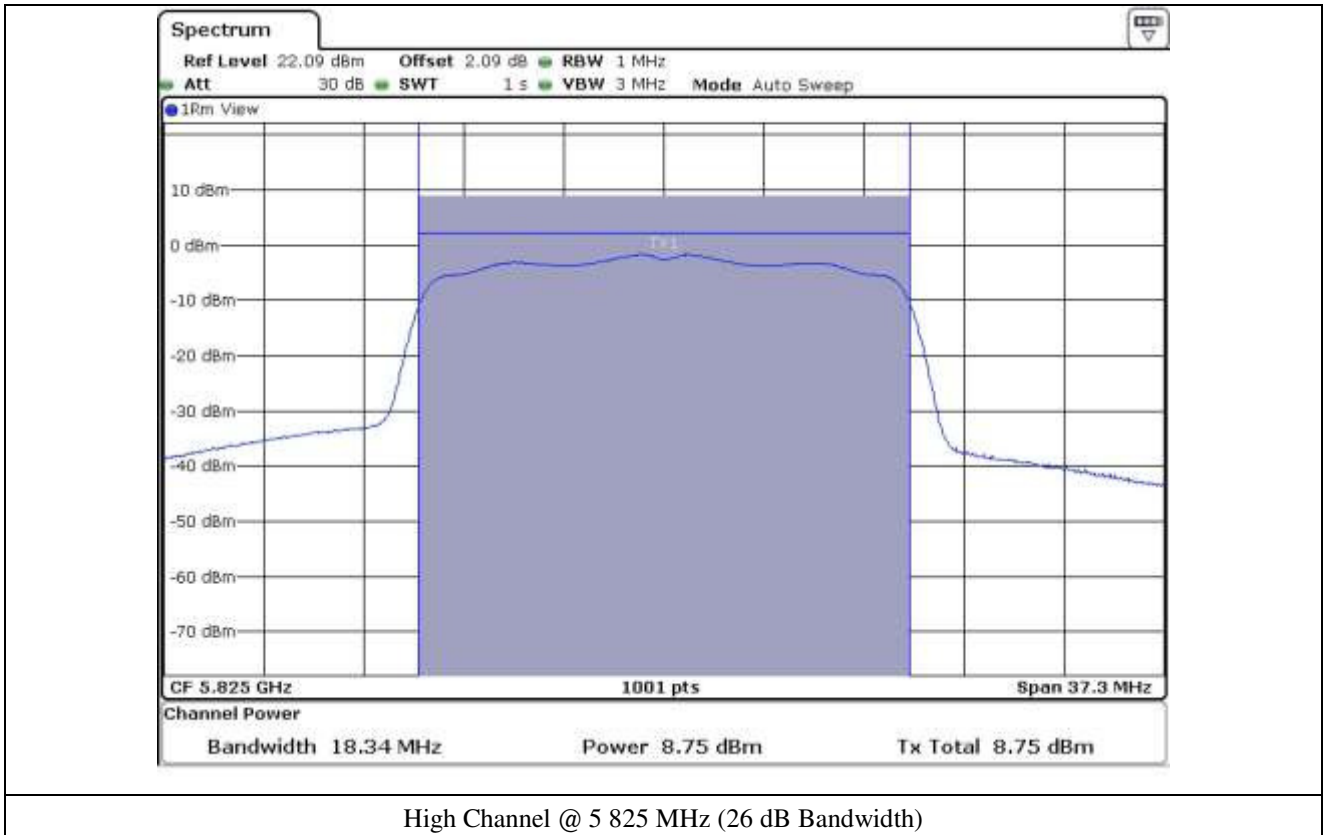

High Channel @ 5 825 MHz (26 dB Bandwidth)

8.5 Test data for 802.11n_HT20 RLAN Mode

- Test Date : March 15, 2016

- Test Result : Pass

FREQUENCY RANGE (MHz)	CHANNEL	FREQUENCY (MHz)	26 dB Bandwidth (MHz)	MEASURED VLAUE (dBm)	LIMIT (dBm)	MARGIN (dB)
5 150 ~ 5 250	Low	5 180	18.82	10.15	23.98	13.83
	Middle	5 200	18.82	9.68	23.98	14.30
	High	5 240	18.82	10.53	23.98	13.45
5 250 ~ 5 350	Low	5 260	18.82	9.89	23.98	14.09
	Middle	5 300	18.82	10.22	23.98	13.76
	High	5 320	18.82	9.55	23.98	14.43
5 470 ~ 5 725	Low	5 500	18.82	8.66	23.98	15.32
	Middle	5 600	18.82	7.62	23.98	16.36
	High	5 700	18.82	8.28	23.98	15.70
5 725 ~ 5 850	Low	5 745	18.82	9.93	30.00	20.07
	Middle	5 785	18.82	8.50	30.00	21.50
	High	5 825	18.82	8.97	30.00	21.03

Remark: See next page for measurement data.



Tested by: Jun-Hui, Lee / Senior Engineer



Low Channel @ 5 180 MHz (26 dB Bandwidth)



Middle Channel @ 5 200 MHz (26 dB Bandwidth)

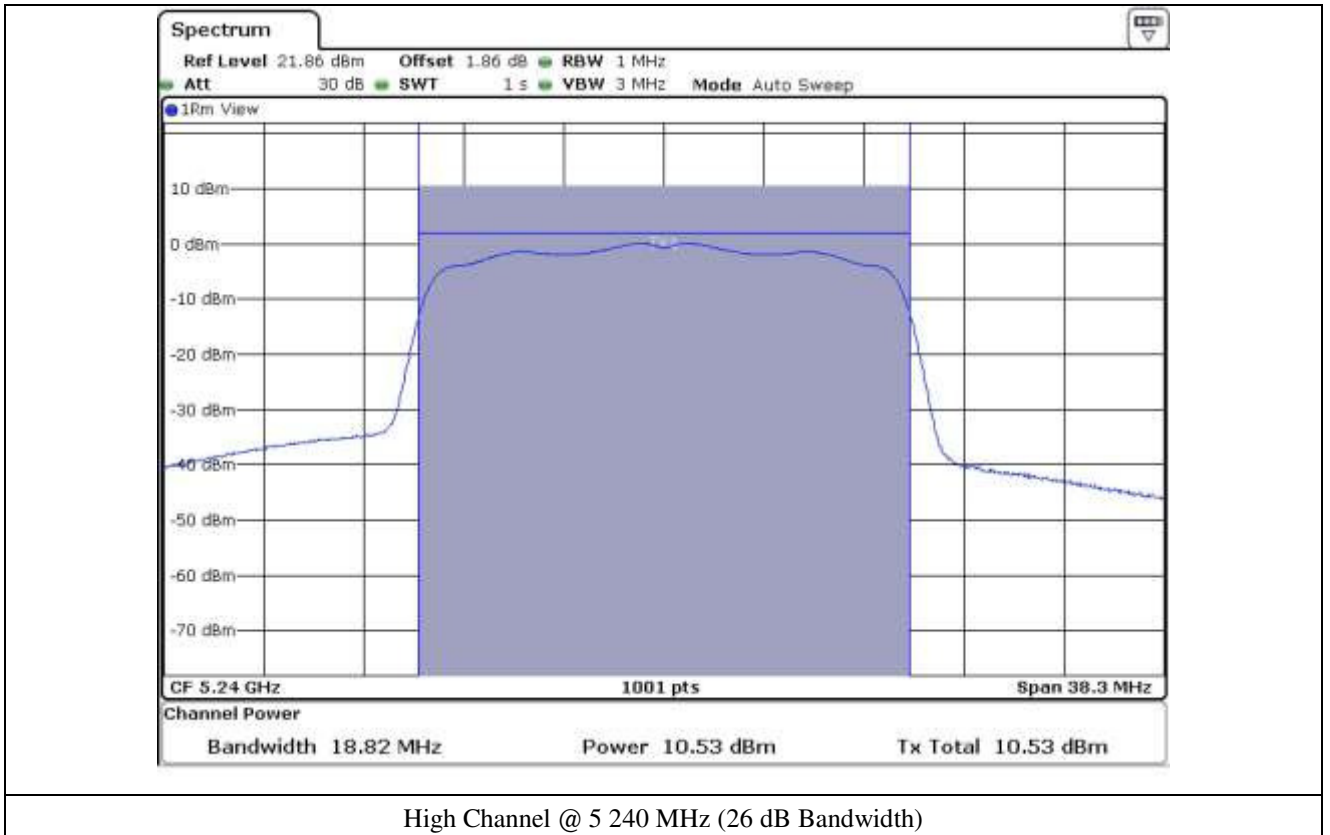

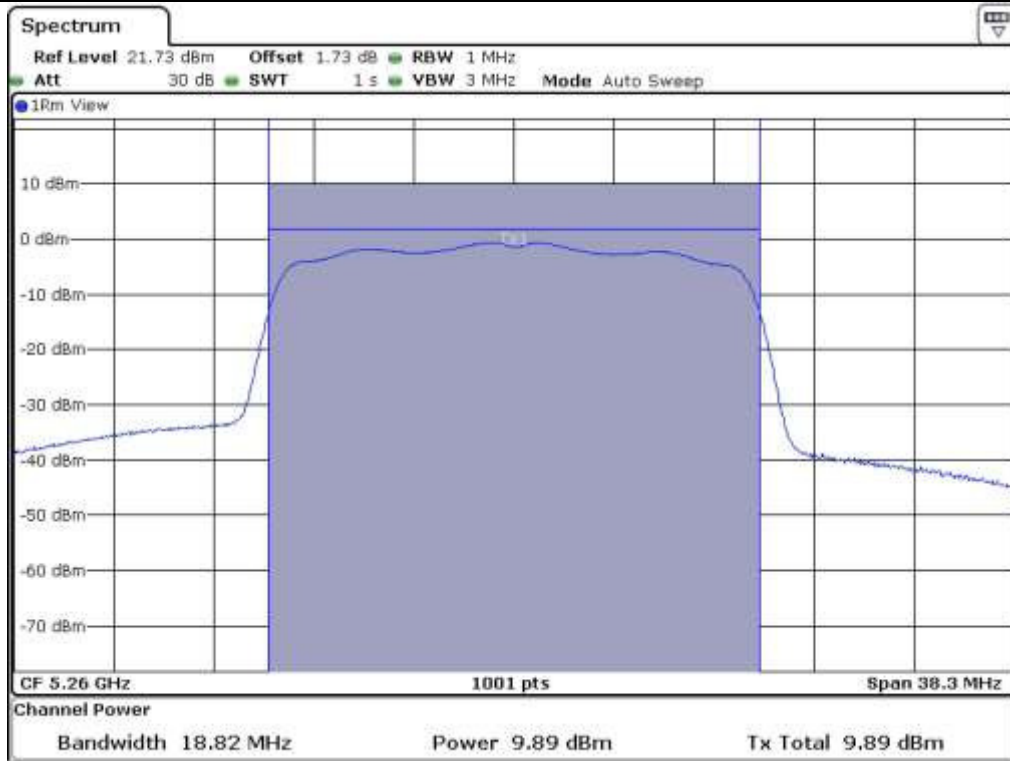

Low Channel @ 5 260 MHz (26 dB Bandwidth)



Middle Channel @ 5 300 MHz (26 dB Bandwidth)

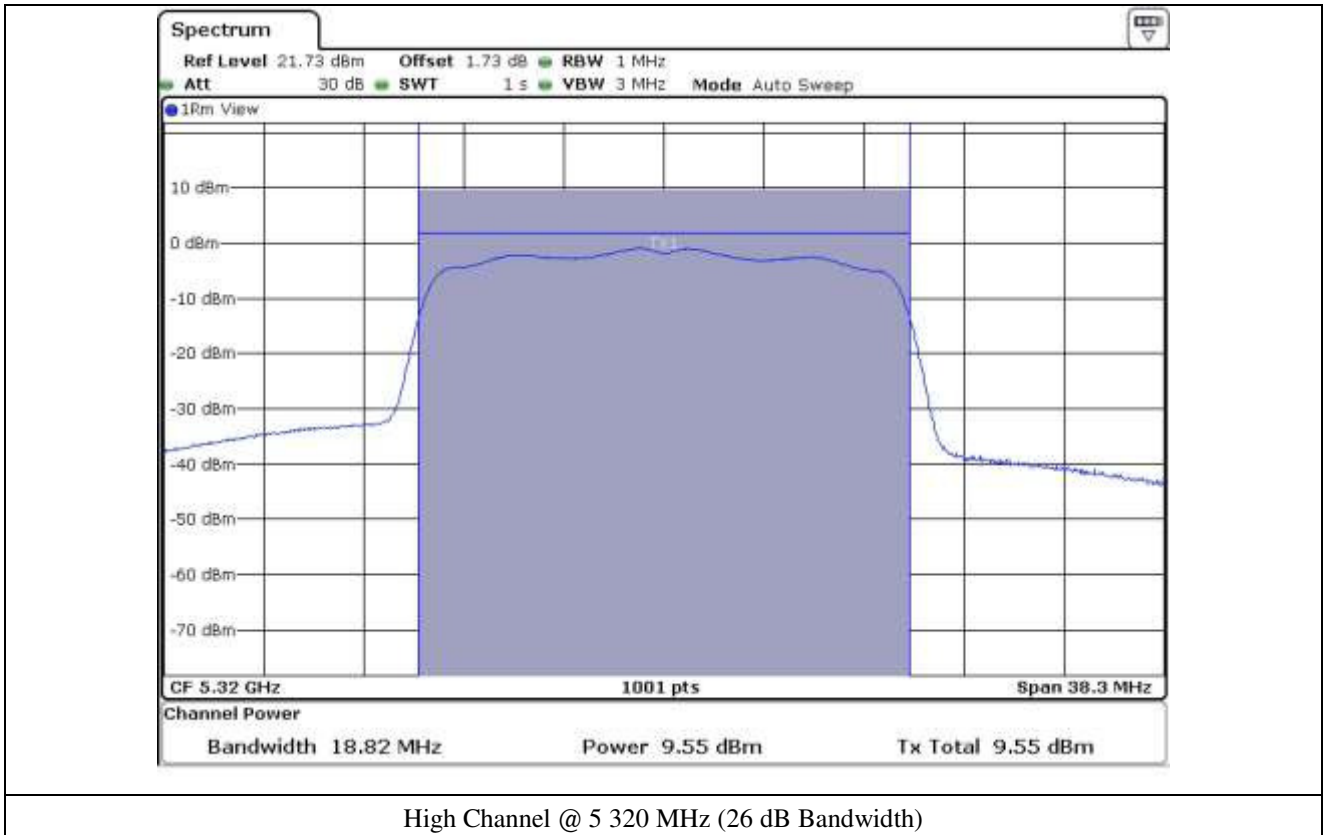



Low Channel @ 5 500 MHz (26 dB Bandwidth)



Middle Channel @ 5 600 MHz (26 dB Bandwidth)

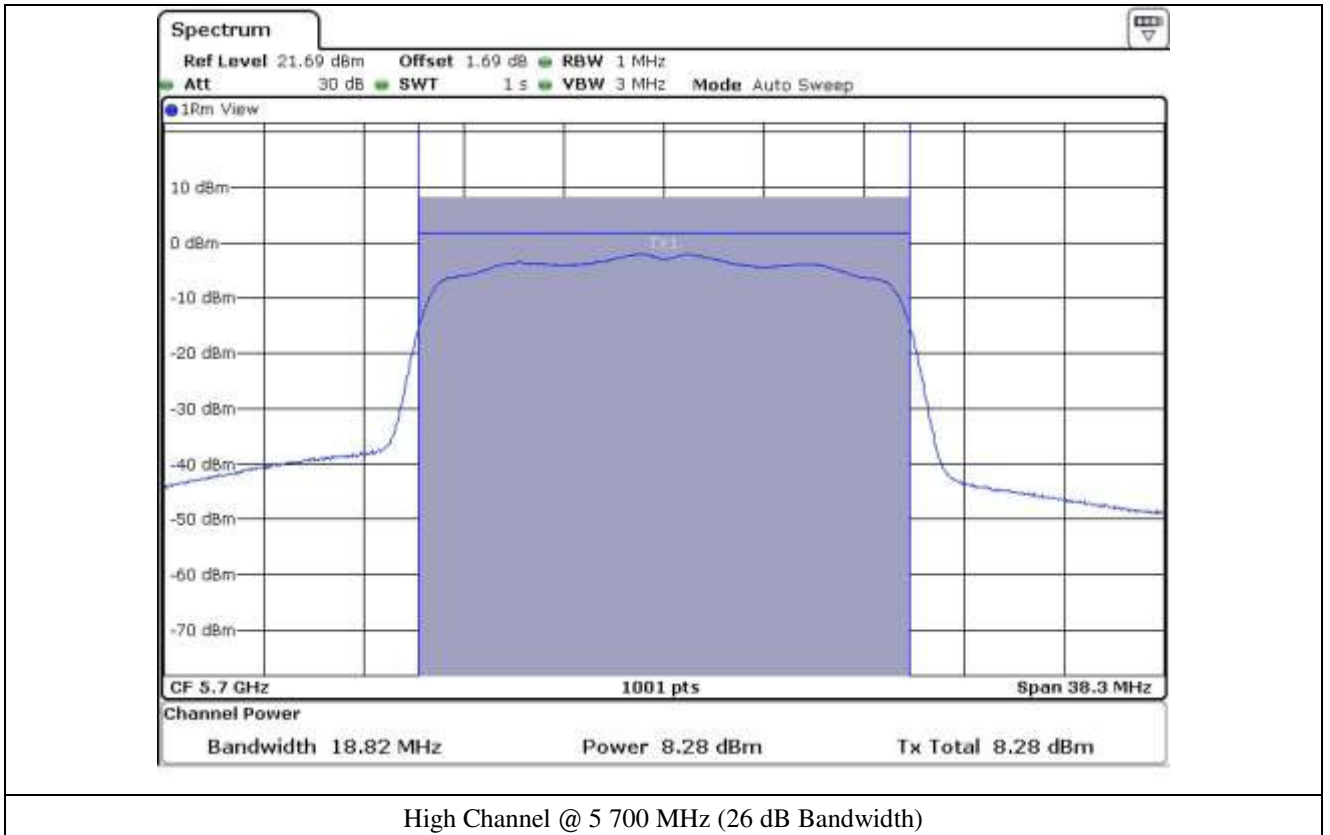



Low Channel @ 5.745 MHz (26 dB Bandwidth)

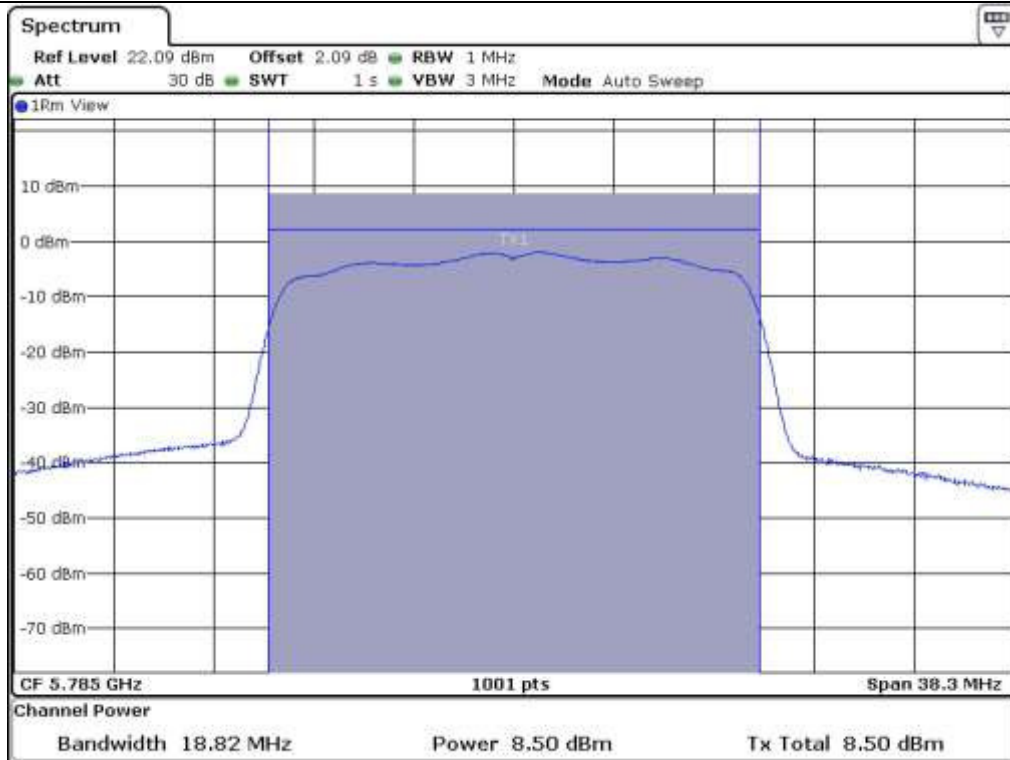

Middle Channel @ 5.785 MHz (26 dB Bandwidth)

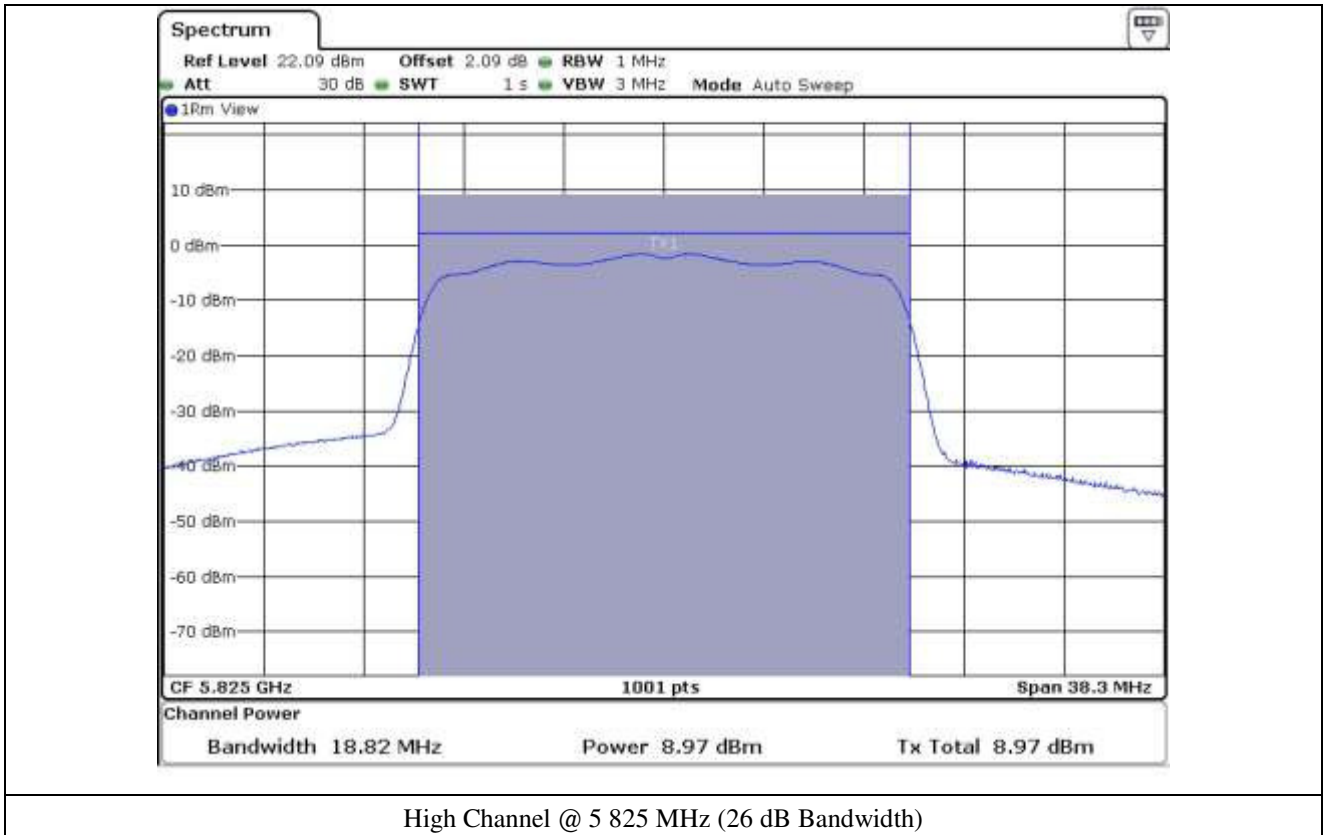

9. PEAK POWER SPECTRUL DENSITY

9.1 Operating environment

Temperature : 22 °C
 Relative humidity : 55 % R.H.

9.2 Test set-up

The antenna output of the EUT was connected to the spectrum analyzer. The resolution bandwidth is set to 1 MHz, the video bandwidth is set to 3 times the resolution bandwidth. The maximum level form the EUT in 1 MHz bandwidth was measured with above condition.

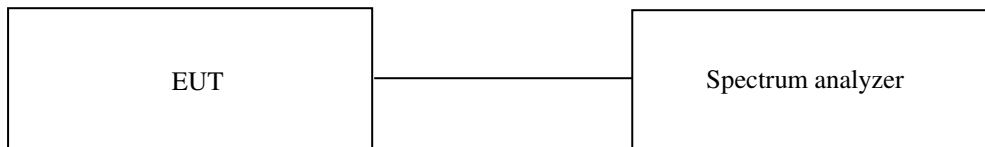

9.3 Test equipment used

Model Number	Manufacturer	Description	Serial Number	Last Cal.
■ - FSV40	Rohde & Schwarz	Signal Analyzer	101009	Jul. 22, 2015 (1Y)

All test equipment used is calibrated on a regular basis.

9.4 Test data for 802.11a RLAN Mode

- Test Date : March 15, 2016
- Operating condition : Highest Output Power Transmitting Mode
- Test Result : Pass

FREQUENCY RANGE (MHz)	CHANNEL	FREQUENCY (MHz)	MEASURED VLAUE (dBm)	LIMIT (dBm)	MARGIN (dB)
5 150 ~ 5 250	Low	5 180	-0.12	11.00	11.12
	Middle	5 200	-0.81	11.00	11.81
	High	5 240	0.13	11.00	10.87
5 250 ~ 5 350	Low	5 260	-0.84	11.00	11.84
	Middle	5 300	0.00	11.00	11.00
	High	5 320	-0.86	11.00	11.86
5 470 ~ 5 725	Low	5 500	-1.62	11.00	12.62
	Middle	5 600	-2.42	11.00	13.42
	High	5 700	-1.85	11.00	12.85
5 725 ~ 5 850	Low	5 745	-0.31	30.00	30.31
	Middle	5 785	-1.94	30.00	31.94
	High	5 825	-1.49	30.00	31.49

Remark: See next page for measurement data.



Tested by: Jun-Hui, Lee / Senior Engineer



Low Channel (5 180 MHz)



Middle Channel (5 200 MHz)





Low Channel (5 260 MHz)



Middle Channel (5 300 MHz)



High Channel (5 320 MHz)



Low Channel (5 500 MHz)



Middle Channel (5 600 MHz)





Low Channel (5.745 MHz)



Middle Channel (5.785 MHz)



High Channel (5 825 MHz)

9.5 Test data for 802.11n_HT20 RLAN Mode

- Test Date : March 15, 2016
- Operating condition : Highest Output Power Transmitting Mode
- Test Result : Pass

FREQUENCY RANGE (MHz)	CHANNEL	FREQUENCY (MHz)	MEASURED VALUE (dBm)	LIMIT (dBm)	MARGIN (dB)
5 150 ~ 5 250	Low	5 180	-0.30	11.00	11.30
	Middle	5 200	-0.93	11.00	11.93
	High	5 240	0.27	11.00	10.73
5 250 ~ 5 350	Low	5 260	-0.52	11.00	11.52
	Middle	5 300	0.15	11.00	10.85
	High	5 320	-0.63	11.00	11.63
5 470 ~ 5 725	Low	5 500	-1.70	11.00	12.70
	Middle	5 600	-2.43	11.00	13.43
	High	5 700	-2.01	11.00	13.01
5 725 ~ 5 850	Low	5 745	-0.25	30.00	30.25
	Middle	5 785	-2.02	30.00	32.02
	High	5 825	-1.56	30.00	31.56

Remark: See next page for measurement data.



Tested by: Jun-Hui, Lee / Senior Engineer



Low Channel (5 180 MHz)



Middle Channel (5 200 MHz)





Low Channel (5 260 MHz)



Middle Channel (5 300 MHz)



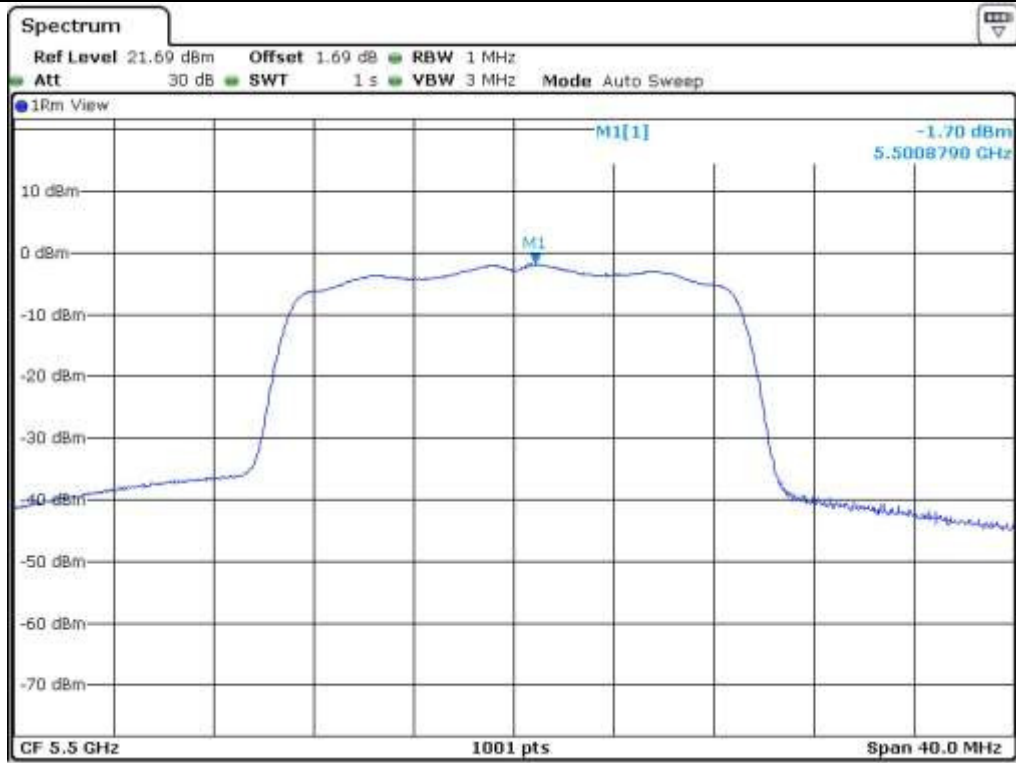

Low Channel (5 500 MHz)



Middle Channel (5 600 MHz)





Low Channel (5 745 MHz)



Middle Channel (5 785 MHz)



10. FREQUENCY STABILITY WITH TEMPERATURE VARIATION

10.1 Operating environment

Temperature : 22 °C
 Relative humidity : 55 % R.H.

10.2 Test set-up

Turn EUT off and set chamber temperature to -30 °C and then allow sufficient time (approximately 20 min to 30 min after chamber reach the assigned temperature) for EUT to stabilize. Turn on the EUT and measure the EUT operating frequency and then turn off the EUT after the measurement. The temperature in the chamber was raised 10 °C step from 0 °C to +65 °C. Repeat above method for frequency measurements every 10 °C step and then record all measured frequencies on each temperature step.

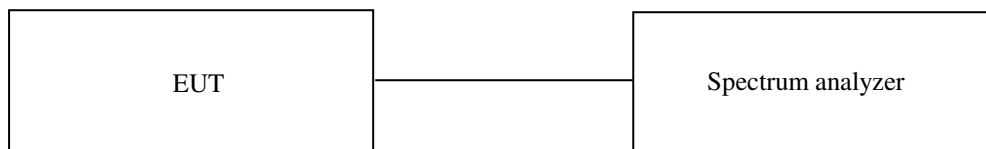

10.3 Test equipment used

Model Number	Manufacturer	Description	Serial Number	Last Cal.(Interval)
■ - FSV40	Rohde & Schwarz	Signal Analyzer	101009	Jul. 22, 2015 (1Y)
■ - SSE-43CI-A	Samkun Tech	Humidity Chamber	060712	May 15, 2015 (1Y)
■ - DRP-305DN	DIGITAL Elec.	DC Power supply	4030195	Sep. 03, 2015 (1Y)

All test equipment used is calibrated on a regular basis.

10.4 Test Data for 5 150 MHz ~ 5 250 MHz Band

-. Test Date : March 15, 2016

-. Result : Pass

Temperature (°C)	Carrier Freq. (Hz)	Measured Freq. (Hz)	Freequency Error (kHz)
0	5 180 000 000	5 180 027 125	27.125
10		5 180 025 593	25.593
20		5 180 024 018	24.018
30		5 180 022 954	22.954
40		5 180 022 018	22.018
50		5 180 021 035	21.035
60		5 180 020 439	20.439
65		5 180 019 787	19.787
0		5 200 000 000	5 200 027 165
10	5 200 025 737		25.737
20	5 200 024 485		24.485
30	5 200 023 812		23.812
40	5 200 022 949		22.949
50	5 200 022 013		22.013
60	5 200 021 287		21.287
65	5 200 020 620		20.620
0	5 240 000 000		5 240 028 182
10		5 240 026 604	26.604
20		5 240 025 251	25.251
30		5 240 024 377	24.377
40		5 240 023 318	23.318
50		5 240 022 485	22.485
60		5 240 021 973	21.973
65		5 240 020 783	20.783



Tested by: Jun-Hui, Lee / Senior Engineer

10.5 Test Data for 5 250 MHz ~ 5 350 MHz Band

-. Test Date : March 15, 2016

-. Result : Pass

Temperature (°C)	Carrier Freq. (Hz)	Measured Freq. (Hz)	Freequency Error (kHz)
0	5 260 000 000	5 260 028 557	28.557
10		5 260 027 211	27.211
20		5 260 025 748	25.748
30		5 260 024 696	24.696
40		5 260 023 718	23.718
50		5 260 022 640	22.640
60		5 260 021 810	21.810
65		5 260 020 973	20.973
0		5 300 000 000	5 300 029 054
10	5 300 027 711		27.711
20	5 300 026 183		26.183
30	5 300 025 268		25.268
40	5 300 024 451		24.451
50	5 300 023 376		23.376
60	5 300 022 764		22.764
65	5 300 021 506		21.506
0	5 320 000 000		5 320 029 547
10		5 320 027 846	27.846
20		5 320 026 701	26.701
30		5 320 025 842	25.842
40		5 320 025 004	25.004
50		5 320 024 028	24.028
60		5 320 023 250	23.250
65		5 320 022 155	22.155



Tested by: Jun-Hui, Lee / Senior Engineer

10.6 Test Data for 5 470 MHz ~ 5 725 MHz Band

-. Test Date : March 15, 2016

-. Result : Pass

Temperature (°C)	Carrier Freq. (Hz)	Measured Freq. (Hz)	Freequency Error (kHz)
0	5 500 000 000	5 500 036 057	36.057
10		5 500 034 773	34.773
20		5 500 033 186	33.186
30		5 500 032 340	32.340
40		5 500 031 252	31.252
50		5 500 030 133	30.133
60		5 500 029 352	29.352
65		5 500 028 438	28.438
0		5 600 000 000	5 600 036 871
10	5 600 035 380		35.380
20	5 600 034 098		34.098
30	5 600 033 145		33.145
40	5 600 032 389		32.389
50	5 600 031 212		31.212
60	5 600 030 165		30.165
65	5 600 029 358		29.358
0	5 700 000 000		5 700 038 033
10		5 700 036 417	36.417
20		5 700 034 936	34.936
30		5 700 034 082	34.082
40		5 700 033 123	33.123
50		5 700 032 365	32.365
60		5 700 031 015	31.015
65		5 700 030 217	30.217



Tested by: Jun-Hui, Lee / Senior Engineer

10.7 Test Data for 5 725 MHz ~ 5 850 MHz Band

-. Test Date : March 15, 2016

-. Result : Pass

Temperature (°C)	Carrier Freq. (Hz)	Measured Freq. (Hz)	Freequency Error (kHz)
0	5 745 000 000	5 745 038 201	38.201
10		5 745 036 755	36.755
20		5 745 035 310	35.310
30		5 745 034 120	34.120
40		5 745 033 416	33.416
50		5 745 032 257	32.257
60		5 745 031 319	31.319
65		5 745 030 382	30.382
0		5 785 000 000	5 785 038 616
10	5 785 037 131		37.131
20	5 785 035 844		35.844
30	5 785 034 989		34.989
40	5 785 034 037		34.037
50	5 785 033 217		33.217
60	5 785 032 215		32.215
65	5 785 031 628		31.628
0	5 825 000 000		5 825 039 138
10		5 825 038 004	38.004
20		5 825 036 291	36.291
30		5 825 035 174	35.174
40		5 825 034 222	34.222
50		5 825 033 426	33.426
60		5 825 032 196	32.196
65		5 825 031 342	31.342

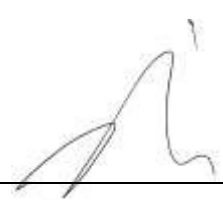

Tested by: Jun-Hui, Lee / Senior Engineer

11. FREQUENCY STABILITY WITH VOLTAGE VARIATION

11.1 Operating environment

Temperature : 22 °C
 Relative humidity : 55 % R.H.

11.2 Test set-up

An external DC power supply was connected to the input of the EUT. The voltage of EUT set to 115 % of the nominal value and then was reduced to 85 % of nominal voltage. The output frequency was recorded at each step.

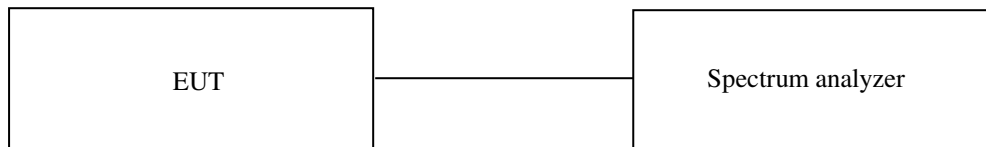

11.3 Test equipment used

Model Number	Manufacturer	Description	Serial Number	Last Cal.(Interval)
■ - FSV40	Rohde & Schwarz	Signal Analyzer	101009	Jul 22, 2015 (1Y)
■ - DRP-305DN	DIGITAL Elec.	DC Power supply	4030195	Sep. 03, 2015 (1Y)

All test equipment used is calibrated on a regular basis.

11.4 Test Data for 5 150 MHz ~ 5 250 MHz Band

-. Test Date : March 15, 2016

-. Result : Pass

Voltage (Vdc)	Carrier Freq. (Hz)	Measured Freq. (Hz)	Freequency Error (kHz)
4.37	5 180 000 000	5 180 024 189	24.189
3.80		5 180 024 142	24.142
3.23		5 180 024 083	24.083
4.37	5 200 000 000	5 200 024 570	24.570
3.80		5 200 024 513	24.513
3.23		5 200 024 436	24.436
4.37	5 240 000 000	5 240 025 138	25.138
3.80		5 240 025 215	25.215
3.23		5 240 025 171	25.171

11.5 Test Data for 5 250 MHz ~ 5 350 MHz Band

-. Test Date : March 15, 2016

-. Result : Pass

Voltage (Vdc)	Carrier Freq. (Hz)	Measured Freq. (Hz)	Freequency Error (kHz)
4.37	5 260 000 000	5 260 025 511	25.511
3.80		5 260 025 681	25.681
3.23		5 260 025 569	25.569
4.37	5 300 000 000	5 300 026 412	26.412
3.80		5 300 026 163	26.163
3.23		5 300 026 047	26.047
4.37	5 320 000 000	5 320 026 462	26.462
3.80		5 320 026 412	26.412
3.23		5 320 026 344	26.344

11.6 Test Data for 5 470 MHz ~ 5 725 MHz Band

-. Test Date : March 15, 2016

-. Result : Pass

Voltage (Vdc)	Carrier Freq. (Hz)	Measured Freq. (Hz)	Freequency Error (kHz)
4.37	5 500 000 000	5 500 033 158	33.158
3.80		5 500 033 200	33.200
3.23		5 500 033 141	33.141
4.37	5 600 000 000	5 600 033 932	33.932
3.80		5 600 034 038	34.038
3.23		5 600 033 887	33.887
4.37	5 700 000 000	5 700 034 860	34.860
3.80		5 700 034 898	34.898
3.23		5 700 034 916	34.916

11.7 Test Data for 5 725 MHz ~ 5 850 MHz Band

-. Test Date : March 15, 2016

-. Result : Pass

Voltage (Vdc)	Carrier Freq. (Hz)	Measured Freq. (Hz)	Freequency Error (kHz)
4.37	5 745 000 000	5 745 035 479	35.479
3.80		5 745 035 485	35.485
3.23		5 745 035 430	35.430
4.37	5 785 000 000	5 785 035 681	35.681
3.80		5 785 035 737	35.737
3.23		5 785 035 799	35.799
4.37	5 825 000 000	5 825 036 274	36.274
3.80		5 825 036 300	36.300
3.23		5 825 036 263	36.263



Tested by: Jun-Hui, Lee / Senior Engineer

12. RADIATED SPURIOUS EMISSIONS

12.1 Operating environment

Temperature : (23 ~ 24) °C
 Relative humidity : (43 ~ 44) % R.H.

12.2 Test set-up for conducted measurement

The radiated emissions measurements were performed on the 3 m, open-field test site. The EUT was placed on a non-conductive turntable above the ground plane.

The frequency spectrum from 30 MHz to 40 GHz was scanned and maximum emission levels at each frequency recorded. The system was rotated 360°, and the antenna was varied in the height between 1.0 m and 4.0 m in order to determine the maximum emission levels. This procedure was performed for horizontal and vertical polarization of the receiving antenna.

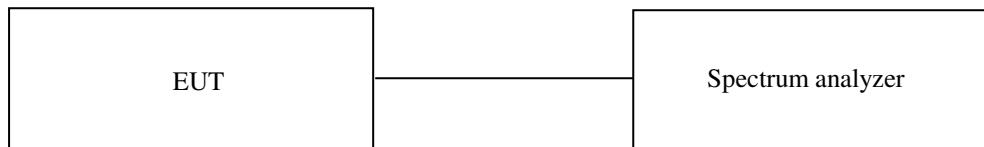

12.3 Test equipment used

Model Number	Manufacturer	Description	Serial Number	Last Cal.(Interval)
■ - FSV40	Rohde & Schwarz	Signal Analyzer	101009	Jul. 22, 2015 (1Y)
■ - ESCI	Rohde & Schwarz	Test Receiver	101012	Nov. 02, 2015 (1Y)
■ - 310N	Sonoma Instrument	Pre-Amplifier	312544	Apr. 29, 2015 (1Y)
■ - SCU-18	Rohde & Schwarz	Pre-Amplifier	10041	Nov. 23, 2015 (1Y)
■ - SCU40A	Rohde & Schwarz	Pre-Amplifier	100436	Jun. 04, 2015 (1Y)
■ - DT3000	Innco System	Turn Table	930611	N/A
■ - MA4000-EP	Innco System	Antenna Master	3320611	N/A
■ - VULB9163	Schwarzbeck	TRILOG Broadband Antenna	9163-421	Jul. 10, 2014 (2Y)
■ - BBHA9120D	Schwarzbeck	Horn Antenna	BBHA9120D295	Aug. 31, 2015 (2Y)
■ - BBHA9170	Schwarzbeck	Horn Antenna	BBHA9170178	Apr. 30, 2015 (2Y)

All test equipment used is calibrated on a regular basis.

12.4 Test data for 5 150 MHz ~ 5 250 MHz Band

12.4.1 Test data for 30 MHz ~ 1 000 MHz

Humidity Level : (43 ~ 44) % R.H. Temperature: (23 ~ 24) °C

Limits apply to : FCC CFR 47, PART 15, SUBPART C, SECTION 15.247

Result : PASSED

EUT : Premium Tablet Date: March 09, 2016

Detector : CISPR Quasi-Peak (6 dB Bandwidth: 120 kHz)

-. Low, Middle and High Channels were tested, but the worst data were recorded.

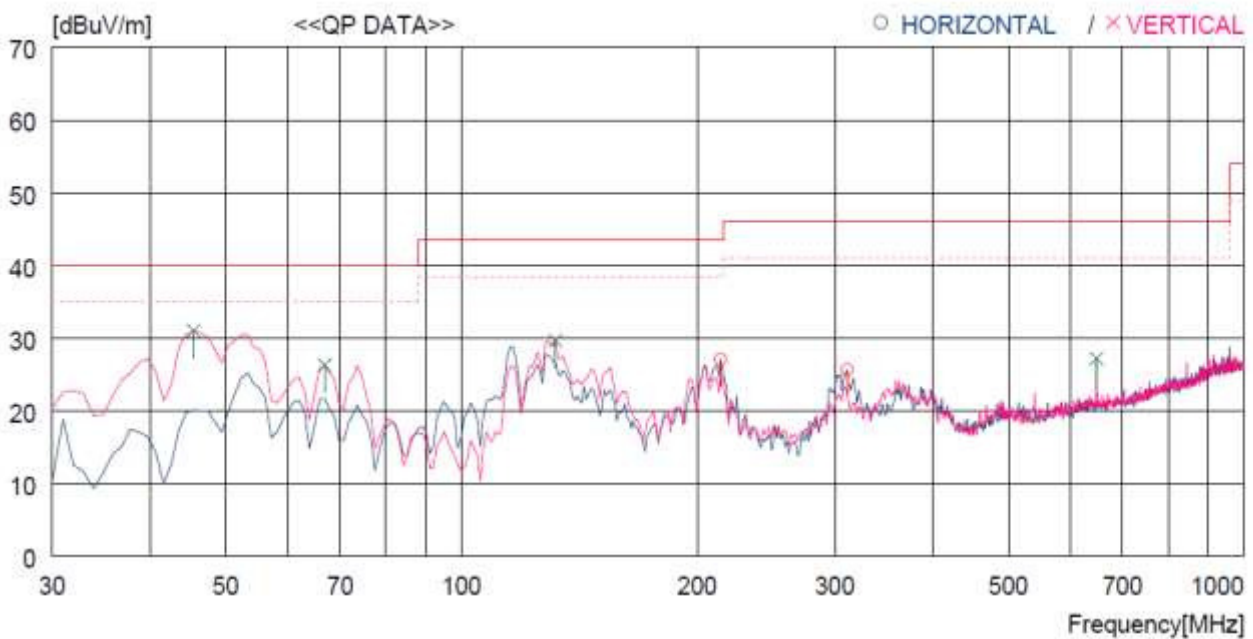

No.	FREQ [MHz]	READING QP [dBuV]	ANT FACTOR [dB]	LOSS [dB]	GAIN [dB]	RESULT [dBuV/m]	LIMIT [dBuV/m]	MARGIN [dB]	ANTENNA [cm]	TABLE [DEG]
---- Horizontal ----										
1	214.300	44.8	11.2	3.9	32.8	27.1	43.5	16.4	100	25
2	311.300	39.9	13.8	4.7	32.7	25.7	46.0	20.3	100	359
---- Vertical ----										
3	45.520	48.1	13.9	1.9	32.9	31.0	40.0	9.0	100	0
4	66.860	46.2	10.9	2.3	33.1	26.3	40.0	13.7	100	130
5	131.850	50.7	9.0	3.1	33.1	29.7	43.5	13.8	100	102
6	647.887	34.3	19.4	6.9	33.4	27.2	46.0	18.8	100	340

12.4.2 Test data for Below 30 MHz

- Test Date : March 09, 2016
- Resolution bandwidth : 200 Hz (from 9 kHz to 0.15 MHz), 9 kHz (from 0.15 MHz to 30 MHz)
- Frequency range : 9 kHz ~ 30 MHz
- Measurement distance : 3 m
- Operating mode : Transmitting mode

Frequency (MHz)	Reading (dBµV)	Ant. Pol. (H/V)	Ant. Height (m)	Angle (°)	Ant. Factor (dB/m)	Cable Loss	Emission Level(dBµV/m)	Limits (dBµV/m)	Margin (dB)
Any emissions were not observed from the EUT.									

12.4.3 Test data for above 1 GHz

- Test Date : March 09, 2016
- Resolution bandwidth : 1 MHz for Peak and Average Mode
- Video bandwidth : 1 MHz for Peak Mode, 10 Hz for Average Mode
- Frequency range : 1 GHz ~ 40 GHz
- Measurement distance : 3 m
- Operating mode : Transmitting mode

Frequency (MHz)	Reading (dBμV)	Detector Mode	Ant. Pol. (H/V)	Ant. Factor	Cable Loss	Amp Gain	Total (dBμV/m)	Limits (dBμV/m)	Margin (dB)
Low Channel									
10 360.00	52.40	Peak	H	38.60	16.30	42.50	64.80	73.98	9.18
	35.18	Average	H				47.58	53.98	6.40
	52.11	Peak	V				64.51	73.98	9.47
	35.25	Average	V				47.65	53.98	6.33
Middle Channel									
10 400.00	52.41	Peak	H	38.60	16.30	42.50	64.81	73.98	9.17
	35.25	Average	H				47.65	53.98	6.33
	51.84	Peak	V				64.24	73.98	9.74
	34.12	Average	V				46.52	53.98	7.46
High Channel									
10 480.00	52.42	Peak	H	38.60	16.30	42.50	64.82	73.98	9.16
	36.07	Average	H				48.47	53.98	5.51
	52.06	Peak	V				64.46	73.98	9.52
	36.09	Average	V				48.49	53.98	5.49

Remark - "H": Horizontal, "V": Vertical

Margin (dB) = Limits (dBμV/m) - Emission Level (dBμV/m)



Tested by: Jun-Hui, Lee / Senior Engineer

12.5 Test data for 5 250 MHz ~ 5 350 MHz Band

12.5.1 Test data for 30 MHz ~ 1 000 MHz

Humidity Level : (43 ~ 44) % R.H. Temperature: (23 ~ 24) °C

Limits apply to : FCC CFR 47, PART 15, SUBPART C, SECTION 15.247

Result : PASSED

EUT : Premium Tablet

Date: March 09, 2016

Detector : CISPR Quasi-Peak (6 dB Bandwidth: 120 kHz)

-. Low, Middle and High Channels were tested, but the worst data were recorded.

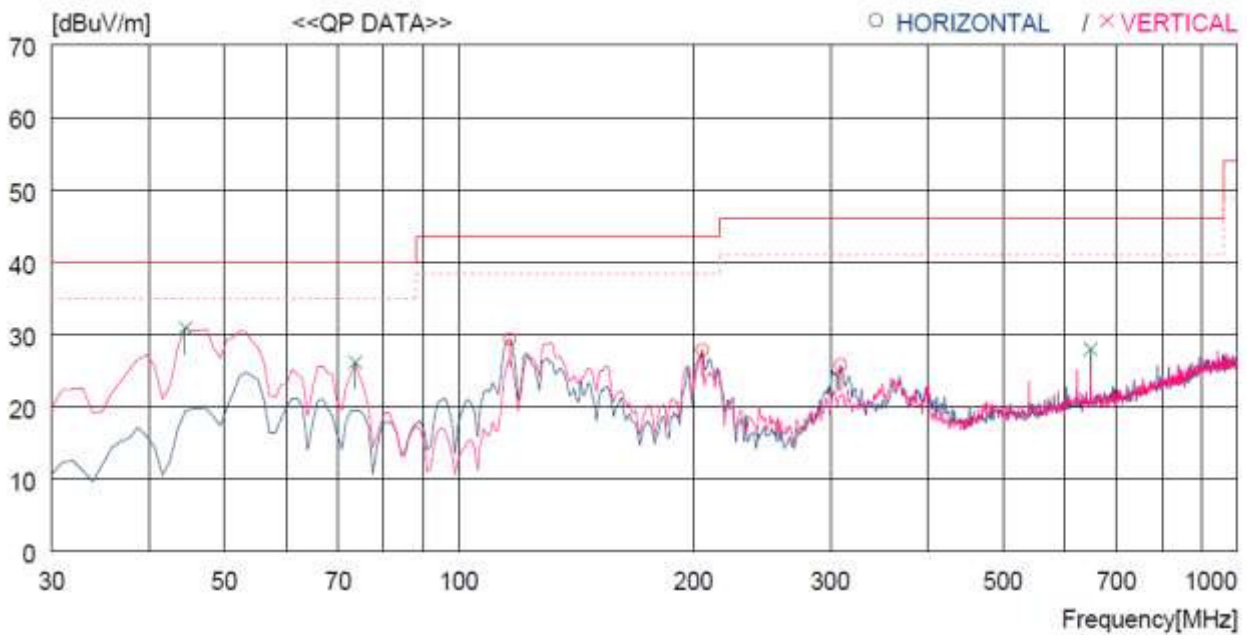

No.	FREQ [MHz]	READING QP [dBuV]	ANT FACTOR [dB]	LOSS [dB]	GAIN [dB]	RESULT [dBuV/m]	LIMIT [dBuV/m]	MARGIN [dB]	ANTENNA [cm]	TABLE [DEG]
----- Horizontal -----										
1	116.330	48.7	10.6	3.3	33.2	29.4	43.5	14.1	300	359
2	205.570	46.0	10.9	3.8	32.8	27.9	43.5	15.6	100	359
3	309.360	40.0	13.8	4.7	32.7	25.8	46.0	20.2	100	195
----- Vertical -----										
4	44.550	48.0	13.9	1.9	32.9	30.9	40.0	9.1	100	0
5	73.650	48.0	8.9	2.4	33.1	26.2	40.0	13.8	200	359
6	647.887	35.1	19.4	6.9	33.4	28.0	46.0	18.0	100	186

12.5.2 Test data for Below 30 MHz

- Test Date : March 09, 2016
- Resolution bandwidth : 200 Hz (from 9 kHz to 0.15 MHz), 9 kHz (from 0.15 MHz to 30 MHz)
- Frequency range : 9 kHz ~ 30 MHz
- Measurement distance : 3 m
- Operating mode : Transmitting mode

Frequency (MHz)	Reading (dBμV)	Ant. Pol. (H/V)	Ant. Height (m)	Angle (°)	Ant. Factor (dB/m)	Cable Loss	Emission Level (dBμV/m)	Limits (dBμV/m)	Margin (dB)
Any emissions were not observed from the EUT.									

12.5.3 Test data for above 1 GHz

- Test Date : March 09, 2016
- Resolution bandwidth : 1 MHz for Peak and Average Mode
- Video bandwidth : 1 MHz for Peak Mode, 10 Hz for Average Mode
- Frequency range : 1 GHz ~ 40 GHz
- Measurement distance : 3 m
- Operating mode : Transmitting mode

Frequency (MHz)	Reading (dBμV)	Detector Mode	Ant. Pol. (H/V)	Ant. Factor	Cable Loss	Amp Gain	Total (dBμV/m)	Limits (dBμV/m)	Margin (dB)
Low Channel									
10 520.00	53.48	Peak	H	38.80	16.50	42.50	66.28	73.98	7.70
	37.54	Average	H				50.34	53.98	3.64
	52.11	Peak	V				64.91	73.98	9.07
	36.18	Average	V				48.98	53.98	5.00
Middle Channel									
10 600.00	53.30	Peak	H	38.80	16.50	42.50	66.10	73.98	7.88
	36.68	Average	H				49.48	53.98	4.50
	53.10	Peak	V				65.90	73.98	8.08
	36.97	Average	V				49.77	53.98	4.21
High Channel									
10 640.00	53.63	Peak	H	38.80	16.50	42.50	66.43	73.98	7.55
	36.54	Average	H				49.34	53.98	4.64
	53.25	Peak	V				66.05	73.98	7.93
	36.81	Average	V				49.61	53.98	4.37

Remark - "H": Horizontal, "V": Vertical

Margin (dB) = Limits (dBμV/m) - Emission Level (dBμV/m)

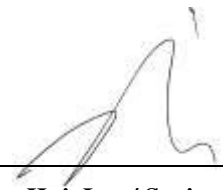

Tested by: Jun-Hui, Lee / Senior Engineer

12.6 Test data for 5 470 MHz ~ 5 725 MHz Band

12.6.1 Test data for 30 MHz ~ 1 000 MHz

Humidity Level : (43 ~ 44) % R.H. Temperature: (23 ~ 24) °C

Limits apply to : FCC CFR 47, PART 15, SUBPART C, SECTION 15.247

Result : PASSED

EUT : Premium Tablet

Date: March 09, 2016

Detector : CISPR Quasi-Peak (6 dB Bandwidth: 120 kHz)

-. Low, Middle and High Channels were tested, but the worst data were recorded.

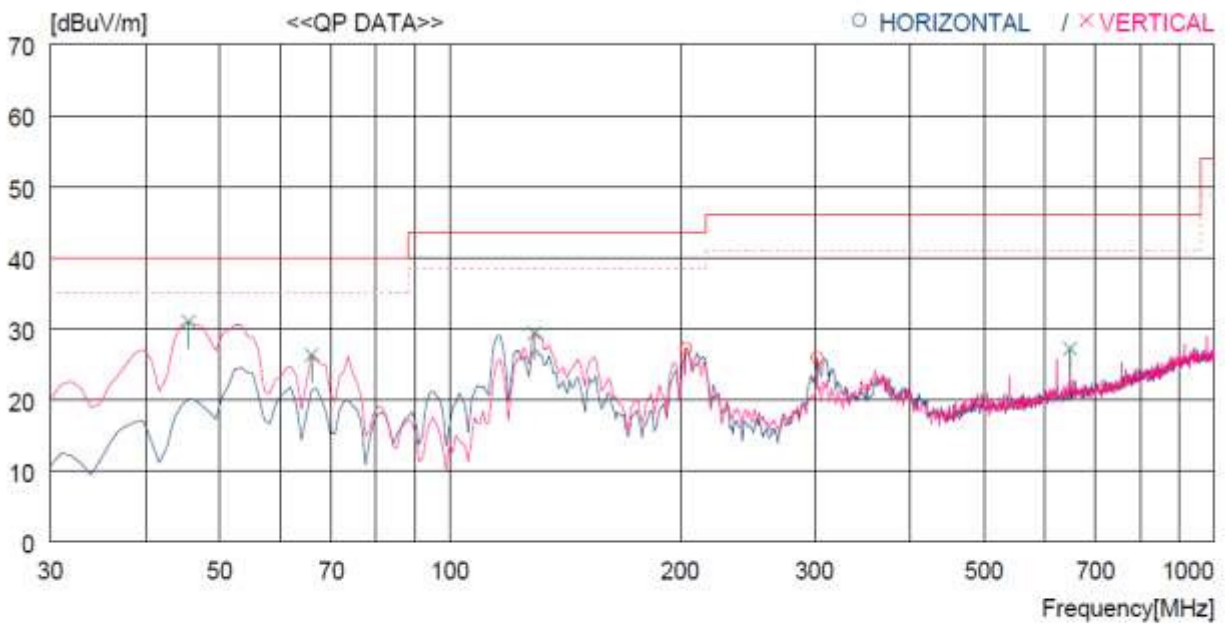

No.	FREQ [MHz]	READING QP [dBuV]	ANT FACTOR [dB]	LOSS [dB]	GAIN [dB]	RESULT [dBuV/m]	LIMIT [dBuV/m]	MARGIN [dB]	ANTENNA [cm]	TABLE [DEG]
---- Horizontal ----										
1	203.630	45.3	10.9	3.8	32.8	27.2	43.5	16.3	100	359
2	302.570	40.4	13.6	4.6	32.7	25.9	46.0	20.1	100	359
---- Vertical ----										
3	45.520	48.1	13.9	1.9	32.9	31.0	40.0	9.0	100	256
4	65.890	45.9	11.2	2.3	33.1	26.3	40.0	13.7	100	158
5	128.940	50.1	9.3	3.1	33.1	29.4	43.5	14.1	100	0
6	647.887	34.3	19.4	6.9	33.4	27.2	46.0	18.8	100	0

12.6.2 Test data for Below 30 MHz

- Test Date : March 09, 2016
- Resolution bandwidth : 200 Hz (from 9 kHz to 0.15 MHz), 9 kHz (from 0.15 MHz to 30 MHz)
- Frequency range : 9 kHz ~ 30 MHz
- Measurement distance : 3 m
- Operating mode : Transmitting mode

Frequency (MHz)	Reading (dBμV)	Ant. Pol. (H/V)	Ant. Height (m)	Angle (°)	Ant. Factor (dB/m)	Cable Loss	Emission Level(dBμV/m)	Limits (dBμV/m)	Margin (dB)
Any emissions were not observed from the EUT.									

12.6.3 Test data for above 1 GHz

- Test Date : March 09, 2016
- Resolution bandwidth : 1 MHz for Peak and Average Mode
- Video bandwidth : 1 MHz for Peak Mode, 10 Hz for Average Mode
- Frequency range : 1 GHz ~ 40 GHz
- Measurement distance : 3 m
- Operating mode : Transmitting mode

Frequency (MHz)	Reading (dBμV)	Detector Mode	Ant. Pol. (H/V)	Ant. Factor	Cable Loss	Amp Gain	Total (dBμV/m)	Limits (dBμV/m)	Margin (dB)
Low Channel									
11 000.00	53.18	Peak	H	39.40	17.30	42.60	67.28	73.98	6.70
	36.30	Average	H				50.40	53.98	3.58
	52.74	Peak	V				66.84	73.98	7.14
	35.98	Average	V				50.08	53.98	3.90
Middle Channel									
11 200.00	52.00	Peak	H	39.40	17.30	42.60	66.10	73.98	7.88
	35.47	Average	H				49.57	53.98	4.41
	52.18	Peak	V				66.28	73.98	7.70
	36.01	Average	V				50.11	53.98	3.87
High Channel									
11 400.00	52.22	Peak	H	39.40	17.30	42.60	66.32	73.98	7.66
	35.53	Average	H				49.63	53.98	4.35
	51.88	Peak	V				65.98	73.98	8.00
	35.25	Average	V				49.35	53.98	4.63

Remark - "H": Horizontal, "V": Vertical

Margin (dB) = Limits (dBμV/m) - Emission Level (dBμV/m)

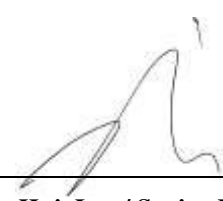

Tested by: Jun-Hui, Lee / Senior Engineer

12.7 Test data for 5 725 MHz ~ 5 850 MHz Band

12.7.1 Test data for 30 MHz ~ 1 000 MHz

Humidity Level : (43 ~ 44) % R.H. Temperature: (23 ~ 24) °C

Limits apply to : FCC CFR 47, PART 15, SUBPART C, SECTION 15.247

Result : PASSED

EUT : Premium Tablet Date: March 09, 2016

Detector : CISPR Quasi-Peak (6 dB Bandwidth: 120 kHz)

-. Low, Middle and High Channels were tested, but the worst data were recorded.

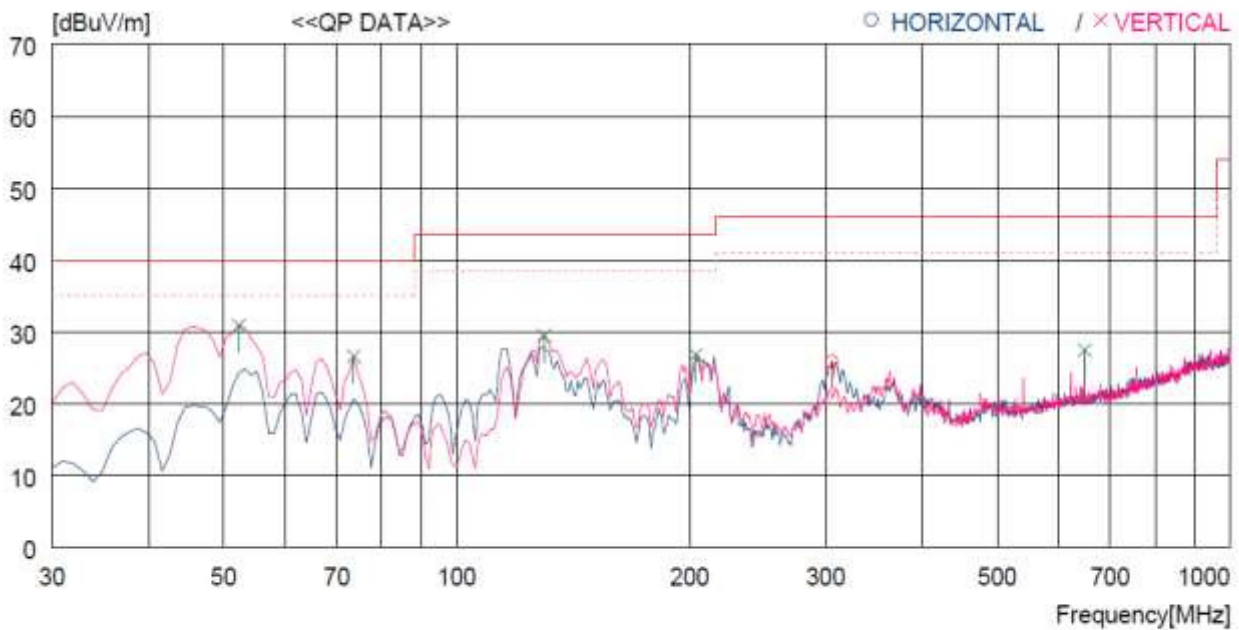

No.	FREQ [MHz]	READING QP [dBuV]	ANT FACTOR [dB]	LOSS [dB]	GAIN [dB]	RESULT [dBuV/m]	LIMIT [dBuV/m]	MARGIN [dB]	ANTENNA [cm]	TABLE [DEG]
----- Horizontal -----										
1	305.480	40.2	13.7	4.7	32.7	25.9	46.0	20.1	100	180
----- Vertical -----										
2	52.310	48.3	13.6	2.0	33.0	30.9	40.0	9.1	100	0
3	73.650	48.4	8.9	2.4	33.1	26.6	40.0	13.4	200	146
4	129.910	50.3	9.2	3.1	33.1	29.5	43.5	14.0	100	0
5	203.630	44.9	10.9	3.8	32.8	26.8	43.5	16.7	100	214
6	647.887	34.6	19.4	6.9	33.4	27.5	46.0	18.5	100	348

12.7.2 Test data for Below 30 MHz

- Test Date : March 09, 2016
- Resolution bandwidth : 200 Hz (from 9 kHz to 0.15 MHz), 9 kHz (from 0.15 MHz to 30 MHz)
- Frequency range : 9 kHz ~ 30 MHz
- Measurement distance : 3 m
- Operating mode : Transmitting mode

Frequency (MHz)	Reading (dBμV)	Ant. Pol. (H/V)	Ant. Height (m)	Angle (°)	Ant. Factor (dB/m)	Cable Loss	Emission Level(dBμV/m)	Limits (dBμV/m)	Margin (dB)
Any emissions were not observed from the EUT.									

12.7.3 Test data for above 1 GHz

- Test Date : March 09, 2016
- Resolution bandwidth : 1 MHz for Peak and Average Mode
- Video bandwidth : 1 MHz for Peak Mode, 10 Hz for Average Mode
- Frequency range : 1 GHz ~ 40 GHz
- Measurement distance : 3 m
- Operating mode : Transmitting mode

Frequency (MHz)	Reading (dBμV)	Detector Mode	Ant. Pol. (H/V)	Ant. Factor	Cable Loss	Amp Gain	Total (dBμV/m)	Limits (dBμV/m)	Margin (dB)
Low Channel									
11 490.00	52.01	Peak	H	39.50	17.50	42.70	66.31	73.98	7.67
	36.43	Average	H				50.73	53.98	3.25
	51.57	Peak	V				65.87	73.98	8.11
	36.75	Average	V				51.05	53.98	2.93
Middle Channel									
11 570.00	51.98	Peak	H	39.50	17.50	42.70	66.28	73.98	7.70
	36.51	Average	H				50.81	53.98	3.17
	51.64	Peak	V				65.94	73.98	8.04
	36.45	Average	V				50.75	53.98	3.23
High Channel									
11 650.00	51.75	Peak	H	39.50	17.50	42.70	66.05	73.98	7.93
	37.26	Average	H				51.56	53.98	2.42
	51.30	Peak	V				65.60	73.98	8.38
	36.30	Average	V				50.60	53.98	3.38

Remark - "H": Horizontal, "V": Vertical

Margin (dB) = Limits (dBμV/m) - Emission Level (dBμV/m)



Tested by: Jun-Hui, Lee / Senior Engineer

13. RADIATED RESTRICTED BAND EDGE MEASUREMENTS

13.1 Operating environment

Temperature : 24 °C
 Relative humidity : 49 % R.H.

13.2 Test set-up for conducted measurement

The radiated emissions measurements were performed on the 3 m, open-field test site. The EUT was placed on a non-conductive turntable above the ground plane.

The system was rotated 360°, and the antenna was varied in the height between 1.0 m and 4.0 m in order to determine the maximum emission levels. This procedure was performed for horizontal and vertical polarization of the receiving antenna.

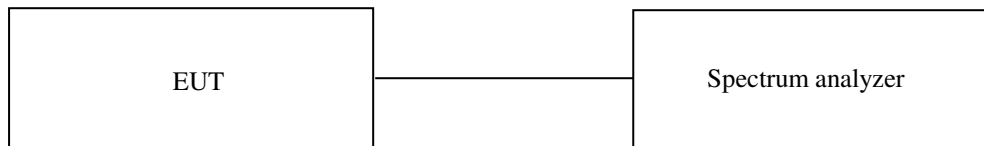

13.3 Test equipment used

Model Number	Manufacturer	Description	Serial Number	Last Cal.(Interval)
■ - FSV40	Rohde & Schwarz	Signal Analyzer	101009	Jul. 22, 2015 (1Y)
■ - ESCI	Rohde & Schwarz	Test Receiver	101012	Nov. 02, 2015 (1Y)
■ - 310N	Sonoma Instrument	Pre-Amplifier	312544	Apr. 29, 2015 (1Y)
■ - SCU-18	Rohde & Schwarz	Pre-Amplifier	10041	Nov. 23, 2015 (1Y)
■ - DT3000	Innco System	Turn Table	930611	N/A
■ - MA4000-EP	Innco System	Antenna Master	3320611	N/A
■ - VULB9163	Schwarzbeck	TRILOG Broadband Antenna	9163-421	Jul. 10, 2014 (2Y)
■ - BBHA9120D	Schwarzbeck	Horn Antenna	BBHA9120D295	Aug. 31, 2015 (2Y)
■ - BBHA9170	Schwarzbeck	Horn Antenna	BBHA9170178	Apr. 30, 2015 (2Y)

All test equipment used is calibrated on a regular basis.

13.4 Test data for 5 150 MHz ~ 5 250 MHz Band

13.4.1 Test data for 802.11a RLAN Mode

- Test Date : March 07, 2016
- Resolution bandwidth : 1 MHz for Peak and Average Mode for the emissions fall in restricted band,
100 kHz for Peak Mode for the emissions outside restricted band
- Video bandwidth : 1 MHz for Peak Mode, 10 Hz for Average Mode
- Measurement distance : 3 m
- Result : Pass

Frequency (MHz)	Reading (dBμV)	Detector Mode	Ant. Pol. (H/V)	Ant. Factor	Cable Loss	Amp Gain	Total (dBμV/m)	Limits (dBμV/m)	Margin (dB)
5 150.00	59.41	Peak	H	31.00	11.50	42.20	59.71	74.00	14.29
	38.19	Average	H				38.49	54.00	15.51
	55.13	Peak	V				55.43	74.00	18.57
	37.87	Average	V				38.17	54.00	15.83

Tabulated test data for Restricted Band

Remark - “H”: Horizontal, “V”: Vertical

Margin (dB) = Limits (dBμV/m) - Emission Level (dBμV/m)



Tested by: Jun-Hui, Lee / Senior Engineer

13.4.2 Test data for 802.11n_HT20 RLAN Mode

- Test Date : March 07, 2016
- Resolution bandwidth : 1 MHz for Peak and Average Mode for the emissions fall in restricted band,
100 kHz for Peak Mode for the emissions outside restricted band
- Video bandwidth : 1 MHz for Peak Mode, 10 Hz for Average Mode
- Measurement distance : 3 m
- Result : Pass

Frequency (MHz)	Reading (dBμV)	Detector Mode	Ant. Pol. (H/V)	Ant. Factor	Cable Loss	Amp Gain	Total (dBμV/m)	Limits (dBμV/m)	Margin (dB)
5 150.00	51.16	Peak	H	31.00	11.50	42.20	51.46	74.00	22.54
	36.72	Average	H				37.02	54.00	16.98
	51.42	Peak	V				51.72	74.00	22.28
	37.42	Average	V				37.72	54.00	16.28

Tabulated test data for Restricted Band

Remark - “H”: Horizontal, “V”: Vertical

$$\text{Margin (dB)} = \text{Limits (dB}\mu\text{V/m)} - \text{Emission Level (dB}\mu\text{V/m)}$$



Tested by: Jun-Hui, Lee / Senior Engineer

13.5 Test data for 5 250 MHz ~ 5 350 MHz Band

13.5.1 Test data for 802.11a RLAN Mode

- Test Date : March 07, 2016
- Resolution bandwidth : 1 MHz for Peak and Average Mode for the emissions fall in restricted band,
100 kHz for Peak Mode for the emissions outside restricted band
- Video bandwidth : 1 MHz for Peak Mode, 10 Hz for Average Mode
- Measurement distance : 3 m
- Result : Pass

Frequency (MHz)	Reading (dBµV)	Detector Mode	Ant. Pol. (H/V)	Ant. Factor	Cable Loss	Amp Gain	Total (dBµV/m)	Limits (dBµV/m)	Margin (dB)
5 350.00	52.76	Peak	H	31.30	11.70	42.20	53.56	74.00	20.44
	38.57	Average	H				39.37	54.00	14.63
	52.15	Peak	V				52.95	74.00	21.05
	37.89	Average	V				38.69	54.00	15.31

Tabulated test data for Restricted Band

Remark - “H”: Horizontal, “V”: Vertical

$$\text{Margin (dB)} = \text{Limits (dBµV/m)} - \text{Emission Level (dBµV/m)}$$



Tested by: Jun-Hui, Lee / Senior Engineer

13.5.2 Test data for 802.11n_HT20 RLAN Mode

- Test Date : March 07, 2016
- Resolution bandwidth : 1 MHz for Peak and Average Mode for the emissions fall in restricted band,
100 kHz for Peak Mode for the emissions outside restricted band
- Video bandwidth : 1 MHz for Peak Mode, 10 Hz for Average Mode
- Measurement distance : 3 m
- Result : Pass

Frequency (MHz)	Reading (dBμV)	Detector Mode	Ant. Pol. (H/V)	Ant. Factor	Cable Loss	Amp Gain	Total (dBμV/m)	Limits (dBμV/m)	Margin (dB)
5 350.00	52.82	Peak	H	31.30	11.70	42.20	53.62	74.00	20.38
	38.06	Average	H				38.86	54.00	15.14
	51.72	Peak	V				52.52	74.00	21.48
	37.86	Average	V				38.66	54.00	15.34

Tabulated test data for Restricted Band

Remark - “H”: Horizontal, “V”: Vertical

$$\text{Margin (dB)} = \text{Limits (dB}\mu\text{V/m)} - \text{Emission Level (dB}\mu\text{V/m)}$$



Tested by: Jun-Hui, Lee / Senior Engineer

13.6 Test data for 5 725 MHz ~ 5 850 MHz Band

13.6.1 Test data for 802.11a RLAN Mode

- Test Date : March 07, 2016
- Resolution bandwidth : 1 MHz for Peak and Average Mode for the emissions fall in restricted band,
100 kHz for Peak Mode for the emissions outside restricted band
- Video bandwidth : 1 MHz for Peak Mode, 10 Hz for Average Mode
- Measurement distance : 3 m
- Result : Pass

Frequency (MHz)	Reading (dBμV)	Detector Mode	Ant. Pol. (H/V)	Ant. Factor	Cable Loss	Amp Gain	Total (dBμV/m)	Limits (dBμV/m)	Margin (dB)
Low Channel									
5 725.00	69.93	Peak	H	31.90	12.10	42.20	71.73	74.00	2.27
	47.51	Average	H				49.31	54.00	4.69
	65.29	Peak	V				67.09	74.00	6.91
	43.49	Average	V				45.29	54.00	8.71
High Channel									
5 850.00	57.62	Peak	H	32.10	12.20	42.20	59.72	74.00	14.28
	40.34	Average	H				42.44	54.00	11.56
	52.91	Peak	V				55.01	74.00	18.99
	38.50	Average	V				40.60	54.00	13.40

Tabulated test data for Restricted Band

Remark - “H”: Horizontal, “V”: Vertical

Margin (dB) = Limits (dBμV/m) - Emission Level (dBμV/m)



Tested by: Jun-Hui, Lee / Senior Engineer

15.6.2 Test data for 802.11n_HT20 RLAN Mode

- Test Date : March 07, 2016
- Resolution bandwidth : 1 MHz for Peak and Average Mode for the emissions fall in restricted band,
100 kHz for Peak Mode for the emissions outside restricted band
- Video bandwidth : 1 MHz for Peak Mode, 10 Hz for Average Mode
- Measurement distance : 3 m
- Result : Pass

Frequency (MHz)	Reading (dBμV)	Detector Mode	Ant. Pol. (H/V)	Ant. Factor	Cable Loss	Amp Gain	Total (dBμV/m)	Limits (dBμV/m)	Margin (dB)
Low Channel									
5 725.00	70.81	Peak	H	31.90	12.10	42.20	72.61	74.00	1.39
	49.24	Average	H				51.04	54.00	2.96
	66.68	Peak	V				68.48	74.00	5.52
	44.79	Average	V				46.59	54.00	7.41
High Channel									
5 850.00	58.95	Peak	H	32.10	12.20	42.20	61.05	74.00	12.95
	42.65	Average	H				44.75	54.00	9.25
	55.07	Peak	V				57.17	74.00	16.83
	39.47	Average	V				41.57	54.00	12.43

Tabulated test data for Restricted Band

Remark - “H”: Horizontal, “V”: Vertical

$$\text{Margin (dB)} = \text{Limits (dB}\mu\text{V/m)} - \text{Emission Level (dB}\mu\text{V/m)}$$



Tested by: Jun-Hui, Lee / Senior Engineer

14. CONDUCTED EMISSION TEST

14.1 Operating environment

Temperature : (23 ~ 24) °C
 Relative humidity : (46 ~ 49) % R.H.

14.2 Test set-up

The EUT was placed on a wooden table, 0.8 m height above the floor. Power was fed to the EUT through a 50 Ω / 50 μH + 5 Ω Artificial Mains Network (AMN). The ground plane was electrically bonded to the reference ground system and all power lines were filtered from ambient.

14.3 Test equipment used

Model Number	Manufacturer	Description	Serial Number	Last Cal. (Interval)
■ - ESPI	Rohde & Schwarz	Test Receiver	101012	Nov. 02, 2015 (1Y)
□ - ESHS10	Rohde & Schwarz	Test Receiver	834467/007	Apr. 29, 2015 (1Y)
□ - NSLK8128	Schwarzbeck	AMN	8128-216	Apr. 06, 2015 (1Y)
■ - NSLK8126	Schwarzbeck	AMN	8126-404	Apr. 29, 2015 (1Y)
□ - 3825/2	EMCO	AMN	9109-1869	Apr. 29, 2015 (1Y)
■ - 3825/2	EMCO	AMN	9109-1867	Apr. 29, 2015 (1Y)

All test equipment used is calibrated on a regular basis.

14.4 Test data

14.4.1 Test data for 5 150 MHz ~ 5 250 MHz Band

- Test Date : March 08, 2016
- Resolution bandwidth : 9 kHz
- Frequency range : 0.15 MHz ~ 30 MHz
- Tested Line : HOT LINE

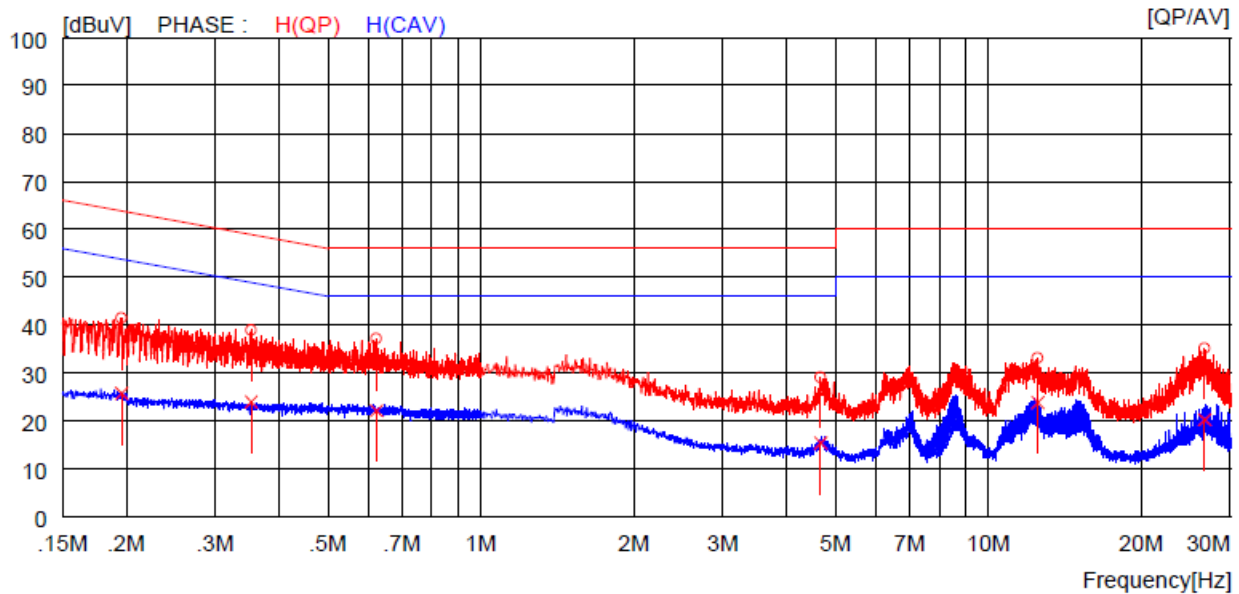

NO	FREQ [MHz]	READING		C.FACTOR		RESULT		LIMIT		MARGIN		PHASE
		QP	AV	QP	AV	QP	AV	QP	AV	QP	AV	
		[dBuV]	[dBuV]	[dB]	[dBuV]	[dBuV]	[dBuV]	[dBuV]	[dBuV]	[dBuV]	[dBuV]	
1	0.19600	31.6	---	---	9.8	41.4	---	63.8	---	22.4	---	H(QP)
2	0.35300	29.0	---	---	9.9	38.9	---	58.9	---	20.0	---	H(QP)
3	0.62300	27.1	---	---	10.0	37.1	---	56.0	---	18.9	---	H(QP)
4	4.67200	19.0	---	---	10.1	29.1	---	56.0	---	26.9	---	H(QP)
5	12.51000	22.6	---	---	10.5	33.1	---	60.0	---	26.9	---	H(QP)
6	26.66000	24.6	---	---	10.5	35.1	---	60.0	---	24.9	---	H(QP)
7	0.19600	---	---	15.9	9.8	---	25.7	---	53.8	---	28.1	H(CAV)
8	0.35300	---	---	14.0	9.9	---	23.9	---	48.9	---	25.0	H(CAV)
9	0.62300	---	---	12.1	10.0	---	22.1	---	46.0	---	23.9	H(CAV)
10	4.67200	---	---	5.2	10.1	---	15.3	---	46.0	---	30.7	H(CAV)
11	12.51000	---	---	13.3	10.5	---	23.8	---	50.0	---	26.2	H(CAV)
12	26.66000	---	---	9.7	10.5	---	20.2	---	50.0	---	29.8	H(CAV)

- Tested Line : NEUTRAL LINE

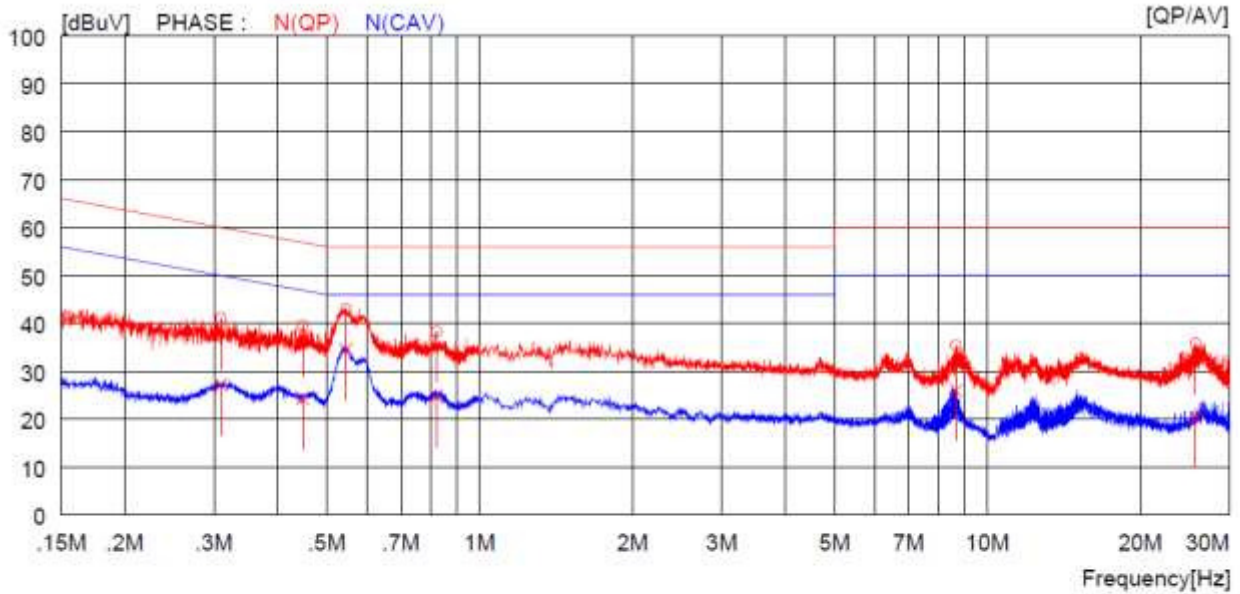

NO	FREQ		READING		C.FACTOR		RESULT		LIMIT		MARGIN	PHASE
	QP	AV	QP	AV	QP	AV	QP	AV	QP	AV		
	[MHz]	[dBuV]	[dBuV]	[dB]	[dBuV]	[dBuV]	[dBuV]	[dBuV]	[dBuV]	[dBuV]	[dBuV]	
1	0.30900	31.1	---	9.9	41.0	---	60.0	---	19.0	---	N(QP)	
2	0.44800	29.6	---	9.9	39.5	---	56.9	---	17.4	---	N(QP)	
3	0.54600	33.0	---	10.0	43.0	---	56.0	---	13.0	---	N(QP)	
4	0.82100	28.2	---	10.0	38.2	---	56.0	---	17.8	---	N(QP)	
5	8.67000	25.1	---	10.3	35.4	---	60.0	---	24.6	---	N(QP)	
6	25.72000	25.3	---	10.5	35.8	---	60.0	---	24.2	---	N(QP)	
7	0.30900	---	17.3	9.9	---	27.2	---	50.0	---	22.8	N(CAV)	
8	0.44800	---	14.4	9.9	---	24.3	---	46.9	---	22.6	N(CAV)	
9	0.54600	---	24.6	10.0	---	34.6	---	46.0	---	11.4	N(CAV)	
10	0.82100	---	14.7	10.0	---	24.7	---	46.0	---	21.3	N(CAV)	
11	8.67000	---	15.7	10.3	---	26.0	---	50.0	---	24.0	N(CAV)	
12	25.72000	---	9.9	10.5	---	20.4	---	50.0	---	29.6	N(CAV)	

Remark: Margin (dB) = Limit – Level (Result)

The emission level in above table is included the transducer factor that means insertion loss (LISN), cable loss and attenuator.

Tested by: Jun-Hui, Lee / Senior Engineer

14.4.2 Test data for 5 250 MHz ~ 5 350 MHz Band

- Test Date : March 08, 2016
- Resolution bandwidth : 9 kHz
- Frequency range : 0.15 MHz ~ 30 MHz
- Tested Line : HOT LINE

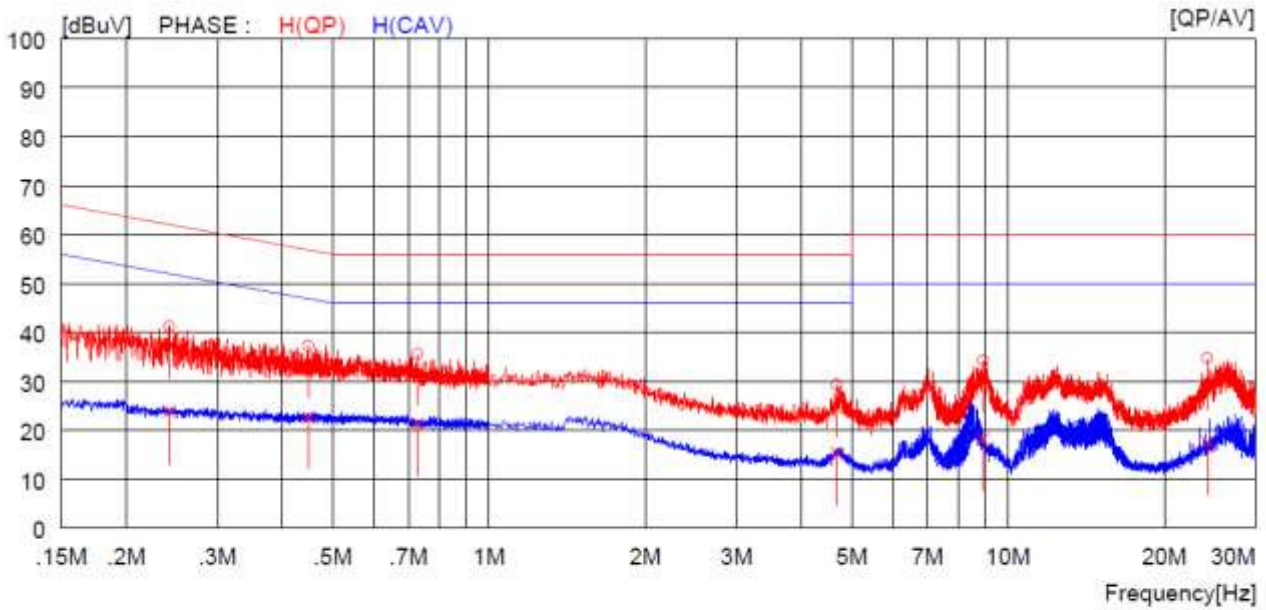

NO	FREQ [MHz]	READING		C.FACTOR [dB]	RESULT		LIMIT	MARGIN	PHASE			
		QP [dBuV]	AV [dBuV]		QP [dBuV]	AV [dBuV]						
1	0.24200	31.3	---	---	9.9	41.2	---	62.0	---	20.8	H(QP)	
2	0.44800	27.3	---	---	9.9	37.2	---	56.9	---	19.7	H(QP)	
3	0.72900	25.6	---	---	10.0	35.6	---	56.0	---	20.4	H(QP)	
4	4.68000	19.2	---	---	10.1	29.3	---	56.0	---	26.7	H(QP)	
5	8.95000	23.9	---	---	10.3	34.2	---	60.0	---	25.8	H(QP)	
6	24.22000	24.2	---	---	10.5	34.7	---	60.0	---	25.3	H(QP)	
7	0.24200	---	13.9	---	9.9	---	23.8	---	52.0	---	28.2	H(CAV)
8	0.44800	---	12.7	---	9.9	---	22.6	---	46.9	---	24.3	H(CAV)
9	0.72900	---	11.3	---	10.0	---	21.3	---	46.0	---	24.7	H(CAV)
10	4.68000	---	5.2	---	10.1	---	15.3	---	46.0	---	30.7	H(CAV)
11	8.95000	---	7.9	---	10.3	---	18.2	---	50.0	---	31.8	H(CAV)
12	24.22000	---	7.1	---	10.5	---	17.6	---	50.0	---	32.4	H(CAV)

-. Tested Line : NEUTRAL LINE

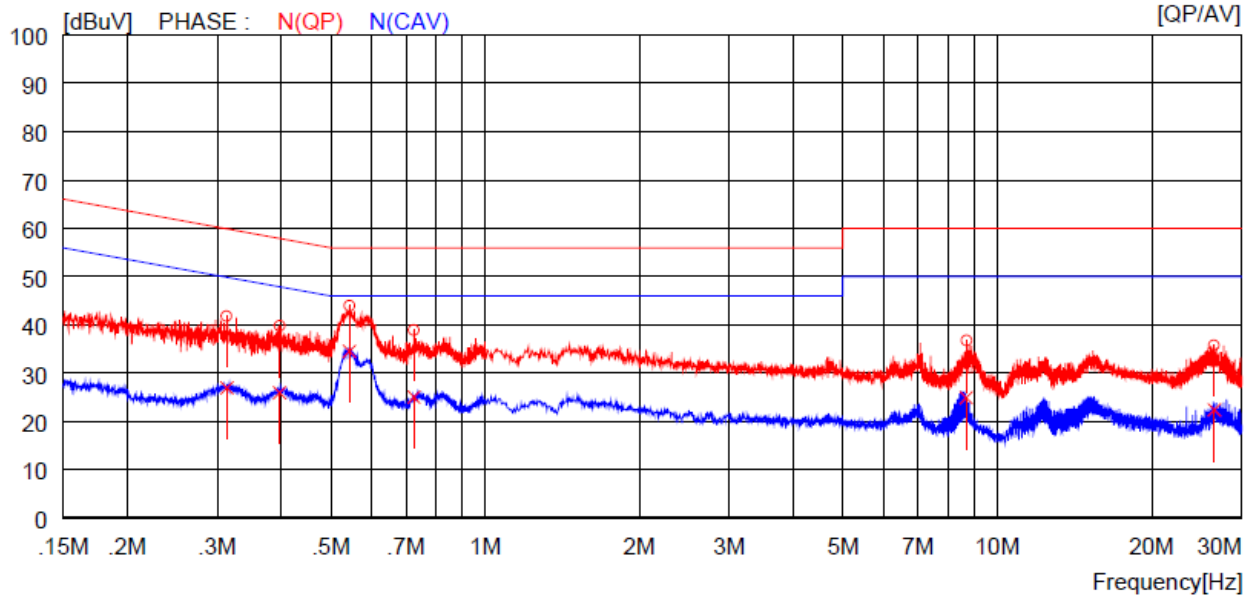

NO	FREQ		READING		C.FACTOR		RESULT		LIMIT		MARGIN	PHASE
	QP	AV	QP	AV	QP	AV	QP	AV	QP	AV		
	[MHz]	[dBuV]	[dBuV]	[dB]	[dBuV]	[dBuV]	[dBuV]	[dBuV]	[dBuV]	[dBuV]	[dBuV]	
1	0.31300	31.9	---	9.9	41.8	---	59.9	---	18.1	---	N(QP)	
2	0.39700	29.9	---	9.9	39.8	---	57.9	---	18.1	---	N(QP)	
3	0.54300	34.0	---	10.0	44.0	---	56.0	---	12.0	---	N(QP)	
4	0.72600	28.9	---	10.0	38.9	---	56.0	---	17.1	---	N(QP)	
5	8.71500	26.4	---	10.3	36.7	---	60.0	---	23.3	---	N(QP)	
6	26.52000	25.3	---	10.5	35.8	---	60.0	---	24.2	---	N(QP)	
7	0.31300	---	17.1	9.9	---	27.0	---	49.9	---	22.9	N(CAV)	
8	0.39700	---	16.1	9.9	---	26.0	---	47.9	---	21.9	N(CAV)	
9	0.54300	---	24.5	10.0	---	34.5	---	46.0	---	11.5	N(CAV)	
10	0.72600	---	15.1	10.0	---	25.1	---	46.0	---	20.9	N(CAV)	
11	8.71500	---	14.6	10.3	---	24.9	---	50.0	---	25.1	N(CAV)	
12	26.52000	---	11.9	10.5	---	22.4	---	50.0	---	27.6	N(CAV)	

Remark: Margin (dB) = Limit – Level (Result)

The emission level in above table is included the transducer factor that means insertion loss (LISN), cable loss and attenuator.

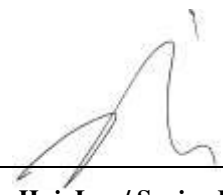

 Tested by: Jun-Hui, Lee / Senior Engineer

14.4.3 Test data for 5 470 MHz ~ 5 725 MHz Band

- Test Date : March 08, 2016
- Resolution bandwidth : 9 kHz
- Frequency range : 0.15 MHz ~ 30 MHz
- Tested Line : HOT LINE

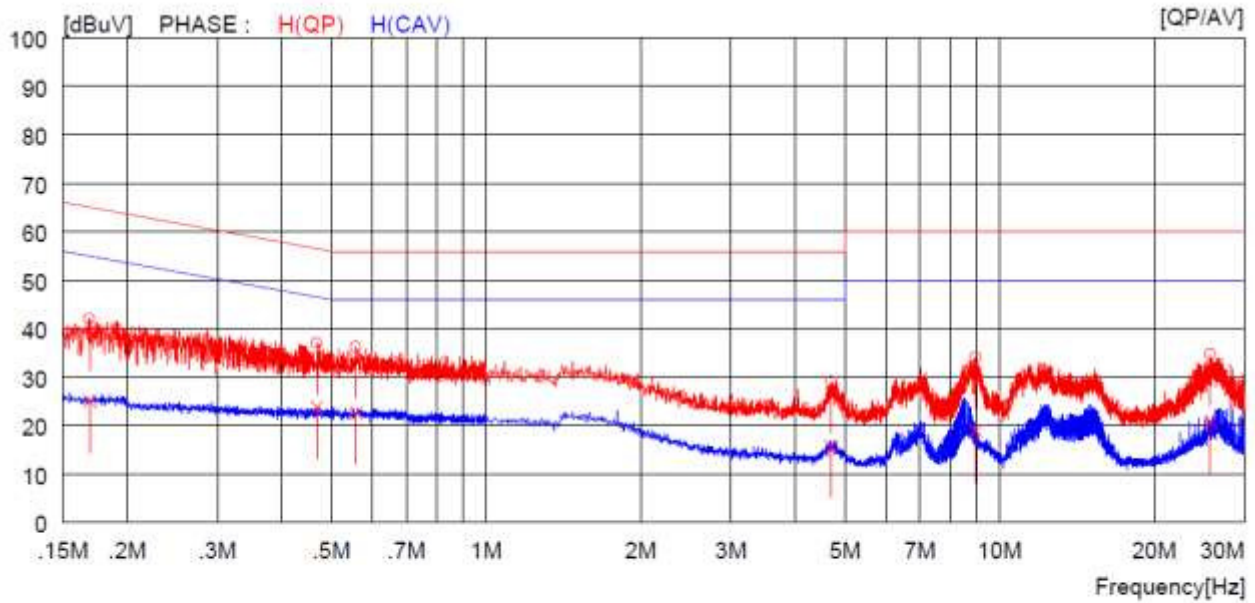

NO	FREQ [MHz]	READING		C.FACTOR [dB]	RESULT		LIMIT		MARGIN		PHASE	
		QP [dBuV]	AV [dBuV]		QP [dBuV]	AV [dBuV]	QP [dBuV]	AV [dBuV]	QP [dBuV]	AV [dBuV]		
1	0.16900	32.2	---	---	9.8	42.0	---	65.0	---	23.0	---	H(QP)
2	0.46800	27.1	---	---	9.9	37.0	---	56.5	---	19.5	---	H(QP)
3	0.55800	26.2	---	---	10.0	36.2	---	56.0	---	19.8	---	H(QP)
4	4.68800	19.0	---	---	10.1	29.1	---	56.0	---	26.9	---	H(QP)
5	8.99500	23.8	---	---	10.3	34.1	---	60.0	---	25.9	---	H(QP)
6	25.72000	24.3	---	---	10.5	34.8	---	60.0	---	25.2	---	H(QP)
7	0.16900	---	15.2	---	9.8	---	25.0	---	55.0	---	30.0	H(CAV)
8	0.46800	---	13.9	---	9.9	---	23.8	---	46.5	---	22.7	H(CAV)
9	0.55800	---	12.7	---	10.0	---	22.7	---	46.0	---	23.3	H(CAV)
10	4.68800	---	5.7	---	10.1	---	15.8	---	46.0	---	30.2	H(CAV)
11	8.99500	---	8.6	---	10.3	---	18.9	---	50.0	---	31.1	H(CAV)
12	25.72000	---	10.3	---	10.5	---	20.8	---	50.0	---	29.2	H(CAV)

-. Tested Line : NEUTRAL LINE

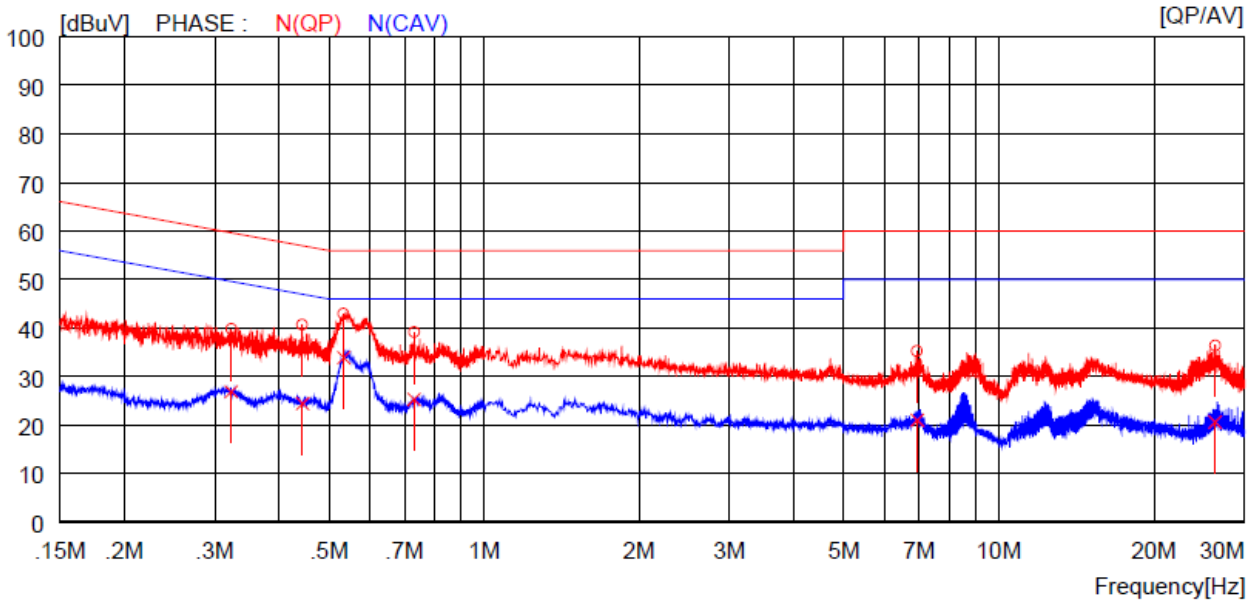

NO	FREQ [MHz]	READING		C.FACTOR		RESULT		LIMIT	MARGIN	PHASE	
		QP	AV	QP	AV	QP	AV				QP
		[dBuV]	[dBuV]	[dB]	[dBuV]	[dBuV]	[dBuV]	[dBuV]	[dBuV]		
1	0.32300	29.9	---	---	9.9	39.8	---	59.6	---	19.8	N(QP)
2	0.44400	30.8	---	---	9.9	40.7	---	57.0	---	16.3	N(QP)
3	0.53400	33.0	---	---	10.0	43.0	---	56.0	---	13.0	N(QP)
4	0.73200	29.1	---	---	10.0	39.1	---	56.0	---	16.9	N(QP)
5	6.94500	25.0	---	---	10.2	35.2	---	60.0	---	24.8	N(QP)
6	26.33000	25.9	---	---	10.5	36.4	---	60.0	---	23.6	N(QP)
7	0.32300	---	---	17.0	9.9	---	---	26.9	---	49.6	N(CAV)
8	0.44400	---	---	14.5	9.9	---	---	24.4	---	47.0	N(CAV)
9	0.53400	---	---	23.9	10.0	---	---	33.9	---	46.0	N(CAV)
10	0.73200	---	---	15.3	10.0	---	---	25.3	---	46.0	N(CAV)
11	6.94500	---	---	10.8	10.2	---	---	21.0	---	50.0	N(CAV)
12	26.33000	---	---	10.1	10.5	---	---	20.6	---	50.0	N(CAV)

Remark: Margin (dB) = Limit – Level (Result)

The emission level in above table is included the transducer factor that means insertion loss (LISN), cable loss and attenuator.

Tested by: Jun-Hui, Lee / Senior Engineer

14.4.4 Test data for 5 725 MHz ~ 5 850 MHz Band

- Test Date : March 08, 2016
- Resolution bandwidth : 9 kHz
- Frequency range : 0.15 MHz ~ 30 MHz
- Tested Line : HOT LINE

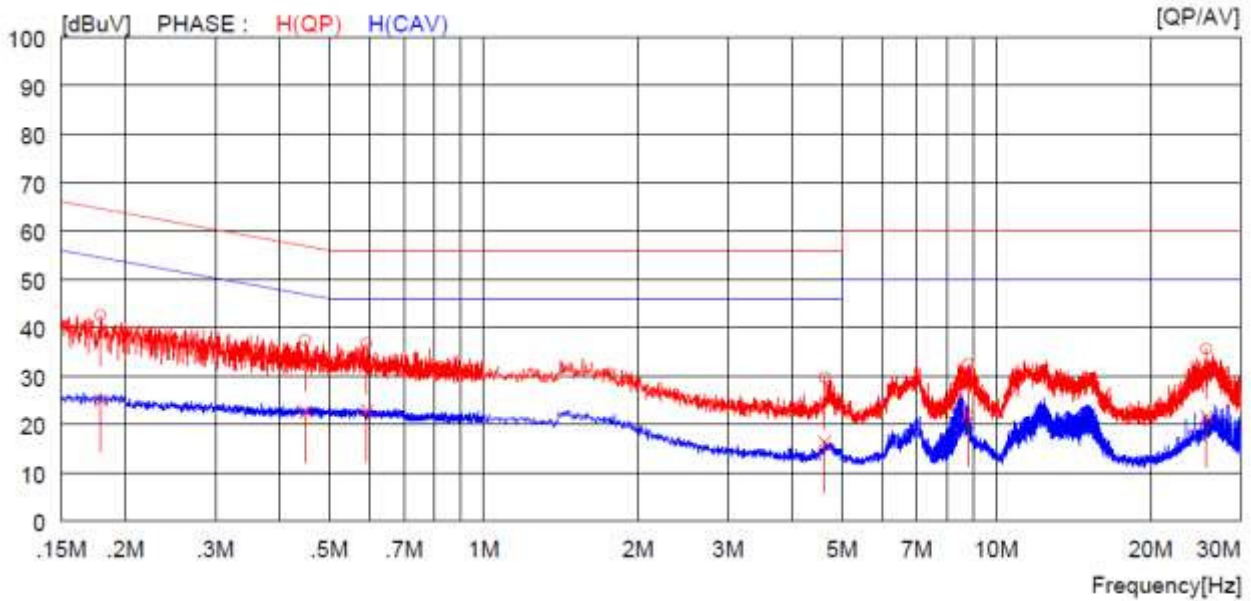

NO	FREQ [MHz]	READING		C.FACTOR [dB]	RESULT		LIMIT	MARGIN	PHASE			
		QP [dBuV]	AV [dBuV]		QP [dBuV]	AV [dBuV]						
1	0.17900	32.8	---	---	9.8	42.6	---	64.5	---	21.9	---	H(QP)
2	0.44900	27.5	---	---	9.9	37.4	---	56.9	---	19.5	---	H(QP)
3	0.59100	26.7	---	---	10.0	36.7	---	56.0	---	19.3	---	H(QP)
4	4.62800	19.6	---	---	10.1	29.7	---	56.0	---	26.3	---	H(QP)
5	8.81000	22.2	---	---	10.3	32.5	---	60.0	---	27.5	---	H(QP)
6	25.71000	25.1	---	---	10.5	35.6	---	60.0	---	24.4	---	H(QP)
7	0.17900	---	---	15.1	9.8	---	24.9	---	54.5	---	29.6	H(CAV)
8	0.44900	---	---	12.7	9.9	---	22.6	---	46.9	---	24.3	H(CAV)
9	0.59100	---	---	12.9	10.0	---	22.9	---	46.0	---	23.1	H(CAV)
10	4.62800	---	---	6.3	10.1	---	16.4	---	46.0	---	29.6	H(CAV)
11	8.81000	---	---	11.7	10.3	---	22.0	---	50.0	---	28.0	H(CAV)
12	25.71000	---	---	11.1	10.5	---	21.6	---	50.0	---	28.4	H(CAV)

-. Tested Line : NEUTRAL LINE

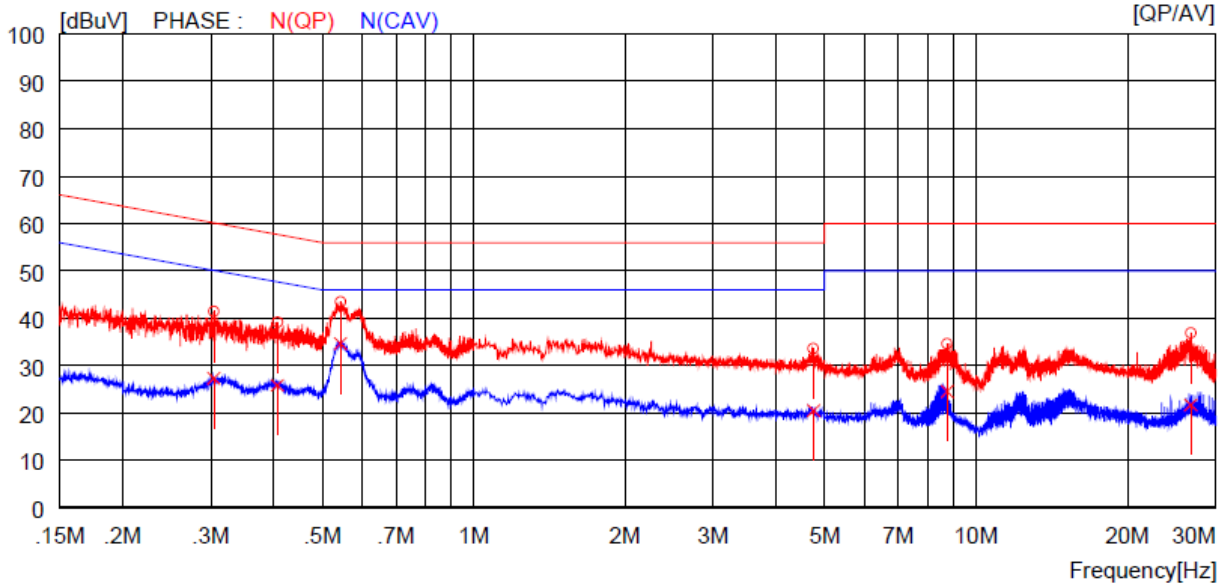

NO	FREQ [MHz]	READING		C.FACTOR		RESULT		LIMIT		MARGIN		PHASE
		QP	AV	QP	AV	QP	AV	QP	AV	QP	AV	
		[dBuV]	[dBuV]	[dB]	[dBuV]	[dBuV]	[dBuV]	[dBuV]	[dBuV]	[dBuV]	[dBuV]	
1	0.30400	31.5	---	---	9.9	41.4	---	60.1	---	18.7	---	N(QP)
2	0.40700	29.3	---	---	9.9	39.2	---	57.7	---	18.5	---	N(QP)
3	0.54300	33.4	---	---	10.0	43.4	---	56.0	---	12.6	---	N(QP)
4	4.74800	23.5	---	---	10.1	33.6	---	56.0	---	22.4	---	N(QP)
5	8.76500	24.3	---	---	10.3	34.6	---	60.0	---	25.4	---	N(QP)
6	26.77000	26.4	---	---	10.5	36.9	---	60.0	---	23.1	---	N(QP)
7	0.30400	---	---	17.4	9.9	---	27.3	---	50.1	---	22.8	N(CAV)
8	0.40700	---	---	16.0	9.9	---	25.9	---	47.7	---	21.8	N(CAV)
9	0.54300	---	---	24.7	10.0	---	34.7	---	46.0	---	11.3	N(CAV)
10	4.74800	---	---	10.4	10.1	---	20.5	---	46.0	---	25.5	N(CAV)
11	8.76500	---	---	14.3	10.3	---	24.6	---	50.0	---	25.4	N(CAV)
12	26.77000	---	---	11.2	10.5	---	21.7	---	50.0	---	28.3	N(CAV)

Remark: Margin (dB) = Limit – Level (Result)

The emission level in above table is included the transducer factor that means insertion loss (LISN), cable loss and attenuator.

Tested by: Jun-Hui, Lee / Senior Engineer

15 DYNAMIC FREQUENCY SELECTION (DFS)

15.1 Operating environment

Temperature : 22 °C
 Relative humidity : 55 % R.H.

15.2 Test set-ups

The FCC 06-96 and RSS-210 A9.3 describes a conducted test setup. A conducted test setup was user this testing. Figure 1 shows the typical test setup. Each one channel selected between 5 250 MHz and 5 350 MHz, 5 470 MHz and 5 725 MHz is chosen for the testing.

Figure 1. Setup for Client with injection at the Master

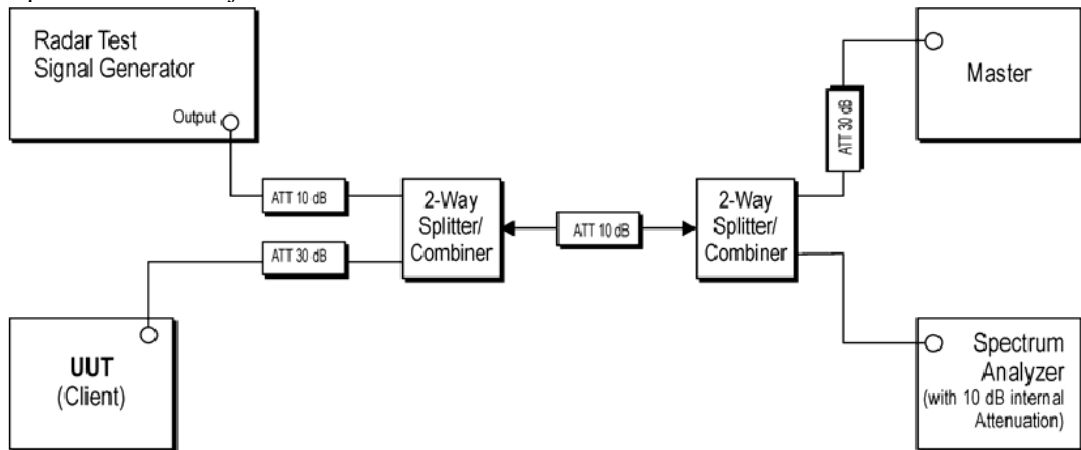

15.3 DFS Test Signals

Table 5 – Short Pulse Radar Test Waveforms

Radar Type	Pulse Width (μsec)	PRI (μsec)	Number of Pulses	Minimum Percentage of Successful Detection	Minimum Number of Trials
0	1	1428	18	See Note 1	See Note 1
1	1	Test A: 15 unique PRI values randomly selected from the list of 23 PRI values in Table 5a	Roundup $\left\{ \begin{matrix} \left(\frac{1}{360} \right) \cdot \\ \left(\frac{19 \cdot 10^6}{PRI_{\mu sec}} \right) \end{matrix} \right\}$	60%	30
		Test B: 15 unique PRI values randomly selected within the range of 518-3066 μ sec, with a minimum increment of 1 μ sec, excluding PRI values selected in Test A			
2	1-5	150-230	23-29	60%	30
3	6-10	200-500	16-18	60%	30
4	11-20	200-500	12-16	60%	30
Aggregate (Radar Types 1-4)				80%	120

Table 6 – Long Pulse Radar Test Waveform

Radar Type	Pulse Width (μsec)	Chirp Width (MHz)	PRI (μsec)	Number of Pulses per Burst	Number of Bursts	Minimum Percentage of Successful Detection	Minimum Number of Trials
5	50-100	5-20	1000-2000	1-3	8-20	80%	30

15.4 Technical Requirement Specification

Table 1: Applicability of DFS Requirements Prior to Use of a Channel

Requirement	Operational Mode		
	Master	Client (without DFS)	Client (with DFS)
<i>Non-Occupancy Period</i>	Yes	Not required	Yes
<i>DFS Detection Threshold</i>	Yes	Not required	Yes
<i>Channel Availability Check Time</i>	Yes	Not required	Not required
<i>Uniform Spreading</i>	Yes	Not required	Not required
<i>U-NII Detection Bandwidth</i>	Yes	Not required	Yes

Table 2: Applicability of DFS requirements during normal operation

Requirement	Operational Mode		
	Master	Client (without DFS)	Client (with DFS)
<i>DFS Detection Threshold</i>	Yes	Not required	Yes
<i>Channel Closing Transmission Time</i>	Yes	Yes	Yes
<i>Channel Move Time</i>	Yes	Yes	Yes
<i>U-NII Detection Bandwidth</i>	Yes	Not required	Yes

15.5 Test equipment used

Model Number	Manufacturer	Description	Serial Number	Last Cal. (Interval)
■ - FSV40	Rohde & Schwarz	Signal Analyzer	101009	Jul. 30, 2014 (1Y)
■ - D-05180-2	RLC Electronis Inc.	Combiner	0813	Apr. 29, 2014 (1Y)
■ - 11636B	Hewlett Packard	Combiner	12268	Nov. 08, 2014 (1Y)
■ - SMJ100A	R/S	Signal Generator	101038	Nov. 08, 2014 (1Y)
■ - DRP-305DN	DIGITAL Elec.	DC Power supply	4030195	Sep. 03, 2014 (1Y)
■ AIR-AP1252AG-K-K9	CISCO	AP	FGL1439Z0KE	N/A

All test equipment used is calibrated on a regular basis.

15.6 Test data for 5 250 MHz ~ 5 350 MHz Band

-. Test Date : March 15, 2015

Frequency (MHz)	Channel move time(s)		Channel closing transmission time(ms)	
	Measured	Limit	Measured	Limit
5 300	0.128	10	0	60

15.6.1 Plot of Radar waveform type1

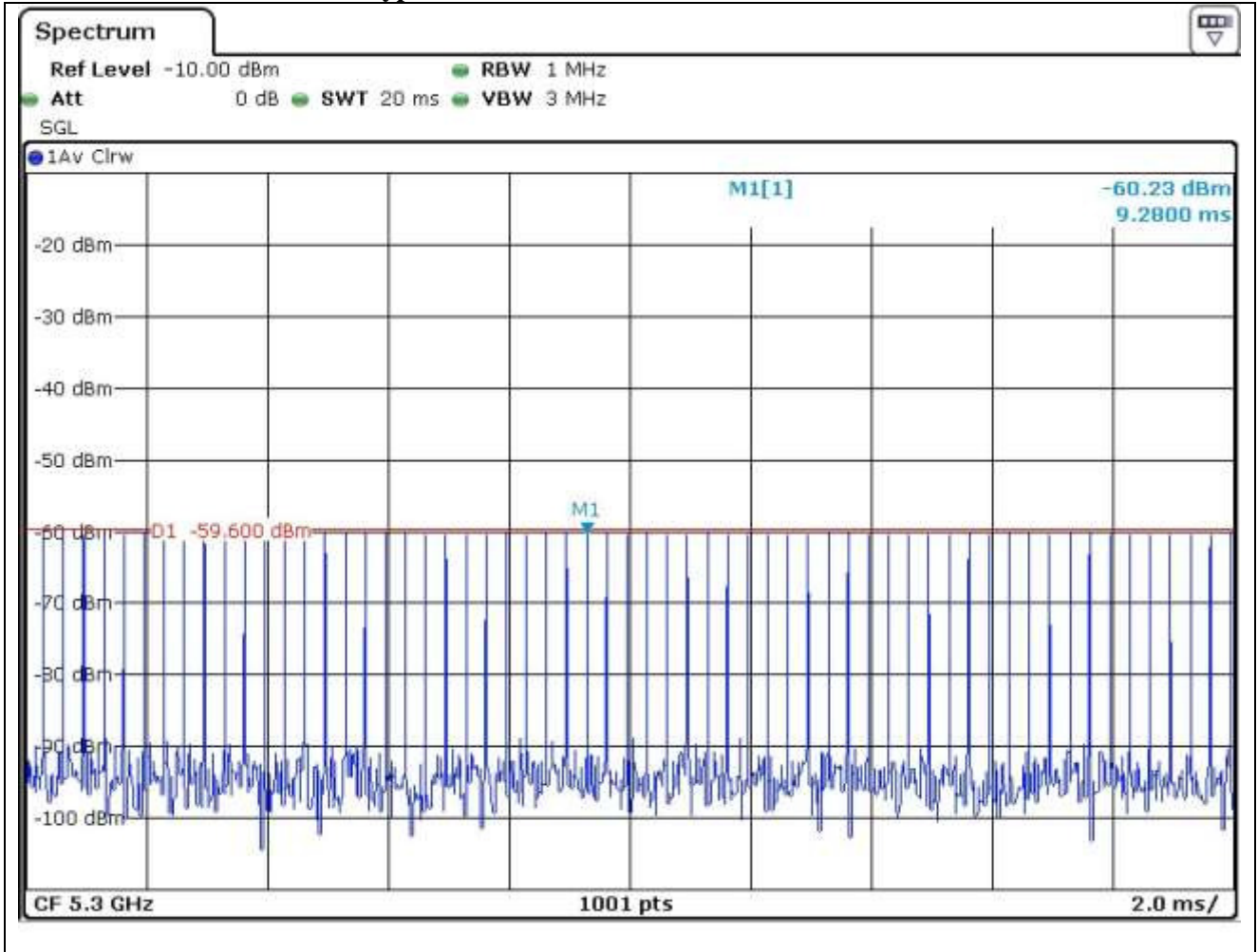

Note: The calibrated conducted DFS detection threshold level is set to -59.5 dBm (-62+1+0.15=-60.85)

15.6.2 No traffic signal(master signal)

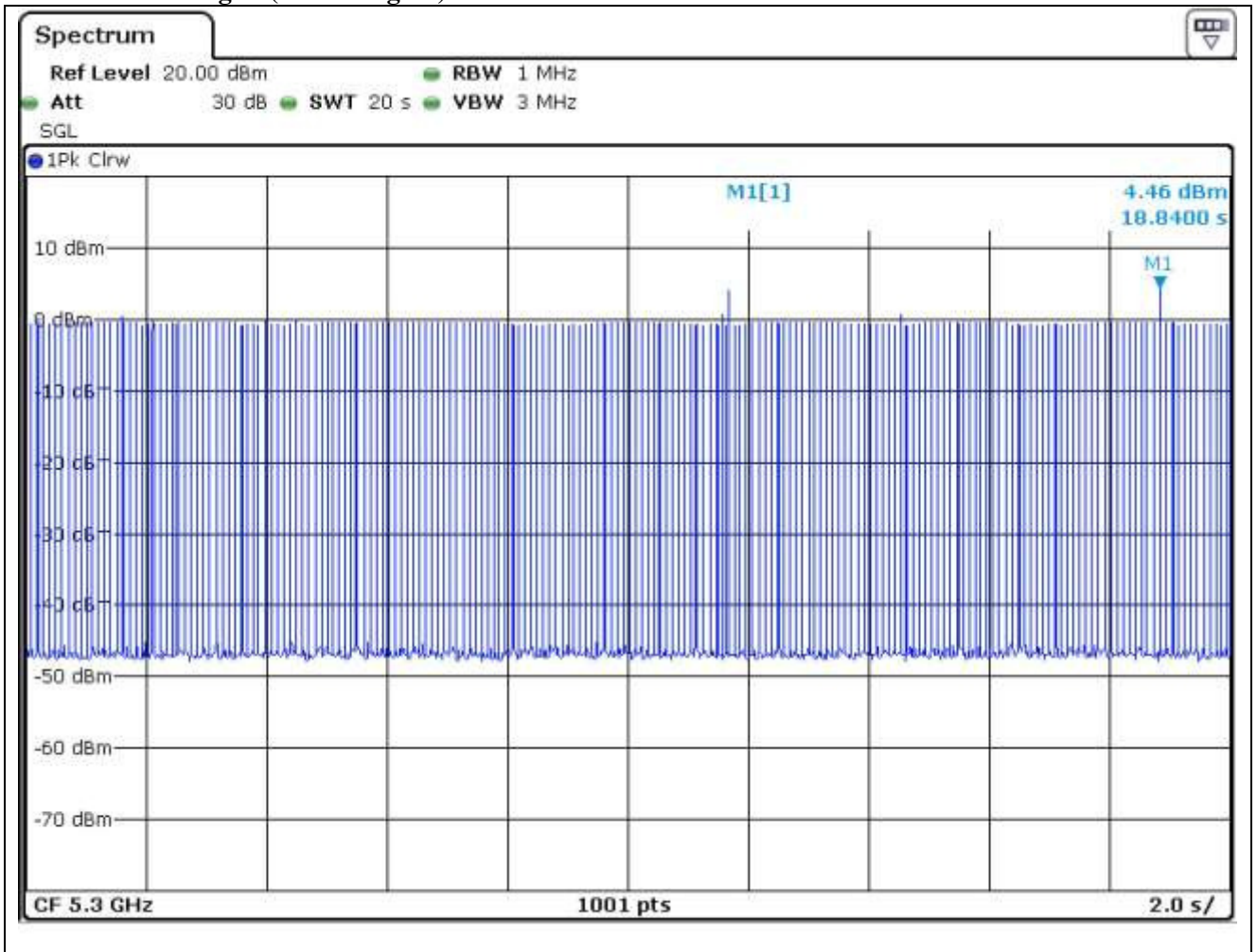

15.6.3 Client(EUT) Data Traiifc Signal

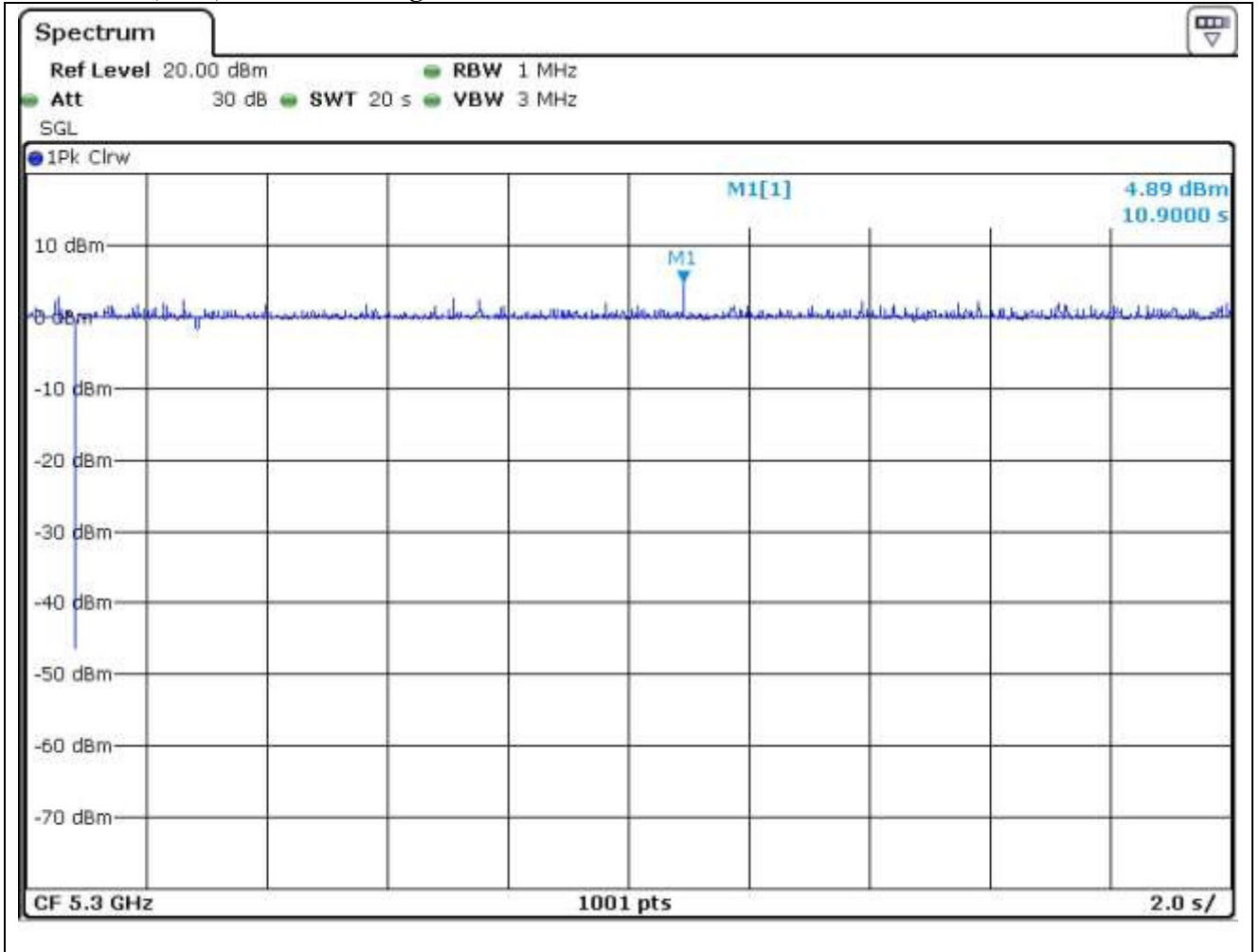

15.6.4 Channel move and Channel Closing transmission time

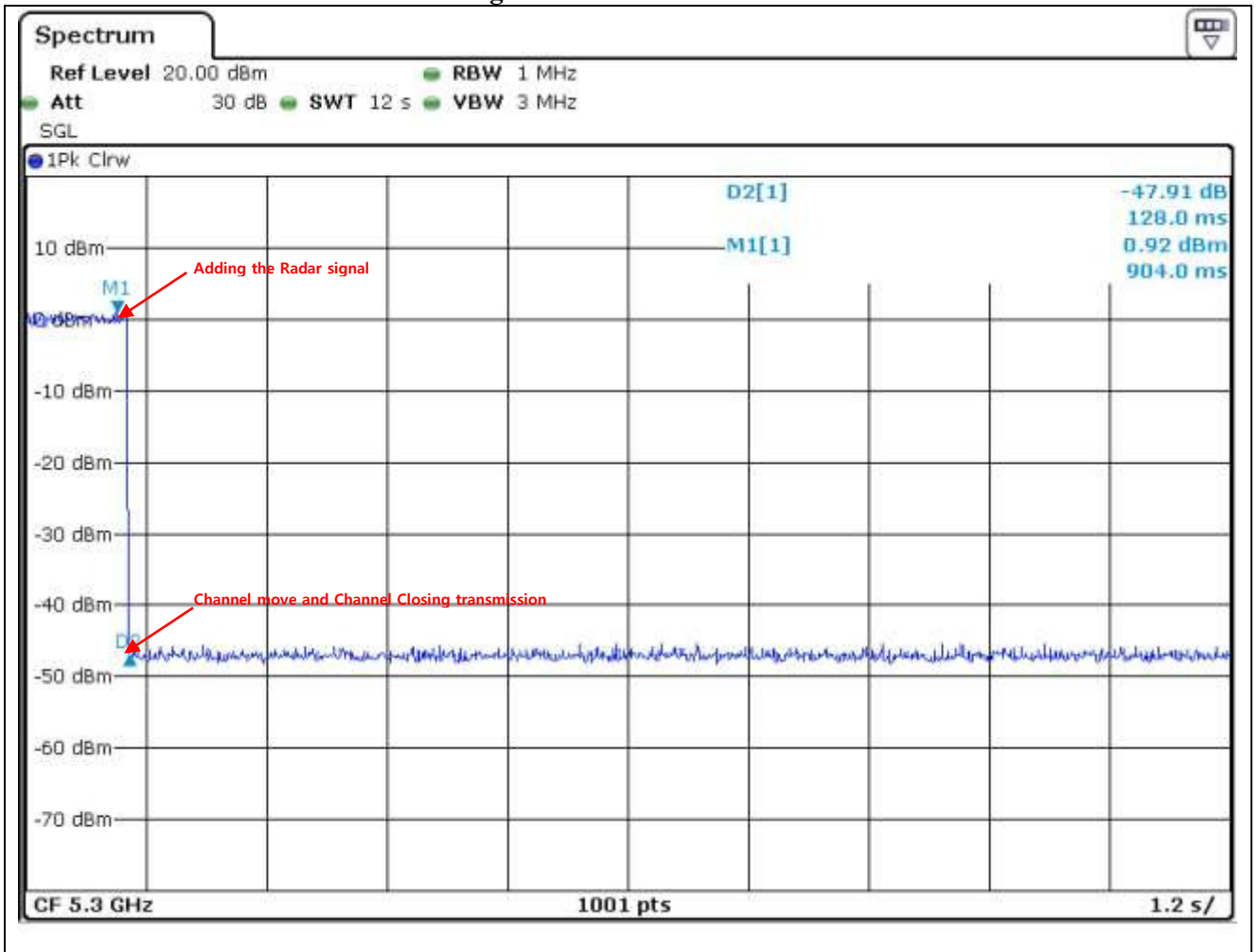

15.7 Test data for 5 470 MHz ~ 5 725 MHz Band

-. Test Date : March 11, 2015

Frequency (MHz)	Channel move time(s)		Channel closing transmission time(ms)	
	Measured	Limit	Measured	Limit
5 600	0.176	10	0	60

15.7.1 Plot of Radar waveform type1

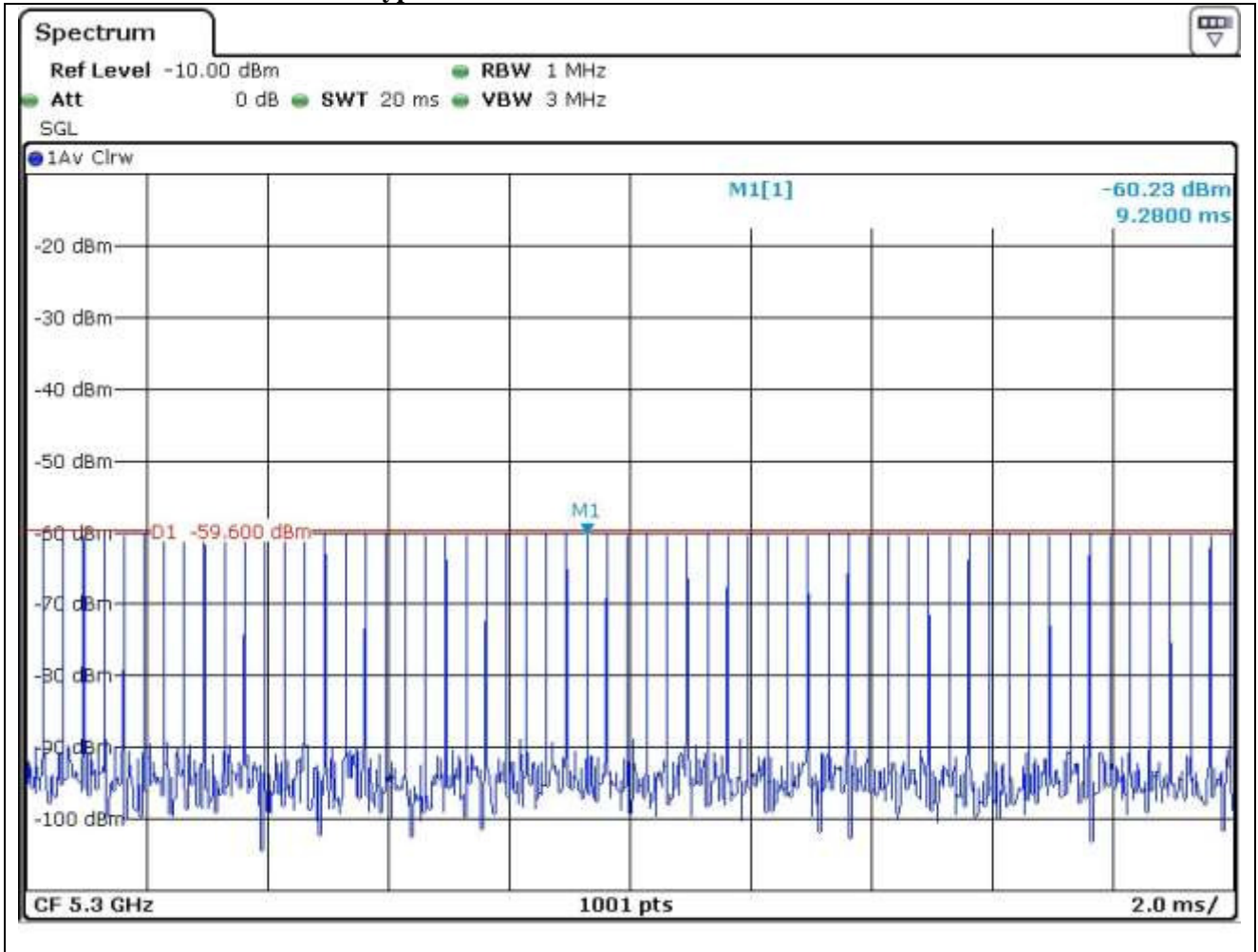

Note: The calibrated conducted DFS detection threshold level is set to -59.5 dBm $(-62+1+(-2.42))=-63.42$

15.7.2 No traffic signal(master signal)

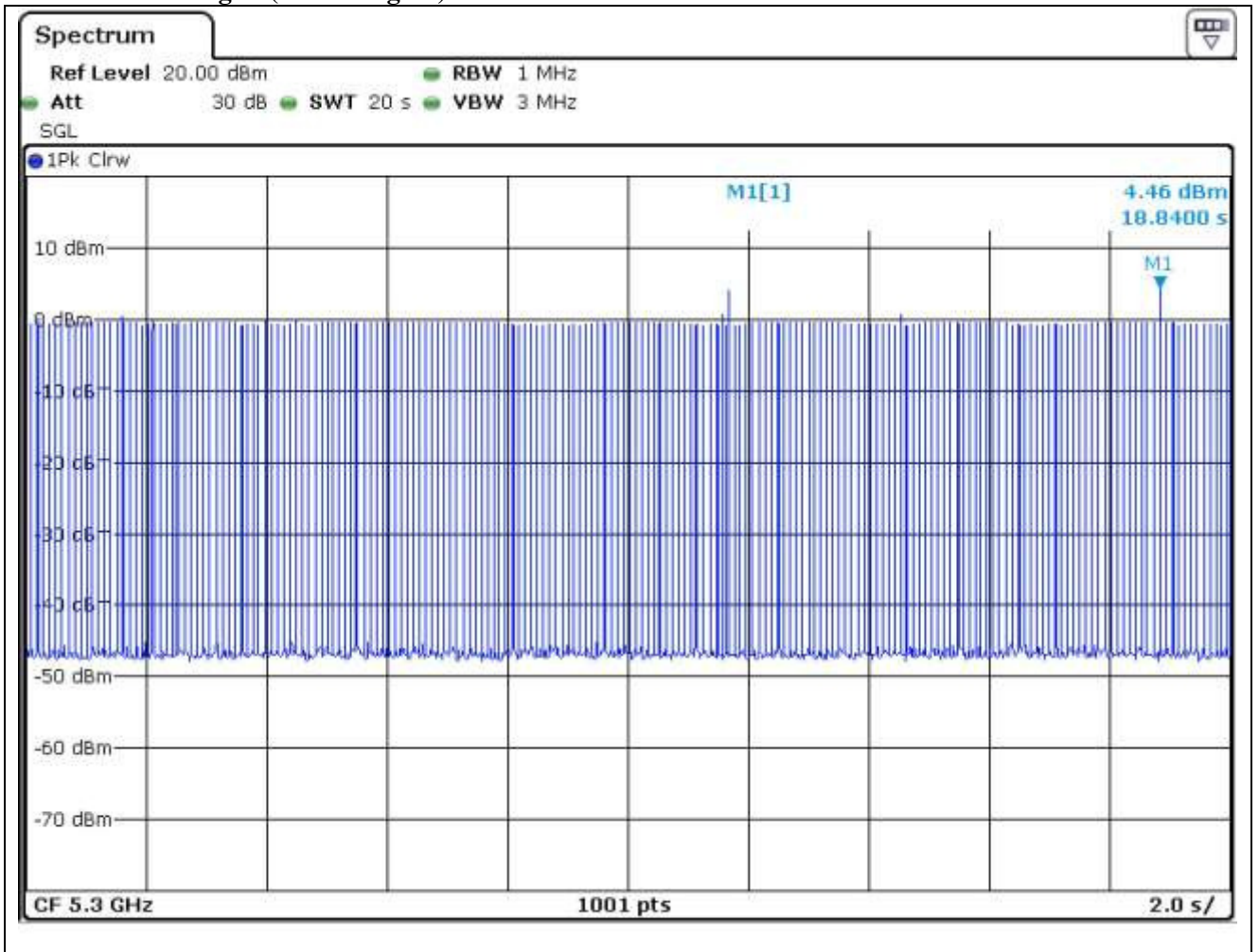

15.7.3 Client(EUT) Data Traiifc Signal

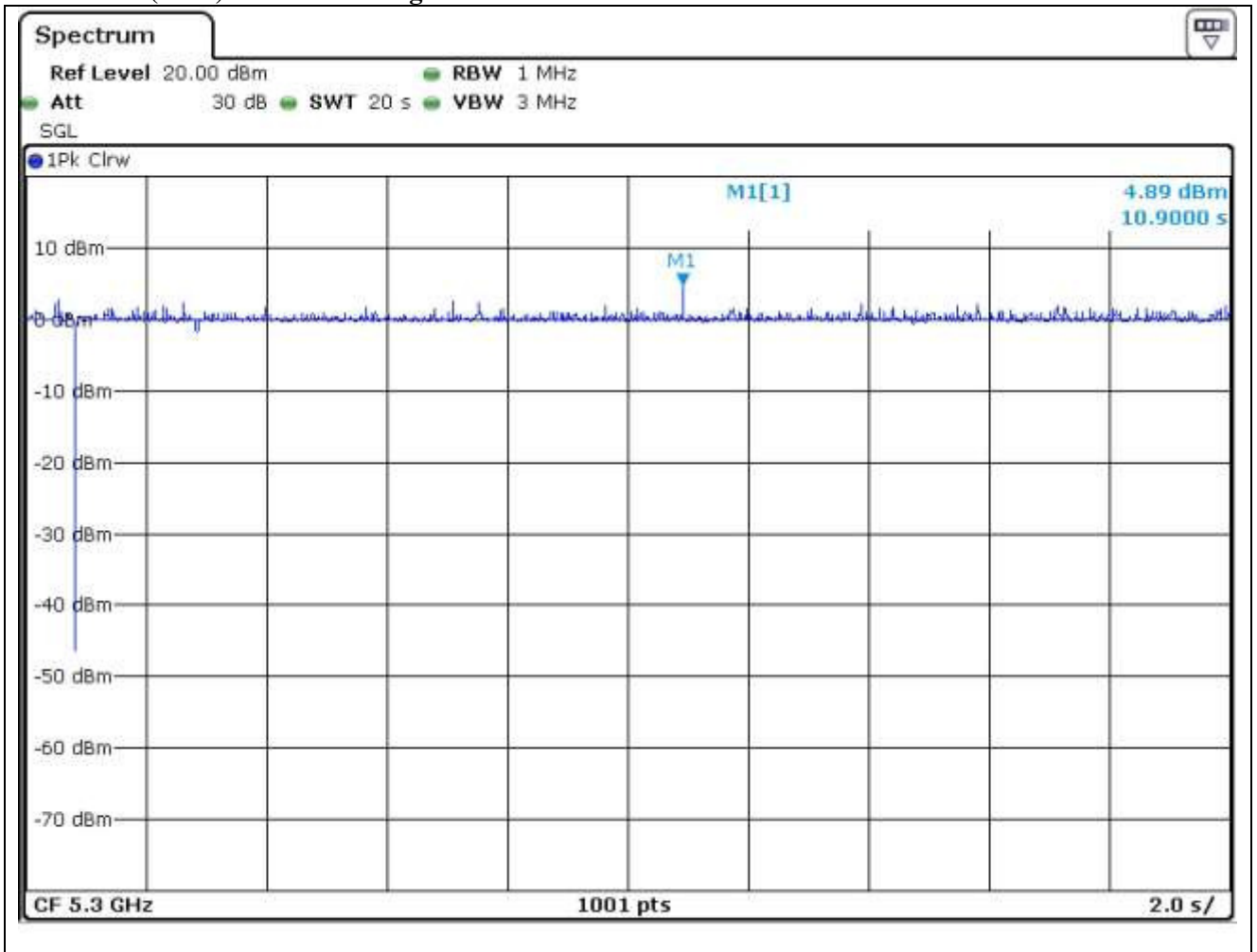

15.7.4 Channel move and Channel Closing transmission time

