







**TEST REPORT**  
 No.: 2-20795542c/11

According to:  
**FCC Regulations**  
 FCC Part 15B  
 &  
**IC Regulations**  
 RSS-Gen, Issue 2  
 RSS-132, Issue 2  
 RSS-133, Issue 5

for

Cinterion Wireless Modules GmbH

Quad-Band GSM/GPRS Module BGS2-W  
 FCC-ID: QIPBGS2  
 IC: 7830A-BGS2

Laboratory Accreditation and Listings			
 D-PL-12047-01-01	 MRA US-EU 0003	 Industry Canada Reg. No.: 3462D-1 3462D-2	 Reg. No.: R-2665, R-2666 C-2914, T-1967 G-301
 LAB CODE 20011130-00			
accredited according to DIN EN ISO/IEC 17025			
<p><b>CETECOM GmbH</b>            Laboratory Radio Communications &amp; Electromagnetic Compatibility            Im Teelbruch 116 • 45219 Essen • Germany            Registered in Essen, Germany, Reg. No.: HRB Essen 8984            Tel.: + 49 (0) 20 54 / 95 19-954 • Fax: + 49 (0) 20 54 / 95 19-964            E-mail: info@cetecom.com • Internet: www.cetecom.com</p>			

## Table of contents

<b>1. SUMMARY OF TEST RESULTS.....</b>	<b>3</b>
1.1. TESTS OVERVIEW FCC Part 15 and Kanada IC Standards (RSS-Gen) .....	3
<b>2. ADMINISTRATIVE DATA .....</b>	<b>4</b>
2.1. Identification of the testing laboratory .....	4
2.2. Test location .....	4
2.3. Organizational items .....	4
2.4. Applicant’s details .....	4
2.5. Manufacturer’s details .....	4
<b>3. EQUIPMENT UNDER TEST (EUT).....</b>	<b>5</b>
3.1. Additional declaration and description of main EUT .....	5
3.2. Configuration of cables used for testing .....	5
3.3. EUT: Type, S/N etc. and short descriptions used in this test report .....	6
3.4. Auxiliary Equipment (AE): Type, S/N etc. and short descriptions.....	6
3.5. EUT set-ups .....	7
3.6. EUT operating modes .....	7
3.7. Configuration of cables used for testing .....	7
3.8. Parameter Settings on mobile phone and base station CMU200 .....	8
<b>4. MEASUREMENTS .....</b>	<b>9</b>
4.1. Conducted emissions on antenna port (RX-Mode).....	9
4.2. Conducted emissions on antenna port, §15.111.....	10
4.3. Conducted emissions on antenna port, Canada requirements, RSS-132, Issue 2, §4.6.....	10
4.4. Conducted emissions on antenna port, Canada requirements, RSS-133, Issue 3, §6.7(b).....	10
4.5. Conducted emissions on AC-Power lines.....	11
4.6. Radiated emissions, 30 MHz - 1 GHz, §15.109 class B, RSS132, RSS133, RSS-gen .....	13
4.7. Radiated emissions, above 1GHz, §15.109 class B, RSS132, RSS133, RSS-gen .....	15
<b>5. MEASUREMENT UNCERTAINTIES.....</b>	<b>18</b>
<b>6. INSTRUMENTS AND ANCILLARY.....</b>	<b>19</b>
6.1. Used equipment “CTC” .....	19

## Table of annex

	<b>Total pages</b>
SEPARATE DOCUMENT 2_20795542C_10_A1.PDF: DIAGRAMS OF TESTING	24
SEPARATE DOCUMENT 2_20795542C_10_A2.PDF: PHOTOS OF TEST SET-UP	3

# 1. Summary of test results

The presented GSM 850/900/1800/1900 Module can be build inside host applications and extends their capability by wireless GSM technology. Data transmissions or voice applications are possible field applications.

In order to verify the compliance with applicable rules, a representative configuration consisting of representative auxiliary equipment was chosen. Embedded in this configuration, the GSM Module can be tested. Pls. refer to set-up description and photos for more details.

Following tests have been performed to show compliance with applicable FCC Part 15B and IC-regulations RSS-Gen., RSS-132 and RSS-133.

The test results apply exclusively to the test samples as presented in chapter 3.1. The CETECOM GmbH does not assume responsibility for any conclusions and generalizations taken in conjunction with other specimens or samples of the type of the item presented to tests.

## 1.1. TESTS OVERVIEW FCC Part 15B and Kanada IC Standards (RSS-Gen)

TEST CASES	PORT	REFERENCES & LIMITS			EUT set-up	EUT operating mode	Result
		FCC Standard	RSS Section	TEST LIMIT			
RX Mode							
AC-Power Lines Conducted Emissions	AC-Power lines	§15.107	RSS-Gen, Issue 2: Chapter 7.2.2	FCC §15.107 class B limits §15.207 limits  IC: Table 2, Chapter 7.2.2	3	1+2	Passed
RECEIVER Radiated emissions	Cabinet + Interconnecting cables (radiated)	§15.109 §15.33 §15.35	RSS-132, Issue 2: 4.6 RSS-Gen, Issue 2: 6(a)  RSS-133, Issue 5: 6.6	FCC 15.109 class B limits  IC-limits: Table 1, Chapter 6	1	1+2	Passed
RECEIVER Conducted emissions	Antenna terminal (conducted)	§2.1051 §15.111(a)	RSS-Gen: 6(b) RSS-132, Issue 2: 4.6 RSS-133, Issue 5: 6.6	FCC: < 2nW IC: < 2 nW/4kHz (30<f<1000MHz) < 5nW/4kHz (f> 1GHz)	2	1+2	Passed

Remark:

See separate test report 2\_20795542b/11 for measurements according FCC Part 22/24 (IC RSS-132/133)

### ATTESTATION:

I declare that all measurements were performed by me or under my supervision and that all measurements have been performed and are correct to my best knowledge and belief to Industry Canada standards. All requirements as shown in above table are met in accordance with enumerated standards.

  
.....  
Dipl.-Ing. W. Richter  
Responsible for test section

  
GmbH  
Im Teelbruch 116  
45219 Essen  
Tel.: +49 (0) 20 54 7 95 19 - 0  
Fax: +49 (0) 20 54 7 95 19 - 097

  
.....  
Dipl.-Ing. C. Lorenz  
Responsible for test report

## 2. Administrative Data

### 2.1. Identification of the testing laboratory

Company name:	CETECOM GmbH
Address:	Im Teelbruch 116 45219 Essen - Kettwig Germany
Laboratory accreditations/Listings:	DAR-Registration No. DAT-P176/94-02 MRA US-EU 0003 IC-Registration No. 3462D-1, 3462D-2 VCCI Registration No. R-2665,R-2666,C-2914,T-339
Responsible for testing laboratory:	Dipl.-Ing. W. Richter
Deputies:	Dipl.-Ing. J. Schmitt

### 2.2. Test location

#### 2.2.1. Test laboratory "CTC"

Company name:	see chapter 2.1. Identification of the testing laboratory
---------------	---

### 2.3. Organizational items

Order No.:	20795542
Responsible for test report and project leader:	Dipl.-Ing. C. Lorenz
Receipt of EUT:	2011-02-01
Date(s) of test:	2011-02-01 - 1
Date of report:	2011-03-01
-----	
Version of template:	09.06 _All.Dotm

### 2.4. Applicant's details

Applicant's name:	Cinterion Wireless Modules GmbH
Address:	Siemensdamm 50 13629 Berlin Germany
Contact person:	Mr. Stefan Ludwig

### 2.5. Manufacturer's details

Manufacturer's name:	please see Applicant's details
Address:	please see Applicant's details

### 3. Equipment under test (EUT)

#### 3.1. Additional declaration and description of main EUT

Main function	GSM/GPRS Quad-Band Module		
Type	BGS2-W		
GSM Frequency range (USA/Canada bands)	GSM 850: 824 – 849MHz (Uplink), 869-894MHz (Downlink) GSM1900: 1850-1910MHz (Uplink), 1930-1990MHz (Downlink)		
Type of modulation	GMSK		
Number of channels (USA/Canada bands)	GSM 850: 128 – 251, 125 channels GSM1900: 512 – 810, 300 channels		
EMISSION DESIGNATOR(S)	245KGXW		
Antenna Type: External magnet mount antenna for vehicular use	<input type="checkbox"/> Integrated <input type="checkbox"/> External, no RF- connector <input checked="" type="checkbox"/> External, separate RF-connector	Frequency range: GSM 850: 824 – 894 MHz GSM 1900: 1850-1990 MHz	
Antenna Gain	<input checked="" type="checkbox"/> radiated: Max. 2 dBi gain at GSM1900		
MAX PEAK Output Power: Radiated ERP	GSM850	29,01 dBm (Burst PK)	
Radiated EIRP	GSM1900	27,60 dBm (Burst PK)	
MAX PEAK Output Power: Conducted	GSM 850	32,40 dBm (PK)	
Conducted	GSM1900	29,89 dBm (PK)	
FCC-ID	QIPBGS2		
IC	7380A-BGS2		
Installed option	<input checked="" type="checkbox"/> GSM900 and GSM1800 Bands		
Special EMI components	--		
Power supply	Internally supplied and controlled by the DSB75 Board for tests: $V_{MIN}=3.3V$ to $V_{MAX}=4.5V$ DSB75 Box was DC supplied with 9V external power supply		
EUT sample type	<input type="checkbox"/> Production	<input checked="" type="checkbox"/> Pre-Production	<input type="checkbox"/> Engineering

#### 3.2. Configuration of cables used for testing

Cable number	Item	Type	S/N serial number	HW hardware status	Cable length
Cable 1	RS232	unshielded	CTC	--	1.8m
Cable 2	USB cable	shielded	CTC	--	1.5m

### 3.3. EUT: Type, S/N etc. and short descriptions used in this test report

Short description*)	EUT	Type	S/N serial number	HW hardware status	SW software status
EUT A	Quad-Band GSM/GPRS Module	BGS2-W	IMEI: 004401 08 048446 8	B2.1	00.960
EUT B	Magnetic Mount antenna	MAR-C3G-2F	CTC#1	2dBi Gain	--
EUT C	Handset Votronic	For M20T, MC35T, TC35T, DSB35	401795321130 4	HH-SI- 30.3/V1.1/0	--
EUT D	Adapter Board for BGS2-W	Ven_60/80_0035	#1	--	--
EUT E	DSB Board + Adapter BG2_PH8_Ada_0207	DSB75	0411090 ICM-100012- 03	B1.1	--
EUT F	Quad-Band GSM/GPRS Module	BGS2-W	IMEI: 004401 08 048449 2	B2.1	00.960

\*) EUT short description is used to simplify the identification of the EUT in this test report.

### 3.4. Auxiliary Equipment (AE): Type, S/N etc. and short descriptions

AE short description *)	Auxiliary Equipment	Type	S/N serial number	HW hardware status	SW software status
AE 1	Notebook	Dell D610D	CTC PC3	--	Windows XP + Terminal Program
AE 2	AC/DC Adapter	FW7238/09	1401	Input: 100V – 240 V AC/50- 60Hz/180mA  Output: 9V DC/800mA	--

\*) AE short description is used to simplify the identification of the auxiliary equipment in this test report.

### 3.5.EUT set-ups

EUT set-up no. *)	Combination of EUT and AE	Remarks
Set. 1	EUT A + EUT B + EUT C + EUT D + EUT E + AE1	AT-commands set the device into operating mode conditions with help of AE1, AE1 connected during tests after successful connection/op-mode establishment but switched off.  Used for radiated measurements
Set. 2	EUT F + EUT B + EUT C + EUT D + EUT E + AE1	AT-commands set the device into operating mode conditions with help of AE1, AE1 connected during tests after successful connection/op-mode establishment but switched off.  Used for conducted RF measurements
Set. 3	EUT A + EUT B + EUT C + EUT D + EUT E + AE1 + AE2	AT-commands set the device into operating mode conditions with help of AE1, AE1 connected during tests after successful connection/op-mode establishment but switched off.  Used for conducted AC mains measurements

\*) EUT set-up no. is used to simplify the identification of the EUT set-up in this test report.

### 3.6. EUT operating modes

EUT operating mode no. *)	Description of operating modes	Additional information
op. 1	GSM 850 Idle mode BCCH 182	The mobile station is synchronized to the Broadcast Control Channel (BCCH) and listening to the Common Control Channel (CCCH). Periodic location update is disabled.
op. 2	GSM 1900 Idle mode BCCH 651	The mobile station is synchronized to the Broadcast Control Channel (BCCH) and listening to the Common Control Channel (CCCH). Periodic location update is disabled.

\*) EUT operating mode no. is used to simplify the test report.

### 3.7. Configuration of cables used for testing

Cable number	Item	Type	S/N serial number	HW hardware status	Cable length
Cable 3	RS232	unshielded	CTC	--	1.8m
Cable 4	USB cable	shielded	CTC	--	1.5m

### 3.8. Parameter Settings on mobile phone and base station CMU200

Following settings apply to the MS during the measurements in GSM/(E)GPRS-Mode only:

Parameter	Traffic Mode	Idle Mode
Traffic Channels mobile station (EUT)	GSM 850 TCH <sub>MS</sub> = 128/ 192 /251 GSM 1900 TCH <sub>MS</sub> = 512 / 681 / 810	--
maximum power level (PCL)	GSM 850: PCL = 5 (2 Watt) GSM 1900: PCL = 0 (1 Watt)	--
Modulation	GSM: GMSK-Modulation Scheme EDGE: 8-PSK Modulation Scheme	--
DTX	off	--
Bitstream	PRBS 2E9-1 (pseudo-random-sequence) – CCITT 0.153	
Timeslot	3	
Hopping	off	
Timeslot (slot mode)	GSM-Mode: single GPRS-Mode: maximum allowed uplink slots no. according MS class	
MS slot class	Class 10	
Maximum data transmission rate, single time slot	GSM: 17,6 kBit/s Slot EDGE: 59,2 kBit/s Slot	
Speech transcoding (Traffic Mode)	Full rate Version 1	
Mode	BCCH and TCH	
BCCH – base station (CMU,CMD)		GSM 850: 182 GSM 1900: 651
TCH – base station (CMD, CMU)	auto	
Power level TCH – base station (used timeslot level)	- 70 dBm	
Power level BCCH – base station (control channel level)	- 80 dBm	
External attenuation RF/AF-Input/Output	Accord. calibration prior to measurements	
Mobile Country Code	310	310
BS_AG_BLKS_RES		0
Paging reorganisation		Off (0)
Signalling channel	Not applicable	SDCCH
Location Update		Auto
Cell access		Disabled (barred)

#### Settings for CMU (general)

Repetition	Continuous
Stop condition	None
Display mode	Max./Min
Statistic Count	1000 Bursts
Decoder	Standard

Additional settings on the base stations CMU200 for frequency stability measurements



## 4. Measurements

### 4.1. Conducted emissions on antenna port (RX-Mode)

**Test location and equipment** (for reference numbers please see chapter 'List of test equipment')

test location	<input checked="" type="checkbox"/> CETECOM Essen (Chapter. 2.2.1)	<input type="checkbox"/> Please see Chapter. 2.2.2	<input type="checkbox"/> Please see Chapter. 2.2.3
test site	<input type="checkbox"/> 441 EMI SAR	<input type="checkbox"/> 487 SAR NSA	<input type="checkbox"/> 337 OATS <input checked="" type="checkbox"/> 347 Radio.lab.
receiver	<input type="checkbox"/> 377 ESCS30	<input type="checkbox"/> 001 ESS	<input checked="" type="checkbox"/> ESU
spectr. analys.	<input type="checkbox"/> 381 380 FSBS	<input type="checkbox"/> 120 FSEM	<input type="checkbox"/> 264 FSEK
signaling	<input checked="" type="checkbox"/> 298 CMU	<input type="checkbox"/> 460 CMU	<input type="checkbox"/> 295 RACAL <input type="checkbox"/> 392 MT8820A
power supply	<input type="checkbox"/> 456 EA 3013A	<input type="checkbox"/> 457 EA 3013A	<input type="checkbox"/> 459 EA 2032-50 <input type="checkbox"/> 268 EA- 3050 <input type="checkbox"/> 494 AG6632A <input checked="" type="checkbox"/> 498 NGPE 40
otherwise	<input type="checkbox"/> 400 FTC40x15E	<input type="checkbox"/> 401 FTC40x15E	<input type="checkbox"/> 110 USB LWL <input checked="" type="checkbox"/> 482 Filter Matrix

#### Standards and Limits: CFR 47, Part 15, Subpart B, §15.111 (a), RSS-132, RSS-133, RSS-Gen

Standard	conducted emission limits on antenna port	
	Value / [nW]	Value / [dBm]
FCC: §15.111(a)	2 nW for all frequencies	-57dBm
RSS-Gen	2 nW below 1GHz	-57 dBm
RSS-132	5 nW about 1GHz	-53 dBm
RSS-133		

#### Test condition and measurement test set-up

link to test system (if used):	<input type="checkbox"/> Air-link	<input checked="" type="checkbox"/> cable connection
Climatic conditions	Temperature: (23.3°C)	Rel. humidity: (37)%
EMI-Receiver (Analyzer) Settings	Span/Range: from RBW/VBW: 100 kHz below 1GHz, 1MHz above 1GHz Detector/ Mode: PEAK, TRACE max-hold mode, repetitive scan Quasi-Peak for final measurement on critical measurements (f<1GHz) Average: for final measurement on critical measurements (f>1GHz)	

#### GENERAL MEASUREMENT PROCEDURES:

The measurement test set-up and test procedure are in accordance with the provisions described in ANSI 63.4: 2003 (2009)

The *Equipment under Test* (EUT) set-up to defined operating mode and installed (connected) to accessory equipment according the general description of use given by the applicant.

#### Test Set-up for conducted measurements

The EUT's RF-signal is coupled out by a suitable antenna coupling connector (1). The signal is first 10 dB attenuated (2) before it is 0° divided by a power divider (3). One of the signal path is connected to the communication base station (4), other branch is connected to the spectrum – analyzer (5). The specific attenuation losses for both signal paths/branches are determined prior to the measurement within a set-up calibration. These are then taken into account by correcting the measurement readings on the spectrum-analyzer.

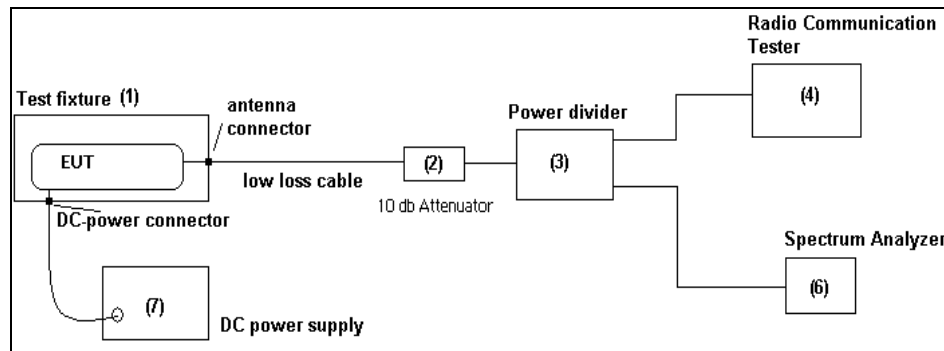

**Schematic: Test set-up conducted**

#### 4.2. Conducted emissions on antenna port, §15.111

Middle RX-channel = 192 (Set-up 2, Op. Mode 1)

BCCH channel = 182 (Downlink)							
Sweep frequency range: [MHz]	Diagram number	Frequency of emission [MHz]	Transducer factor [dB]	Result /[dBm]		Limit [dBm]	Verdict
				PK	AV		
Sweep 1: 30MHz - 1GHz	14.21	178.60	1.)	-64.43	--	-57	Passed
		879.91		-44.22	--		BCCH channel 182, emission not from EUT, Passed
Sweep 2: 1GHz-5GHz	14.22 + discrete frequencies	1867.62 35669.8	--	-61.42 -63.72 -63.73	-68.77 -76.27 -76.17		

Remark: see also diagrams enclosed in Annex A1 for more details

- 1.) External path correction factors counted automatically in the measurement software

#### 4.3. Conducted emissions on antenna port, Canada requirements, RSS-132, Issue 2, §4.6

Middle RX-channel = 192 (Set-up 2, Op. Mode 1)

BCCH channel = 182 (Downlink)							
Sweep frequency range: [MHz]	Diagram number	Frequency of emission [MHz]	Transducer factor [dB]	Correction factor (RBW:3kHz-> 4kHz)	Result [dBm]	Limit [dBm]	Verdict
Sweep 1: 30..1000MHz	14.17	30-1000MHz 880.10 MHz	1.)	+ 1.25 dB	< - 86.75 dBm -53.15 remark 2.)	-57	Passed
Sweep 2: 1 .. 19.5 GHz	14.18	1-18.5GHz 3588.25 MHz	1.)		< -69.75 dBm -68.11 dBm	-53	Passed

Remark: see also diagrams enclosed in Annex A1 for more details

- 2.) Peak from measurement set-up, BCCH carrier of base station

#### 4.4. Conducted emissions on antenna port, Canada requirements, RSS-133, Issue 3, §6.7(b)

Middle RX-channel = 661 (Set-up 2, Op. Mode 2)

BCCH channel = 651 (downlink)							
Sweep frequency range: [MHz]	Diagram number	Frequency of emission [MHz]	Transducer factor [dB]	Correction factor (RBW:3kHz-> 4kHz)	Result [dBm]	Limit [dBm]	Verdict
Sweep 1: 30..1000MHz	14.19	30-1000MHz	1.)	+ 1.25 dB	< -77.23 dBm	-57	Passed
Sweep 2: 1 .. 19.5 GHz	14.20	1-18.5GHz 12.835GHz 1957.25MHz	1.)		< -68.58 dBm -66.73 dBm -52.20 dBm	-54	Passed

Remark: see also diagrams enclosed in Annex A1 for more details

- 2.) Peak from measurement set-up, BCCH carrier of base station

### Verdict

Summary of conducted measurement: Passed

#### 4.5. Conducted emissions on AC-Power lines

##### TEST LOCATION AND EQUIPMENT (for reference numbers please see chapter 'List of test equipment')

test location	<input checked="" type="checkbox"/> CETECOM Essen (Chapter 2.2.1)	<input type="checkbox"/> Please see Chapter 2.2.2	<input type="checkbox"/> Please see Chapter 2.2.3
test site	<input type="checkbox"/> 333 EMI field	<input checked="" type="checkbox"/> 348 EMI cond.	<input type="checkbox"/> 334 EMS-field <input type="checkbox"/> 335 EMS cond <input type="checkbox"/> 347 Radio.lab. <input type="checkbox"/> 337 OATS
receiver	<input checked="" type="checkbox"/> 001 ESS	<input type="checkbox"/> 377 ESCS 30	<input type="checkbox"/>
LISN	<input checked="" type="checkbox"/> 005 ESH2-Z5	<input type="checkbox"/> 007 ESH3-Z6	<input type="checkbox"/> 300 ESH3-Z5 & 50Ω used for AE <input checked="" type="checkbox"/> no LISN for AE <input type="checkbox"/>
signaling	<input type="checkbox"/> 017 CMD 65	<input type="checkbox"/> 323 CMD 55	<input type="checkbox"/> 340 CMD 55
signaling	<input type="checkbox"/> 298 CMU	<input type="checkbox"/> 460 CMU	<input checked="" type="checkbox"/> 295 RACAL <input checked="" type="checkbox"/> 392 MT8820A

##### STANDARDS AND LIMITS: PART 15, SUBPART B, §15.107, §15.207, CANADA: RSS-GEN:7.2.2, ANSI C63.4:2009

Frequency [MHz]	Conducted limit [dBμV] Class B		Conducted limit [dBμV] Class A	
	QUASI-Peak	AVERAGE	QUASI-Peak	AVERAGE
0.15 – 0.5	66 to 56*	56 to 46*	79	66
0.5 – 5	56	46	73	60
5 – 30	60	50	73	60

Remark: \* decreases with the logarithm of the frequency

##### TEST CONDITION AND MEASUREMENT PROCEDURES TEST SET-UP

link to test system (if used):	<input checked="" type="checkbox"/> air link <input type="checkbox"/> cable connection <input type="checkbox"/>
EUT-grounding	<input checked="" type="checkbox"/> none <input type="checkbox"/> with power supply <input type="checkbox"/> additional connection
Equipment set up	<input checked="" type="checkbox"/> table top (40 cm distance to reference ground plane (wall)) <input type="checkbox"/> floor standing EUT stands isolated on reference ground plane (floor)
Climatic conditions	Temperature: (23.7°C) Rel. humidity: (33)%
EMI-Receiver (Analyzer) Settings	Span/Range: 150 kHz to 30 MHz RBW: 9 kHz Detector/Mode: Max PEAK-hold, repetitive scan for preliminary testing Quasi-Peak Detector and Average-Detector for final measurement according ANSI 63.4, CISPR 16

Devices which can be connected to the public AC-power network, should be tested against the radio frequency voltage conducted back into the AC-power line in the frequency range 150kHz to 30 MHz. Compliance should be tested by measuring the radio frequency voltage between each power line and ground at the power terminals in the stated frequency range.

A 500hm/50μH line impedance stabilization network (LISN) is used therefore. The EUT power input leads are connected through the LISN to the AC-power source. The LISN enclosure is electrically connected to the GND-plane. The measuring instrument is connected to the coaxial output of the LISN.

Tabletop devices were set-up on a 80 cm height over reference ground plane, floor standing equipment 10 cm raised above ground plane.

Measurements have been performed on each phase line and neutral line of the devices AC-power lines. The EUT was power supplied with 110 V/60Hz.

The EUT was tested in the defined operating mode and installed (connected) to accessory equipment according the general description of use given by the applicant.

**Preliminary testing** as a first step, determines the worst-case phase line (neutral or phase) as well as the most critical amplitude by changing the operating mode. A complete frequency-sweep is performed with PK-Detector.

**Final testing** for power phases and critical frequencies (Margin to AV- or QP limit lower than 3dB) as a second step includes measurements either on discrete frequency components with receivers detector set to Quasi-Peak and Average per frequency component or a complete sweep with corresponding detector.

**MEASUREMENT RESULTS**

<b>EUT</b> Type and S/N or EUT set-up no.		EUT set-up 3			
EUT operating mode		EUT operating mode 2			
Diagram No.	Command or EUT operating mode or operating mode no.	Detector (Peak, CISPR AV, CISPR QP)	Power line (L1, L2, L3, N)	Additional (scan-) information (e.g. Pre-test Fast scan, Maxhold, Final measurement)	Result (passed / failed /final measurement . necessary)
1.1	EUT operating mode: Op. Mode 2: IDLE 1900	Peak, AV,QP	L1, N	The Diagram shows PK/AV detector measurements on L1 and N with max-hold mode. Final measurement QP and AV was carried out on at least one frequency (please see diagram)	passed

Remarks: The diagram 1.1 contains the maximum values from L 1 + N phase

<b>EUT</b> Type and S/N or EUT set-up no.		EUT set-up 3			
EUT operating mode		EUT operating mode 1			
Diagram No.	Command or EUT operating mode or operating mode no.	Detector (Peak, CISPR AV, CISPR QP)	Power line (L1, L2, L3, N)	Additional (scan-) information (e.g. Pre-test Fast scan, Maxhold, Final measurement)	Result (passed / failed /final measurement . necessary)
1.3	EUT operating mode: Op. Mode 1: IDLE 850	Peak, AV,QP	L1, N	The Diagram shows PK/AV detector measurements on L1 and N with max-hold mode. Final measurement QP and AV was carried out on at least one frequency (please see diagram)	passed

Remarks: The diagram 1.3 contains the maximum values from L1 + N phase

Margin to Limit for verdict:  $M = L_T - R_R + C_{Loss}$

Abbreviations used:

- $R_R$  : Receiver readings in dB $\mu$ V
- $C_{Loss}$ : cable loss
- $L_T$  : Limit in dB $\mu$ V

**VERDICT**

Summary of measurement results for conducted emissions on AC-Power lines: Passed

#### 4.6. Radiated emissions, 30 MHz - 1 GHz, §15.109 class B, RSS132, RSS133, RSS-gen

##### TEST LOCATION AND EQUIPMENT (for reference numbers please see chapter 'List of test equipment')

test location	<input checked="" type="checkbox"/> CETECOM Essen (Chapter. 2.2.1)	<input type="checkbox"/> Please see Chapter. 2.2.2	<input type="checkbox"/> Please see Chapter. 2.2.3
test site	<input checked="" type="checkbox"/> 441 EMI SAR	<input type="checkbox"/> 487 SAR NSA	<input type="checkbox"/> 337 OATS
receiver	<input type="checkbox"/> 377 ESCS30	<input checked="" type="checkbox"/> 001 ESS	<input type="checkbox"/> 347 Radio.lab.
spectr. analys.	<input type="checkbox"/> 381 380 FSBS	<input type="checkbox"/> 120 FSEM	<input type="checkbox"/> 264 FSEK
antenna	<input checked="" type="checkbox"/> 048 EMCO3143	<input type="checkbox"/> 133 EMCO3115	<input type="checkbox"/> 302 BBHA9170
signaling	<input type="checkbox"/> 298 CMU	<input type="checkbox"/> 460 CMU	<input checked="" type="checkbox"/> 392 MT8820A
power supply	<input type="checkbox"/> 456 EA 3013A	<input checked="" type="checkbox"/> 087 EA 3013A	<input type="checkbox"/> 459 EA 2032-50
otherwise	<input type="checkbox"/> 400 FTC40x15E	<input type="checkbox"/> 401 FTC40x15E	<input checked="" type="checkbox"/> 110 USB LWL
			<input checked="" type="checkbox"/> 482 Filter Matrix

##### STANDARDS AND LIMITS: CFR 47, PART 15, SUBPART B, §15.109 (CLASS B), §15.209, ANSI C63.4

Frequency [MHz]	Radiated emission limits, Class B, 3 meters		Radiated emission limits, Class A, 10 meters	
	QUASI-Peak [microvolts/meter]	QUASI-Peak [dBµV/m]	QUASI-Peak [microvolts/meter]	QUASI-Peak [dBµV/m]
30-88	100	40	90	39,0
88-216	150	43,5	150	43,5
216-960	200	46,0	210	46,4
above 960	500	54,0	300	59,5

##### TEST CONDITION AND MEASUREMENT TEST SET-UP

link to test system (if used):	<input checked="" type="checkbox"/> air link	<input type="checkbox"/> cable connection	<input type="checkbox"/>
EUT-grounding	<input checked="" type="checkbox"/> none	<input type="checkbox"/> with power supply	<input type="checkbox"/> additional connection
Equipment set up	<input checked="" type="checkbox"/> table top 0.8m height		<input type="checkbox"/> floor standing
Climatic conditions	Temperature: (24°C)		Rel. humidity: (30)%
EMI-Receiver (Analyzer) Settings	Span/Range: 30 MHz to 1 GHz RBW/VBW: 120 kHz / (auto) Detector/ Mode: PEAK, TRACE max-hold mode, repetitive scan Quasi-Peak, for final measurement for critical measurements		

##### GENERAL MEASUREMENT PROCEDURES:

The measurement test set-up and test procedure are in accordance with the provisions described in ANSI 63.4: 2009

The *Equipment under Test* (EUT) set-up to defined operating mode and installed (connected) to accessory equipment according the general description of use given by the applicant.

##### MEASUREMENT METHOD (30 MHz < f < 1 GHz):

An EMI analyzer together with a broadband antenna was used in order to identify the emissions from the EUT by positioning the antenna close to the EUT surfaces.

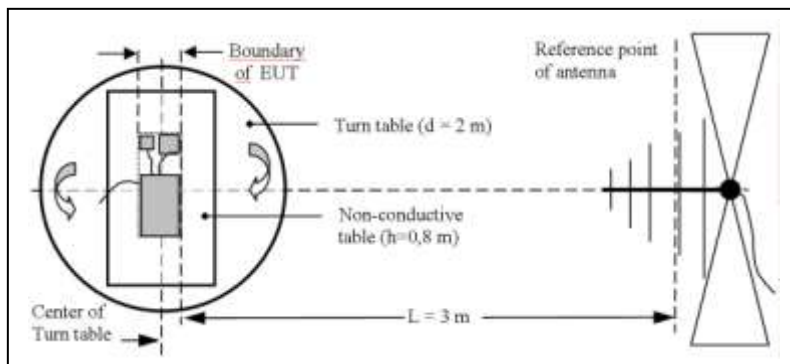

The interconnecting cables and equipment position were varied in order to maximize the emissions. Then most critical frequencies are recorded for further investigations. Based on the exploratory measurements, the most critical frequencies are re-measured by maintaining the EUT's operating mode, cable position, etc. The EUT was placed on a non-conductive support of 0.8 m height. By rotating the turntable angle in the range 0 to 360 degree, the EUT itself either over

3-orthogonal axis (not defined usage position) or 2-orthogonal axis (defined usage position) and the measurement antenna height from 1 meter to 4 meters, the maximized emissions are recorded. The measurements are performed for both polarizations of the measuring antenna: horizontal and vertical.

**RESULTS**

Set-up No.		1								
Operating Mode		2								
Diagram no.	Frequency	MaxPeak	Meas. Time	Bandwidth	Antenna height	Polarity	Turntable position	Corr. (dB)	Margin (dB)	Limit (dBμV/m)
	(MHz)	(dBμV/m)	(ms)	(kHz)	(cm)		(deg)	(C <sub>F</sub> )	(M)	(L <sub>T</sub> )
2.01	866.36	40.09	10	120	100-400	H/V	0..360°	--	--	46.0 QP)
	30..1000 MHz	< 42.5 (PK)	10	120	100-400	H/V	0..360°	--	--	Part 15.109B

Remark: \*.) see also plots enclosed in separate annex A1

Set-up No.		1								
Operating Mode		1								
Diagram no.	Frequency	MaxPeak	Meas. Time	Bandwidth	Antenna height	Polarity	Turntable position	Corr. (dB)	Margin (dB)	Limit (dBμV/m)
	(MHz)	(dBμV/m)	(ms)	(kHz)	(cm)		(deg)	(C <sub>F</sub> )	(M)	(L <sub>T</sub> )
2.02	316.28	28.79	10	120	100-400	H/V	0..360°	--	--	46.0 (QP)
	30..1000 MHz	< 40.0 (PK)	10	120	100-400	H/V	0..360°	--	--	Part 15.109B

Remark: \*.) see also plots enclosed in separate annex A1

Signals due to base stations BCCH Signals: GSM850 – Channel 182 – 880MHz

<p><b>Margin to Limit:</b></p> $M = L_T - R_R + C_F + D_F$ $= L_T - R_R + AF_{ANTENNA} + Cable_{LOSS} + D_F$ <p>Remark: positive margin means passed result</p>	<p><b>Abbreviations used:</b></p> <ul style="list-style-type: none"> <li>• R<sub>R</sub> : Receiver readings in dBμV/m</li> <li>• C<sub>F</sub>: Transducer in dB = AF (antenna factor) + CL (cable loss)</li> <li>• D<sub>F</sub> : distance correction factor (if different measurement distance used than specified in the standard)</li> </ul>
---	--

**VERDICT**

Summary of measurement results for radiated emissions above 30 MHz and below 1 GHz : Passed

#### 4.7. Radiated emissions, above 1GHz, §15.109 class B, RSS132, RSS133, RSS-gen

##### TEST LOCATION AND EQUIPMENT (for reference numbers please see chapter 'List of test equipment')

test site	<input type="checkbox"/> 441 EMI SAR	<input type="checkbox"/> 348 EMI cond.	<input checked="" type="checkbox"/> 443 EMI FAR	<input type="checkbox"/> 347 Radio.lab.	<input type="checkbox"/> 337 OATS	<input type="checkbox"/>
equipment	<input type="checkbox"/> 331 HC 4055	<input type="checkbox"/>	<input type="checkbox"/>	<input type="checkbox"/>	<input type="checkbox"/>	<input type="checkbox"/>
Spectr. analys.	<input type="checkbox"/> 138 139 FSBS	<input type="checkbox"/> 120 FSEM	<input type="checkbox"/> 264 FSEK	<input checked="" type="checkbox"/> 489 ESU	<input type="checkbox"/>	<input type="checkbox"/>
antenna meas	<input type="checkbox"/> 048 3143	<input type="checkbox"/> 289 CBL 6141	<input checked="" type="checkbox"/> 439 HL 562	<input checked="" type="checkbox"/> 549 HL452	<input type="checkbox"/> 302 BBHA9170	<input type="checkbox"/> 477 GPS
antenna meas	<input type="checkbox"/> 123 HUF-Z2	<input type="checkbox"/> 132 HUF-Z3	<input type="checkbox"/> 030 HFH-Z2	<input type="checkbox"/>	<input type="checkbox"/>	<input type="checkbox"/>
antenna subst	<input type="checkbox"/> 071 HUF-Z2	<input type="checkbox"/> 020 EMCO3115	<input type="checkbox"/> 063 LP 3146	<input type="checkbox"/> 303 BBHA9170	<input type="checkbox"/>	<input type="checkbox"/>
power meter	<input type="checkbox"/> 009 NRV	<input type="checkbox"/> 010 URV5-Z2	<input type="checkbox"/> 011 URV5-Z2	<input type="checkbox"/>	<input type="checkbox"/>	<input type="checkbox"/>
Signalgener.	<input type="checkbox"/> 008 SMG	<input type="checkbox"/> 140 SMHU	<input type="checkbox"/> 263 SMP04	<input type="checkbox"/>	<input type="checkbox"/>	<input type="checkbox"/>
power meter	<input type="checkbox"/> 262 NRV-S	<input type="checkbox"/> 266 NRV-Z31	<input type="checkbox"/> 265 NRV-Z33	<input type="checkbox"/> 261 NRV-Z55	<input type="checkbox"/> 356 NRV-Z1	<input type="checkbox"/>
DCpower	<input type="checkbox"/> 086 LNG50-10	<input checked="" type="checkbox"/> 087 EA3013	<input type="checkbox"/> 354 NGPE 40	<input type="checkbox"/> 349 car battery	<input type="checkbox"/> 350 Car battery	<input type="checkbox"/>
multimeter	<input type="checkbox"/> 341 Fluke 112	<input type="checkbox"/>	<input type="checkbox"/>	<input type="checkbox"/>	<input type="checkbox"/>	<input type="checkbox"/>
signaling	<input type="checkbox"/> 298 CMU	<input checked="" type="checkbox"/> 546 CMU	<input type="checkbox"/> 295 RACAL	<input type="checkbox"/> 392 MT8820A		

##### STANDARDS AND LIMITS: CFR 47, PART 15, SUBPART B, §15.109 (CLASS B), §15.209, ANSI C63.4

Frequency [MHz]	Radiated emission limits, 3 meters measurement distance			
	AV [microvolts/meter]	AV [dBµV/m]	Peak [microvolts/meter]	Peak [dBµV/m]
above 1GHz	500	54.0	5000	74.0

##### TEST CONDITION AND MEASUREMENT TEST SET-UP

link to test system (if used):	<input checked="" type="checkbox"/> air link	<input type="checkbox"/> cable connection	<input type="checkbox"/>
EUT-grounding	<input checked="" type="checkbox"/> none	<input type="checkbox"/> with power supply	<input type="checkbox"/> additional connection
Equipment set up	<input checked="" type="checkbox"/> table top 1.5m height	<input type="checkbox"/> floor standing	
Climatic conditions	Temperature: (24°C)		Rel. humidity: (30)%
Spectrum-Analyzer settings	Span/Frequency range : 1..10 GHz +single frequencies determined in step 1 RBW/VBW: 1 MHz / 3 MHz Detector/ Mode: Peak, MAX-hold, repetitive scan for exploratory measurement PEAK/ AVERAGE, for final measurement for critical frequencies Antenna Polarisation Horizontal / Vertical		

##### GENERAL MEASUREMENT PROCEDURES:

The measurement test set-up and test procedure are in accordance with the provisions described in ANSI 63.4: 2009.

The *Equipment under Test* (EUT) was placed on a non-conductive positioning table of 0.8 or 1.5 meter height depending from the frequency range. The measuring distance was set to 3 meter for frequencies up to 18GHz and 1 meter above 18GHz.

The EUT was set-up to defined operating mode and installed (connected) to accessory equipment according the general description of use given by the applicant.

For the upper frequency measurement range, it was assumed that the highest frequency generated in the device is same as the highest operable TX-frequency in GSM1900 Mode (1909.8 MHz). Therefore the upper frequency limit was set to 10GHz for IDLE 1900 operating mode or 6GHz for IDLE 850.

**1. Step exploratory measurement:** see above description as in the frequency range lower 1GHz.

**2. Step Final Measurement(1 GHz<f <18 GHz):** On the Worst-Case EUT configuration, frequency components with a margin lower than 6 dB to the limits, will be re-measured by maintaining the EUT's operating mode, cable position, etc.. For find the worst-case emission, the turntable was changed in the range 0 to 360 degree and the EUT itself either over 3-orthogonal axis (not defined usage position) or 2-orthogonal axis (defined usage position). The measurements are performed for both polarizations of the measuring antenna: horizontal and vertical.

**MEASUREMENT RESULTS:**

Set-up No.		1								
Operating Mode		1								
Diagram no.	Frequency	MaxPeak	Meas. Time	Bandwidth	Antenna height	Polarity	Turntable position	Corr. (dB)	Margin (dB)	Limit (dBμV/m)
	(MHz)	(dBμV/m)	(ms)	(kHz)	(cm)		(deg)	(CF)	(M)	(LT)
2.03	2.504GHz	61.34 (PK)	10	1000	155.0	H/V	0..360°	--	12.66 (PK)	74.0 (PK)
	1867.6	42.81 (AV)	10	1000	155.0	H/V	0..360°	--	11.19 (AV)	54.0 (AV)

Remark: 1.) diagrams shows PK/AV detector measurements  
 \*.) see also plots enclosed in separate annex 1

Set-up No.		1								
Operating Mode		1								
Diagram no.	Frequency	MaxPeak	Meas. Time	Bandwidth	Antenna height	Polarity	Turntable position	Corr. (dB)	Margin (dB)	Limit (dBμV/m)
	(MHz)	(dBμV/m)	(ms)	(kHz)	(cm)		(deg)	(C <sub>F</sub> )	(M)	(L <sub>T</sub> )
2.04	3519.9	44.2 (PK)	100	1000	155.0	V	8.0	-0.7	29.8	74.0 (PK)
	3519.9	31.0 (AV)	100	1000	155.0	V	-10.0	-0.7	23.0	54.0 (AV)

Remark: 1.) diagrams shows PK/AV detector measurements  
 \*.) see also plots enclosed in separate annex 1

Set-up No.		1								
Operating Mode		2								
Diagram no.	Frequency	MaxPeak	Meas. time	Bandwidth	Antenna height	Polarity	Turntable position	Corr. (dB)	Margin (dB)	Limit (dBμV/m)
	(MHz)	(dBμV/m)	(ms)	(kHz)	(cm)		(deg)	(C <sub>F</sub> )	(M)	(L <sub>T</sub> )
2.05	1958.0 remark 2.)	50.27 (PK)	10	1000	155.0	H/V	0..360°	--	--	74 (PK) 54 (AV)
	1-2.8GHz	< 47.5 (PK)	10	1000	155.0	H/V	0..360°	--	>20 to PK	74.0 (PK)

Remark: 1.) diagrams shows PK/AV detector measurements  
 \*.) see also plots enclosed in separate annex 1  
 2.) Signal due to base stations BCCH Signal: GSM1900, Channel 651 – 1958MHz



Set-up No.		1								
Operating Mode		2								
Diagram no.	Frequenc y (MHz)	MaxPeak (dBμV/m)	Meas. Time (ms)	Bandwidth (kHz)	Antenna height (cm)	Polarity	Turntable position (deg)	Corr. (dB) (CF)	Margin (dB) (M)	Limit (dBμV /m) (LT)
2.06	3795.30	43.4 (PK)	100.0	1000	155.0	V	331.0	--	30.6	74.0 (PK)
	3871.80	46.3 (PK)	100.0	1000	155.0	V	338.0	--	27.7	
	3915.90	46.3 (PK)	100.0	1000	155.0	H	316.0	--	27.7	
	3871.40	29.2 (AV)	100.0	1000	155.0	V	343.0	--	24.8	54.0 (AV)
	3915.90	33.2 (AV)	100.0	1000	155.0	H	310.0	--	20.8	

Remark: 1.) diagrams shows PK/AV detector measurements  
 \*.) see also plots enclosed in separate annex 1

<p><b>Margin to Limit:</b></p> $M = L_T - R_R + C_F + D_F$ $= L_T - R_R + AF_{ANTENNA} + Cable_{LOSS} + D_F$ <p>Remark: positive margin means passed result</p>	<p><b>Abbreviations used:</b></p> <ul style="list-style-type: none"> <li>• <math>R_R</math> : Receiver readings in dBμV/m</li> <li>• CF: Transducer in dB = AF (antenna factor) + CL (cable loss)</li> <li>• <math>D_F</math> : distance correction factor (if different measurement distance used than specified in the standard)</li> <li>• <math>L_T</math> : Limit in dBμV/m</li> </ul>
---	---

**VERDICT**

Summary of measurement results for radiated emissions above 1 GHz : Passed

## 5. Measurement uncertainties

The reported uncertainties are calculated based on the standard uncertainty multiplied with the appropriate coverage factor **k**, such that a confidence level of approximately 95% is achieved.

For uncertainty determination, each component used in the concrete measurement set-up was taken in account and it's contribution to the overall uncertainty according it's statistical distribution calculated.

Following table shows expectable uncertainties for each measurement type performed.

Measurement	Frequency range	Calculated uncertainty based on a confidence level of 95%	Remarks:
RF-Power Output conducted	9 kHz .. 20 GHz	1.0 dB	--
RF-Power Output radiated	30 MHz .. 4 GHz	3.17 dB	Substitution method
Conducted RF-emissions on antenna ports	9 kHz .. 20 GHz	1.0 dB	--
Radiated RF-emissions enclosure	150 kHz .. 30 MHz	5.0 dB	Magnetic field
	30 MHz .. 1 GHz	4.2 dB	E-Field
	1 GHz .. 18GHz	4.8 dB	E-Field
	1 GHz .. 20 GHz	3.17 dB	Substitution method
Occupied bandwidth	9 kHz .. 4 GHz	0.1272 ppm (Delta Marker method)	Frequency error
		1 dB	Power
Emission bandwidth	9 kHz .. 4 GHz	0.1272 ppm (Delta Marker method)	Frequency error
		1 dB	Power
Frequency stability	9 kHz .. 20 GHz	0.0636 ppm	--
Conducted emissions on AC-mains port (U <sub>CISPR</sub> )	9 kHz .. 150 kHz	4.0 dB	--
	150 kHz .. 30 MHz	3.6 dB	

**Table : measurement uncertainties, valid for conducted/radiated measurements**

## 6. Instruments and Ancillary

### 6.1. Used equipment “CTC”

The “Ref.-No” in the left column of the following tables allows the clear identification of the laboratory equipment.

#### 6.1.1. Test software and firmware of equipment

Ref.-No.	Equipment	Type	Serial-No.	Version of Firmware or Software during the test
001	emi test receiver	ESS	825132/017	Firm.= 1.21 , OTP=2.0, GRA=2.0
012	signal generator (EMS-cond.)	SMY 01	839069/027	Firm.= V 2.02
013	power meter (EMS cond.)	NRVD	839111/003	Firm.= V 1.51
017	Communication Tester	CMD 60 M	844365/014	Firmware = V 3.52 .22.01.99, DECT Firmware D2.87
053	audio analyzer	UPA3	860612/022	Firm. V 4.3
119	RT harmonics analyser/dig. flickermeter	B10	G60547	Firm.= V 3.1DHG
140	signal generator	SMHU	831314/006	Firm.= 3.21
261	thermal power sensor	NRV-Z55	825083/0008	EPROM-Datum 02.12.04, SE EE 1 B
262	power meter	NRV-S	825770/0010	Firm.= 2.6
263	signal generator	SMP 04	826190/0007	Firm.=3.21
264	spectrum analyzer	FSEK 30	826939/005	Bios=2.1, Analyzer= 3.20
295	Racal Digital Radio Test Set	6103	1572	UNIT Firmware= 4.04, SW-Main=4.04, SW-BBP=1.04,
298	Univ. Radio Communication Tester	CMU 200	832221/091	R&S Test Firmware =3.53 /3.54 (current Testsoftw. f.
323	Communication Tester	CMD 055	825878/0034	Firm.= 3.52 .22.01.99
331	climatic test chamber -40/+80 Grad	HC 4055	43146	TSI 1.53
335	System-CTC-EMS-Conducted	System EMS Conducted	-	EMS-K1 Immunity Test-Software 1.20SR10
340	Univ. Communication Tester	CMD 55	849709/037	Firm.= 3.52 .22.01.99
355	power meter	URV 5	891310/027	Firm.= 1.31
365	10V Insertion Unit 50 Ohm	URV5-Z2	100880	Eprom Data = 31.03.08
366	Ultra Compact Simulator	UCS 500 M4	V0531100594	Firm. UCS 500=001925/3.06a02, rc=ISMIEC 4.10
371	Bluetooth Tester	CBT32	100153	CBT V4.6.1 + SW-Option K55
377	emi test receiver	ESCS 30	100160	Firm.= 2.30, OTP= 02.01, GRA= 02.36
378	broadband RF field monitor	RadiSense III	03D00013SNO-08	Firm.= V.03D13
383	signal generator	SME 03	842 828 /034	Firm.= 4.61
389	digital multimeter	Keithley 2000	0583926	Firm. = A13 (Mainboard) A02 (Display)
392	Radio Communication Tester	MT8820A	6K00000788	Firm.= 4.50 #005, IPL=4.01#001,OS=4.02#001,
441	System CTC-SAR-EMI Cable Loss	System EMI field (SAR)	-	EMC 32 Version 8.10.10
442	System CTC-SAR-EMS	System EMS field (SAR)	-	EMS-K1 Immunity-Software 1.20SR10
443	System CTC-FAR-EMI-Spuri	System CTC-FAR-EMI-	-	Spuri 7.2.5
444	System CTC FAR-EMS	System EMS-Field (FAR)	-	EMS-K1 Immunity-Software 1.20SR10
460	Univ. Radio Communication Tester	CMU 200	108901	R&S Test Firmware Base=5.14/Messsoftware=
489	emi test receiver	ESU40	1000-30	Firmware=4.43 SP3, Bios=V5.1-16-3,
491	ESD Simulator dito	ESD dito	dit0307022	V 2.30
524	Voltage Drop Simulator	VDS 200	0196-16	Software Nr: 000037 Version V4.20a01
526	Burst Generator	EFT 200 A	0496-06	Software Nr. 000034 Version V2.32
527	Micro Pulse Generator	MPG 200 B	0496-05	Software-Nr. 000030 Version V2.43
528	Load Dump Simulator	LD 200B	0496-06	Software-Nr. 000031 Version V2.35a01
547	Univ. Radio Kommunikation Tester	CMU 200	835390/014	R&S Test Firmware Base=V5.1403 (current Testsoftw.
584	Spectrum Analyzer	FSU 8	100248	2.82_SP3
594	Kommunikation Tester	CMW500	101757	Firmware and Applications 1.0.15.23
597	Univ. Radio Communication Tester	CMU 200	100347	R&S Test Firmware Base=5.01/Messsoftware=
598	Spectrum Analyser	FSEM 30	831259/013	Firmware Bios 3.3 , Analyzer 3.3

## 6.1.2. Single instruments and test systems

Ref.-No.	Equipment	Type	Serial-No.	Manufacturer	Interval of calibration	Remark	Cal due
001	emi test receiver	ESS	825132/017	Rohde & Schwarz	12 M	-	31.03.2011
005	AC - LISN (50 Ohm/50µH, test site 1)	ESH2-Z5	861741/005	Rohde & Schwarz	24 M	-	31.03.2012
007	DC - LISN (50 Ohm/5µH)	ESH3-Z6	892563/002	Rohde & Schwarz	24 M	-	31.03.2012
009	power meter (EMS-radiated)	NRV	863056/017	Rohde & Schwarz	12 M	-	31.03.2011
011	insertion unit (EMS-radiated)	URV5-Z2	864169/004	Rohde & Schwarz	24 M	-	31.03.2011
012	signal generator (EMS-cond.)	SMY 01	839069/027	Rohde & Schwarz	36/12 M	-	31.03.2011
013	power meter (EMS cond.)	NRVD	839111/003	Rohde & Schwarz	24 M	-	31.03.2011
014	insertion unit (EMS cond.)	URV5-Z2	838519/029	Rohde & Schwarz	24 M	-	31.03.2011
015	insertion unit (EMS cond.)	URV5-Z4	838570/024	Rohde & Schwarz	24 M	-	31.03.2011
016	line impedance simulating network	Op. 24-D	B6366	Spitzenberger+Spies	36 M	-	31.03.2013
017	Communication Tester	CMD 60 M	844365/014	Rohde & Schwarz	12 M	-	31.03.2011
020	horn antenna 18 GHz (Subst 1)	3115	9107-3699	EMCO	36/12 M	-	31.03.2013
021	loop antenna (H-Field)	6502	9206-2770	EMCO	36 M	-	31.03.2013
022	audio measurement amplifier	2636C	1537643	Brüel & Kjaer	12 M	-	31.03.2011
030	loop antenna (H-field)	HFH-Z2	879604/026	Rohde & Schwarz	36 M	-	31.03.2012
031	absorbing clamp	MDS-21	863325/015	Rohde & Schwarz	24 M	-	31.03.2012
033	RF-current probe. (100kHz-30MHz)	ESH2-Z1	879581/18	Rohde & Schwarz	24 M	-	31.03.2011
049	current clamp (injection)	F-120-2	48	FCC	12 M	-	31.03.2011
050	3-ph coupling-decoupling-netw. (Burst)	CDN 300	176	Schaffner	24 M	-	31.03.2012
051	VHF-current probe 20-300 MHz	ESV-Z1	872421	Rohde & Schwarz	36 M	-	31.03.2012
052	notch filter DECT	WRCB 1887,82/1889,55SS	12	Wainwright Industries	pre-m	-	30.05.2011
053	audio analyzer	UPA3	860612/022	Rohde & Schwarz	36 M	-	31.03.2011
057	relay-switch-unit (EMS system)	RSU	494440/002	Rohde & Schwarz	-	1a	30.05.2011
058	capacitive clamp (Burst)	IP 4	99	Hafely	-	4	
060	power amplifier (DC-2kHz)	PAS 5000	B6363	Spitzenberger+Spies	-	3	
066	notch filter (WCDMA; FDD1)	WRCT 1900/2200-5/40-	5	Wainwright GmbH	12 M	-	30.05.2011
067	coupling decoupling-network	CDN801-M2/M3	272	Lüthi	12 M	-	31.03.2011
068	coupling decoupling-network	CDN 801-M5	95226	Lüthi	12 M	-	31.03.2011
069	EM - clamp	EM101	9535159	Lüthi	36 M	-	31.03.2013
072	coupling decoupling-network	CDN801-M2/M3	276	Lüthi	12 M	-	31.03.2011
083	AC - power supply, 0-10 A	EAC/MT 27010	910502096	EURO TEST	pre-m	2	
084	AC - power supply, 0-5 A	ELABO-8-34214	-	ELABO	pre-m	2	
085	AC - power supply, 0-10 A	R250	-	Schunterm.&Benningh.	pre-m	2	
086	DC - power supply, 0 -10 A	LNG 50-10	-	Heinzinger Electronic	pre-m	2	
087	DC - power supply, 0 -5 A	EA-3013 S	-	Elektro Automatik	pre-m	2	
090	Helmholtz coil: 2x10 coils in series	-	-	RWTÜV	pre-m	4	
091	USB-LWL-Converter	OLS-1	007/2006	Ing. Büro Scheiba	-	4	
094	artificial head (No.1)	4905	1566990	Brüel & Kjaer	pre-m	2	
099	passive voltage probe	ESH2-Z3	299.7810.52	Rohde & Schwarz	36 M	-	31.03.2012
100	passive voltage probe	Probe TK 9416	without	Schwarzbeck	36 M	-	31.03.2012
110	USB-LWL-Converter	OLS-1	-	Extreme USB	-	4	
119	RT harmonics analyser/dig. flickermeter	B10	G60547	BOCONSULT	36 M	-	31.03.2013
121	notch filter GSM 1900	WRCB 1879.5/1880,5EE	15	Wainwright GmbH	12 M	-	30.05.2011
122	notch filter GSM 1800	WRCB 1747/1748	12	Wainwright GmbH	12 M	-	30.05.2011
131	RF-Current Probe	F-52	19	FCC	12 M	-	31.03.2011
134	horn antenna 18 GHz (Subst 2)	3115	9005-3414	EMCO	12 M	-	31.03.2011
136	adjustable dipole antenna (Dipole 1)	3121C-DB4	9105-0697	EMCO	12 M	-	31.03.2012
140	signal generator	SMHU	831314/006	Rohde & Schwarz	24 M	-	31.03.2012
248	attenuator	SMA 6dB 2W	-	Radiall	pre-m	2	
249	attenuator	SMA 10dB 10W	-	Radiall	pre-m	2	
252	attenuator	N 6dB 12W	-	Radiall	pre-m	2	
254	high pass GSM1800/1900/DECT	5HC 2600/12750-1,5KK	23042	Trilithic	12 M	-	30.05.2011
256	attenuator	SMA 3dB 2W	-	Radiall	pre-m	2	
257	hybrid	4031C	04491	Narda	pre-m	2	
260	hybrid coupler	4032C	11342	Narda	pre-m	2	
261	thermal power sensor	NRV-Z55	825083/0008	Rohde & Schwarz	24/12 M	-	31.03.2012
262	power meter	NRV-S	825770/0010	Rohde & Schwarz	24 M	-	31.03.2012
263	signal generator	SMP 04	826190/0007	Rohde & Schwarz	36 M	-	31.03.2013
264	spectrum analyzer	FSEK 30	826939/005	Rohde & Schwarz	12 M	-	31.03.2011
265	peak power sensor	NRV-Z33, Model 04	840414/009	Rohde & Schwarz	24 M	-	31.03.2012
266	peak power sensor	NRV-Z31, Model 04	843383/016	Rohde & Schwarz	24 M	-	31.03.2012
268	AC/DC power supply	EA 3050-A	9823636	-	pre-m	2	
270	termination	1418 N	BB6935	Weinschel	pre-m	2	
271	termination	1418 N	BE6384	Weinschel	pre-m	2	
272	attenuator (20 dB) 50 W	Model 47	BF6239	Weinschel	pre-m	2	
273	attenuator, (10 dB) 100 W	Model 48	BF9229	Weinschel	pre-m	2	
274	attenuator (10 dB) 50 W	Model 47 (10 dB) 50 W	BG0321	Weinschel	pre-m	2	
275	DC-Block	Model 7003 (N)	C5129	Weinschel	pre-m	2	
276	DC-Block	Model 7006 (SMA)	C7061	Weinschel	pre-m	2	
279	power divider	1515 (SMA)	LH855	Weinschel	pre-m	2	
284	coupling decoupling network	CDN 801-M1	1661	Lüthi	12 M	-	31.03.2011
285	coupling decoupling network	CDN 801-S1	1642	Lüthi	12 M	-	31.03.2011
287	pre-amplifier 25MHz - 4GHz	AMF-2D-100M4G-35-10P	379418	Miteq	12 M	-	30.05.2011
290	notch filter GSM 900	WRCA 901.9/903,1SS	3RR	Wainwright GmbH	12 M	-	30.05.2011
291	high pass filter GSM 850/900	WHJ 2200-4EE	14	Wainwright GmbH	12 M	-	30.05.2011
296	audio measurement amplifier	2636C	R=316568/004	Brüel & Kjaer	18 M	-	31.03.2011
298	Univ. Radio Communication Tester	CMU 200	832221/091	Rohde & Schwarz	12 M	-	31.03.2011
299	audio microphone	134	-	Brüel & Kjaer	pre-m	2	
300	AC LISN (50 Ohm/50µH, 1-phase)	ESH3-Z5	892 239/020	Rohde & Schwarz	12 M	-	31.03.2011

Ref.-No.	Equipment	Type	Serial-No.	Manufacturer	Interval of calibration	Remark	Cal due
301	attenuator (20 dB) 50W, 18GHz	47-20-33	AW0272	Lucas Weinschel	pre-m	2	
302	horn antenna 40 GHz (Meas 1)	BBHA9170	155	Schwarzbeck	36 M	-	31.03.2011
303	horn antenna 40 GHz (Subst 1)	BBHA9170	156	Schwarzbeck	36 M	-	31.03.2011
304	fix dipole antenna 1,6 GHz	EMCO 3125-307	9907-1001	ETS	24/12 M	-	31.03.2011
305	fix dipole antenna 1,8-2,0 GHz	EMCO 3125-306	9907-1001	ETS	24/12 M	-	31.03.2011
306	fix dipole antenna 2,45 GHz	EMCO 3125-308	9907-1001	ETS	24/12 M	-	31.03.2011
307	fix dipole antenna 3 GHz	EMCO 3125-309	9907-1001	ETS	24/12 M	-	31.03.2011
317	1000 Hz calibrator 94 dB SPL	4230 94dB	1542286	Brüel & Kjaer	12 M	-	31.03.2011
323	Communication Tester	CMD 055	825878/0034	Rohde & Schwarz	12 M	-	31.03.2011
331	climatic test chamber -40/+80 Grad	HC 4055	43146	Heraeus Vötsch	24 M	-	30.11.2012
340	Univ. Communication Tester	CMD 55	849709/037	Rohde & Schwarz	24 M	-	31.03.2012
341	digital multimeter	Fluke 112	81650455	Fluke	24 M	-	31.03.2012
342	digital multimeter	Voltcraft M-4660A	IB 255466	Voltcraft	24 M	-	31.03.2011
344	adaptor 150/50 Ohm	150/50	-	Krohne	12 M	-	31.03.2011
345	adaptor 150/50 Ohm	150/50	-	Krohne	12 M	-	31.03.2011
347	laboratory site	radio lab.	-	-	-	3	
348	laboratory site	EMI conducted	-	-	-	3	
349	car battery 12 V	car battery 12 V	without	-	-	3	
350	car battery 12 V	car battery 12 V	without	-	-	3	
354	DC - power supply 40A	NGPE 40/40	448	Rohde & Schwarz	pre-m	-	
355	power meter	URV 5	891310/027	Rohde & Schwarz	12 M	-	31.03.2011
356	power sensor	NRV-Z1	882322/014	Rohde & Schwarz	24 M	-	31.03.2011
357	power sensor	NRV-Z1	861761/002	Rohde & Schwarz	24 M	-	31.03.2011
358	Power Amplifier 10 kHz-220MHz	AR75A220M1	15860	Amplifier Research	12 M	1b	30.04.2010
365	10V Insertion Unit 50 Ohm	URV5-Z2	100880	Rohde & Schwarz	24 M	-	31.03.2012
366	Ultra Compact Simulator	UCS 500 M4	V0531100594	EM-Test	12 M	-	01.04.2011
367	audio measurement amplifier	2636	316832/001	Brüel & Kjaer	12 M	-	31.03.2011
369	insertion unit (SAR-EMS, Ch. A)	URV5-Z2	100301	Rohde & Schwarz	24 M	-	31.03.2011
370	insertion unit (SAR-EMS, Ch. B)	URV5-Z2	100302	Rohde & Schwarz	24 M	-	31.03.2011
371	Bluetooth Tester	CBT32	100153	R&S	12 M	-	31.03.2011
373	V-Network 5µH/50 Ohm	ESH3-Z6	100535	Rohde & Schwarz	12 M	-	31.03.2011
374	power amplifier 0,8-3 GHz	60S1G3	306528	Amplifier Research	-	1a	30.05.2011
375	directional coupler	DC7144M1	306498	Amplifier Research	-	1a	30.05.2011
376	horn antenna 6 GHz	BBHA9120 E	BBHA 9120 E 179	Schwarzbeck	12 M	-	01.04.2011
377	emi test receiver	ESCS 30	100160	Rohde & Schwarz	12 M	-	31.03.2011
378	broadband RF field monitor	RadiSense III	03D00013SNO-08	DARE B.V.	12 M	-	31.03.2011
383	signal generator	SME 03	842 828 /034	Rohde & Schwarz	36 M	-	31.03.2013
386	coupling decoupling network	CDN USB/p	19397	Schaffner	12 M	-	31.03.2011
387	coupling decoupling network	CDN L-801 M2	2051	Lüthi	12 M	-	31.03.2011
388	coupling decoupling network	CDN L-801 T2	1929	Lüthi	12 M	-	31.03.2011
389	digital multimeter	Keithley 2000	0583926	Keithley	24 M	-	31.03.2011
390	Industry Acoustic System	MO 2000 Set	2127100123	Sennheiser	-	4	
392	Radio Communication Tester	MT8820A	6K00000788	Anritsu	12 M	-	31.03.2011
394	power amplifier 80-1000 MHz	BLWA 0810-250/200	045610	Bonn-Elektronik	-	1a	30.05.2011
399	Sound Calibrator	Sound Calibrator 4231	2665101	Brüel & Kjaer	12 M	-	31.03.2011
400	ferrite tube (>15 dB, EN 55022)	FTC 40 X 15 E	5559	Lüthi	36 M	-	31.03.2012
401	ferrite tube (>15 dB, EN 55022)	FTC 40 X 15 E	5560	Lüthi	36 M	-	31.03.2012
431	Model 7405	Near-Field Probe Set	9305-2457	EMCO	-	4	
439	UltraLog-Antenna	HL 562	100248	Rohde + Schwarz	12 M	-	30.04.2011
440	CDN for Databable	CDN-UTP	CDN-UTP 029	EMC Partner AG,	24 M	-	31.03.2012
441	System CTC-SAR-EMI Cable Loss	System EMI field (SAR)	-	ETS	12 M	5	31.08.2011
442	System CTC-SAR-EMS	System EMS field (SAR)	-	ETS-	12 M	5	30.04.2011
443	System CTC-FAR-EMI-Spuri	System CTC-FAR-EMI-	-	ETS-Lindgren/Cetecom	12 M	5	30.06.2011
444	System CTC FAR-EMS	System EMS-Field (FAR)	-	ETS Lindgren/Cetecom	12 M	5	30.05.2011
448	notch filter WCDMA FDD II	WRCT 1850.0/2170.0-	5	Wainwright Instruments	12 M	1c	30.05.2011
449	notch filter WCDMA FDD V	WRCT 824.0/894.0-5/40-	1	Wainwright Instruments	12 M	1c	30.05.2011
454	Oscilloscope	HM 205-3	9210 P 29661	Hameg	-	4	
455	Oscilloscope	HP 54602B	US 350 336 45	Hawlett Packard	-	4	
456	DC-Power supply 0-5A	EA 3013 S	207810	Elektro Automatik	pre-m	2	
459	DC -power supply 0-5 A , 0-32 V	EA-PS 2032-50	910722	Elektro Automatik	pre-m	2	
460	Univ. Radio Communication Tester	CMU 200	108901	Rohde & Schwarz	12 M	-	31.03.2011
462	AF-Generator	MX-2020	-	Conrad	-	4	
463	Universal source	HP3245A	2831A03472	Agilent	-	4	
466	digital multimeter	Fluke 112	89210157	Fluke USA	24 M	-	31.03.2012
467	digital multimeter	Fluke 112	89680306	Fluke USA	24 M	-	31.03.2012
468	digital multimeter	Fluke 112	90090455	Fluke USA	24 M	-	31.03.2012
477	ReRadiating GPS-System	AS-47	-	Automotive Cons. Fink	-	3	
480	power meter (Fula)	NRVS	838392/031	Rohde & Schwarz	24 M	-	31.03.2011
482	filtermatrix	FilterMatrix SAR 1	-	CETECOM (Brl)	-	1d	
484	pre-amplifier 2,5 - 18 GHz	AMF-5D-02501800-25-	1244554	Miteq	12 M	-	01.06.2011
487	System CTC NSA-Verification SAR-EMI	System EMI field (SAR)	-	ETS	12 M	-	30.09.2011
489	emi test receiver	ESU40	1000-30	Rohde & Schwarz	12 M	-	31.03.2011
491	ESD Simulator dito	ESD dito	dito307022	EM-Test	24 M	-	31.03.2011
498	Power Supply	NGPE 40/40	402	Rohde & Schwarz	-	2	
500	industry Acoustic System	MO 2000 Set	100048	Sennheiser	-	4	
502	band reject filter	WRCG 1709/1786-	SN 9	Wainwright	-	2	
503	band reject filter	WRCG 824/849-814/859-	SN 5	Wainwright	-	2	
517	relais swite matrix	HF Relais Box Keithley	SE 04	Keithley	-	2	
523	Digitalmultimeter	L4411A	MY46000154	Agilent	24 M	-	31.03.2011
524	Voltage Drop Simulator	VDS 200	0196-16	EM Test	24 M	-	31.03.2011
525	Koppelnetzwerk	CNA 200	1196-01	EM Test	24 M	-	31.03.2011
526	Burst Generator	EFT 200 A	0496-06	EM Test	24 M	-	31.03.2011
527	Micro Pulse Generator	MPG 200 B	0496-05	EM Test	24 M	-	31.03.2011
528	Load Dump Simulator	LD 200B	0496-06	EM Test	24 M	-	31.03.2011
533	Impedance Stabilization Network	ISN T200A	25706	Teseq	12 M	-	31.03.2011

Ref.-No.	Equipment	Type	Serial-No.	Manufacturer	Interval of calibration	Remark	Cal due
534	Impedance Stabilization Network	ISN T400A	Teseq	12 M	-	31	
535	Impedance Stabilization Network	ISN T800	26321	Teseq	12 M	-	31.03.2011
536	Impedance Stabilization Network	ISN ST08	25867	Teseq	12 M	-	31.03.2011
541	Impedance Stabilization Network	ISN T8-Cat6	26373	Teseq Berlin	12 M	-	31.03.2011
547	Univ. Radio Kommunikation Tester	CMU 200	835390/014	Rohde & Schwarz	12 M	-	31.03.2011
548	Digital-Barometer	GBP 2300	without	Greisinger GmbH	36/12 M	-	31.03.2012
549	Log.Per-Antenna	HL025	1000060	Rohde & Schwarz	36/12 M	-	31.03.2012
552	high pass filter 2.8-18GHz	WHKX 2.8/18G-10SS	4	Wainwright	12 M	-	30.06.2011
558	System CTC FAR S-VSWR	System CTC FAR S-	-	CTC	24 M	-	31.08.2011
574	Biconilog Hybrid Antenna	BTA-L	980026L	Frankonia	36/12 M	-	30.03.2013
584	Spectrum Analyzer	FSU 8	100248	Rohde & Schwarz	12 M	-	31.03.2012
592	CDN-HDMI	CDN-HDMI	A3029004	Frankonia / Dr.Hubert	12 M	-	31.03.2011
594	Kommunikation Tester	CMW500	101757	Rohde & Schwarz	24 M	-	31.03.2012
595	Analog Adder	TS8910	-	Rohde & Schwarz	pre-m	-	
598	Spectrum Analyser	FSEM 30	831259/013	Rohde & Schwarz	12 M	-	13.01.2011

### 6.1.3. Legend

Note / remarks		Calibrated during system calibration:
	1a	System CTC-SAR-EMS (Ref.-No. 442)
	1b	System-CTC-EMS-Conducted (Ref.-No. 335)
	1c	System CTC-FAR-EMI-spurious emission (Ref.-No . 443)
	1d	System CTC-SAR-EMI (Ref.-No . 441)
	1e	System CTC-OATS (EMI radiated) (Ref.-No. 337)
	1 f	System CTC-CTIA-OTA (Ref.-No . 420)
	1 g	System CTC-FAR-EMS (Ref.-No . 444)
	2	Calibration or equipment check immediately before measurement
	3	Regulatory maintained equipment for functional check or support purpose,
	4	Ancillary equipment without calibration e.g. mechanical equipment or monitoring equipment
	5	Test System

Interval of calibration	12 M	12 month
	24 M	24 month
	36 M	36 month
	24/12 M	Calibration every 24 months, between this every 12 months internal validation
	36/12 M	Calibration every 36 months, between this every 12 months internal validation
	Pre-m	Check before starting the measurement
	-	Without calibration