



TEST REPORT



DT&C Co., Ltd.

42, Yurim-ro, 154Beon-gil, Cheoin-gu, Yongin-si, Gyeonggi-do, Korea, 17042
Tel : 031-321-2664, Fax : 031-321-1664

1. Report No : DRTFCC1902-0044
2. Customer
 - Name : BLUEBIRD INC.
 - Address : (Dogok-dong, SEI Tower 13,14) 39, Eonjuro30-gil, Gangnam-gu, Seoul South Korea
3. Use of Report : FCC Original Grant
4. Product Name / Model Name : Enterprise Full Touch Handheld Computer / EF501
FCC ID : SS4EF501X
5. Test Method Used : KDB971168 D01v03, ANSI/TIA-603-E-2016, ANSI C63.26-2015
Test Specification : §2, §22(H), §24(E), §27
6. Date of Test : 2018.12.05 ~ 2019.01.24
7. Testing Environment : Refer to appended test report.
8. Test Result : Refer to attached test result.

Affirmation	Tested by	Reviewed by
	Name : JaeHyeok Bang 	Name : GeunKi Son  (Signature)

The test results presented in this test report are limited only to the sample supplied by applicant and the use of this test report is inhibited other than its purpose. This test report shall not be reproduced except in full, without the written approval of DT&C Co., Ltd.

2019 . 02 . 20 .

DT&C Co., Ltd.

If this report is required to confirmation of authenticity, please contact to report@dtnc.net

Test Report Version

Test Report No.	Date	Description
DRTFCC1902-0044	Feb. 20, 2019	Initial issue

Table of Contents

1. GENERAL INFORMATION	4
2. INTRODUCTION	5
2.1. EUT DESCRIPTION	5
2.2. EUT CAPABILITIES.....	5
2.3. TESTING ENVIRONMENT	5
2.4. MEASURING INSTRUMENT CALIBRATION	5
2.5. MEASUREMENT UNCERTAINTY	5
2.6. TEST FACILITY	5
3. DESCRIPTION OF TESTS.....	6
3.1 ERP & EIRP (Effective Radiated Power & Equivalent Isotropic Radiated Power)	6
3.2 PEAK TO AVERAGE RATIO	8
3.3 OCCUPIED BANDWIDTH (99 % Bandwidth)	10
3.4 SPURIOUS EMISSIONS AT ANTENNA TERMINAL	11
3.5 BAND EDGE EMISSIONS AT ANTENNA TERMINAL	12
3.6 RADIATED SPURIOUS EMISSIONS	13
3.7 FREQUENCY STABILITY / VARIATION OF AMBIENT TEMPERATURE.....	14
4. LIST OF TEST EQUIPMENT	15
5. SUMMARY OF TEST RESULTS.....	16
6. EMISSION DESIGNATOR AND SAMPLE CALCULATION....	17
7. TEST DATA	19
7.1 PEAK TO AVERAGE RATIO	19
7.2 OCCUPIED BANDWIDTH (99 % Bandwidth)	19
7.3 SPURIOUS MISSIONS AT ANTENNA TERMINAL.....	20
7.4 BAND EDGE EMISSIONS AT ANTENNA TERMINAL	20
7.5 EFFECTIVE RADIATED POWER.....	21
7.6 EQUIVALENT ISOTROPIC RADIATED POWER.....	22
7.7 RADIATED SPURIOUS EMISSIONS	23
7.8 FREQUENCY STABILITY / VARIATION OF AMBIENT TEMPERATURE.....	29
7.8.1 FREQUENCY STABILITY (WCDMA850)	29
7.8.2 FREQUENCY STABILITY (WCDMA1700)	30
7.8.3 FREQUENCY STABILITY (WCDMA1900)	31
8. TEST PLOTS	32
8.1 PEAK TO AVERAGE RATIO	32
8.2 OCCUPIED BANDWIDTH (99 % Bandwidth)	34
8.3 SPURIOUS EMISSIONS AT ANTENNA TERMINAL	46
8.4 BAND EDGE EMISSIONS AT ANTENNA TERMINAL.....	62

1. GENERAL INFORMATION

Applicant Name : Bluebird Inc.
Address : (Dogok-dong, SEI Tower 13,14) 39, Eonjuro30-gil, Gangnam-gu, Seoul South Korea
FCC ID : SS4EF501X
FCC Classification : PCS Licensed Transmitter held to ear (PCE)
EUT : Enterprise Full Touch Handheld Computer
Model Name : EF501
Add Model Name : EF501R
Supplying power : DC 3.80 V
Antenna Type : Internal Antenna

Mode	Tx Frequency (MHz)	Emission Designator	ERP (Max. Power)		EIRP (Max. Power)	
			dBm	W	dBm	W
WCDMA850	826.4 ~ 846.6	4M16F9W	21.18	0.131	-	-
HSUPA850	826.4 ~ 846.6	4M17F9W	20.17	0.104	-	-
WCDMA1700	1712.4 ~ 1752.6	4M15F9W	-	-	22.48	0.177
HSUPA1700	1712.4 ~ 1752.6	4M14F9W	-	-	21.79	0.151
WCDMA1900	1852.4 ~ 1907.6	4M12F9W	-	-	23.64	0.231
HSUPA1900	1852.4 ~ 1907.6	4M14F9W	-	-	23.14	0.206

2. INTRODUCTION

2.1. EUT DESCRIPTION

The Equipment Under Test (EUT) supports WCDMA/LTE Phone with Bluetooth, WLAN, NFC.

2.2. EUT CAPABILITIES

This EUT contains the following capabilities:

850/1700/1900 WCDMA/HSUPA, Multi-band LTE, 802.11b/g/n WLAN(2.4GHz),
802.11a/n/ac WLAN(5GHz), Bluetooth(BDR, EDR, LE), NFC.

2.3. TESTING ENVIRONMENT

Ambient Condition	
▪ Temperature	+20 °C ~ +24 °C
▪ Relative Humidity	41 % ~ 46 %

2.4. MEASURING INSTRUMENT CALIBRATION

The measuring equipment, which was utilized in performing the tests documented herein, has been calibrated in accordance with the manufacturer's recommendations for utilizing calibration equipment, which is traceable to recognized national standards.

2.5. MEASUREMENT UNCERTAINTY

The measurement uncertainties shown below were calculated in accordance with requirements of ANSI C63.4-2014. All measurement uncertainty values are shown with a coverage factor of $k = 2$ to indicate a 95 % level of confidence.

Parameter	Measurement uncertainty
Radiated Disturbance (Below 1 GHz)	5.1 dB (The confidence level is about 95 %, $k = 2$)
Radiated Disturbance (1 GHz ~ 18 GHz)	5.4 dB (The confidence level is about 95 %, $k = 2$)
Radiated Disturbance (Above 18 GHz)	5.3 dB (The confidence level is about 95 %, $k = 2$)

2.6. TEST FACILITY

DT&C Co., Ltd.		
The 3 m test site and conducted measurement facility used to collect the radiated data are located at the 42, Yurim-ro, 154beon-gil, Cheoin-gu, Yongin-si, Gyeonggi-do, Korea 17042. The test site complies with the requirements of § 2.948 according to ANSI C63.4-2014.		
- FCC MRA Accredited Test Firm No. : KR0034		
www.dtc.net		
Telephone	:	+ 82-31-321-2664
FAX	:	+ 82-31-321-1664

3. DESCRIPTION OF TESTS

3.1 ERP & EIRP (Effective Radiated Power & Equivalent Isotropic Radiated Power)

Test Set-up

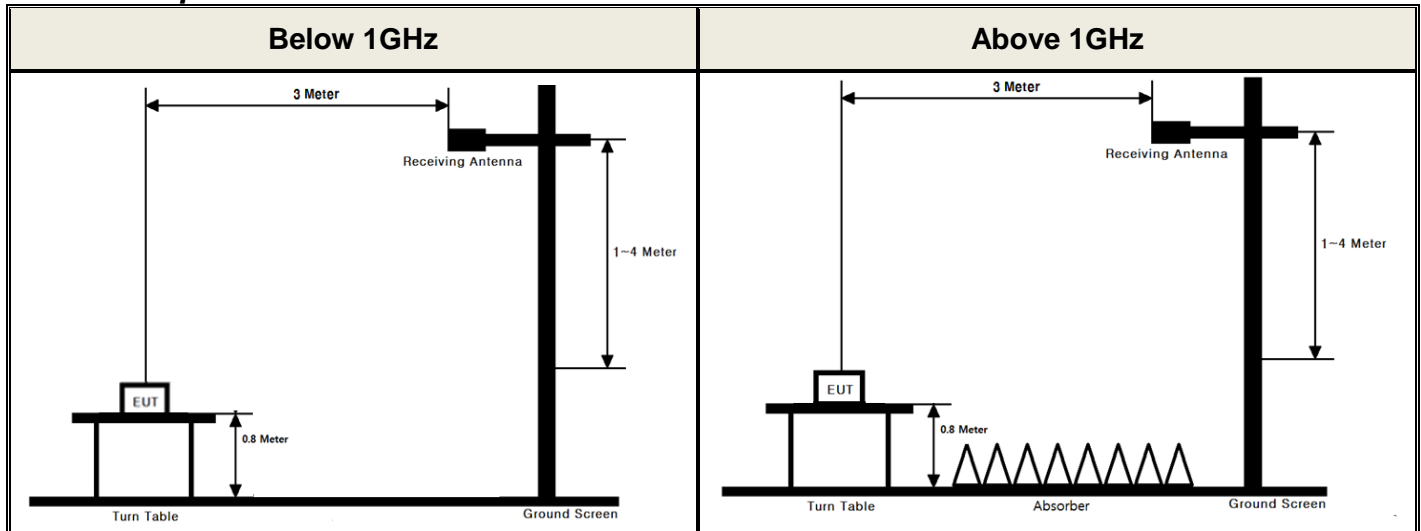

These measurements were performed at 3 m test site. The equipment under test is placed on a non-conductive table 0.8 meters above a turntable which is flush with the ground plane and 3 meters from the receive antenna. For measurements above 1 GHz absorbers are placed on the floor between the turn table and the antenna mast in such a way so as to maximize the reduction of reflections. For measurements below 1 GHz, the absorbers are removed.

Test Procedure

- ANSI/TIA-603-E-2016 - Section 2.2.17
- KDB971168 D01v03 - Section 5.2.2
- ANSI 63.26-2015 – Section 5.2.4.4.1

Test setting

1. Set span to 2 x to 3 x the OBW.
2. Set RBW = 1% to 5% of the OBW.
3. Set VBW \geq 3 x RBW.
4. Set number of points in sweep \geq 2 x span / RBW.
5. Sweep time:
 - 1) Set = auto-couple, or
 - 2) Set \geq [10 x (number of points in sweep) x (transmission period)] for single sweep (automation-compatible) measurement. Transmission period is the on and off time of the transmitter.
6. Detector = power averaging (rms).
7. If the EUT can be configured to transmit continuously, then set the trigger to free run.
8. If the EUT cannot be configured to transmit continuously, then use a sweep trigger with the level set to enable triggering only on full power bursts and configure the EUT to transmit at full power for the entire duration of each sweep. Verify that the sweep time is less than or equal to the transmission burst duration. Time gating can also be used under similar constraints (i.e., configured such that measurement data is collected only during active full-power transmissions).
9. Trace average at least 100 traces in power averaging (rms) mode if sweep is set to auto-couple. To accurately determine the average power over multiple symbols, it can be necessary to increase the number of traces to be averaged above 100 or, if using a manually configured sweep time, increase the sweep time.

10. Compute the power by integrating the spectrum across the OBW of the signal using the instrument's band or channel power measurement function, with the band/channel limits set equal to the OBW band edges. If the instrument does not have a band or channel power function, then sum the spectrum levels (in linear power units) at intervals equal to the RBW extending across the entire OBW of the spectrum.

The receiver antenna height and turntable rotations were adjusted for the highest reading on the receive spectrum analyzer.

A half-wave dipole was substituted in place of the EUT. This dipole antenna was driven by a signal generator and the level of the signal generator was adjusted to obtain the same receive spectrum analyzer reading. The conducted power at the terminal of the substitute antenna is measured.

The ERP/EIRP is calculated using the following formula:

ERP/EIRP = The conducted power at the substitute antenna's terminal [dBm] + Substitute Antenna gain [dBd for ERP, dBi for EIRP]

For readings above 1 GHz, the above procedure is repeated using horn antennas and the difference between the gain of the horn antenna and an isotropic antenna are taken into consideration.

3.2 PEAK TO AVERAGE RATIO

Test set-up

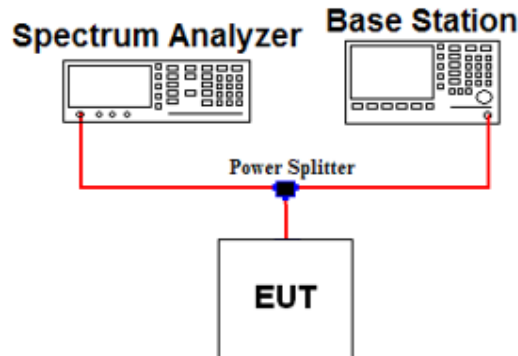

Test Procedure

- KDB971168 D01v03 - Section 5.7.2
- ANSI C63.26-2015 – Section 5.2.3.4

A peak to average ratio measurement is performed at the conducted port of the EUT.

The spectrum analyzers Complementary Cumulative Distribution Function (CCDF) measurement profile is used to determine the largest deviation between the average and the peak power of the EUT in a given bandwidth. The CCDF curve shows how much time the peak waveform spends at or above a given average power level. The present of time the signal spends at or above the level defines the probability for that particular power level.

Test setting

The spectrum Analyzer's CCDF measurement function is enabled.

1. Set resolution/measurement bandwidth \geq OBW or specified reference bandwidth.
2. Set the number of counts to a value that stabilizes the measured CCDF curve.
3. Set the measurement interval as follows:
 - 1) For continuous transmissions, set to the greater of $[10 \times (\text{number of points in sweep}) \times (\text{transmission symbol period})]$ or 1 ms.
 - 2) For burst transmissions, employ an external trigger that is synchronized with the EUT burst timing sequence, or use the internal burst trigger with a trigger level that allows the burst to stabilize. Set the measurement interval to a time that is less than or equal to the burst duration.
 - 3) If there are several carriers in a single antenna port, the peak power shall be determined for each individual carrier (by disabling the other carriers while measuring the required carrier) and the total peak power calculated from the sum of the individual carrier peak powers.
4. Record the maximum PAPR level associated with a probability of 0.1%.
5. The peak power level is calculated from the sum of the PAPR value from step d) to the measured average power.

■ Alternate Procedure

- KDB971168 D01v03 - Section 5.7.3
- ANSI C63.26-2015 – Section 5.2.6

Use one of the measurement procedures of the peak power and record as P_{Pk} .

Use one of the measurement procedures of the average power and record as P_{Avg} .

Both the peak and average power levels must be expressed in the same logarithmic units (e.g., dBm). Determine the PAPR from:

$$\text{PAPR (dB)} = P_{Pk} \text{ (dBm or dBW)} - P_{Avg} \text{ (dBm or dBW)}.$$

Where,

PAPR peak-to-average power ratio, in dB

P_{Pk} measured peak power or peak PSD level, in dBm or dBW

P_{Avg} measured average power or average PSD level, in dBm or dBW

- Peak Power Measurement

1. Set the RBW \geq OBW
2. Set VBW \geq 3 x RBW
3. Set span \geq 2 x RBW
4. Sweep time \geq 10 x (number of points in sweep) x (transmission symbol period).
5. Detector = peak
6. Trace mode = max hold
8. Allow trace to fully stabilize.
9. Use the peak marker function to determine the peak amplitude level.

- Average Power Measurement

1. Set span to 2 x to 3 x the OBW.
2. Set RBW = 1% to 5% of the OBW.
3. Set VBW \geq 3 x RBW.
4. Set number of measurement points in sweep \geq 2 \times span / RBW..
5. Sweep time = 1) auto-couple, or
2) set \geq [10 x (number of points in sweep) x (transmission period)] for single sweep (automation-compatible (measurement. Transmission period is the on and off time of the transmitter.
6. Detector = power averaging (RMS).
7. If the EUT can be configured to transmit continuously, then set the trigger to free run.
8. If the EUT cannot be configured to transmit continuously, then use a sweep trigger with the level set to enable Triggering only on full power bursts and configure the EUT to transmit at full power for the entire duration of each Sweep. Verify that the sweep time is less than or equal to the transmission burst duration. Time gating can also be used under similar constraints (i.e., configured such that measurement data is collected only during active full-Power transmissions)
9. Trace average at least 100 traces in power averaging (rms) mode if sweep is set to auto-couple. To accurately determine the average power over multiple symbols, it can be necessary to increase the number of traces to be averaged above 100 or, if using a manually configured sweep time, increase the sweep time.
10. Compute the power by integrating the spectrum across the OBW of the signal using the instrument's band or channel power measurement function, with the band/channel limits set equal to the OBW band edges. If the instrument does not have a band or channel power function, then sum the spectrum levels (in linear power units) at intervals equal to the RBW extending across the entire OBW of the spectrum.

3.3 OCCUPIED BANDWIDTH (99 % Bandwidth)

Test set-up

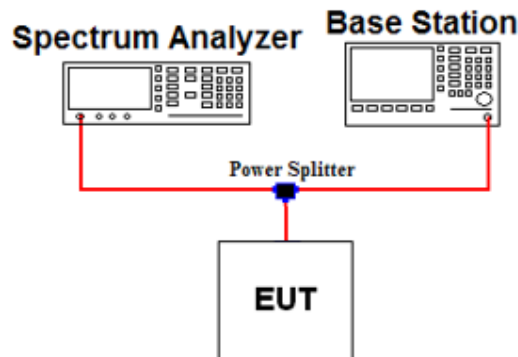

Offset value information

Frequency (MHz)	Offset Value (dB)	Frequency (MHz)	Offset Value (dB)
826.4	7.52	1852.4	8.32
836.6	7.53	1880	8.36
846.6	7.58	1907.6	8.36
1712.4	8.24	-	-
1732.4	8.25	-	-
1752.6	8.27	-	-

Note. 1: The offset values from EUT to Spectrum analyzer were measured and used for test.

Test Procedure

- KDB971168 D01v03 - Section 4.3
- ANSI C63.26-2015 – Section 5.4.4

The occupied bandwidth, that is the frequency bandwidth such that, below its lower and above its upper frequency limits, the mean powers radiated are each equal to 0.5 percent of the total mean power of a given emission.

Test setting

1. The signal analyzer's automatic bandwidth measurement capability was used to perform the 99 % occupied bandwidth and the 26 dB bandwidth. The bandwidth measurement was not influenced by any intermediate power nulls in the fundamental emission.
2. $RBW = 1 \sim 5 \%$ of the expected OBW & $VBW \geq 3 \times RBW$
3. Detector = Peak
4. Trace mode = Max hold
5. Sweep = Auto couple
6. The trace was allowed to stabilize
7. If necessary, step 2 ~ 6 were repeated after changing the RBW such that it would be within 1 ~ 5 % of the 99 % occupied bandwidth observed in step 6.

3.4 SPURIOUS EMISSIONS AT ANTENNA TERMINAL

Test set-up

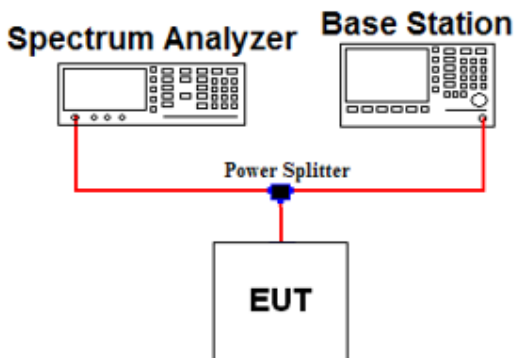

Offset value information

Frequency (MHz)	Offset Value (dB)	Frequency (MHz)	Offset Value (dB)
10000	10.13	20000	11.81
-	-	-	-

Note. 1: The offset value from EUT to Spectrum analyzer was measured and used for test.

Test Procedure

- KDB971168 D01v03 - Section 6
- ANSI C63.26-2015 - Section 5.7

The level of the carrier and the various conducted spurious and harmonic frequencies is measured by means of a calibrated spectrum analyzer. The EUT was setup to maximum output power at its low, middle, high channel with all bandwidths. The spectrum is scanned from 9 kHz up to a frequency including its 10th harmonic.

The power of any spurious emission shall be attenuated below the transmitter power (P) by at least $43 + 10 \log(P)$ dB, where P is the transmitter power in Watts.

Test setting

1. RBW = 100 kHz(Below 1 GHz) or 1 MHz(Above 1 GHz) & VBW $\geq 3 \times$ RBW (Refer to Note 1)
2. Detector = RMS & Trace mode = Max hold
3. Sweep time = Auto couple
4. Number of sweep point $\geq 2 \times$ span / RBW
5. The trace was allowed to stabilize

Note 1: Compliance with these provisions is based on the use of measurement instrumentation employing a resolution bandwidth of 100 kHz or greater for Part 22 and 1 MHz or greater for Part 24, 27

3.5 BAND EDGE EMISSIONS AT ANTENNA TERMINAL

Test set-up

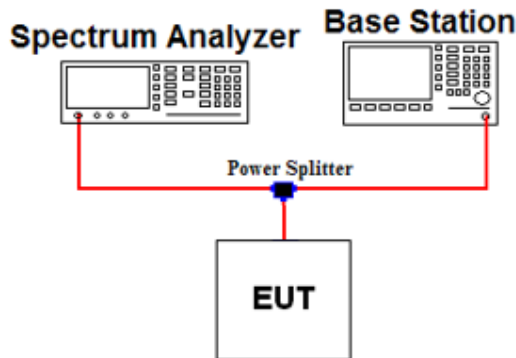

Offset value information

Frequency (MHz)	Offset Value (dB)	Frequency (MHz)	Offset Value (dB)
819-824	7.52	1845-1849	8.32
849-854	7.60	1850	8.33
1701-1710	8.24	1910-1915	8.38
1755-1764	8.27	-	-

Note. 1: The offset value from EUT to Spectrum analyzer was measured and used for test.

Test Procedure

- KDB971168 D01v03 - Section 6
- ANSI C63.26-2015 - Section 5.7

All out of band emissions are measured by means of a calibrated spectrum analyzer. The EUT was setup to maximum output power at its lowest and highest channel with all modulations.

The power of any spurious emission shall be attenuated below the transmitter power (P) by at least $43 + 10 \log(P)$ dB, where P is the transmitter power in Watts.

Test setting

1. Start and stop frequency were set such that the band edge would be placed in the center of the plot
2. Span was set large enough so as to capture all out of band emissions near the band edge
3. RBW $\geq 1\%$ of the emission
4. VBW $\geq 3 \times$ RBW
5. Detector = RMS & Trace mode = Max hold
6. Sweep time = Auto couple or 1 s for band edge
7. Number of sweep point $\geq 2 \times$ span / RBW
8. The trace was allowed to stabilize

Note 1: In the 1 MHz bands immediately outside and adjacent to the frequency block a resolution bandwidth of **at least one percent** of the emission bandwidth of the fundamental emission of the transmitter may be employed to demonstrate compliance with the out-of-band emissions limit.

The emission bandwidth is defined as the width of the signal between two points, one below the carrier center frequency and one above the carrier center frequency, outside of which all emission are attenuated at least 26 dB below the transmitter power.

3.6 RADIATED SPURIOUS EMISSIONS

Test Set-up

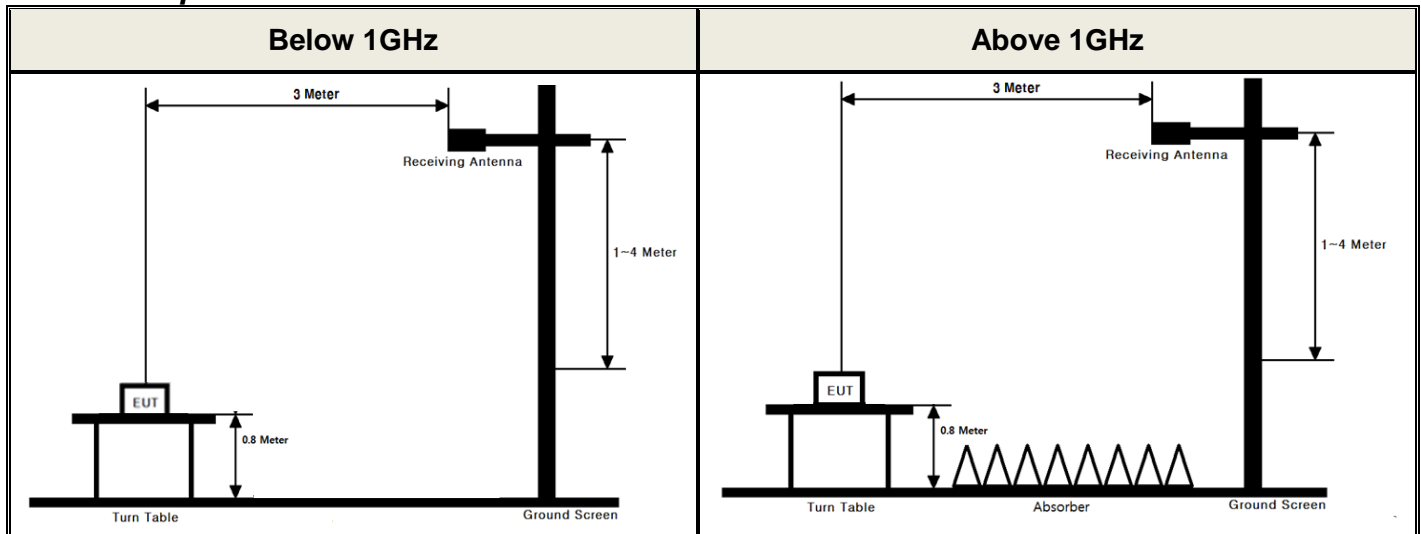

These measurements were performed at 3 m test site. The equipment under test is placed on a non-conductive table 0.8-meters above a turntable which is flush with the ground plane and 3 meters from the receive antenna. For measurements above 1 GHz absorbers are placed on the floor between the turn table and the antenna mast in such a way so as to maximize the reduction of reflections. For measurements below 1 GHz, the absorbers are removed.

Test Procedure

- ANSI/TIA-603-E-2016 - Section 2.2.12
- KDB971168 D01v03 - Section 5.8
- ANSI C63.26-2015 - Section 5.5

Test setting

1. RBW = 100 kHz for below 1 GHz and 1 MHz for above 1 GHz / VBW \geq 3 X RBW
2. Detector = RMS & Trace mode = Max hold
3. Sweep time = Auto couple
4. Number of sweep point \geq 2 X span / RBW
5. The trace was allowed to stabilize

The receive antenna height and turntable rotations were adjusted for the highest reading on the receive spectrum analyzer.

For radiated spurious emission measurements below 1 GHz, a half-wave dipole was substituted in place of the EUT. This dipole antenna was driven by a signal generator and the level of the signal generator was adjusted to obtain the same spectrum analyzer reading.

For radiated spurious emission measurements above 1 GHz, a Horn antenna was substituted in place of the EUT. This Horn antenna was driven by a signal generator and the level of the signal generator was adjusted to obtain the same spectrum analyzer reading. The difference between the gain of the horn and an isotropic antenna are taken into consideration.

3.7 FREQUENCY STABILITY / VARIATION OF AMBIENT TEMPERATURE

Test Set-up

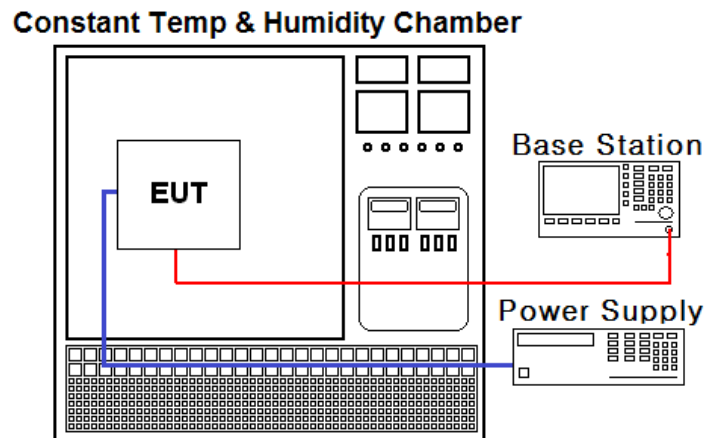

Test Procedure

- ANSI/TIA-603-E-2016
- KDB971168 D01v03 - Section 9

The frequency stability of the transmitter is measured by:

- a.) **Temperature:**
The temperature is varied from - 30 °C to + 50 °C in 10 °C increments using an environmental chamber.
- b.) **Primary Supply Voltage:**
The primary supply voltage is varied from 85 % to 115 % of the nominal value for non hand-carried battery and AC powered equipment. For hand-carried, battery-powered equipment, primary supply voltage is reduced to the battery operating end point which shall be specified by the manufacturer.

Specification:

The frequency stability shall be sufficient to ensure that the fundamental emission stays within the authorized frequency block for Part 24, 27. The frequency stability of the transmitter shall be maintained within $\pm 0.00025\%$ (± 2.5 ppm) of the center frequency for Part 22.

Time Period and Procedure:

1. The carrier frequency of the transmitter is measured at room temperature.
(20 °C to provide a reference)
2. The equipment is turned on in a "standby" condition for one minute before applying power to the transmitter. Measurement of the carrier frequency of the transmitter is made within one minute after applying power to the transmitter.
3. Frequency measurements are made at 10 °C intervals ranging from -30 °C to +50 °C.
A period of at least one half-hour is provided to allow stabilization of the equipment at each temperature level.

4. LIST OF TEST EQUIPMENT

Type	Manufacturer	Model	Cal.Date (yy/mm/dd)	Next.Cal. Date (yy/mm/dd)	S/N
Spectrum Analyzer	Agilent Technologies	N9020A	18/07/09	19/07/09	MY46471251
Spectrum Analyzer	Agilent Technologies	N9020A	18/12/20	19/12/20	MY50200828
DC power supply	Agilent Technologies	66332A	18/07/02	19/07/02	MY43001172
Multimeter	FLUKE	17B	17/12/26 18/12/18	18/12/26 19/12/18	26030065WS
Power Splitter	Anritsu	K241B	18/12/19	19/12/19	016681
Temp & Humi	SJ Science	SJ-TH-S50	18/07/06	19/07/06	U5542113
Radio Communication Analyzer	Agilent Technologies	E5515C	18/07/04	19/07/04	GB41321164
Thermohygrometer	BODYCOM	BJ5478	18/01/03 18/12/27	19/01/03 19/12/27	120612-2
Thermohygrometer	BODYCOM	BJ5478	18/01/03 18/12/27	19/01/03 19/12/27	120612-1
Signal Generator	Rohde Schwarz	SMBV100A	17/12/27 18/12/19	18/12/27 19/12/19	255571
Signal Generator	ANRITSU	SMF100A	18/06/07	19/06/07	102341
Loop Antenna	Schwarzbeck	FMZB1513	18/01/30	20/01/30	1513-128
Bilog Antenna	Schwarzbeck	VULB 9160	18/07/13	20/07/13	3359
Dipole Antenna	Schwarzbeck	VHA9103	17/03/14	19/03/14	2116
Dipole Antenna	Schwarzbeck	VHA9103	18/04/13	20/04/13	2117
Dipole Antenna	Schwarzbeck	UHA9105	17/03/14	19/03/14	2261
Dipole Antenna	Schwarzbeck	UHA9105	18/04/13	20/04/13	2262
HORN ANT	ETS	3117	18/05/10	20/05/10	00140394
HORN ANT	ETS	3117	18/03/26	20/03/26	00152145
HORN ANT	A.H.Systems	SAS-574	17/04/25	19/04/25	154
HORN ANT	A.H.Systems	SAS-574	17/07/31	19/07/31	155
Amplifier	EMPOWER	BBS3Q7ELU	18/07/10	19/07/10	1020
PreAmplifier	H.P	8447D	17/12/26 18/12/18	18/12/26 19/12/18	2944A07774
PreAmplifier	Agilent	8449B	18/07/05	19/07/05	3008A02108
High-pass filter	Wainwright	WHKX12-935-1000-15000-40SS	18/07/05	19/07/05	7
High-pass filter	Wainwright	WHKX12-2580-3000-18000-80SS	18/07/05	19/07/05	3
High-pass filter	Wainwright	WHNX8.5/26.5G-6SS	18/07/03	19/07/03	1
Cable	DTNC	Cable	18/07/06	19/07/06	M-01
Cable	DTNC	Cable	18/07/06	19/07/06	M-02
Cable	Junkosha	MWX315	18/11/19	19/11/19	M-05
Cable	Junkosha	MWX221	18/11/19	19/11/19	M-06
Cable	DTNC	Cable	18/07/05	19/07/05	RF-10
Cable	Radiall	TESTPRO3	18/07/05	19/07/05	RF-84

Note1: The measurement antennas were calibrated in accordance to the requirements of ANSI C63.5-2017.

Note2: The cable is not a regular calibration item, so it has been calibrated by DT & C itself.

5. SUMMARY OF TEST RESULTS

FCC Part Section(s)	Parameter	Status Note 1
2.1046	Conducted Output Power	C ^{Note2}
22.913(a) 24.232(c) 27.50(d.4)	Effective Radiated Power Equivalent Isotropic Radiated Power	C
2.1049	Occupied Bandwidth	C
2.1051 22.917(a) 24.238(a) 27.53(h)	Band Edge Emissions at Antenna Terminal Spurious Emissions at Antenna Terminal	C
24.232(d) 27.50(d.5)	Peak to Average Ratio	C
2.1053 22.917(a) 24.238(a) 27.53(h)	Radiated Spurious and Harmonic Emissions	C
2.1055 22.355 24.235 27.54	Frequency Stability	C
Note 1: C =Comply NC =Not Comply NT =Not Tested NA =Not Applicable Note 2: Refer to RF exposure report.		

6. EMISSION DESIGNATOR AND SAMPLE CALCULATION

A. Emission Designator

WCDMA850 Emission Designator

Emission Designator = **4M16F9W**
WCDMA OBW = 4.1645 MHz
(Measured at the 99.75 % power bandwidth)
F = Frequency Modulation
9 = Composite Digital Information
W = Combination (Audio/Data)

WCDMA1700 Emission Designator

Emission Designator = **4M15F9W**
WCDMA OBW = 4.1459 MHz
(Measured at the 99.75 % power bandwidth)
F = Frequency Modulation
9 = Composite Digital Information
W = Combination (Audio/Data)

HSUPA1700 Emission Designator

Emission Designator = **4M12F9W**
HSUPA OBW = 4.1177 MHz
(Measured at the 99.75 % power bandwidth)
F = Frequency Modulation
9 = Composite Digital Information
W = Combination (Audio/Data)

HSUPA850 Emission Designator

Emission Designator = **4M17F9W**
HSUPA OBW = 4.1701 MHz
(Measured at the 99.75 % power bandwidth)
F = Frequency Modulation
9 = Composite Digital Information
W = Combination (Audio/Data)

WCDMA1900 Emission Designator

Emission Designator = **4M14F9W**
WCDMA OBW = 4.1412 MHz
(Measured at the 99.75 % power bandwidth)
F = Frequency Modulation
9 = Composite Digital Information
W = Combination (Audio/Data)

HSUPA1900 Emission Designator

Emission Designator = **4M14F9W**
HSUPA OBW = 4.13610MHz
(Measured at the 99.75 % power bandwidth)
F = Frequency Modulation
9 = Composite Digital Information
W = Combination (Audio/Data)

B. For substitution method

EIRP for WCDMA1900

MODE	Channel	Freq.(MHz)	Spectrum Reading Value (dBm)	Ant Pol (H/V)	Level (dBm) @ Ant Terminal	TX Ant Gain (dBi)	Result	
							(dBm)	(W)
WCDMA1900	9262	1852.40	-24.62	H	18.69	4.95	23.64	0.231

ERP or EIRP = Level @ Ant Terminal LEVEL(dBm) + Tx Ant. Gain

- 1) The EUT mounted on a non-conductive turntable is 0.8 meter above test site ground level.
- 2) During the test, the turn table is rotated until the maximum signal is found.
- 3) Record the field strength meter's level.
- 4) Replace the EUT with dipole/Horn antenna that is connected to a calibrated signal generator.
- 5) Increase the signal generator output till the field strength meter's level is equal to the item (3).
- 6) The signal generator output level with substituted antenna gain is the rating of ERP, EIRP or Radiated spurious emission.

7. TEST DATA

7.1 PEAK TO AVERAGE RATIO

- Plots of the EUT's Peak- to- Average Ratio are shown in Clause 8.1

7.2 OCCUPIED BANDWIDTH (99 % Bandwidth)

Mode	Channel	Frequency(MHz)	Test Result (kHz)
WCDMA850	4132	826.4	4164.50
	4183	836.6	4146.90
	4233	846.6	4138.60
HSUPA850	4132	826.4	4170.10
	4183	836.6	4161.40
	4233	846.6	4162.30
WCDMA1700	1312	1712.4	4128.40
	1412	1732.4	4145.90
	1513	1752.6	4138.40
HSUPA1700	1312	1712.4	4113.70
	1412	1732.4	4141.20
	1513	1752.6	4113.20
WCDMA1900	9262	1852.4	4110.80
	9400	1880.0	4112.70
	9538	1907.6	4117.70
HSUPA1900	9262	1852.4	4132.20
	9400	1880.0	4130.70
	9538	1907.6	4136.10

7.3 SPURIOUS MISSIONS AT ANTENNA TERMINAL

- Plots of the EUT's Conducted Spurious Emissions are shown in Clause 8.3

7.4 BAND EDGE EMISSIONS AT ANTENNA TERMINAL

- Plots of the EUT's Band Edge are shown in Clause 8.4

7.5 EFFECTIVE RADIATED POWER

- WCDMA850 data

Mode	CH	Frequency (MHz)	Ant. Pol. (H/V)	LEVEL@ TX ANTENNA TERMINAL (dBm)	Antenna Gain (dBd)	ERP (dBm)	ERP (W)	Note.
WCDMA850	4132	826.4	H	19.95	1.23	21.18	0.131	-
WCDMA850	4183	836.6	H	19.09	1.22	20.31	0.107	-
WCDMA850	4233	846.6	H	19.75	1.21	20.96	0.125	-

- HSUPA850 data

Mode	CH	Frequency (MHz)	Ant. Pol. (H/V)	LEVEL@ TX ANTENNA TERMINAL (dBm)	Antenna Gain (dBd)	ERP (dBm)	ERP (W)	Note.
HSUPA850	4132	826.4	H	18.94	1.23	20.17	0.104	-
HSUPA850	4183	836.6	H	18.13	1.22	19.35	0.086	-
HSUPA850	4233	846.6	H	18.87	1.21	20.08	0.102	-

NOTES:

This EUT was tested under all configurations and the highest power is reported in WCDMA mode with HSDPA inactive at 12.2 kbps RMC and TPC bits set to "1". This EUT was tested with the fully charged battery. Also, we have done x, y, z planes in EUT and horizontal and vertical polarization of detecting antenna.

The worst case data is reported.

7.6 EQUIVALENT ISOTROPIC RADIATED POWER

- WCDMA1700 data

Mode	CH	Frequency (MHz)	Ant. Pol. (H/V)	LEVEL@ TX ANTENNA TERMINAL (dBm)	Antenna Gain (dBi)	EIRP (dBm)	EIRP (W)	Note.
WCDMA1700	1312	1712.4	H	16.17	6.02	22.19	0.166	-
WCDMA1700	1412	1732.4	H	16.32	5.84	22.16	0.164	-
WCDMA1700	1513	1752.6	H	16.83	5.65	22.48	0.177	-

- HSUPA1700 data

Mode	CH	Frequency (MHz)	Ant. Pol. (H/V)	LEVEL@ TX ANTENNA TERMINAL (dBm)	Antenna Gain (dBi)	EIRP (dBm)	EIRP (W)	Note.
HSUPA1700	1312	1712.4	H	15.39	6.02	21.41	0.138	-
HSUPA1700	1412	1732.4	H	15.06	5.84	20.90	0.123	-
HSUPA1700	1513	1752.6	H	16.14	5.65	21.79	0.151	-

- WCDMA1900 data

Mode	CH	Frequency (MHz)	Ant. Pol. (H/V)	LEVEL@ TX ANTENNA TERMINAL (dBm)	Antenna Gain (dBi)	EIRP (dBm)	EIRP (W)	Note.
WCDMA1900	9262	1852.4	H	18.69	4.95	23.64	0.231	-
WCDMA1900	9400	1880.0	H	18.74	4.80	23.54	0.226	-
WCDMA1900	9538	1907.6	H	18.13	4.65	22.78	0.190	-

- HSUPA1900 data

Mode	CH	Frequency (MHz)	Ant. Pol. (H/V)	LEVEL@ TX ANTENNA TERMINAL (dBm)	Antenna Gain (dBi)	EIRP (dBm)	EIRP (W)	Note.
HSUPA1900	9262	1852.4	H	18.19	4.95	23.14	0.206	-
HSUPA1900	9400	1880.0	H	18.04	4.80	22.84	0.192	-
HSUPA1900	9538	1907.6	H	17.40	4.65	22.05	0.160	-

NOTES:

This EUT was tested under all configurations and the highest power is reported in WCDMA mode with HSDPA inactive at 12.2 kbps RMC and TPC bits set to "1". This EUT was tested with the fully charged battery. Also, we have done x, y, z planes in EUT and horizontal and vertical polarization of detecting antenna.

The worst case data is reported.

7.7 RADIATED SPURIOUS EMISSIONS

- WCDMA850 data

Channel (ERP)	Tx Freq. (MHz)	Freq. (MHz)	POL (H/V)	LEVEL @ ANTENNA TERMINAL (dBm)	Substitute Antenna Gain (dBd)	Correct Generator Level (dBm)	Result (dBc)	Limit (dBc)
4132 (0.131 W)	826.4	1651.32	H	-50.90	3.82	-47.08	68.26	34.18
		-	-	-	-	-	-	
4183 (0.107 W)	836.6	1670.48	H	-55.59	3.89	-51.70	72.01	33.31
		-	-	-	-	-	-	
4233 (0.125 W)	846.6	1694.76	H	-54.81	3.96	-50.85	71.81	33.96
		-	-	-	-	-	-	

- Limit Calculation= $43 + 10 \log_{10}(\text{ERP [W]})$ [dBc]

- No other spurious and harmonic emissions were reported greater than listed emissions above table.

NOTES:

This EUT was tested under all configurations and the highest power is reported in WCDMA mode with HSDPA inactive at 12.2 kbps RMC and TPC bits set to "1". This EUT was tested with the fully charged battery. Also, we have done x, y, z planes in EUT and horizontal and vertical polarization of detecting antenna. The worst case data is reported.

- HSUPA850 data

Channel (ERP)	Tx Freq. (MHz)	Freq. (MHz)	POL (H/V)	LEVEL@ ANTENNA TERMINAL (dBm)	Substitute Antenna Gain (dBd)	Correct Generator Level (dBm)	Result (dBc)	Limit (dBc)
4132 (0.104 W)	826.4	1652.38	H	-52.43	3.83	-48.60	68.77	33.17
		-	-	-	-	-	-	
4183 (0.086 W)	836.6	1672.40	H	-55.82	3.89	-51.93	71.28	32.35
		-	-	-	-	-	-	
4233 (0.102 W)	846.6	1692.21	H	-55.43	3.96	-51.47	71.55	33.08
		-	-	-	-	-	-	

- Limit Calculation= $43 + 10 \log_{10}(\text{ERP [W]})$ [dBc]

- No other spurious and harmonic emissions were reported greater than listed emissions above table.

NOTES:

This EUT was tested under all configurations and the highest power is reported in WCDMA mode with HSDPA inactive at 12.2 kbps RMC and TPC bits set to "1". This EUT was tested with the fully charged battery. Also, we have done x, y, z planes in EUT and horizontal and vertical polarization of detecting antenna.

The worst case data is reported.

- WCDMA1700 data

Channel (EIRP)	Tx Freq. (MHz)	Freq. (MHz)	POL (H/V)	LEVEL@ ANTENNA TERMINAL (dBm)	Substitute Antenna Gain (dBi)	Correct Generator Level (dBm)	Result (dBc)	Limit (dBc)
1312 (0.166 W)	1712.4	3426.94	V	-54.43	8.02	-46.41	68.60	35.19
		-	-	-	-	-	-	
1412 (0.164 W)	1732.4	3462.38	V	-55.06	8.11	-46.95	69.11	35.16
		-	-	-	-	-	-	
1513 (0.177 W)	1752.6	3507.02	V	-55.84	8.22	-47.62	70.10	35.48
		-	-	-	-	-	-	

- Limit Calculation= $43 + 10 \log_{10}(\text{EIRP [W]})$ [dBc]

- No other spurious and harmonic emissions were reported greater than listed emissions above table.

NOTES:

This EUT was tested under all configurations and the highest power is reported in WCDMA mode with HSDPA inactive at 12.2 kbps RMC and TPC bits set to "1". This EUT was tested with the fully charged battery. Also, we have done x, y, z planes in EUT and horizontal and vertical polarization of detecting antenna.

The worst case data is reported.

- HSUPA1700 data

Channel (EIRP)	Tx Freq. (MHz)	Freq. (MHz)	POL (H/V)	LEVEL@ ANTENNA TERMINAL (dBm)	Substitute Antenna Gain (dBi)	Correct Generator Level (dBm)	Result (dBc)	Limit (dBc)
1312 (0.138 W)	1712.4	3424.77	V	-53.33	8.01	-45.32	66.73	34.41
		-	-	-	-	-	-	
1412 (0.123 W)	1732.4	3465.52	V	-53.97	8.12	-45.85	66.75	33.90
		-	-	-	-	-	-	
1513 (0.151 W)	1752.6	3504.56	V	-55.15	8.21	-46.94	68.73	34.79
		-	-	-	-	-	-	

- Limit Calculation= $43 + 10 \log_{10}(\text{EIRP [W]})$ [dBc]

- No other spurious and harmonic emissions were reported greater than listed emissions above table.

NOTES:

This EUT was tested under all configurations and the highest power is reported in WCDMA mode with HSDPA inactive at 12.2 kbps RMC and TPC bits set to "1". This EUT was tested with the fully charged battery. Also, we have done x, y, z planes in EUT and horizontal and vertical polarization of detecting antenna.

The worst case data is reported.

- WCDMA1900 data

Channel (EIRP)	Tx Freq. (MHz)	Freq. (MHz)	POL (H/V)	LEVEL@ ANTENNA TERMINAL (dBm)	Substitute Antenna Gain (dBi)	Correct Generator Level (dBm)	Result (dBc)	Limit (dBc)
9262 (0.231 W)	1852.4	3701.81	V	-54.39	8.38	-46.01	69.65	36.64
		-	-	-	-	-	-	
9400 (0.226 W)	1880.0	3758.32	V	-54.54	8.37	-46.17	69.71	36.54
		-	-	-	-	-	-	
9538 (0.190 W)	1907.6	3818.00	V	-55.19	8.22	-46.97	69.75	35.78
		-	-	-	-	-	-	

- Limit Calculation= $43 + 10 \log_{10}(\text{EIRP [W]})$ [dBc]

- No other spurious and harmonic emissions were reported greater than listed emissions above table.

NOTES:

This EUT was tested under all configurations and the highest power is reported in WCDMA mode with HSDPA inactive at 12.2 kbps RMC and TPC bits set to "1". This EUT was tested with the fully charged battery. Also, we have done x, y, z planes in EUT and horizontal and vertical polarization of detecting antenna.

The worst case data is reported.

- HSUPA1900 data

Channel (EIRP)	Tx Freq. (MHz)	Freq. (MHz)	POL (H/V)	LEVEL@ ANTENNA TERMINAL (dBm)	Substitute Antenna Gain (dBi)	Correct Generator Level (dBm)	Result (dBc)	Limit (dBc)
9262 (0.206 W)	1852.4	3706.05	V	-53.24	8.38	-44.86	68.00	36.14
		-	-	-	-	-	-	
9400 (0.192 W)	1880.0	3757.14	V	-54.60	8.37	-46.23	69.07	35.84
		-	-	-	-	-	-	
9538 (0.160 W)	1907.6	3815.44	V	-52.48	8.22	-44.26	66.31	35.05
		-	-	-	-	-	-	

- Limit Calculation= $43 + 10 \log_{10}(\text{EIRP [W]})$ [dBc]

- No other spurious and harmonic emissions were reported greater than listed emissions above table.

NOTES:

This EUT was tested under all configurations and the highest power is reported in WCDMA mode with HSDPA inactive at 12.2 kbps RMC and TPC bits set to "1". This EUT was tested with the fully charged battery. Also, we have done x, y, z planes in EUT and horizontal and vertical polarization of detecting antenna.

The worst case data is reported.

7.8 FREQUENCY STABILITY / VARIATION OF AMBIENT TEMPERATURE

7.8.1 FREQUENCY STABILITY (WCDMA850)

OPERATING FREQUENCY : 836,600,000_Hz
 CHANNEL : 4183(Mid)
 REFERENCE VOLTAGE : 3.80_V DC
 DEVIATION LIMIT : $\pm 0.00025\%$ or 2.5 ppm

VOLTAGE (%)	POWER (V DC)	TEMP (°C)	FREQ (Hz)	Deviation	
				(ppm)	(%)
100%	3.80	+20(Ref)	836,600,018	0.022	0.00000215
100%		-30	836,600,014	0.017	0.00000167
100%		-20	836,600,015	0.018	0.00000179
100%		-10	836,600,015	0.018	0.00000179
100%		0	836,600,016	0.019	0.00000191
100%		+10	836,600,013	0.016	0.00000155
100%		+20	836,600,018	0.022	0.00000215
100%		+30	836,600,018	0.022	0.00000215
100%		+40	836,600,013	0.016	0.00000155
100%		+50	836,600,021	0.025	0.00000251
115%	4.37	+20	836,600,013	0.016	0.00000155
BATT.ENDPOINT	3.60	+20	836,600,014	0.017	0.00000167

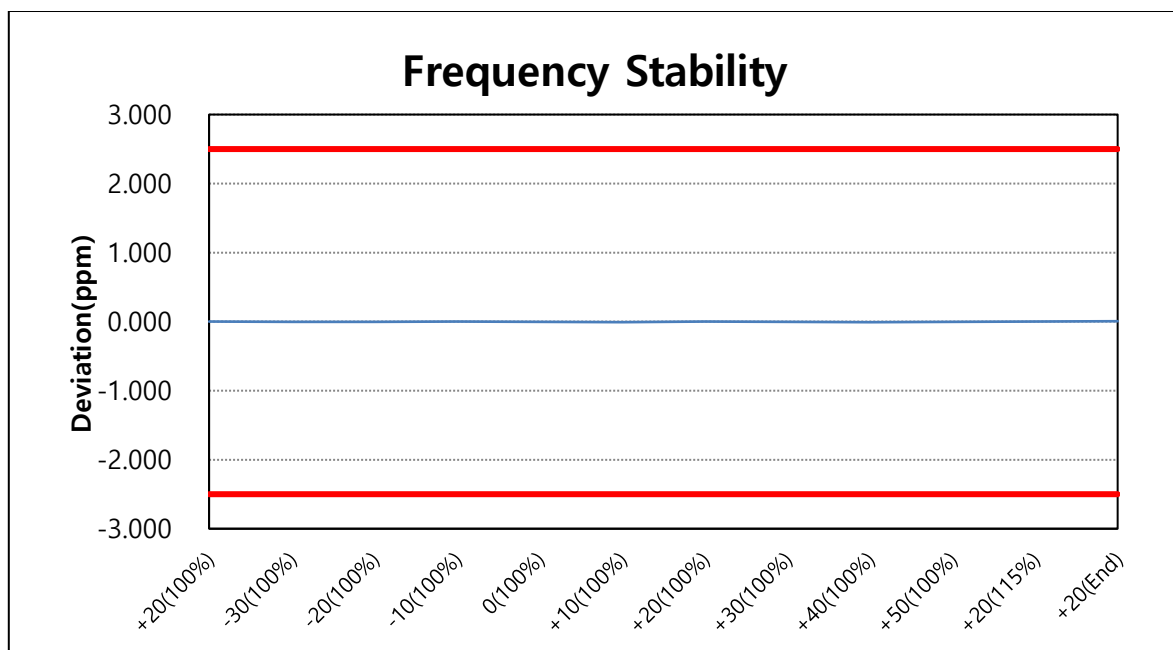

7.8.2 FREQUENCY STABILITY (WCDMA1700)

OPERATING FREQUENCY : 1,732,400,000 Hz
 CHANNEL : 1412(Mid)
 REFERENCE VOLTAGE : 3.80 V DC
 LIMIT : The frequency stability shall be sufficient to ensure that the fundamental emission stays within the authorized frequency block.

VOLTAGE (%)	POWER (V DC)	TEMP (°C)	FREQ (Hz)	Deviation	
				(ppm)	(%)
100%	3.80	+20(Ref)	1,732,400,013	0.008	0.00000075
100%		-30	1,732,400,016	0.009	0.00000092
100%		-20	1,732,400,022	0.013	0.00000127
100%		-10	1,732,400,017	0.010	0.00000098
100%		0	1,732,400,015	0.009	0.00000087
100%		+10	1,732,400,015	0.009	0.00000087
100%		+20	1,732,400,013	0.008	0.00000075
100%		+30	1,732,400,018	0.010	0.00000104
100%		+40	1,732,400,016	0.009	0.00000092
100%		+50	1,732,400,019	0.011	0.00000110
115%	4.37	+20	1,732,400,014	0.008	0.00000081
BATT.ENDPOINT	3.60	+20	1,732,400,012	0.007	0.00000069

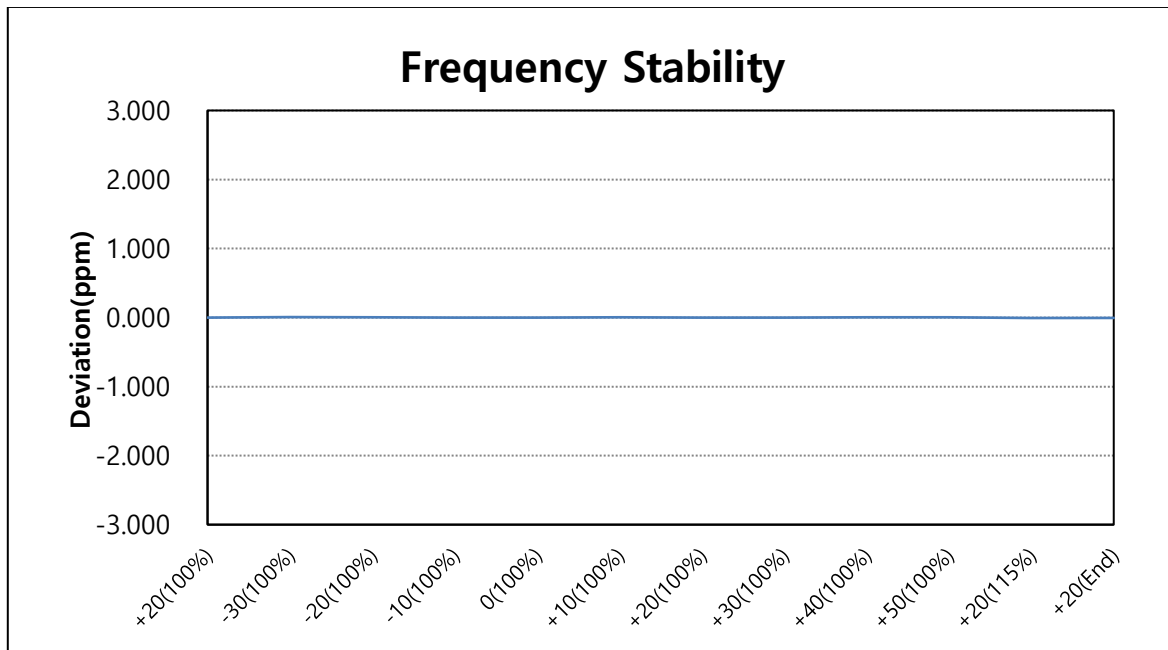

Note. Based on the results of the frequency stability test at the center channel the frequency deviation results measured are very small. As such it is determined that the channels at the band edge would remain inband when the maximum measured frequency deviation noted during the frequency stability tests is applied. Therefore the device is determined to remain operating in band over the temperature and voltage range as tested.

7.8.3 FREQUENCY STABILITY (WCDMA1900)

OPERATING FREQUENCY : 1,880,000,000 Hz
 CHANNEL : 9400(Mid)
 REFERENCE VOLTAGE : 3.80 V DC
 LIMIT : The frequency stability shall be sufficient to ensure that the fundamental emission stays within the authorized frequency block.

VOLTAGE (%)	POWER (V DC)	TEMP (°C)	FREQ (Hz)	Deviation	
				(ppm)	(%)
100%	3.80	+20(Ref)	1,880,000,021	0.011	0.00000112
100%		-30	1,880,000,014	0.007	0.00000074
100%		-20	1,880,000,018	0.010	0.00000096
100%		-10	1,880,000,014	0.007	0.00000074
100%		0	1,880,000,013	0.007	0.00000069
100%		+10	1,880,000,019	0.010	0.00000101
100%		+20	1,880,000,021	0.011	0.00000112
100%		+30	1,880,000,016	0.009	0.00000085
100%		+40	1,880,000,015	0.008	0.00000080
100%		+50	1,880,000,021	0.011	0.00000112
115%	4.37	+20	1,880,000,017	0.009	0.00000090
BATT.ENDPOINT	3.60	+20	1,880,000,015	0.008	0.00000080

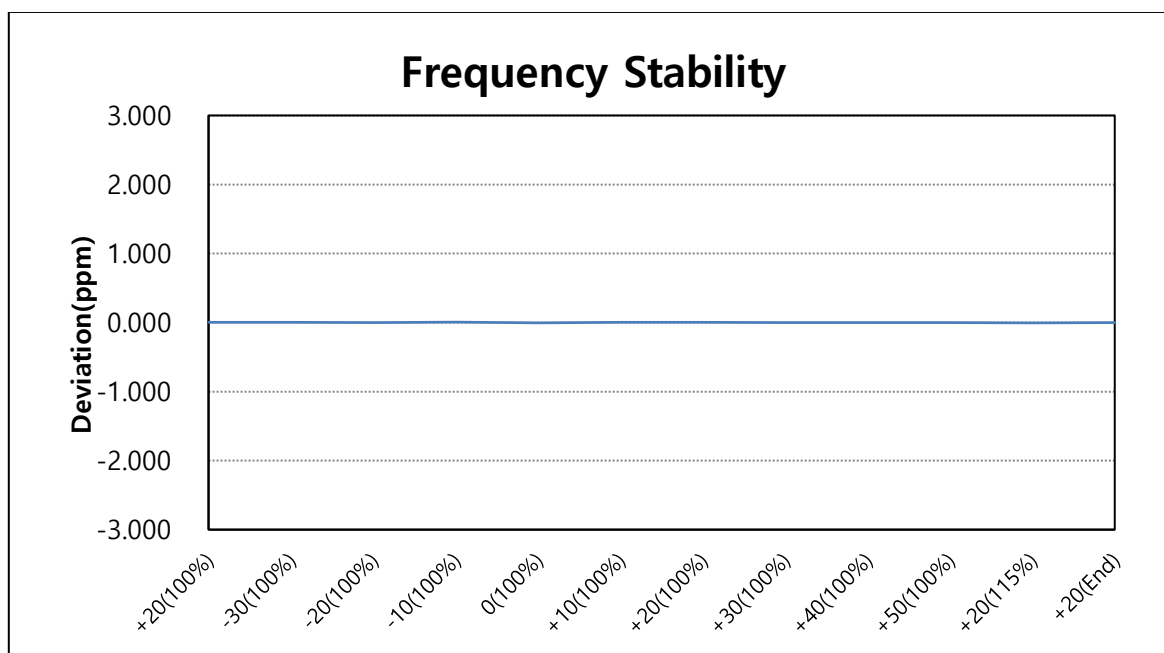

Note. Based on the results of the frequency stability test at the center channel the frequency deviation results measured are very small. As such it is determined that the channels at the band edge would remain inband when the maximum measured frequency deviation noted during the frequency stability tests is applied. Therefore the device is determined to remain operating in band over the temperature and voltage range as tested.

8. TEST PLOTS

8.1 PEAK TO AVERAGE RATIO

WCDMA1700 & Channel: 1412

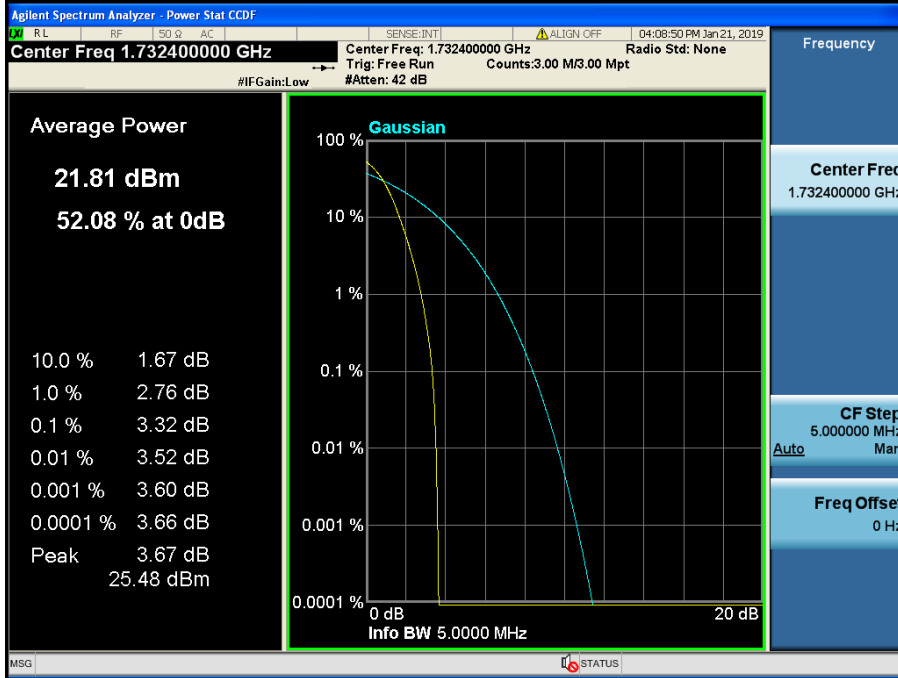

HSUPA1700 & Channel: 1412

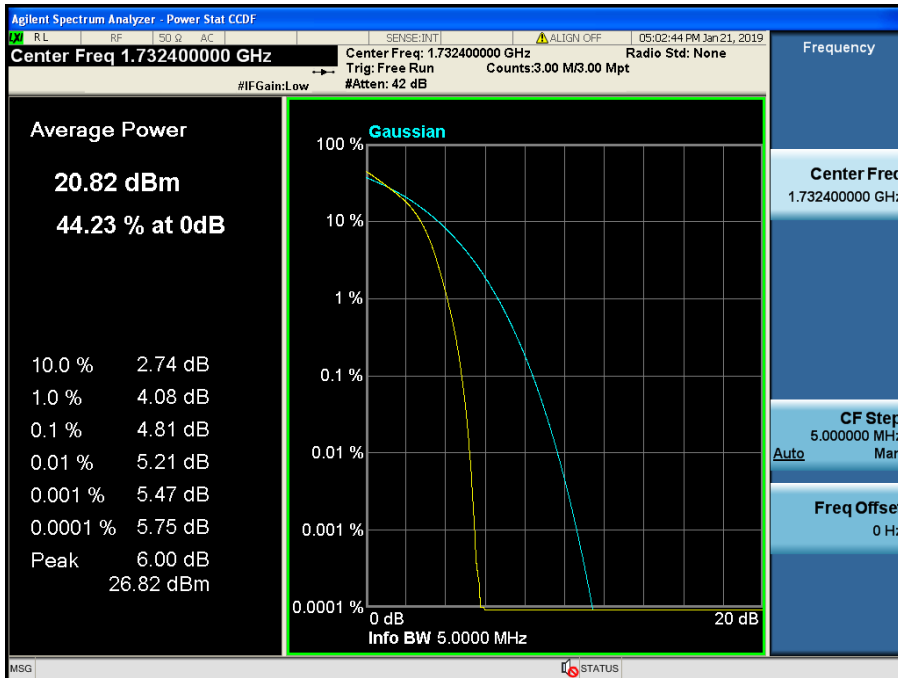

WCDMA1900 & Channel: 9400

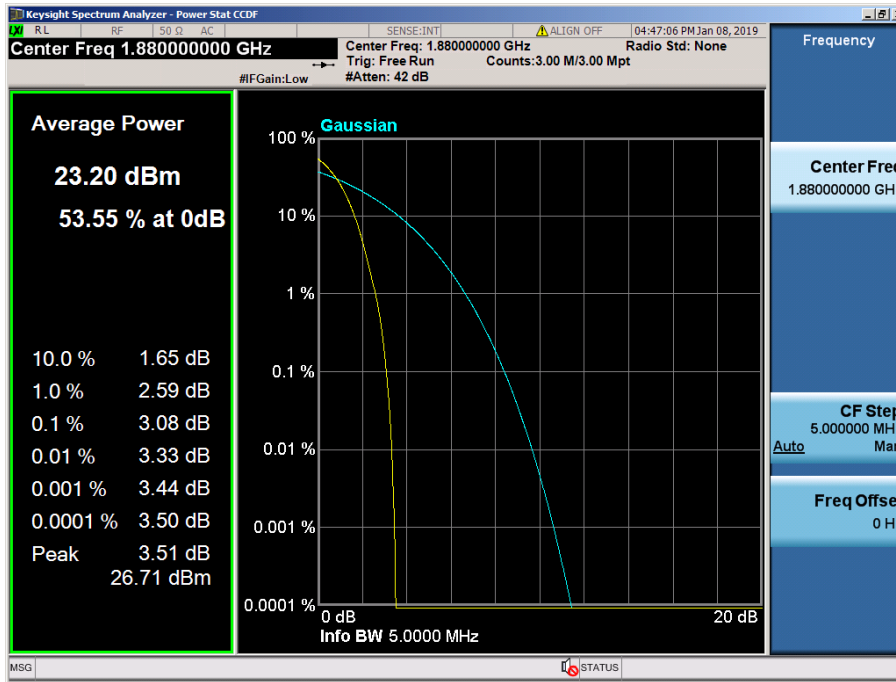

HSUPA1900 & Channel: 9400

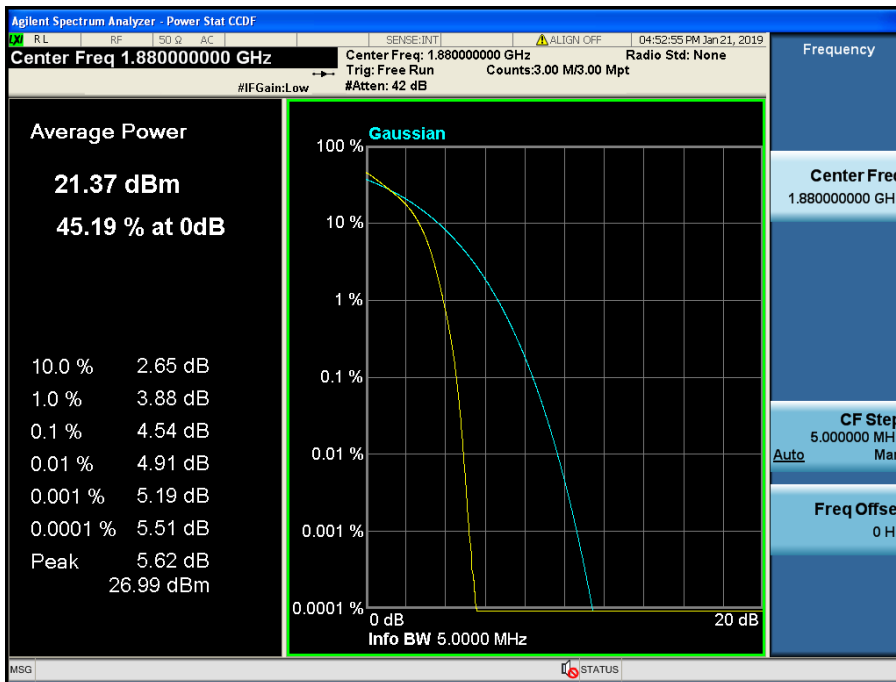

8.2 OCCUPIED BANDWIDTH (99 % Bandwidth)

WCDMA850 & Channel: 4132

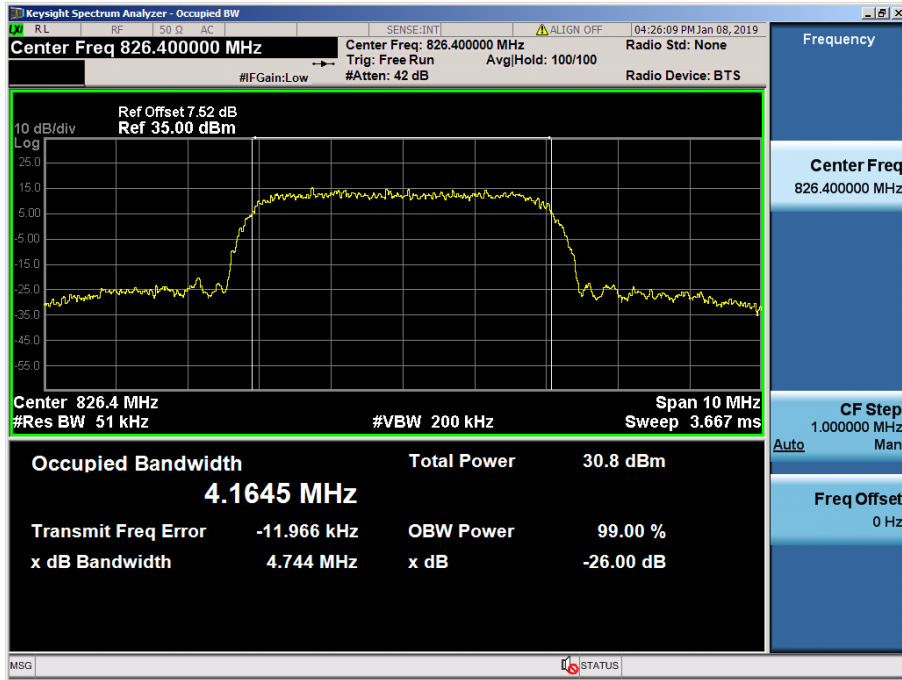

WCDMA850 & Channel: 4183

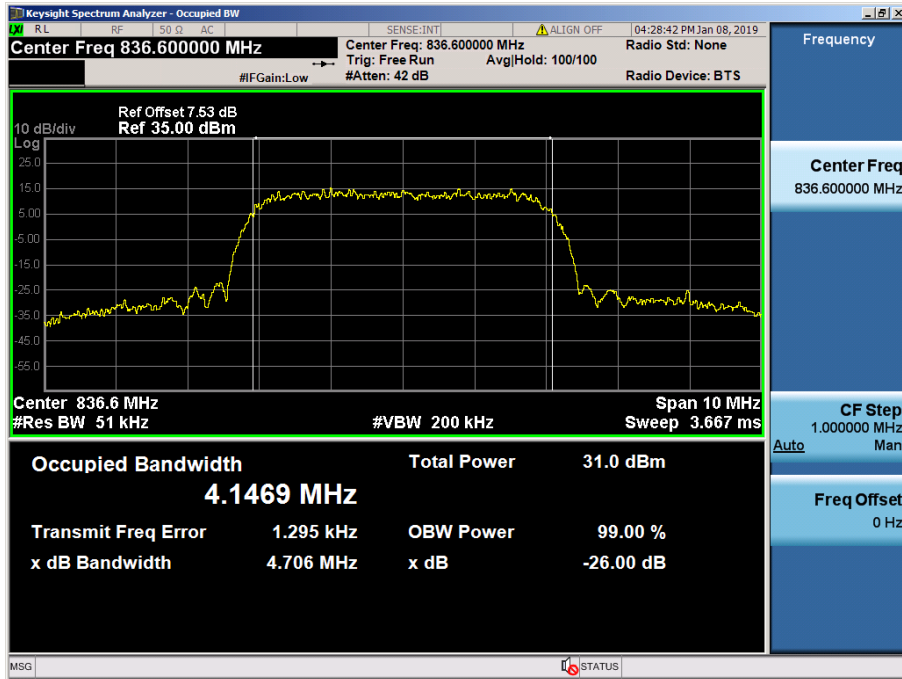

WCDMA850 & Channel: 4233

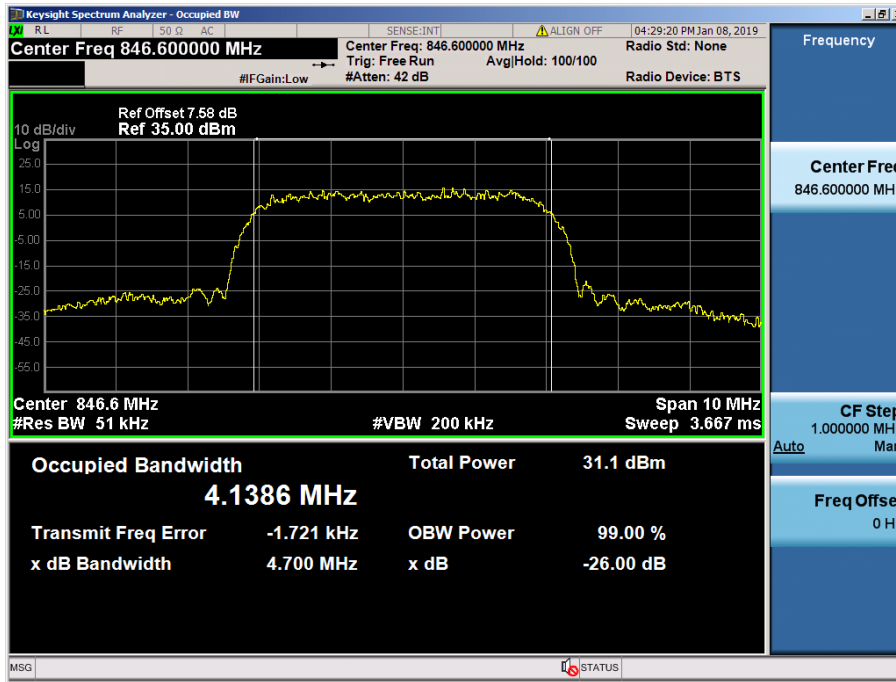

HSUPA850 & Channel: 4132

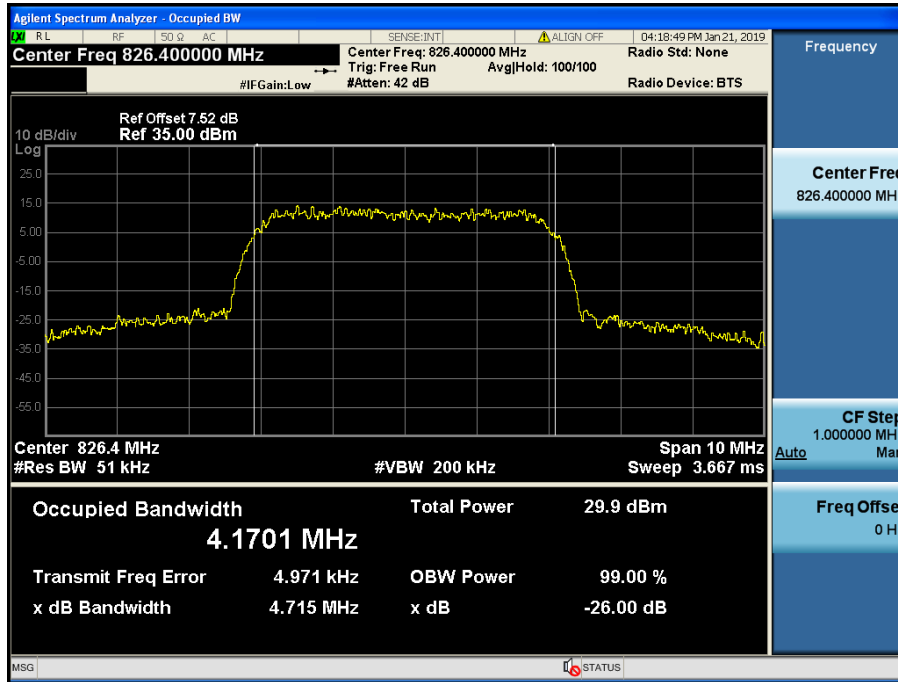

HSUPA850 & Channel: 4183

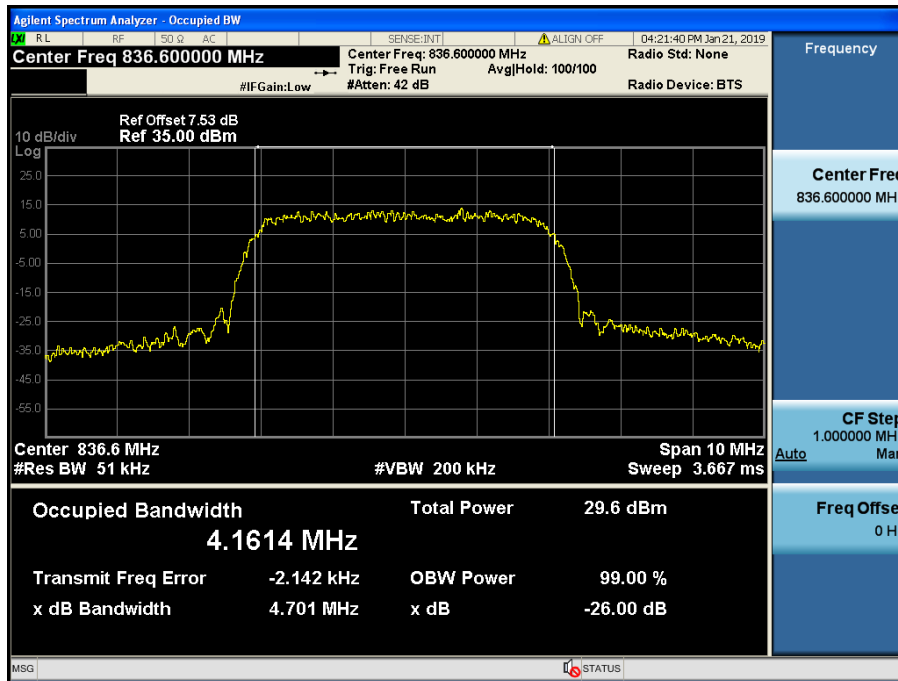

HSUPA850 & Channel: 4233

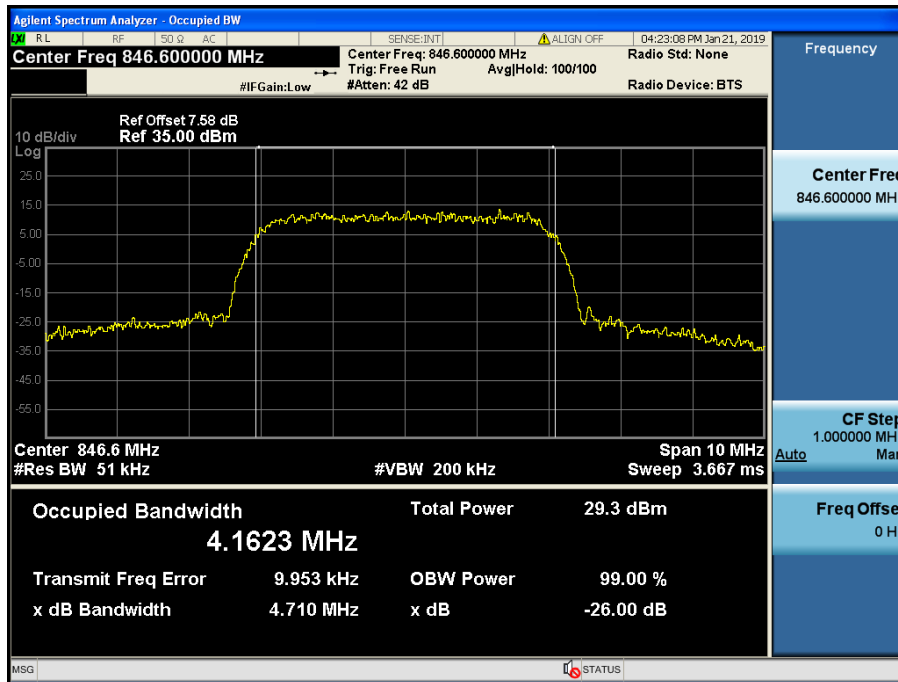

WCDMA1700 & Channel: 1312

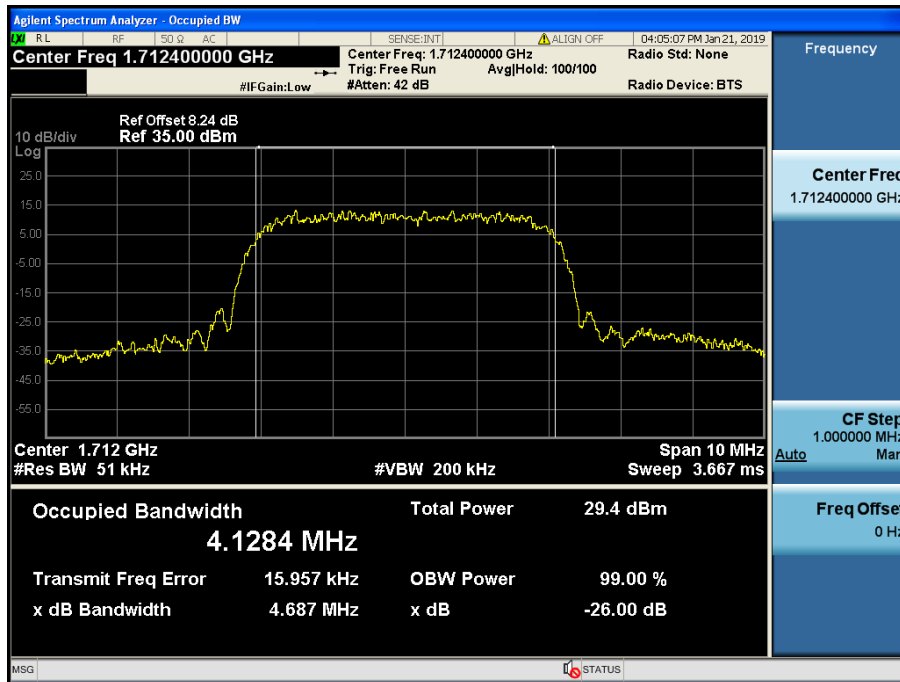

WCDMA1700 & Channel: 1412

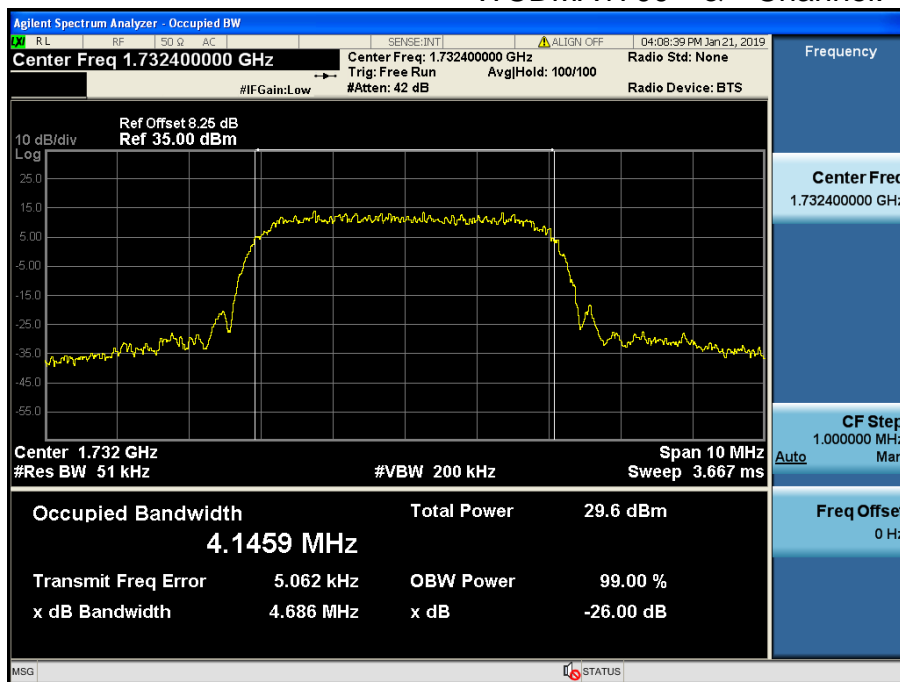

WCDMA1700 & Channel: 1513

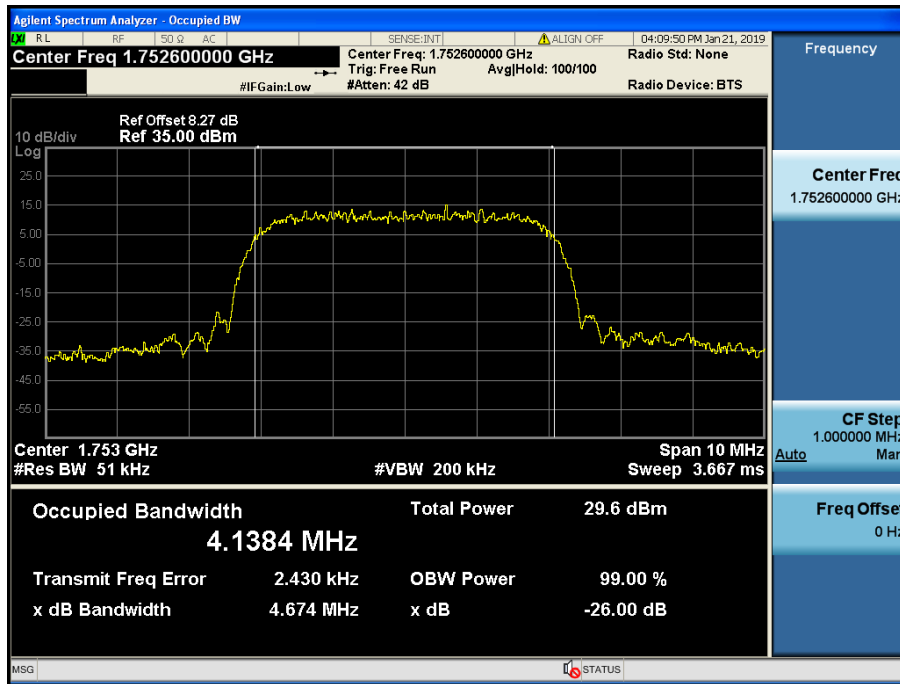

HSUPA1700 & Channel: 1312

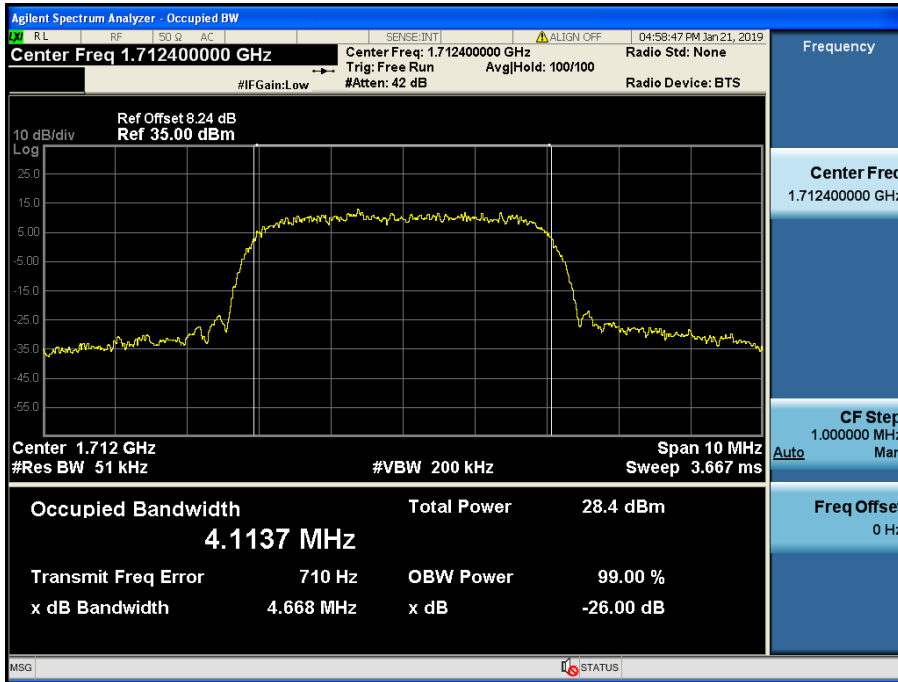

HSUPA1700 & Channel: 1412

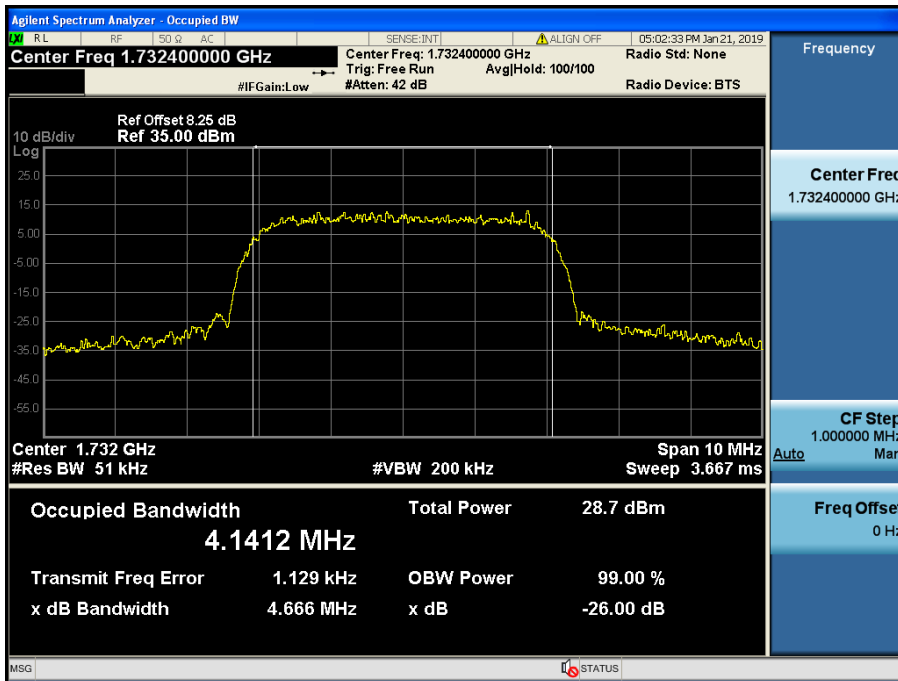

HSUPA1700 & Channel: 1513

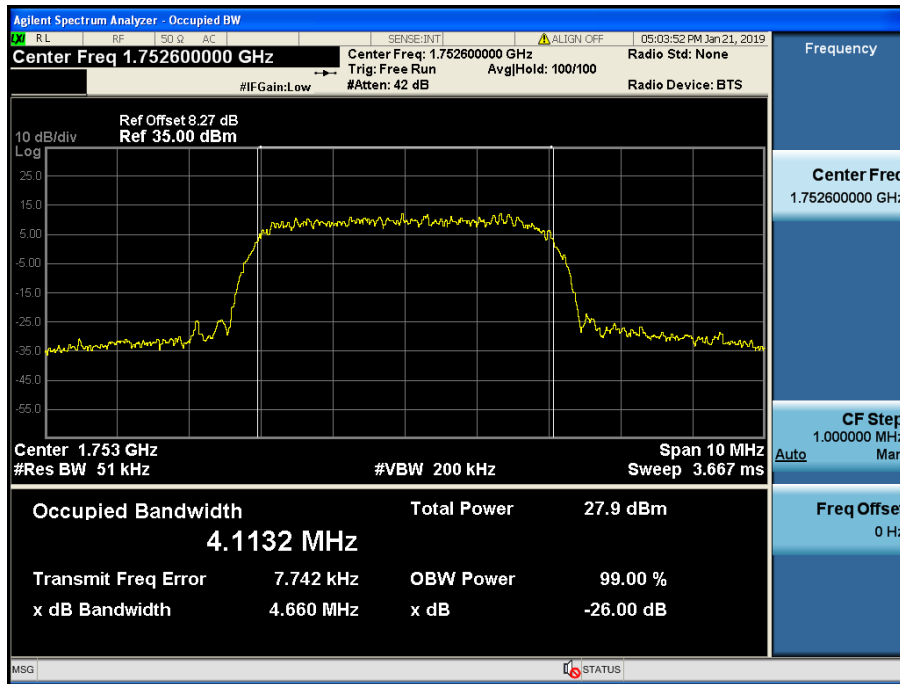

WCDMA1900 & Channel: 9262

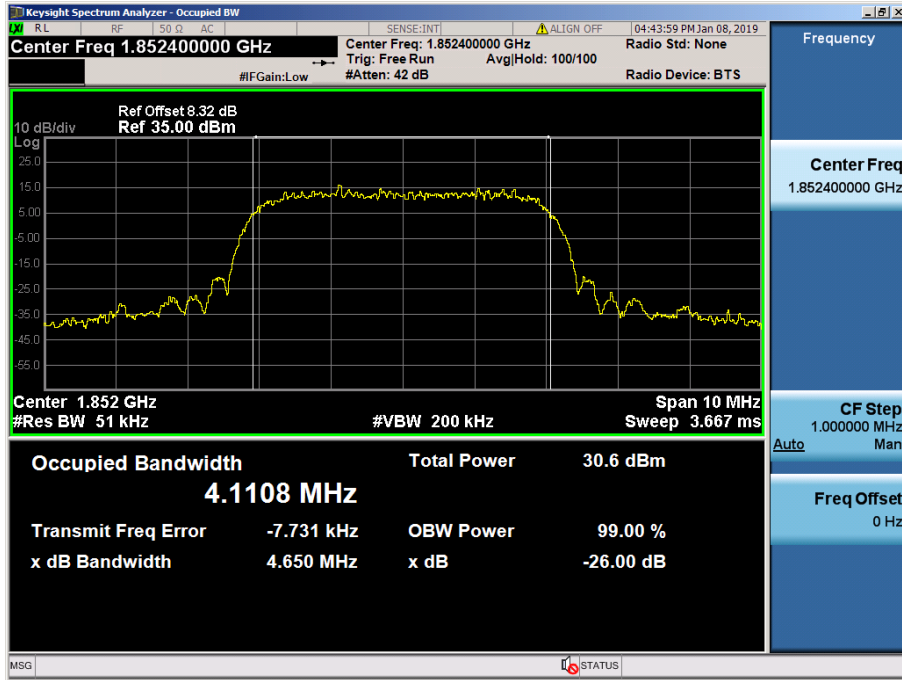

WCDMA1900 & Channel: 9400

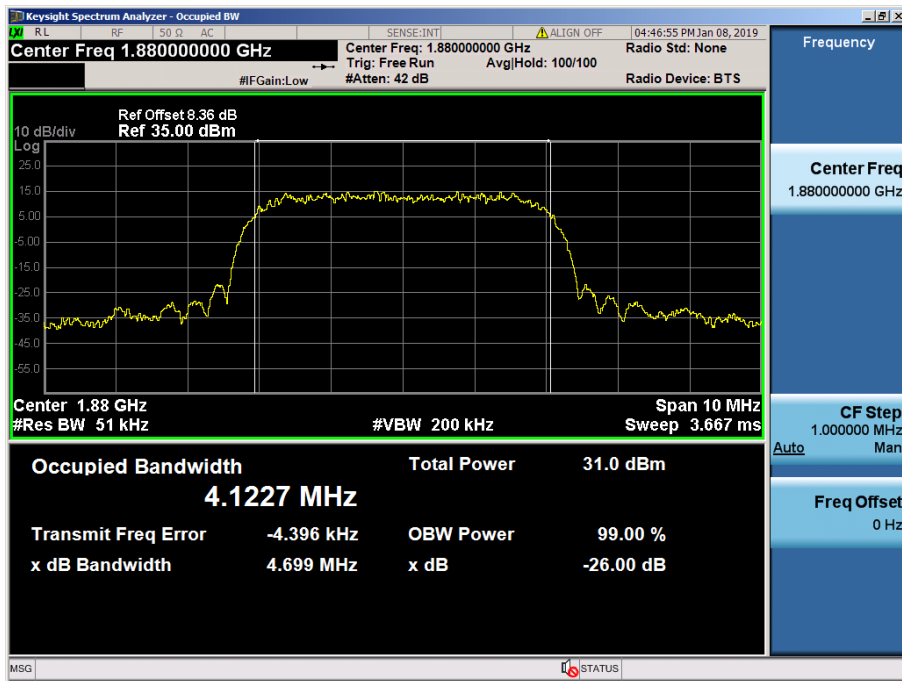

WCDMA1900 & Channel: 9538

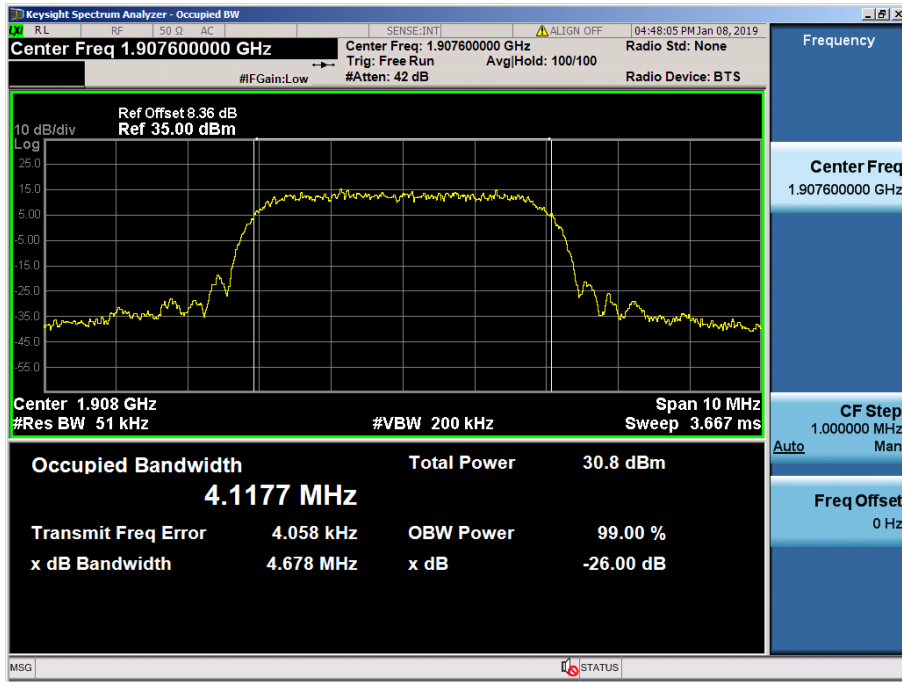

HSUPA1900 & Channel: 9262

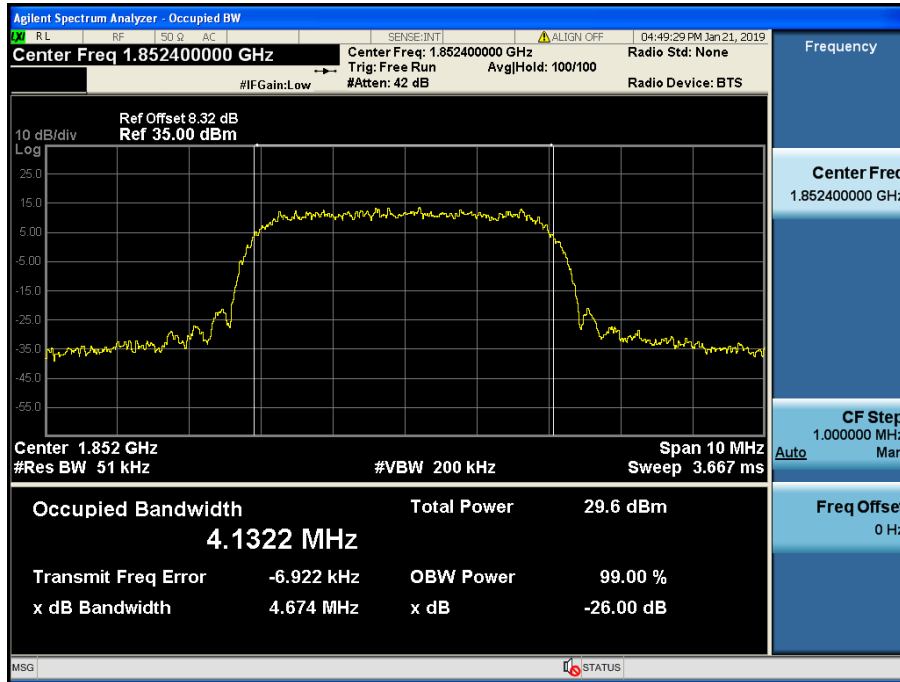

HSUPA1900 & Channel: 9400

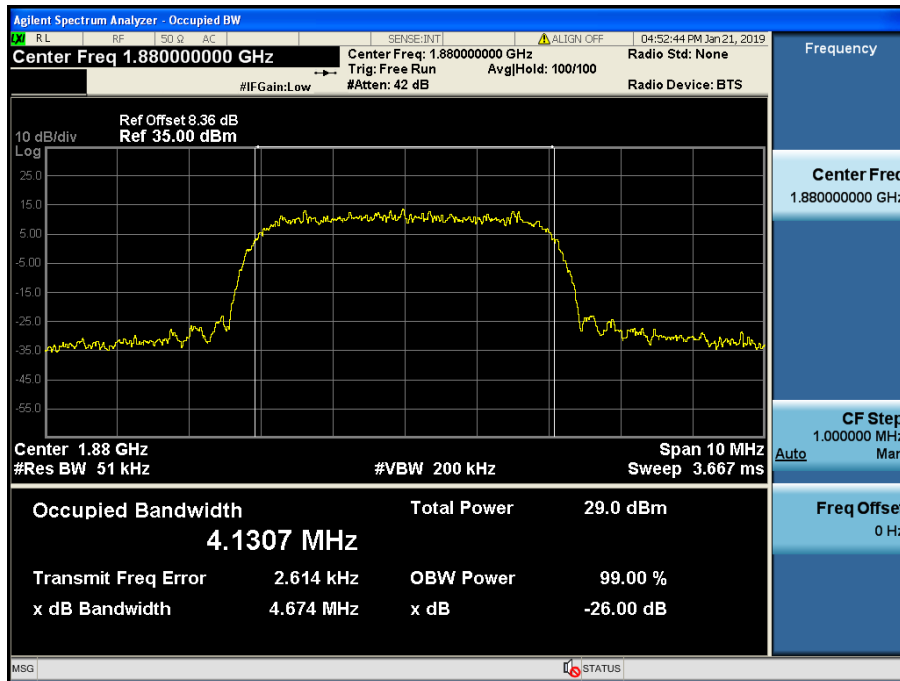

HSUPA1900 & Channel: 9538

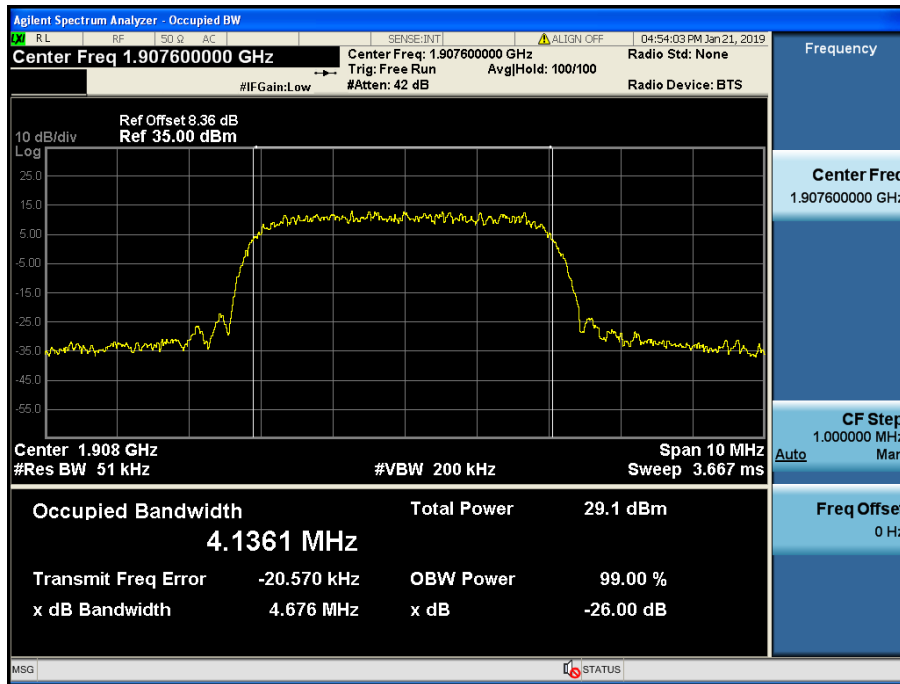

8.3 SPURIOUS EMISSIONS AT ANTENNA TERMINAL

WCDMA850 & Channel: 4132

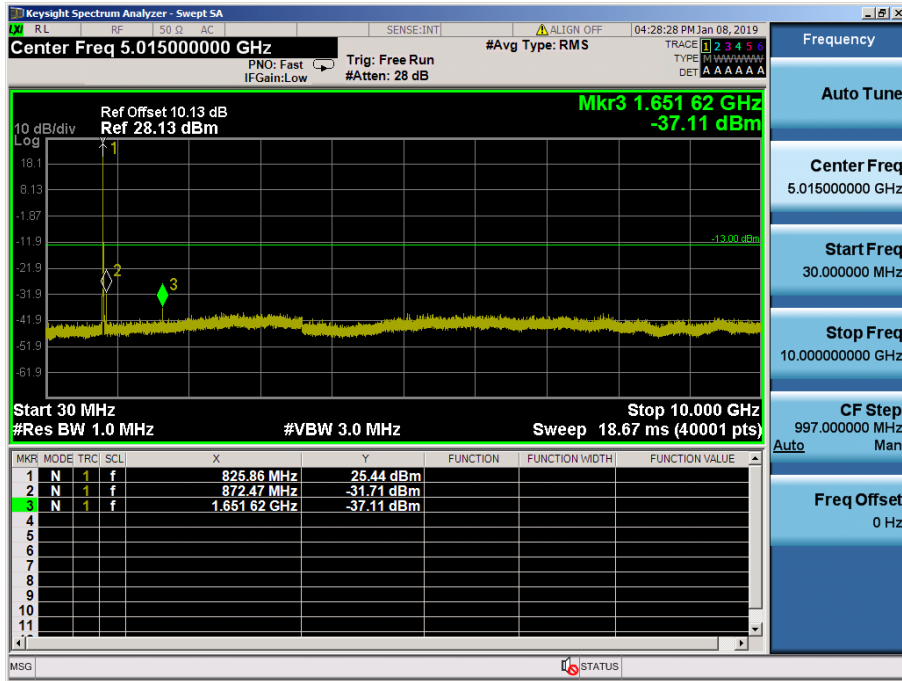

WCDMA850 & Channel: 4183

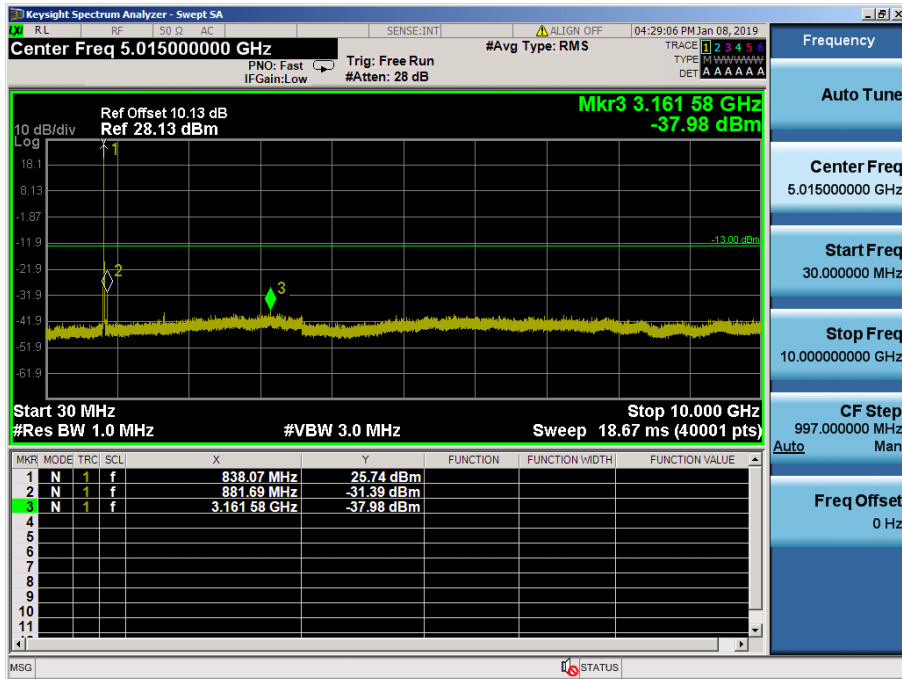

WCDMA850 & Channel: 4233

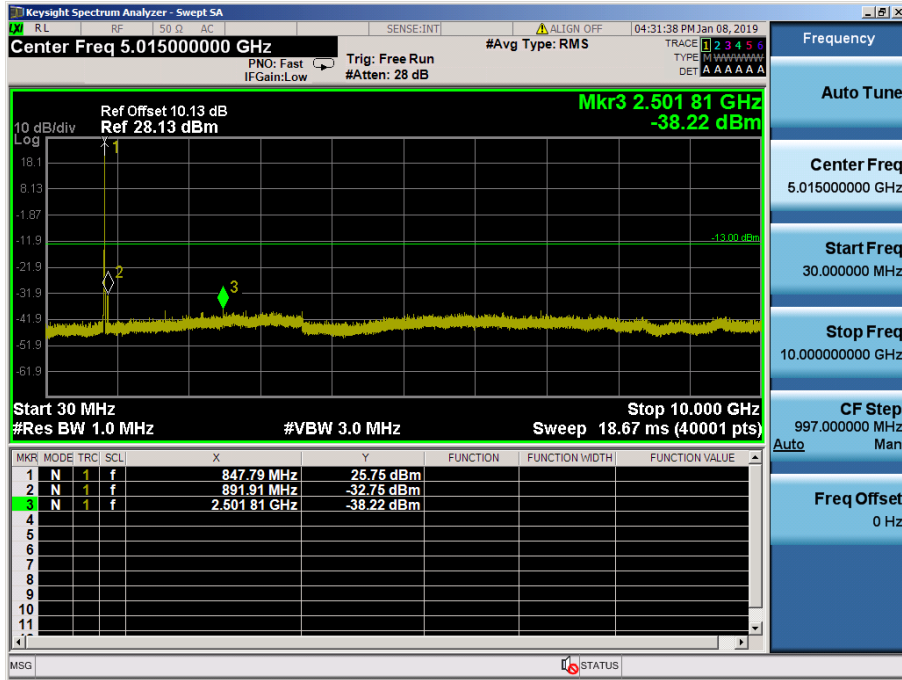

HSUPA850 & Channel: 4132

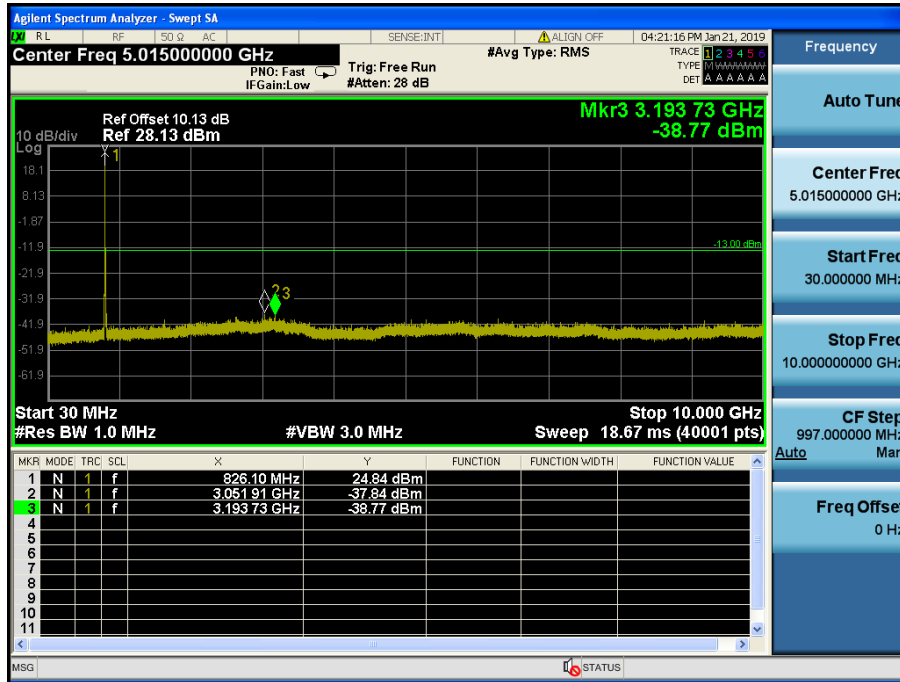

HSUPA850 & Channel: 4183

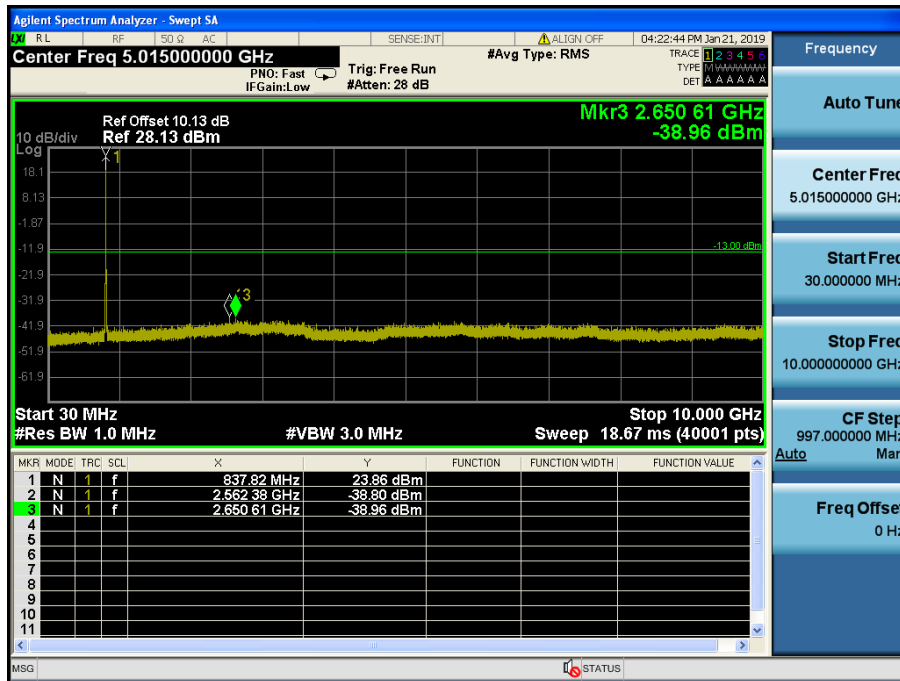

HSUPA850 & Channel: 4233

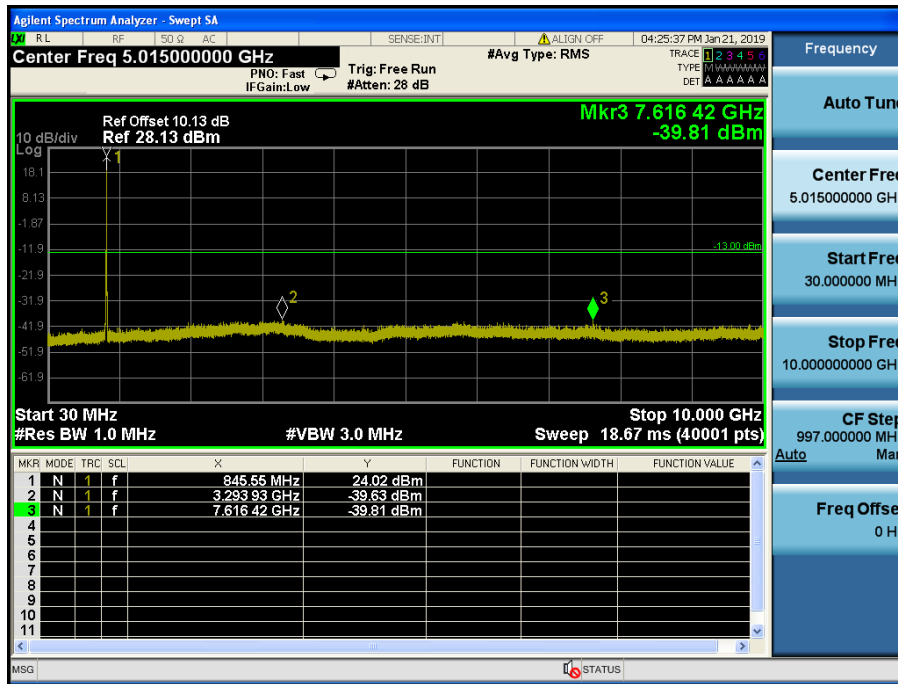

WCDMA1700 & Channel: 1312

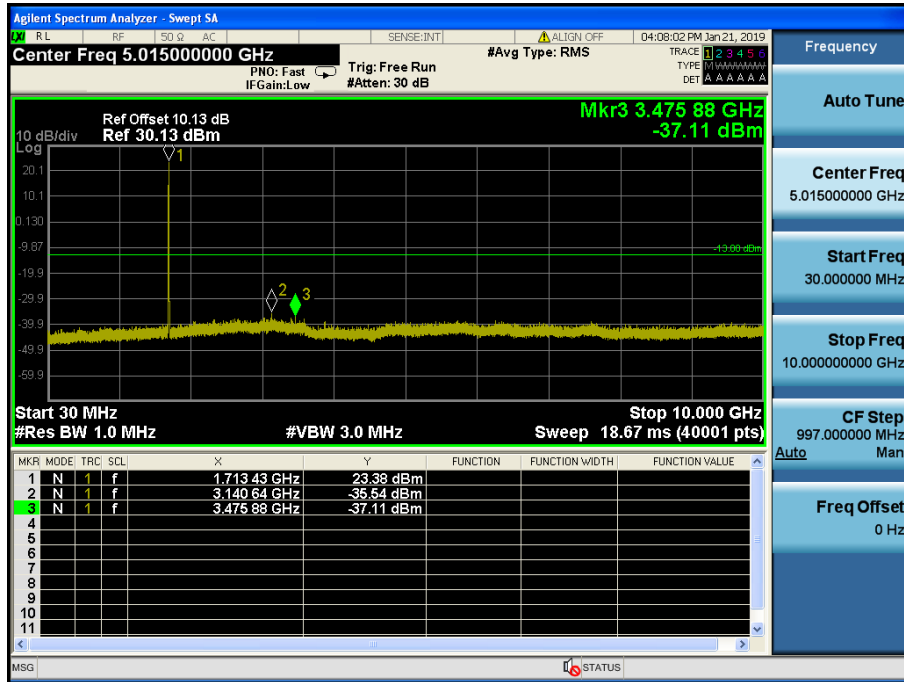

WCDMA1700 & Channel: 1312

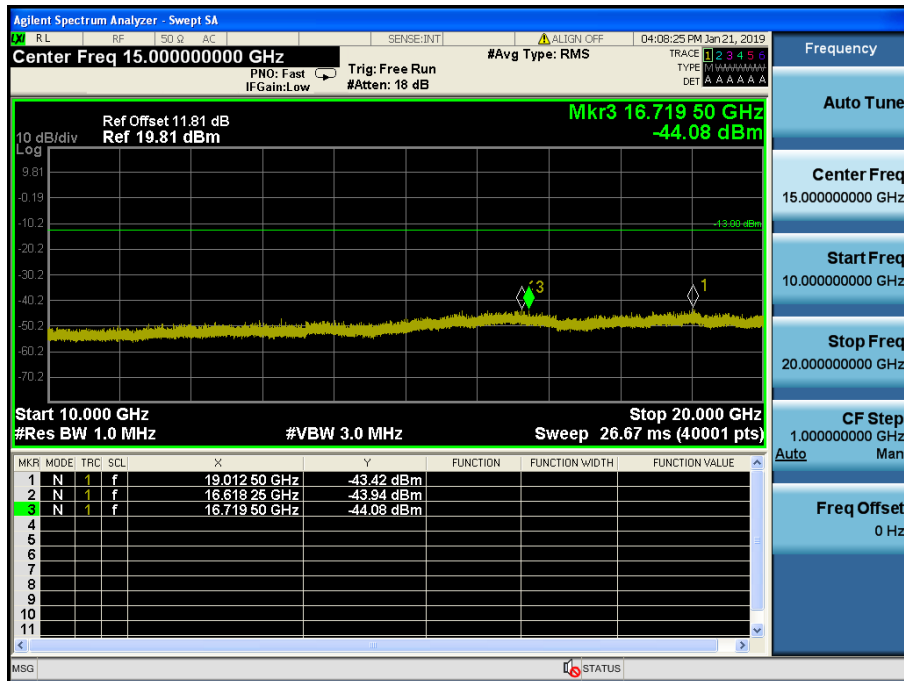

WCDMA1700 & Channel: 1412

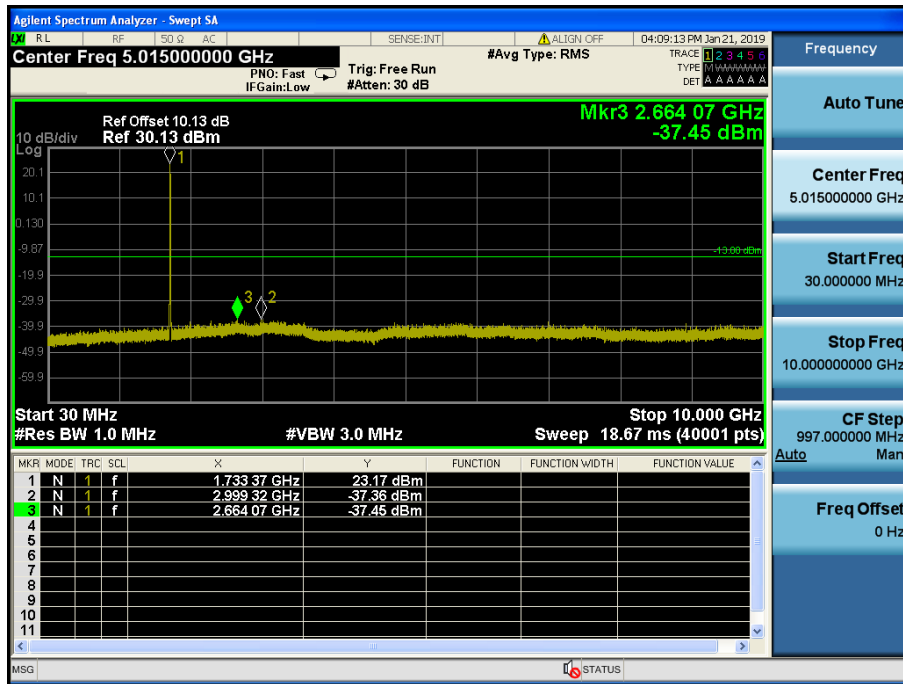

WCDMA1700 & Channel: 1412

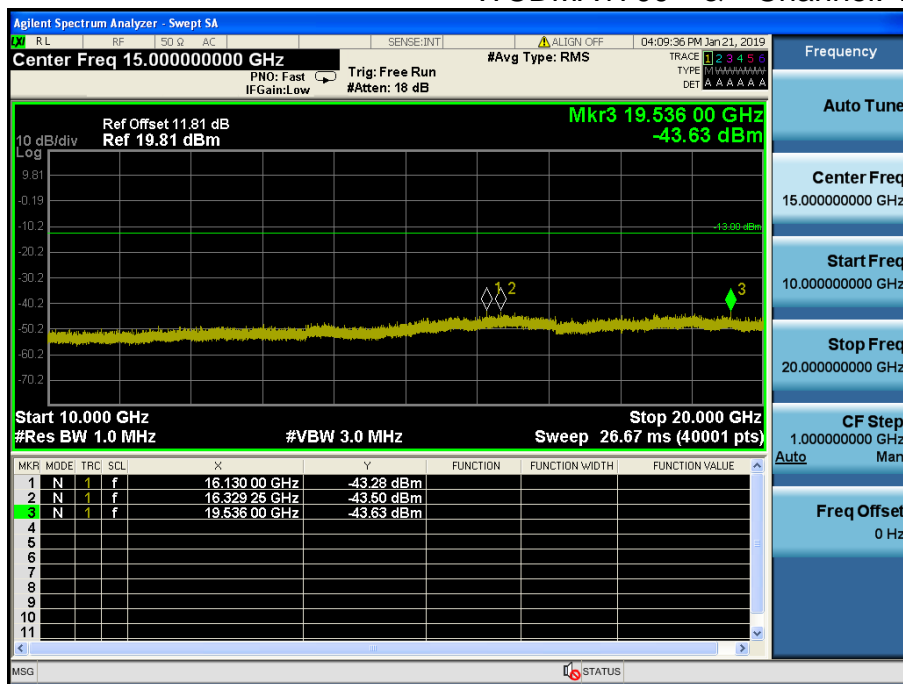

WCDMA1700 & Channel: 1513

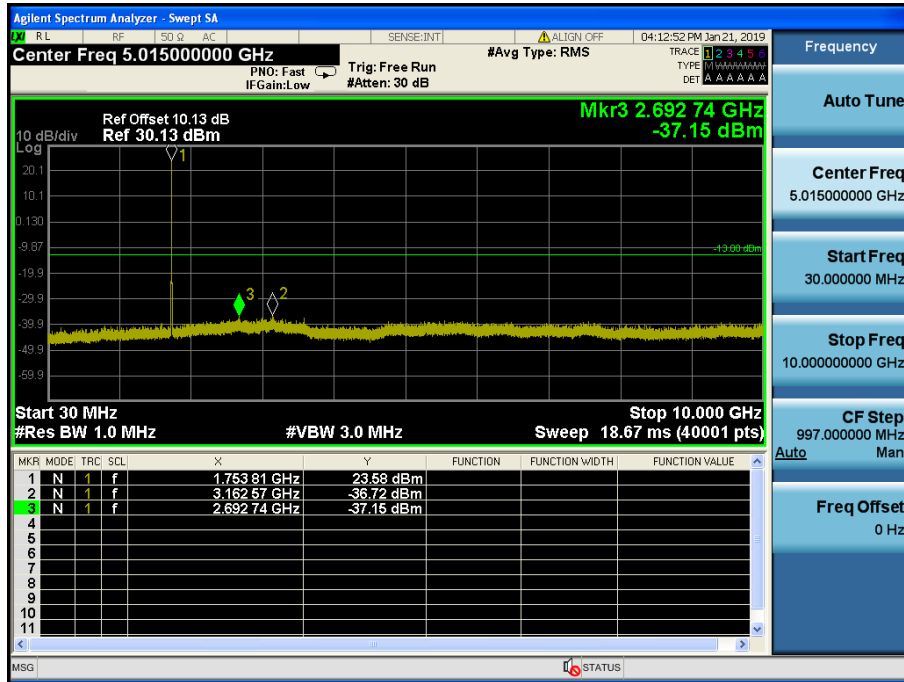

WCDMA1700 & Channel: 1513

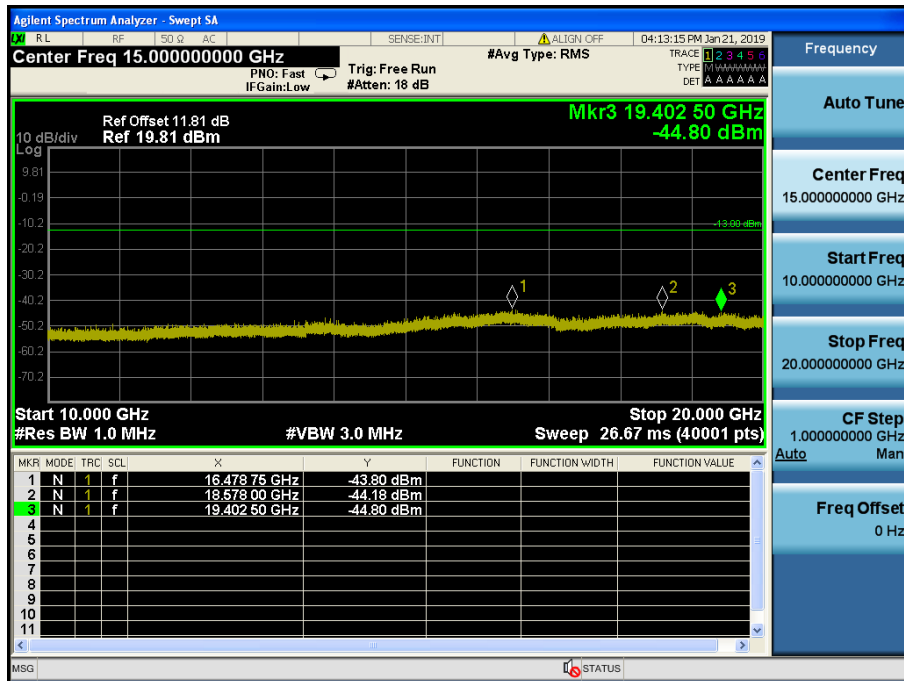

HSUPA1700 & Channel: 1312

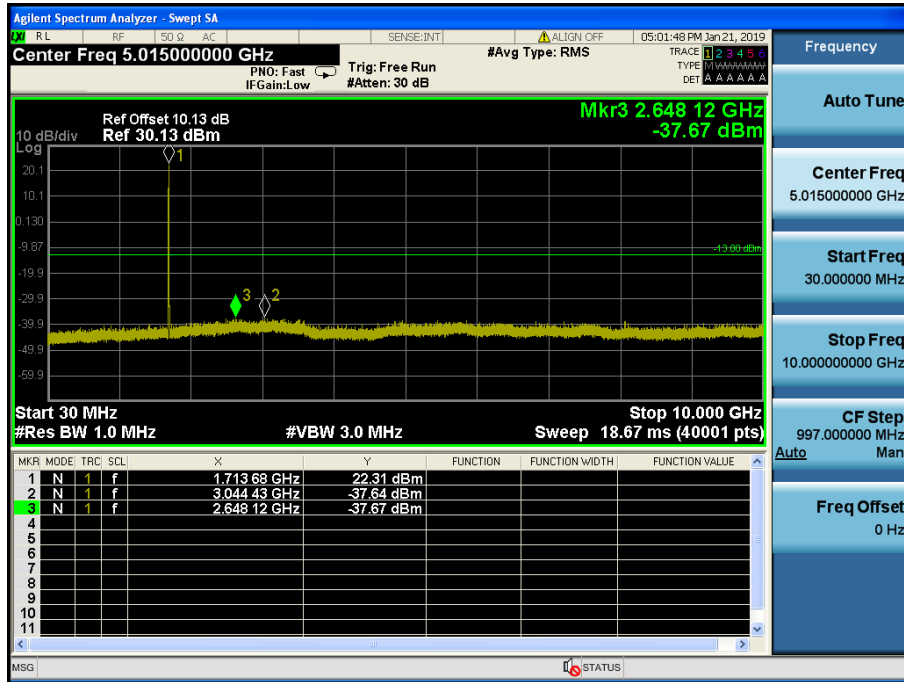

HSUPA1700 & Channel: 1312

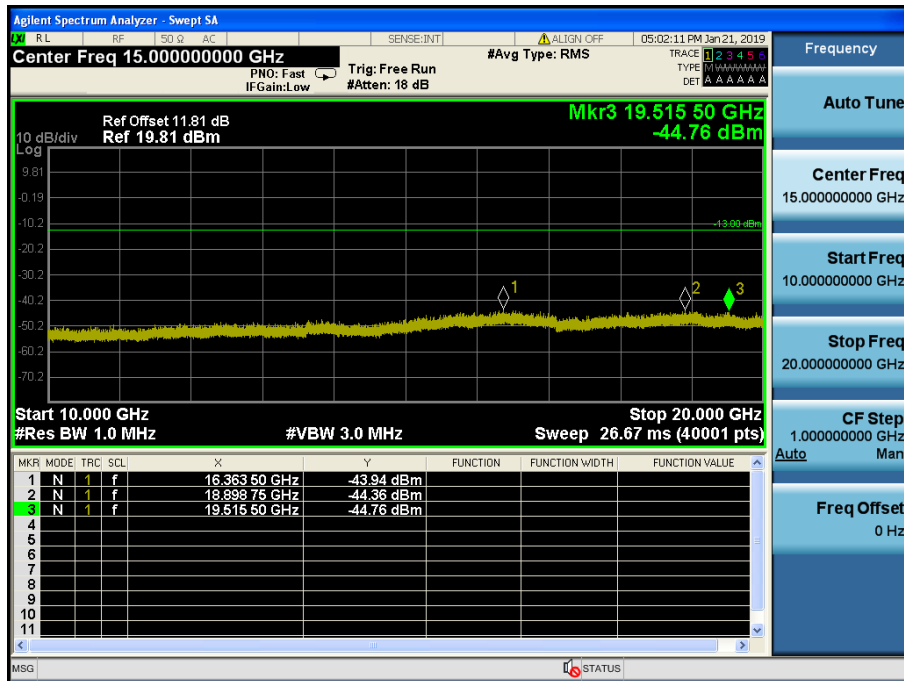

HSUPA1700 & Channel: 1412

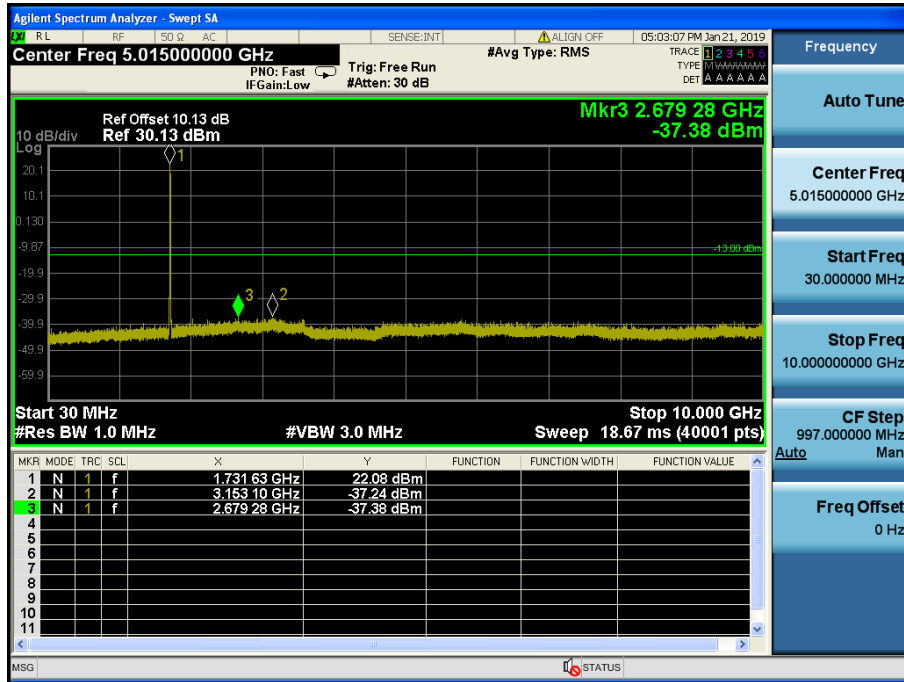

HSUPA1700 & Channel: 1412

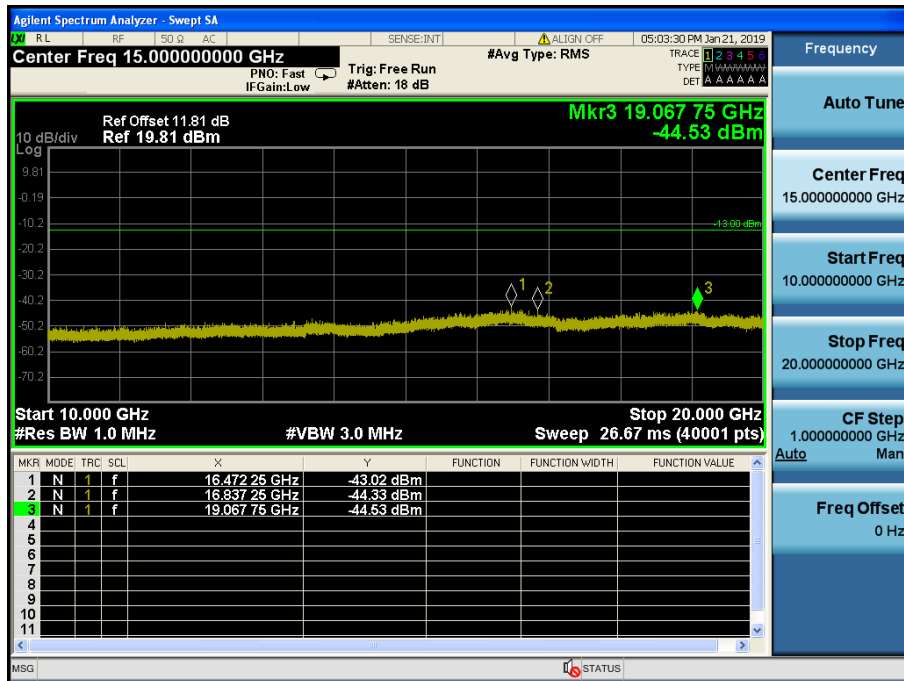

HSUPA1700 & Channel: 1513

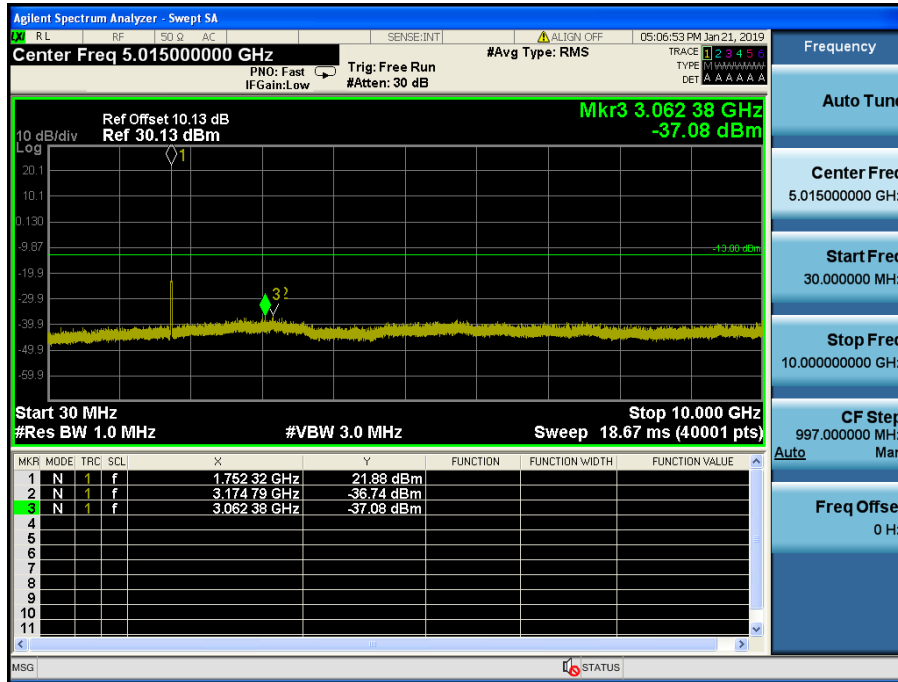

HSUPA1700 & Channel: 1513

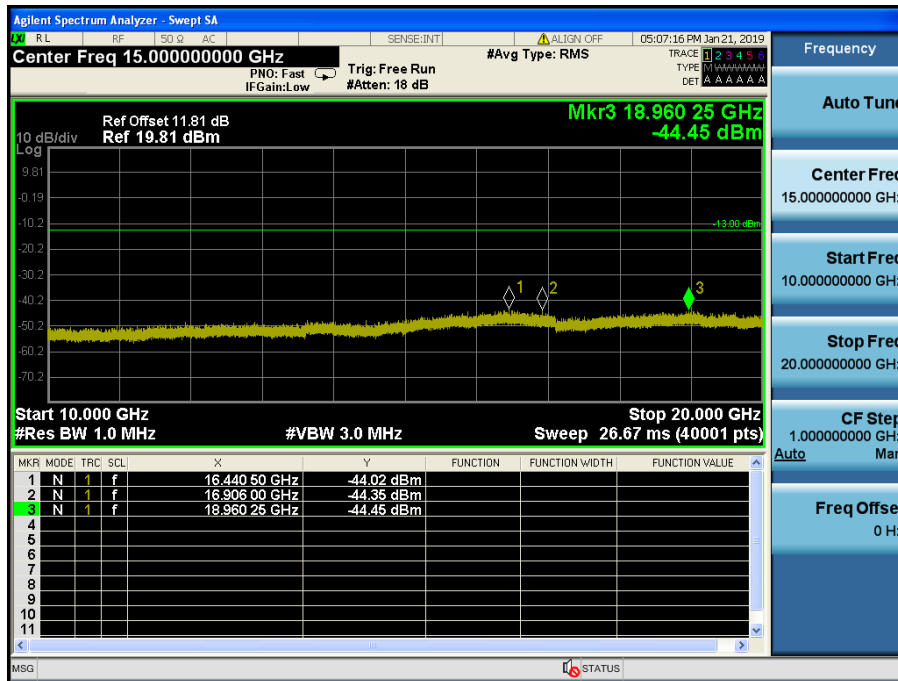

WCDMA1900 & Channel: 9262

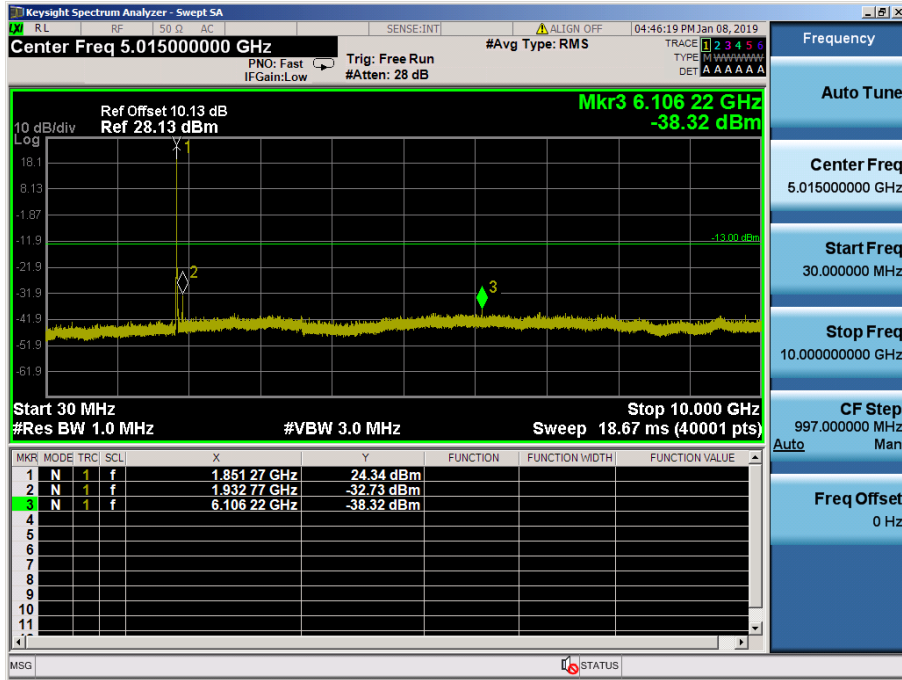

WCDMA1900 & Channel: 9262

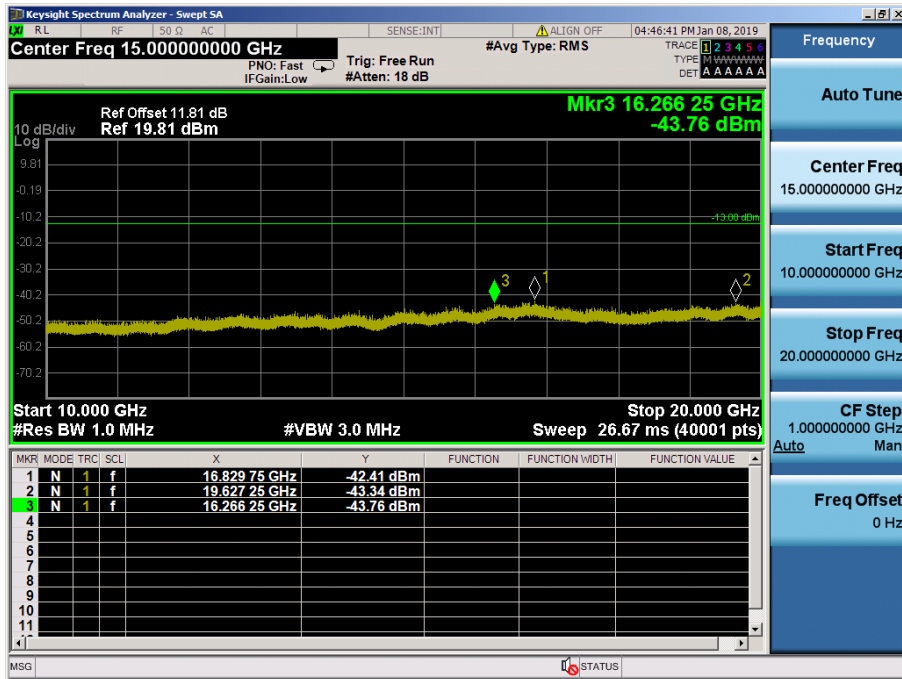

WCDMA1900 & Channel: 9400

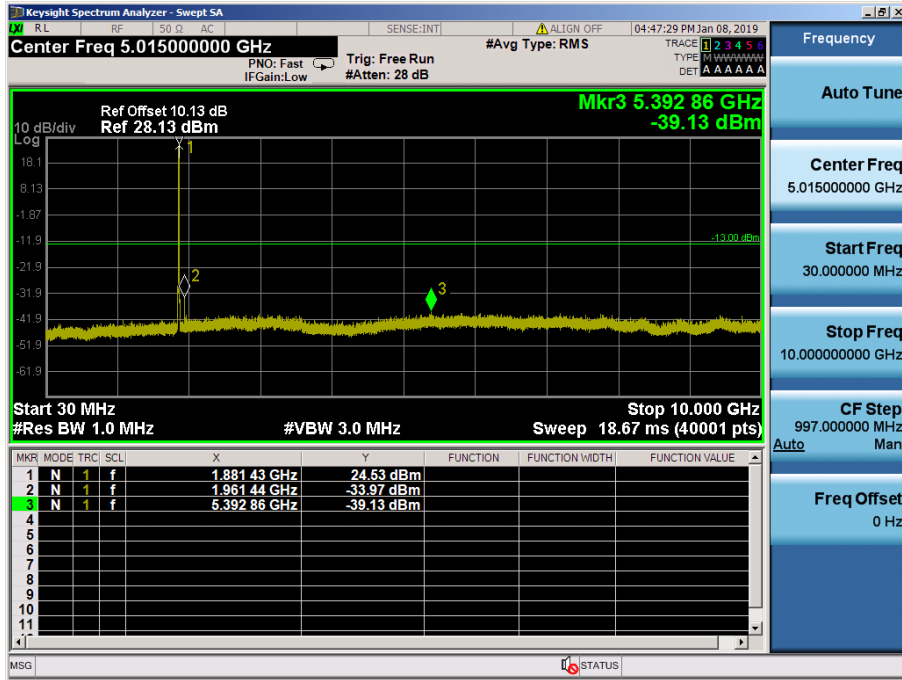

WCDMA1900 & Channel: 9400

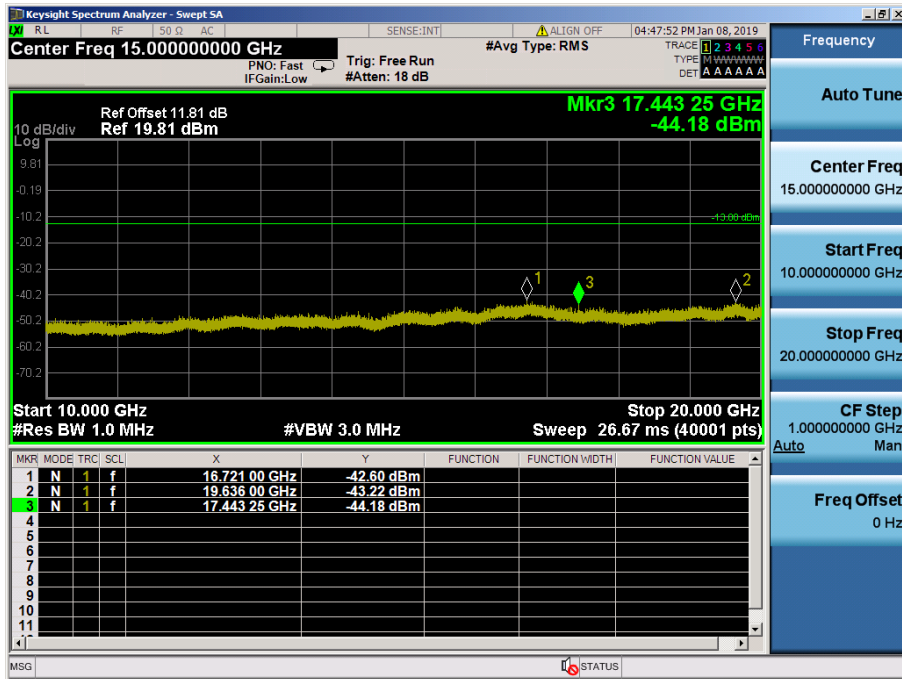

WCDMA1900 & Channel: 9538

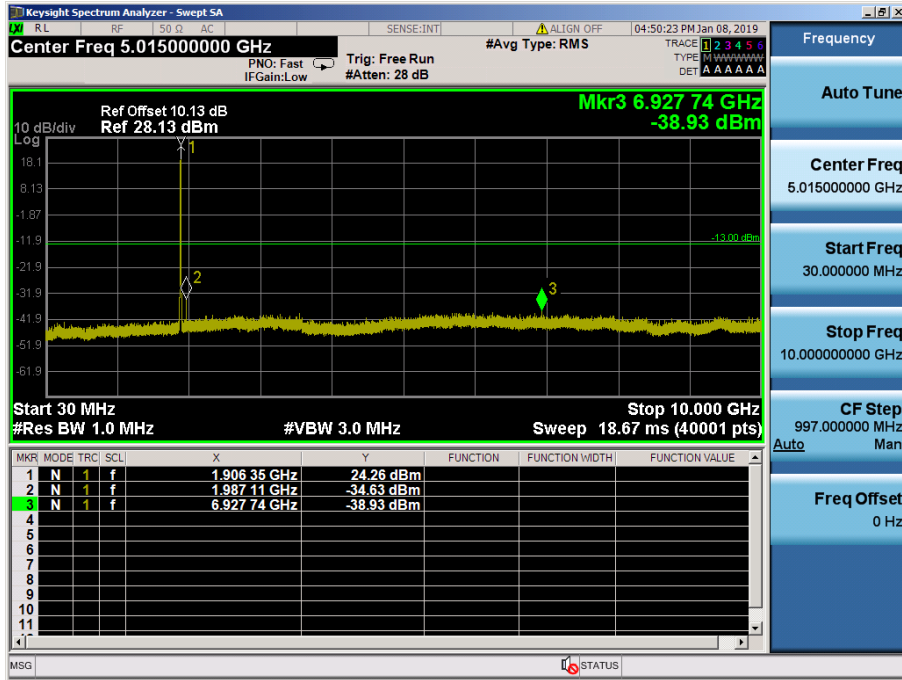

WCDMA1900 & Channel: 9538

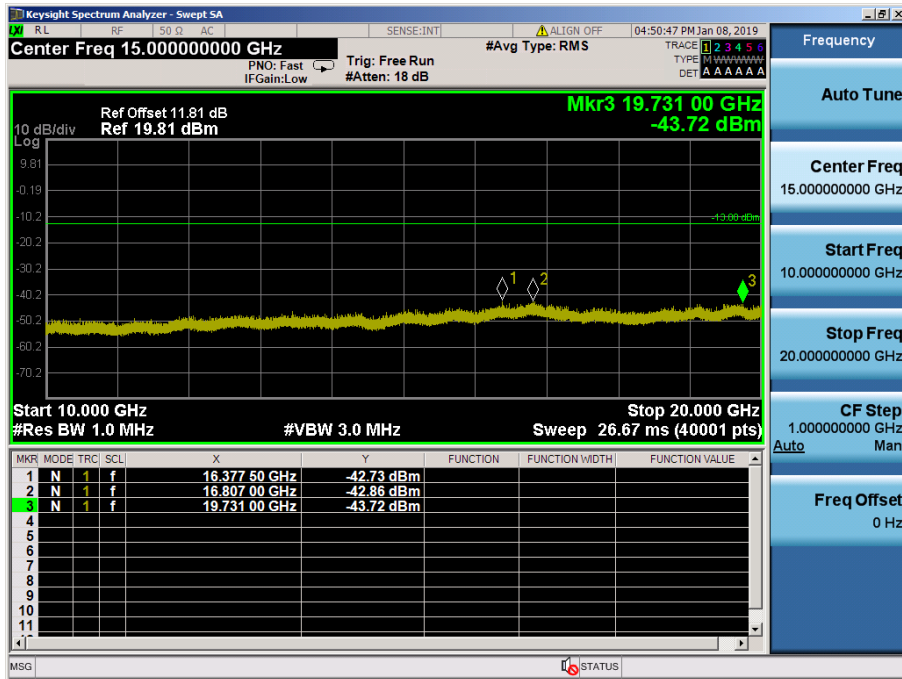

HSUPA1900 & Channel: 9262

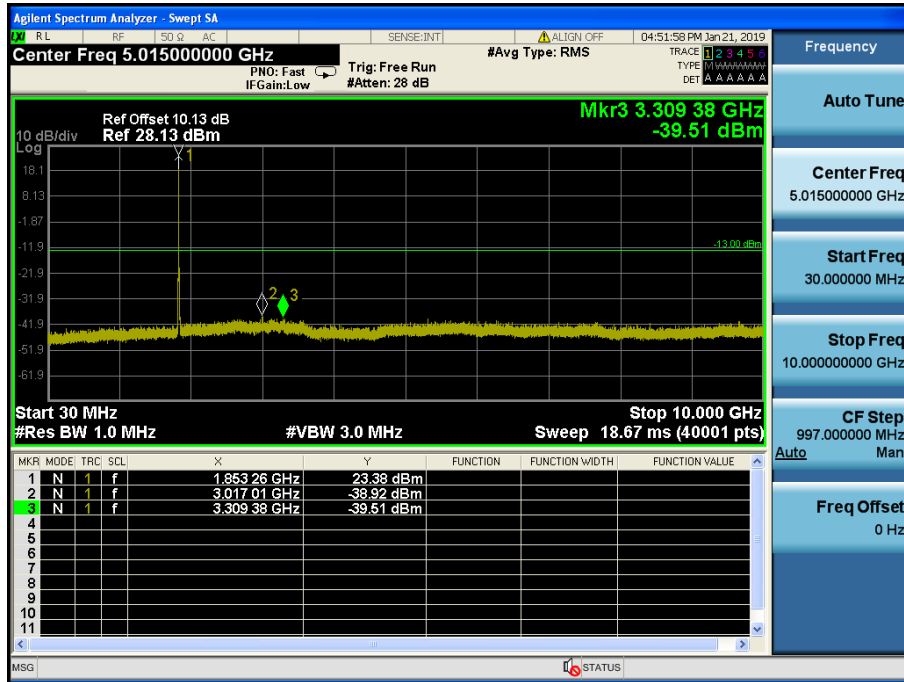

HSUPA1900 & Channel: 9262

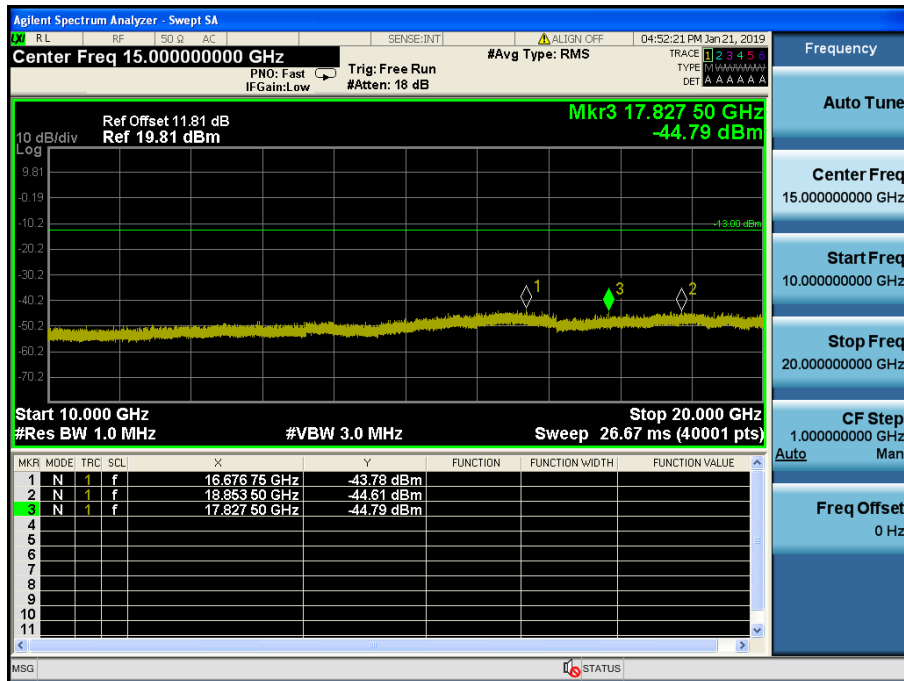

HSUPA1900 & Channel: 9400

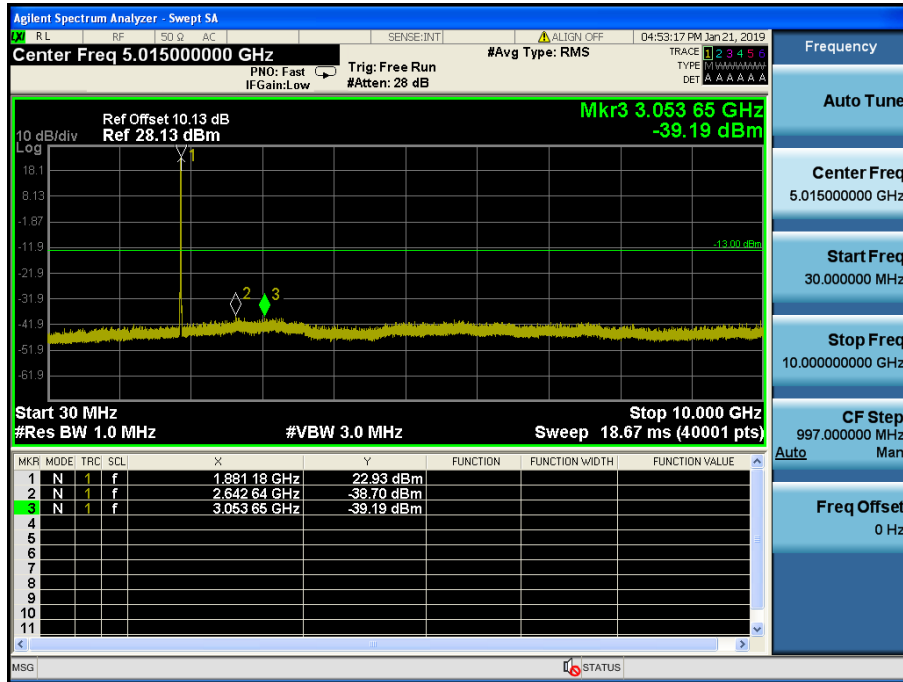

HSUPA1900 & Channel: 9400

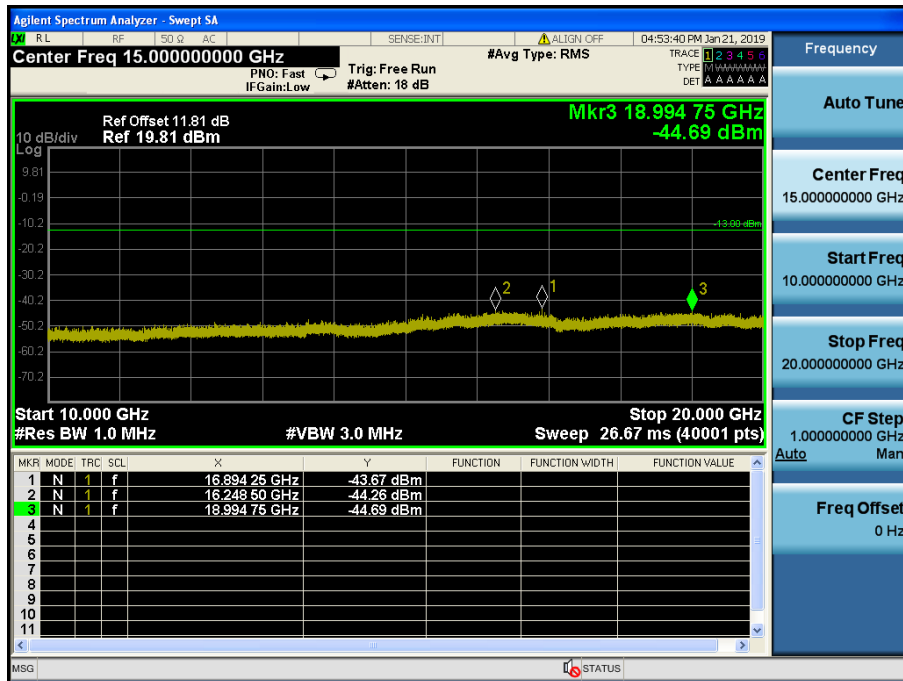

HSUPA1900 & Channel: 9538

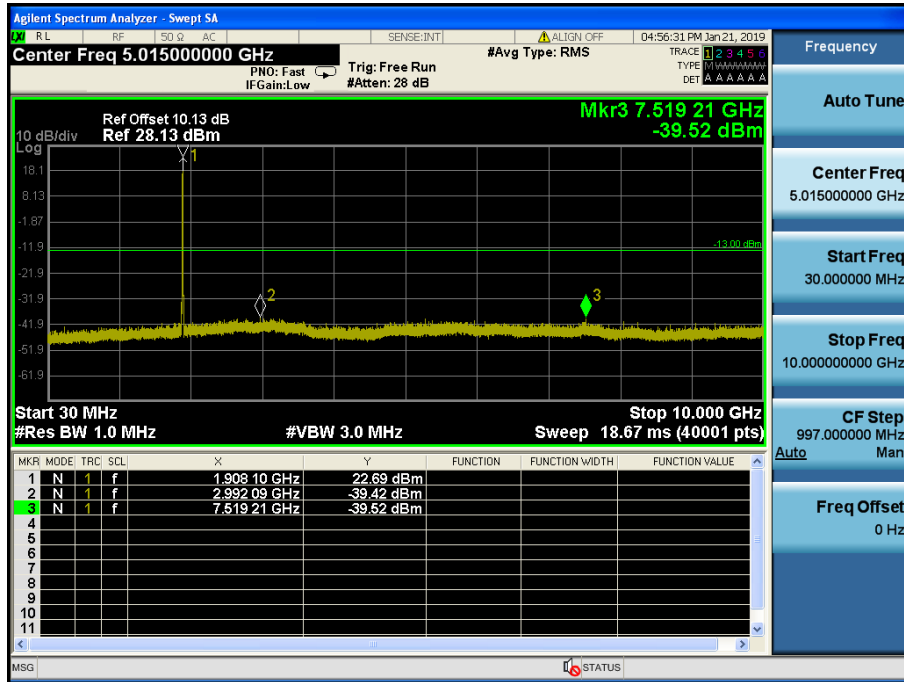

HSUPA1900 & Channel: 9538

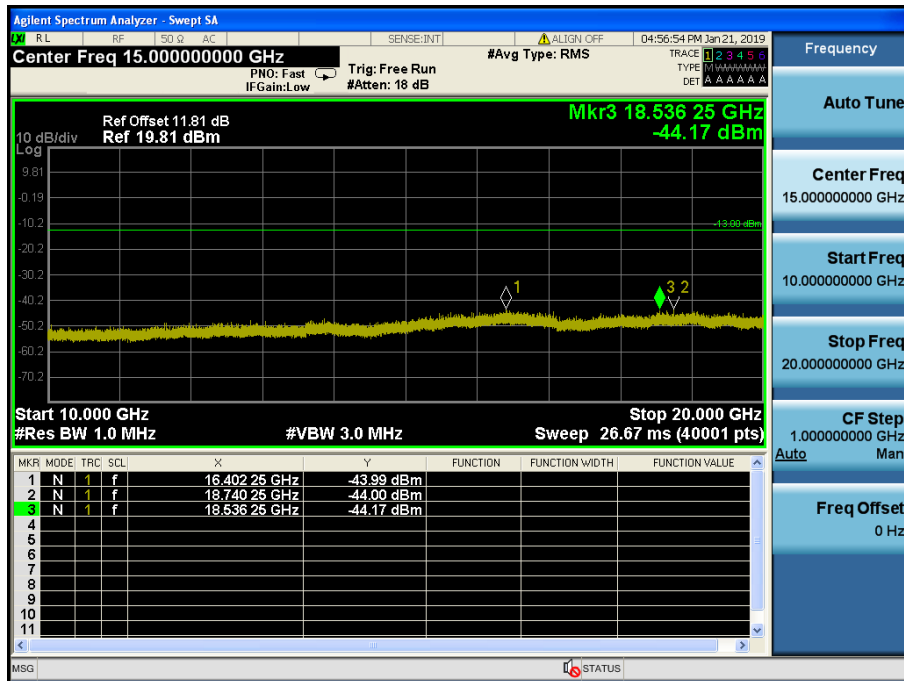

8.4 BAND EDGE EMISSIONS AT ANTENNA TERMINAL

WCDMA850 & Channel: 4132

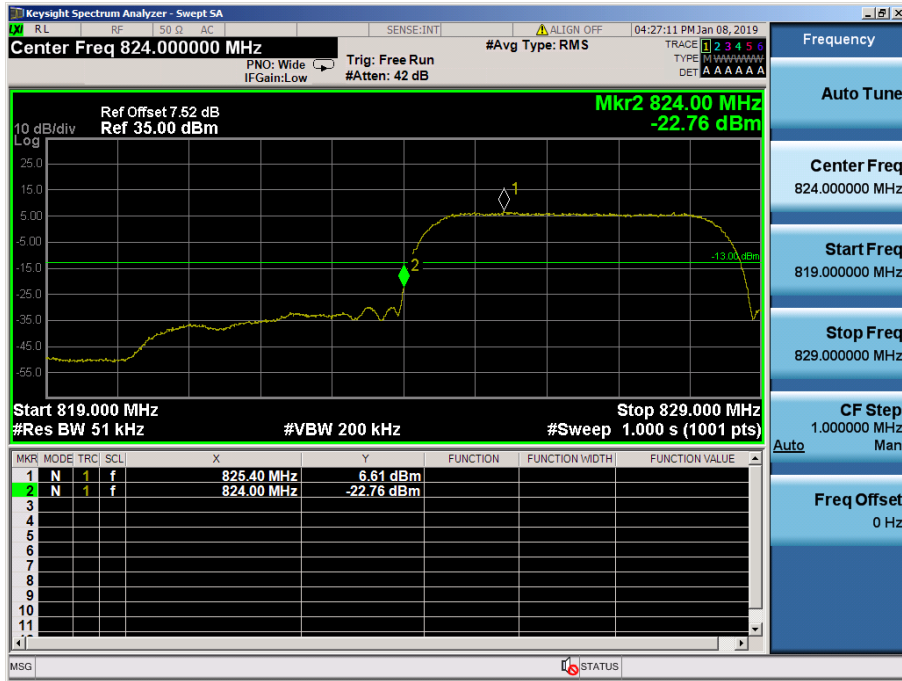

WCDMA850 & Channel: 4132

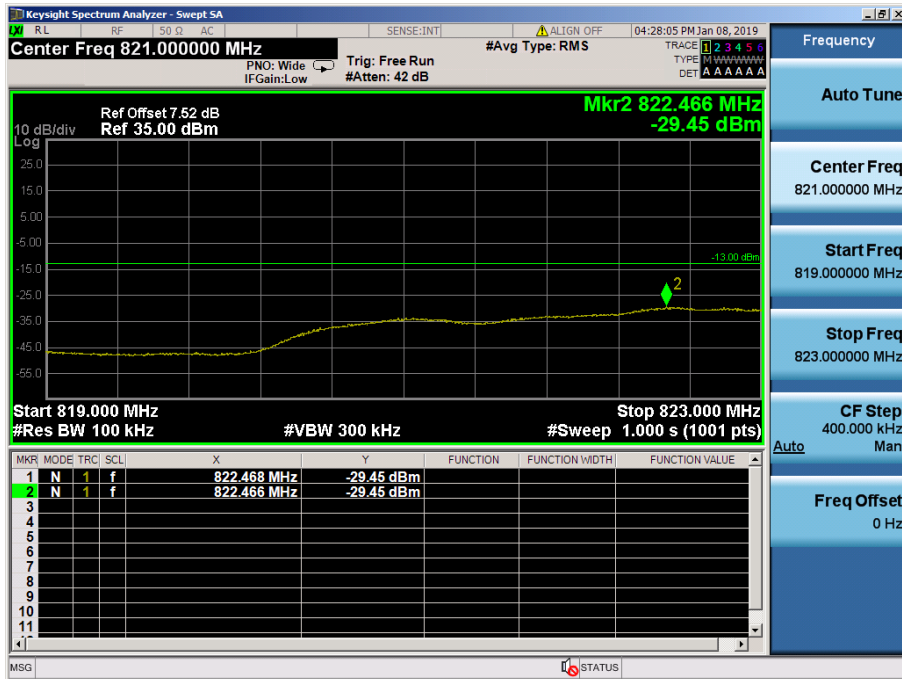

WCDMA850 & Channel: 4233



WCDMA850 & Channel: 4233



HSUPA850 & Channel: 4132

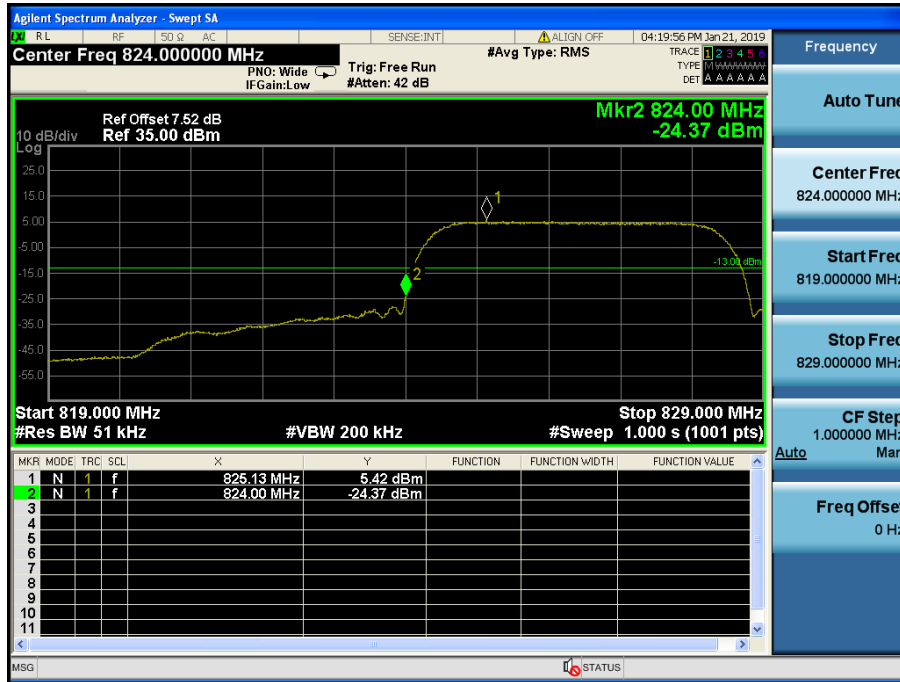

HSUPA850 & Channel: 4132

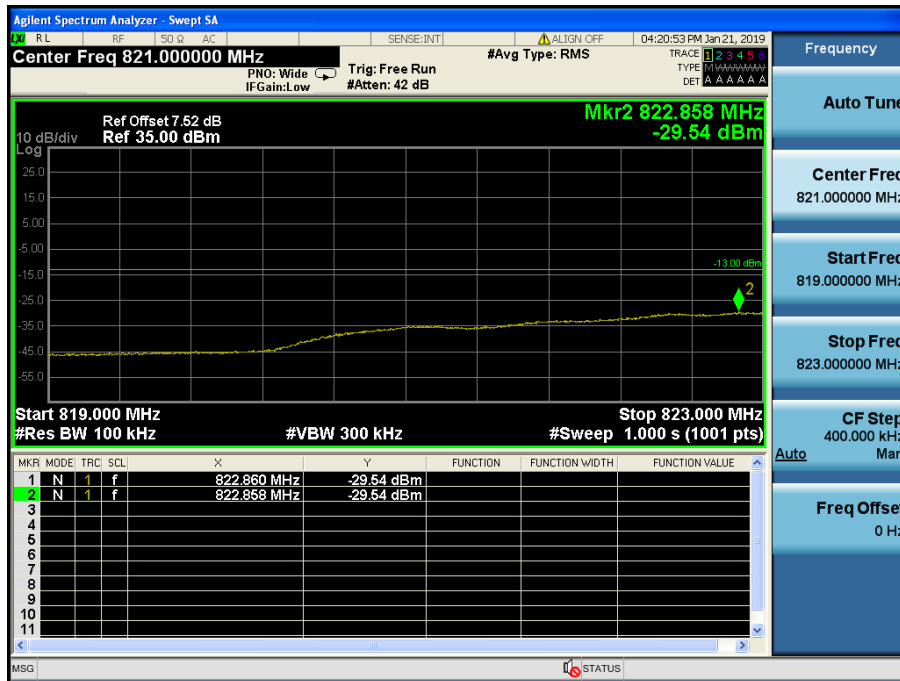

HSUPA850 & Channel: 4233



HSUPA850 & Channel: 4233

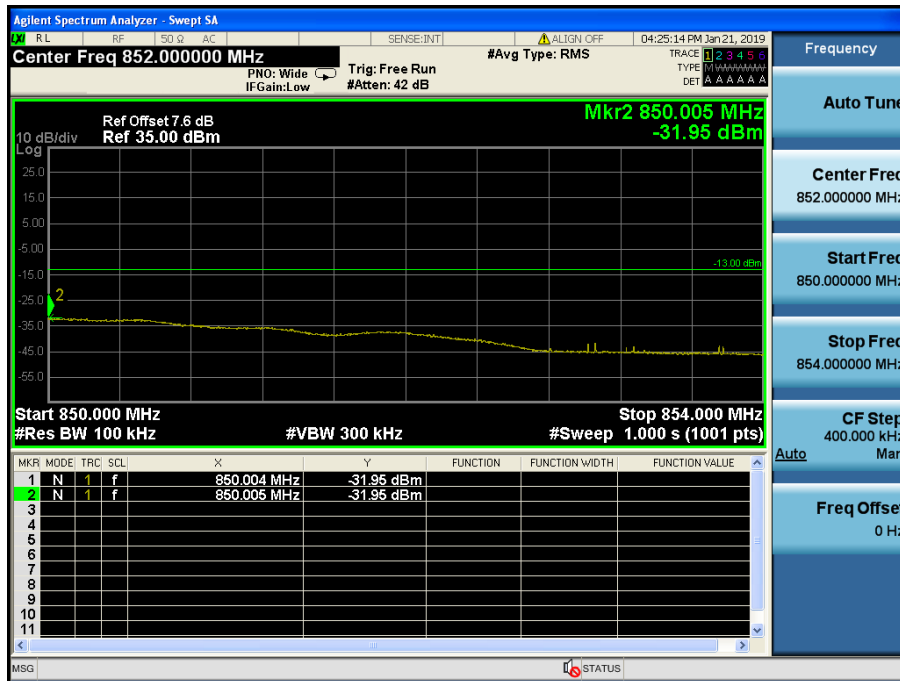

WCDMA1700 & Channel: 1312

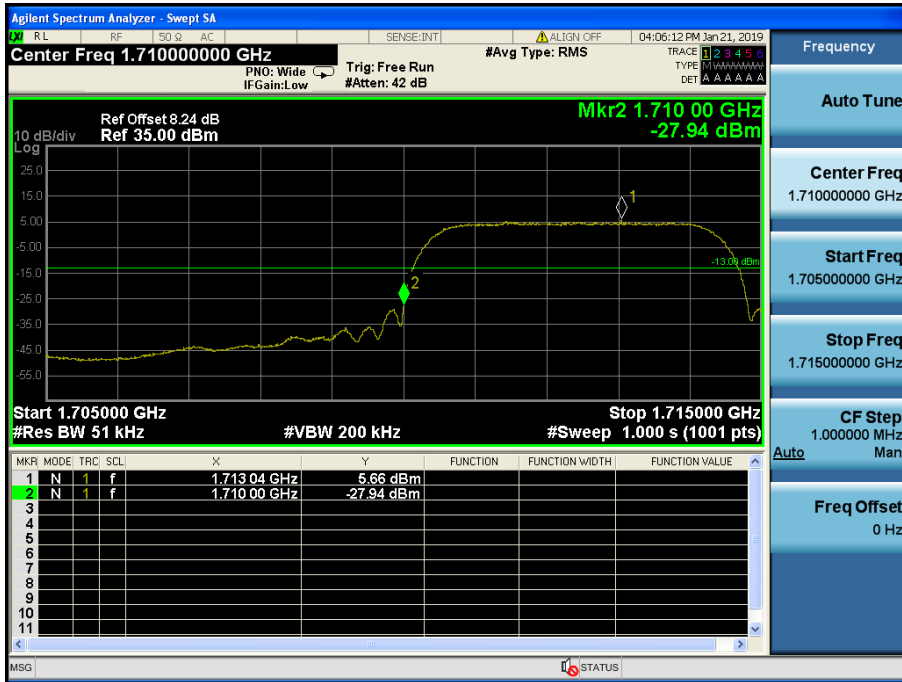

WCDMA1700 & Channel: 1312

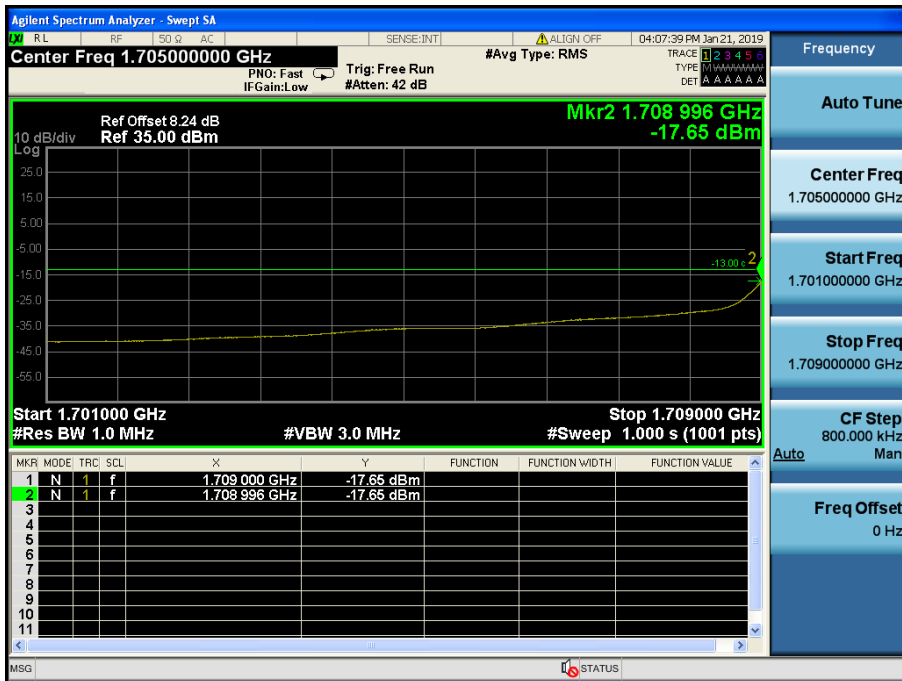

WCDMA1700 & Channel: 1513



WCDMA1700 & Channel: 1513

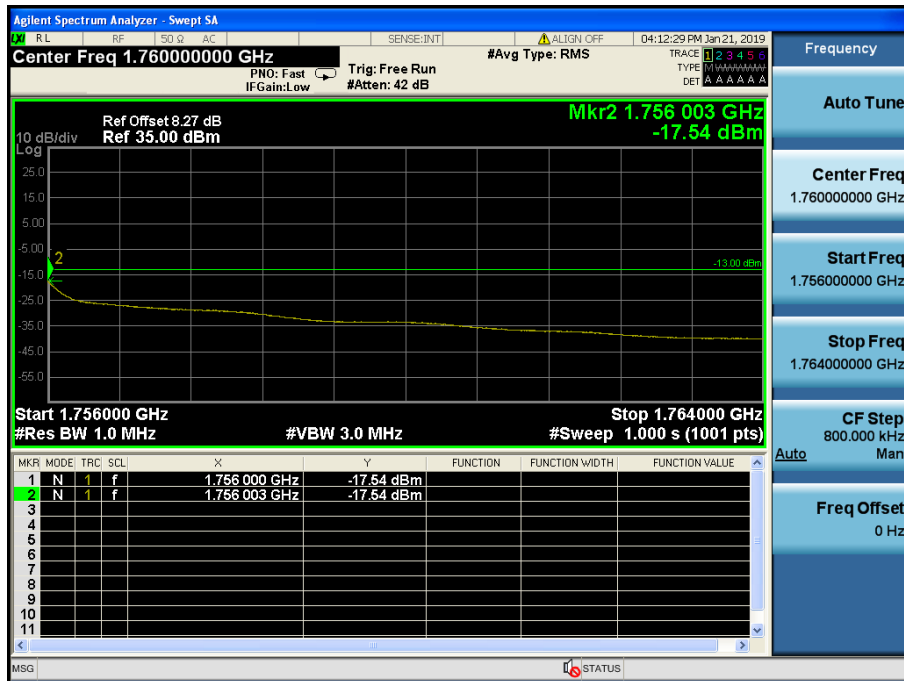

HSUPA1700 & Channel: 1312

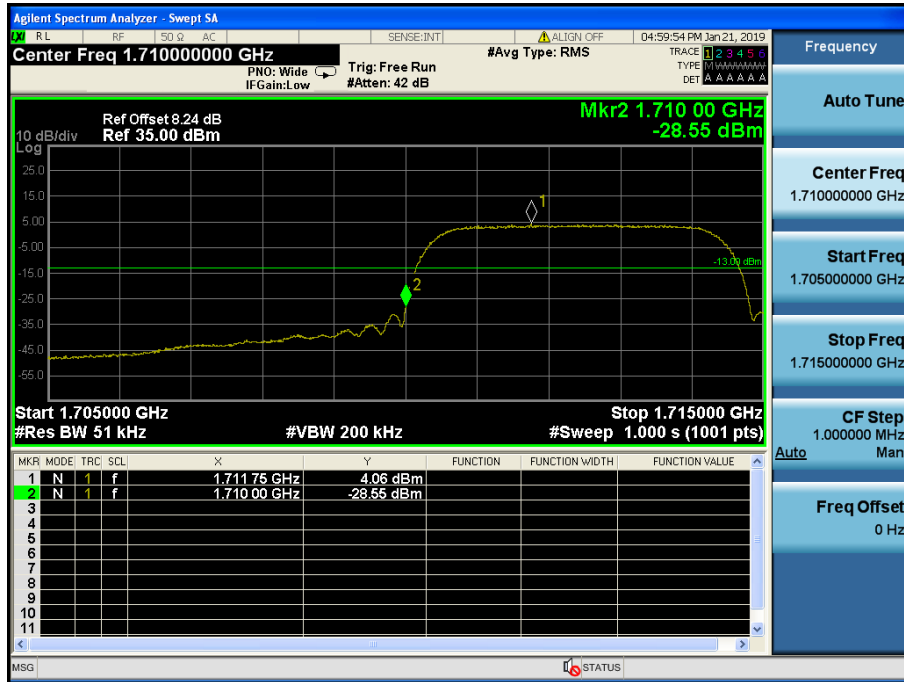

HSUPA1700 & Channel: 1312

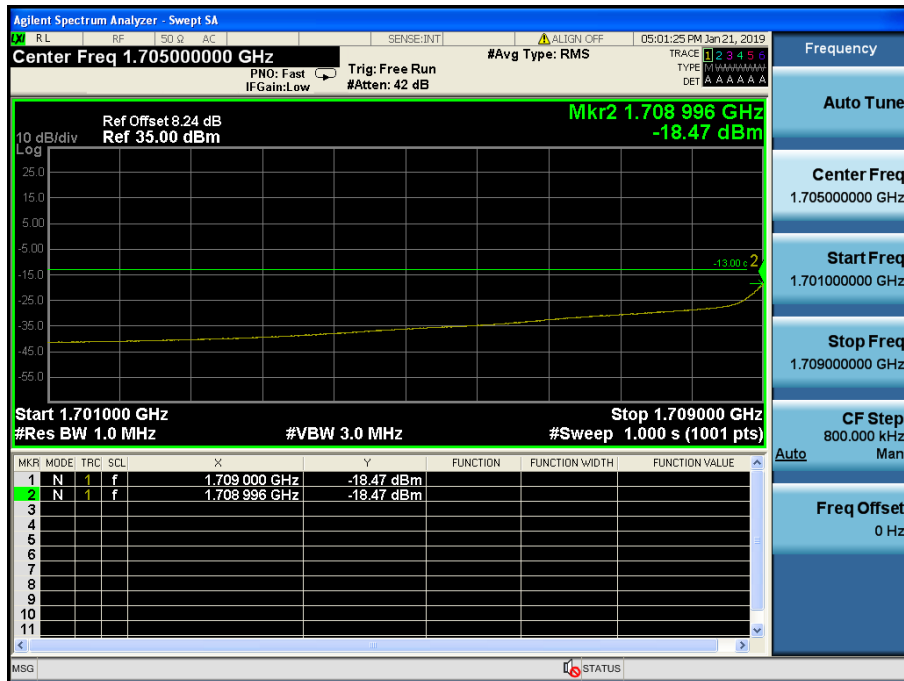

HSUPA1700 & Channel: 1513



HSUPA1700 & Channel: 1513

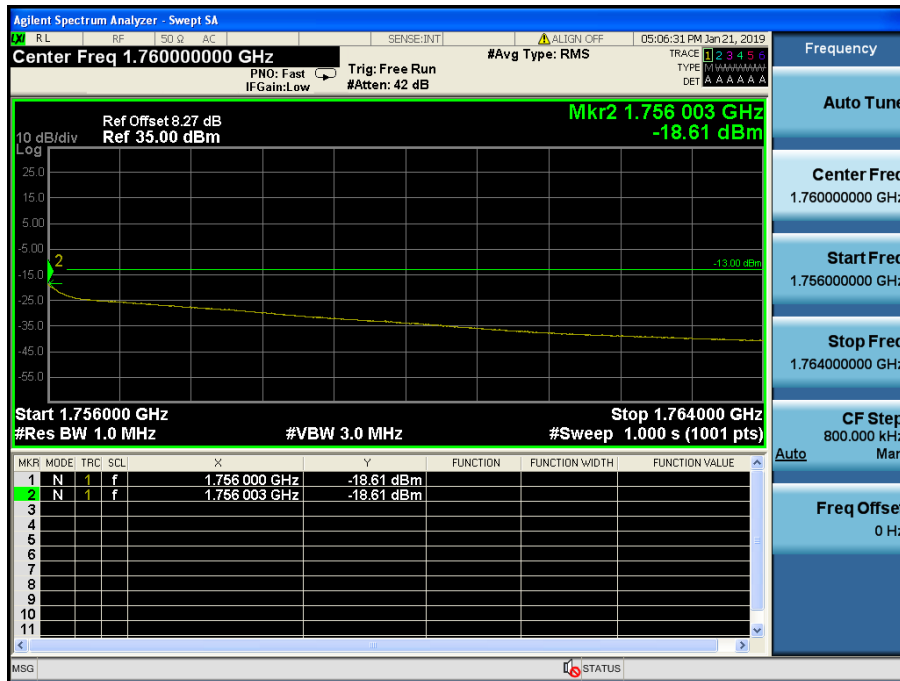

WCDMA1900 & Channel: 9262



WCDMA1900 & Channel: 9262

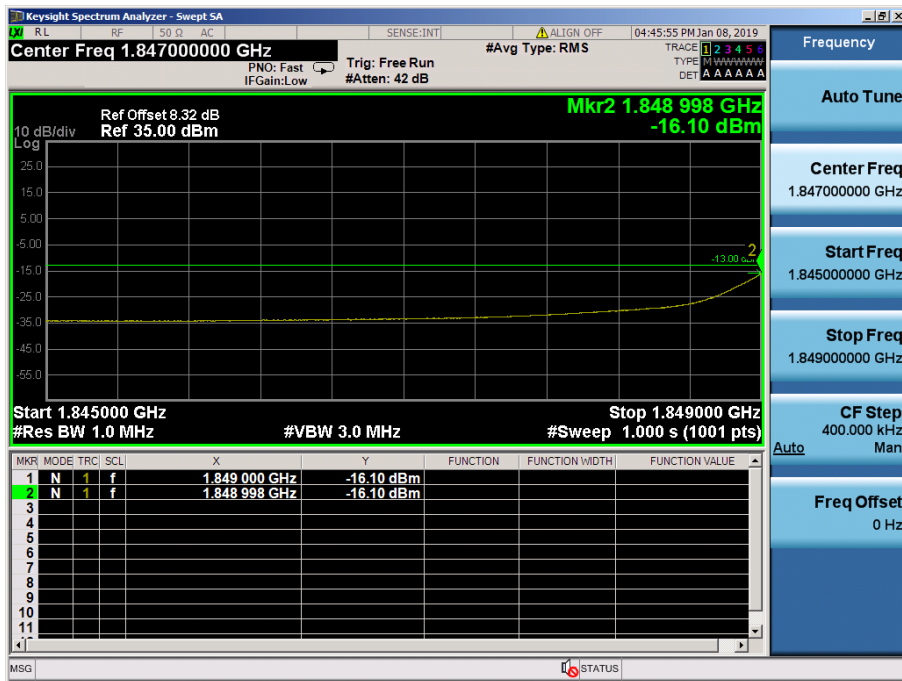

WCDMA1900 & Channel: 9538



WCDMA1900 & Channel: 9538

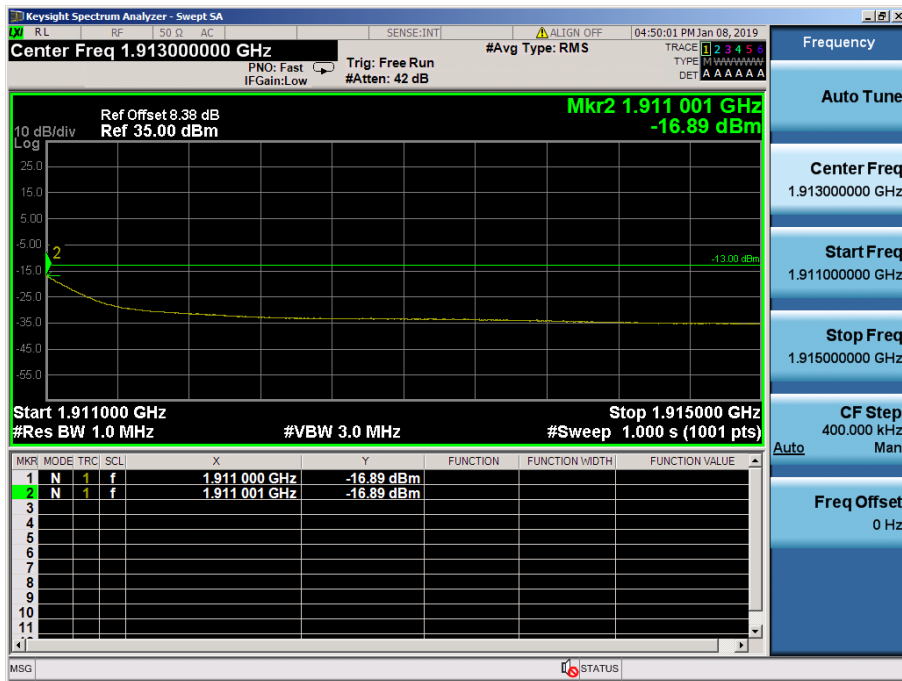

HSUPA1900 & Channel: 9262

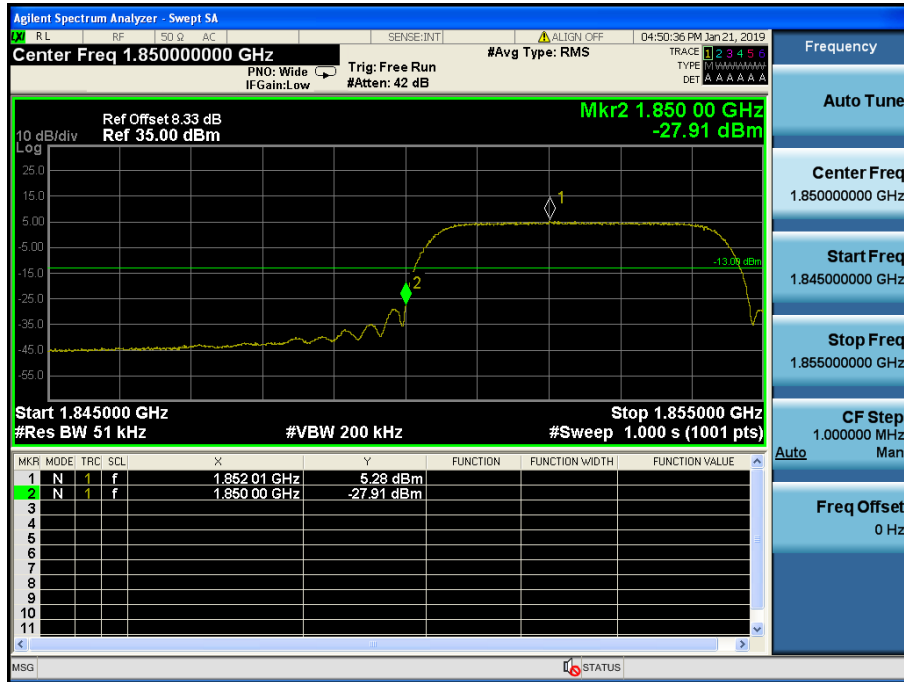

HSUPA1900 & Channel: 9262

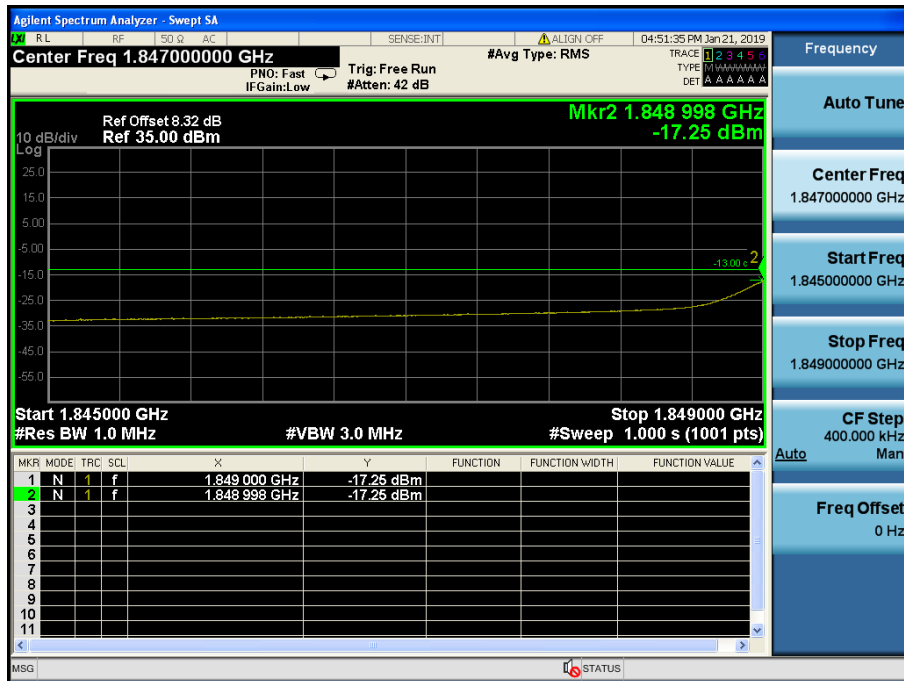

HSUPA1900 & Channel: 9538

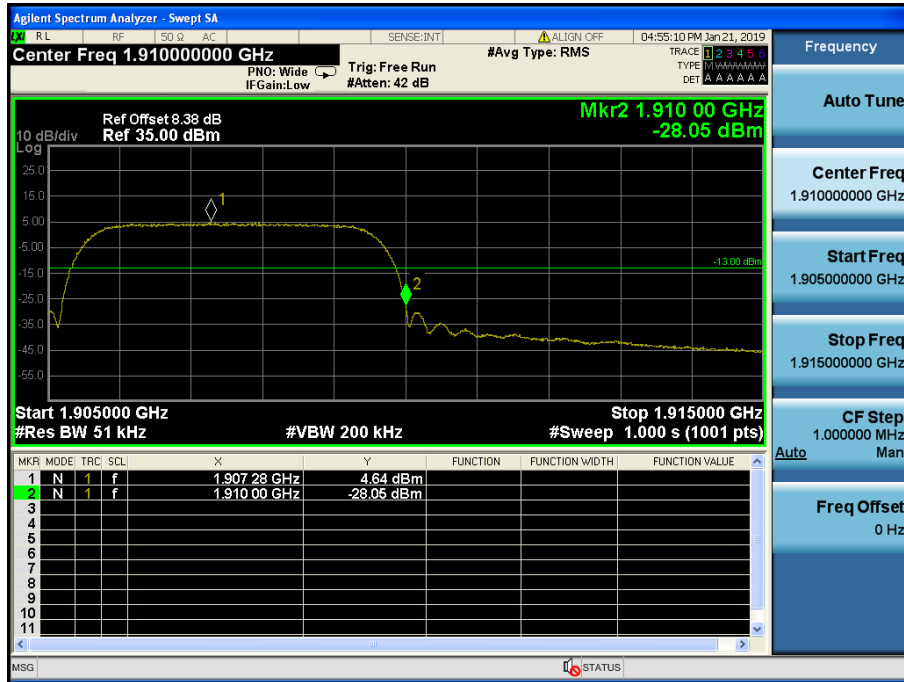

HSUPA1900 & Channel: 9538

