



# TEST REPORT



**DT&C Co., Ltd.**

42, Yurim-ro, 154Beon-gil, Cheoin-gu, Yongin-si, Gyeonggi-do, Korea, 17042  
Tel : 031-321-2664, Fax : 031-321-1664

1. Report No : DRTFCC1902-0046
2. Customer
  - Name : Bluebird Inc.
  - Address : (Dogok-dong, SEI Tower 13,14) 39, Eonjuro30-gil, Gangnam-gu, Seoul South Korea
3. Use of Report : FCC Original Grant
4. Product Name / Model Name : Enterprise Full Touch Handheld Computer / EF501  
FCC ID : SS4EF501X
5. Test Method Used : KDB971168 D01v03, ANSI/TIA-603-E-2016, ANSI C63.26-2015  
Test Specification : §2, §22, §24(E), §27, §90(R)
6. Date of Test : 2018.12.02 ~ 2019.02.13
7. Testing Environment : Refer to appended test report.
8. Test Result : Refer to the attached test result.

Affirmation	Tested by	Reviewed by
	Name : JaeHyeok Bang 	Name : Geunki Son  (Signature)

The test results presented in this test report are limited only to the sample supplied by applicant and the use of this test report is inhibited other than its purpose. This test report shall not be reproduced except in full, without the written approval of DT&C Co., Ltd.

2019 . 02 . 20 .

**DT&C Co., Ltd.**

If this report is required to confirmation of authenticity, please contact to [report@dtnc.net](mailto:report@dtnc.net)

## Test Report Version

Test Report No.	Date	Description
DRTFCC1902-0046	Feb. 20, 2019	Initial issue

# Table of Contents

<b>1. GENERAL INFORMATION .....</b>	<b>5</b>
<b>2. INTRODUCTION .....</b>	<b>7</b>
2.1 EUT DESCRIPTION .....	7
2.2. EUT CAPABILITIES .....	7
2.3. TESTING ENVIRONMENT .....	7
2.4 MEASURING INSTRUMENT CALIBRATION.....	7
2.5. MEASUREMENT UNCERTAINTY .....	7
2.6. TEST FACILITY.....	7
<b>3. DESCRIPTION OF TESTS.....</b>	<b>8</b>
3.1 ERP & EIRP (Effective Radiated Power & Equivalent Isotropic Radiated Power) .....	8
3.2 PEAK TO AVERAGE RATIO .....	10
3.3 OCCUPIED BANDWIDTH.....	11
3.4 BAND EDGE EMISSIONS AT ANTENNA TERMINAL .....	12
3.5 SPURIOUS AND HARMONIC EMISSIONS AT ANTENNA TERMINAL .....	14
3.6 UNDESIRABLE EMISSIONS .....	15
3.7 FREQUENCY STABILITY .....	16
<b>4. LIST OF TEST EQUIPMENT .....</b>	<b>17</b>
<b>5. SUMMARY OF TEST RESULTS .....</b>	<b>18</b>
<b>6. SAMPLE CALCULATION .....</b>	<b>19</b>
<b>7. TEST DATA.....</b>	<b>22</b>
7.1 OCCUPIED BANDWIDTH.....	22
7.2 PEAK TO AVERAGE RATIO.....	22
7.3 BAND EDEG EMISSIONS (Conducted).....	22
7.4 SPURIOUS AND HARMONICS EMISSIONS (Conducted) .....	22
7.5 ERP & EIRP .....	23
7.5.1 LTE Band 71.....	23
7.5.2 LTE Band 12.....	24
7.5.3 LTE Band 13.....	25
7.5.4 LTE Band 14.....	26
7.5.5 LTE Band 5.....	27
7.5.6 LTE Band 66, 4.....	28
7.5.7 LTE Band 2.....	29
7.6 UNDESIRABLE EMISSIONS (Radiated).....	30
7.6.1 LTE Band 71.....	30
7.6.2 LTE Band 12.....	32
7.6.3 LTE Band 13.....	35
7.6.4 LTE Band 14.....	36
7.6.5 LTE Band 5.....	37
7.6.6 LTE Band 66, 4.....	39

7.6.7 LTE Band 2.....	41
<b>7.7 FREQUENCY STABILITY .....</b>	<b>43</b>
7.7.1 LTE Band 71.....	43
7.7.2 LTE Band 12.....	44
7.7.3 LTE Band 13.....	45
7.7.4 LTE Band 14.....	46
7.7.5 LTE Band 5.....	47
7.7.6 LTE Band 66, 4.....	48
7.7.7 LTE Band 2.....	49
<b>8. TEST PLOTS .....</b>	<b>50</b>
<b>8.1 OCCUPIED BANDWIDTH.....</b>	<b>50</b>
8.1.1 LTE Band 71.....	50
8.1.2 LTE Band 12.....	54
8.1.3 LTE Band 13.....	58
8.1.14 LTE Band 14.....	60
8.1.5 LTE Band 5.....	62
8.1.6 LTE Band 66, 4.....	66
8.1.7 LTE Band 2.....	72
<b>8.2 PEAK TO AVERAGE RATIO.....</b>	<b>78</b>
8.2.1 LTE Band 71.....	78
8.2.2 LTE Band 12.....	82
8.2.3 LTE Band 13.....	86
8.2.3 LTE Band 14.....	88
8.2.3 LTE Band 5.....	90
8.2.4 LTE Band 66, 4.....	94
8.2.5 LTE Band 2.....	100
<b>8.3 BAND EDGE EMISSIONS(Conducted).....</b>	<b>106</b>
8.3.1 LTE Band 71.....	106
8.3.2 LTE Band 12.....	114
8.3.3 LTE Band 13.....	122
8.3.3 LTE Band 14.....	130
8.3.4 LTE Band 5.....	132
8.3.4 LTE Band 66, 4.....	140
8.3.5 LTE Band 2.....	152
<b>8.4 SPURIOUS AND HARMONICS EMISSIONS(Conducted) .....</b>	<b>164</b>
8.4.1 LTE Band 71.....	164
8.4.2 LTE Band 12.....	170
8.4.3 LTE Band 13.....	176
8.4.4 LTE Band 14.....	178
8.4.5 LTE Band 5.....	180
8.4.6 LTE Band 66, 4.....	186
8.4.7 LTE Band 2.....	204

## 1. GENERAL INFORMATION

**Applicant Name** : BLUEBIRD INC.  
**Address** : (Dogok-dong, SEI Tower 13,14) 39, Eonjuro30-gil, Gangnam-gu, Seoul South Korea  
**FCC ID** : SS4EF501X  
**FCC Classification** : PCS Licensed Transmitter held to ear (PCE)  
**EUT Type** : Enterprise Full Touch Handheld Computer  
**Model Name** : EF501  
**Add Model Name** : EF501R  
**Supplying power** : DC 3.8 V  
**Antenna Information** : Internal Antenna

Mode	TX Frequency (MHz)	Emission Designator	Modulation	ERP	
				Max power (dBm)	Max power (W)
LTE Band 71	673 ~ 688	17M9G7D	QPSK	20.20	0.105
LTE Band 71	673 ~ 688	17M9W7D	16QAM	19.29	0.085
LTE Band 71	670.5 ~ 690.5	13M4G7D	QPSK	20.30	0.107
LTE Band 71	670.5 ~ 690.5	13M4W7D	16QAM	18.45	0.070
LTE Band 71	668 ~ 693	8M94G7D	QPSK	20.66	0.116
LTE Band 71	668 ~ 693	8M94W7D	16QAM	19.81	0.096
LTE Band 71	665.5 ~ 695.5	4M50G7D	QPSK	20.53	0.113
LTE Band 71	665.5 ~ 695.5	4M48W7D	16QAM	19.70	0.093
LTE Band 12	704 ~ 711	8M96G7D	QPSK	16.52	0.045
LTE Band 12	704 ~ 711	8M95W7D	16QAM	15.11	0.032
LTE Band 12	701.5 ~ 713.5	4M48G7D	QPSK	16.34	0.043
LTE Band 12	701.5 ~ 713.5	4M49W7D	16QAM	15.17	0.033
LTE Band 12	700.5 ~ 714.5	2M69G7D	QPSK	16.50	0.045
LTE Band 12	700.5 ~ 714.5	2M70W7D	16QAM	15.21	0.033
LTE Band 12	699.7 ~ 715.3	1M09G7D	QPSK	16.39	0.044
LTE Band 12	699.7 ~ 715.3	1M09W7D	16QAM	15.10	0.032
LTE Band 13	782 ~ 782	8M93G7D	QPSK	16.77	0.048
LTE Band 13	782 ~ 782	8M92W7D	16QAM	15.45	0.035
LTE Band 13	779.5 ~ 784.5	4M49G7D	QPSK	16.74	0.047
LTE Band 13	779.5 ~ 784.5	4M49W7D	16QAM	15.37	0.034
LTE Band 14	793 ~ 793	8M94G7D	QPSK	19.17	0.083
LTE Band 14	793 ~ 793	8M91W7D	16QAM	17.75	0.060
LTE Band 14	790.5 ~ 795.5	4M48G7D	QPSK	19.92	0.098
LTE Band 14	790.5 ~ 795.5	4M50W7D	16QAM	17.88	0.061
LTE Band 5	829 ~ 844	8M97G7D	QPSK	22.16	0.164
LTE Band 5	829 ~ 844	8M96W7D	16QAM	21.24	0.133
LTE Band 5	826.5 ~ 846.5	4M49G7D	QPSK	22.32	0.171
LTE Band 5	826.5 ~ 846.5	4M48W7D	16QAM	20.99	0.126
LTE Band 5	825.5 ~ 847.5	2M70G7D	QPSK	22.23	0.167
LTE Band 5	825.5 ~ 847.5	2M70W7D	16QAM	20.91	0.123
LTE Band 5	824.7 ~ 848.3	1M08G7D	QPSK	22.63	0.183
LTE Band 5	824.7 ~ 848.3	1M09W7D	16QAM	21.51	0.142

Mode	TX Frequency (MHz)	Emission Designator	Modulation	EIRP	
				Max power(dBm)	Max power(W)
LTE Band 66, 4	1720 ~ 1770	17M9G7D	QPSK	23.47	0.222
LTE Band 66, 4	1720 ~ 1770	17M9W7D	16QAM	22.38	0.173
LTE Band 66, 4	1717.5 ~ 1772.5	13M4G7D	QPSK	23.37	0.217
LTE Band 66, 4	1717.5 ~ 1772.5	13M4W7D	16QAM	22.30	0.170
LTE Band 66, 4	1715 ~ 1775	8M95G7D	QPSK	23.38	0.218
LTE Band 66, 4	1715 ~ 1775	8M94W7D	16QAM	21.79	0.151
LTE Band 66, 4	1712.5 ~ 1777.5	4M49G7D	QPSK	22.99	0.199
LTE Band 66, 4	1712.5 ~ 1777.5	4M49W7D	16QAM	21.71	0.148
LTE Band 66, 4	1711.5 ~ 1778.5	2M70G7D	QPSK	22.81	0.191
LTE Band 66, 4	1711.5 ~ 1778.5	2M70W7D	16QAM	21.74	0.149
LTE Band 66, 4	1710.7 ~ 1779.3	1M09G7D	QPSK	22.82	0.191
LTE Band 66, 4	1710.7 ~ 1779.3	1M09W7D	16QAM	21.73	0.149
LTE Band 2	1860 ~ 1900	17M9G7D	QPSK	23.68	0.233
LTE Band 2	1860 ~ 1900	17M8W7D	16QAM	22.44	0.175
LTE Band 2	1857.5 ~ 1902.5	13M4G7D	QPSK	24.56	0.286
LTE Band 2	1857.5 ~ 1902.5	13M4W7D	16QAM	23.51	0.224
LTE Band 2	1855 ~ 1905	8M96G7D	QPSK	23.88	0.244
LTE Band 2	1855 ~ 1905	8M94W7D	16QAM	22.64	0.184
LTE Band 2	1852.5 ~ 1907.5	4M49G7D	QPSK	23.71	0.235
LTE Band 2	1852.5 ~ 1907.5	4M49W7D	16QAM	22.25	0.168
LTE Band 2	1851.5 ~ 1908.5	2M70G7D	QPSK	23.59	0.229
LTE Band 2	1851.5 ~ 1908.5	2M70W7D	16QAM	22.48	0.177
LTE Band 2	1850.7 ~ 1909.3	1M09G7D	QPSK	23.45	0.221
LTE Band 2	1850.7 ~ 1909.3	1M09W7D	16QAM	22.24	0.167

Note: This device supports both LTE Band 66(1710 ~ 1780MHz) and LTE Band 4(1710 ~ 1755MHz). And LTE Band 66 overlaps the entire frequency range of LTE Band 4. Therefore, test data provided in this report covers Band 4 as well as Band 66.

## 2. INTRODUCTION

### 2.1 EUT DESCRIPTION

The Equipment Under Test (EUT) supports WCDMA/LTE Phone with Bluetooth, WLAN, NFC.

### 2.2. EUT CAPABILITIES

This EUT contains the following capabilities:

850/1700/1900 WCDMA/HSUPA, Multi-band LTE, 802.11b/g/n WLAN(2.4GHz),  
802.11a/n/ac WLAN(5GHz), Bluetooth(BDR, EDR, LE), NFC.

### 2.3. TESTING ENVIRONMENT

Ambient Condition	
▪ Temperature	+21 °C ~ +24 °C
▪ Relative Humidity	38 % ~ 45 %

### 2.4 MEASURING INSTRUMENT CALIBRATION

The measuring equipment, which was utilized in performing the tests documented herein, has been calibrated in accordance with the manufacturer's recommendations for utilizing calibration equipment, which is traceable to recognized national standards.

### 2.5. MEASUREMENT UNCERTAINTY

The measurement uncertainties shown below were calculated in accordance with requirements of ANSI C 63.4-2014. All measurement uncertainty values are shown with a coverage factor of  $k = 2$  to indicate a 95 % level of confidence.

Parameter	Measurement uncertainty
Radiated Disturbance (Below 1 GHz)	5.1 dB (The confidence level is about 95 %, $k = 2$ )
Radiated Disturbance (1 GHz ~ 18 GHz)	5.4 dB (The confidence level is about 95 %, $k = 2$ )
Radiated Disturbance (Above 18 GHz)	5.3 dB (The confidence level is about 95 %, $k = 2$ )

### 2.6. TEST FACILITY

<b>DT&amp;C Co., Ltd.</b>	
The 3 m test site and conducted measurement facility used to collect the radiated data are located at the 42, Yurim-ro, 154beon-gil, Cheoin-gu, Yongin-si, Gyeonggi-do, Korea 17042. The test site complies with the requirements of § 2.948 according to ANSI 63.4-2014.	
<b>- FCC MRA Accredited Test Firm No. : KR0034</b>	
<a href="http://www.dtnc.net">www.dtnc.net</a>	
Telephone	: + 82-31-321-2664
FAX	: + 82-31-321-1664

### 3. DESCRIPTION OF TESTS

#### 3.1 ERP & EIRP (Effective Radiated Power & Equivalent Isotropic Radiated Power)

##### Test Set-up

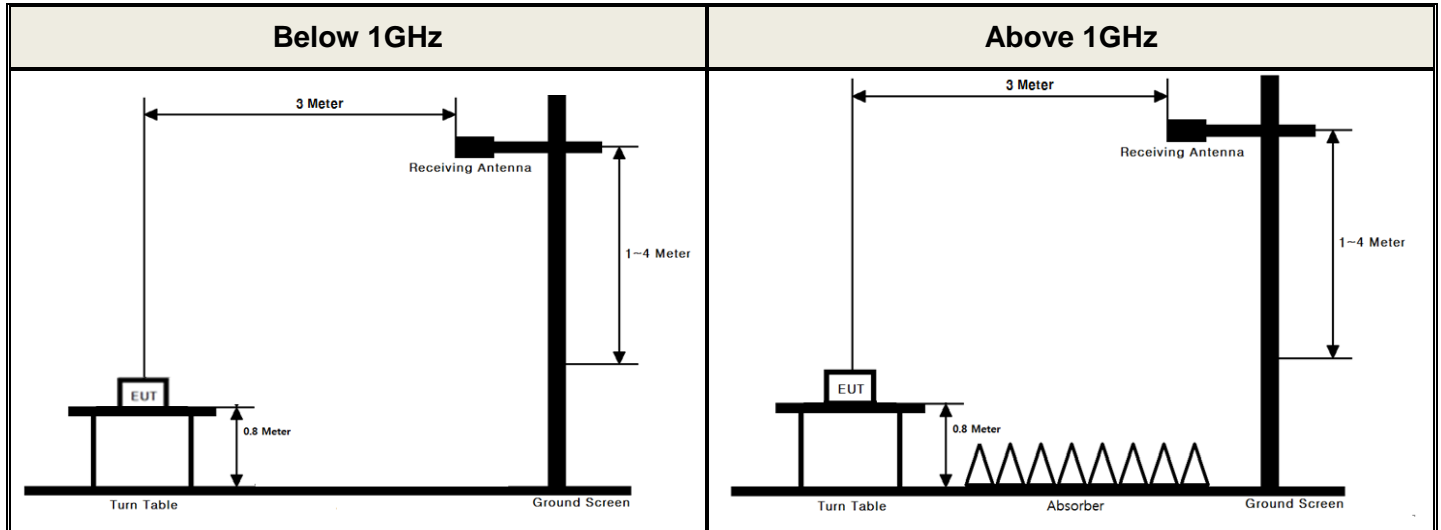

These measurements were performed at 3 m test site. The equipment under test is placed on a non-conductive table 0.8-meters above a turntable which is flush with the ground plane and 3 meters from the receive antenna. For measurements above 1GHz absorbers are placed on the floor between the turn table and the antenna mast in such a way so as to maximize the reduction of reflections. For measurements below 1 GHz, the absorbers are removed.

##### Test Procedure

- ANSI/TIA-603-E-2016 - Section 2.2.17
- KDB971168 D01v03 - Section 5.2.2
- ANSI C63.26-2015 – Section 5.2.4.4.1

##### Test setting

1. Set span to 2 x to 3 x the OBW.
2. Set RBW = 1% to 5% of the OBW.
3. Set VBW  $\geq$  3 x RBW.
4. Set number of points in sweep  $\geq$  2 x span / RBW.
5. Sweep time:
  - 1) Set = auto-couple, or
  - 2) Set  $\geq$  [10 x (number of points in sweep) x (transmission period)] for single sweep (automation-compatible) measurement. Transmission period is the on and off time of the transmitter.
6. Detector = power averaging (rms).
7. If the EUT can be configured to transmit continuously, then set the trigger to free run.
8. If the EUT cannot be configured to transmit continuously, then use a sweep trigger with the level set to enable triggering only on full power bursts and configure the EUT to transmit at full power for the entire duration of each sweep. Verify that the sweep time is less than or equal to the transmission burst duration. Time gating can also be used under similar constraints (i.e., configured such that measurement data is collected only during active full-power transmissions).
9. Trace average at least 100 traces in power averaging (rms) mode if sweep is set to auto-couple. To accurately determine the average power over multiple symbols, it can be necessary to increase the number of traces to be averaged above 100 or, if using a manually configured sweep time, increase the sweep time.



10. Compute the power by integrating the spectrum across the OBW of the signal using the instrument's band or channel power measurement function, with the band/channel limits set equal to the OBW band edges. If the instrument does not have a band or channel power function, then sum the spectrum levels (in linear power units) at intervals equal to the RBW extending across the entire OBW of the spectrum.

The receiver antenna height and turntable rotations were adjusted for the highest reading on the receive spectrum analyzer.

A half-wave dipole was substituted in place of the EUT. This dipole antenna was driven by a signal generator and the level of the signal generator was adjusted to obtain the same receive spectrum analyzer reading. The conducted power at the terminal of the substitute antenna is measured.

The ERP/EIRP is calculated using the following formula:

**ERP/EIRP = The conducted power at the substitute antenna's terminal [dBm] + Substitute Antenna gain [dBd for ERP , dBi for EIRP]**

For readings above 1 GHz, the above procedure is repeated using horn antennas and the difference between the gain of the horn antenna and an isotropic antenna are taken into consideration.

## 3.2 PEAK TO AVERAGE RATIO

### Test set-up

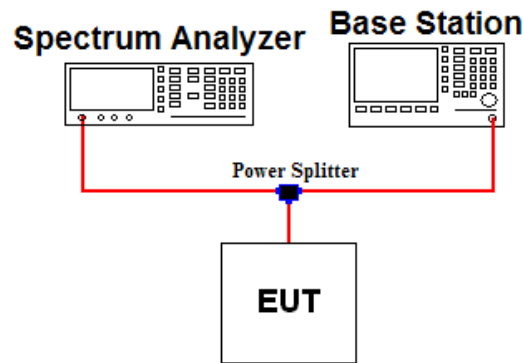

### Test Procedure

- KDB971168 D01v03 - Section 5.7.2
- ANSI C63.26-2015 – Section 5.2.3.4

A peak to average ratio measurement is performed at the conducted port of the EUT.

The spectrum analyzers Complementary Cumulative Distribution Function (CCDF) measurement profile is used to determine the largest deviation between the average and the peak power of the EUT in a given bandwidth. The CCDF curve shows how much time the peak waveform spends at or above a given average power level. The present of time the signal spends at or above the level defines the probability for that particular power level.

### Test setting

The spectrum Analyzer's CCDF measurement function is enabled.

1. Set resolution/measurement bandwidth  $\geq$  OBW or specified reference bandwidth.
2. Set the number of counts to a value that stabilizes the measured CCDF curve.
3. Set the measurement interval as follows:
  - 1) For continuous transmissions, set to the greater of  $[10 \times (\text{number of points in sweep}) \times (\text{transmission symbol period})]$  or 1 ms.
  - 2) For burst transmissions, employ an external trigger that is synchronized with the EUT burst timing sequence, or use the internal burst trigger with a trigger level that allows the burst to stabilize. Set the measurement interval to a time that is less than or equal to the burst duration.
  - 3) If there are several carriers in a single antenna port, the peak power shall be determined for each individual carrier (by disabling the other carriers while measuring the required carrier) and the total peak power calculated from the sum of the individual carrier peak powers.
4. Record the maximum PAPR level associated with a probability of 0.1%.
5. The peak power level is calculated from the sum of the PAPR value from step d) to the measured average power.

### 3.3 OCCUPIED BANDWIDTH.

#### Test set-up

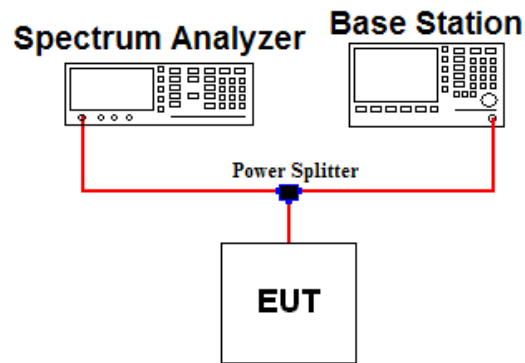

#### Test Procedure

- KDB971168 D01v03 - Section 4.3
- ANSI C63.26-2015 – Section 5.4.4

The occupied bandwidth, that is the frequency bandwidth such that, below its lower and above its upper frequency limits, the mean powers radiated are each equal to 0.5 percent of the total mean power of a given emission.

#### Test setting

1. The signal analyzer's automatic bandwidth measurement capability was used to perform the 99 % occupied bandwidth and the 26 dB bandwidth. The bandwidth measurement was not influenced by any intermediate power nulls in the fundamental emission.
2.  $RBW = 1 \sim 5 \%$  of the expected OBW &  $VBW \geq 3 \times RBW$
3. Detector = Peak
4. Trance mode = Max hold
5. Sweep = Auto couple
6. The trace was allowed to stabilize
7. If necessary, step 2 ~ 6 were repeated after changing the RBW such that it would be within 1 ~ 5 % of the 99 % occupied bandwidth observed in step 6.

### 3.4 BAND EDGE EMISSIONS AT ANTENNA TERMINAL

#### Test set-up

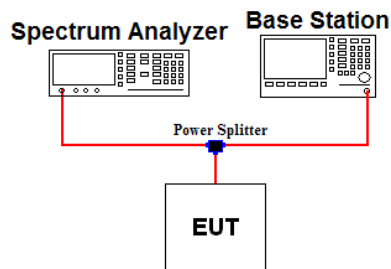

#### Test Procedure

- KDB971168 D01v03 - Section 6
- ANSI C63.26-2015 – Section 5.7

All out of band emissions are measured by means of a calibrated spectrum analyzer. The EUT was setup to maximum output power at its lowest and highest channel with all bandwidths, modulations and RB configurations.

The power of any spurious emission shall be attenuated below the transmitter power (P) by at least  $43 + 10 \log(P)$  dB.

#### Test setting

1. Start and stop frequency were set such that the band edge would be placed in the center of the plot
2. Span was set large enough so as to capture all out of band emissions near the band edge
3. RBW  $\geq 1\%$  of the emission bandwidth
4. VBW  $\geq 3 \times$  RBW
5. Detector = RMS & Trace mode = Max hold
6. Sweep time = Auto couple or 1 s for band edge
7. Number of sweep point  $\geq 2 \times$  span / RBW
8. The trace was allowed to stabilize

Note 1: Per Part 22.917(b)(1) / 24.238(b) / 27.53(h) in the 1 MHz bands immediately outside and adjacent to the frequency block a resolution bandwidth of at least one percent of the emission bandwidth of the fundamental emission of the transmitter may be employed to demonstrate compliance with the out-of-band emissions limit.

The emission bandwidth is defined as the width of the signal between two points, one below the carrier center frequency and one above the carrier center frequency, outside of which all emission are attenuated at least 26 dB below the transmitter power.

Note 2: Per Part 27(g) for operations in the 600 MHz band and the 698-746 MHz band, compliance with this provision is based on the use of measurement instrumentation employing a resolution bandwidth of 100 kilohertz or greater. However, in the 100 kilohertz bands immediately outside and adjacent to a licensee's frequency block, a resolution bandwidth of at least 30 kHz may be employed.

Note 3: Per Part 27.53(c.5) for operations in the 776-788 MHz band, compliance with this provision is based on the use of measurement instrumentation employing a resolution bandwidth of 100 kilohertz or greater. However, in the 100 kilohertz bands immediately outside and adjacent to a licensee's frequency block, a resolution bandwidth of at least 30 kHz may be employed.

Note 4: Per Part 27.53(c.4) for all frequencies between 763-775 MHz and 793-805 MHz, the FCC limit is  $65 + 10 \log_{10}(P[\text{Watts}]) - 35$  dBm in a 6.25 kHz bandwidth.

Note 3: Per Part 90.543(e) for operations in the 758-768 MHz and the 788-798 MHz bands, the power of any emission outside the licensee's frequency band(s) of operation shall be attenuated below the transmitter power (P) within the licensed band(s) of operation, measured in watts, in accordance with the following:

- (1) On all frequencies between 769-775 MHz and 799-805 MHz, by a factor not less than  $76 + 10 \log (P)$  dB in a 6.25 kHz band segment, for base and fixed stations.
- (2) On all frequencies between 769-775 MHz and 799-805 MHz, by a factor not less than  $65 + 10 \log (P)$  dB in a 6.25 kHz band segment, for mobile and portable stations.
- (3) On any frequency between 775-788 MHz, above 805 MHz, and below 758 MHz, by at least  $43 + 10 \log (P)$  dB.
- (4) Compliance with the provisions of paragraphs (e)(1) and (2) of this section is based on the use of measurement instrumentation such that the reading taken with any resolution bandwidth setting should be adjusted to indicate spectral energy in a 6.25 kHz segment.
- (5) Compliance with the provisions of paragraph (e)(3) of this section is based on the use of measurement instrumentation employing a resolution bandwidth of 100 kHz or greater. However, in the 100 kHz bands immediately outside and adjacent to the frequency block, a resolution bandwidth of 30 kHz may be employed.

### 3.5 SPURIOUS AND HARMONIC EMISSIONS AT ANTENNA TERMINAL

#### Test set-up

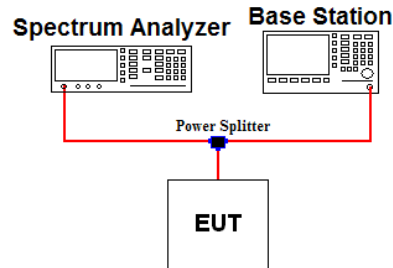

#### Test Procedure

- KDB971168 D01v03 - Section 6
- ANSI C63.26-2015 – Section 5.7

The level of the carrier and the various conducted spurious and harmonic frequencies is measured by means of a calibrated spectrum analyzer. The EUT was setup to maximum output power at its low, middle, high channel with all bandwidths, modulations and RB configurations. The spectrum is scanned from 9 kHz up to a frequency including its 10<sup>th</sup> harmonic.

The power of any spurious emission shall be attenuated below the transmitter power (P) by at least  $43 + 10 \log(P)$  dB.

#### Test setting

1. RBW = 100 kHz(Below 1 GHz) or 1 MHz(Above 1 GHz) & VBW  $\geq 3 \times$  RBW ( Refer to Note 1)
2. Detector = RMS & Trace mode = Max hold
3. Sweep time = Auto couple
4. Number of sweep point  $\geq 2 \times$  span / RBW
5. The trace was allowed to stabilize

Note 1: Compliance with these provisions is based on the use of measurement instrumentation employing a resolution bandwidth of 100 kHz or greater for frequencies less than 1GHz and 1MHz or greater for frequencies greater than 1GHz.

### 3.6 UNDESIRABLE EMISSIONS

#### Test Set-up

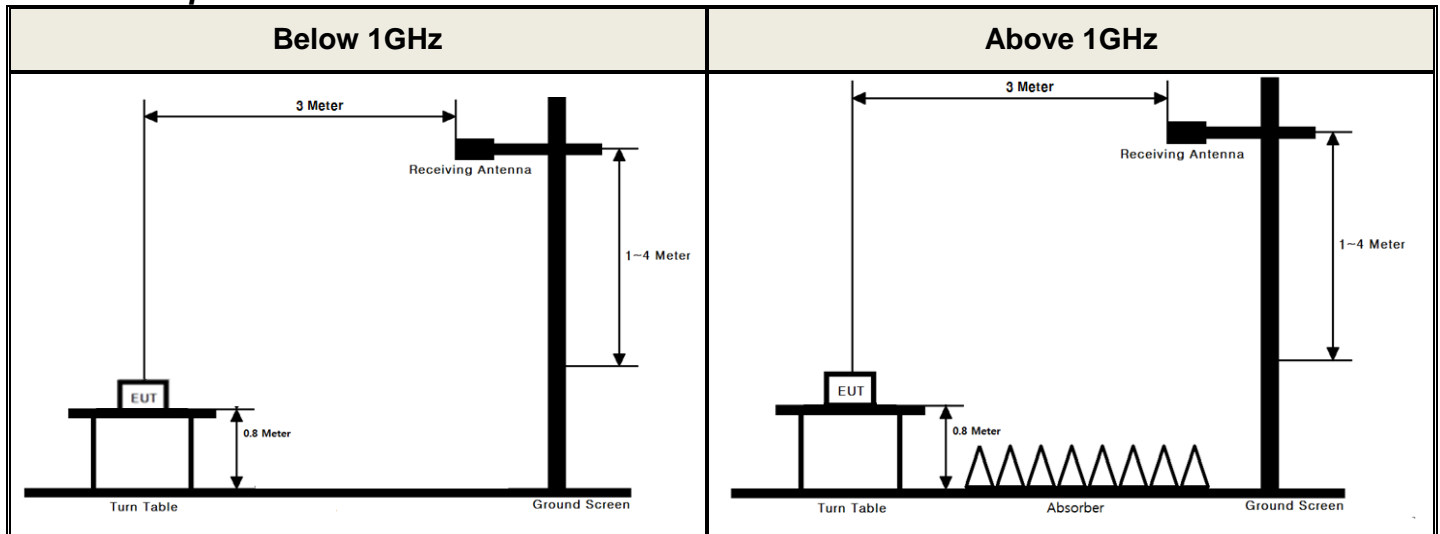

These measurements were performed at 3 test site. The equipment under test is placed on a non-conductive table 0.8-meters above a turntable which is flush with the ground plane and 3 meters from the receive antenna. For measurements above 1 GHz absorbers are placed on the floor between the turn table and the antenna mast in such a way so as to maximize the reduction of reflections. For measurements below 1 GHz, the absorbers are removed.

#### Test Procedure

- ANSI/TIA-603-E-2016 - Section 2.2.12
- KDB971168 D01v03 - Section 5.8
- ANSI C63.26-2015 – Section 5.5

#### Test setting

1. RBW = 100 kHz for below 1 GHz and 1 MHz for above 1 GHz / VBW  $\geq$  3 X RBW
2. Detector = RMS & Trace mode = Max hold
3. Sweep time = Auto couple
4. Number of sweep point  $\geq$  2 X span / RBW
5. The trace was allowed to stabilize

The receive antenna height and turntable rotations were adjusted for the highest reading on the receive spectrum analyzer.

For radiated power measurements below 1 GHz, a half-wave dipole was substituted in place of the EUT. This dipole antenna was driven by a signal generator and the level of the signal generator was adjusted to obtain the same spectrum analyzer reading.

For radiated power measurements above 1 GHz, a Horn antenna was substituted in place of the EUT. This Horn antenna was driven by a signal generator and the level of the signal generator was adjusted to obtain the same spectrum analyzer reading. The difference between the gain of the horn and an isotropic antenna are taken into consideration.

This measurement was performed with the EUT oriented in 3 orthogonal axis.

### 3.7 FREQUENCY STABILITY

#### Test Set-up

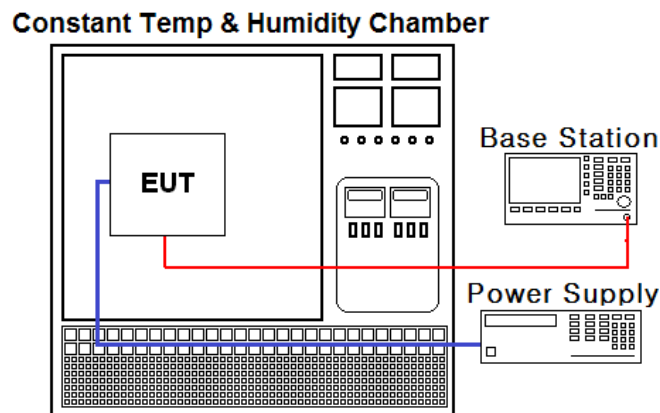

#### Test Procedure

- ANSI/TIA-603-E-2016
- KDB971168 D01v03 - Section 9

The frequency stability of the transmitter is measured by:

a.) **Temperature:**

The temperature is varied from - 30 °C to + 50 °C using an environmental chamber.

b.) **Primary Supply Voltage:**

The primary supply voltage is varied from 85 % to 115 % of the nominal value for non hand-carried battery and AC powered equipment. For hand-carried, battery-powered equipment, primary supply voltage is reduced to the battery operating end point which shall be specified by the manufacturer.

#### Specification:

The frequency stability shall be sufficient to ensure that the fundamental emission stays within the authorized frequency block for Part 24, 27. The frequency stability of the transmitter shall be maintained within  $\pm 0.00025\%$  ( $\pm 2.5$  ppm) of the center frequency for Part 22.

#### Time Period and Procedure:

1. The carrier frequency of the transmitter is measured at room temperature.  
(20 °C to provide a reference)
2. The equipment is turned on in a "standby" condition for one minute before applying power to the transmitter. Measurement of the carrier frequency of the transmitter is made within one minute after applying power to the transmitter.
3. Frequency measurements are made at 10 °C intervals ranging from -30 °C to +50 °C.  
A period of at least one half-hour is provided to allow stabilization of the equipment at each temperature level.



## 4. LIST OF TEST EQUIPMENT

Type	Manufacturer	Model	Cal.Date (yy/mm/dd)	Next.Cal. Date (yy/mm/dd)	S/N
Spectrum Analyzer	Agilent Technologies	N9020A	18/07/09	19/07/09	MY46471251
Spectrum Analyzer	Agilent Technologies	N9020A	18/12/20	19/12/20	MY50200828
DC power supply	Agilent Technologies	66332A	18/07/02	19/07/02	MY43001172
Multimeter	FLUKE	17B+	17/12/26 18/12/18	18/12/26 19/12/18	36390701WS
Power Splitter	Anritsu	K241B	18/12/19	19/12/19	016681
Temp & Humi	SJ Science	SJ-TH-S50	18/07/06	19/07/06	U5542113
Radio Communication Analyzer	Anritsu	MT8820C	18/07/03	19/07/03	6200978101
Thermohygrometer	BODYCOM	BJ5478	18/01/03 18/12/27	19/01/03 19/12/27	120612-1
Thermohygrometer	BODYCOM	BJ5478	18/01/03 18/12/27	19/01/03 19/12/27	120612-2
Signal Generator	Rohde Schwarz	SMBV100A	18/12/19	19/12/19	255571
Signal Generator	Rohde Schwarz	SMF100A	18/06/07	19/06/07	102341
Loop Antenna	Schwarzbeck	FMZB1513	18/01/30	20/01/30	1513-128
Bilog Antenna	Schwarzbeck	VULB 9160	18/07/13	20/07/13	3359
Dipole Antenna	Schwarzbeck	VHA9103	17/03/14	19/03/14	2116
Dipole Antenna	Schwarzbeck	VHA9103	18/04/13	20/04/13	2117
Dipole Antenna	Schwarzbeck	UHA9105	17/03/14	19/03/14	2261
Dipole Antenna	Schwarzbeck	UHA9105	18/04/13	20/04/13	2262
HORN ANT	ETS	3117	18/05/10	20/05/10	00140394
HORN ANT	ETS	3117	18/03/26	20/03/26	00152145
HORN ANT	A.H.Systems	SAS-574	17/04/25	19/04/25	154
HORN ANT	A.H.Systems	SAS-574	17/07/31	19/07/31	155
Amplifier	RF Bay Inc	MPA-40-40	18/12/20	19/12/20	21151801
Amplifier	EMPOWER	BBS3Q7ELU	18/07/10	19/07/10	1020
PreAmplifier	H.P	8447D	17/12/26 18/12/18	18/12/26 19/12/18	2944A07774
PreAmplifier	Agilent	8449B	18/07/05	19/07/05	3008A02108
High-pass filter	Wainwright	WHKX12-935-1000-15000-40SS	18/07/05	19/07/05	7
High-pass filter	Wainwright	WHKX12-2580-3000-18000-80SS	18/07/05	19/07/05	3
High-pass filter	Wainwright	WHNX8.5/26.5G-6SS	18/07/03	19/07/03	1
Cable	DTNC	Cable	18/07/06	19/07/06	M-01
Cable	DTNC	Cable	18/07/06	19/07/06	M-02
Cable	Junkosha	MWX315	18/11/19	19/11/19	M-05
Cable	Junkosha	MWX221	18/11/19	19/11/19	M-06
Cable	DTNC	Cable	18/07/05	19/07/05	RF-10
Cable	Radiall	TESTPRO3	18/07/05	19/07/05	RF-84

Note1: The measurement antennas were calibrated in accordance to the requirements of ANSI C63.5-2017.

Note2: The cable is not a regular calibration item, so it has been calibrated by DT & C itself.

## 5. SUMMARY OF TEST RESULTS

FCC Part Section(s)	Test Description	Test Limit	Test Condition	Status Note 1
2.1046	Conducted Output Power	N/A	Conducted	<b>C</b> Note2
2.1049	Occupied Bandwidth	N/A		<b>C</b>
24.232(d) 27.50(d.5)	Peak to Average Ratio	< 13 dB		<b>C</b>
2.1051 22.917(a) 24.238(a) 27.53(g) 27.53(h) 27.53(c)	Band Edge / Conducted Spurious Emissions	> 43 + 10log <sub>10</sub> (P) dB at Band edge and for all out-of-band emissions		<b>C</b>
27.53(c.4)	Undesirable Emissions in 763 ~ 775MHz & 793 ~ 805MHz	< 65 + 10 log10(P) dB		<b>C</b>
90.543(e)	Band Edge / Conducted Spurious Emissions	On all frequencies between 769-775 MHz and 799-805 MHz, by a factor not less than > 65 + 10 log (P) dB in a 6.25 kHz On any frequency between 775-788 MHz, above 805 MHz, and below 758 MHz, by at least > 43 + 10 log (P) dB.		<b>C</b>
2.1055 22.355 24.235 27.54 90.213	Frequency Stability	< 2.5 ppm (Part 22) Fundamental emissions must stay within Authorized frequency block (Part 24, 27) N/A (Part 90)		<b>C</b>
27.50(b.10) 27.50(c.10)	Radiated Output Power (B12, 13, 71)	< 3 Watts max. ERP		Radiated
22.913(a.5)	Radiated Output Power (B5)	< 7 Watts max. ERP	<b>C</b>	
27.50(d.4)	Radiated Output Power (B66, 4)	< 1 Watts max. EIRP	<b>C</b>	
24.232(c) 27.50(h.2)	Radiated Output Power(B2)	< 2 Watts max. EIRP	<b>C</b>	
90.542 (a.7)	Radiated Output Power(B14)	< 3 Watts max EIRP	<b>C</b>	
2.1053 22.917(a) 24.238(a) 27.53(g) 27.53(h) 27.53(c) 90.543 (e)	Undesirable Emissions	> 43 + 10log <sub>10</sub> (P) dB for all out-of-band emissions	<b>C</b>	
27.53(f) 90.543(f)	Undesirable Emissions in 1559 ~ 1610MHz	< -70 dBW/MHz (for wideband signals) < -80 dBW (for discrete emissions of less than 700 Hz bandwidth)	<b>C</b>	
Note 1: <b>C</b> =Comply <b>NC</b> =Not Comply <b>NT</b> =Not Tested <b>NA</b> =Not Applicable Note 2: Refer to RF Exposure Report (Test Report SAR)				

## 6. SAMPLE CALCULATION

### A. Emission Designator

#### LTE Band 71(QPSK)

Emission Designator = **17M9G7D**  
LTE OBW = 17.851 MHz  
G = Phase Modulation  
7 = Quantized/Digital Info  
D = Data Transmission

#### LTE Band 12(QPSK)

Emission Designator = **8M96G7D**  
LTE OBW = 8.964 MHz  
W = Amplitude/Angle Modulated  
7 = Quantized/Digital Info  
D = Data Transmission

#### LTE Band 13(QPSK)

Emission Designator = **8M93G7D**  
LTE OBW = 8.932 MHz  
G = Phase Modulation  
7 = Quantized/Digital Info  
D = Data Transmission

#### LTE Band 14(QPSK)

Emission Designator = **8M94G7D**  
LTE OBW = 8.938 MHz  
G = Phase Modulation  
7 = Quantized/Digital Info  
D = Data Transmission

#### LTE Band 5(QPSK)

Emission Designator = **8M97G7D**  
LTE OBW = 8.968 MHz  
G = Phase Modulation  
7 = Quantized/Digital Info  
D = Data Transmission

#### LTE Band 66, 4 (QPSK)

Emission Designator = **17M9G7D**  
LTE OBW = 17.873 MHz  
G = Phase Modulation  
7 = Quantized/Digital Info  
D = Data Transmission

#### LTE Band 71(16QAM)

Emission Designator = **17M9W7D**  
LTE OBW = 17.867 MHz  
W = Amplitude/Angle Modulated  
7 = Quantized/Digital Info  
D = Data Transmission

#### LTE Band 12(16QAM)

Emission Designator = **8M95W7D**  
LTE OBW = 8.947 MHz  
W = Amplitude/Angle Modulated  
7 = Quantized/Digital Info  
D = Data Transmission

#### LTE Band 13(16QAM)

Emission Designator = **8M92W7D**  
LTE OBW = 8.919 MHz  
W = Amplitude/Angle Modulated  
7 = Quantized/Digital Info  
D = Data Transmission

#### LTE Band 14(16QAM)

Emission Designator = **8M91W7D**  
LTE OBW = 8.914 MHz  
W = Amplitude/Angle Modulated  
7 = Quantized/Digital Info  
D = Data Transmission

#### LTE Band 5(16QAM)

Emission Designator = **8M96W7D**  
LTE OBW = 8.957 MHz  
W = Amplitude/Angle Modulated  
7 = Quantized/Digital Info  
D = Data Transmission

#### LTE Band 66, 4(16QAM)

Emission Designator = **17M9W7D**  
LTE OBW = 17.861 MHz  
W = Amplitude/Angle Modulated  
7 = Quantized/Digital Info  
D = Data Transmission

**LTE Band 2(QPSK)**Emission Designator = **17M9G7D**

LTE OBW = 17.857 MHz

G = Phase Modulation

7 = Quantized/Digital Info

D = Data Transmission

**LTE Band 2(16QAM)**Emission Designator = **17M8W7D**

LTE OBW = 17.844 MHz

W = Amplitude/Angle Modulated

7 = Quantized/Digital Info

D = Data Transmission

## B. For substitution method

### EIRP for Band 2

Channel Bandwidth (MHz)	Test Frequency (MHz)	Test Mode	RB Size/ Offset	Spectrum Reading Value(dBm)	EUT Axis	Ant Pol (H/V)	Level(dBm) @ Ant Terminal	TX Ant Gain (dBi)	EIRP (dBm)	EIRP (W)
20	1860	QPSK	1/50	-23.28	X	H	18.77	4.91	23.68	0.233

### ERP or EIRP = Level @ Ant Terminal LEVEL(dBm) + Tx Ant. Gain

- 1) The EUT mounted on a non-conductive turntable is 0.8 meter above test site ground level.
- 2) During the test, the turn table is rotated until the maximum signal is found.
- 3) Record the field strength meter's level.
- 4) Replace the EUT with dipole/Horn antenna that is connected to a calibrated signal generator.
- 5) Increase the signal generator output till the field strength meter's level is equal to the item (3).
- 6) The signal generator output level with substituted antenna gain is the rating of ERP, EIRP or Radiated spurious emission.

## 7. TEST DATA

### 7.1 OCCUPIED BANDWIDTH

- Plots of the EUT's Occupied Bandwidth are shown in Clause 8.1

### 7.2 PEAK TO AVERAGE RATIO

- Plots of the EUT's Peak- to- Average Ratio are shown in Clause 8.2

### 7.3 BAND EDGE EMISSIONS (Conducted)

- Plots of the EUT's Band Edge Emissions are shown in Clause 8.3

### 7.4 SPURIOUS AND HARMONICS EMISSIONS (Conducted)

- Plots of the EUT's Spurious Emissions are shown in Clause 8.4

## 7.5 ERP & EIRP

### 7.5.1 LTE Band 71

Channel Bandwidth (MHz)	Test Frequency (MHz)	Test Mode	RB Size/Offset	Ant Pol (H/V)	Level(dBm) @ Ant Terminal	TX Ant Gain (dBd)	ERP (dBm)	ERP (W)
20	665.5	QPSK	1/50	H	19.13	1.43	20.56	0.114
		16QAM	1/50	H	18.22	1.43	19.65	0.092
	695.5	QPSK	1/50	H	18.19	1.30	19.49	0.089
		16QAM	1/50	H	17.00	1.30	18.30	0.068
15	670.5	QPSK	1/0	H	18.89	1.41	20.30	0.107
		16QAM	1/0	H	17.04	1.41	18.45	0.070
	680.5	QPSK	1/36	H	16.79	1.36	18.15	0.065
		16QAM	1/36	H	15.64	1.36	17.00	0.050
	690.5	QPSK	1/74	H	18.03	1.32	19.35	0.086
		16QAM	1/74	H	16.62	1.32	17.94	0.062
10	668	QPSK	1/25	H	19.24	1.42	20.66	0.116
		16QAM	1/25	H	18.39	1.42	19.81	0.096
	680.5	QPSK	1/25	H	16.55	1.36	17.91	0.062
		16QAM	1/25	H	15.45	1.36	16.81	0.048
	693	QPSK	1/49	H	17.91	1.31	19.22	0.084
		16QAM	1/49	H	16.96	1.31	18.27	0.067
5	665.5	QPSK	1/12	H	19.10	1.43	20.53	0.113
		16QAM	1/12	H	18.27	1.43	19.70	0.093
	680.5	QPSK	1/0	H	16.97	1.36	18.33	0.068
		16QAM	1/0	H	15.71	1.36	17.07	0.051
	695.5	QPSK	1/24	H	17.61	1.30	18.91	0.078
		16QAM	1/24	H	16.35	1.30	17.65	0.058

Note: This device was tested under all bandwidths, modulations and RB configurations and the worst case data are reported in the table above.

### 7.5.2 LTE Band 12

Channel Bandwidth (MHz)	Test Frequency (MHz)	Test Mode	RB Size/ Offset	Ant Pol (H/V)	Level(dBm) @ Ant Terminal	TX Ant Gain (dBd)	ERP (dBm)	ERP (W)
10	704	QPSK	1/25	H	14.80	1.28	16.08	0.041
		16QAM	1/25	H	13.62	1.28	14.90	0.031
	711	QPSK	1/25	H	15.24	1.28	16.52	0.045
		16QAM	1/25	H	13.83	1.28	15.11	0.032
5	701.5	QPSK	1/12	H	14.38	1.28	15.66	0.037
		16QAM	1/12	H	12.84	1.28	14.12	0.026
	707.5	QPSK	1/12	H	15.06	1.28	16.34	0.043
		16QAM	1/12	H	13.89	1.28	15.17	0.033
	713.5	QPSK	1/24	H	14.59	1.28	15.87	0.039
		16QAM	1/24	H	13.55	1.28	14.83	0.030
3	700.5	QPSK	1/14	H	14.41	1.28	15.69	0.037
		16QAM	1/14	H	13.22	1.28	14.50	0.028
	707.5	QPSK	1/7	H	15.22	1.28	16.50	0.045
		16QAM	1/7	H	13.71	1.28	14.99	0.032
	714.5	QPSK	1/14	H	15.18	1.28	16.46	0.044
		16QAM	1/14	H	13.93	1.28	15.21	0.033
1.4	699.7	QPSK	1/2	H	14.32	1.28	15.60	0.036
		16QAM	1/2	H	12.79	1.28	14.07	0.026
	707.5	QPSK	1/2	H	15.11	1.28	16.39	0.044
		16QAM	1/2	H	13.82	1.28	15.10	0.032
	715.3	QPSK	1/2	H	14.82	1.28	16.10	0.041
		16QAM	1/2	H	13.63	1.28	14.91	0.031

Note: This device was tested under all bandwidths, modulations and RB configurations and the worst case data are reported in the table above.



### 7.5.3 LTE Band 13

Channel Bandwidth (MHz)	Test Frequency (MHz)	Test Mode	RB Size/ Offset	Ant Pol (H/V)	Level(dBm) @ Ant Terminal	TX Ant Gain (dBd)	ERP (dBm)	ERP (W)
10	782	QPSK	1/25	H	15.51	1.26	16.77	0.048
		16QAM	1/25	H	14.19	1.26	15.45	0.035
5	779.5	QPSK	1/0	H	15.17	1.26	16.43	0.044
		16QAM	1/0	H	14.11	1.26	15.37	0.034
	784.5	QPSK	1/12	H	15.49	1.25	16.74	0.047
		16QAM	1/12	H	14.02	1.25	15.27	0.034

Note: This device was tested under all bandwidths, modulations and RB configurations and the worst case data are reported in the table above.

### 7.5.4 LTE Band 14

Channel Bandwidth (MHz)	Test Frequency (MHz)	Test Mode	RB Size/ Offset	Ant Pol (H/V)	Level(dBm) @ Ant Terminal	TX Ant Gain (dBd)	ERP (dBm)	ERP (W)
10	793	QPSK	1/25	H	17.92	1.25	19.17	0.083
		16QAM	1/25	H	16.50	1.25	17.75	0.060
5	790.5	QPSK	1/12	H	17.21	1.25	18.46	0.070
		16QAM	1/12	H	16.10	1.25	17.35	0.054
	795.5	QPSK	1/12	H	18.67	1.25	19.92	0.098
		16QAM	1/12	H	16.63	1.25	17.88	0.061

Note: This device was tested under all bandwidths, modulations and RB configurations and the worst case data are reported in the table above.

### 7.5.5 LTE Band 5

Channel Bandwidth (MHz)	Test Frequency (MHz)	Test Mode	RB Size/ Offset	Ant Pol (H/V)	Level(dBm) @ Ant Terminal	TX Ant Gain (dBd)	ERP (dBm)	ERP (W)
10	829	QPSK	1/25	H	20.78	1.23	22.01	0.159
		16QAM	1/25	H	19.49	1.23	20.72	0.118
	836.5	QPSK	1/49	H	20.57	1.22	21.79	0.151
		16QAM	1/49	H	20.02	1.22	21.24	0.133
	844	QPSK	1/25	H	20.95	1.21	22.16	0.164
		16QAM	1/25	H	20.01	1.21	21.22	0.132
5	826.5	QPSK	1/12	H	21.09	1.23	22.32	0.171
		16QAM	1/12	H	19.76	1.23	20.99	0.126
	836.5	QPSK	1/12	H	19.90	1.22	21.12	0.129
		16QAM	1/12	H	18.42	1.22	19.64	0.092
	846.5	QPSK	1/24	H	20.15	1.21	21.36	0.137
		16QAM	1/24	H	18.71	1.21	19.92	0.098
3	825.5	QPSK	1/14	H	21.00	1.23	22.23	0.167
		16QAM	1/14	H	19.68	1.23	20.91	0.123
	836.5	QPSK	1/0	H	19.71	1.22	20.93	0.124
		16QAM	1/0	H	18.04	1.22	19.26	0.084
	847.5	QPSK	1/7	H	20.69	1.21	21.90	0.155
		16QAM	1/7	H	19.26	1.21	20.47	0.111
1.4	824.7	QPSK	1/2	H	21.40	1.23	22.63	0.183
		16QAM	1/2	H	20.28	1.23	21.51	0.142
	836.5	QPSK	1/2	H	20.36	1.22	21.58	0.144
		16QAM	1/2	H	18.88	1.22	20.10	0.102
	848.3	QPSK	1/2	H	20.76	1.21	21.97	0.157
		16QAM	1/2	H	19.32	1.21	20.53	0.113

Note: This device was tested under all bandwidths, modulations and RB configurations and the worst case data are reported in the table above.

**7.5.6 LTE Band 66, 4**

Channel Bandwidth (MHz)	Test Frequency (MHz)	Test Mode	RB Size/Offset	Ant Pol (H/V)	Level(dBm) @ Ant Terminal	TX Ant Gain (dBi)	EIRP (dBm)	EIRP (W)
20	1720	QPSK	1/99	H	17.25	5.95	23.20	0.209
		16QAM	1/99	H	16.10	5.95	22.05	0.160
	1745	QPSK	1/0	H	17.74	5.73	23.47	0.222
		16QAM	1/0	H	16.65	5.73	22.38	0.173
	1770	QPSK	1/50	H	17.98	5.42	23.40	0.219
		16QAM	1/50	H	16.90	5.42	22.32	0.171
15	1717.5	QPSK	1/0	H	16.83	5.97	22.80	0.191
		16QAM	1/0	H	16.33	5.97	22.30	0.170
	1745	QPSK	1/0	H	17.64	5.73	23.37	0.217
		16QAM	1/0	H	16.46	5.73	22.19	0.166
	1772.5	QPSK	1/74	H	16.34	5.39	21.73	0.149
		16QAM	1/74	H	15.16	5.39	20.55	0.114
10	1715	QPSK	1/0	H	16.65	6.00	22.65	0.184
		16QAM	1/0	H	15.48	6.00	21.48	0.141
	1745	QPSK	1/0	H	17.65	5.73	23.38	0.218
		16QAM	1/0	H	16.06	5.73	21.79	0.151
	1775	QPSK	1/25	H	16.90	5.36	22.26	0.168
		16QAM	1/25	H	15.60	5.36	20.96	0.125
5	1712.5	QPSK	1/0	H	16.48	6.02	22.50	0.178
		16QAM	1/0	H	15.44	6.02	21.46	0.140
	1745	QPSK	1/0	H	17.26	5.73	22.99	0.199
		16QAM	1/0	H	15.98	5.73	21.71	0.148
	1777.5	QPSK	1/0	H	16.39	5.32	21.71	0.148
		16QAM	1/0	H	14.85	5.32	20.17	0.104
3	1711.5	QPSK	1/0	H	16.39	6.03	22.42	0.175
		16QAM	1/0	H	14.99	6.03	21.02	0.126
	1745	QPSK	1/0	H	17.08	5.73	22.81	0.191
		16QAM	1/0	H	16.01	5.73	21.74	0.149
	1778.5	QPSK	1/0	H	16.82	5.31	22.13	0.163
		16QAM	1/0	H	15.55	5.31	20.86	0.122
1.4	1710.7	QPSK	1/2	H	16.40	6.03	22.43	0.175
		16QAM	1/2	H	15.22	6.03	21.25	0.133
	1745	QPSK	1/2	H	17.09	5.73	22.82	0.191
		16QAM	1/2	H	16.00	5.73	21.73	0.149
	1779.3	QPSK	1/2	H	16.43	5.30	21.73	0.149
		16QAM	1/2	H	15.09	5.30	20.39	0.109

Note: This device was tested under all bandwidths, modulations and RB configurations and the worst case data are reported in the table above.

### 7.5.7 LTE Band 2

Channel Bandwidth (MHz)	Test Frequency (MHz)	Test Mode	RB Size/Offset	Ant Pol (H/V)	Level(dBm) @ Ant Terminal	TX Ant Gain (dBi)	EIRP (dBm)	EIRP (W)
20	1860	QPSK	1/50	H	18.77	4.91	23.68	0.233
		16QAM	1/50	H	17.35	4.91	22.26	0.168
	1880	QPSK	1/0	H	17.97	4.80	22.77	0.189
		16QAM	1/0	H	17.00	4.80	21.80	0.151
	1900	QPSK	1/0	H	18.84	4.69	23.53	0.225
		16QAM	1/0	H	17.75	4.69	22.44	0.175
15	1857.5	QPSK	1/74	H	19.64	4.92	24.56	0.286
		16QAM	1/74	H	18.59	4.92	23.51	0.224
	1880	QPSK	1/74	H	18.31	4.80	23.11	0.205
		16QAM	1/74	H	17.18	4.80	21.98	0.158
	1902.5	QPSK	1/74	H	19.27	4.68	23.95	0.248
		16QAM	1/74	H	17.75	4.68	22.43	0.175
10	1855	QPSK	1/25	H	18.94	4.94	23.88	0.244
		16QAM	1/25	H	17.70	4.94	22.64	0.184
	1880	QPSK	1/25	H	18.06	4.80	22.86	0.193
		16QAM	1/25	H	16.68	4.80	21.48	0.141
	1905	QPSK	1/49	H	18.87	4.67	23.54	0.226
		16QAM	1/49	H	17.54	4.67	22.21	0.166
5	1852.5	QPSK	1/12	H	18.24	4.95	23.19	0.208
		16QAM	1/12	H	17.30	4.95	22.25	0.168
	1880	QPSK	1/24	H	17.91	4.80	22.71	0.187
		16QAM	1/24	H	16.64	4.80	21.44	0.139
	1907.5	QPSK	1/24	H	19.06	4.65	23.71	0.235
		16QAM	1/24	H	17.53	4.65	22.18	0.165
3	1851.5	QPSK	1/0	H	18.07	4.95	23.02	0.200
		16QAM	1/0	H	17.06	4.95	22.01	0.159
	1880	QPSK	1/0	H	17.94	4.80	22.74	0.188
		16QAM	1/0	H	16.89	4.80	21.69	0.148
	1908.5	QPSK	1/14	H	18.94	4.65	23.59	0.229
		16QAM	1/14	H	17.83	4.65	22.48	0.177
1.4	1850.7	QPSK	1/2	H	18.26	4.96	23.22	0.210
		16QAM	1/2	H	17.05	4.96	22.01	0.159
	1880	QPSK	1/2	H	18.25	4.80	23.05	0.202
		16QAM	1/2	H	16.93	4.80	21.73	0.149
	1909.3	QPSK	1/2	H	18.81	4.64	23.45	0.221
		16QAM	1/2	H	17.60	4.64	22.24	0.167

Note: This device was tested under all bandwidths, modulations and RB configurations and the worst case data are reported in the table above.

## 7.6 UNDESIRABLE EMISSIONS (Radiated)

### 7.6.1 LTE Band 71

B.W (MHz)	Test Freq. (MHz)	RB Size/ Offset	Test Mode	Freq.(MHz)	Ant Pol (H/V)	Level(dBm) @ Ant Terminal	TX Ant Gain(dBd)	Result		Limit (dBc)
								(dBm)	(dBc)	
20	665.5	1/50	QPSK	1345.96	H	-54.90	2.39	-52.51	73.07	33.56
				2019.29	H	-51.14	2.67	-48.47	69.03	
			16QAM	1346.33	H	-55.38	2.40	-52.98	72.63	32.65
				2019.47	H	-53.80	2.67	-51.13	70.78	
	695.5	1/50	QPSK	1376.53	H	-55.22	2.59	-52.63	72.12	32.49
				2064.15	H	-50.86	2.86	-48.00	67.49	
16QAM			1376.01	H	-55.42	2.59	-52.83	71.13	31.30	
			2064.23	H	-52.00	2.86	-49.14	67.44		
15	670.5	1/0	QPSK	1327.82	H	-54.48	1.98	-52.50	72.80	33.30
				1991.23	H	-52.72	2.53	-50.19	70.49	
			16QAM	1327.90	H	-55.11	1.98	-53.13	71.58	31.45
				1991.23	H	-53.77	2.53	-51.24	69.69	
	680.5	1/36	QPSK	1360.41	H	-55.14	2.52	-52.62	70.77	31.15
				2041.03	H	-52.52	2.76	-49.76	67.91	
			16QAM	1360.48	H	-56.21	2.52	-53.69	70.69	30.00
				2040.64	H	-52.09	2.76	-49.33	66.33	
	690.5	1/74	QPSK	1394.50	H	-55.13	2.67	-52.46	71.81	32.35
				1394.64	H	-56.00	2.67	-53.33	72.68	
			16QAM	1394.64	H	-55.13	2.67	-52.46	70.40	30.94
				2091.38	H	-52.16	2.97	-49.19	67.13	
10	668	1/25	QPSK	1335.92	H	-55.24	2.16	-53.08	73.74	33.66
				2004.11	H	-52.64	2.61	-50.03	70.69	
			16QAM	1335.89	H	-56.10	2.16	-53.94	73.75	32.81
				2004.46	H	-51.95	2.61	-49.34	69.15	
	680.5	1/25	QPSK	1361.16	H	-54.79	2.53	-52.26	70.17	30.91
				2041.83	H	-49.72	2.77	-46.95	64.86	
			16QAM	1361.20	H	-55.45	2.53	-52.92	69.73	29.81
				2041.47	H	-50.27	2.76	-47.51	64.32	
	693	1/49	QPSK	1394.73	H	-55.38	2.67	-52.71	71.93	32.22
				2092.19	H	-50.81	2.98	-47.83	67.05	
			16QAM	1394.74	H	-55.87	2.67	-53.20	71.47	31.27
				2092.41	H	-52.27	2.98	-49.29	67.56	

B.W (MHz)	Test Freq. (MHz)	RB Size/ Offset	Test Mode	Freq.(MHz)	Ant Pol (H/V)	Level(dBm) @ Ant Terminal	TX Ant Gain(dBd)	Result		Limit (dBc)
								(dBm)	(dBc)	
5	665.5	1/12	QPSK	1330.59	H	-55.74	2.04	-53.70	74.23	33.53
				1996.27	H	-51.72	2.57	-49.15	69.68	
			16QAM	1331.23	H	-56.26	2.06	-54.20	73.90	32.70
				1996.72	H	-53.03	2.57	-50.46	70.16	
	680.5	1/0	QPSK	1356.47	H	-54.78	2.51	-52.27	70.60	31.33
				2034.81	H	-52.43	2.74	-49.69	68.02	
			16QAM	1356.72	H	-55.32	2.51	-52.81	69.88	30.07
				2034.95	H	-51.76	2.74	-49.02	66.09	
	695.5	1/24	QPSK	1395.24	H	-54.37	2.67	-51.70	70.61	31.91
				2093.06	H	-53.00	2.98	-50.02	68.93	
			16QAM	1395.18	H	-55.03	2.67	-52.36	70.01	30.65
				2092.91	H	-52.54	2.98	-49.56	67.21	

Note 1: Limit Calculation =  $43 + 10\log_{10}(P[\text{Watts}])$

Note 2: This device was tested under all bandwidths, modulations and RB configurations and the worst case data are reported in the table above.

Note 3: The frequency spectrum is examined from 9 kHz to the 10th harmonic of the fundamental frequency of the transmitter. No other spurious and harmonic emissions were reported greater than listed emissions above table.

**7.6.2 LTE Band 12**

B.W (MHz)	Test Freq. (MHz)	RB Size/ Offset	Test Mode	Freq.(MHz)	Ant Pol (H/V)	Level(dBm) @ Ant Terminal	TX Ant Gain(dBd)	Result		Limit (dBc)	
								(dBm)	(dBc)		
10	704	1/25	QPSK	1408.61	V	-57.66	2.78	-54.88	70.96	29.08	
				2112.15	H	-48.42	3.06	-45.36	61.44		
				2816.49	V	-49.46	4.86	-44.60	60.68		
				3521.41	H	-55.61	6.10	-49.51	65.59		
			16QAM	1408.77	V	-58.23	2.78	-55.45	70.35		27.90
				2112.54	H	-49.29	3.06	-46.23	61.13		
	711	1/25	QPSK	2816.35	V	-50.88	4.86	-46.02	60.92	28.11	
				3519.05	H	-55.41	6.10	-49.31	64.21		
				1422.36	V	-54.62	2.92	-51.70	68.22		
			16QAM	2133.40	H	-47.89	3.15	-44.74	61.26		
				2844.38	V	-49.85	4.95	-44.90	61.42		
				3555.26	H	-53.36	6.17	-47.19	63.71		
5	701.5	1/12	QPSK	1422.34	V	-54.92	2.92	-52.00	67.11	28.11	
				2133.31	H	-48.68	3.15	-45.53	60.64		
				2844.37	V	-48.00	4.95	-43.05	58.16		
				3555.25	H	-52.97	6.17	-46.80	61.91		
			16QAM	1402.91	V	-56.52	2.72	-53.80	69.46		28.66
				2104.49	H	-48.41	3.03	-45.38	61.04		
	707.5	1/12	QPSK	3806.08	V	-52.39	6.07	-46.32	61.98	27.12	
				3507.97	H	-55.72	6.07	-49.65	65.31		
				1402.17	V	-57.71	2.71	-55.00	69.12		
			16QAM	2104.44	H	-50.13	3.03	-47.10	61.22		29.34
				2806.25	V	-51.06	4.83	-46.23	60.35		
				3507.68	H	-55.70	6.07	-49.63	63.75		
713.5	1/24	QPSK	1415.06	V	-54.70	2.84	-51.86	68.20	28.87		
			2122.69	H	-47.27	3.11	-44.16	60.50			
			2830.05	V	-47.67	4.91	-42.76	59.10			
		16QAM	3537.47	H	-53.15	6.14	-47.01	63.35		27.83	
			1414.90	V	-57.40	2.84	-54.56	69.73			
			2122.72	H	-50.12	3.11	-47.01	62.18			
713.5	1/24	QPSK	2830.16	V	-48.93	4.91	-44.02	59.19	27.83		
			3537.30	H	-53.02	6.14	-46.88	62.05			
			1431.12	V	-57.39	3.01	-54.38	70.25			
		16QAM	2146.99	H	-49.55	3.21	-46.34	62.21		28.87	
			2862.67	V	-49.67	5.01	-44.66	60.53			
			3578.30	H	-52.64	6.19	-46.45	62.32			
16QAM	1431.12	V	-61.07	3.01	-58.06	72.89	27.83				
	2147.08	H	-50.14	3.21	-46.93	61.76					
	2862.44	V	-50.32	5.01	-45.31	60.14					
				3578.17	H	-53.63	6.19	-47.44	62.27		



B.W (MHz)	Test Freq. (MHz)	RB Size/ Offset	Test Mode	Freq.(MHz)	Ant Pol (H/V)	Level(dBm) @ Ant Terminal	TX Ant Gain(dBd)	Result		Limit (dBc)
								(dBm)	(dBc)	
3	700.5	1/14	QPSK	1403.57	V	-55.11	2.73	-52.38	68.07	28.69
				2105.54	H	-48.89	3.03	-45.86	61.55	
				2807.30	V	-52.73	4.83	-47.90	63.59	
				3509.82	H	-54.68	6.07	-48.61	64.30	
			16QAM	1403.34	V	-57.38	2.72	-54.66	69.16	27.50
				2105.42	H	-49.32	3.03	-46.29	60.79	
				2807.23	V	-53.00	4.83	-48.17	62.67	
				3510.42	H	-55.00	6.08	-48.92	63.42	
	707.5	1/7	QPSK	1415.27	V	-55.68	2.85	-52.83	69.33	29.50
				2122.52	H	-48.55	3.10	-45.45	61.95	
				2829.92	V	-48.21	4.91	-43.30	59.80	
				3537.52	H	-53.83	6.14	-47.69	64.19	
			16QAM	1415.00	V	-56.72	2.84	-53.88	68.87	27.99
				2122.64	H	-49.63	3.11	-46.52	61.51	
				2830.04	V	-48.43	4.91	-43.52	58.51	
				3537.40	H	-54.48	6.14	-48.34	63.33	
714.5	1/14	QPSK	1431.59	V	-55.82	3.01	-52.81	69.27	29.46	
			2147.41	H	-48.87	3.21	-45.66	62.12		
			2863.03	V	-49.03	5.01	-44.02	60.48		
			3578.80	H	-54.89	6.19	-48.70	65.16		
		16QAM	1431.59	V	-56.94	3.01	-53.93	69.14	28.21	
			2147.43	H	-50.63	3.21	-47.42	62.63		
			2862.94	V	-49.92	5.01	-44.91	60.12		
			3578.87	H	-54.45	6.19	-48.26	63.47		

B.W (MHz)	Test Freq. (MHz)	RB Size/ Offset	Test Mode	Freq.(MHz)	Ant Pol (H/V)	Level(dBm) @ Ant Terminal	TX Ant Gain(dBd)	Result		Limit (dBc)	
								(dBm)	(dBc)		
1.4	699.7	1/2	QPSK	1399.19	V	-55.96	2.69	-53.27	68.87	28.60	
				2098.88	H	-47.83	3.01	-44.82	60.42		
				2798.59	V	-50.01	4.80	-45.21	60.81		
				3498.44	H	-54.55	6.05	-48.50	64.10		
			16QAM	1399.24	V	-57.21	2.69	-54.52	68.59		27.07
				2098.96	H	-49.06	3.01	-46.05	60.12		
				2798.59	V	-50.28	4.80	-45.48	59.55		
				3497.67	H	-54.79	6.04	-48.75	62.82		
	707.5	1/2	QPSK	1414.97	V	-56.15	2.84	-53.31	69.70	29.39	
				2122.34	H	-49.24	3.10	-46.14	62.53		
				2829.73	V	-47.97	4.91	-43.06	59.45		
				3536.97	H	-53.56	6.14	-47.42	63.81		
			16QAM	1414.79	V	-56.58	2.84	-53.74	68.84	28.10	
				2122.30	H	-50.69	3.10	-47.59	62.69		
				2829.66	V	-48.12	4.90	-43.22	58.32		
				3536.79	H	-54.32	6.14	-48.18	63.28		
715.3	1/2	QPSK	1430.20	V	-56.01	3.00	-53.01	69.11	29.10		
			2145.59	H	-49.41	3.20	-46.21	62.31			
			2860.60	V	-51.14	5.00	-46.14	62.24			
			3576.02	H	-53.75	6.19	-47.56	63.66			
		16QAM	1430.50	V	-56.85	3.00	-53.85	68.76	27.91		
			2145.74	H	-51.17	3.20	-47.97	62.88			
			2860.91	V	-51.33	5.00	-46.33	61.24			
			3576.22	H	-53.99	6.19	-47.80	62.71			

Note 1: Limit Calculation =  $43 + 10\log_{10}(P[\text{Watts}])$

Note 2: This device was tested under all bandwidths, modulations and RB configurations and the worst case data are reported in the table above.

Note 3: The frequency spectrum is examined from 9 kHz to the 10th harmonic of the fundamental frequency of the transmitter. No other spurious and harmonic emissions were reported greater than listed emissions above table.

### 7.6.3 LTE Band 13

B.W (MHz)	Test Freq. (MHz)	Test Mode	RB Size/ Offset	Freq.(MHz)	Ant Pol (H/V)	Level(dBm) @ Ant Terminal	TX Ant Gain(dBd)	Result		Limit (dBc)
								(dBm)	(dBc)	
5	779.5	QPSK	1/0	1554.52	H	-56.83	3.79	-53.04	69.47	29.43
		16QAM	1/0	1554.70	H	-57.94	3.79	-54.15	69.52	28.37

Note 1: Limit Calculation =  $43 + 10\log_{10}(P[\text{Watts}])$

Note 2: This device was tested under all bandwidths, modulations and RB configurations and the worst case data are reported in the table above.

Note 3: The frequency spectrum is examined from 9 kHz to the 10th harmonic of the fundamental frequency of the transmitter. No other spurious and harmonic emissions were reported greater than listed emissions above table.

### UNDESIRABLE EMISSIONS IN 1559~1610MHz (LTE Band 13)

B.W (MHz)	Test Freq. (MHz)	Test Mode	RB Size/ Offset	Freq.(MHz)	Ant Pol (H/V)	Level(dBm) @ Ant Terminal	TX Ant Gain(dBi)	Result	Margin	Limit (dBm/MHz)
								(dBm)	(dB)	
10	782	QPSK	1/25	1564.26	H	-56.60	5.95	-50.65	10.65	-40.00
		16QAM	1/25	1564.10	H	-57.82	5.95	-51.87	11.87	
5	784.5	QPSK	1/12	1569.34	H	-56.00	5.96	-50.04	10.04	
		16QAM	1/12	1569.18	H	-57.55	5.96	-51.59	11.59	

**7.6.4 LTE Band 14**

B.W (MHz)	Test Freq. (MHz)	Test Mode	RB Size/ Offset	Freq.(MHz)	Ant Pol (H/V)	Level(dBm) @ Ant Terminal	TX Ant Gain(dBd)	Result		Limit (dBc)
								(dBm)	(dBc)	
10	793	QPSK	1/25	2379.50	V	-52.76	3.78	-48.98	68.15	32.17
		16QAM	1/25	2380.73	V	-52.75	3.78	-48.97	66.72	30.75
5	790.5	QPSK	1/12	2371.76	V	-51.56	3.78	-47.78	66.24	31.46
		16QAM	1/12	2371.76	V	-51.08	3.78	-47.30	67.22	32.92
	795.5	QPSK	1/12	2386.10	V	-53.43	3.78	-49.65	67.00	30.35
		16QAM	1/12	2386.37	V	-51.51	3.78	-47.73	65.61	30.88

Note 1: Limit Calculation =  $43 + 10\log_{10}(P[\text{Watts}])$

Note 2: This device was tested under all bandwidths, modulations and RB configurations and the worst case data are reported in the table above.

Note 3: The frequency spectrum is examined from 9 kHz to the 10th harmonic of the fundamental frequency of the transmitter. No other spurious and harmonic emissions were reported greater than listed emissions above table.

**UNDESIRABLE EMISSIONS IN 1559~1610MHz (LTE Band 14)**

B.W (MHz)	Test Freq. (MHz)	Test Mode	RB Size/ Offset	Freq.(MHz)	Ant Pol (H/V)	Level(dBm) @ Ant Terminal	TX Ant Gain(dBi)	Result	Margin	Limit (dBm/MHz)
								(dBm)	(dB)	
10	793	QPSK	1/25	1586.47	V	-56.75	5.98	-50.77	10.77	-40.00
		16QAM	1/25	1585.86	V	-55.75	5.98	-49.77	9.77	
5	790.5	QPSK	1/12	1581.03	V	-55.50	5.97	-49.53	9.53	
		16QAM	1/12	1581.45	V	-56.24	5.97	-50.27	10.27	
	795.5	QPSK	1/12	1590.92	V	-56.70	5.99	-50.71	10.71	
		16QAM	1/12	1591.05	V	-56.71	5.99	-50.72	10.72	

**7.6.5 LTE Band 5**

B.W (MHz)	Test Freq. (MHz)	RB Size/ Offset	Test Mode	Freq.(MHz)	Ant Pol (H/V)	Level(dBm) @ Ant Terminal	TX Ant Gain(dBd)	Result		Limit (dBc)
								(dBm)	(dBc)	
10	829	1/25	QPSK	1658.12	H	-51.37	3.85	-47.52	69.53	35.01
				2486.88	V	-52.35	3.81	-48.54	70.55	
			16QAM	1658.20	H	-51.77	3.85	-47.92	68.64	33.72
				2487.96	V	-51.96	3.81	-48.15	68.87	
	836.5	1/49	QPSK	1681.61	H	-49.77	3.92	-45.85	67.64	34.79
				2522.68	V	-50.82	3.77	-47.05	68.84	
			16QAM	1681.89	H	-50.97	3.92	-47.05	68.29	34.24
				2522.78	V	-51.93	3.77	-48.16	69.40	
	844	1/25	QPSK	1688.40	H	-51.87	3.94	-47.93	70.09	35.16
				2532.39	V	-49.68	3.75	-45.93	68.09	
			16QAM	1687.86	H	-52.32	3.94	-48.38	69.60	34.22
				2532.45	V	-51.27	3.75	-47.52	68.74	
5	826.5	1/12	QPSK	1653.10	H	-49.61	3.83	-45.78	68.10	35.32
				2479.94	V	-50.33	3.80	-46.53	68.85	
			16QAM	1652.99	H	-48.45	3.83	-44.62	65.61	33.99
				2479.78	V	-51.18	3.80	-47.38	68.37	
	836.5	1/12	QPSK	1673.03	H	-52.14	3.89	-48.25	69.37	34.12
				2509.66	V	-51.57	3.80	-47.77	68.89	
			16QAM	1673.08	H	-52.88	3.89	-48.99	68.63	32.64
				2509.29	V	-51.43	3.81	-47.62	67.26	
	846.5	1/24	QPSK	1697.48	H	-48.09	3.97	-44.12	65.48	34.36
				2545.99	V	-51.36	3.71	-47.65	69.01	
			16QAM	1697.42	H	-49.02	3.97	-45.05	64.97	32.92
				2545.96	V	-52.10	3.71	-48.39	68.31	

B.W (MHz)	Test Freq. (MHz)	RB Size/ Offset	Test Mode	Freq.(MHz)	Ant Pol (H/V)	Level(dBm) @ Ant Terminal	TX Ant Gain(dBd)	Result		Limit (dBc)
								(dBm)	(dBc)	
3	825.5	1/7	QPSK	1653.38	H	-51.04	3.83	-47.21	69.44	35.23
				2480.48	V	-50.74	3.80	-46.94	69.17	
			16QAM	1653.37	H	-51.95	3.83	-48.12	69.03	33.91
				2480.21	V	-51.56	3.80	-47.76	68.67	
	836.5	1/7	QPSK	1670.38	H	-50.10	3.89	-46.21	67.14	33.93
				2505.65	V	-51.19	3.82	-47.37	68.30	
			16QAM	1670.31	H	-49.75	3.88	-45.87	65.13	32.26
				2505.71	V	-52.45	3.82	-48.63	67.89	
	847.5	1/7	QPSK	1695.05	H	-50.23	3.96	-46.27	68.17	34.90
				2542.28	V	-51.19	3.72	-47.47	69.37	
			16QAM	1694.89	H	-49.59	3.96	-45.63	66.10	33.47
				2542.86	V	-52.63	3.72	-48.91	69.38	
1.4	824.7	1/2	QPSK	1649.14	H	-52.66	3.82	-48.84	71.47	35.63
				2473.62	V	-50.88	3.79	-47.09	69.72	
			16QAM	1649.04	H	-51.84	3.82	-48.02	69.53	34.51
				2473.60	V	-50.42	3.79	-46.63	68.14	
	836.5	1/2	QPSK	1672.84	H	-52.28	3.89	-48.39	69.97	34.58
				2509.35	V	-48.94	3.81	-45.13	66.71	
			16QAM	1673.15	H	-52.91	3.89	-49.02	69.12	33.10
				2509.30	V	-50.31	3.81	-46.50	66.60	
	848.3	1/2	QPSK	1696.37	H	-49.45	3.97	-45.48	67.45	34.97
				2508.20	V	-52.46	3.81	-48.65	70.62	
			16QAM	1696.14	H	-51.17	3.97	-47.20	67.73	33.53
				2506.89	V	-52.91	3.81	-49.10	69.63	

Note 1: Limit Calculation =  $43 + 10\log_{10}(P[\text{Watts}])$

Note 2: This device was tested under all bandwidths, modulations and RB configurations and the worst case data are reported in the table above.

Note 3: The frequency spectrum is examined from 9 kHz to the 10th harmonic of the fundamental frequency of the transmitter. No other spurious and harmonic emissions were reported greater than listed emissions above table.

**7.6.6 LTE Band 66, 4**

B.W (MHz)	Test Freq. (MHz)	RB Size/ Offset	Test Mode	Freq.(MHz)	Ant Pol (H/V)	Level(dBm) @ Ant Terminal	TX Ant Gain(dBi)	Result		Limit (dBc)
								(dBm)	(dBc)	
20	1720	1/99	QPSK	3457.70	H	-54.64	8.10	-46.54	69.74	36.20
			16QAM	3457.50	H	-55.35	8.10	-47.25	69.30	35.05
	1745	1/0	QPSK	3471.93	H	-54.16	8.13	-46.03	69.50	36.47
			16QAM	3471.94	H	-55.51	8.13	-47.38	69.76	35.38
	1770	1/50	QPSK	3540.54	H	-54.62	8.30	-46.32	69.12	36.40
			16QAM	3540.10	H	-54.46	8.30	-46.16	68.48	35.32
15	1717.5	1/0	QPSK	3421.30	H	-53.89	8.01	-45.88	68.68	35.80
			16QAM	3421.29	H	-54.71	8.01	-46.70	69.00	35.30
	1745	1/0	QPSK	3476.79	H	-55.28	8.14	-47.14	70.51	36.37
			16QAM	3476.76	H	-54.93	8.14	-46.79	68.98	35.19
	1772.5	1/74	QPSK	3558.14	H	-54.35	8.32	-46.03	67.76	34.73
			16QAM	3558.04	H	-55.33	8.32	-47.01	67.56	33.55
10	1715	1/0	QPSK	3421.03	H	-55.66	8.00	-47.66	70.31	35.65
			16QAM	3421.32	H	-55.91	8.01	-47.90	69.38	34.48
	1745	1/0	QPSK	3480.99	H	-54.37	8.15	-46.22	69.60	36.38
			16QAM	3481.23	H	-53.73	8.15	-45.58	67.37	34.79
	1775	1/25	QPSK	3550.12	H	-54.54	8.32	-46.22	68.48	35.26
			16QAM	3550.47	H	-54.99	8.32	-46.67	67.63	33.96
5	1712.5	1/0	QPSK	3420.76	H	-55.27	8.00	-47.27	69.77	35.50
			16QAM	3420.33	H	-55.97	8.00	-47.97	69.43	34.46
	1745	1/0	QPSK	3485.36	H	-53.68	8.16	-45.52	68.51	35.99
			16QAM	3485.84	H	-55.44	8.17	-47.27	68.98	34.71
	1777.5	1/0	QPSK	3550.93	H	-54.15	8.32	-45.83	67.54	34.71
			16QAM	3550.56	H	-54.06	8.32	-45.74	65.91	33.17

B.W (MHz)	Test Freq. (MHz)	RB Size/ Offset	Test Mode	Freq.(MHz)	Ant Pol (H/V)	Level(dBm) @ Ant Terminal	TX Ant Gain(dBi)	Result		Limit (dBc)
								(dBm)	(dBc)	
3	1711.5	1/0	QPSK	3420.24	H	-54.36	8.00	-46.36	68.78	35.42
			16QAM	3421.03	H	-55.05	8.00	-47.05	68.07	34.02
	1745	1/0	QPSK	3487.81	H	-54.43	8.17	-46.26	69.07	35.81
			16QAM	3487.30	H	-55.16	8.17	-46.99	68.73	34.74
	1778.5	1/0	QPSK	3554.69	H	-54.64	8.32	-46.32	68.15	35.13
			16QAM	3554.99	H	-55.11	8.32	-46.79	67.65	33.86
1.4	1710.7	1/2	QPSK	3422.33	H	-56.20	8.01	-48.19	70.62	35.43
			16QAM	3422.29	H	-56.34	8.01	-48.33	69.58	34.25
	1745	1/2	QPSK	3490.12	H	-55.00	8.18	-46.82	69.64	35.82
			16QAM	3490.07	H	-55.57	8.18	-47.39	69.12	34.73
	1779.3	1/2	QPSK	3558.33	H	-54.83	8.32	-46.51	68.24	34.73
			16QAM	3558.82	H	-55.34	8.33	-47.01	67.40	33.39

Note 1: Limit Calculation =  $43 + 10\log_{10}(P[\text{Watts}])$

Note 2: This device was tested under all bandwidths, modulations and RB configurations and the worst case data are reported in the table above.

Note 3: The frequency spectrum is examined from 9 kHz to the 10th harmonic of the fundamental frequency of the transmitter. No other spurious and harmonic emissions were reported greater than listed emissions above table.



**7.6.7 LTE Band 2**

B.W (MHz)	Test Freq. (MHz)	RB Size/ Offset	Test Mode	Freq.(MHz)	Ant Pol (H/V)	Level(dBm) @ Ant Terminal	TX Ant Gain(dBi)	Result		Limit (dBc)
								(dBm)	(dBc)	
20	1860	1/50	QPSK	3720.30	V	-51.14	8.39	-42.75	66.43	36.68
				5580.54	V	-52.99	10.51	-42.48	66.16	
			16QAM	3720.48	V	-53.05	8.39	-44.66	66.92	35.26
				5580.19	V	-52.90	10.51	-42.39	64.65	
	1880	1/50	QPSK	3760.18	V	-51.25	8.36	-42.89	65.66	35.77
				5640.38	V	-49.67	10.64	-39.03	61.80	
			16QAM	3760.30	V	-52.07	8.36	-43.71	65.51	34.80
				5640.34	V	-50.18	10.64	-39.54	61.34	
	1900	1/50	QPSK	3799.88	V	-50.94	8.22	-42.72	66.25	36.53
				5699.91	V	-51.72	10.74	-40.98	64.51	
			16QAM	3800.19	V	-53.05	8.22	-44.83	67.27	35.44
				5700.43	V	-51.35	10.74	-40.61	63.05	
15	1857.5	1/74	QPSK	3728.55	V	-52.19	8.39	-43.80	68.36	37.56
				5594.73	V	-52.80	10.56	-42.24	66.80	
			16QAM	3728.34	V	-53.45	8.39	-45.06	68.57	36.51
				5596.89	V	-52.73	10.57	-42.16	65.67	
	1880	1/74	QPSK	3773.13	V	-52.10	8.32	-43.78	66.89	36.11
				5660.14	V	-50.12	10.68	-39.44	62.55	
			16QAM	3773.36	V	-51.38	8.32	-43.06	65.04	34.98
				5660.20	V	-50.75	10.68	-40.07	62.05	
	1902.5	1/74	QPSK	3818.56	V	-52.29	8.22	-44.07	68.02	36.95
				5727.64	V	-50.96	10.72	-40.24	64.19	
			16QAM	3818.33	V	-52.13	8.22	-43.91	66.34	35.43
				5727.51	V	-50.41	10.72	-39.69	62.12	
10	1855	1/25	QPSK	3710.18	V	-52.02	8.38	-43.64	67.52	36.88
				5565.29	V	-52.29	10.46	-41.83	65.71	
			16QAM	3709.96	V	-52.55	8.38	-44.17	66.81	35.64
				5565.00	V	-52.35	10.46	-41.89	64.53	
	1880	1/25	QPSK	3760.36	V	-51.38	8.36	-43.02	65.88	35.86
				5640.05	V	-50.41	10.64	-39.77	62.63	
			16QAM	3960.04	V	-50.92	8.57	-42.35	63.83	34.48
				5640.27	V	-51.04	10.64	-40.40	61.88	
	1905	1/49	QPSK	3818.78	V	-51.13	8.22	-42.91	66.45	36.54
				5728.16	V	-49.84	10.72	-39.12	62.66	
			16QAM	3818.98	V	-51.54	8.22	-43.32	65.53	35.21
				5728.71	V	-50.72	10.72	-40.00	62.21	

B.W (MHz)	Test Freq. (MHz)	RB Size/ Offset	Test Mode	Freq.(MHz)	Ant Pol (H/V)	Level(dBm) @ Ant Terminal	TX Ant Gain(dBi)	Result		Limit (dBc)		
								(dBm)	(dBc)			
5	1852.5	1/12	QPSK	3705.21	V	-50.79	8.38	-42.41	65.60	36.19		
				5557.29	V	-52.74	10.43	-42.31	65.50			
			16QAM	3705.14	V	-52.44	8.38	-44.06	66.31	35.25		
				5557.76	V	-51.41	10.44	-40.97	63.22			
	1880	1/24	QPSK	3764.06	V	-50.41	8.35	-42.06	64.77	35.71		
				5646.68	V	-49.37	10.65	-38.72	61.43			
			16QAM	3764.43	V	-50.73	8.35	-42.38	63.82	34.44		
				5646.75	V	-50.26	10.65	-39.61	61.05			
			1907.5	1/24	QPSK	3819.08	V	-51.34	8.22	-43.12	66.83	36.71
						5728.61	V	-50.44	10.72	-39.72	63.43	
	16QAM	3819.49			V	-52.33	8.22	-44.11	66.29	35.18		
		5729.22			V	-50.77	10.72	-40.05	62.23			
3	1851.5	1/0	QPSK	3700.30	V	-50.69	8.38	-42.31	65.33	36.02		
				5549.91	V	-52.61	10.41	-42.20	65.22			
			16QAM	3700.68	V	-51.67	8.38	-43.29	65.30	35.01		
				5550.45	V	-53.55	10.41	-43.14	65.15			
	1880	1/0	QPSK	3757.61	V	-50.67	8.37	-42.30	65.04	35.74		
				5636.53	V	-51.43	10.64	-40.79	63.53			
			16QAM	3757.40	V	-53.95	8.37	-45.58	67.27	34.69		
				5636.18	V	-51.30	10.64	-40.66	62.35			
	1908.5	1/14	QPSK	3814.70	V	-51.19	8.22	-42.97	66.56	36.59		
				5729.36	V	-50.09	10.72	-39.37	62.96			
			16QAM	3815.19	V	-51.79	8.22	-43.57	66.05	35.48		
				5729.43	V	-51.46	10.72	-40.74	63.22			
1.4	1850.7	1/2	QPSK	3701.36	V	-51.82	8.38	-43.44	66.66	36.22		
				5551.70	V	-52.69	10.42	-42.27	65.49			
			16QAM	3701.10	V	-53.09	8.38	-44.71	66.72	35.01		
				5551.85	V	-52.80	10.42	-42.38	64.39			
	1880	1/2	QPSK	3759.70	V	-51.99	8.37	-43.62	66.67	36.05		
				5639.80	V	-50.81	10.64	-40.17	63.22			
			16QAM	3760.06	V	-52.32	8.36	-43.96	65.69	34.73		
				5640.09	V	-51.65	10.64	-41.01	62.74			
	1909.3	1/2	QPSK	3818.28	V	-51.56	8.22	-43.34	66.79	36.45		
				5727.84	V	-50.44	10.72	-39.72	63.17			
			16QAM	3818.10	V	-52.71	8.22	-44.49	66.73	35.24		
				5727.62	V	-50.60	10.72	-39.88	62.12			

Note 1: Limit Calculation =  $43 + 10\log_{10}(P[\text{Watts}])$

Note 2: This device was tested under all bandwidths, modulations and RB configurations and the worst case data are reported in the table above.

Note 3: The frequency spectrum is examined from 9 kHz to the 10th harmonic of the fundamental frequency of the transmitter. No other spurious and harmonic emissions were reported greater than listed emissions above table.

## 7.7 FREQUENCY STABILITY

### 7.7.1 LTE Band 71

OPERATING FREQUENCY : 680.5 MHz  
 REFERENCE VOLTAGE : 3.8 VDC  
 LIMIT : The frequency stability shall be sufficient to ensure that the fundamental emission stays within the authorized frequency block.

VOLTAGE (%)	POWER (V DC)	TEMP (°C)	FREQUENCY (Hz)	FREQ.Dev (Hz)	Deviation	
					(ppm)	(%)
100%	3.80	+20(Ref)	680,500,003	3	0.0044	0.000000441
100%		-30	680,500,003	3	0.0044	0.000000441
100%		-20	680,500,005	5	0.0073	0.000000735
100%		-10	680,499,999	-1	-0.0015	-0.000000147
100%		0	680,499,997	-3	-0.0044	-0.000000441
100%		+10	680,500,003	3	0.0044	0.000000441
100%		+20	680,500,003	3	0.0044	0.000000441
100%		+30	680,499,998	-2	-0.0029	-0.000000294
100%		+40	680,500,003	3	0.0044	0.000000441
100%		+50	680,500,004	4	0.0059	0.000000588
115%		4.37	+20	680,500,002	2	0.0029
BATT.ENDPOINT	3.60	+20	680,499,998	-2	-0.0029	-0.000000294

**Note.** Based on the results of the frequency stability test at the center channel the frequency deviation results measured are very small. As such it is determined that the channels at the band edge would remain inband when the maximum measured frequency deviation noted during the frequency stability tests is applied. Therefore the device is determined to remain operating in band over the temperature and voltage range as tested.

**7.7.2 LTE Band 12**

OPERATING FREQUENCY : 707.5 MHz  
 REFERENCE VOLTAGE : 3.8 VDC  
 LIMIT : The frequency stability shall be sufficient to ensure that the fundamental emission stays within the authorized frequency block.

VOLTAGE (%)	POWER (V DC)	TEMP (°C)	FREQUENCY (Hz)	FREQ.Dev (Hz)	Deviation	
					(ppm)	(%)
100%	3.80	+20(Ref)	707,500,002	2	0.0028	0.000000283
100%		-30	707,500,003	3	0.0042	0.000000424
100%		-20	707,500,001	1	0.0014	0.000000141
100%		-10	707,499,998	-2	-0.0028	-0.000000283
100%		0	707,500,003	3	0.0042	0.000000424
100%		+10	707,500,001	1	0.0014	0.000000141
100%		+20	707,500,002	2	0.0028	0.000000283
100%		+30	707,500,002	2	0.0028	0.000000283
100%		+40	707,499,997	-3	-0.0042	-0.000000424
100%		+50	707,500,003	3	0.0042	0.000000424
115%	4.37	+20	707,499,999	-1	-0.0014	-0.000000141
BATT.ENDPOINT	3.60	+20	707,499,999	-1	-0.0014	-0.000000141

**Note.** Based on the results of the frequency stability test at the center channel the frequency deviation results measured are very small. As such it is determined that the channels at the band edge would remain inband when the maximum measured frequency deviation noted during the frequency stability tests is applied. Therefore the device is determined to remain operating in band over the temperature and voltage range as tested.

### 7.7.3 LTE Band 13

OPERATING FREQUENCY : 782 MHz  
 REFERENCE VOLTAGE : 3.8 VDC  
 LIMIT : The frequency stability shall be sufficient to ensure that the fundamental emission stays within the authorized frequency block.

VOLTAGE (%)	POWER (V DC)	TEMP (°C)	FREQUENCY (Hz)	FREQ.Dev (Hz)	Deviation	
					(ppm)	(%)
100%	3.80	+20(Ref)	781,999,998	-2	-0.0026	-0.000000256
100%		-30	781,999,999	-1	-0.0013	-0.000000128
100%		-20	781,999,997	-3	-0.0038	-0.000000384
100%		-10	781,999,997	-3	-0.0038	-0.000000384
100%		0	781,999,999	-1	-0.0013	-0.000000128
100%		+10	781,999,995	-5	-0.0064	-0.000000639
100%		+20	781,999,998	-2	-0.0026	-0.000000256
100%		+30	781,999,998	-2	-0.0026	-0.000000256
100%		+40	781,999,996	-4	-0.0051	-0.000000512
100%		+50	781,999,998	-2	-0.0026	-0.000000256
115%	4.37	+20	781,999,998	-2	-0.0026	-0.000000256
BATT.ENDPOINT	3.60	+20	782,000,001	1	0.0013	0.000000128

**Note.** Based on the results of the frequency stability test at the center channel the frequency deviation results measured are very small. As such it is determined that the channels at the band edge would remain inband when the maximum measured frequency deviation noted during the frequency stability tests is applied. Therefore the device is determined to remain operating in band over the temperature and voltage range as tested.

**7.7.4 LTE Band 14**

OPERATING FREQUENCY : 793 MHz  
 REFERENCE VOLTAGE : 3.8 VDC  
 DEVIATION LIMIT : NA

VOLTAGE (%)	POWER (V DC)	TEMP (°C)	FREQUENCY (Hz)	FREQ.Dev (Hz)	Deviation	
					(ppm)	(%)
100%	3.80	+20(Ref)	792,999,998	-2	-0.0025	-0.000000252
100%		-30	793,000,001	1	0.0013	0.000000126
100%		-20	793,000,002	2	0.0025	0.000000252
100%		-10	792,999,998	-2	-0.0025	-0.000000252
100%		0	792,999,998	-2	-0.0025	-0.000000252
100%		+10	792,999,995	-5	-0.0063	-0.000000631
100%		+20	792,999,998	-2	-0.0025	-0.000000252
100%		+30	792,999,997	-3	-0.0038	-0.000000378
100%		+40	793,000,001	1	0.0013	0.000000126
100%		+50	792,999,998	-2	-0.0025	-0.000000252
115%	4.37	+20	792,999,996	-4	-0.0050	-0.000000504
BATT.ENDPOINT	3.60	+20	792,999,999	-1	-0.0013	-0.000000126

**7.7.5 LTE Band 5**

OPERATING FREQUENCY : 836.5 MHz  
 REFERENCE VOLTAGE : 3.8 VDC  
 DEVIATION LIMIT :  $\pm 0.00025\%$  or 2.5 ppm

VOLTAGE (%)	POWER (V DC)	TEMP (°C)	FREQUENCY (Hz)	FREQ.Dev (Hz)	Deviation	
					(ppm)	(%)
100%	3.80	+20(Ref)	836,500,001	1	0.0012	0.000000120
100%		-30	836,499,997	-3	-0.0036	-0.000000359
100%		-20	836,500,001	1	0.0012	0.000000120
100%		-10	836,499,998	-2	-0.0024	-0.000000239
100%		0	836,499,993	-7	-0.0084	-0.000000837
100%		+10	836,499,991	-9	-0.0108	-0.000001076
100%		+20	836,500,001	1	0.0012	0.000000120
100%		+30	836,499,997	-3	-0.0036	-0.000000359
100%		+40	836,499,996	-4	-0.0048	-0.000000478
100%		+50	836,500,009	9	0.0108	0.000001076
115%		4.37	+20	836,499,999	-1	-0.0012
BATT.ENDPOINT	3.60	+20	836,500,001	1	0.0012	0.000000120

**Note.** Based on the results of the frequency stability test at the center channel the frequency deviation results measured are very small. as such it is determined that the channels at the band edge would remain inband when the maximum measured frequency deviation noted during the frequency stability tests is applied. therefore the device is determined to remain operating in band over the temperature and voltage range as tested.

**7.7.6 LTE Band 66, 4**

OPERATING FREQUENCY : 1745.0 MHz  
 REFERENCE VOLTAGE : 3.8 VDC  
 LIMIT : The frequency stability shall be sufficient to ensure that the fundamental emission stays within the authorized frequency block.

VOLTAGE (%)	POWER (V DC)	TEMP (°C)	FREQUENCY (Hz)	FREQ.Dev (Hz)	Deviation	
					(ppm)	(%)
100%	3.80	+20(Ref)	1,745,000,006	6	0.0034	0.000000344
100%		-30	1,745,000,006	6	0.0034	0.000000344
100%		-20	1,744,999,996	-4	-0.0023	-0.000000229
100%		-10	1,745,000,001	1	0.0006	0.000000057
100%		0	1,744,999,998	-2	-0.0011	-0.000000115
100%		+10	1,744,999,996	-4	-0.0023	-0.000000229
100%		+20	1,745,000,006	6	0.0034	0.000000344
100%		+30	1,745,000,005	5	0.0029	0.000000287
100%		+40	1,745,000,001	1	0.0006	0.000000057
100%		+50	1,745,000,004	4	0.0023	0.000000229
115%		4.37	+20	1,745,000,004	4	0.0023
BATT.ENDPOINT	3.60	+20	1,744,999,996	-4	-0.0023	-0.000000229

**Note.** Based on the results of the frequency stability test at the center channel the frequency deviation results measured are very small. As such it is determined that the channels at the band edge would remain inband when the maximum measured frequency deviation noted during the frequency stability tests is applied. Therefore the device is determined to remain operating in band over the temperature and voltage range as tested.



### 7.7.7 LTE Band 2

OPERATING FREQUENCY : 1880.0 MHz  
 REFERENCE VOLTAGE : 3.8 VDC  
 LIMIT : The frequency stability shall be sufficient to ensure that the fundamental emission stays within the authorized frequency block.

VOLTAGE (%)	POWER (V DC)	TEMP (°C)	FREQUENCY (Hz)	FREQ.Dev (Hz)	Deviation	
					(ppm)	(%)
100%	3.80	+20(Ref)	1,879,999,996	-4	-0.0021	-0.000000213
100%		-30	1,879,999,999	-1	-0.0005	-0.000000053
100%		-20	1,879,999,999	-1	-0.0005	-0.000000053
100%		-10	1,879,999,997	-3	-0.0016	-0.000000160
100%		0	1,880,000,001	1	0.0005	0.000000053
100%		+10	1,879,999,995	-5	-0.0027	-0.000000266
100%		+20	1,879,999,996	-4	-0.0021	-0.000000213
100%		+30	1,879,999,999	-1	-0.0005	-0.000000053
100%		+40	1,879,999,997	-3	-0.0016	-0.000000160
100%		+50	1,880,000,003	3	0.0016	0.000000160
115%		4.37	+20	1,879,999,997	-3	-0.0016
BATT.ENDPOINT	3.60	+20	1,880,000,003	3	0.0016	0.000000160

**Note.** Based on the results of the frequency stability test at the center channel the frequency deviation results measured are very small. As such it is determined that the channels at the band edge would remain inband when the maximum measured frequency deviation noted during the frequency stability tests is applied. Therefore the device is determined to remain operating in band over the temperature and voltage range as tested.

## 8. TEST PLOTS

Note: All bandwidths, RB configurations, and modulations were investigated.  
The worst case test results are reported.

### 8.1 OCCUPIED BANDWIDTH

#### 8.1.1 LTE Band 71

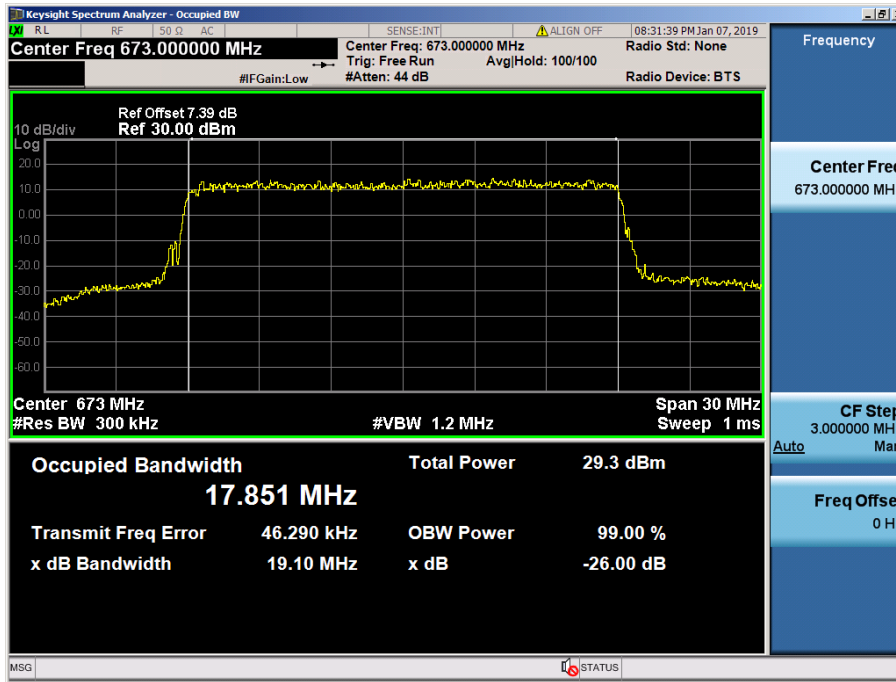

LTE Band 71 / 20 MHz / QPSK - RB Size 100

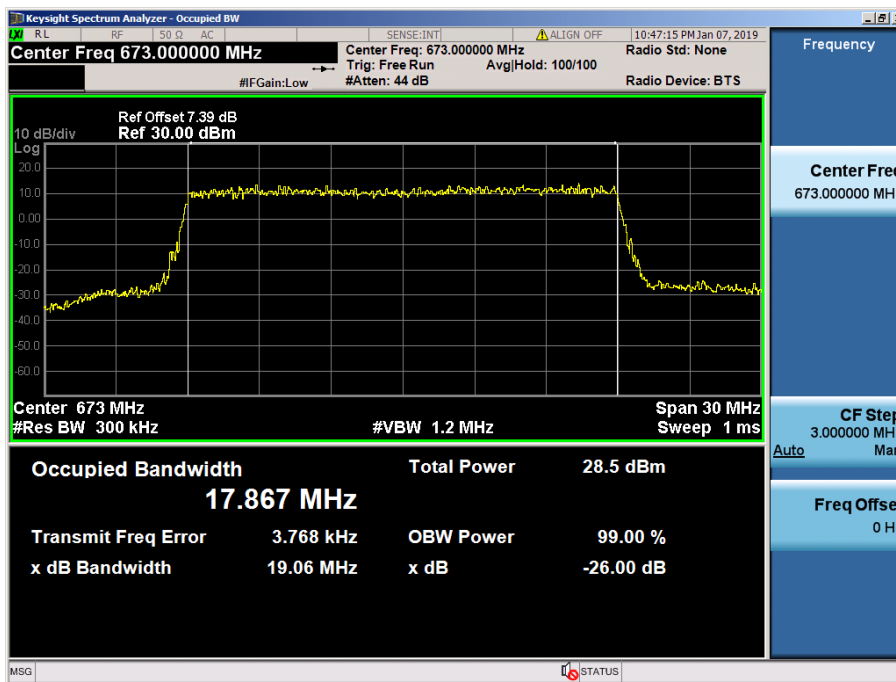

LTE Band 71 / 20 MHz / 16QAM - RB Size 100

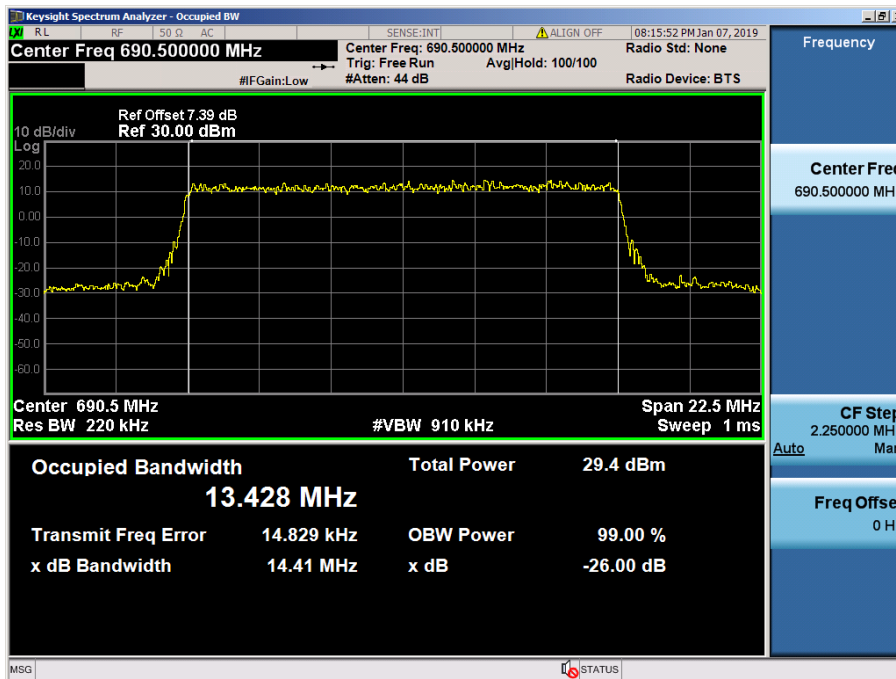

LTE Band 71 / 15 MHz / QPSK - RB Size 75

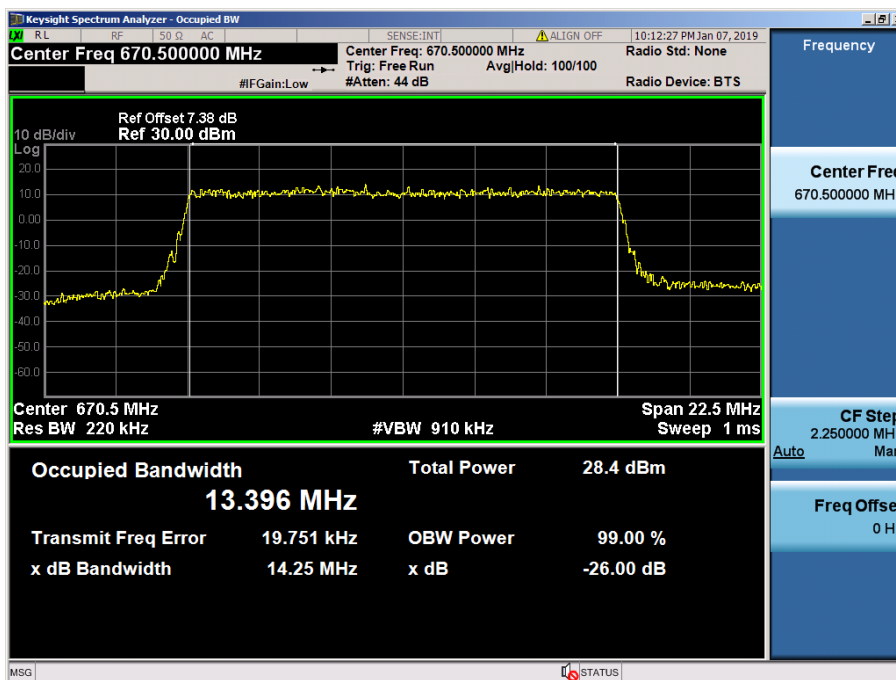

LTE Band 71 / 15 MHz / 16QAM - RB Size 75

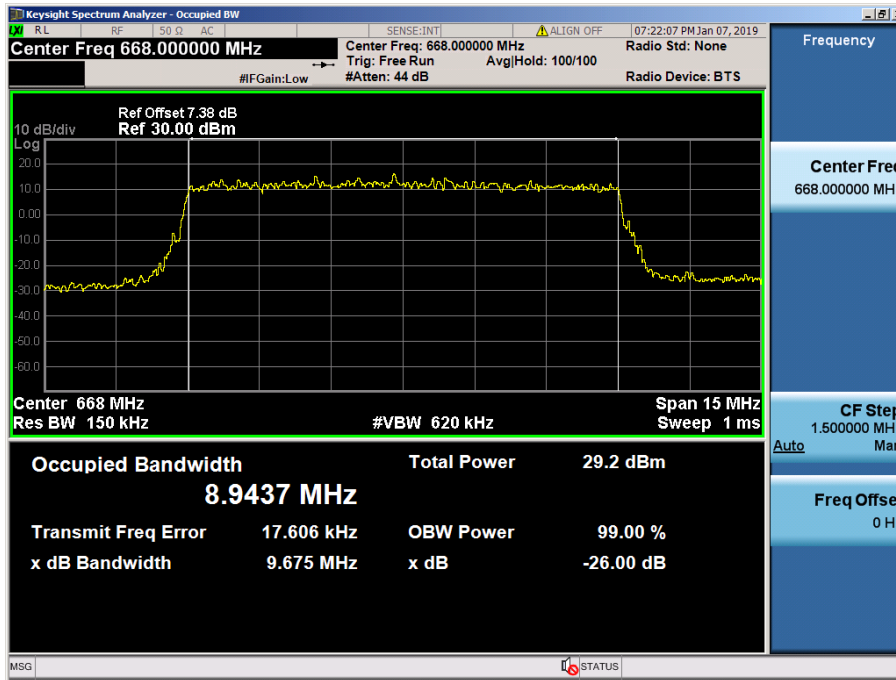

LTE Band 71 / 10 MHz / QPSK - RB Size 50

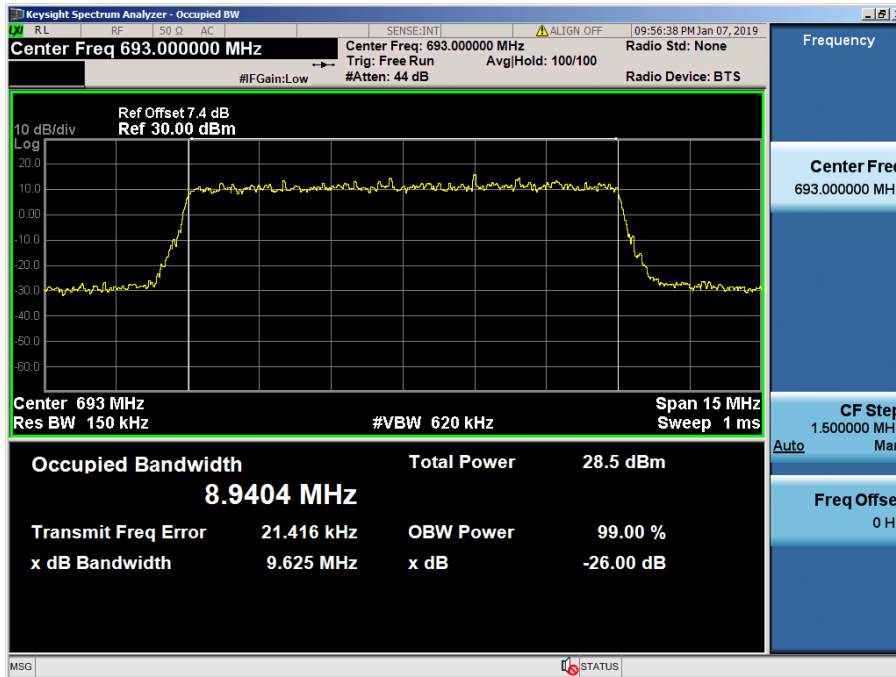

LTE Band 71 / 10 MHz / 16QAM - RB Size 50

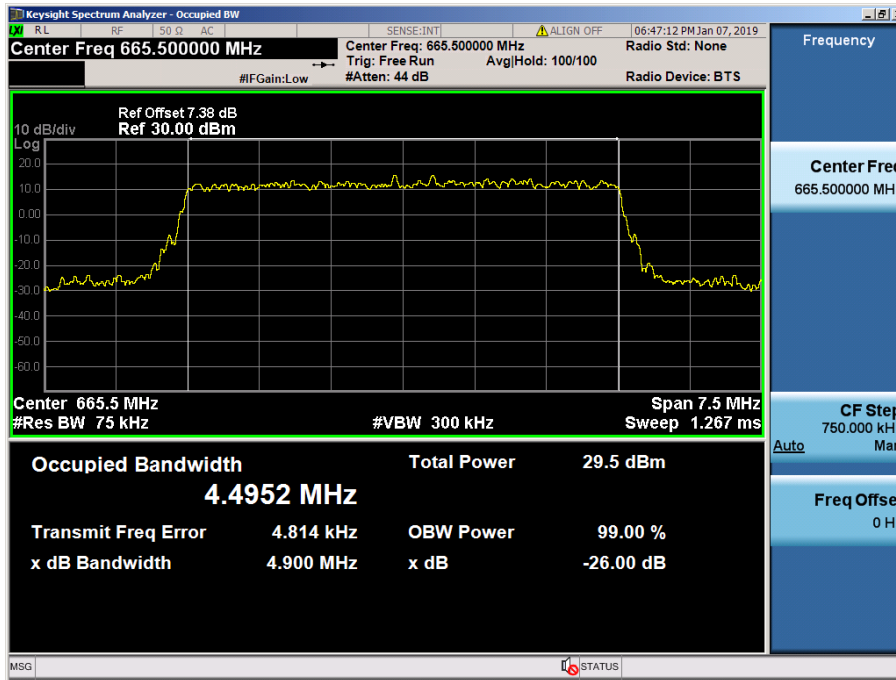

LTE Band 71 / 5 MHz / QPSK - RB Size 25

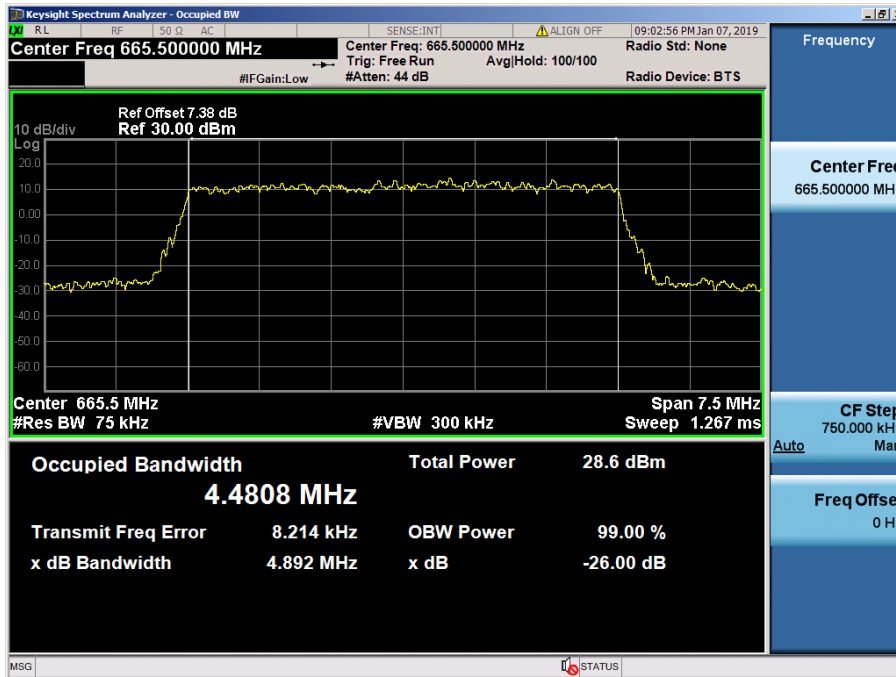

LTE Band 71 / 5 MHz / 16QAM - RB Size 25

8.1.2 LTE Band 12

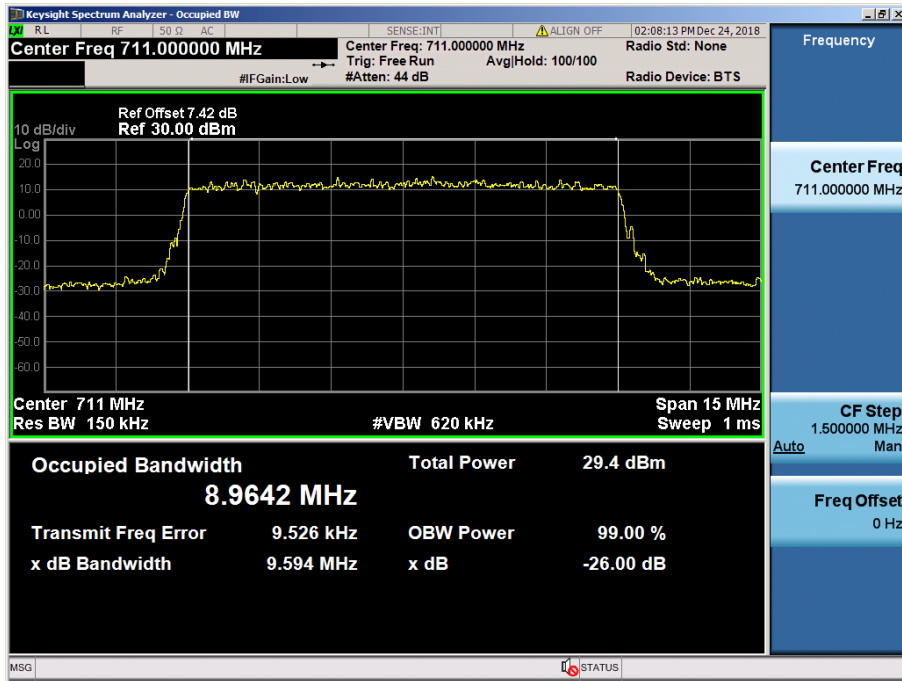

LTE Band 12 / 10 MHz / QPSK - RB Size 50

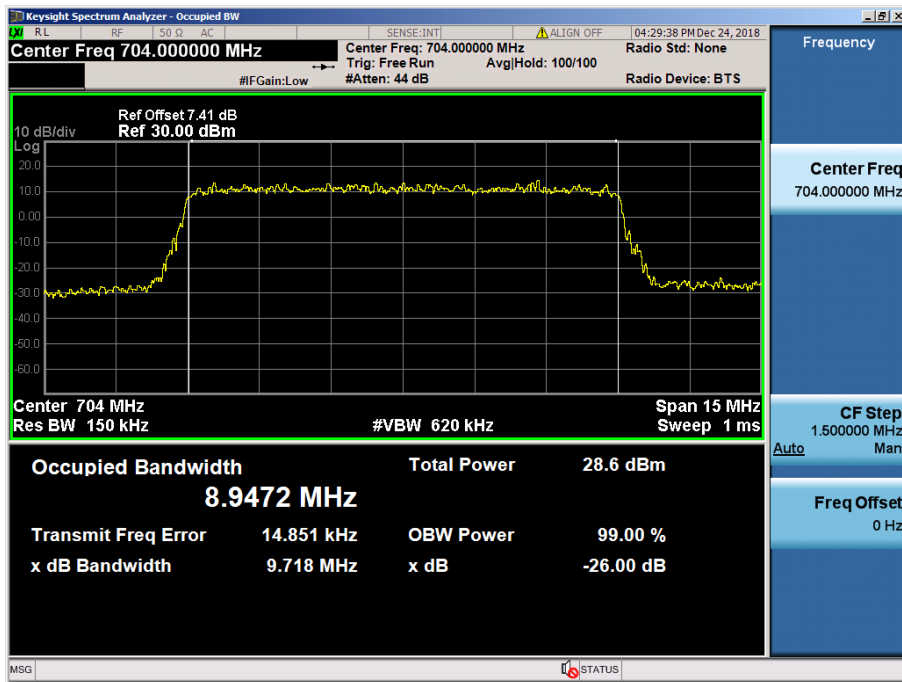

LTE Band 12 / 10 MHz / 16QAM - RB Size 50

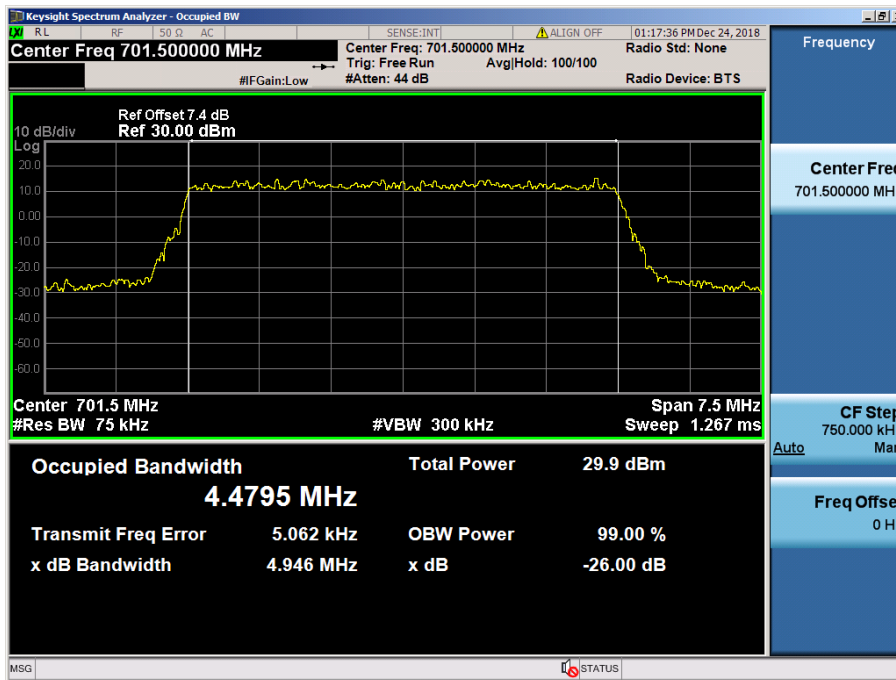

LTE Band 12 / 5 MHz / QPSK - RB Size 25

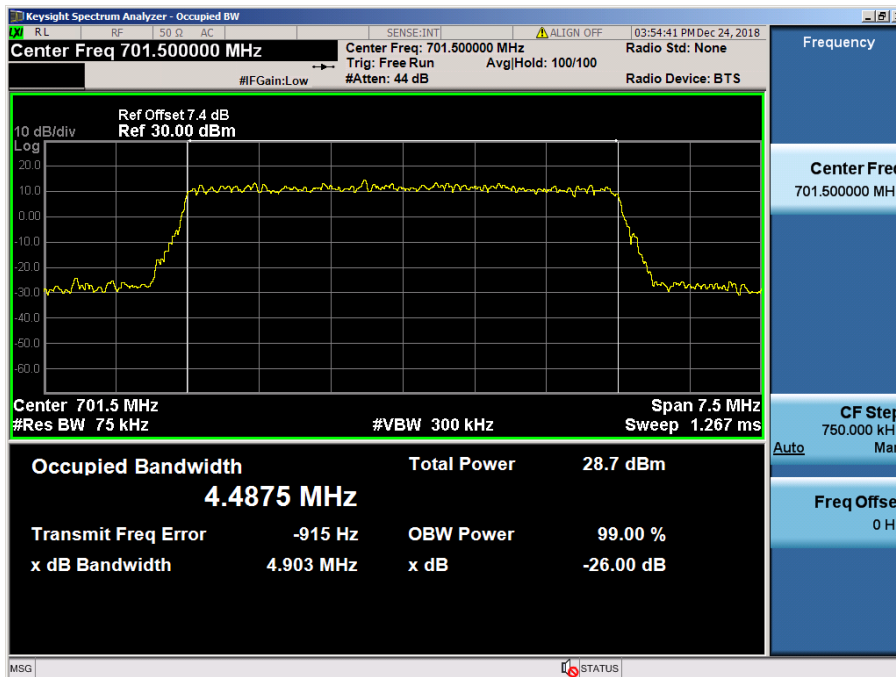

LTE Band 12 / 5 MHz / 16QAM - RB Size 25

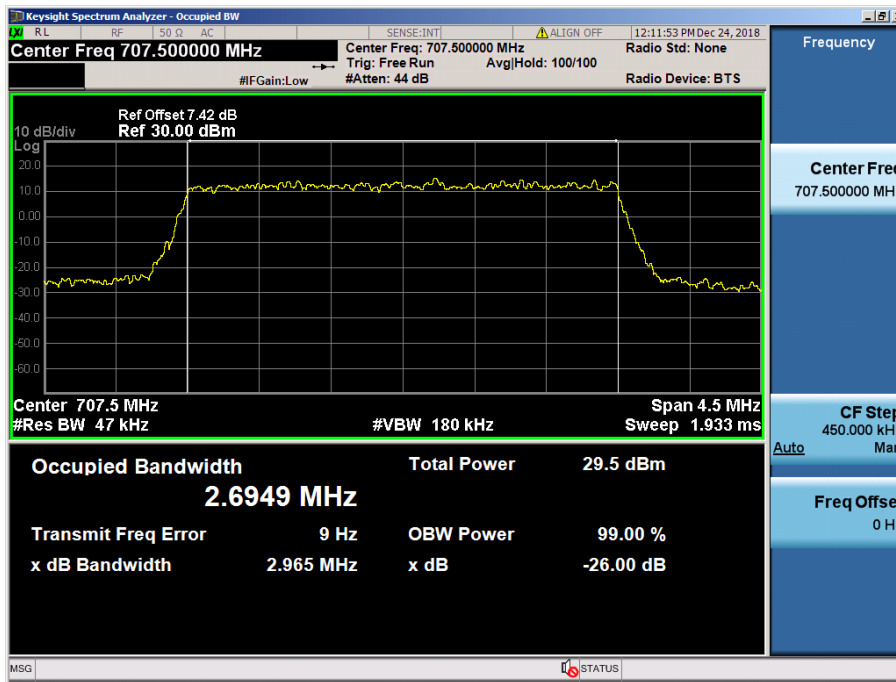

LTE Band 12 / 3 MHz / QPSK - RB Size 15

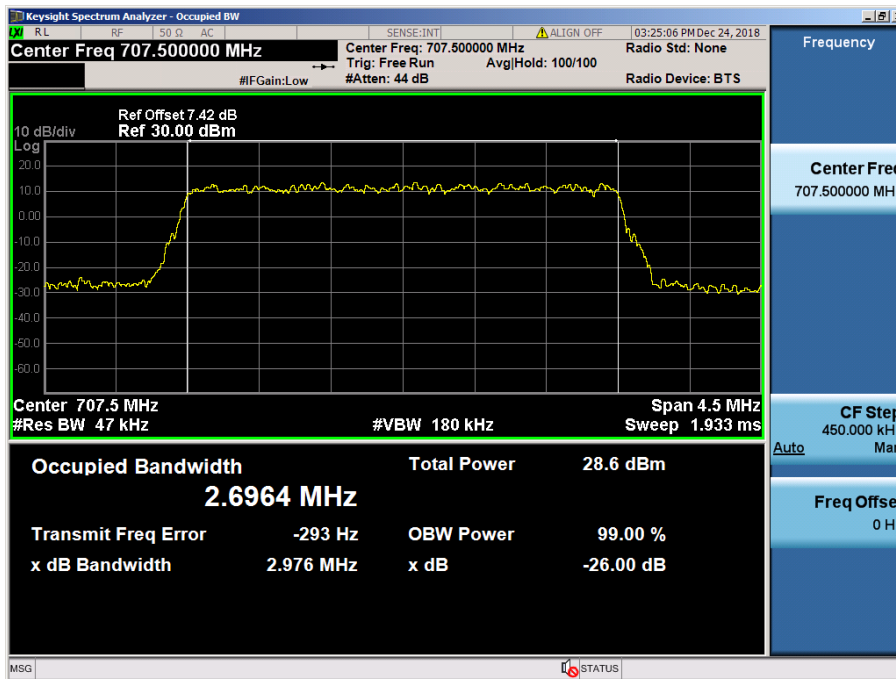

LTE Band 12 / 3 MHz / 16QAM - RB Size 15



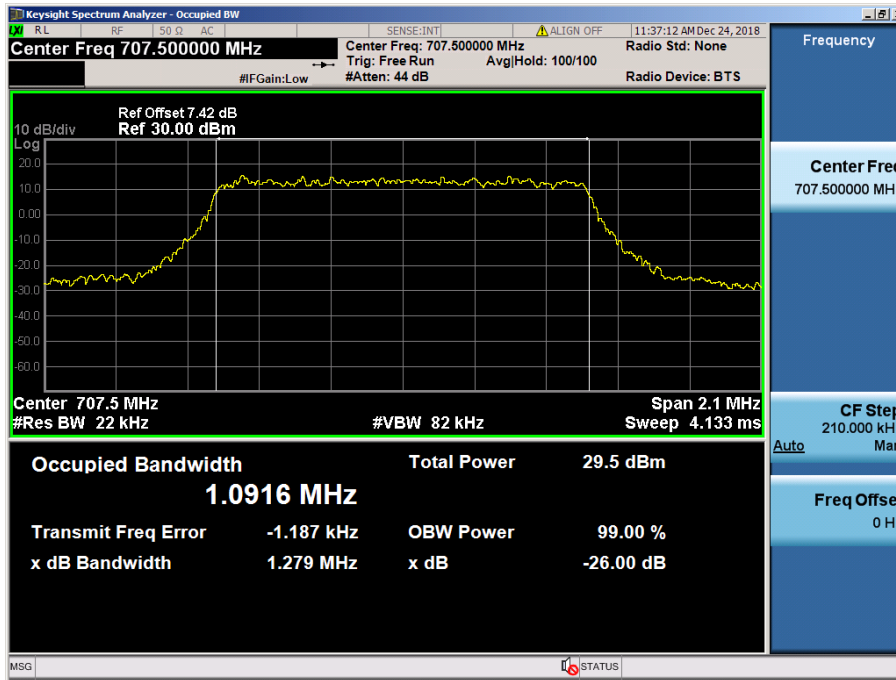

LTE Band 12 / 1.4 MHz / QPSK - RB Size 6



LTE Band 12 / 1.4 MHz / 16QAM - RB Size 6

8.1.3 LTE Band 13

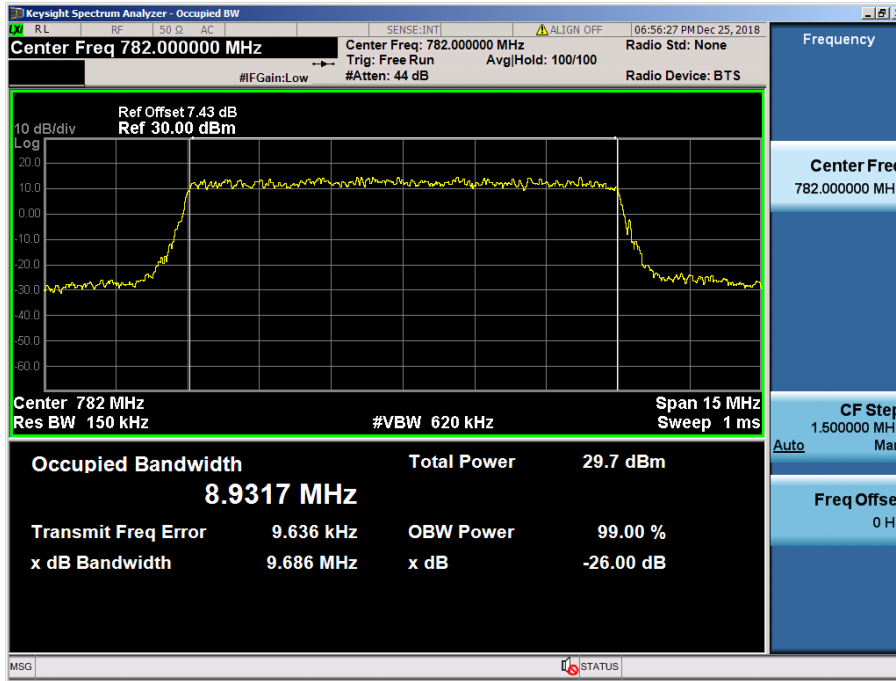

LTE Band 13 / 10 MHz / QPSK - RB Size 50

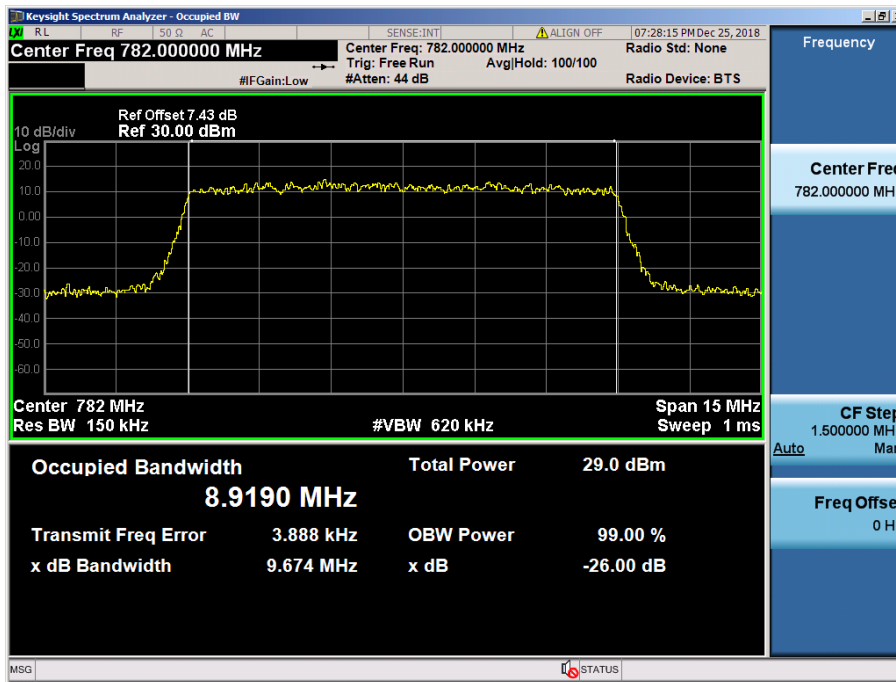

LTE Band 13 / 10 MHz / 16QAM - RB Size 50

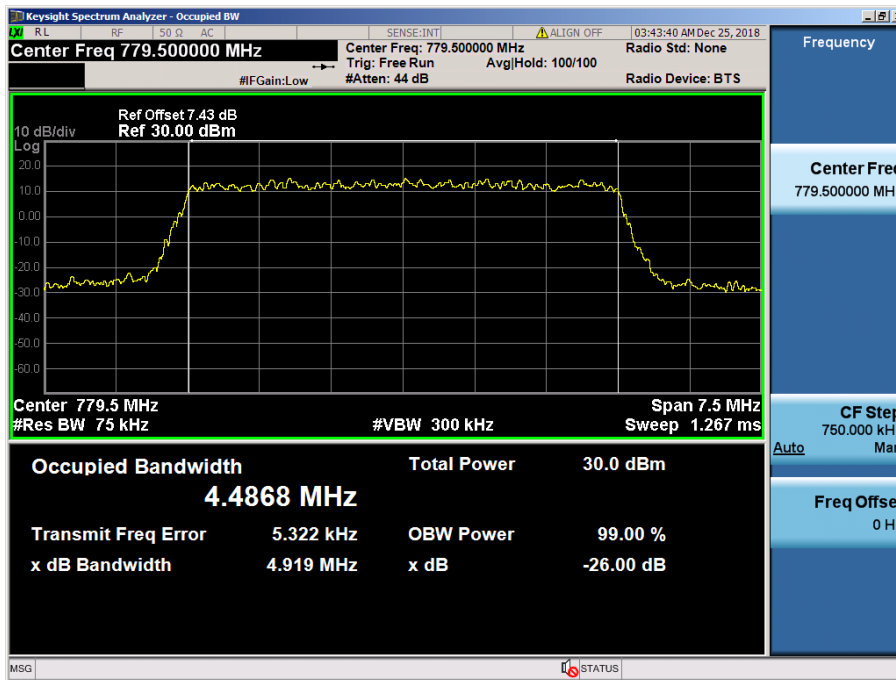

LTE Band 13 / 5 MHz / QPSK - RB Size 25

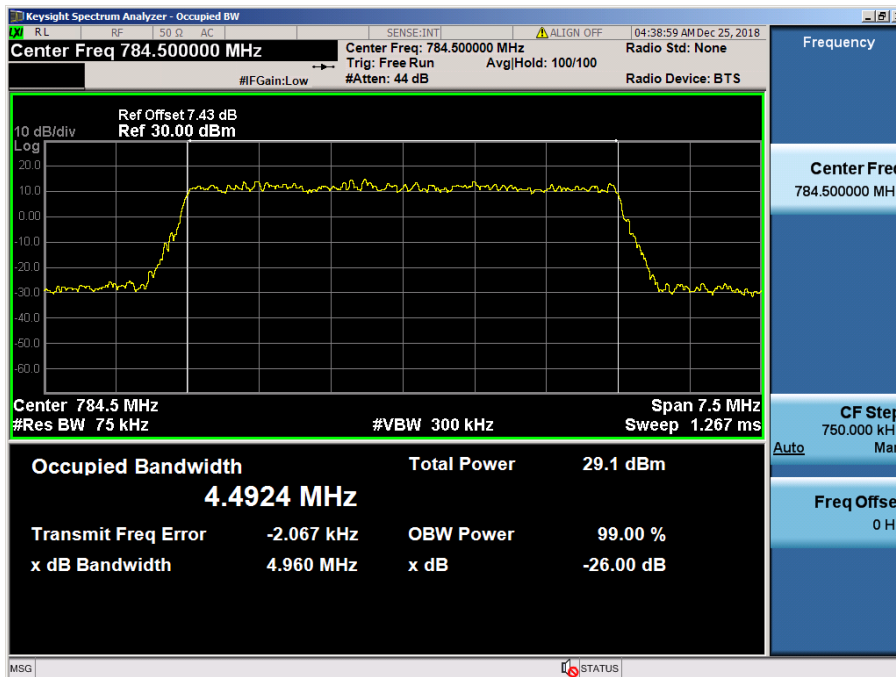

LTE Band 13 / 5 MHz / 16QAM - RB Size 25

8.1.14 LTE Band 14

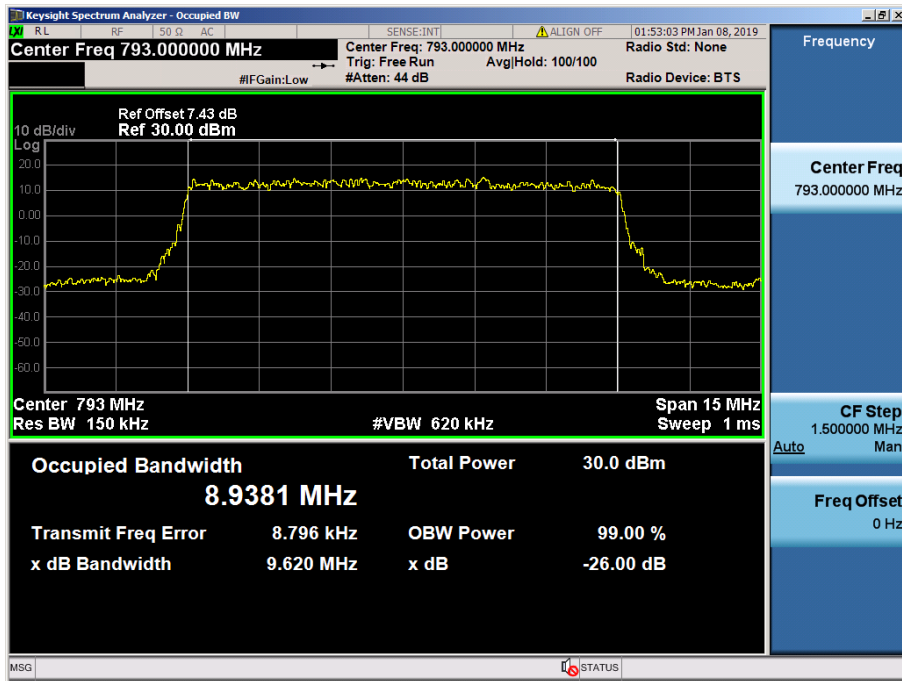

LTE Band 14 / 10 MHz / QPSK - RB Size 50

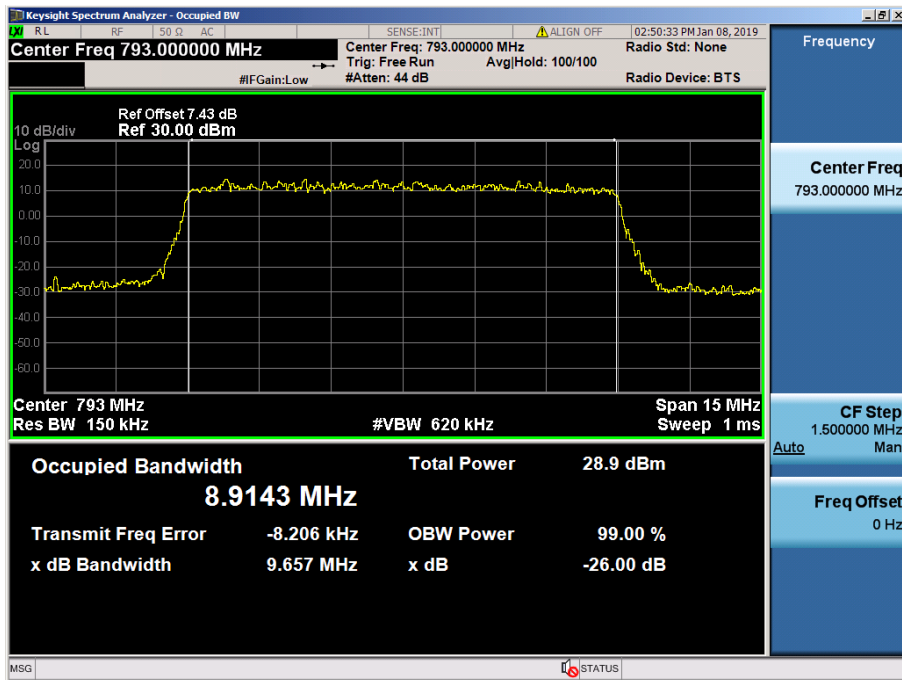

LTE Band 14 / 10 MHz / 16QAM - RB Size 50

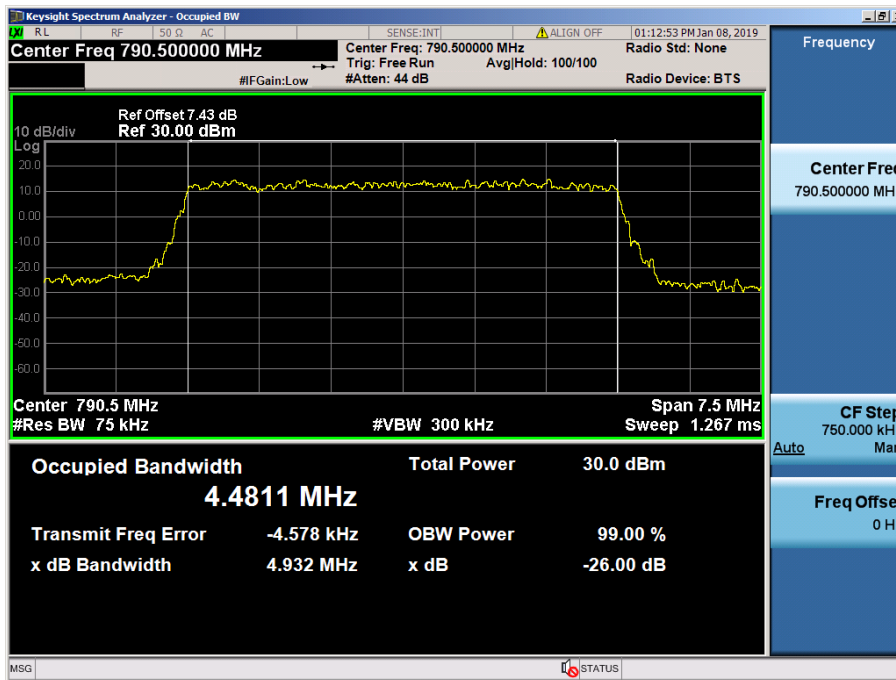

LTE Band 14 / 5 MHz / QPSK - RB Size 25

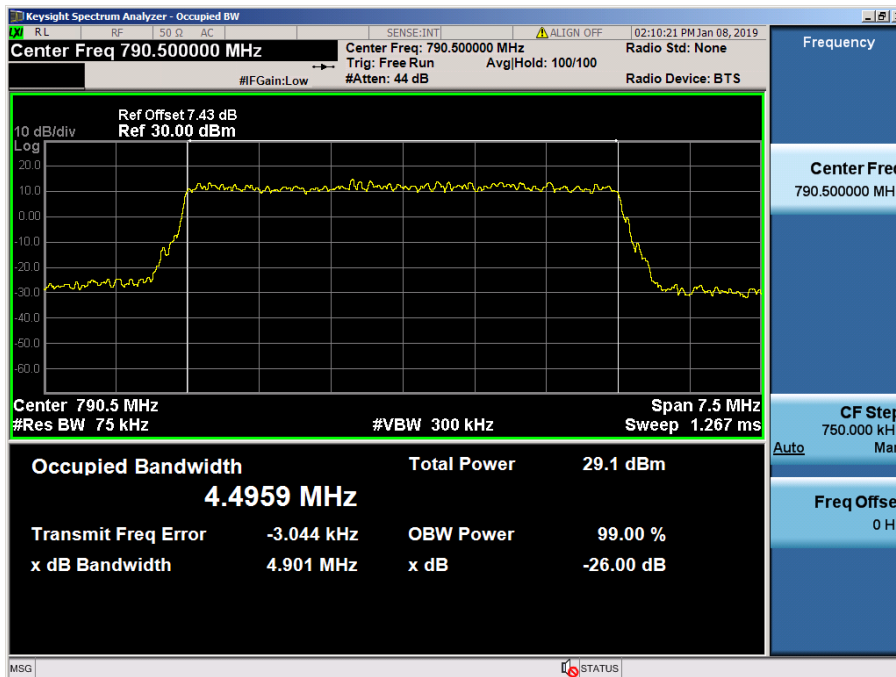

LTE Band 14 / 5 MHz / 16QAM - RB Size 25

8.1.5 LTE Band 5

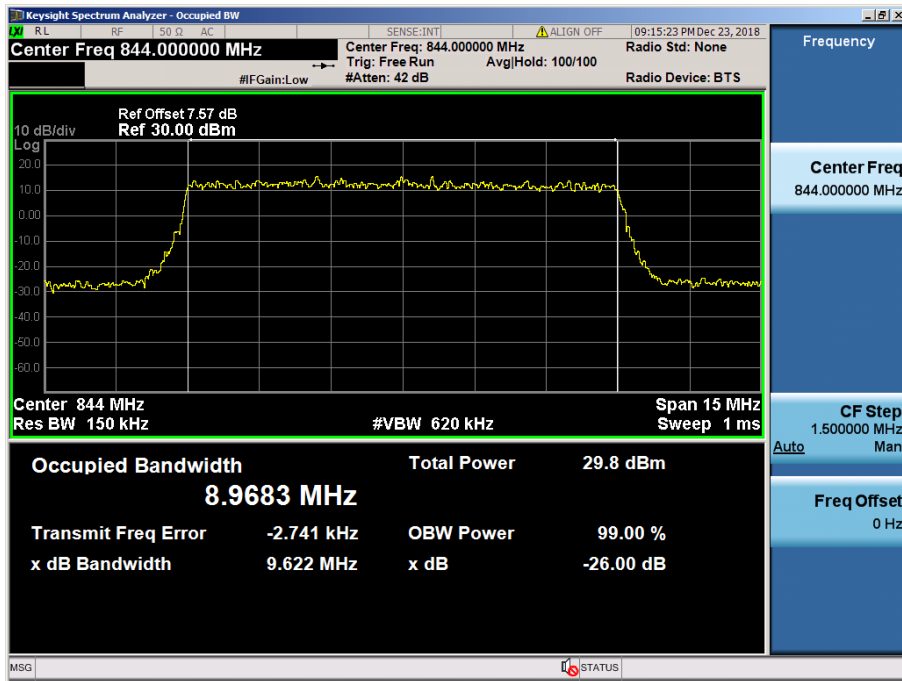

LTE Band 5 / 10 MHz / QPSK - RB Size 50

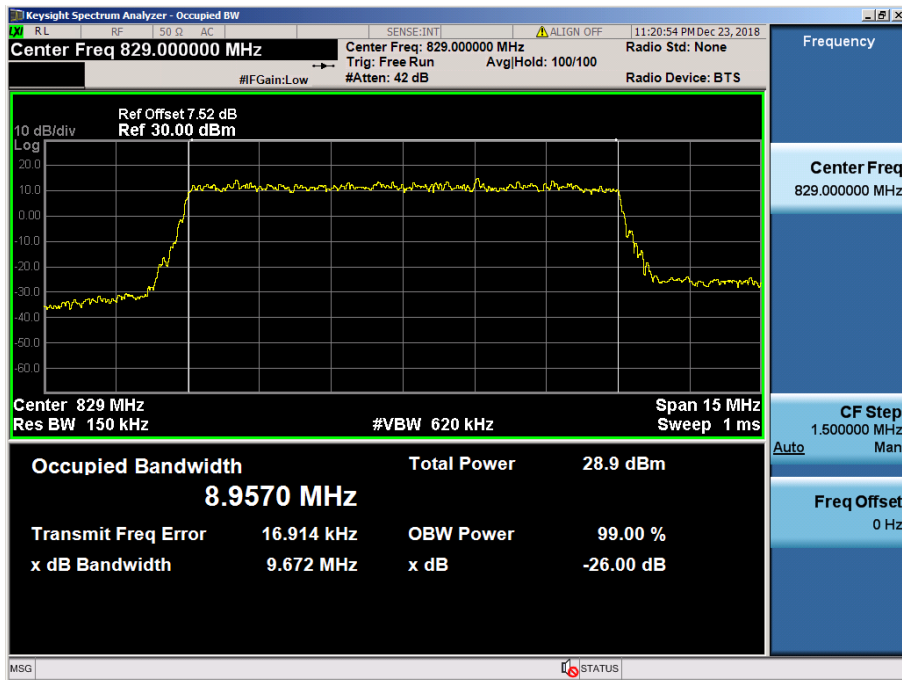

LTE Band 5 / 10 MHz / 16QAM - RB Size 50



LTE Band 5 / 5 MHz / QPSK - RB Size 25

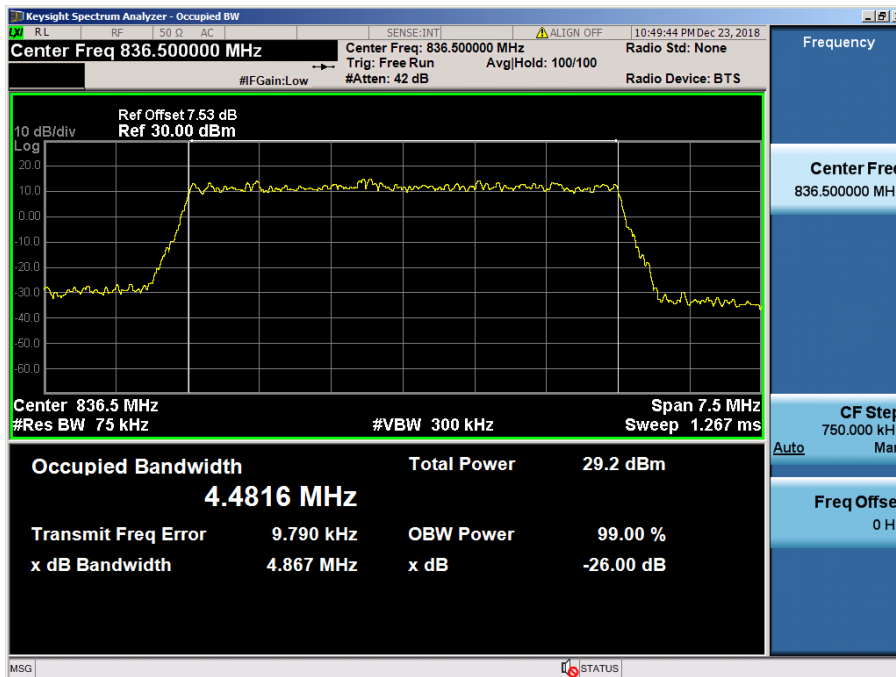

LTE Band 5 / 5 MHz / 16QAM - RB Size 25

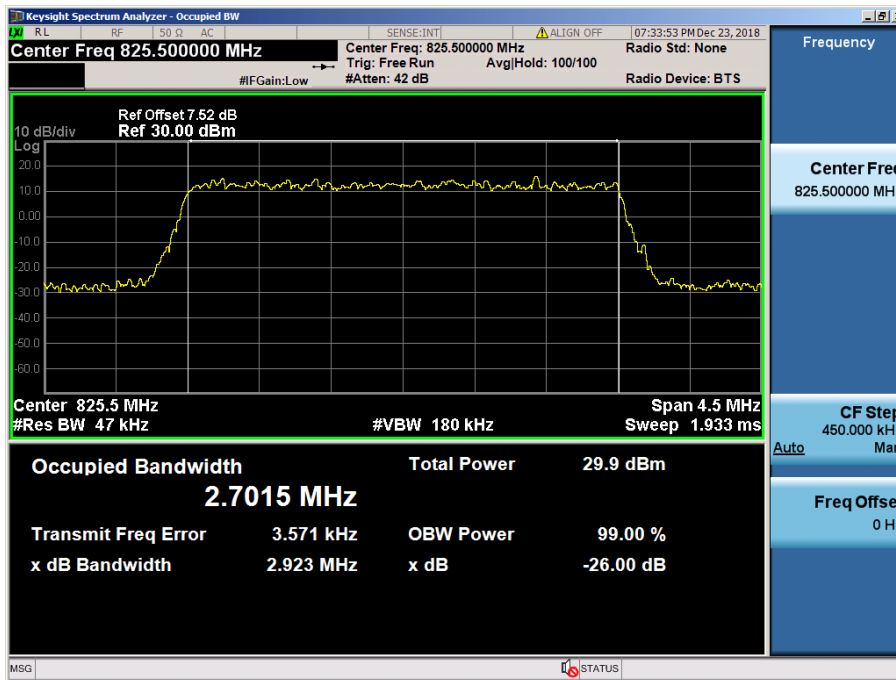

LTE Band 5 / 3 MHz / QPSK - RB Size 15

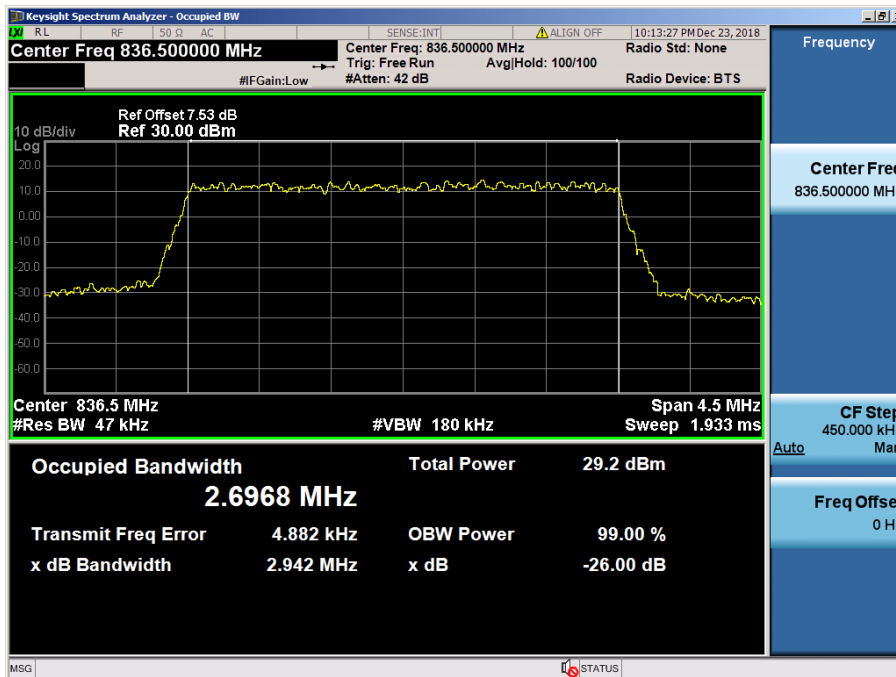

LTE Band 5 / 3 MHz / 16QAM - RB Size 15



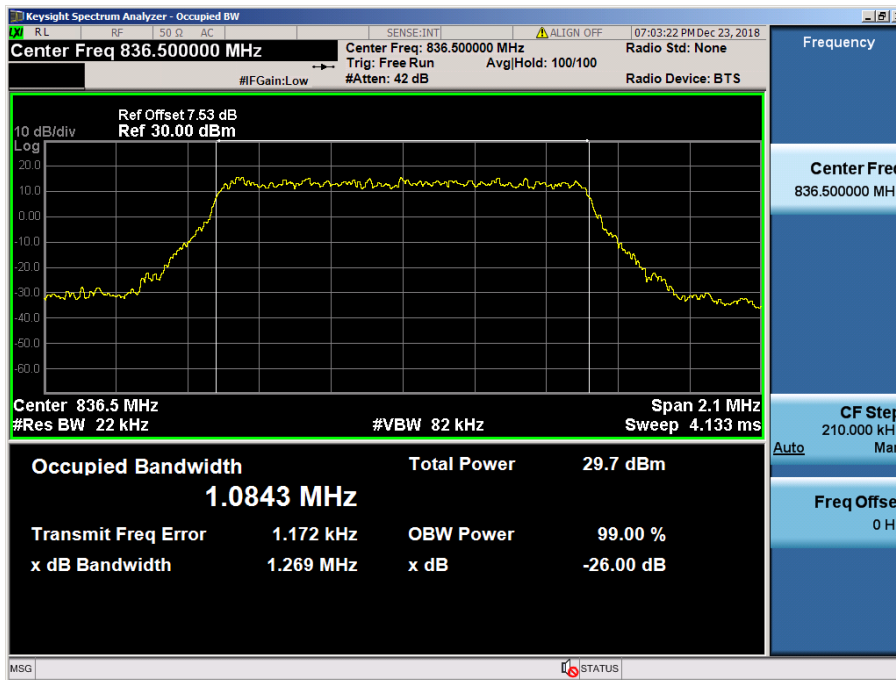

LTE Band 5 / 1.4 MHz / QPSK - RB Size 6

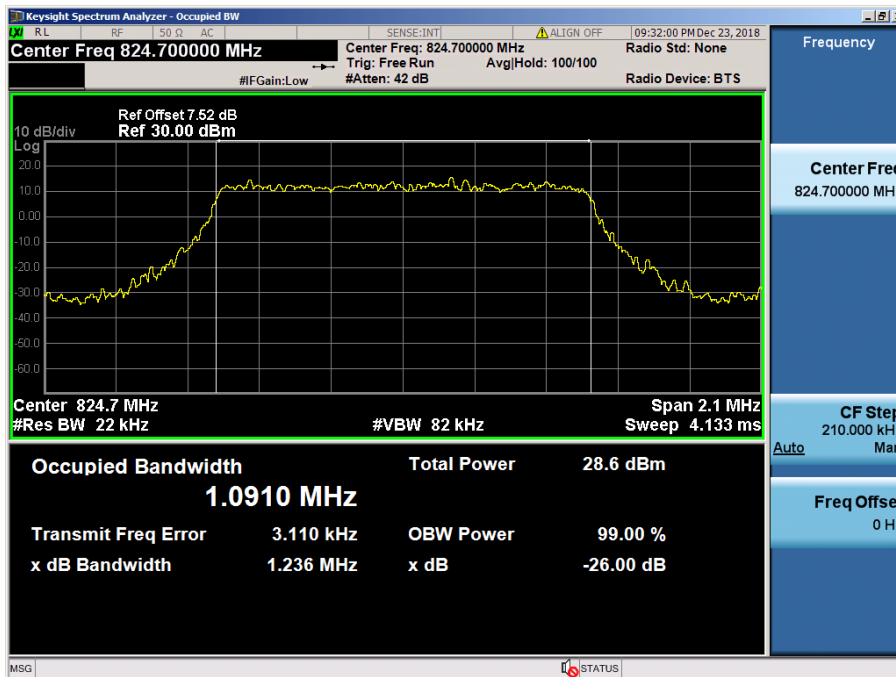

LTE Band 5 / 1.4 MHz / 16QAM - RB Size 6

8.1.6 LTE Band 66, 4

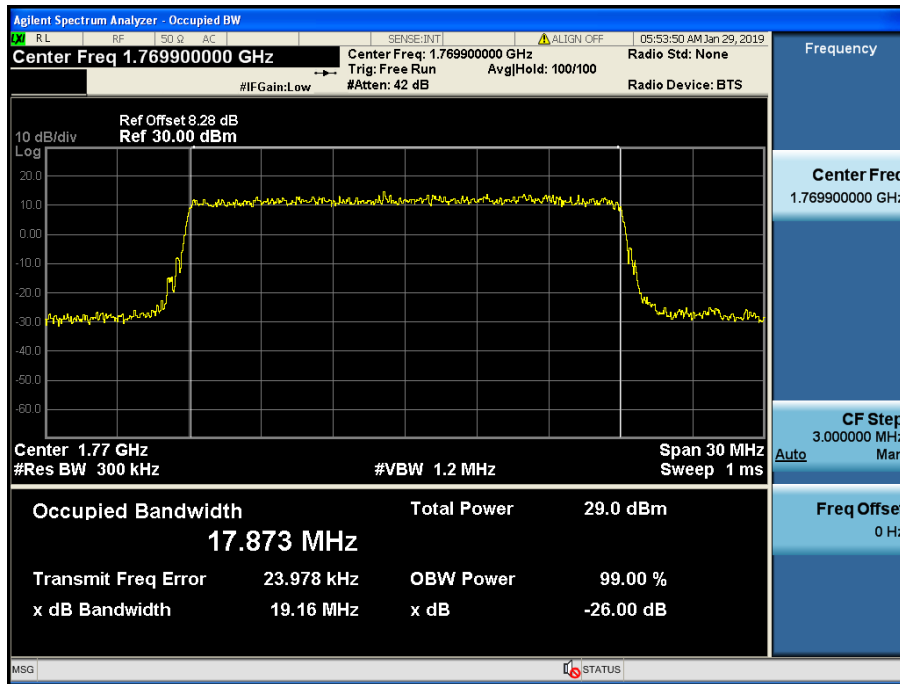

LTE Band 66 / 20 MHz / QPSK - RB Size 100

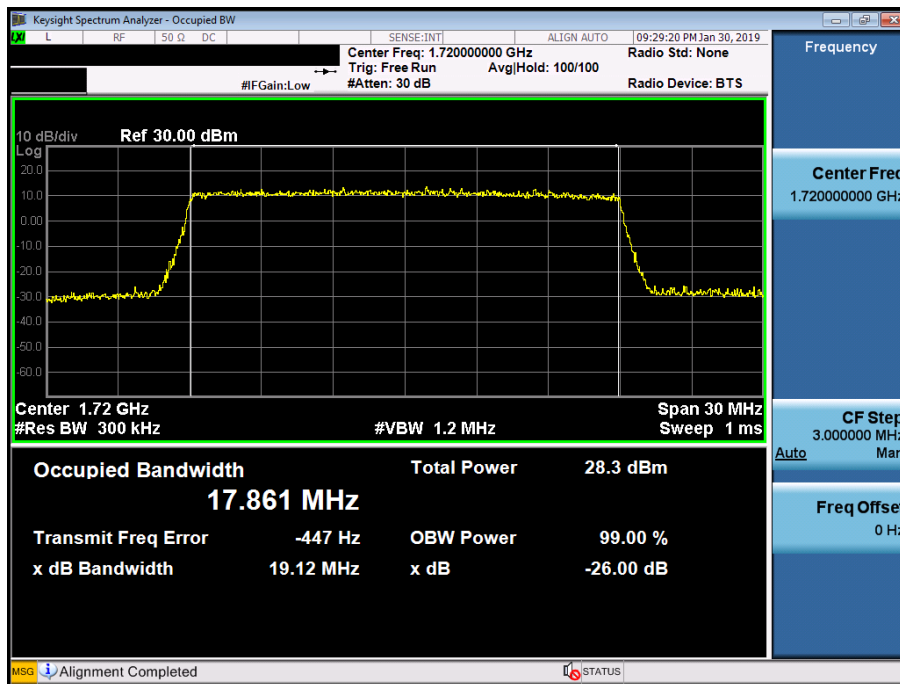

LTE Band 66 / 20 MHz / 16QAM - RB Size 100

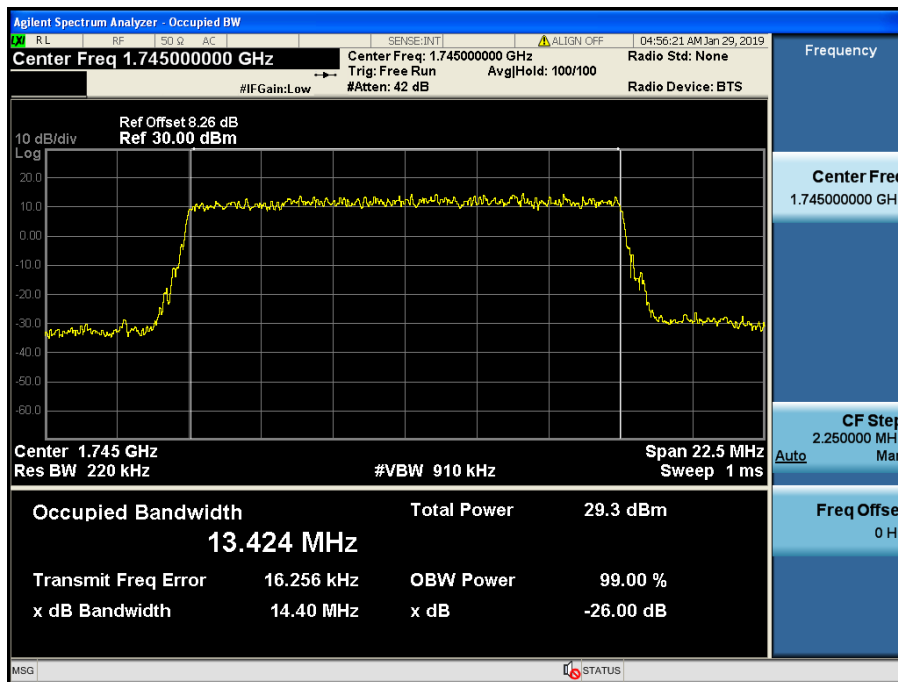

LTE Band 66 / 15 MHz / QPSK - RB Size 75

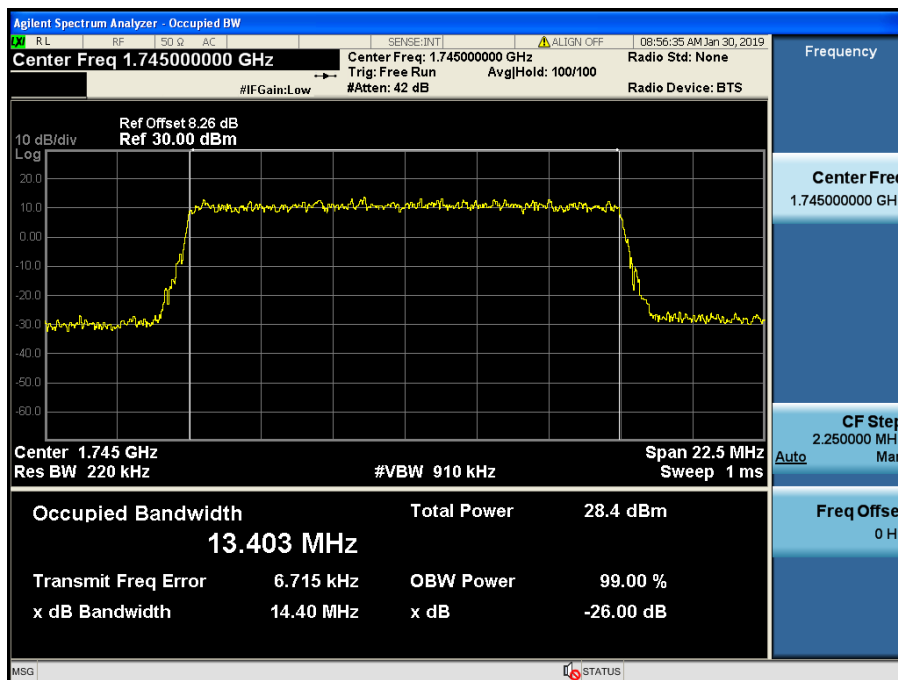

LTE Band 66 / 15 MHz / 16QAM - RB Size 75

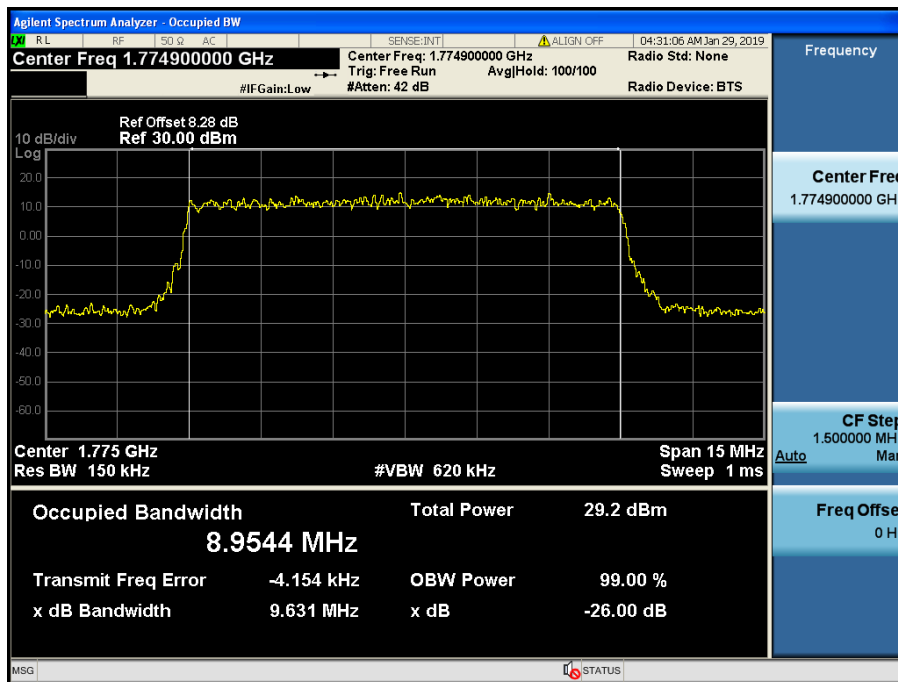

LTE Band 66 / 10 MHz / QPSK - RB Size 50

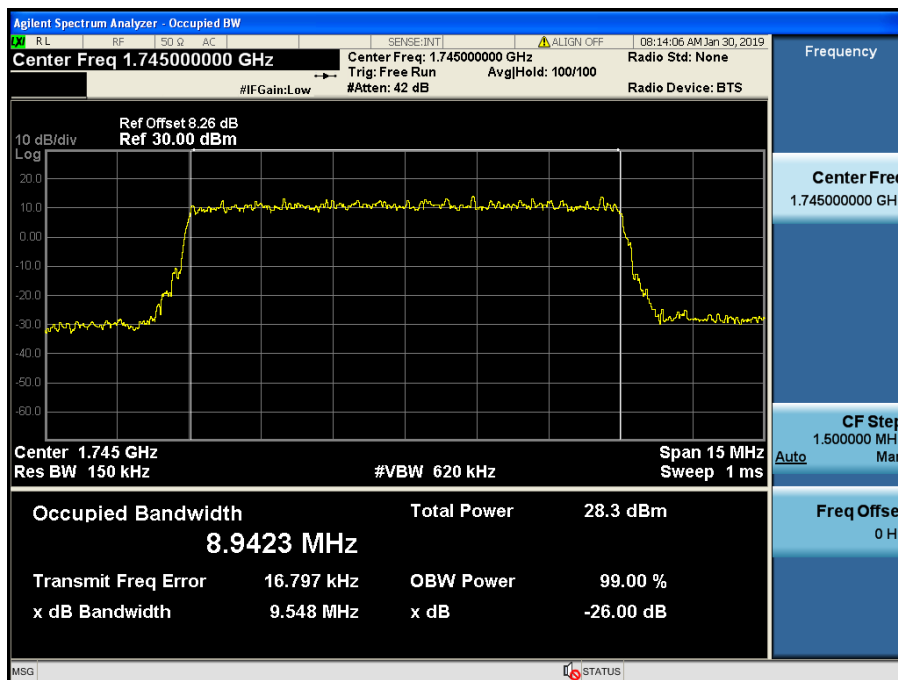

LTE Band 66 / 10 MHz / 16QAM - RB Size 50

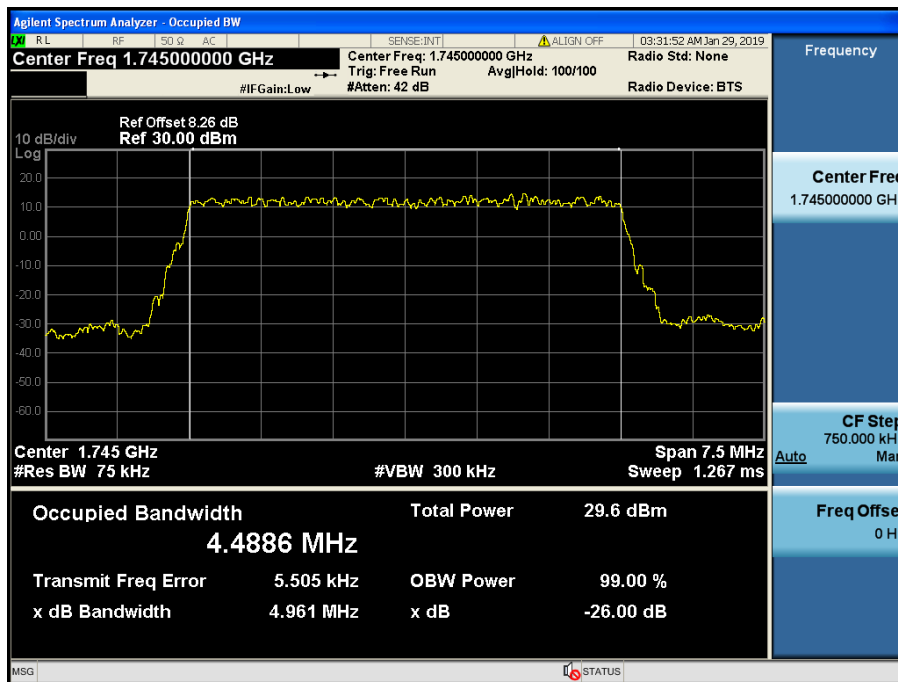

LTE Band 66 / 5 MHz / QPSK - RB Size 25

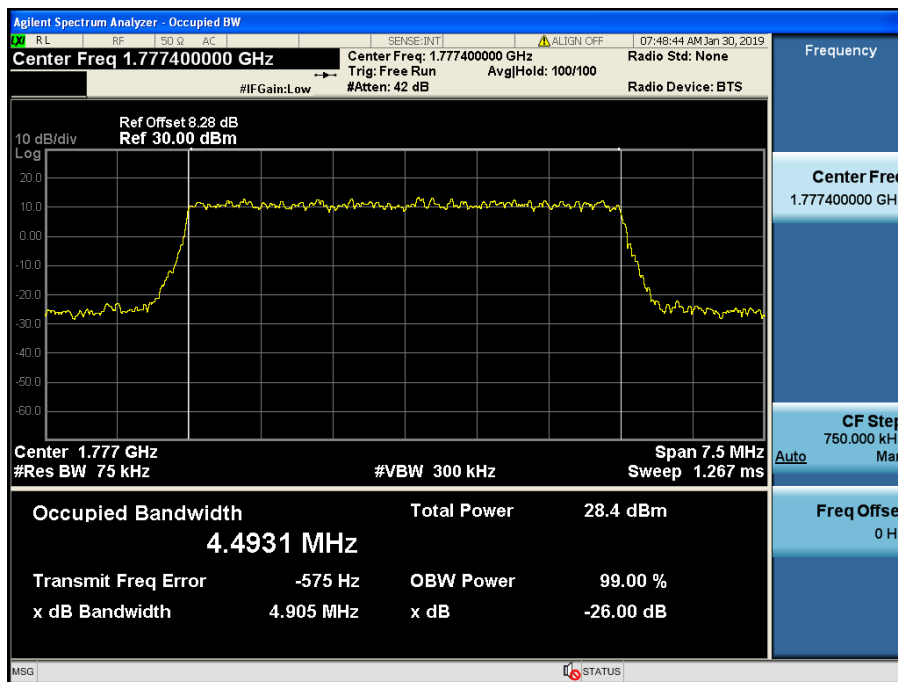

LTE Band 66 / 5 MHz / 16QAM - RB Size 25

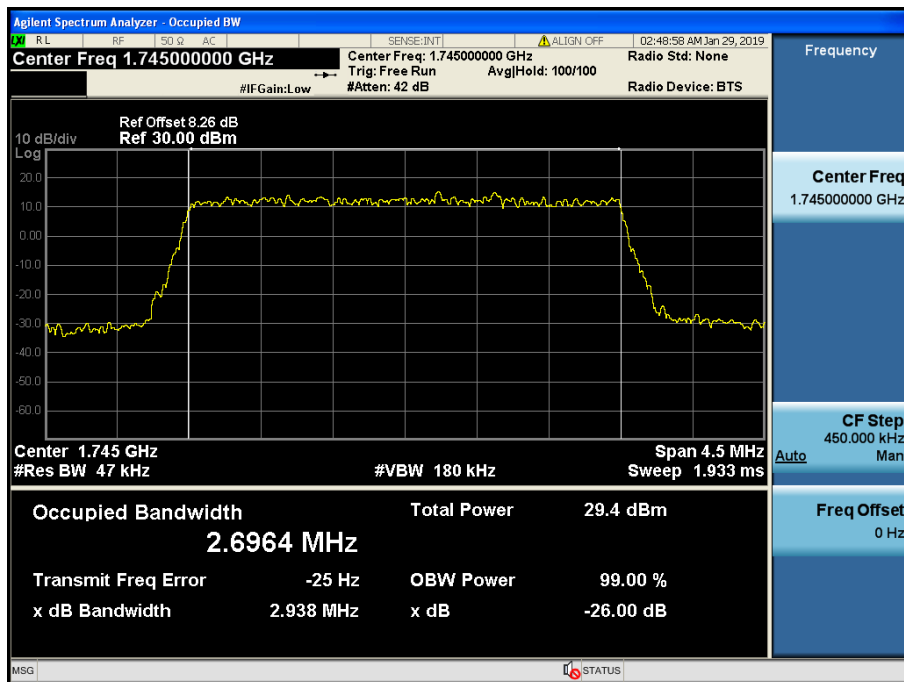

LTE Band 66 / 3 MHz / QPSK - RB Size 15

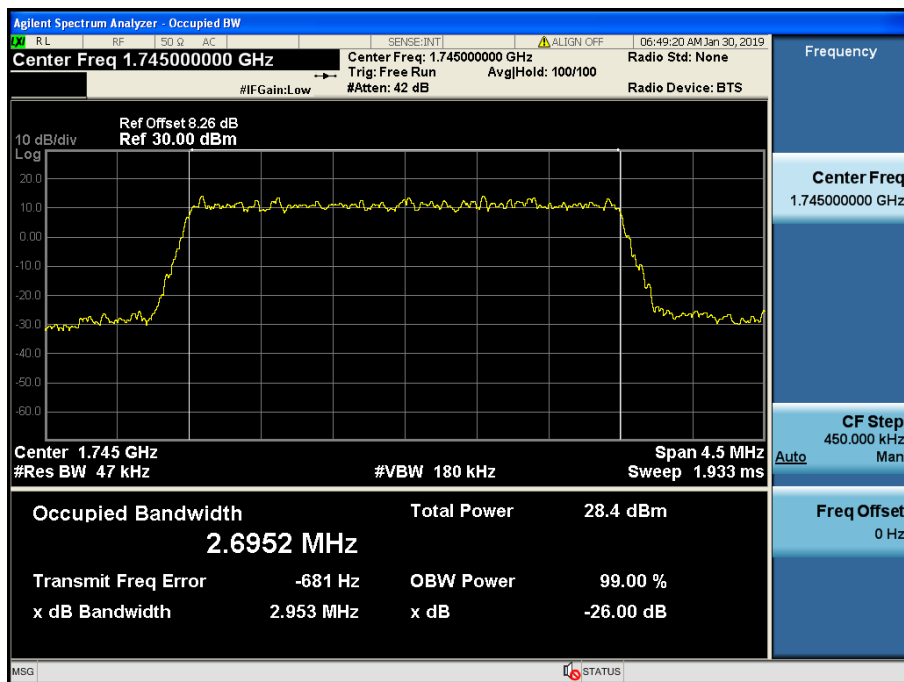

LTE Band 66 / 3 MHz / 16QAM - RB Size 15

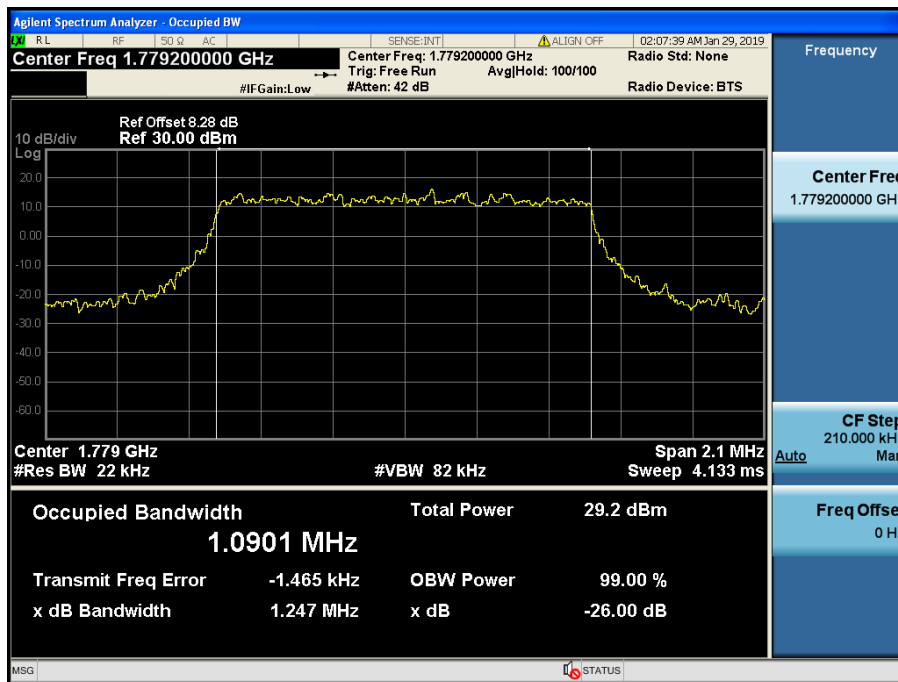

LTE Band 66 / 1.4 MHz / QPSK - RB Size 6

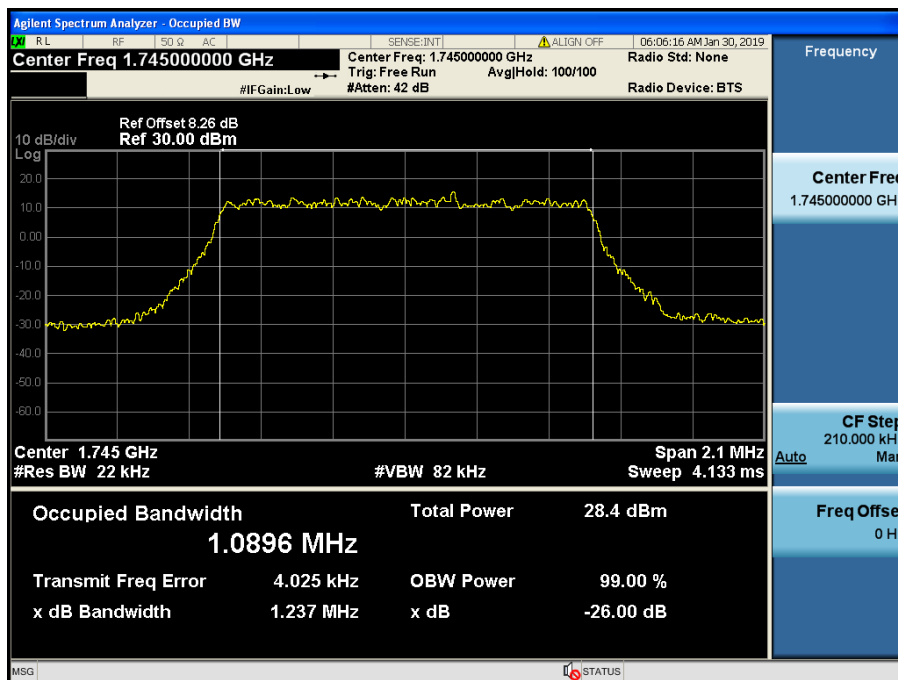

LTE Band 66 / 1.4 MHz / 16QAM - RB Size 6

8.1.7 LTE Band 2

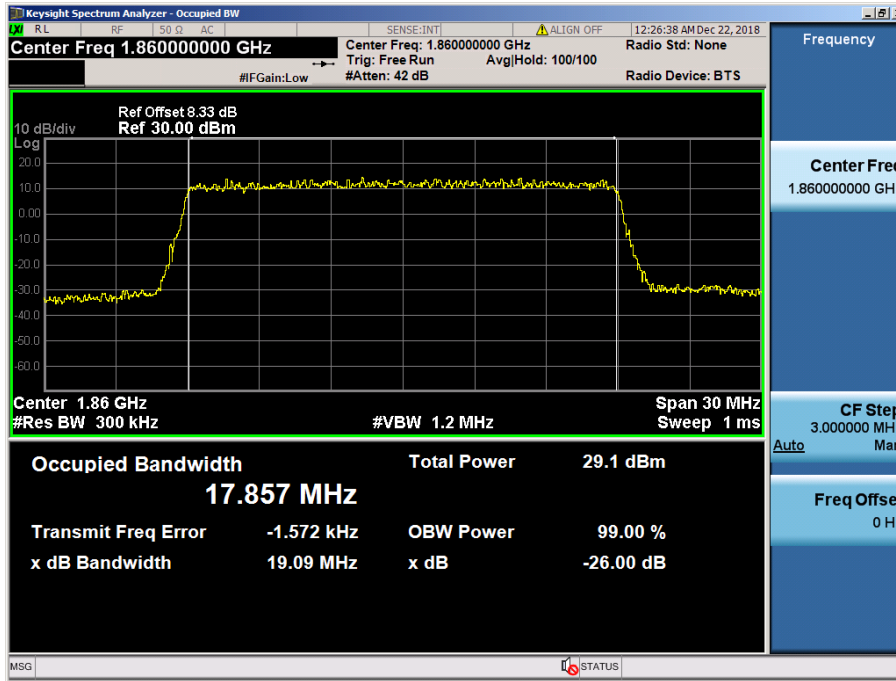

LTE Band 2 / 20 MHz / QPSK - RB Size 100

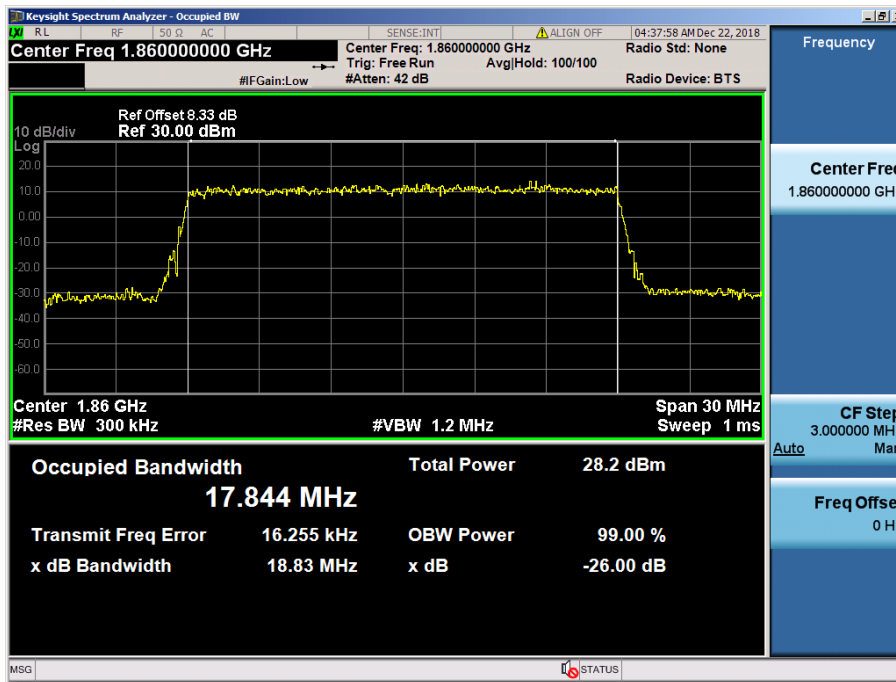

LTE Band 2 / 20 MHz / 16QAM - RB Size 100



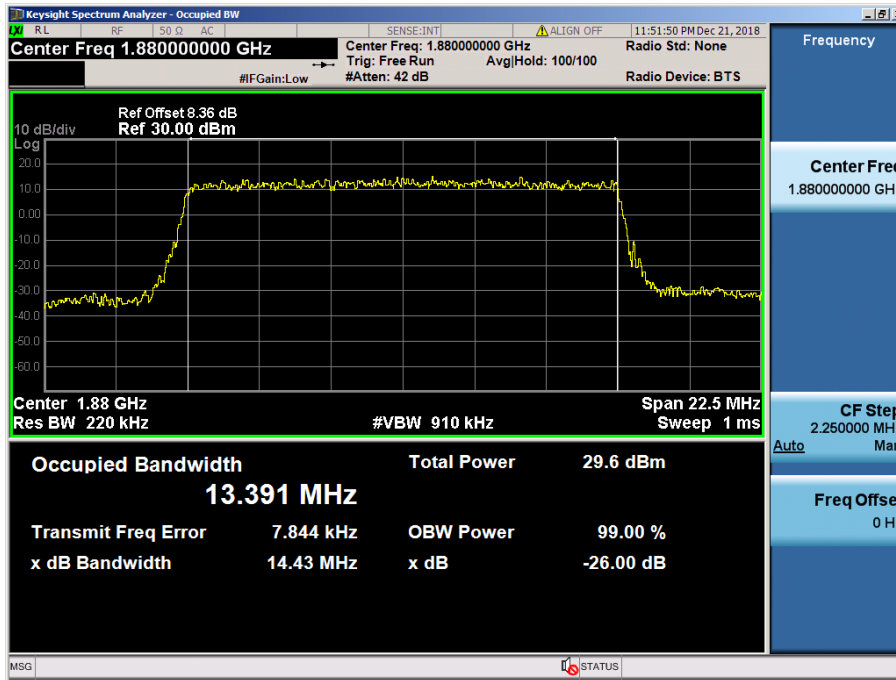

LTE Band 2 / 15 MHz / QPSK - RB Size 75

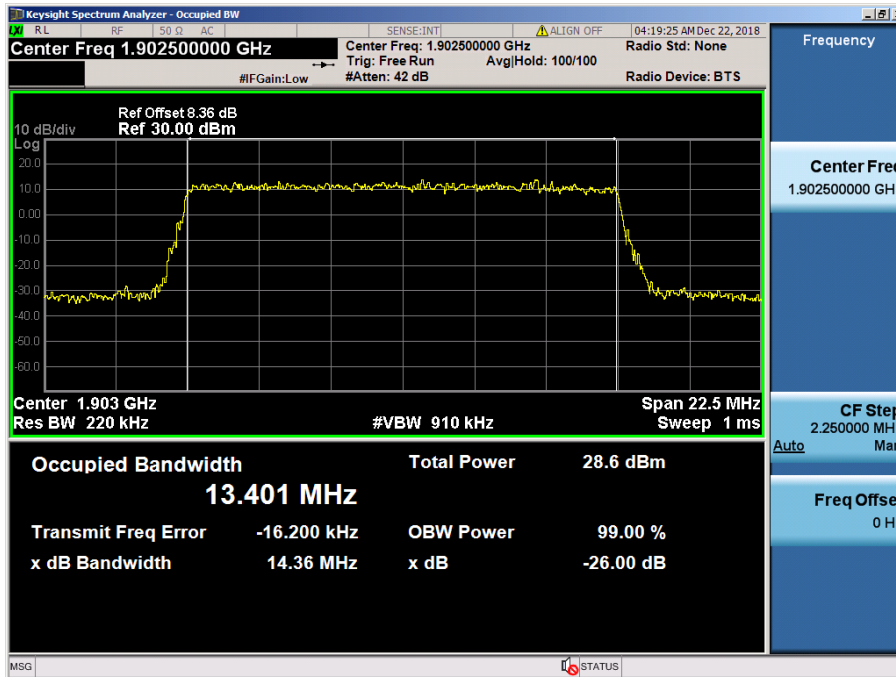

LTE Band 2 / 15 MHz / 16QAM - RB Size 75

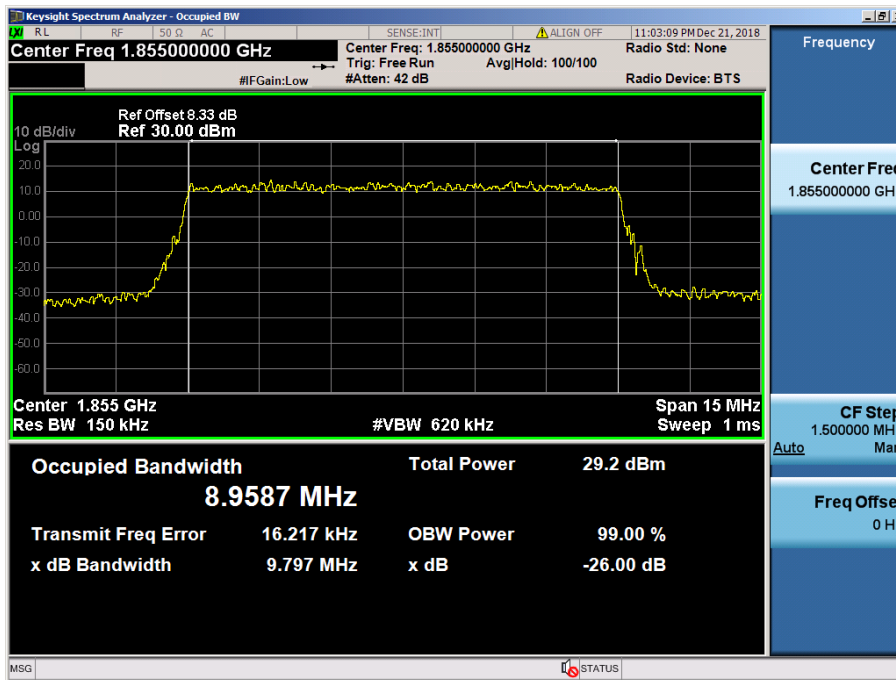

LTE Band 2 / 10 MHz / QPSK - RB Size 50

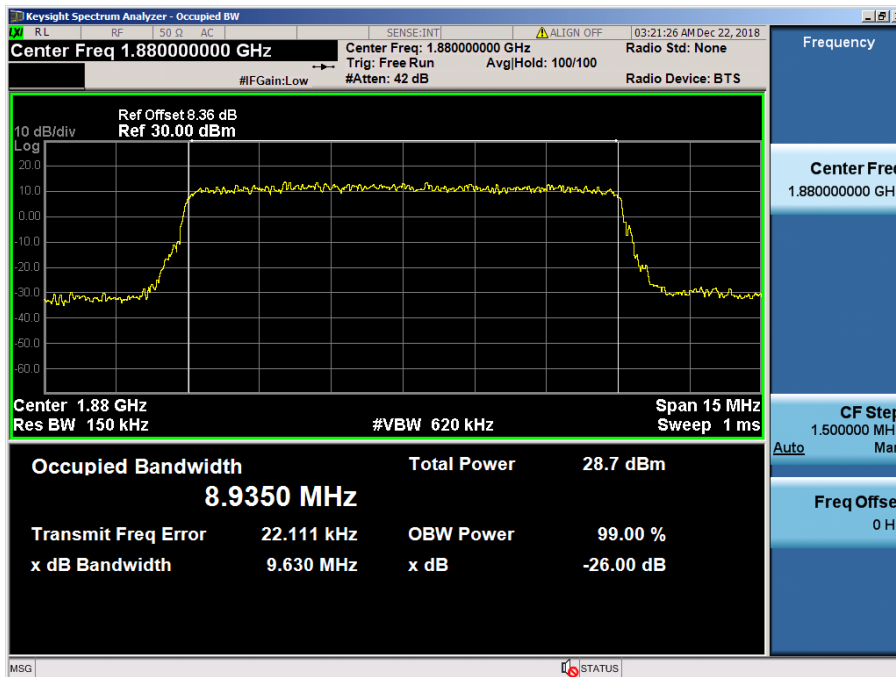

LTE Band 2 / 10 MHz / 16QAM - RB Size 50

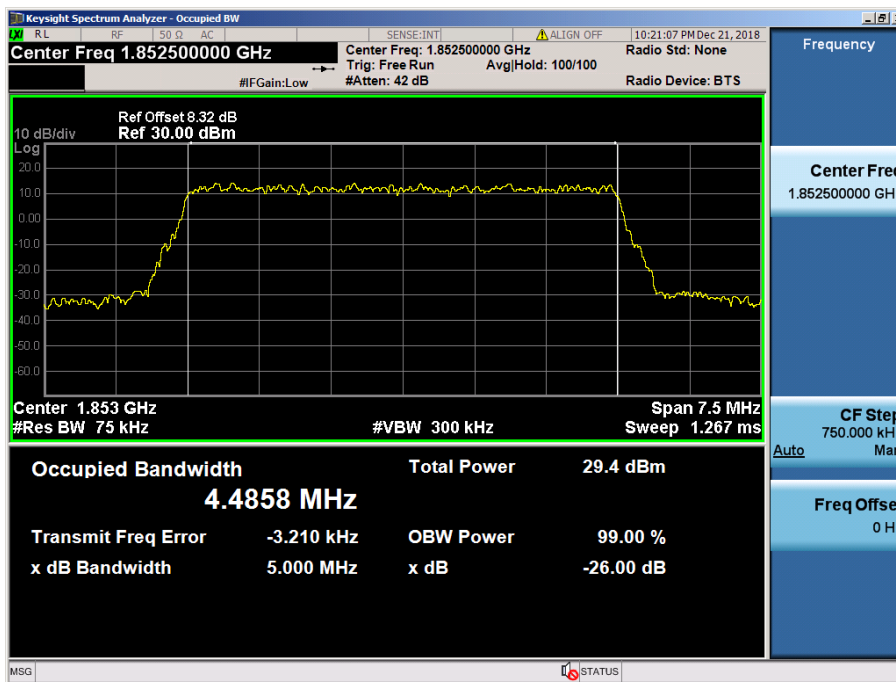

LTE Band 2 / 5 MHz / QPSK - RB Size 25

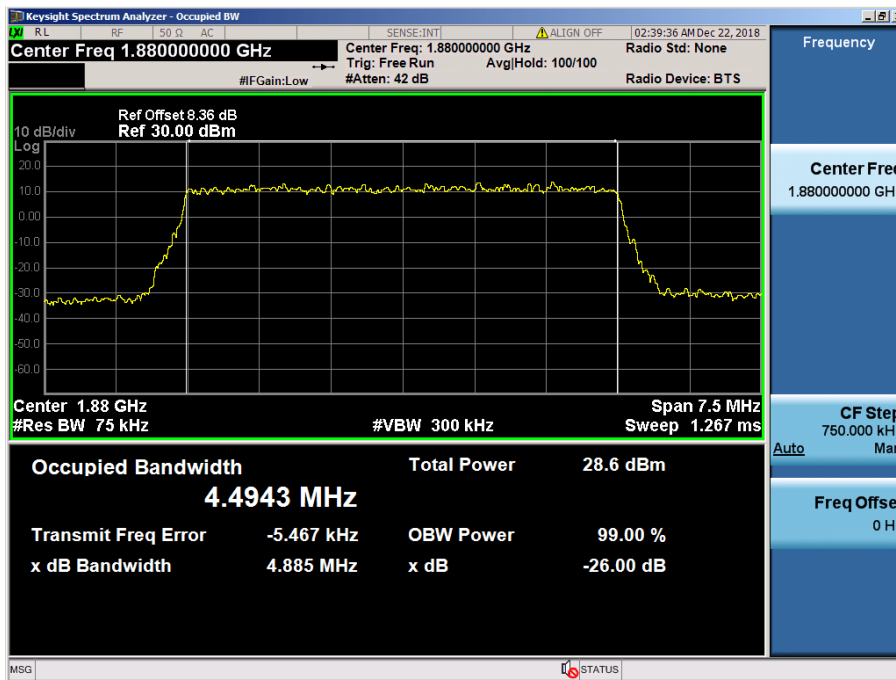

LTE Band 2 / 5 MHz / 16QAM - RB Size 25

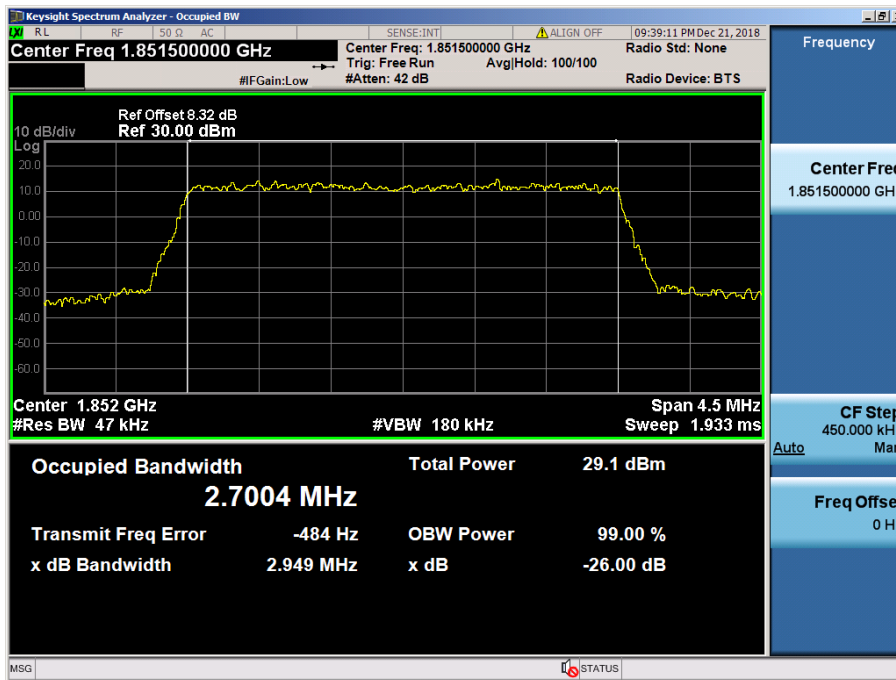

LTE Band 2 / 3 MHz / QPSK - RB Size 15

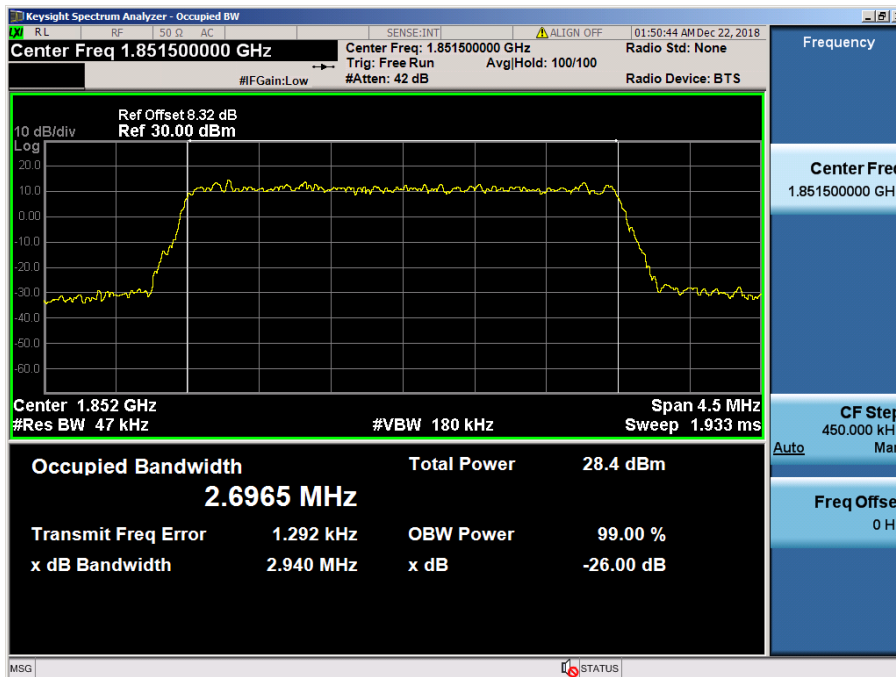

LTE Band 2 / 3 MHz / 16QAM - RB Size 15

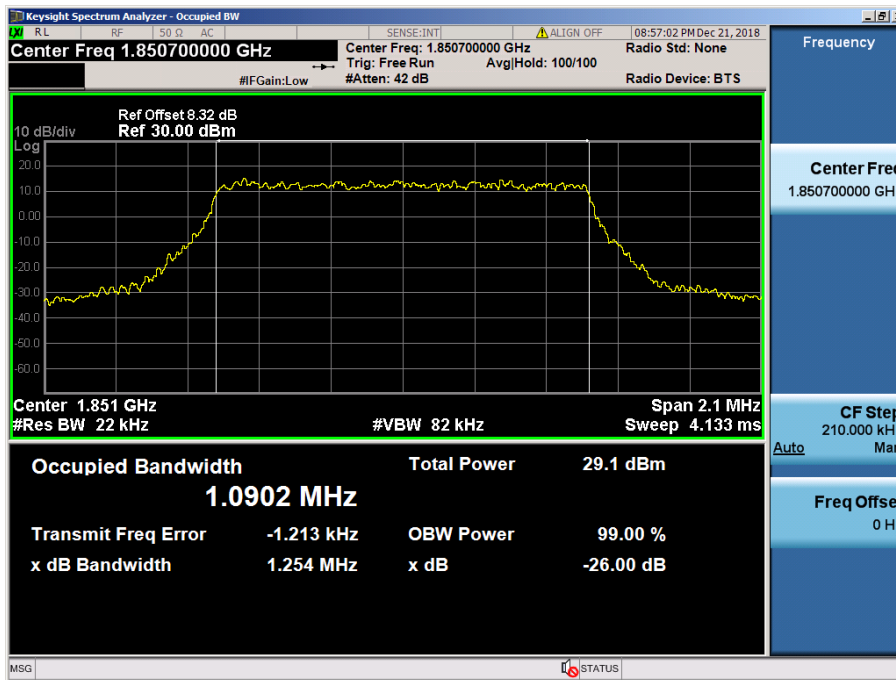

LTE Band 2 / 1.4 MHz / QPSK - RB Size 6

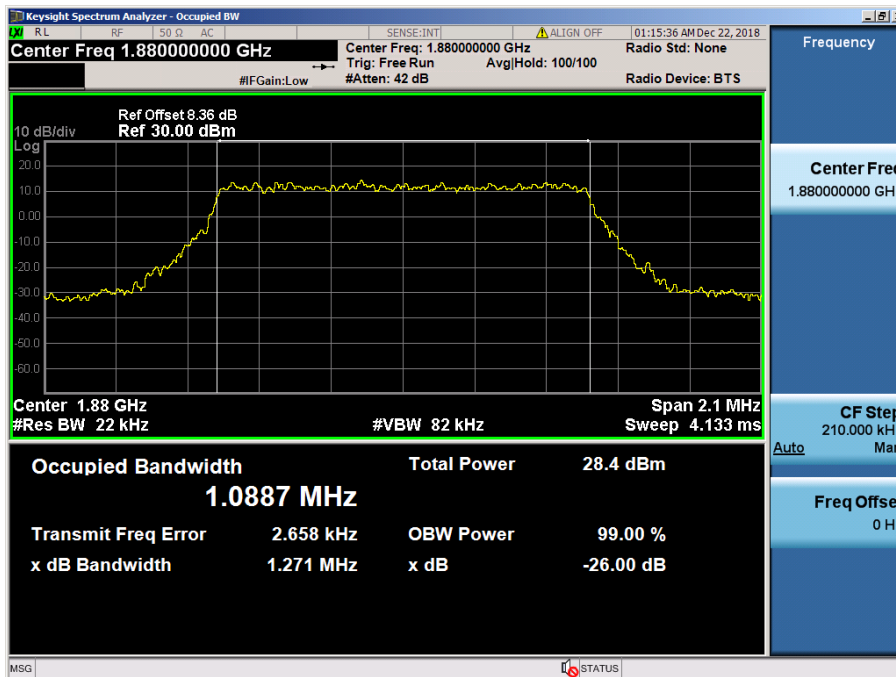

LTE Band 2 / 1.4 MHz / 16QAM - RB Size 6

## 8.2 PEAK TO AVERAGE RATIO

### 8.2.1 LTE Band 71

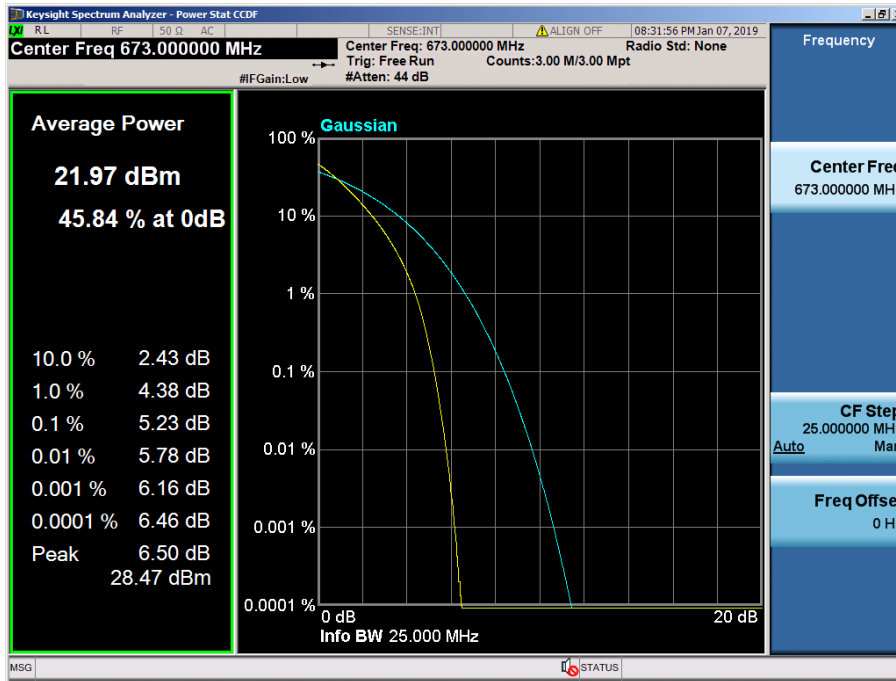

LTE Band 71 / 20 MHz / QPSK - RB Size 100

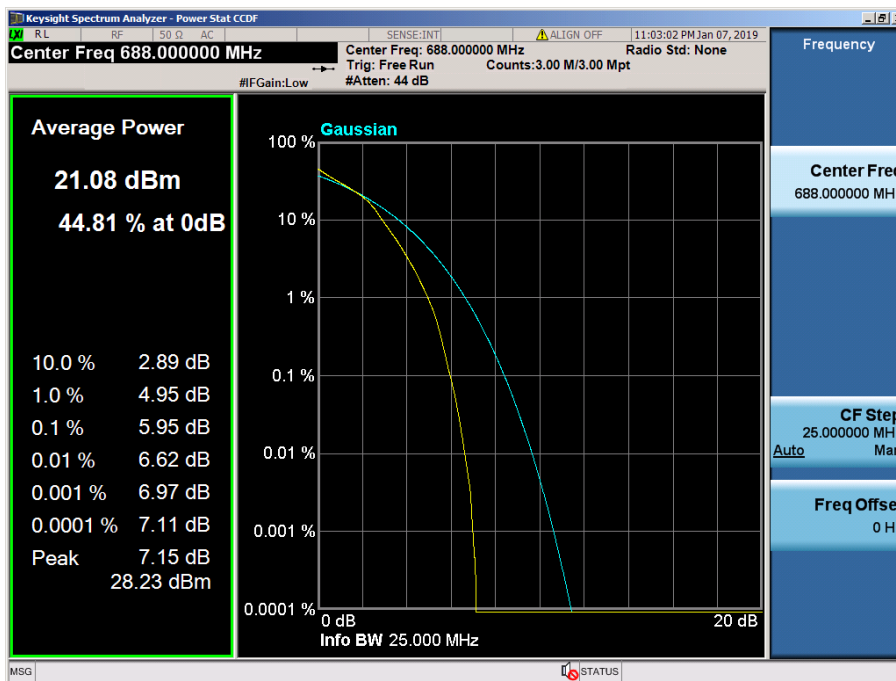

LTE Band 71 / 20 MHz / 16QAM - RB Size 100

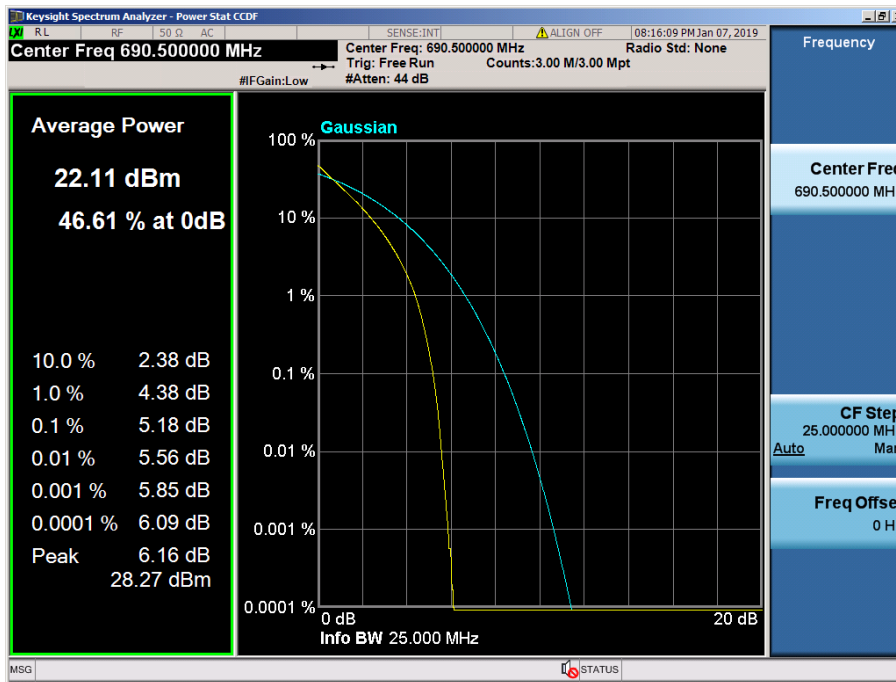

LTE Band 71 / 15 MHz / QPSK - RB Size 75

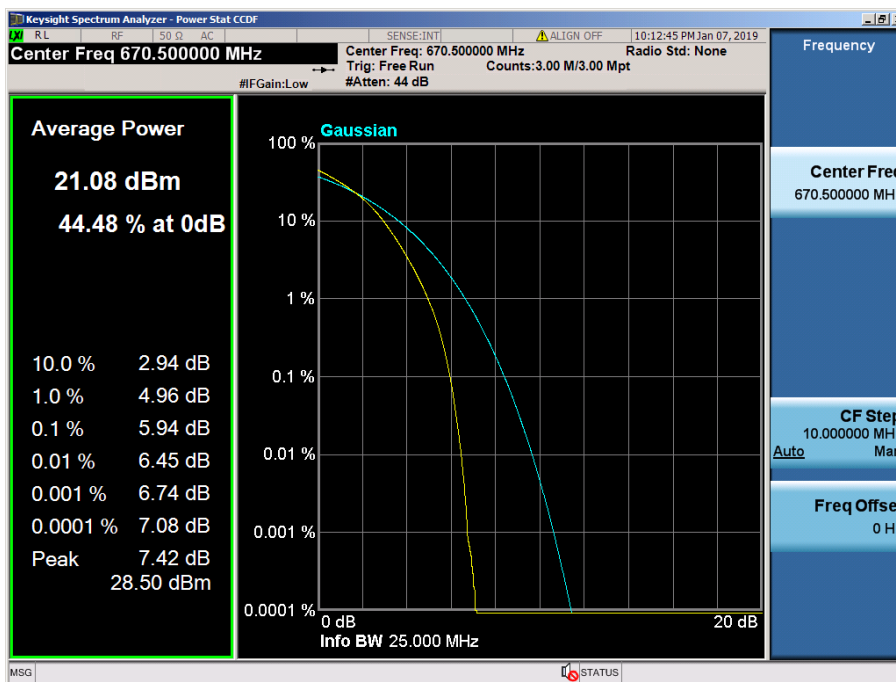

LTE Band 71 / 15 MHz / 16QAM - RB Size 75

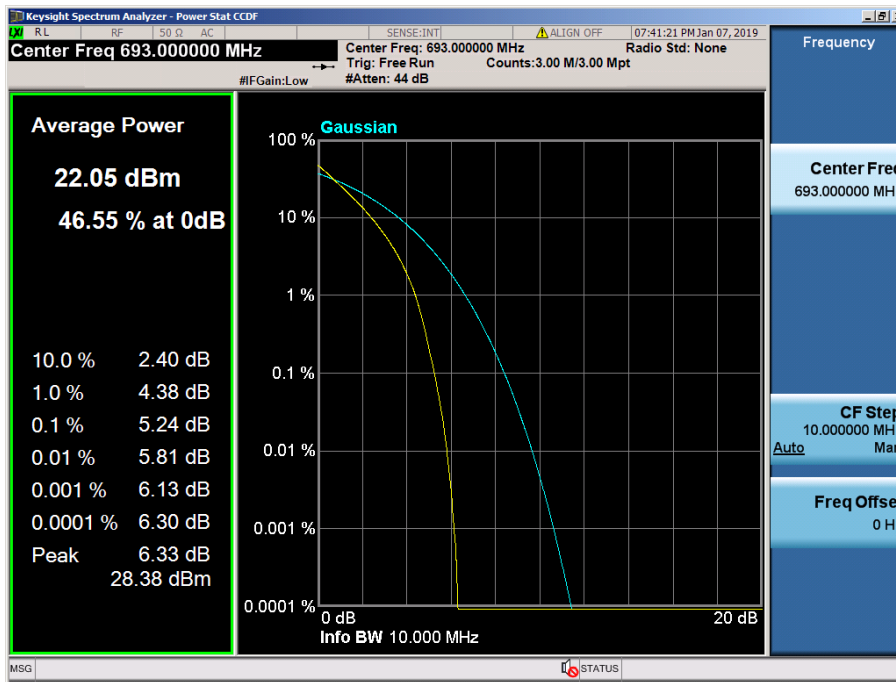

LTE Band 71 / 10 MHz / QPSK - RB Size 50

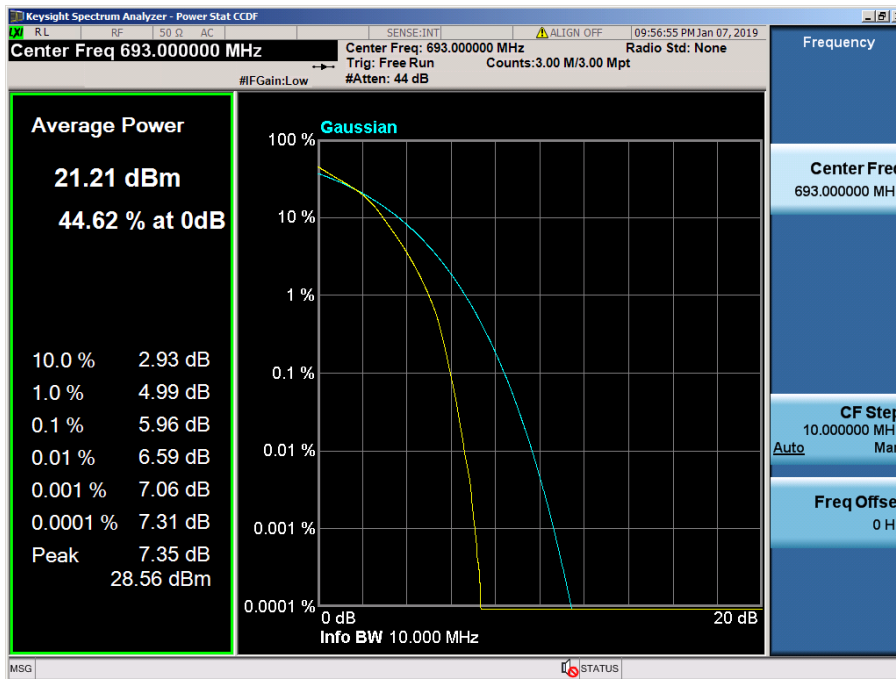

LTE Band 71 / 10 MHz / 16QAM - RB Size 50



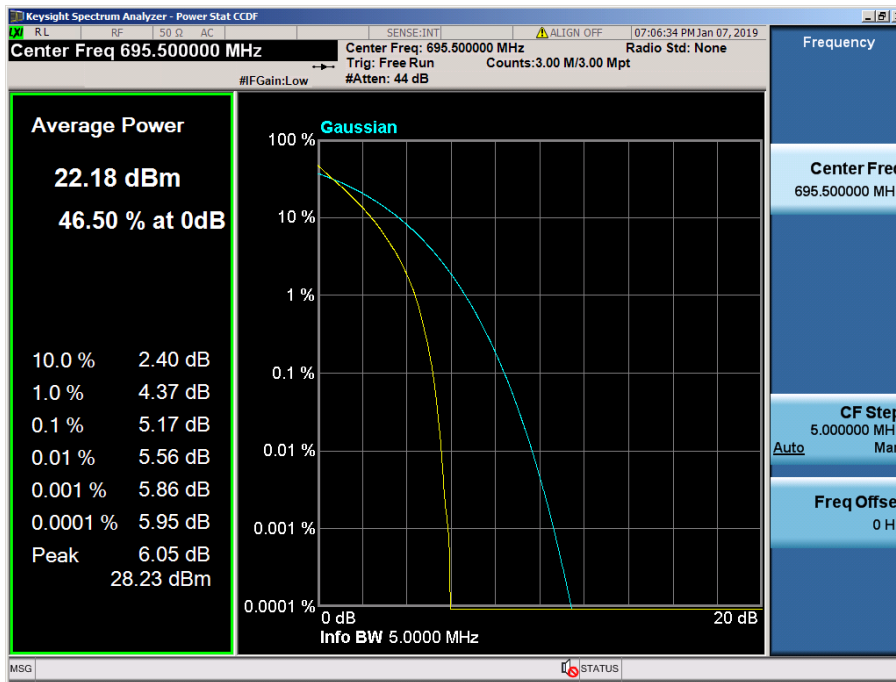

LTE Band 71 / 5 MHz / QPSK - RB Size 25

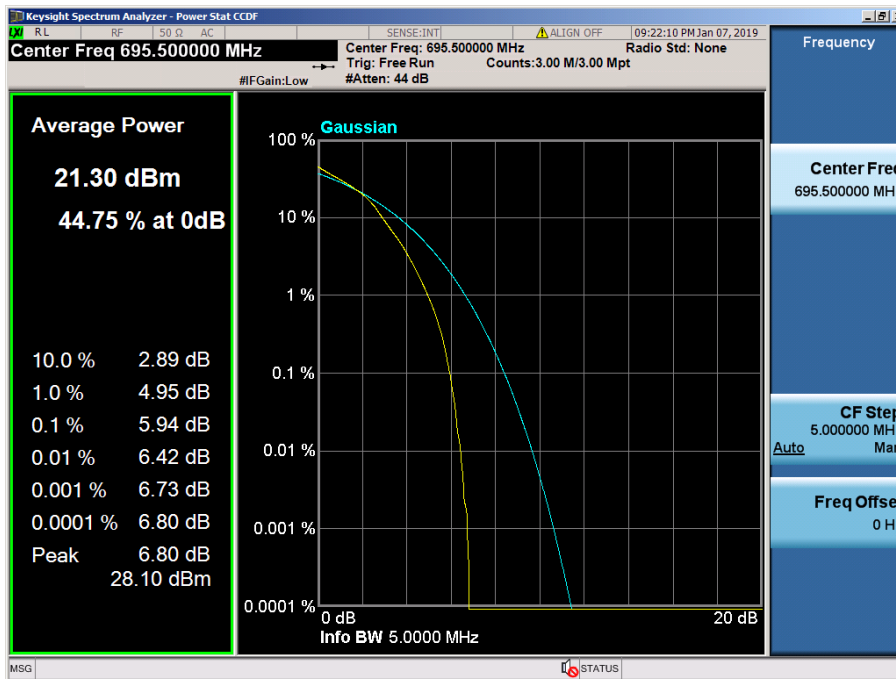

LTE Band 71 / 5 MHz / 16QAM - RB Size 25