

FCC Part 22/24  
&  
RSS 132, Issue 2  
RSS 133, Issue 3  
TEST REPORT  
No.: 2-20722858c/07-C1

for

GSM/GPRS Module

MC55i

**Applicant:** Siemens AG

Laboratory Accreditation and Listings		
 Deutscher Akkreditierungs Rat  DAT-P-176/94-02	<b>Federal Communications Commission</b>  <b>FCC Registration No. 99538 MRA US-EU DE0003</b>	<b>Industry Canada</b>  <b>IC Registration No. IC 3465</b>
accredited according to DIN EN ISO/IEC 17025		

CETECOM GmbH  
Laboratory RC & EMC  
Im Teelbruch 116  
D-45219 Essen  
Germany

Telephone: + 49 (0) 20 54 / 95 19-954  
Fax: + 49 (0) 20 54 / 95 19-964

## Table of contents

<b>1. SUMMARY OF TEST RESULTS</b>	<b>3</b>
1.1. TESTS OVERVIEW	3
<b>2. ADMINISTRATIVE DATA</b>	<b>5</b>
2.1. Identification of the testing laboratory	5
2.2. Test location	5
2.3. Organizational items	5
2.4. Applicant's details	5
2.5. Manufacturer's details	5
<b>3. EQUIPMENT UNDER TEST (EUT)</b>	<b>6</b>
3.1. Additional declaration and description of main EUT	6
3.2. EUT: Type, S/N etc. and short descriptions used in this test report	6
3.3. Auxiliary Equipment (AE): Type, S/N etc. and short descriptions	7
3.4. EUT set-ups	7
3.5. EUT operating modes	8
3.6. Additional declaration and description of EUT's	9
3.7. Configuration of cables used for testing	9
<b>4. MEASUREMENTS SET-UPS</b>	<b>10</b>
4.1. Conducted measurements test set-up	10
4.2. Radiated measurements test set-up	11
4.3. Parameter Settings on mobile phone and base station CMU200	12
<b>5. MEASUREMENTS AND TEST RESULTS</b>	<b>13</b>
5.1. RF power output (Conducted and Radiated)	13
5.2. Occupied 99% bandwidth	16
5.3. Emission limits radiated (Spurious emission radiated) $f < 30$ MHz	18
5.4. Emission limits (Spurious emission) $f > 30$ MHz	20
5.5. Frequency stability on temperature and voltage variations	28
<b>6. MEASUREMENT UNCERTAINTIES</b>	<b>37</b>
<b>7. CALIBRATION METHOD OF ANECHOIC CHAMBER</b>	<b>38</b>
<b>8. INSTRUMENTS AND ANCILLARY</b>	<b>39</b>
8.1. Used equipment "CTC"	39
<b>9. ANNEX 1: DIAGRAMS OF THE MEASUREMENTS</b>	<b>43</b>
9.1. EMISSION BANDWIDTH	43
9.2. OCCUPIED 99% BANDWIDTH	49
9.3. SPURIOUS EMISSIONS CONDUCTED	55
9.4. RADIATED SPURIOUS EMISSIONS	81
9.5. MAGNETIC FIELD STRENGTH MEASUREMENTS (RADIATED)	131
9.6. IC : CONDUCTED MEASUREMENTS IN RX-MODE 850MHZ, RSS-132-ISSUE 2, CHAPTER 4.6	137
9.7. IC: CONDUCTED MEASUREMENTS IN RX-MODE 1900 MODE: RSS-133-ISSUE 3, CHAPTER 6.7(B)	138
<b>10. ANNEX A - PHOTOS: EUT AND ACCESSORIES</b>	<b>139</b>
<b>11. ANNEX B - PHOTOS: TEST SET-UP</b>	<b>139</b>

## 1. Summary of test results

The test results apply exclusively to the test samples as presented in chapter 3.1. The CETECOM GmbH does not assume responsibility for any conclusions and generalisations taken in conjunction with other specimens or samples of the type of the item presented to tests.

The presented GSM 850/900/1800/1900 Module can be build inside host applications and extends their capability by wireless GSM technology. Data transmission or voice application are possible field applications.

In order to verify the compliance, a representative configuration consisting of different auxiliary equipment was chosen. Embedded in this configuration, the GSM/GPRS Module can be tested.

Following tests have been performed to show compliance with applicable standards: FCC Part 2, Part 22 and Part 24, Subpart E (Broadband PCS) of the FCC CFR 47 Rules and RSS-132 and RS-133 IC rules.

### ATTESTATION:

I declare that all measurements were performed by me or under my supervision and that all measurements have been performed and are correct to my best knowledge and belief to Industry Canada standards. All requirements as shown in below table are met in accordance with enumerated standards.

### 1.1. TESTS OVERVIEW

TEST CASES	PORT	REFERENCES & LIMITS			EUT set-up	EUT operating mode	Result
		FCC Standard	RSS Section	TEST LIMIT			
TX-Mode							
RF POWER (conducted)	Antenna terminal (conducted)	§2.1046	--	N/A	1	2+4	Passed
RF-POWER radiated (ERP/EIRP)	Cabinet	§2.1046 §22.913(a)(2) §24.232(c)	RSS-132: 4.4 SRSP-503: 5.1.3  RSS-133:6.4 SRSP-510: 5.1.2	< 7 Watt ERP  < 2 Watt (EIRP)	1	2+4	Passed
SPURIOUS EMISSIONS (conducted)	Antenna terminal (conducted)	§2.1051 §22.917(a)(b) §24.238(a)(b)	RSS 132: 4.5.1 RSS 133: 6.5.1	43+10log(P) dBc	1	2+4	Passed
99% OCCUPIED BANDWIDTH	Antenna terminal (conducted)	§2.202 §2.1049 §22.917(a) §24.238(a)	RSS Gen:4.6.1	99% Power	1	2+4	Passed

SPURIOUS EMISSIONS (radiated)	Cabinet + Interconnecting cables (radiated)	§15.209(a)	RSS-Gen: 4.11 RSS-210: Table 3 RSS-310: Table 4	2400/F(kHz) $\mu$ V/m 24000/F(kHz) $\mu$ V/m 30 $\mu$ V/m	1	2+4	Passed
		§2.1053(a) §22.917(a)(b) §24.238(a)(b)	RSS-132: 4.5.1 RSS 133: 6.5.1	43+10log(P) dBc	1	2+4	Passed
FREQUENCY STABILITY	Antenna terminal (conducted)	§22.355 §24.235 §2.1055	RSS-132: 4.3 RSS 133: 6.3	< 2.5ppm  <0.1 ppm	1+2	2+4	Passed

RX Mode							
RECEIVER  Spurious emissions	Cabinet + Interconnecting cables (radiated)	§15.109 §15.33 §15.35	RSS-132: 4.6 RSS-Gen:6(a)  RSS 133: 6.7(a)	FCC 15.109 Limits	1	1+3	Passed Remark 1
		Antenna terminal (conducted)	§2.1051	RSS-Gen: 6(b) RSS132: 4.6 RSS133: 6.7(b)	43+10log(P) dBc	2	

Remark: 1.) See separate test report B\_2\_20722858b/07 for measurements according Part 15, Subpart B.

.....  
D. Franke  
Responsible for testing laboratory



GmbH  
Im Teebruch 116  
45219 Essen  
Tel.: + 49 (0) 20 54 / 95 19 - 0  
Fax: + 49 (0) 20 54 / 95 19 - 097

.....  
Dipl.-Ing. C. Lorenz.  
Responsible for test report

This test report B\_2\_20722858C\_07-C1 is replacing test report no. B\_2\_20722858C\_07 dated 10.12.2007.

## 2. Administrative Data

### 2.1. Identification of the testing laboratory

Company name:	CETECOM GmbH
Address:	Im Teelbruch 116 45219 Essen – Kettwig, Germany
Laboratory accreditations/Listings:	DAR-Registration No. DAT-P-176/94-02 FCC-Registration No. 99538 MRA US-EU DE0003 IC-Registration No. 3465
Responsible for testing laboratory:	Dipl.-Ing. W. Richter
Deputies:	Dipl.-Ing. H. Strehlow, D. Franke

### 2.2. Test location

#### 2.2.1. Test laboratory “CTC”

Company name:	see chapter 2.1. Identification of the testing laboratory
---------------	---

### 2.3. Organizational items

Order No.:	20722858
Responsible for test report and project leader:	Dipl.-Ing. C. Lorenz
Receipt of EUT:	20.11.2007
Date(s) of test:	21.11.2007 – 07.12.2007
Date of report:	03.01.2008
Number of report pages:	139
-----	
Version of template:	07.11

### 2.4. Applicant’s details

Applicant’s name:	Siemens AG
Address:	ICM WM RD ST3 Siemensdamm 50 13623 Berlin Germany
Contact person:	Mr. Thorsten Liebig

### 2.5. Manufacturer’s details

Manufacturer’s name:	please see Applicant's details
Address:	please see Applicant's details

### 3. Equipment under test (EUT)

#### 3.1. Additional declaration and description of main EUT

Main function	GSM/GPRS Module		
Type	MC55i		
GSM Frequency range	GSM850: 824 - 849MHz (Uplink), 869 – 894 MHz (Downlink) GSM1900: 1850-1910MHz (Uplink), 1930-1990MHz (Downlink)		
Type of modulation	GMSK		
Number of channels	GSM850: 128 – 251, 125 channels GSM1900: 512 – 810, 300 channels		
EMISSION DESIGNATOR(S)			
Antenna Type	Antenna connector, tested with external standard car magnet antenna		
MAX PEAK Output Power: GSM 850 Radiated	32.02 dBm		
GSM 1900	30.82 dBm		
MAX PEAK Output Power: GSM 850 Conducted	32.57 dBm		
GSM1900	30.11 dBm		
FCC-ID	QIPMC55i		
IC	267W-MC55i		
Installed option	--		
Special EMI components	--		
EUT sample type	<input type="checkbox"/> Production	<input checked="" type="checkbox"/> Pre-Production	<input type="checkbox"/> Engineering

(Applicant's declaration,  = not selected,  = selected)

#### 3.2. EUT: Type, S/N etc. and short descriptions used in this test report

Short description*)	EUT	Type	S/N serial number	HW hardware status	SW software status
EUT A	GSM/GPRS Module	MC55i	IMEI: 004401080149 475	B2.1	00.303
EUT B	GSM/GPRS Module	MC55i	IMEI: 004401080149 509	B2.1	00.303

\*) EUT short description is used to simplify the identification of the EUT in this test report.

### 3.3. Auxiliary Equipment (AE): Type, S/N etc. and short descriptions

AE short description *)	Auxiliary Equipment	Type	S/N serial number	HW hardware status	SW software status
AE 1	DSB Board	DSB45_B1.1	S30880-Q8301-A1-3 A5B009001034 50-A	B1.1	--
AE 2	DSB Board	DSB45_B1.1	S30880-Q8301-A1-3 A5B009001034 50-B	B1.1	--
AE 3	Handset for Siemens	M20T, MC35T, TC35T, DSB35	017953211304	HH-SI-30.3/V1.1/0--	--
AE 4	GSM Antenna	1140.26-MMCX/m	--	--	--
AE 5	RS 232 cable	--	--	--	--
AE 6	Notebook	Dell D610	EMC #4	--	Windows XP + Terminal Program

\*) AE short description is used to simplify the identification of the auxiliary equipment in this test report.

### 3.4.EUT set-ups

EUT set-up no. *)	Combination of EUT and AE	Remarks
Set. 1	EUT A + AE 1 + AE 3 + (AE 4) + AE 5 + (AE 6)	For conducted tests no AE 4 used
Set. 2	EUT B + AE 2 + AE5 + (AE6)	Test performed: Frequency Error TCH850 mode Receiver conducted spurious emissions

\*) EUT set-up no. is used to simplify the identification of the EUT set-up in this test report.

### 3.5. EUT operating modes

EUT operating mode no. *)	Description of operating modes	Additional information
op. 1	<b>GSM 850</b> Idle mode BCCH 50	The mobile station is synchronized to the Broadcast Control Channel (BCCH) and listening to the Common Control Channel (CCCH). Periodic location update is disabled.
op. 2	<b>GSM 850</b> TCH mode	A communication link is established between the mobile station and the test simulator. The transmitter is operated at its maximum rated output power: 33 dBm (power class 4; power control level 5). The input signal to the receiver is modulated with normal test modulation. The wanted RF input signal level to the receiver of the mobile station is set to a level to provide a stable communication link.
op. 3	<b>GSM 1900</b> Idle mode BCCH 651	The mobile station is synchronized to the Broadcast Control Channel (BCCH) and listening to the Common Control Channel (CCCH).
op. 4	<b>GSM 1900</b> TCH mode	A communication link is established between the mobile station and the test simulator. The transmitter is operated at its maximum rated output power: 30 dBm (power class 1; power control level 0). The input signal to the receiver is modulated with normal test modulation. The wanted RF input signal level to the receiver of the mobile station is set to a level to provide a stable communication link

\*) EUT operating mode no. is used to simplify the test report.



### 3.6. Additional declaration and description of EUT's

(Applicant's declaration,  = not selected,  = selected)

AE 1		typical operating cycle. <input checked="" type="checkbox"/> < 0,5 sec. <input type="checkbox"/> :	typical use <input type="checkbox"/> portable use <input checked="" type="checkbox"/> fixed use	<input type="checkbox"/> table-top <input type="checkbox"/> floor-standing <input checked="" type="checkbox"/> not defined
Place of use? <input type="checkbox"/> vehicular use		<input checked="" type="checkbox"/> Residential, commercial and light industry <input type="checkbox"/> Industrial environment		
<b>Power line:</b>		EUT-grounding: (in case of deviation during tests the single details are described on chapter 4)		
<input type="checkbox"/> AC Hz	<input type="checkbox"/> L1, <input type="checkbox"/> L2, <input type="checkbox"/> L3, <input type="checkbox"/> N <input type="checkbox"/> 12V, <input type="checkbox"/> 24V, <input type="checkbox"/> 230V, <input type="checkbox"/> 400V	<input checked="" type="checkbox"/> none <input type="checkbox"/> with power supply <input type="checkbox"/> additional:		
<input checked="" type="checkbox"/> DC	<input checked="" type="checkbox"/> 9 V DC			
<b>Other Ports</b>	possible total cable length	shielding	connected during test	
1. DC Power port	<input checked="" type="checkbox"/> > 1m <input type="checkbox"/> > 2m <input type="checkbox"/> > 3m <input type="checkbox"/> :	<input type="checkbox"/> screened <input checked="" type="checkbox"/> unscreened	<input checked="" type="checkbox"/> yes <input type="checkbox"/> no	
2. Handset port (audio)	<input type="checkbox"/> > 1m <input checked="" type="checkbox"/> > 2m <input type="checkbox"/> > 3m <input type="checkbox"/> :	<input type="checkbox"/> screened <input checked="" type="checkbox"/> unscreened	<input checked="" type="checkbox"/> yes <input type="checkbox"/> no	
3. RF antenna port	<input type="checkbox"/> > 1m <input checked="" type="checkbox"/> > 2m <input type="checkbox"/> > 3m <input type="checkbox"/> :	<input checked="" type="checkbox"/> screened <input type="checkbox"/> unscreened	<input checked="" type="checkbox"/> yes <input type="checkbox"/> no	
4. RS 232 port (COM1) (COM2-not used)	<input checked="" type="checkbox"/> > 1m <input type="checkbox"/> > 2m <input type="checkbox"/> > 3m <input type="checkbox"/> :	<input type="checkbox"/> screened <input checked="" type="checkbox"/> unscreened	<input checked="" type="checkbox"/> yes <input type="checkbox"/> no	
Does EUT contain devices susceptible to magnetic fields, e.g. Hall elements, electrodynamics microphones, etc.?			<input type="checkbox"/> yes <input checked="" type="checkbox"/> no	
Is mounting position / usual operating position defined?			<input type="checkbox"/> yes <input checked="" type="checkbox"/> no	

### 3.7. Configuration of cables used for testing

Following cables were connected to the DSB board according manufacturers information: DC-power supply cable, Audio cable and RF cable.

## 4. Measurements Set-ups

### 4.1. Conducted measurements test set-up

The EUT's RF-signal is coupled out by a suitable antenna coupling connector (1). The signal is first 10 dB attenuated (2) before it is 0° divided by a power divider (3). One of the signal path is connected to the communication base station (4), other branch is connected to the spectrum – analyzer (5). The specific attenuation losses for both signal paths/branches are determined prior to the measurement within a set-up calibration. These are then taken into account by correcting the measurement readings on the spectrum-analyzer.

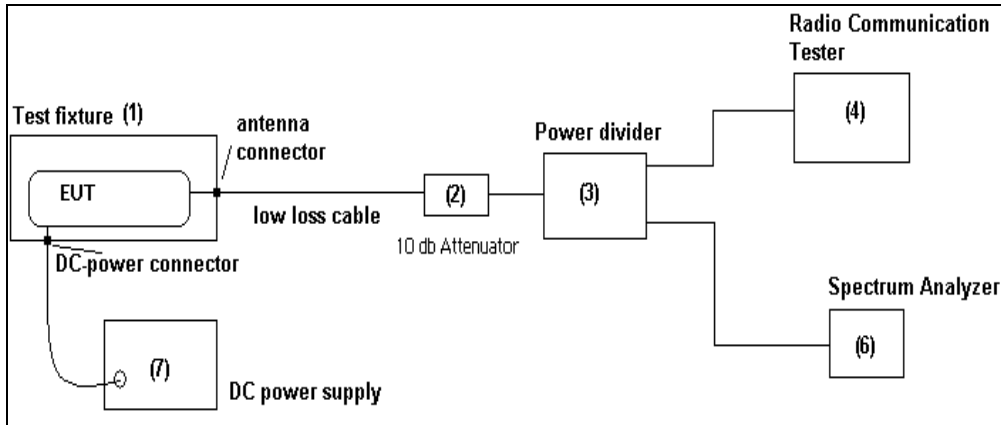

**Schematic: Test set-up conducted**

Following modified test set-up schematic apply for tests performed inside the climatic chamber: (Frequency stability)

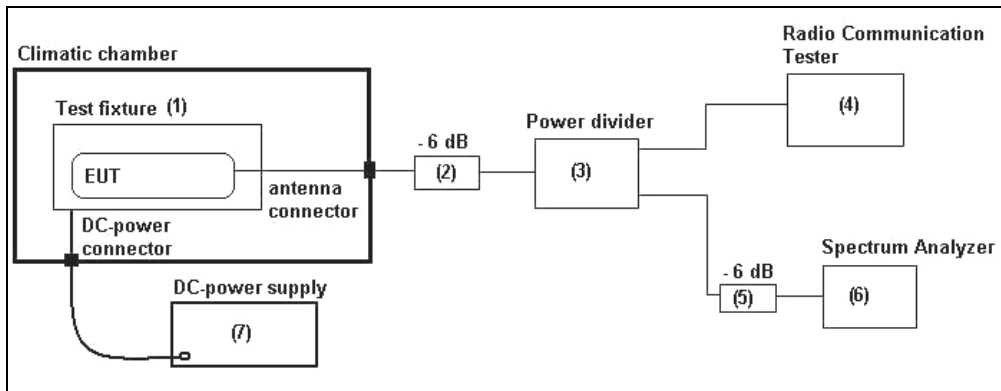

**Schematic: Test set-up conducted within climatic chamber**

## 4.2. Radiated measurements test set-up

The radiated emissions from the test device are measured first as exploratory measurement in a semi or fully anechoic chamber with the dimensions of 12 x 8 x 8 meter. After determining the emissions spectrum from the EUT and connected accessories, the most critical frequencies within a defined range are re-checked on CETECOM's Open Area Test side recognized by the FCC to be compliant with ANSI 63.4: 2001

The EUT and accessories are placed on a non-conducting tipping table of 1 meter height (semi-anechoic chamber) or 1.55m height (fully-anechoic chamber) which is situated in the middle of the turntable. The turntable can rotate the device under test 360 degree, the tipping table can rotate the device from laid to standing position. This way the device under test can be rotated in all three orthogonal planes in order to maximize the detected emissions. The turn- and tipping table are controlled by a controller unit. All positions manipulations are software controlled from a operator PC.

The measurements are performed for both receiving antenna polarisations: vertical and horizontal.

Up to 18GHz a measurement distance of 3 meters is used, above 18GHz the distance is 1meter. A Biconic-Logarithmic antenna up to 1 GHz and a Horn antenna for frequencies greater then 1 GHz are used. (see equipment list)

The EUT is powered either by a external DC-supply with nominal voltage or a AC/DC power supply as accessory. The signalling is performed from outside the chamber with a communication test center (CMU) by airlink.

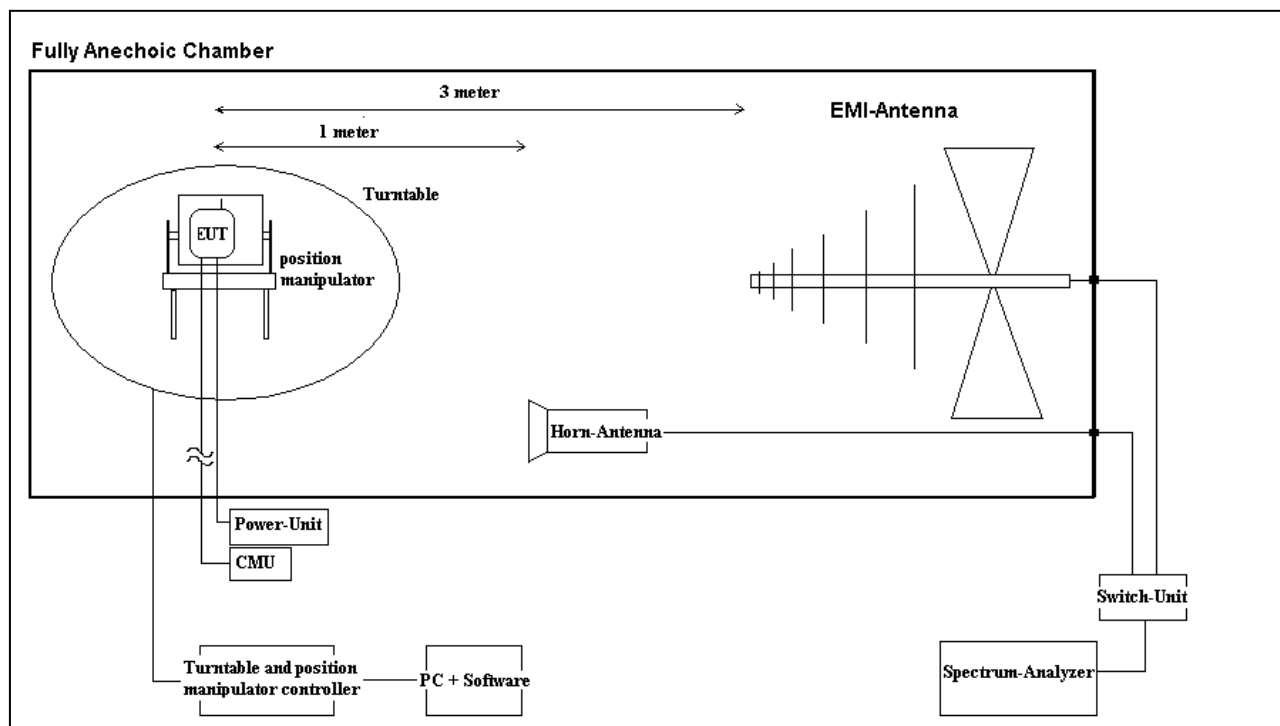

**Schematic: radiated measurements test set-up**

### 4.3. Parameter Settings on mobile phone and base station CMU200

#### Settings for CMU (general)

Parameter	Traffic Mode	Idle Mode
Traffic Channels mobile station	GSM 850: TCH <sub>MS</sub> = 128/192/251 GSM 1900 TCH <sub>MS</sub> = 512/681/810	--
maximum power step (PCL)	GSM 850: PCL = 5 (2 Watt) GSM 1900: PCL = 0 (1 Watt)	--
Modulation	GSM: GMSK-Modulation Scheme	--
DTX	off	--
Bitstream	PRBS 2E9-1 (pseudo-random-sequence) – CCITT 0.153	
Timeslot	3	
Hopping	off	
Timeslot (slot mode)	single	
Maximum data transmission rate, single time slot	GSM: 17,6 kBit/s Slot	
Speech transcoding (Traffic Mode)	Full rate Version 1	
Mode	BCCH and TCH	
BCCH – base station (CMU,CMD)	Channel 182 for GSM 850 Channel 651 for GSM1900	182 651
TCH – base station (CMD, CMU)	auto	
Power level TCH – base station (used timeslot level)	- 70 dBm	
Power level BCCH – base station (control channel level)	- 80 dBm	
External attenuation RF/AF-Input/Output	Accord. calibration prior to measurements	
P/PCL	3 channels	
BS_AG_BLKS_RES	Not applicable	0
Paging reorganisation		Off (0)
Signalling channel		SDCCH
Location Update		Auto
Cell access		Disabled (barred)

#### Additional settings on the base stations CMU200 for frequency stability measurements

Repetition	Continuous	
Stop condition	None	
Display mode	Max./Min	
Statistic Count	1000 Bursts	
Decoder	Standard	

## 5. Measurements and test results

### 5.1. RF power output (Conducted and Radiated)

#### REFERENCES

§2.1046 (conducted), §22.913(a)(2), § 24.232(c)

IC: RSS-132:4.4 + SRSP 503:5.1.3 for GSM 850; RSS-133:6.4 + SRSP-510:5.1.2 for GSM 1900

Maximum Power Output of the mobile phone should be determined while measured conducted and radiated way.

Limit radiated: 33dBm (2 Watt e.i.r.p.)

#### TEST SET-UP (CONDUCTED)

- see conducted measurement set-up, description in chapter 4.1
- a suitable artificial antenna or RF-connector is provided by the applicant in order to perform the conducted measurements. Any data provided with the artificial antenna or connector, have been taken in account in order to correct the measurement data.

#### MOBILE PHONE SETTINGS

- according 4.3

#### BASE STATION SETTING

- according 4.3

#### TEST METHOD

- 1.) The measurements were made at the upper, middle and lower carrier traffic frequencies of the operating band. Choosing three TX-carrier frequencies of the mobile phone within each operable GSM band, should be sufficient to demonstrate compliance.
- 2.) The measurements were performed with the integrated power measurement function of the „radio communication tester CMU“ from Rohde&Schwarz company. In this way spectrum-analyzers instrument limitations can be avoided or minimized. Instead, CMU manufacturers declared measurement error can be considered for this measurement.
- 3.) The attenuation (insertion loss) at the RF Inputs/Outputs of CMU were set according the path loss of the test set-up, determined in a step before starting the measurements.
- 4.) PK and Average Values have been recorded for each channel and band.

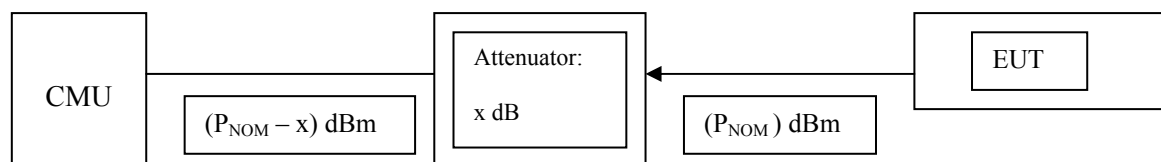

## MEASUREMENT RESULTS (CONDUCTED)

### Op. Mode 2, Set-up 1

Channel/ Frequency (MHz)		Peak Output Power (dBm)	Average Output Power (dBm)
GSM 850	Channel 128/ 824.2 MHz	32,32	32,31
	Channel 192/ 837 MHz	32,46	32,45
	Channel 251/ 848.8 MHz	32,57	32,56

### Op. Mode 4, Set-up 1

Channel/ Frequency (MHz)		Peak Output Power (dBm)	Average Output Power (dBm)
GSM 1900	Channel 512/ 1850.2 MHz	30,11	29,99
	Channel 661/ 1880.0 MHz	29,88	29,77
	Channel 810/ 1909.8 MHz	29,82	29,70

**VERDICT:** passed

## AMBIENT ENVIRONMENTAL CONDITIONS

Temperature	21,7 °C
Relative Humidity	30%
Air pressure	980 hPa

## TEST EQUIPMENT

Used equipment (see reference in the annex)
436 (OTA), 420, 463

## MEASUREMENT RESULTS (RADIATED)

### TEST METHOD

The measurements were made at the upper, center, and lower carrier traffic frequencies of each operable band band. Choosing three TX-carrier frequencies of the mobile phone in each operable band, should be sufficient to demonstrate compliance.

The measurements were performed by using the **substitution method** (ANSI/TIA/EIA 603) with a spectrum-analyzer. This method can be described like follows:

- 1.) choosing of suitable spectrum-analyzer settings for performing the measurements. This settings of the spectrum analyzer must be maintained for both stages of the measurements: EUT emission measurements and also for measurements of the substituted level.

Parameter	Setting
RBW	1 MHz
VBW	10 MHz
Span	10 MHz
Detector Mode	Positive max-hold
Average	off
Sweep Time	coupled

- 2.) The maximum level of the peak power was recorded, while the emissions were maximized by rotating the EUT in three orthogonal axes, which was situated on a non-conductive turntable of 1.55 m height ( $P_{MEAS,1}$ ). This was performed for both measuring antenna polarisations (vertical/horizontal), the maximum of both values is used for further measurements and final substitution ( $P_{MEAS,1,MAX}$ ).
- 3.) As the maximum emission is recorded, the EUT is replaced by a frequency dependant suitable antenna, which is connected to a RF-signal generator, which is transmitting on the determined worst-case frequency as determined in step 2.
- 4.) The RF-signal level of the signal generator is adjusted as long the same worst-case level determined first step is measured at the spectrum analyzer ( $P_{SMHU}=P_{MEAS,1,MAX}$ )
- 5.) Than the RF-signal cable is disconnected from the antenna and connected to a power-level meter. The level is determined ( $P_{MEAS,2}$ ).
- 6.) The final result is calculated by adding the ERP/EIRP gain of the antenna which substitutes the EUT.  

$$P_{EUT,SUBST} = P_{MEAS,2} + G_{Antenna}$$

### RESULTS (RADIATED)

Channel/ Frequency (MHz)		Power value (dBm)		Antenna Polarisation for maximum Power	Verdict
GSM 850	Channel 128/ 824.2 MHz	28.59	ERP-value	H	Passed
	Channel 192/ 837 MHz	31.56			
	Channel 251/ 848.8 MHz	32.02			
GSM 1900	Channel 512/ 1850.2 MHz	29.55	EIRP-value	V	Passed
	Channel 661/ 1880.0 MHz	28.61			
	Channel 810/ 1909.8 MHz	30.82			

Remark: the measured EIRP values are only valid with the GSM antenna (AE 4) as presented by the applicant.

As other antennas are used, the measurement results would give other EIRP values, re-tests are necessary when other antennas are used.

### AMBIENT ENVIRONMENTAL CONDITIONS

Temperature	24,3°C
Relative Humidity	37%
Air pressure	970hPa

### TEST EQUIPMENT

Used equipment (see reference in the annex)
133, 134, 262, 439, 443, 264, 460, Switch Unit FAR

## 5.2. Occupied 99% bandwidth

### REFERENCES

§2.1049; §22.917(a), §24.238(a)  
IC:RSS-Gen:4.6.1

„the **occupied bandwidth** is the frequency bandwidth, such that, below it lower and above it upper frequency limits, the mean powers radiated are each equal to 0.5 percent of the total mean power radiated.

### TEST SET-UP

- see conducted measurement set-up described in 4.1

### MOBILE PHONE SETTINGS

- Provisions with the requirements is based on the fact, that GSM modulation scheme is GMSK Modulation for GSM equipment with a maximum data transmission rate of 17,6 kBit/s per Slot.
- Provisions with the requirements is based on the fact, that EDGE modulation scheme is 8-PSK Modulation for EDGE equipment with a maximum data transmission rate of 69,2 kBit/s per Slot.
- according table 4.3 a call was established

### SETTINGS OF THE SPECTRUM-ANALYSER

Frequency range	RBW (resolution bandwidth)	VBW (video bandwidth)
1 MHz around carrier frequency	1% from applicants stated/measured emission bandwidth	10 times the RBW

### TEST METHOD

The measurements were made at the upper, middle and lower carrier traffic frequencies of the operating band. Choosing three TX-carrier frequencies of the mobile phone within each operable GSM band, should be sufficient to demonstrate compliance

Additionally the emission bandwidth (-26 dBc bandwidth) was recorded for all three channels. The results were taken in order to determine according the §24.238 the measurement resolution bandwidth, which should be approximately 1% of the emission bandwidth.

### DATA RESULTS

#### Set-up 1, Op-Mode 2

Channel/ Frequency (MHz)		Occupied 99% bandwidth [kHz]	Emission bandwidth [kHz]
GSM 850	Channel 128/ 824.2 MHz	243,58	317.30
	Channel 192/ 837 MHz	245.19	314.10
	Channel 251/ 848.8 MHz	243.58	310.89

Remarks: see annex for plots

#### Set-up 1, Op-Mode 2

Channel/ Frequency (MHz)		Occupied 99% bandwidth [kHz]	Emission bandwidth [kHz]
GSM 1900	Channel 512/ 1850.2 MHz	243.58	317.30
	Channel 661/ 1880.0 MHz	246.79	307.69
	Channel 810/ 1909.8 MHz	245.19	312.50

Remarks: see annex for plots



### **AMBIENT ENVIRONMENTAL CONDITIONS**

Temperature	23,2 °C
Relative Humidity	37 %
Air pressure	970 hPa

### **TEST EQUIPMENT**

Used equipment (see reference in the annex)
264, 460, 463, 517, 529, 530

### 5.3. Emission limits radiated (Spurious emission radiated) $f < 30$ MHz

#### REFERENCES

§15.209

IC: RSS-Gen: 4.11, RSS-210: Table 3, RSS-310: Table 4

#### TEST METHOD

The measurement loop antenna was situated in 3m distance to the EUT. Radiated magnetic emission measurements were made with the antenna situated in 1 meter height. The loop antenna was moved in 2-perpendicular axes (antenna vector in direction of EUT and parallel to EUT) in order to maximize the emissions, the EUT itself in over 3-orthogonal axes by a position manipulator.

For the measurements an extrapolation factor was used in order to normalize the measurement data for determining the compliance, given according standard for 300 and 30 meter distance. The extrapolation factors used for this reduced measurement distance reduction can be found in the Annex 2.

**Measurement procedure:** the loop antenna is connected to an EMI-receiver and positioned in a 3 meter distance from the EUT. The interconnecting cables and equipment position were varied in order to maximize the emissions in respect to the limit. The most critical frequencies are recorded by rotating the EUT itself in 3-orthogonal axis.

#### Results

Set-up No.		1								
Operating Mode		2								
Diagram no.	Polarisation	Frequency [MHz]	Receiver readings ( $R_R$ ) [dBuV/m]	Correction factor ( $C_F$ ) [dB]	Corrected value dBuV/m	Limit ( $L_T$ ) [dBuV/m]		Margin (M) [dB]	Verdict	Remarks
						PK	QP			
2.07	Antenna axis in direction of EUT	8.41	--	Annex 2	8.45	29.54	--	21.09	Passed	Channel 128, MAX hold, PK-detector
		18.21	--		20.19	29.54	--	9.35	Passed	
		19.375	--		20.59	29.54	--	8.95	Passed	
2.10	Antenna	--	--		--	--	--		Passed	Channel 192+251, MAX Hold PK detector
2.08	Antenna axis right angle direction of EUT	19.84	--	Annex 2	20.01	29.54	--	9.53	Passed	Channel 128
2.09		--	--			--	--	--	Passed	Channel 192+251, MAX Hold, PK-detector

Remarks: only worst-case diagrams enclosed in the annex

Set-up No.		1								
Operating Mode		4								
Diagram no.	Polarisation	Frequency [MHz]	Receiver readings (R <sub>R</sub> ) [dBuV/m]	Correction factor (C <sub>F</sub> ) [dB]	Corrected value dBuV/m	Limit (L <sub>T</sub> ) [dBuV/m]		Margin (M) [dB]	Verdict	Remarks
						PK	QP			
2.11	Antenna axis in direction of EUT Antenna	See diagram	--	Annex 2	--	--	--	--	Passed	Channel 512+661+810, MAX Hold, PK detector
2.12	Antenna axis right angle direction of EUT	See diagram	--	Annex 2	--	--	--	--	Passed	Channel 512+661+810, MAX Hold, PK detector

Remarks: only worst-case diagrams enclosed in the annex

### EMI-ANALYZER SETTINGS

Span	9 kHz .. 30 MHz
Detector/ Mode	PEAK, max-hold, repetitive scan for exploratory measurements Quasi-Peak, for final measurement at discrete frequencies
RBW/ VBW	200Hz/ 9 kHz (ANSI 63.4)
Sweep-Time	Coupled (calibrated display)

### SUMMARY OF TEST RESULTS

- pls. See diagrams enclosed in the annex 1 of this test report

### TEST EQUIPMENT

Used equipment (see reference in the annex)
030, 323, 377, 441

## 5.4. Emission limits (Spurious emission) $f > 30$ MHz

### REFERENCES

§2.1051-conducted, §2.1053(a)-radiated, §22.917(a)(b); §24.238(a)(b)

IC: RSS-132:4.5.1, RSS-133:6.5.1 - TX-mode

RSS-132:4.6, RSS-133: 6.7(b) – RX-mode

TX:

„the power of emissions shall be attenuated below the transmitter output power (p) by at least least  $43 + 10 \log(P)$  dB“

### FREQUENCY RANGE

The spectrum was scanned from 30 MHz to the 10th harmonic of the highest frequency generated within the equipment. The detector used was Peak.

The specification that all emissions shall be attenuated below the transmitter power (P) by at least  $43 + 10 \log(P)$  dB, translates in the relevant power range of the mobile phone (1 to 0.001 W) to a constant limit of  $-13$  dBm.

### DESCRIPTION OF SET-UP

- see conducted set-up in chapter 4.1
- see radiated set-up in chapter 4.2

### SETTINGS ON MOBILE PHONE

The measurements were made at the upper, middle, and lower carrier frequencies of the operating band. Choosing three representative TX-carrier frequencies of the mobile phone within each operable GSM band, should be sufficient to demonstrate compliance with the emissions limits outside and adjacent to the frequency blocks.

The individual settings were made according chapter 4.3

### TEST METHOD RADIATED:

**Exploratory measurements:** the potential critical frequencies were checked by investigating the EUT for such frequency components as: harmonics, oscillator and others. These measurement were performed outside the anechoic chamber.

**Final measurements within anechoic-chamber:** By rotating the EUT in three orthogonal planes, the emissions were recorded with Peak-Detector and Hold-Max function of the spectrum-analyzer. If the harmonic could not be detected above the noise floor, the ambient level was recorded. Measurement distance is 3m up to 18GHz, 1m from 18 to 20 GHz. The readings on the spectrum analyzer are corrected with annually performed chamber path calibration values (see chapter 7), so the readings shown are equivalent to the  $\lambda/2$  dipole. Critical measurements near the limit are re-measured with a substitution method accord. ANSI/TIA/EIA 603 as described in chapter 5.1

### SETTINGS OF SPECTRUM-ANALYSER

Frequency range	RBW (resolution bandwidth)	VBW (video bandwidth)
<b>BAND-EDGE compliance:</b> 1MHz immediately adjacent to the frequency blocks	1% from applicants stated/measured emission bandwidth	10 times the RBW
More than 1 MHz outside and adjacent the frequency blocks	1 MHz	10 MHz
IC: 30MHz .. 19.5 GHz	Required: 4KHz * Used: 3 kHz	10KHz

Remark: \* correction factor  $10 \log(4\text{kHz}/3\text{kHz})$  used for results

### 5.4.1. MEASUREMENT RESULTS (conducted)

#### 5.4.1.1. GSM TCH 850: Op. Mode 2, Set-up 1

##### Lowest channel: 128

Transmitting channel/ frequency: TX = 824.2 MHz							
Sweep frequency range: [MHz]	Diagram number	Frequency of emission [MHz]	Worst-Level Polarisation	Transducer factor [dB]	Result [dBm]	Limit [dB]	Verdict
Sweep 1	14.01	671.5	--	--	-41.52	-13 dBm	Passed
Sweep 2	14.02	902.5	--	--	-41.10		Passed
Sweep 3	14.03	12197	--	--	-24.85		Passed
Sweep 4 <sup>4.)</sup>	--	823.99	--	--	-24.92		Passed <sup>4.)</sup>

Remark: see diagrams for more details

4.) Band-Block Edge compliance

##### Middle channel = 192

Transmitting channel/ frequency: TX = 837 MHz							
Sweep frequency range: [MHz]	Diagram number	Frequency of emission [MHz]	Worst-Level Polarisation	Transducer factor [dB]	Result [dBm]	Limit [dB]	Verdict
Sweep 1	14.05	668.75	--	--	-41.82	-13 dBm	Passed
Sweep 2	14.06	890.96	--	--	-41.52		Passed
Sweep 3	14.07	3598.6	--	--	-24.49		Passed

Remark: see diagrams for more details

##### Highest channel: 251

Transmitting channel/ frequency: TX = 848.8 MHz							
Sweep frequency range: [MHz]	Diagram number	Frequency of emission [MHz]	Worst-Level Polarisation	Transducer factor [dB]	Result [dBm]	Limit [dB]	Verdict
Sweep 1	14.08	670.19	--	--	-42.35	-13 dBm	Passed
Sweep 2	14.09	894.13	--	--	-41.36		Passed
Sweep 3	14.10	12334	--	--	-25.26		Passed
Sweep 5 <sup>4.)</sup>	--	849.02	--	--	-23.36		Passed <sup>4.)</sup>

Remark: see diagrams for more details

4.) Band-Block Edge compliance

#### 5.4.1.2. GSM 850 IDLE MODE: Op. Mode 1, Set-up 2

##### Middle TCH channel = 192

Transmitting BCCH channel = 182							
Sweep frequency range: [MHz]	Diagram number	Frequency of emission [MHz]	Worst-Level Polarisation	Transducer factor [dB]	Result [dBm]	Limit FCC [dB]	Verdict
Sweep 1	14.23	670.1	--	--	-42.47	-13 dBm	Passed
Sweep 2	14.24	891.83	--	--	-41.51		Passed
Sweep 3	14.25	3560.9	--	--	-25.02		Passed

Remark: see diagrams for more details

2.) Peak from measurement set-up

#### IC : RSS-132-ISSUE 2, CHAPTER 4.6 ( CONDUCTED MEASUREMENTS IN RX-MODE)

##### Middle TCH channel = 192 (Set-up 1, Op. Mode 1)

Transmitting BCCH channel = 182							
Sweep frequency range: [MHz]	Diagram number	Frequency of emission [MHz]	Transducer factor [dB]	Correction factor (RBW:3kHz-> 4kHz)	Result [dBm]	Limit [dBm]	Verdict
Sweep 1 30..1000MHz	08.302	193.22	16.29	+ 1.25 dB	-84,38	-57	Passed
		603.60	17.14		-85.12		
		877.19 <sup>2.)</sup>	--		-55.40 <sup>2.)</sup>		
		979.79	17.25		-81.4		
Sweep 2 1 .. 19.5 GHz	08.303	1859.7	17.19	+ 1.25 dB	-73.99	-54	Passed
		3579.3	18.98		-72.15		
		13392	22.52		-69.25		
		16891	23.02		-67.95		

Remark: see diagrams for more details

2.) Peak from measurement set-up, BCCH carrier of base station

#### 5.4.1.3. GSM 1900 TCH Mode: Op. Mode 4, Set-up 1

##### Lowest channel: 512

Transmitting channel/ frequency: TX = 1850,2 MHz							
Sweep frequency range: [MHz]	Diagram number	Frequency of emission [MHz]	Worst-Level Polarisation	Transducer factor [dB]	Result [dBm]	Limit [dBc]	Verdict
Sweep 1	8.12	669.87	--	--	-38.94	-13 dBm	Passed
Sweep 2	8.13	Noise level	--	--	see diagram		Passed
Sweep 3	14.14	3698.7	--	--	-39.96		Passed
Sweep 4 <sup>4.)</sup>	--	1849.996795	--	--	-25.84		Passed <sup>4.)</sup>

Remark: see diagrams for more details

4.) Band-Block Edge compliance

**Middle channel = 661**

Transmitting channel/ frequency: TX = 1880,0 MHz							
Sweep frequency range: [MHz]	Diagram number	Frequency of emission [MHz]	Worst-Level Polarisation	Transducer factor [dB]	Result [dBm]	Limit [dBc]	Verdict
Sweep 1	14.16	487.17	--	--	-40.53	-13 dBm	Passed
Sweep 2	14.17	2384.6	--	--	-34.87		Passed
Sweep 3	14.18	3753.2	--	--	-41.76		Passed

Remark: see diagrams for more details

**Highest channel: 810**

Transmitting channel/ frequency: TX = 1908,8 MHz							
Sweep frequency range: [MHz]	Diagram number	Frequency of emission [MHz]	Worst-Level Polarisation	Transducer factor [dB]	Result [dBm]	Limit [dBc]	Verdict
Sweep 1	14.19	669.86	--	--	-39.04	-13 dBm	Passed
Sweep 2	14.20	Noise level	--	--	see diagram		Passed
Sweep 3	14.21	3807.7	--	--	-45.82		Passed
Sweep 5 <sup>4.)</sup>	--	1910.016	--	--	-28.19		Passed <sup>4.)</sup>

Remark: see diagrams for more details

4.) Band-Block Edge compliance

**5.4.1.4. GSM 1900 IDLE MODE: Op. Mode 3, Set-up 2****Middle channel = 661**

Transmitting BCCH channel =651							
Sweep frequency range: [MHz]	Diagram number	Frequency of emission [MHz]	Worst-Level Polarisation	Transducer factor [dB]	Result [dBm]	Limit [dBc]	Verdict
Sweep 1	14.26	673.06	--	--	-39.04	-13 dBm	Passed
Sweep 2	14.27	1305.3	--	--	-35.95		Passed
Sweep 5	14.28	3589.7	--	--	-44.70		Passed

Remark: see diagrams for more details

**IC : RSS-133-ISSUE 3, CHAPTER 6.7(B) ( CONDUCTED MEASUREMENTS IN RX-MODE)**
**Middle TCH channel = 661 (Set-up 1, Op. Mode 3)**

Transmitting BCCH channel = 651							
Sweep frequency range: [MHz]	Diagram number	Frequency of emission [MHz]	Transducer factor [dB]	Correction factor (RBW:3kHz-> 4kHz)	Result [dBm]	Limit [dBm]	Verdict
Sweep 1 30..1000MHz	08.300	--	--	+ 1.25 dB	Margin > 20 dB	-57	Passed
Sweep 2 1 .. 19.5 GHz	08.301	1948.7 <sup>2.)</sup> 3520.3 12354 16772.43	18.5 18.55 21.58 23.03		-50.60 <sup>2.)</sup> -71.67 -68.77 -67.19	-54	Passed

Remark: see diagrams for more details

2.) Peak from measurement set-up, BCCH carrier of base station

**AMBIENT ENVIRONMENTAL CONDITIONS**

Temperature	22,4°C
Relative Humidity	29
Air pressure	980 hPa

**TEST EQUIPMENT**

Used equipment (see reference in the annex)
460, 463, 489, 517, 529, 530



## 5.4.2. MEASUREMENT RESULTS (Radiated)

### 5.4.2.1. GSM 850 TX-Mode: Op. Mode 2, Set-up 1

#### Lowest channel: 128

Transmitting channel/ frequency: TX = 824.2 MHz							
Sweep frequency range: [MHz]	Diagram number (H/V)	Frequency of emission [MHz]	Worst-Level Polarisation	Transducer factor [dB]	Result [dBm]	Limit [dB]	Verdict
Sweep 1	8.01/8.02	Noise Level	--	--	See diagrams	-13 dBm	Passed
Sweep 2 <sup>4.)</sup>	8.07/ 8.08	824.0	H	--	-21.37		Passed <sup>4.)</sup>
Sweep 4	8.11a/8.12a	2435.7	H	--	-23.28		Passed
Sweep 5	8.17 8.18	8772 4109	H V	--	-32.3 -40.5		Passed

Remark: see diagrams for more details

4.) Band-Block Edge compliance

#### Middle channel = 192

Transmitting channel/ frequency: TX = 837 MHz							
Sweep frequency range: [MHz]	Diagram number (H/V)	Frequency of emission [MHz]	Worst-Level Polarisation	Transducer factor [dB]	Result [dBm]	Limit [dB]	Verdict
Sweep 1	8.03/ 8.04	Noise level	--	--	See diagrams	-13 dBm	Passed
Sweep 4	8.13a/ 8.14a	2439.1	--	--	-23.01		Passed
Sweep 5	8.19/ 8.20	Noise level	--	--	See diagrams		Passed

Remark: see diagrams for more details

#### Highest channel: 251

Transmitting channel/ frequency: TX = 848.8 MHz							
Sweep frequency range: [MHz]	Diagram number (H/V)	Frequency of emission [MHz]	Worst-Level Polarisation	Transducer factor [dB]	Result [dBm]	Limit [dB]	Verdict
Sweep 1	8.05/ 8.06	Noise level	--	--	See diagrams	-13 dBm	Passed
Sweep 3 <sup>4.)</sup>	8.09/ 8.10	849.02	--	--	-19.84		Passed <sup>4.)</sup>
Sweep 4	8.15a/ 8.16a	2435.7	H	--	-23.28		Passed
Sweep 5	8.21/ 8.22	Noise level	--	--	See diagrams		Passed

Remark: see diagrams for more details

4.) Band-Block Edge compliance

#### 5.4.2.2. GSM 1900 TX-Mode: Op. Mode 4, Set-up 1

##### Lowest channel: 512

Transmitting channel/ frequency: TX = 1850,2 MHz							
Sweep frequency range: [MHz]	Diagram number (H/V)	Frequency of emission [MHz]	Worst-Level Polarisation	Transducer factor [dB]	Result [dBm]	Limit [dB]	Verdict
Sweep 1	8.23/ 8.24	Noise Level	--	--	See diagrams	-13 dBm	Passed
Sweep 2	8.29b/ 8.30b	Noise level	--	--	See diagrams		Passed
Sweep 3 <sup>4.)</sup>	8.35/ 8.36	1850	H	--	-18.66		Passed <sup>4.)</sup>
Sweep 5	8.39/ 8.40	3685	V	--	-37.7		Passed
		5547	H		-43.5		
		7409	V		-37.5		
Sweep 6	8.45/ 8.46	17122	V	--	-27.28	Passed	

Remark: see diagrams for more details

4.) Band-Block Edge compliance

5.) Exploratory measurements show no critical peaks in the area 18GHz..20 GHz -> no tests in anechoic chamber

##### Middle channel = 661

Transmitting channel/ frequency: TX = 1880,0 MHz							
Sweep frequency range: [MHz]	Diagram number (H/V)	Frequency of emission [MHz]	Worst-Level Polarisation	Transducer factor [dB]	Result [dBm]	Limit [dB]	Verdict
Sweep 1	8.25/ 8.26	849.39	H	--	-29.79	-13 dBm	Passed
Sweep 2	8.31b/ 8.32b	Noise level	--	--	see diagrams		Passed
Sweep 5	8.41/ 8.42	3759	V	--	-39.0		Passed
		5639	H		-38.2		
		7519	V		-36.4		
Sweep 6	8.47/ 8.48	17194	H	--	-26.99		Passed
		16930	H		-27.21		

Remark: see diagrams for more details

5.) Exploratory measurements show no critical peaks in the area 18GHz..20 GHz -> no tests in anechoic chamber

##### Highest channel: 810

Transmitting channel/ frequency: TX = 1908,8 MHz							
Sweep frequency range: [MHz]	Diagram number (H/V)	Frequency of emission [MHz]	Worst-Level Polarisation	Transducer factor [dB]	Result [dBm]	Limit [dB]	Verdict
Sweep 1	8.27/ 8.28	Noise level	--	--	See diagrams	-13 dBm	Passed
Sweep 2	8.33b/ 8.34b	2435.7	H	--	-20.31		Passed
Sweep 4 <sup>4.)</sup>	8.37/ 8.38	1910	V	--	-20.08		Passed <sup>4.)</sup>

Sweep 5	8.43/ 8.44	3814 5729 7630 7649	V H V H	--	-38.8 -37.2 -39.0 -39.4	-13 dBm	Passed
Sweep 6	8.49/ 8.50	Noise Level	--	--	See diagrams		Passed

Remark: see diagrams for more details

4.) Band-Block Edge compliance

5.) Exploratory measurements show no critical peaks in the area 18GHz..20 GHz -> no tests in anechoic chamber

#### AMBIENT ENVIRONMENTAL CONDITIONS

Temperature	24,3°C
Relative Humidity	37
Air pressure	978 hPa

#### TEST EQUIPMENT

Used equipment (see reference in the annex)
133, 302, 264, 439, 443, 460, Switch Unit FAR

## 5.5. Frequency stability on temperature and voltage variations

### REFERENCES

§2.1055, §22.355, §24.235

IC: RSS-Gen:4.7, RSS-132:4.3, RSS-133:4.2+6.3

#### §22.355

Table C-1

#### § 24.235

*“The frequency stability shall be sufficient to ensure that the fundamental emission stays within the authorized frequency block”*

#### § 2.1055(d)(2)

*(d) The frequency stability shall be measured with variation of primary supply voltage as follows:*

*(1) Vary primary supply voltage from 85 to 115 percent of the nominal value for other than hand carried battery equipment.*

*(2) For hand carried, battery powered equipment, reduce primary supply voltage to the battery operating end point which shall be specified by the manufacturer.*

### TEST SET-UP

In order to maintain the voltage constant over the time period of the tests, a dummy battery was connected to a laboratory power supply. The power supply voltage was controlled on the input of the power supply terminals of the EUT.

Compare with the conducted measurement test set-up described in chapter 4.1

### MOBILE PHONE SETTINGS

The measurements were made at the upper, middle, and lower carrier frequencies of the operating band. Choosing three representative TX-carrier frequencies of the mobile phone within each operable GSM band, should be sufficient to demonstrate compliance.

- according chapter 4.3

### TEST METHOD

The RF Channel spacing is 200kHz, with a guard band of 200kHz of each band of the sub-bands. The aim of the EUT is to function under all extreme conditions within authorized sub-bands in regard to temperature and voltage variations. The frequency deviation was recorded with base station's built in capability. (CMU)

As for GSM1900 mode the standard requires that the fundamental emissions stays within the authorized band, a limit of 0.1ppm is considered low enough to ensure this.

In GSM850 mode the limit is 2.5ppm.

### Frequency shift of carrier against a voltage range at constant nominal temperature of 20° Celsius

- 1.) determine the carrier frequency for the lowest and highest channel at room temperature and nominal voltage [20°C]
- 2.) The voltage was reduced in 0.1V steps to the lower end point, where the mobile phone stops working. (this shall be specified by the manufacturer) Record the carrier frequency shift within 2 minutes after powering on the mobile phone, to prevent for self heating effects.
- 3.) The voltage was increased in 0.1V steps to the upper declared voltage of the battery. Record the carrier frequency shift within 2 minutes after powering on the mobile phone, to prevent for self heating effects.

### RESULTS

The module's declared voltage range is 3.35 V for Minimum voltage, and 4,789V for Nominal and Maximum Voltage. This can be set by internal switches inside AE1/AE2 according applicant's operating manual.

#### 5.5.0.1. GSM 1900 Mode: Op. Mode 4, set-up 1

##### CHANNEL 512

Voltage [V]	Nominal frequency [MHz]	Maximum Frequency error		Verdict Limit 0.1 ppm
		[Hz]	[ppm]	
3.35 (Minimum)	1850.2	43	0,023	Passed
3.4		32	0,017	
3.5		37	0,020	
3.6		35	0,019	
3.7		45	0,024	
3.8		37	0,020	
3.9		32	0,017	
4.0		32	0,017	
4.1		39	0,021	
4.2		30	0,016	
4.3		28	0,015	
4.36		30	0,016	
4.789 (Nominal, Maximum)		38	0,020	

Remark: --

##### CHANNEL 661

Voltage [V]	Nominal frequency [MHz]	Maximum Frequency error		Verdict Limit 0.1 ppm
		[Hz]	[ppm]	
3.35 (Minimum)	1880	30	0,016	Passed
3.4		33	0,018	
3.5		42	0,022	
3.6		37	0,020	
3.7		38	0,020	
3.8		43	0,023	
3.9		33	0,018	
4.0		39	0,021	
4.1		35	0,019	
4.2		36	0,019	

4.3		46	0,024	
4.36		35	0,019	
4.789 (Nominal, Maximum)		31	0,016	

Remark: --

**CHANNEL 810**

Voltage [V]	Nominal frequency [MHz]	Maximum Frequency error		Verdict Limit 0.1 ppm
		[Hz]	[ppm]	
3.35 (Minimum)	1909.8	35	0,018	Passed
3.4		37	0,019	
3.5		37	0,019	
3.6		37	0,019	
3.7		36	0,019	
3.8		38	0,020	
3.9		34	0,018	
4.0		35	0,018	
4.1		42	0,022	
4.2		35	0,018	
4.3		36	0,019	
4.36		35	0,018	
4.789 (Nominal, Maximum)		39	0,020	

Remark: --

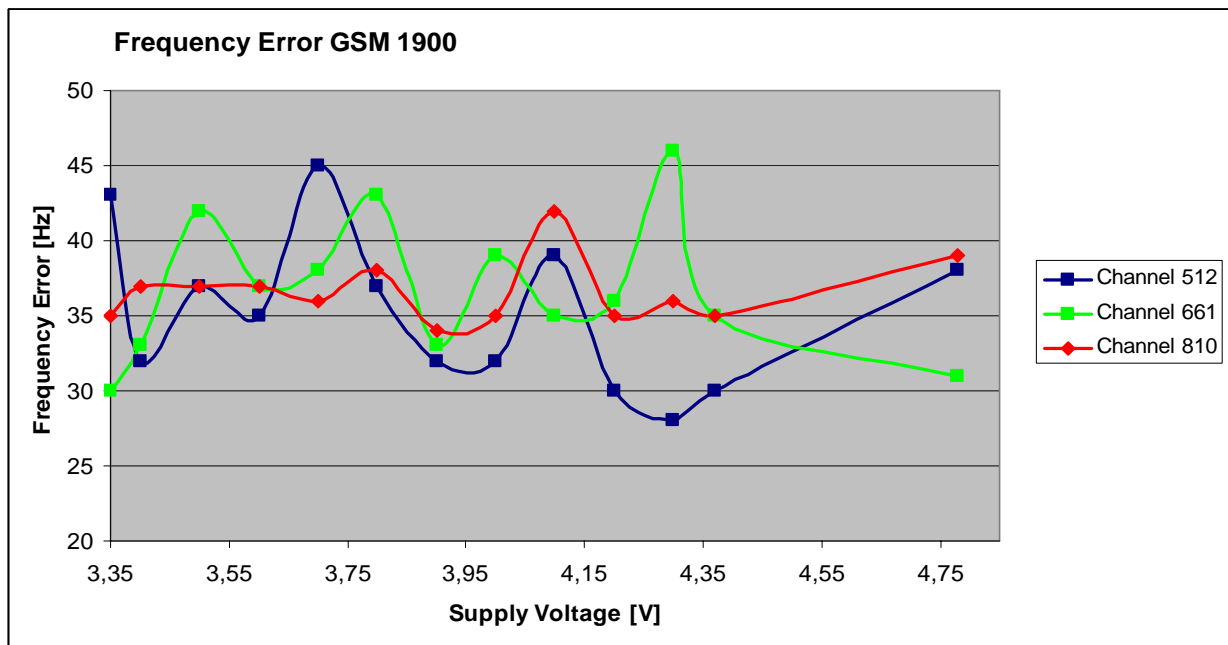

## 5.5.0.2. GSM 850 Mode, Op. Mode 2, set-up 1

**CHANNEL 128**

Voltage [V]	Nominal frequency [MHz]	Maximum Frequency error		Verdict Limit 0.1 ppm
		[Hz]	[ppm]	
3.35 (Minimum)	824.2	18	0,022	Passed
3.4		16	0,019	
3.5		17	0,021	
3.6		18	0,022	
3.7		10	0,012	
3.8		17	0,021	
3.9		19	0,023	
4.0		21	0,025	
4.1		18	0,022	
4.2		18	0,022	
4.3		16	0,019	
4.36		19	0,023	
4.789 (Nominal, Maximum)		17	0,021	

Remark: --

**CHANNEL 192**

Voltage [V]	Nominal frequency [MHz]	Maximum Frequency error		Verdict Limit 0.1 ppm
		[Hz]	[ppm]	
3.35 (Minimum)	837	15	0,018	Passed
3.4		15	0,018	
3.5		18	0,022	
3.6		16	0,019	
3.7		16	0,019	
3.8		18	0,022	
3.9		17	0,020	
4.0		18	0,022	
4.1		20	0,024	
4.2		22	0,026	
4.3		16	0,019	
4.36		17	0,020	
4.789 (Nominal, Maximum)		18	0,022	

Remark: --

**CHANNEL 251**

Voltage [V]	Nominal frequency [MHz]	Maximum Frequency error		Verdict Limit 0.1 ppm
		[Hz]	[ppm]	
3.35 (Minimum)	848.8	15	0,018	Passed
3.4		19	0,022	
3.5		17	0,020	
3.6		23	0,027	
3.7		18	0,021	
3.8		17	0,020	
3.9		17	0,020	
4.0		20	0,024	
4.1		18	0,021	
4.2		21	0,025	
4.3		20	0,024	
4.36		21	0,025	
4.789 (Nominal, Maximum)		19	0,022	

Remark: --

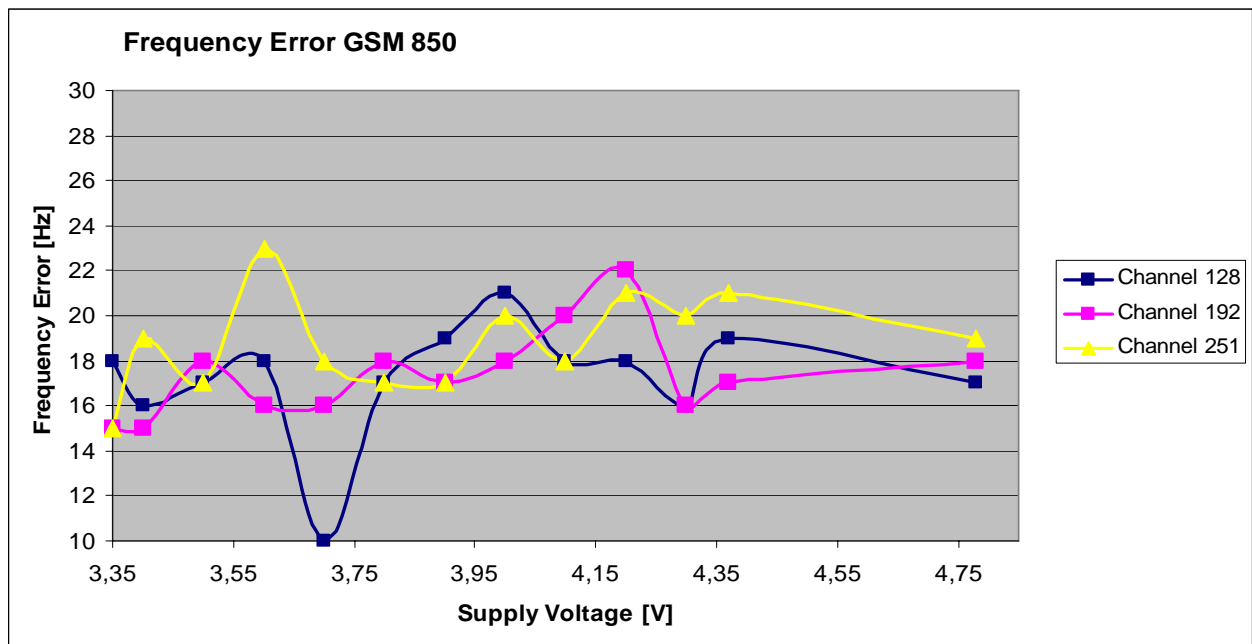

**TEST EQUIPMENT**

Used equipment (see reference in the annex)
298, 331, 354, 460, 463, 517, 529, 530



### Frequency shift of carrier against temperature at constant power supply voltage

- 1.) determine the carrier frequency for the *lowest, middle and highest channel* at room temperature and nominal voltage [20°C]
- 2.) expose the mobile station to -30°C, wait sufficient time to have constant temperature.
- 3.) Perform the carrier frequencies measurements in 10°C increments from -30°C to +60°C. For about half hour at the specified temperature the mobile was powered-off. After powering-on, the measurements were made within 2 minute for the channel lower channel, in order to prevent self-warming of the mobile.

### DATA RESULTS

The used voltage for this test: 4,789V for Nominal and Maximum Voltage. This can be set by internal switches inside AE1/AE2 according applicant's operating manual.

#### 5.5.0.3. GSM 850 Mode: Op. Mode 2, set-up 2

##### Results Channel 128

Temperature [°]	Nominal frequency [MHz]	Maximum Frequency Error			Verdict
		[Hz]	[ppm]	LIMIT	
-30	824.2	32	0,039	±2.5 ppm	Passed
-20		28	0,034		
-10		26	0,032		
0		24	0,029		
10		28	0,034		
20		14	0,017		
30		24	0,029		
40		23	0,028		
50		25	0,030		

Remark:--

##### Results Channel 192

Temperature [°]	Nominal frequency [MHz]	Maximum Frequency Error			Verdict
		[Hz]	[ppm]	LIMIT	
-30	837.0	43	0,051	±2.5 ppm	Passed
-20		28	0,033		
-10		23	0,027		
0		26	0,031		
10		30	0,036		
20		15	0,018		
30		24	0,029		
40		21	0,025		
50		-24	-0,029		

Results Channel 251

Temperature [°]	Nominal frequency [MHz]	Maximum Frequency Error			Verdict
		[Hz]	[ppm]	LIMIT	
-30	848.8	38	0,045	±2.5 ppm	Passed
-20		31	0,037		
-10		29	0,034		
0		25	0,029		
10		29	0,034		
20		17	0,020		
30		25	0,029		
40		25	0,029		
50		-30	-0,035		

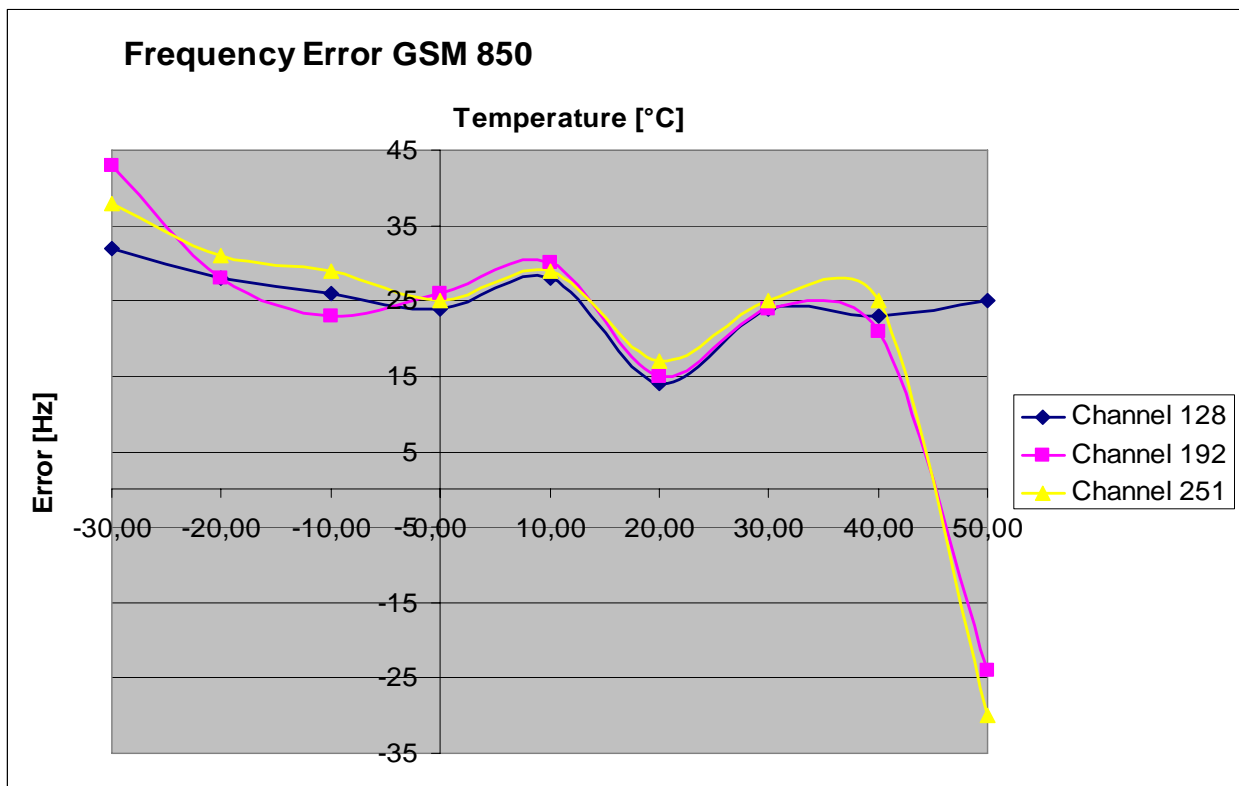

#### 5.5.0.4. GSM 1900 Mode: Op. Mode 4, set-up 1

##### Results Channel 512

Temperature [°]	Nominal frequency [MHz]	Maximum Frequency Error			Verdict
		[Hz]	[ppm]	LIMIT	
-30	1850.2	79	0.043	±0.1 ppm	Passed
-20		55	0.030		
-10		39	0.021		
0		44	0.024		
10		44	0.024		
20		27	0.015		
30		47	0.025		
40		39	0.021		
50		40	0.022		

##### Results Channel 661

Temperature [°]	Nominal frequency [MHz]	Maximum Frequency Error			Verdict
		[Hz]	[ppm]	LIMIT	
-30	1880.0	76	0.040	±0.1 ppm	Passed
-20		51	0.027		
-10		46	0.024		
0		44	0.023		
10		44	0.023		
20		35	0.019		
30		53	0.028		
40		44	0.023		
50		-43	-0.023		

Results Channel 810

Temperature [°]	Nominal frequency [MHz]	Maximum Frequency Error			Verdict
		[Hz]	[ppm]	LIMIT	
-30	1909.8	73	0.038	±0.1 ppm	Passed
-20		56	0.029		
-10		48	0.025		
0		47	0.025		
10		49	0.026		
20		38	0.02		
30		48	0.025		
40		39	0.02		
50		-53	-0.028		

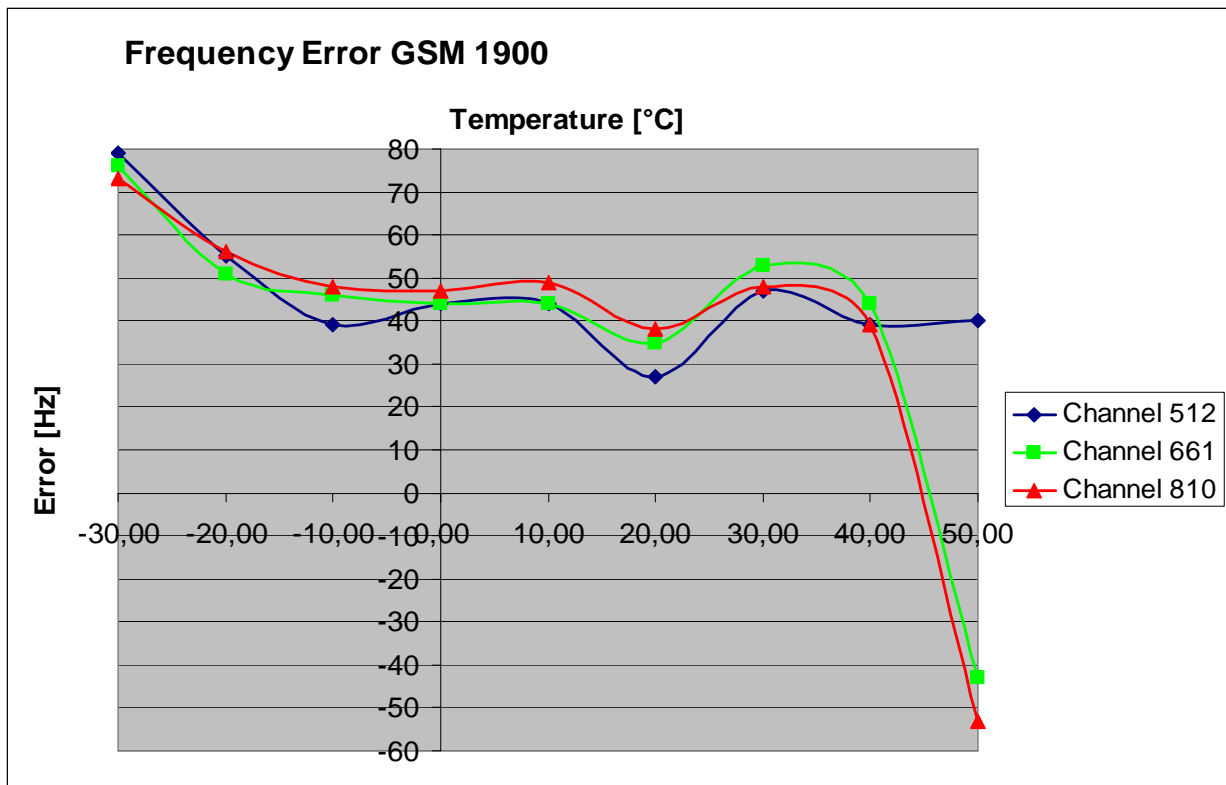

**TEST EQUIPMENT**

Used equipment (see reference in the annex)
298, 331, 354, 460, 463, 517, 529, 530

## 6. Measurement uncertainties

The reported uncertainties are calculated based on the standard uncertainty multiplied with the appropriate coverage factor **k**, such that a confidence level of approximately 95% is achieved.

For uncertainty determination, each component used in the concrete measurement set-up was taken in account and it's contribution to the overall uncertainty according it's statistical distribution calculated.

Following table shows expectable uncertainties for each measurement type performed.

Measurement	Frequency range	Calculated uncertainty based on a confidence level of 95%	Remarks:
RF-Power Output conducted	9 kHz .. 20 GHz	1 dB	--
RF-Power Output radiated	30 MHz .. 4 GHz	3,17 dB	Substitution method
Conducted RF-emissions on antenna ports	9 kHz .. 20 GHz	1 dB	--
Radiated RF-emissions enclosure	150 kHz .. 30 MHz	5 dB	Magnetic field
	30 MHz .. 1 GHz	4,2 dB	E-Field
	1GHz .. 19 GHz	3.17 dB	Substitution method
Occupied bandwidth	9 kHz .. 4 GHz	0,1272 ppm (Delta Marker method)	Frequency error
		1 dB	Power
Emission bandwidth	9 kHz .. 4 GHz	0,1272 ppm (Delta Marker method)	Frequency error
		1 dB	Power
Frequency stability	9 kHz .. 20 GHz	0,0636 ppm	--
Conducted emission on AC-mains port (U <sub>CISPR</sub> )	9 kHz .. 150 kHz	4 dB	--
	150 kHz .. 30 MHz	3.6 dB	

**Table : measurement uncertainties valid for conducted/radiated measurements**

## 7. Calibration method of anechoic chamber

For non-critical frequencies a pre-calibration method was used for determining the relevant radiated field-strength of radiated spurious in the anechoic chamber.

Generally the measured value is influenced by the characteristics of the used cables, filters, antenna, but also by the characteristic of the anechoic chamber.

By defining a **transducer** value, which include all characteristics of the signal propagation path (used equipment, cables, properties of anechoic chamber, etc..) from the source of radiation to the final reading equipment (spectrum-analyzer), the measured value can be corrected in order to get the real value of the device under test.

The method resumes as follows:

- 1.) determination of the path-loss of all cables used on the TX- and RX-side, which are used for the radiated measurement in the specific set-up for 1 meter and 3 meter distance.
- 2.) connection of the cables to the relevant antennas used for calibration.
- 3.) determination of the **space attenuation loss** ( $G$ ) in the anechoic-chamber for both horizontal and vertical antenna polarisations:

A signal generator connected to the TX-antenna sweeps the frequency range of interest (30 MHz to 19.5 GHz) with a level of  $-30\text{dBm}$  - the readings on the RX-side on the spectrum analyzer gives the **space attenuation loss**. The distance between RX- and TX-antenna is 3 meter for frequencies below 1 GHz, and 1 meter for frequencies above 1 GHz.

- 4.) Mathematical determination of the frequency dependant transducer values ( $TD_{H/V}$ ):

$$TD_{H/V} = G_{H/V} + B_{H/V} - 10 \cdot \log_{10}(1,64) + D + E - F$$

### Abbreviations:

$TD_{H/V}$  =  $\lambda/2$  transducer values for horizontal /vertical antenna polarisations

$G_{H/V}$  = space attenuation loss horizontal/ vertical

$B_{H/V}$  = Gain of TX-antenna

$10 \cdot \log_{10}(1,64)$  = Gain in dB of  $\lambda/2$  Dipole relative to isotropic radiator

D = insertion losses of RX cable

E = Loss of filters in signal path (not used for FCC measurements)

F = Gain of pre-amplifiers in signal path

- 5.) The tables below are showing the transducer values for horizontal and vertical polarisation in two reference distances (1 meter and 3 meter). EIRP can be calculated from ERP by adding the gain of the  $\lambda/2$  dipole  $EIRP = ERP + 2.14 \text{ dBi}$
- 6.) Definition of transducer tables which are programmed/ loaded in the spectrum analyzer. The readings on the spectrum-analyzer are automatically corrected by this values and can directly be compared with the limits as given in the relevant standards.

Used equipment for calibration (3 meter distance)

Used equipment (see reference in the annex)

264, 133, 020, 140, 484, 490

Used equipment for calibration (1 meter distance)

Used equipment (see reference in the annex)

302, 303, 264

## 8. Instruments and Ancillary

### 8.1. Used equipment "CTC"

The "Ref.-No" in the left column of the following tables allows the clear identification of the laboratory equipment.

#### 8.1.1. Test software and firmware of equipment

Ref.-No.	Equipment	Type	Serial-No.	Version of Firmware or Software during the test
001	emi test receiver	ESS	825132/017	Firm = 1.16 , OTP=2.0, GRA=2.0
012	signal generator (EMS-cond.)	SMY 01	839069/027	Firm.= V 2.02
013	power meter (EMS cond.)	NRVD	839111/003	Firm.= V 1.51
017	Communication Tester	CMD 60 M	844365/014	Firmware = V 3.52 .22.01.99, DECT Firmware D2.87
053	audio analyzer	UPA3	861215/015	Firm. V 4.3
119	RT harmonics analyser/dig. flickermeter	B10	G60547	Firm.= V 3.1DHG
120	spectrum analyzer	FSEM 30	845538/011	Bios=2.1, Analyzer-Firmware= 3.30.3
138	spectrum analyzer, display unit	FSA-D	863619/003	Firm.= 2.90
139	spectrum analyzer, RF unit	FSBS-RF	863373/003	Firm.= 2.90
140	signal generator	SMHU	831314/006	Firm.= 3.21
261	thermal power sensor	NRV-Z55	825083/0008	EPROM-Datum 02.12.04, SE EE 1 B
262	power meter	NRV-S	825770/0010	Firm = 2.6
263	signal generator	SMP 04	826190/0007	Firm.=3.21
264	spectrum analyzer	FSEK 30	826939/005	Bios=2.1, Analyzer= 3.20
277	Vector-Networkanalyzer	ZVC	831363/0005	Bios= 3.3, Analyzer=3.52
295	Racal Digital Radio Test Set	6103	1572	UNIT Firmware= 4.04, SW-Main=4.04, SW-BBP=1.04,
298	Radio Communication Tester	CMU 200	832221/091	R&S Test Firmware =3.53 /3.54 (current Testsoftw. f.
323	Communication Tester	CMD 55	825878/034	Firm.= 3.52 .22.01.99
331	climatic test chamber -40/+80 Grad	HC 4055	43146	TSI 1.53
335	System-CTC-EMS-Conducted	System EMS Conducted	-	EMS-K1 Immunity Test-Software 1.20SR10
340	Communication Tester	CMD 55	849709/037	Firm = 3.52 .22.01.99
355	power meter	URV 5	891310/027	Firm = 1.31
366	Ultra Compact Simulator	UCS 500 M4	V0531100594	001925 / 3.06a02
377	emi test receiver	ESCS 30	100160	Firm = 2.29, OTP= 02.01, GRA= 02.36
378	broadband RF field monitor	RadiSense III	03D00013SNO-08	Firm = V.03D13
383	signal generator	SME 03	842 828 /034	Firm = 4.61
389	digital multimeter	Keithley 2000	0583926	Firm. = A13 (Mainboard) A02 (Display)
392	Radio Communication Tester	MT8820A	6K00000788	Firm = 4.50 #005, IPL=4.01#001,OS=4.02#001,
420	System CTC CTIA-OTA	System CTC CTIA-OTA	-	EMQuest EMQ-100 Ver. 1.05
436	Radio Communication Tester	CMU 200	103083	R&S Test Firmware =4.30 (current Testsoftw. f. all band
441	System CTC-SAR-EMI	System EMI field (SAR)	-	EMC 32 Version 6.10 .3, ESXS-K1 Version 2.20
442	System CTC-SAR-EMS	System EMS field (SAR)	-	EMS-K1 Immunity-Software 1.20SR10
443	System CTC-FAR-EMI-Spuri	System CTC-FAR-EMI-	-	Spuri 6.4a und Spuri 7.0
444	System CTC FAR-EMS	System EMS-Field (FAR)	-	EMS-K1 Immunity-Software 1.20SR10
460	Radio Communication Tester	CMU 200	108901	R&S Test Firmware Base=4.51/Messsoftware=4.50
489	emi test receiver	ESU40	1000-30	Firmware=3.93, Bios=V5.1-16-3, Specification=01.00
491	ESD Simulator dito	ESD dito	dit0307022	V 2.30
524	Voltage Drop Simulator	VDS 200	0196-16	Software Nr: 000037 Version V4.20a01
526	Burst Generator	EFT 200 A	0496-06	Software Nr. 000034 Version V2.32
527	Micro Pulse Generator	MPG 200 B	0496-05	Software-Nr = 00030 Version V2.43
528	Load Dump Simulator	LD 200B	0496-06	Software-Nr. 000031 Version V2.35a01

#### 8.1.2. Single instruments and test systems

Ref.-No.	Equipment	Type	Serial-No.	Manufacturer	Interval of calibration	Remark	Cal due
001	emi test receiver	ESS	825132/017	Rohde & Schwarz	12 M	-	31.03.2008
005	AC - LISN (50 Ohm/50µH, test site 1)	ESH2-Z5	861741/005	Rohde & Schwarz	12 M	-	31.03.2008
007	DC - LISN (50 Ohm/5µH)	ESH3-Z6	892563/002	Rohde & Schwarz	12 M	-	31.03.2008
009	power meter (EMS-radiated)	NRV	863056/017	Rohde & Schwarz	12 M	-	31.03.2008
012	signal generator (EMS-cond.)	SMY 01	839069/027	Rohde & Schwarz	36 M	-	31.03.2008
013	power meter (EMS cond.)	NRVD	839111/003	Rohde & Schwarz	12 M	-	31.03.2008
014	insertion unit (EMS cond.)	URV5-Z2	838519/029	Rohde & Schwarz	12 M	-	31.03.2008
015	insertion unit (EMS cond.)	URV5-Z4	838570/024	Rohde & Schwarz	12 M	-	31.03.2008
016	line impedance simulating network	Op. 24-D	B6366	Spitzenberger + Spies	36 M	-	31.10.2010
017	Communication Tester	CMD 60 M	844365/014	Rohde & Schwarz	12 M	-	31.03.2008
020	horn antenna 18 GHz (Subst 1)	3115	9107-3699	EMCO	36 M	-	31.03.2010
021	loop antenna (H-Field)	6502	9206-2770	EMCO	36 M	-	31.03.2010
022	audio measurement amplifier	2636C	1537643	Brüel & Kjaer	12 M	-	31.03.2008
024	band pass filter 1 kHz	1625	1814825	Brüel & Kjaer	24 M	2	31.03.2008
030	loop antenna (H-field)	HFH-Z2	879604/026	Rohde & Schwarz	36 M	-	31.03.2009
031	absorbing clamp	MDS-21	863325/015	Rohde & Schwarz	24 M	-	31.03.2009
033	RF-current probe (100kHz-30MHz)	ESH2-Z1	879581/18	Rohde & Schwarz	12 M	-	31.03.2008
034	ESD - generator	ESD 30	ESD 30.0689-04	EM TEST	12 M	-	31.03.2008

Ref.-No.	Equipment	Type	Serial-No.	Manufacturer	Interval of calibration	Remark	Cal due
035	air discharge module	P 18	P 18-0689-04	EM TEST	12 M	-	31.03.2008
036	contact discharge module	P 18	P 18-0392-55	EM TEST	12 M	-	31.03.2008
048	bicon. - log. antenna (SAR)	3143	1108	EMCO	36 M	-	31.10.2008
049	current clamp (injection)	F-120-2	48	FCC	12 M	-	31.03.2008
050	3-ph coupling-decoupling-netw. (Burst)	CDN 300	176	Schaffner	12 M	-	31.03.2008
051	VHF-current probe 20-300 MHz	ESV-Z1	872421	Rohde & Schwarz	12 M	-	31.03.2008
052	notch filter DECT	WRCB 1887,82/1889,55SS	12	Wainwright Industries	12 M	-	31.03.2008
053	audio analyzer	UPA3	861215/015	Rohde & Schwarz	36 M	-	31.03.2008
057	relay-switch-unit (EMS system)	RSU	494440/002	Rohde & Schwarz	-	1a	30.04.2008
058	capacitive clamp (Burst)	IP 4	99	Hafely	-	4	
059	ferrite tube	FGZ 40 X 15 E	4225	Lüthi	36 M	-	31.03.2010
060	power amplifier (DC-2kHz)	PAS 5000	B6363	Spitzenberger + Spies	-	3	
061	ferrite tube	FGZ 40 X 15 E	4250	Lüthi	36 M	-	31.03.2010
063	log.-per. antenna (Subst 1)	3146	860941/007	EMCO	36 M	-	31.10.2010
065	attenuator, (6 dB) 50 Ohm, 250W	AT 50-6-250	521057	BNOS Electronics	12 M	1b	30.04.2008
066	notch filter (WCDMA; FDD1)	WRCT 1900/2200-5/40-	5	Wainwright Instr. GmbH	12 M	-	31.03.2008
067	coupling decoupling-network	CDN801-M2/M3	272	Lüthi	12 M	-	31.03.2008
068	coupling decoupling-network	CDN 801-M5	95226	Lüthi	12 M	-	31.03.2008
069	EM - clamp	EM101	9535159	Lüthi	24 M	-	31.03.2008
070	ferrite tube	FTC101	4199	Lüthi	24 M	-	31.03.2008
071	biconical antenna (Subst 1)	HUF-Z2	863.029/010	Rohde & Schwarz	36 M	-	31.10.2010
072	coupling decoupling-network	CDN801-M2/M3	276	Lüthi	12 M	-	31.03.2008
079	4 wire T-network	EZ-10	862.939 / 011	Rohde & Schwarz	24 M	-	31.03.2009
083	AC - power supply, 0-10 A	EAC/MT 27010	910502096	EURO TEST	pre-m	2	
084	AC - power supply, 0-5 A	ELABO-8-34214	-	ELABO	pre-m	2	
085	AC - power supply, 0-10 A	R250	-	Schunterm.&Benningh.	pre-m	2	
086	DC - power supply, 0 -10 A	LNG 50-10	-	Heinzinger Electronic	pre-m	2	
087	DC - power supply, 0 -5 A	EA-3013 S	-	Elektro Automatik	pre-m	2	
090	Helmholtz coil: 2x10 coils in series	-	-	RWTÜV	pre-m	4	
091	USB-LWL-Converter	OLS-1	007/2006	Ingenieurbüro Scheiba	-	4	
094	artificial head (No.1)	4905	1566990	Brüel & Kjaer	pre-m	2	
095	band pass filter 1 kHz	MS 210R/T2.	2108400	IMD GmbH	24 M	2	31.03.2008
099	passive voltage probe	ESH2-Z3	299.7810.52	Rohde & Schwarz	12 M	-	31.03.2008
100	passive voltage probe	Probe TK 9416	without	Schwarzbeck	12 M	-	31.03.2008
110	USB-LWL-Converter	OLS-1	-	Extreme USB	-	4	
119	RT harmonics analyser/dig. flickermeter	B10	G60547	BOCONSULT	36 M	-	31.03.2010
120	spectrum analyzer	FSEM 30	845538/011	Rohde & Schwarz	12 M	-	31.03.2008
121	notch filter GSM 1900	WRCB 1879,5/1880,5EE	15	Wainwright Industries.	12 M	-	31.03.2008
122	notch filter GSM 1800	WRCB 1747/1748	12	Wainwright Industries	12 M	-	31.03.2008
123	biconical antenna (Subst 2)	HUF-Z2.	860941/007	Rohde & Schwarz	36 M	-	31.03.2010
131	RF-Current Probe	F-52	19	FCC	12 M	-	31.03.2008
132	log.-per. antenna (Subst 2)	HUF-Z3	860862/014	Rohde & Schwarz	36 M	-	31.03.2010
133	horn antenna 18 GHz (Meas 1)	3115	9012-3629	EMCO	36 M	-	31.03.2010
134	horn antenna 18 GHz (Subst 2)	3115	9005-3414	EMCO	12 M	-	31.03.2008
136	adjustable dipole antenna (Dipole 1)	3121C-DB4	9105-0697	EMCO	12 M	-	31.03.2008
137	1000 Hz calibrator 94 dB SPL	4230 94 dB	1 594 698	Brüel & Kjaer	12 M	-	31.03.2008
138	spectrum analyzer, display unit	FSA-D	863619/003	Rohde & Schwarz	12 M	-	31.03.2008
139	spectrum analyzer, RF unit	FSBS-RF	863373/003	Rohde & Schwarz	12 M	-	31.03.2008
140	signal generator	SMHU	831314/006	Rohde & Schwarz	24 M	-	31.03.2008
142	attenuator (6 dB) 2 W, 8 GHz	DGL N	-	Radiall	12 M	1b	30.04.2008
248	attenuator	SMA 6dB 2W	-	Radiall	pre-m	2	
249	attenuator	SMA 10dB 10W	-	Radiall	pre-m	2	
252	attenuator	N 6dB 12W	-	Radiall	pre-m	2	
254	high pass GSM1800/1900/DECT	5HC 2600/12750-1.5KK	23042	Trilithic	12 M	-	31.03.2008
256	attenuator	SMA 3dB 2W	-	Radiall	pre-m	2	
257	hybrid	4031C	04491	Narda	pre-m	2	
260	hybrid coupler	4032C	11342	Narda	pre-m	2	
261	thermal power sensor	NRV-Z55	825083/0008	Rohde & Schwarz	24 M	-	31.03.2008
262	power meter	NRV-S	825770/0010	Rohde & Schwarz	24 M	-	31.03.2008
263	signal generator	SMP 04	826190/0007	Rohde & Schwarz	24 M	-	31.03.2009
264	spectrum analyzer	FSEK 30	826939/005	Rohde & Schwarz	12 M	-	31.03.2008
265	peak power sensor	NRV-Z33, Model 04	840414/009	Rohde & Schwarz	24 M	-	31.03.2008
266	peak power sensor	NRV-Z31, Model 04	843383/016	Rohde & Schwarz	24 M	-	31.03.2008
267	notch filter GSM 850	WRCA 800/960-6EEK	9	Wainwright Industries	12 M	-	31.03.2008
268	AC/DC power supply	EA 3050-A	9823636	pre-m	2		
270	termination	1418 N	BB6935	Weinschel	pre-m	2	
271	termination	1418 N	BE6384	Weinschel	pre-m	2	
272	attenuator (20 dB) 50 W	Model 47	BF6239	Weinschel	pre-m	2	
273	attenuator, (10 dB) 100 W	Model 48	BF9229	Weinschel	pre-m	2	
274	attenuator (10 dB) 50 W	Model 47 (10 dB) 50 W	BG0321	Weinschel	pre-m	2	
275	DC-Block	Model 7003 (N)	C5129	Weinschel	pre-m	2	
276	DC-Block	Model 7006 (SMA)	C7061	Weinschel	pre-m	2	
277	Vector-Networkanalyzer	ZVC	831363/0005	Rohde & Schwarz	12 M	-	31.03.2008
279	power divider	1515 (SMA)	LH855	Weinschel	pre-m	2	
284	coupling decoupling network	CDN 801-M1	1661	Lüthi	12 M	-	31.03.2008
285	coupling decoupling network	CDN 801-S1	1642	Lüthi	12 M	-	31.03.2008
287	pre-amplifier 25MHz - 4GHz	AMF-2D-100M4G-35-10P	379418	Miteq	12 M	-	31.03.2008
289	bicon. - log. antenna (OATS)	CBL 6141	4107	Schaffner Chase	36 M	-	31.10.2010
290	notch filter GSM 900	WRCA 901,9/903,1SS	3RR	Wainwright Industries	12 M	-	31.03.2008
291	high pass filter GSM 850/900	WHJ 2200-4EE	14	Wainwright Industries	12 M	-	31.03.2008
295	Racal Digital Radio Test Set	6103	1572	Racal	24 M	3	31.03.2009
298	Radio Communication Tester	CMU 200	832221/091	Rohde & Schwarz	12 M	-	31.03.2008
299	audio microphone	4134	-	Brüel & Kjaer	pre-m	2	
300	AC LISN (50 Ohm/50µH, 1-phase)	ESH3-Z5	892 239/020	Rohde & Schwarz	12 M	-	31.03.2008
301	attenuator (20 dB) 50W, 18GHz	47-20-33	AW0272	Lucas Weinschel	pre-m	2	



Ref.-No.	Equipment	Type	Serial-No.	Manufacturer	Interval of calibration	Remark	Cal due
302	horn antenna 40 GHz (Meas 1)	BBHA9170	155	Schwarzbeck	24 M	-	31.03.2008
303	horn antenna 40 GHz (Subst 1)	BBHA9170	156	Schwarzbeck	24 M	-	31.03.2008
304	fix dipole antenna 1.6 GHz	EMCO 3125-307	9907-1001	ETS	24 M	-	31.03.2009
305	fix dipole antenna 1.8-2.0 GHz	EMCO 3125-306	9907-1001	ETS	24 M	-	31.03.2009
306	fix dipole antenna 2.45 GHz	EMCO 3125-308	9907-1001	ETS	24 M	-	31.03.2009
307	fix dipole antenna 3 GHz	EMCO 3125-309	9907-1001	ETS	24 M	-	31.03.2009
312	Switch unit	TS-RSP	1000147	R&S	12 M	1f	31.03.2008
317	1000 Hz calibrator 94 dB SPL	4230 94dB	1542286	Brüel & Kjaer	12 M	-	31.03.2008
323	Communication Tester	CMD 55	825878/034	Rohde & Schwarz	12 M	-	31.03.2008
331	climatic test chamber -40/+80 Grad	HC 4055	43146	Heraeus Vötsch	24 M	-	31.10.2008
335	System-CTC-EMS-Conducted	System EMS Conducted	-	Rohde & Schwarz	12 M	5	30.04.2008
337	System CTC OATS	System EMI OATS	-	HD GmbH	12 M	5	30.10.2008
338	pre-amplifier 26GHz	JS4-00102600-38-5P	838697	Miteq	12 M	-	31.03.2008
340	Communication Tester	CMD 55	849709/037	Rohde & Schwarz	12 M	-	31.03.2008
341	digital multimeter	Fluke 112	81650455	Fluke	24 M	-	31.03.2008
342	digital multimeter	Voltcraft M-4660A	IB 255466	Voltcraft	12 M	-	31.03.2008
344	adaptor 150/50 Ohm	150/50	-	Krohne	12 M	-	31.03.2008
345	adaptor 150/50 Ohm	150/50	-	Krohne	12 M	-	31.03.2008
347	laboratory site	radio lab.	-	-	-	3	
348	laboratory site	EMI conducted	-	-	-	3	
349	car battery 12 V	car battery 12 V	without	-	-	3	
350	car battery 12 V	car battery 12 V	without	-	-	3	
354	DC - power supply 40A	NGPE 40/40	448	Rohde & Schwarz	24 M	-	31.03.2008
355	power meter	URV 5	891310/027	Rohde & Schwarz	12 M	-	31.03.2008
356	power sensor	NRV-Z1	882322/014	Rohde & Schwarz	24 M	-	31.03.2008
357	power sensor	NRV-Z1	861761/002	Rohde & Schwarz	24 M	-	31.03.2008
358	Power Amplifier 10 kHz-220MHz	AR75A220M1	15860	Amplifier Research	12 M	1b	30.04.2008
362	TOSM Calibration Kit 50 Ohm	ZV-Z21/ZV-Z11	without	Rohde&Schwarz	12 M	-	31.03.2008
366	Ultra Compact Simulator	UCS 500 M4	V0531100594	EM-Test	12 M	-	31.03.2008
367	audio measurement amplifier	2636	R=316832/001 :	Brüel & Kjaer	12 M	-	31.03.2008
369	insertion unit (SAR-EMS, Ch. A)	URV5-Z2	100301	Rohde & Schwarz	24 M	-	31.03.2008
370	insertion unit (SAR-EMS, Ch. B)	URV5-Z2	100302	Rohde & Schwarz	24 M	-	31.03.2008
374	power amplifier 0.8-3 GHz	60S1G3	306528	Amplifier Research	-	1a	30.04.2008
375	directional coupler	DC7144M1	306498	Amplifier Research	-	1a	30.04.2008
376	horn antenna 6 GHz	BBHA9120 E	BBHA 9120 E 179	Schwarzbeck	12 M	-	31.03.2008
377	emi test receiver	ESCS 30	100160	Rohde & Schwarz	12 M	-	31.03.2008
378	broadband RF field monitor	RadiSense III	03D00013SNO-08	DARE Electronics B.V.	12 M	-	31.03.2008
383	signal generator	SME 03	842 828 /034	Rohde & Schwarz	36 M	-	31.03.2010
386	coupling decoupling network	CDN USB/p	19397	Schaffner	12 M	-	31.03.2008
387	coupling decoupling network	CDN L-801 M2	2051	Lüthi	12 M	-	31.03.2008
388	coupling decoupling network	CDN L-801 T2	1929	Lüthi	12 M	-	31.03.2008
389	digital multimeter	Keithley 2000	0583926	Keithley	24 M	-	31.03.2009
392	Radio Communication Tester	MT8820A	6K00000788	Anritsu	18M	-	31.03.2008
394	power amplifier 80-1000 MHz	BLWA 0810-250/200	045610	Bonn-Elektronik	-	1a	30.04.2008
400	ferrite tube (>15 dB, EN 55022)	FTC 40 X 15 E	5559	Lüthi	12 M	-	31.03.2008
401	ferrite tube (>15 dB, EN 55022)	FTC 40 X 15 E	5560	Lüthi	12 M	-	31.03.2008
411	Test Cable Kit N 50 Ohm (male)	ZV-Z11	100200	R&S / Rosenberger	pre-m	2	
413	Quad-Ridge Horn Antenna	3164-04	00090667	ETS-Lindgren	12 M	1f	31.03.2008
414	Circularly polarized com. Antenna	3102	00033734	EMCO	-	3	
415	Antenna Position Controller	2090	00035634	ETS-Lindgren	-	4	
416	MAPS Positioner	2010	-	ETS-Lindgren	-	4	
420	System CTC CTIA-OTA	System CTC CTIA-OTA	-	ETS-Lindgren/Cetecom	12 M	5	31.03.2008
429	MAPS-Positionier	2015	-	ETS-Lindgren	-	4	
430	Thermo-Hygrometer	H270	54476	Dostmann electronic	24 M	-	30.11.2008
431	Model 7405	Near-Field Probe Set	9305-2457	EMCO	-	4	
432	pre-amplifier 100MHz-26GHz	JS4-00102600-38-5P	1030896	Miteq USA	12 M	-	31.03.2008
436	Radio Communication Tester	CMU 200	103083	Rohde & Schwarz	12 M	-	31.03.2008
439	UltraLog-Antenna	HL 562	100248	Rohde + Schwarz	36 M	-	31.03.2008
440	CDN for Datacable	CDN-UTP	CDN-UTP 029	EMC Partner AG,	24 M	-	31.03.2008
441	System CTC-SAR-EMI	System EMI field (SAR)	-	ETS	12 M	5	31.12.2007
443	System CTC-FAR-EMI-Spuri	System CTC-FAR-EMI-	-	ETS-Lindgren/Cetecom	12 M	5	30.04.2008
444	System CTC FAR-EMS	System EMS-Field (FAR)	-	ETS Lindgren/Cetecom	12 M	5	30.04.2008
448	notch filter WCDMA FDD II	WRCT 1850.0/2170.0-	5	Wainwright Instruments	12 M	1c	31.03.2008
449	notch filter WCDMA FDD V	WRCT 824.0/894.0-5/40-	1	Wainwright Instruments	12 M	1c	31.03.2008
454	Oscilloscope	HM 205-3	9210 P 29661	Hameg	-	4	
455	Oscilloscope	HP 54602B	US 350 336 45	Hawlett Packard	-	4	
456	DC-Power supply 0-5A	EA 3013 S	207810	Elektro Automatik	pre-m	2	
457	DC-Power supply, 0-5A	EA-3013 S	9624680	Elektro Automatik	pre-m	2	
459	DC -power supply 0-5 A , 0-32 V	EA-PS 2032-50	910722	Elektro Automatik	pre-m	2	
460	Radio Communication Tester	CMU 200	108901	Rohde & Schwarz	12 M	-	31.03.2008
462	AF-Generator	MX-2020	-	Conrad	-	4	
463	Universal source	HP3245A	2831A03472	Agilent	-	4	
464	Thermo-Hygro-Monitor	WS-9400	without	Europe Supplies Ltd.	24 M	-	30.11.2008
465	Thermo-Hygro-Monitor	WS-9400	without	Europe Supplies Ltd.	24 M	-	30.11.2008
466	digital multimeter	Fluke 112	89210157	Fluke Corporation USA	24 M	-	31.03.2008
467	digital multimeter	Fluke 112	89680306	Fluke Corporation USA	24 M	-	31.03.2008
468	digital multimeter	Fluke 112	90090455	Fluke Corporation USA	24 M	-	31.03.2008
470	Thermo-Hygro-Monitor	WS-9400	-	distr. by Conrad	24 M	-	30.11.2008
474	EWR-Bandpass 1KHz ( 3 bandwidth)	MS210R/T2	2610102	IMD GmbH	12 M	2	31.10.2007
476	Spectrum Analyzer	FSM	840500/004	Rohde & Schwarz	24 M	-	31.03.2009
477	ReRadiating GPS-System	AS-47	-	Automotive Consulting	-	3	
482	filtermatrix	FilterMatrix SAR 1	-	CETECOM (Brl)	-	1d	
484	pre-amplifier 2,5 - 18 GHz	AMF-5D-02501800-25-	1244554	Miteq	12 M	-	31.03.2008
487	NSA-Verification of CTC-SAR-EMI	System EMI field (SAR)	-	ETS	12 M	-	31.10.2008
489	emi test receiver	ESU40	1000-30	Rohde & Schwarz	12 M	-	31.03.2008

Ref.-No.	Equipment	Type	Serial-No.	Manufacturer	Interval of calibration	Remark	Cal due
490	high pass 2,65 GHz>18GHz	6HC 2650/18000-3-KK	200709138	Trilithic	12 M	-	31.03.2008
491	ESD Simulator dito	ESD dito	dito307022	EM-Test	24 M	-	31.03.2009
494	power supply (GPIB)	Agilent 66332A	US 37474017	Agilent	24 M	-	31.03.2009
498	Power Supply	NGPE 40/40	402	Rohde & Schwarz	-	2	
500	industry Acoustic System	MO 2000 Set	100048	Sennheiser	-	4	
502	band reject filter	WRCG 1709/1786-	SN 9	Wainwright	-	-	
503	band reject filter	WRCG 824/849-814/859-	SN 5	Wainwright	-	-	
517	relais swite matrix	HF Relais Box Keithley	SE 04	-	-	-	
522	electronical load	EL 9000	-	ELV	-	-	
523	Digitalmultimeter	L4411A	MY46000154	Agilent	24 M	-	31.03.2009
524	Voltage Drop Simulator	VDS 200	0196-16	EM Test	18 M	-	31.03.2009
525	Koppelnetzwerk	CNA 200	1196-01	EM Test	18 M	-	31.03.2009
526	Burst Generator	EFT 200 A	0496-06	EM Test	18 M	-	31.03.2009
527	Micro Pulse Generator	MPG 200 B	0496-05	EM Test	18 M	-	31.03.2009
528	Load Dump Simulator	LD 200B	0496-06	EM Test	18 M	-	31.03.2009
529	6 dB Broadband resistive power divider	Model 1515	LH 855	Weinschel	-	2	
530	10 dB Broadband resistive power divider	R 416110000	LOT 9828	-	2		

### 8.1.3. Legend

Note / remarks		Calibrated during system calibration:
	1a	System CTC-SAR-EMS (Ref.-No. 442)
	1b	System-CTC-EMS-Conducted (Ref.-No. 335)
	1c	System CTC-FAR-EMI-spurious emission (Ref.-No. 443)
	1d	System CTC-SAR-EMI (Ref.-No. 441)
	1e	System CTC-OATS (EMI radiated) (Ref.-No. 337)
	1 f	System CTC-CTIA-OTA (Ref.-No. 420)
	1 g	System CTC-FAR-EMS (Ref.-No. 444)
	2	calibration or equipment check immediately before measurement
	3	Regulatory maintained equipment for functional check or support purpose, calibration of this equipment has no effect on measuring result
	4	Ancillary equipment without calibration e.g. mechanical equipment or monitoring equipment
	5	Test System

Interval of calibration	12 M	12 month
	24 M	24 month
	36 M	36 month
	Pre-m	check before starting the measurement
	-	without calibration

## 9. ANNEX 1: Diagrams of the measurements

### 9.1. EMISSION BANDWIDTH

#### 9.1.1. GSM 850 Mode

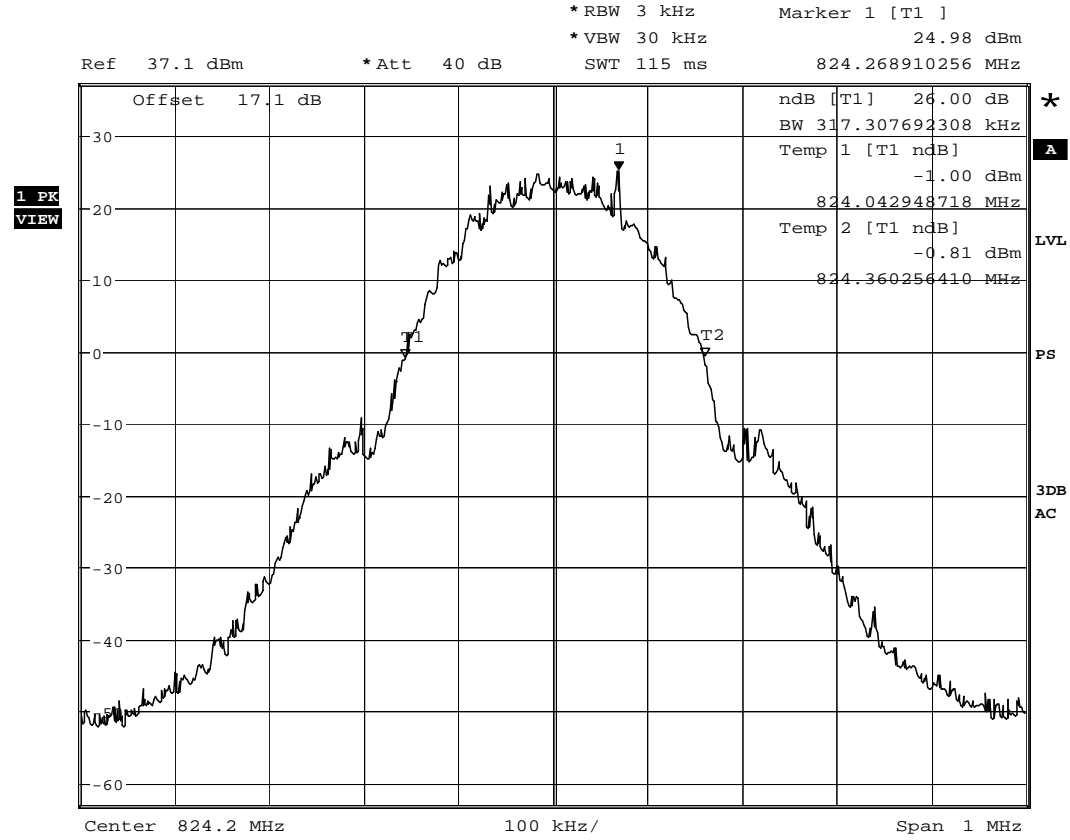

Date: 26.NOV.2007 16:16:13

Channel 128

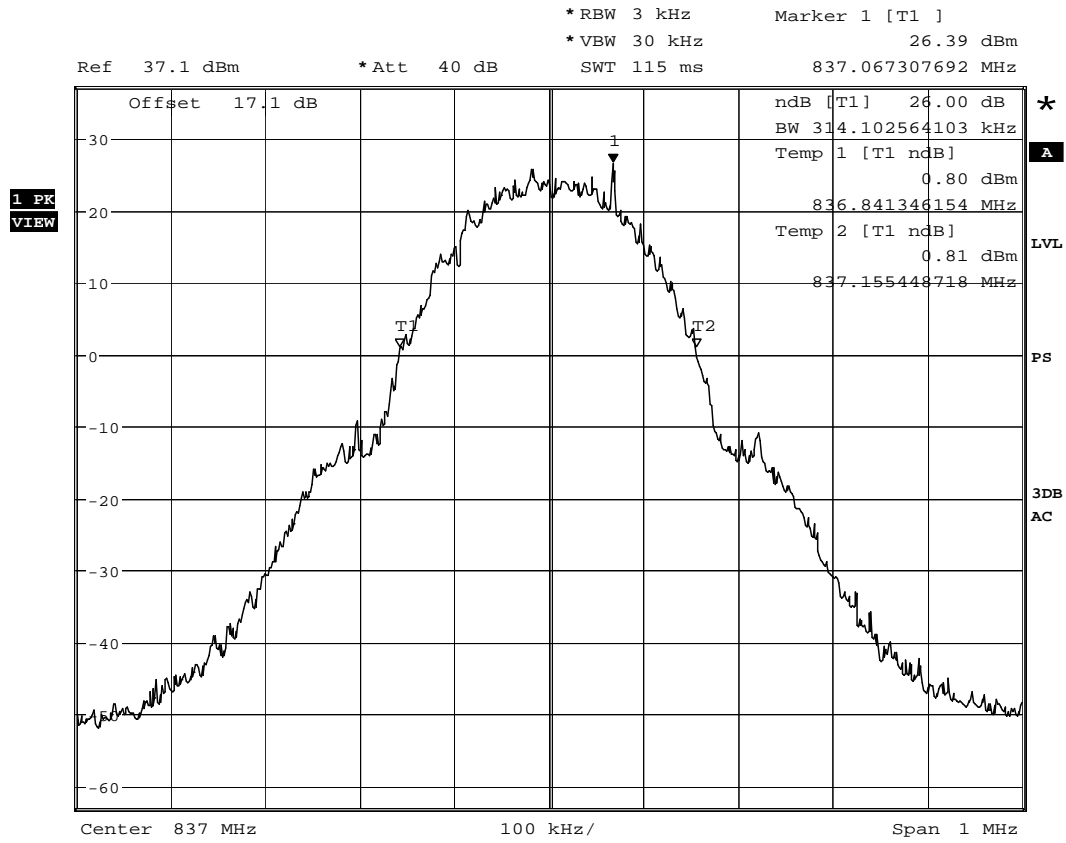

Date: 26.NOV.2007 16:12:49

**Channel 192**

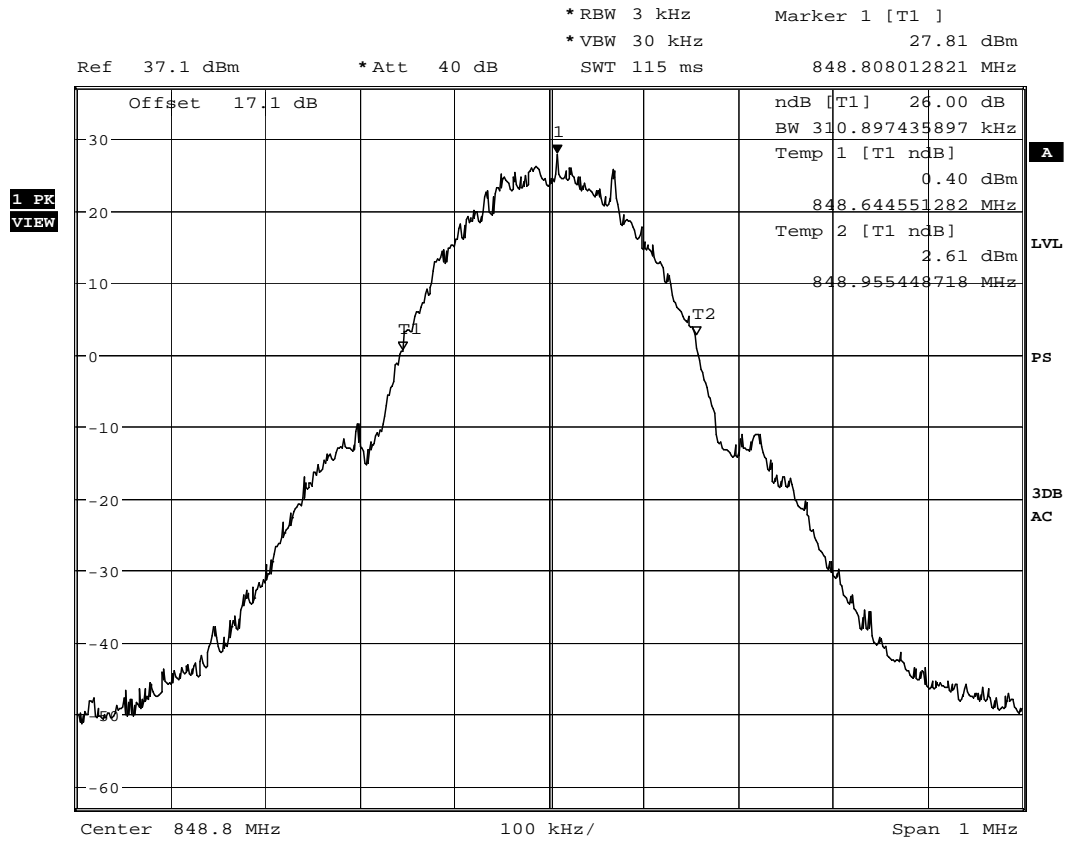

Date: 26.NOV.2007 16:10:00

**Channel 251**

9.1.2. GSM 1900 Mode

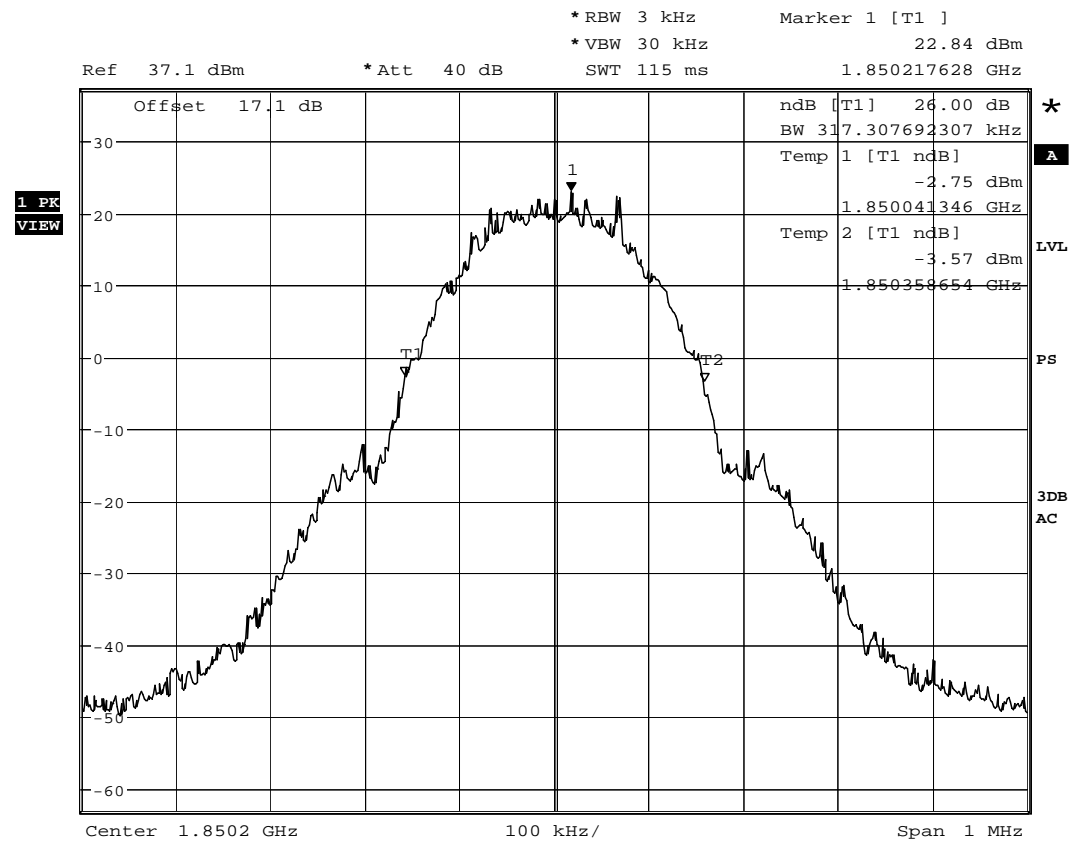

Date: 26.NOV.2007 15:26:07

Channel 512

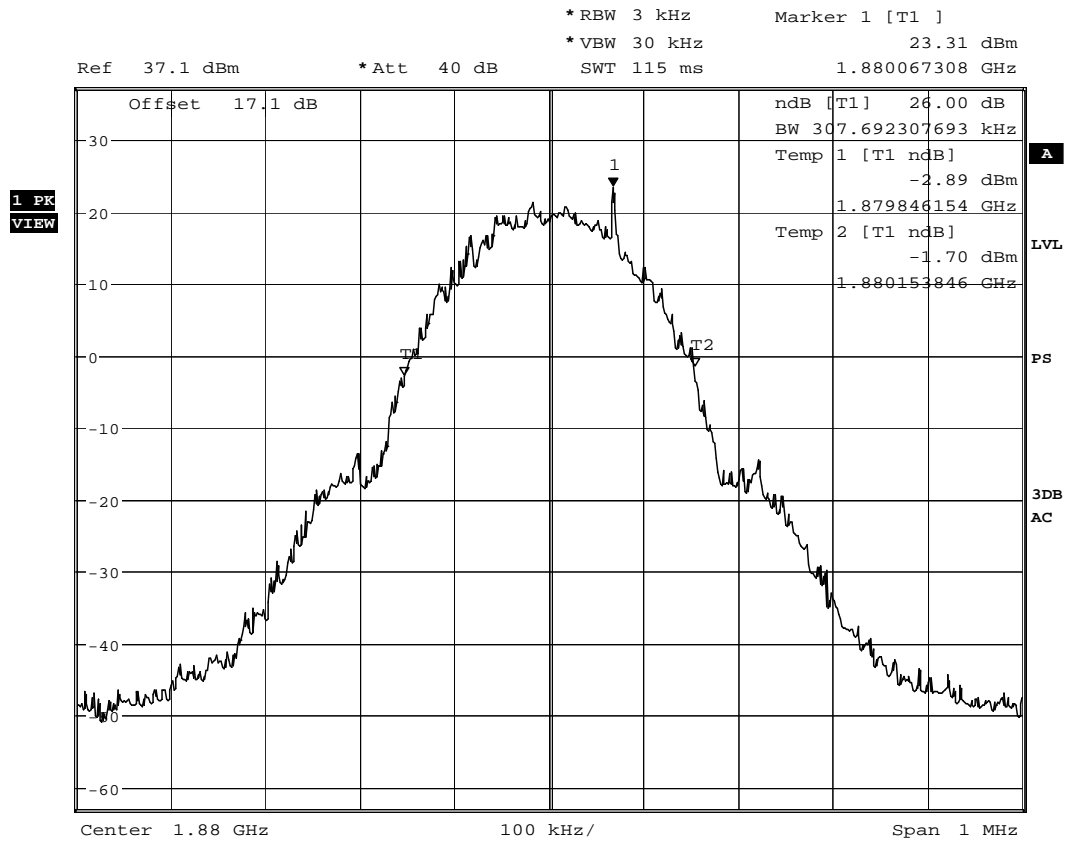

Date: 26.NOV.2007 15:23:45

**Channel 661**

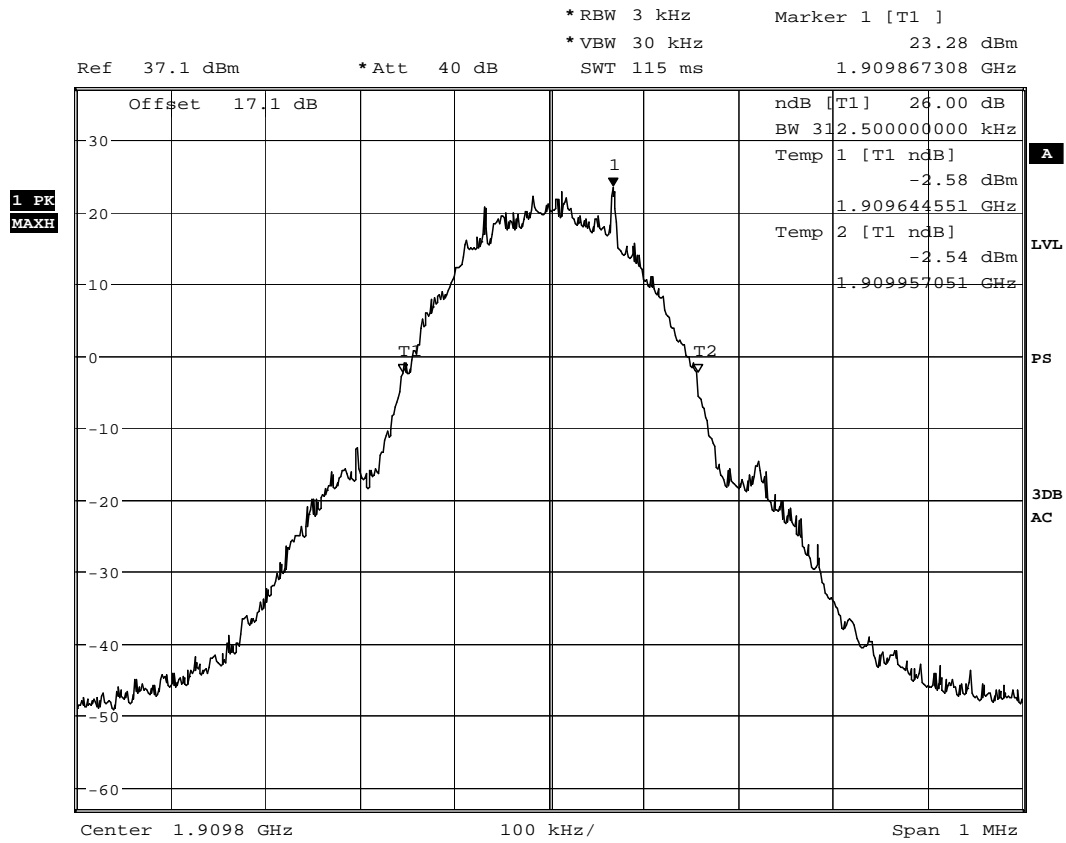

Date: 26.NOV.2007 15:21:54

**Channel 810**



## 9.2. OCCUPIED 99% BANDWIDTH

### 9.2.1. GSM 850 Mode

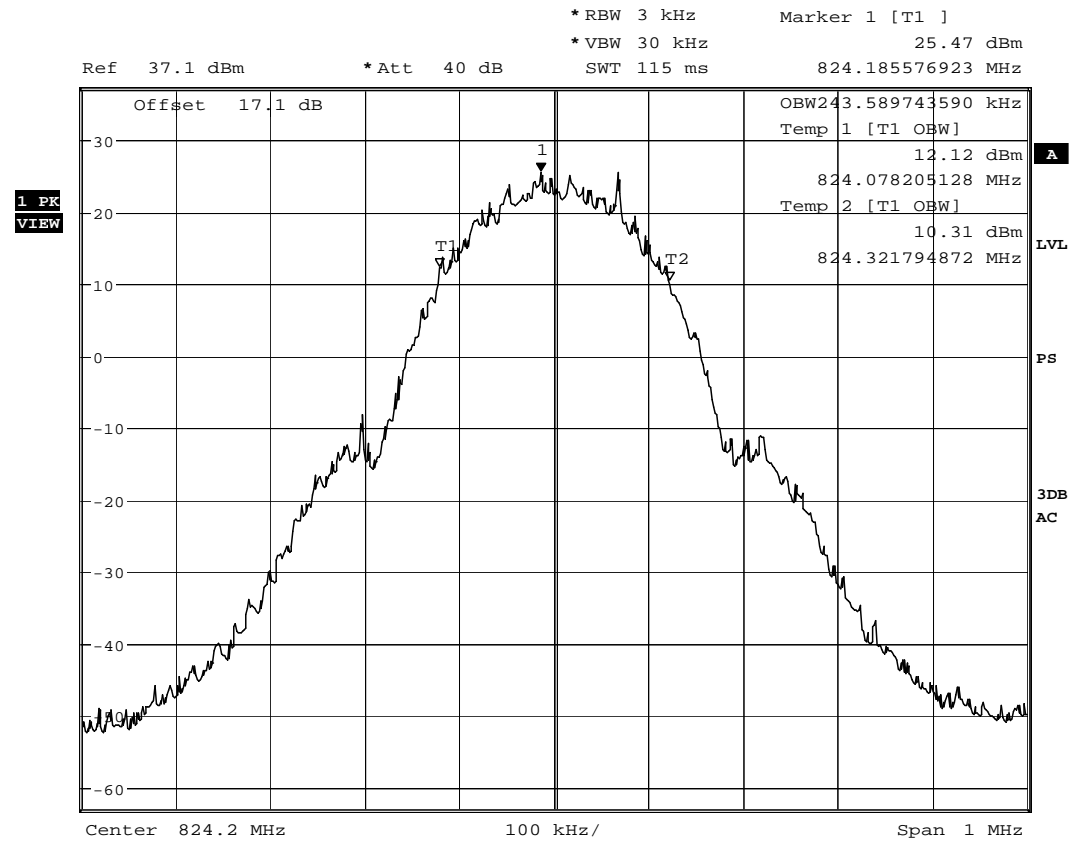

Date: 26.NOV.2007 15:58:40

**Channel 128**

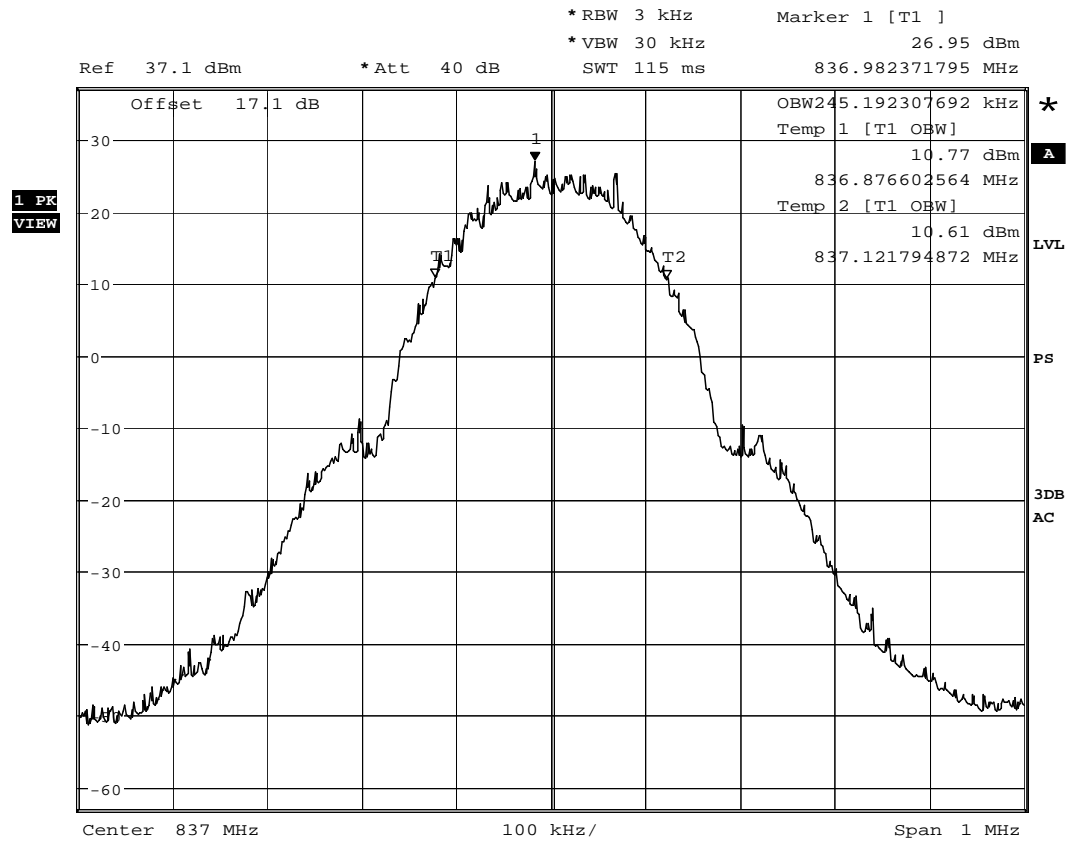

Date: 26.NOV.2007 16:02:41

**Channel 192**

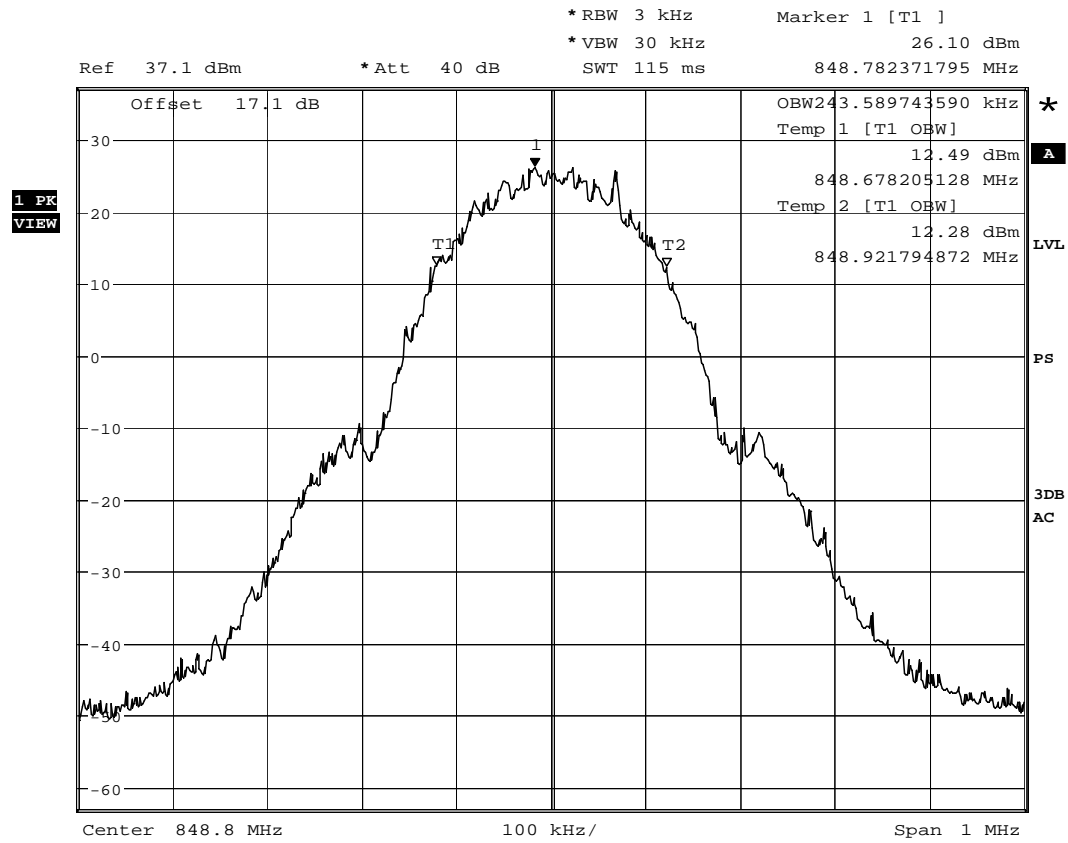

Date: 26.NOV.2007 16:05:56

**Channel 251**

### 9.2.2. GSM 1900 Mode

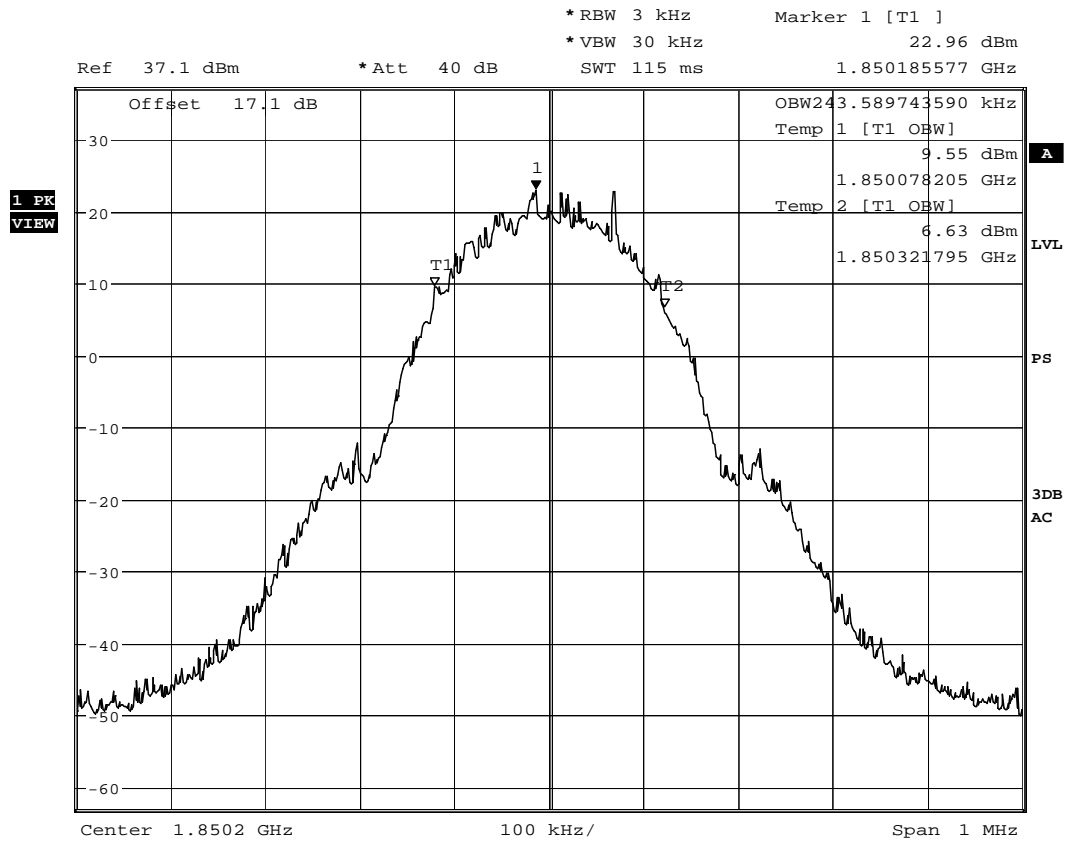

Date: 26.NOV.2007 15:28:38

**Channel 512**

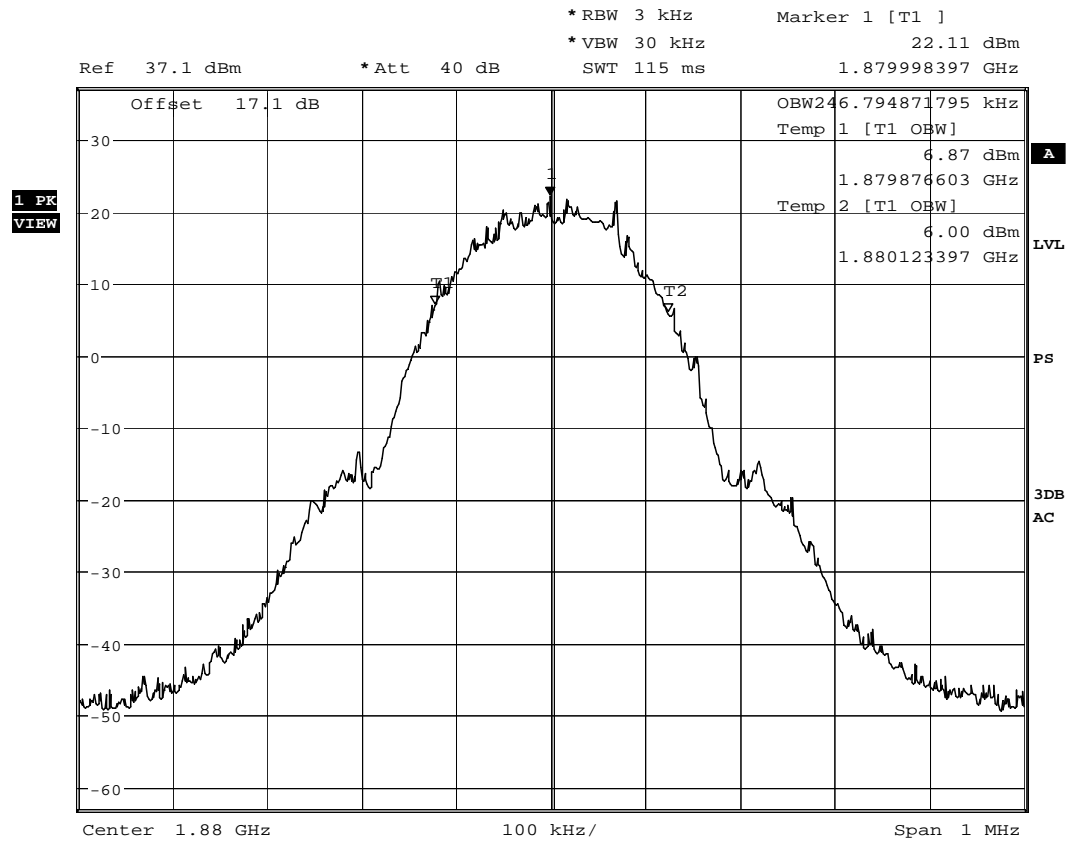

Date: 26.NOV.2007 15:35:59

**Channel 661**

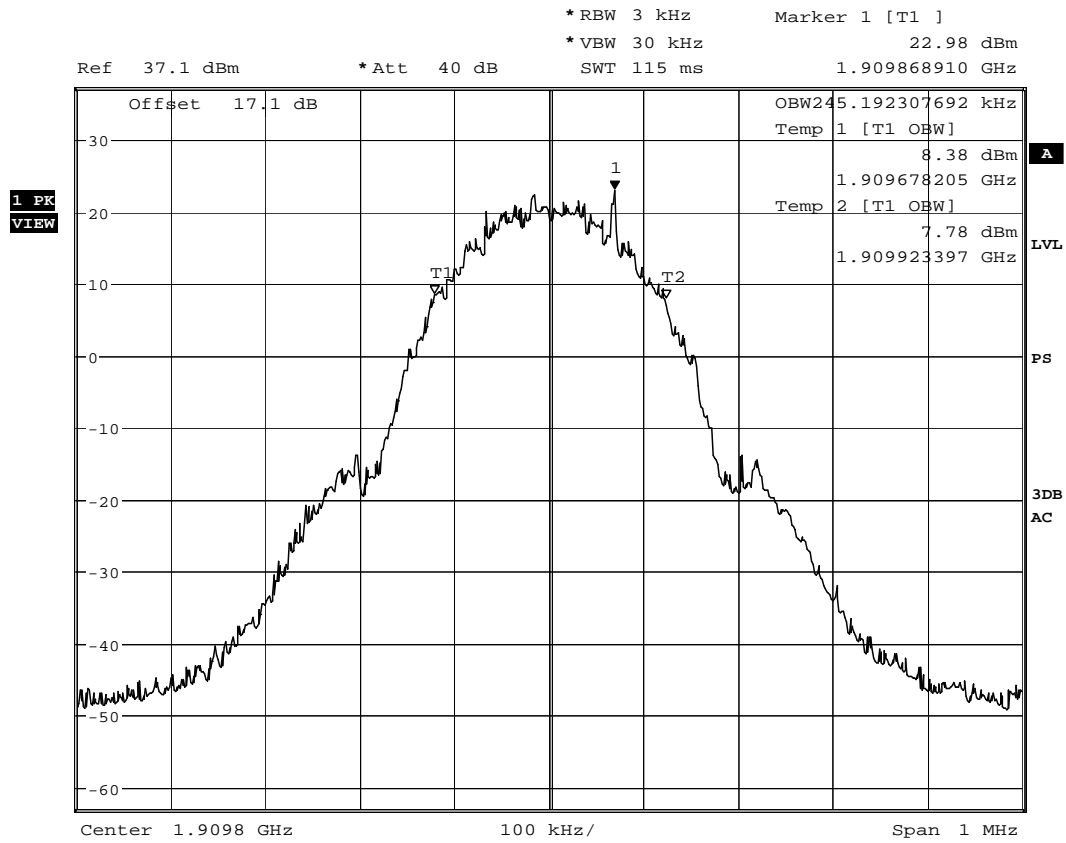

Date: 26.NOV.2007 15:38:51

**Channel 810**

## 9.3. SPURIOUS EMISSIONS CONDUCTED

### 9.3.1. GSM 850 MODE

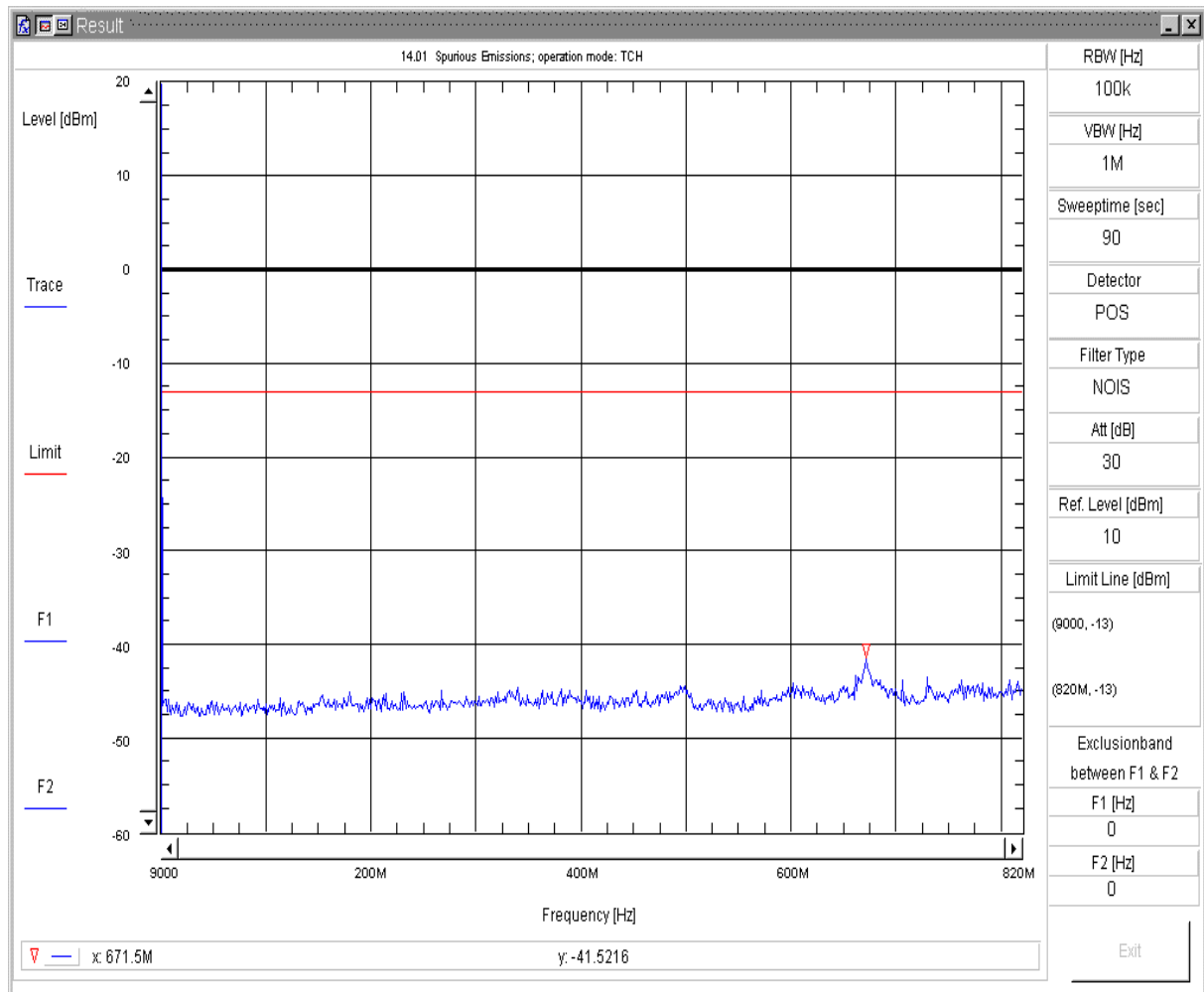

14.01 Conducted Spurious Emission

Transducer: c:\vee\_user\spuri\_V7\conducted\FCC\_Part\_22\_850\TD\_TX  
 Sweepnr: Sweep1  
 EUT OP Mode: FCC\_Part\_22\_850 TCH  
 UE Power: 25.1 dBm / 25.1 dBm  
 UE Status: Connection established (observed by operator)  
 EUT Description: MC55i + Board  
 EUT Hardware:  
 EUT Software: Rev. 00.303  
 EUT Config: C03  
 EUT S/N:  
 Battery: Power Supply (internal); Nominal Voltage; 4.8 VDC  
 Remark: Channel 128  
 Operator: x\_Hol  
 Testing Site: Radio Laboratory; CETECOM Essen

Tue 27/Nov/2007 21:57:050

Conducted Spurious Emissions V7.1.5

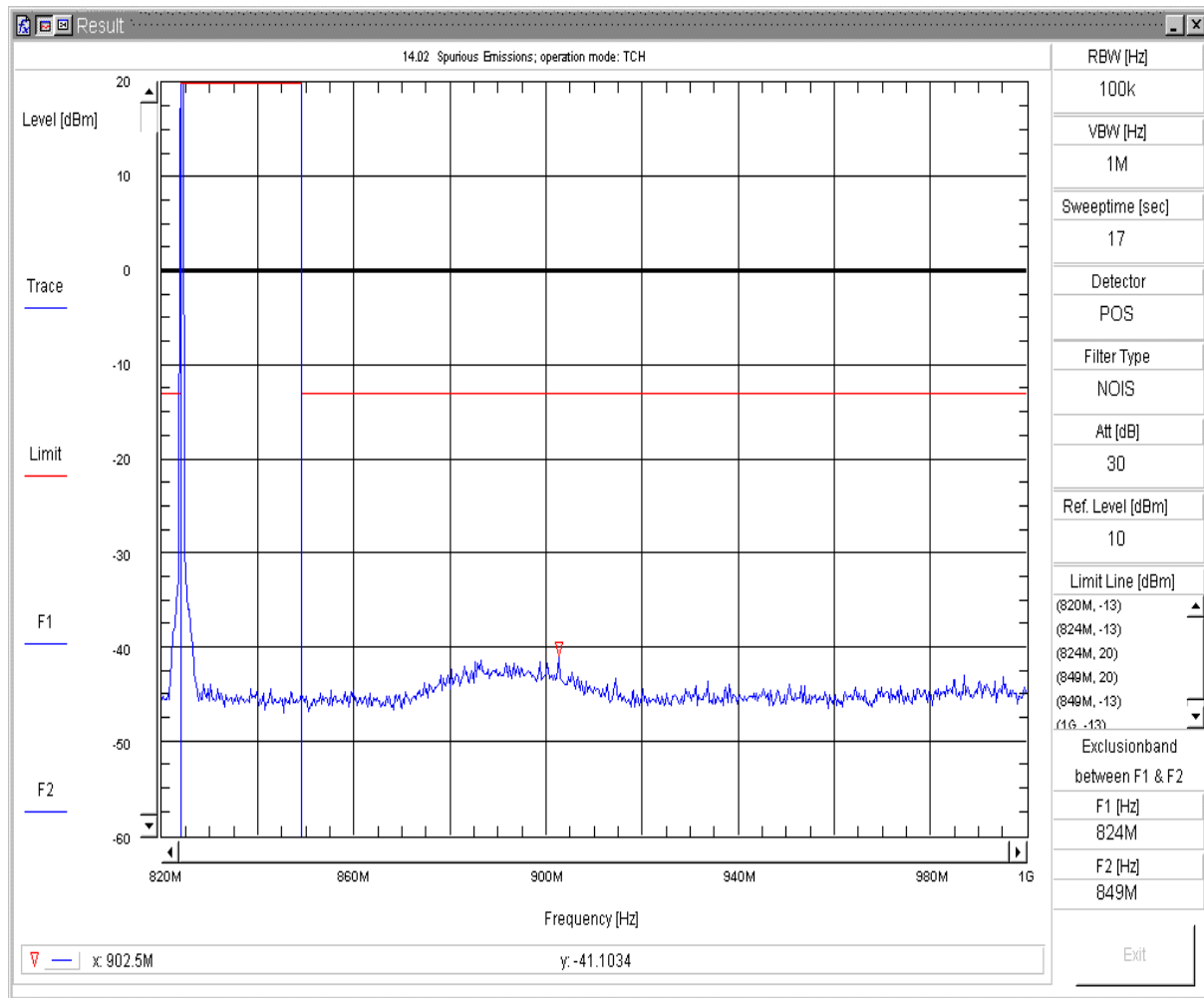

14.02 Conducted Spurious Emission

Transducer: c:\vee\_user\spuri\_V7\conducted\FCC\_Part\_22\_850\TD\_TX  
 Sweepnr: Sweep2  
 EUT OP Mode: FCC\_Part\_22\_850 TCH  
 UE Power: 31.4 dBm / 31.4 dBm  
 UE Status: Connection established (observed by operator)  
 EUT Description: MC55i  
 EUT Hardware: B2.1  
 EUT Software: Rev 00.303  
 EUT Config: C03  
 EUT S/N: IMEI 004401080149475  
 Battery: Power Supply (external); Maximum Voltage; 4.8 VDC  
 Remark: -  
 Operator: LOR  
 Testing Site: Radio Laboratory; CETECOM Essen

Mon 26/Nov/2007 13:02:490

Conducted Spurious Emissions V7.1.5



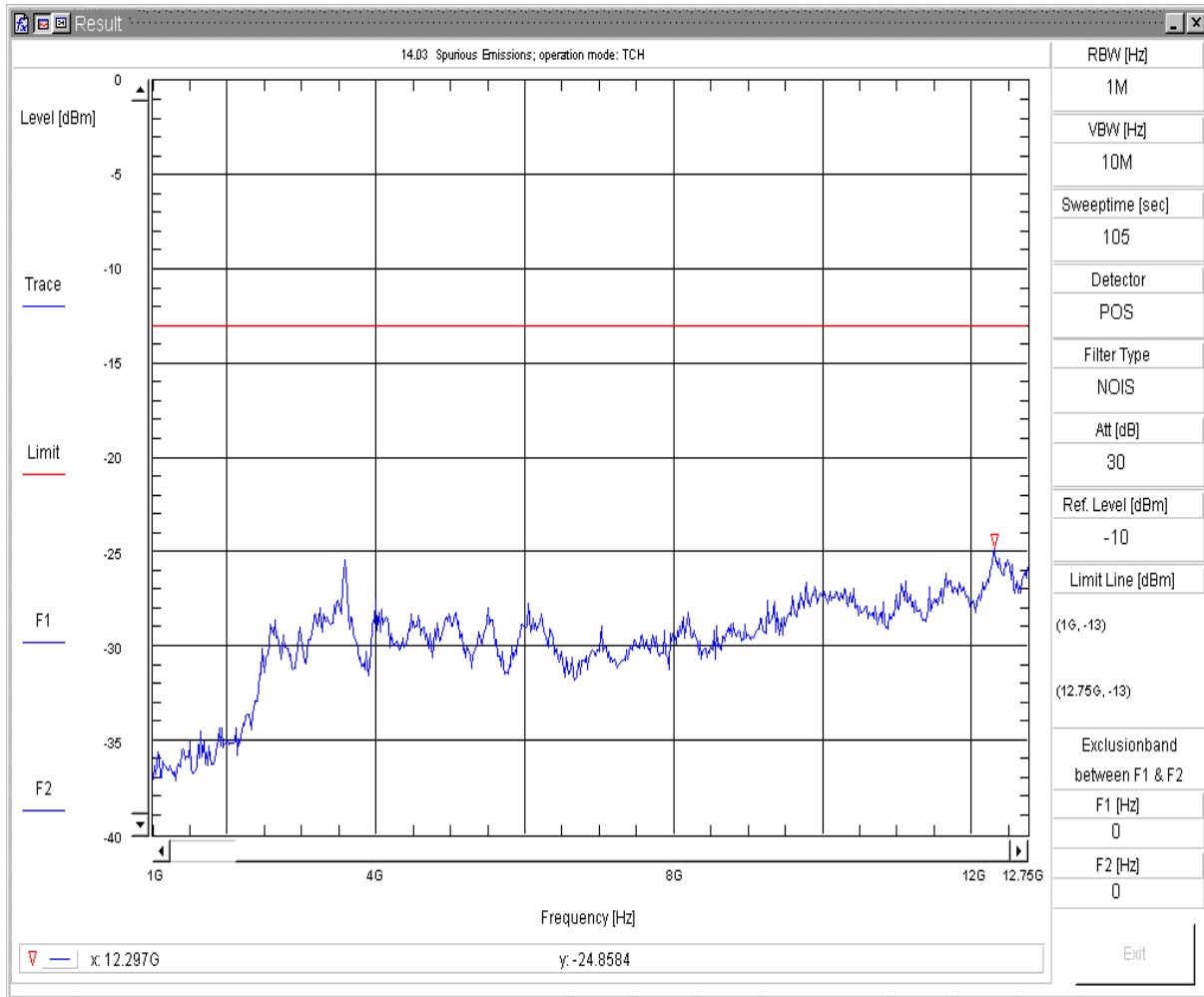

14.03 Conducted Spurious Emission

Transducer: c:\vee\_user\spuri\_V7\conducted\FCC\_Part\_22\_850\TD\_TX  
 Sweepnr: Sweep3  
 EUT OP Mode: FCC\_Part\_22\_850 TCH  
 UE Power: 31.4 dBm / 31.4 dBm  
 UE Status: Connection established (observed by operator)  
 EUT Description: MC55i + Board  
 EUT Hardware:  
 EUT Software: Rev. 00.303  
 EUT Config: C03  
 EUT S/N:  
 Battery: Power Supply (internal); Nominal Voltage; 4.8 VDC  
 Remark: Channel 128  
 Operator: x\_Hol  
 Testing Site: Radio Laboratory; CETECOM Essen

Tue 27/Nov/2007 22:04:360

Conducted Spurious Emissions V7.1.5

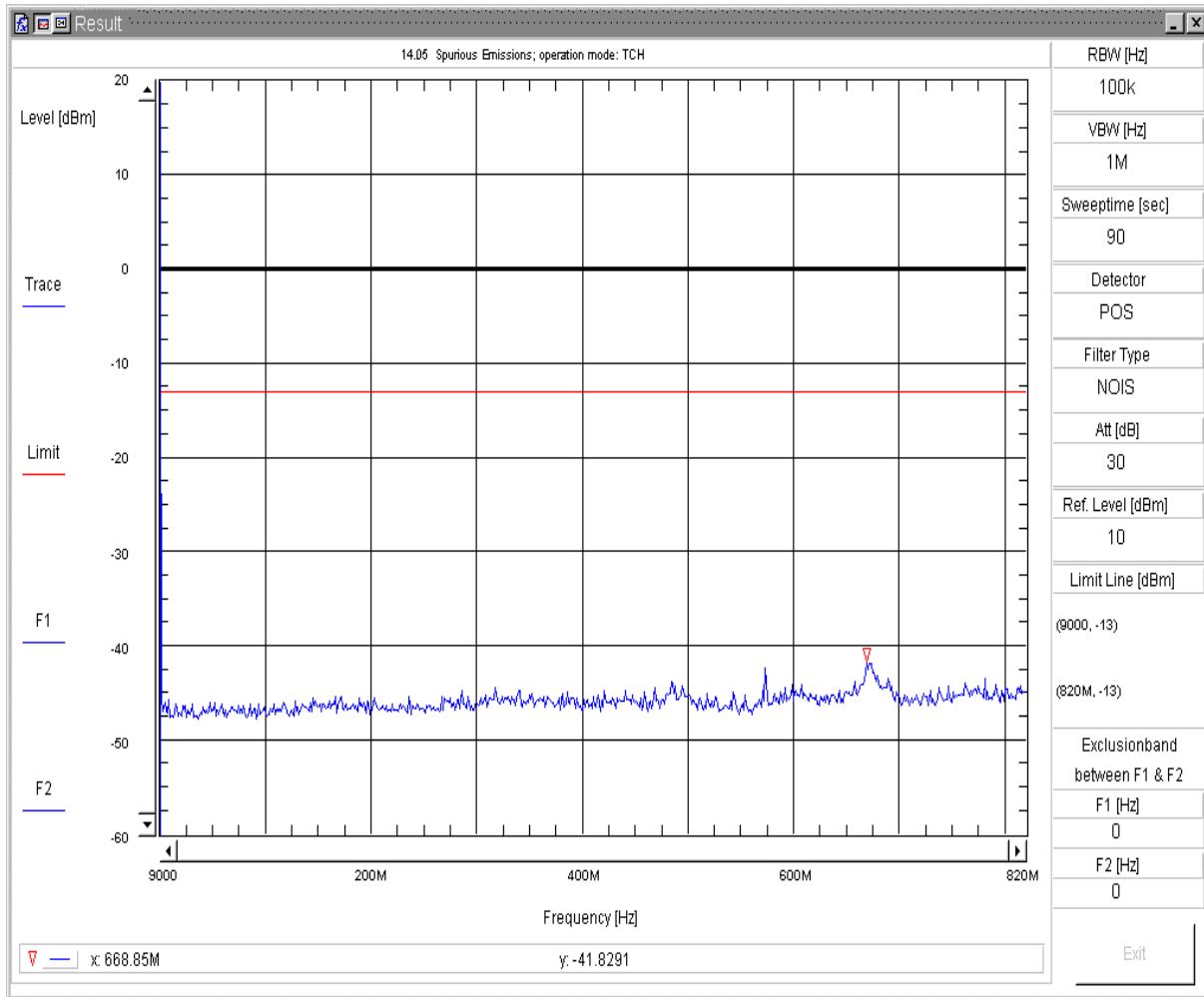

14.05 Conducted Spurious Emission

Transducer: c:\vee\_user\spuri\_V7\conducted\FCC\_Part\_22\_850\TD\_TX  
 Sweepnr: Sweep1  
 EUT OP Mode: FCC\_Part\_22\_850 TCH  
 UE Power: 31.4 dBm / 31.4 dBm  
 UE Status: Connection established (observed by operator)  
 EUT Description: MC55i + Board  
 EUT Hardware:  
 EUT Software: Rev. 00.303  
 EUT Config: C03  
 EUT S/N:  
 Battery: Power Supply (internal); Nominal Voltage; 4.8 VDC  
 Remark: Channel 192  
 Operator: x\_Hol  
 Testing Site: Radio Laboratory; CETECOM Essen

Tue 27/Nov/2007 22:09:450

Conducted Spurious Emissions V7.1.5

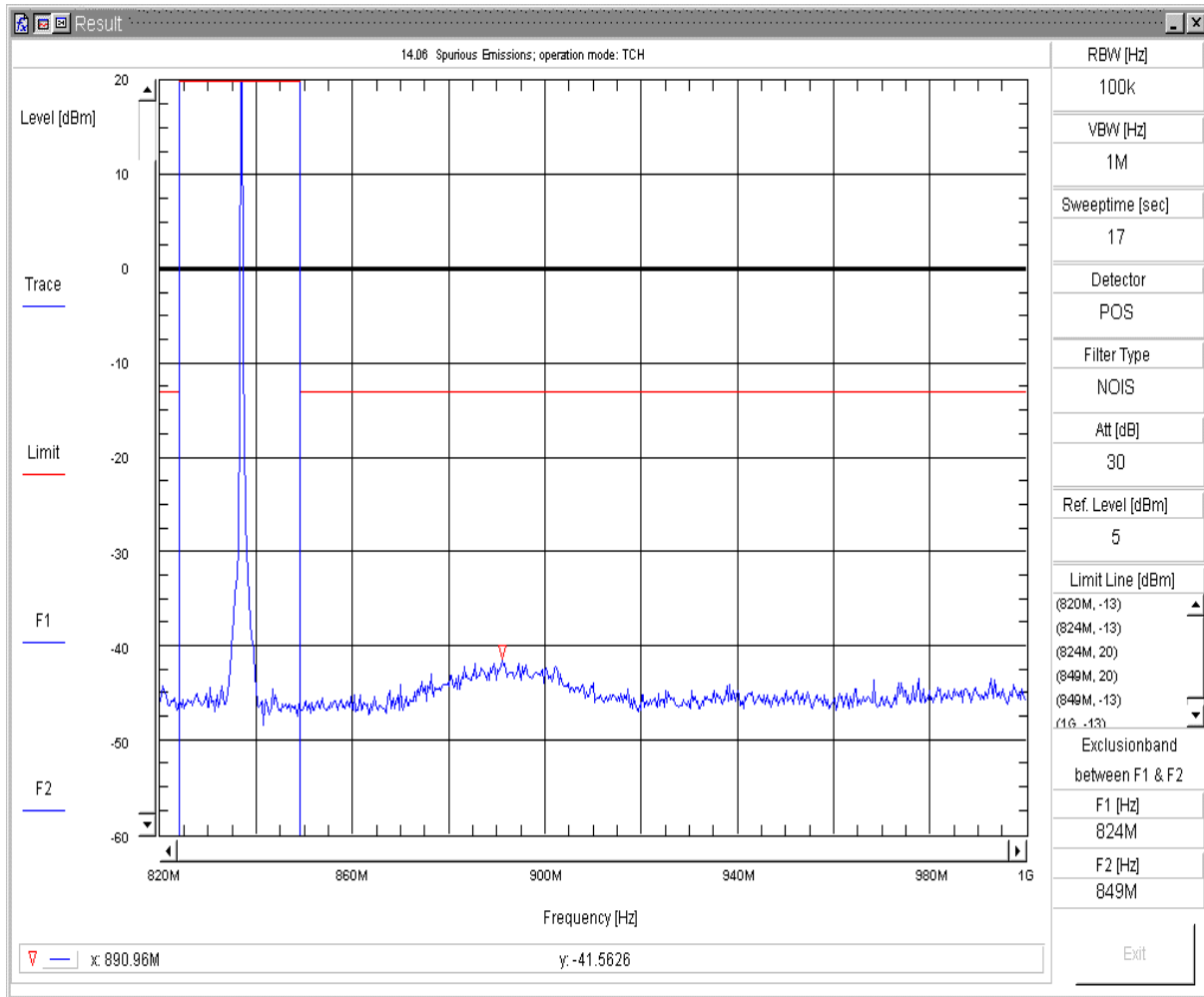

14.06 Conducted Spurious Emission

Transducer: c:\vee\_user\spuri\_V7\conducted\FCC\_Part\_22\_850\TD\_TX  
 Sweepnr: Sweep2  
 EUT OP Mode: FCC\_Part\_22\_850 TCH  
 UE Power: 27.5 dBm / 27.5 dBm  
 UE Status: Connection established (observed by operator)  
 EUT Description: MC55i + Board  
 EUT Hardware:  
 EUT Software: Rev. 00.303  
 EUT Config: C03  
 EUT S/N:  
 Battery: Power Supply (internal); Nominal Voltage; 4.8 VDC  
 Remark: Channel 192  
 Operator: x\_Hol  
 Testing Site: Radio Laboratory; CETECOM Essen

Tue 27/Nov/2007 22:12:450

Conducted Spurious Emissions V7.1.5

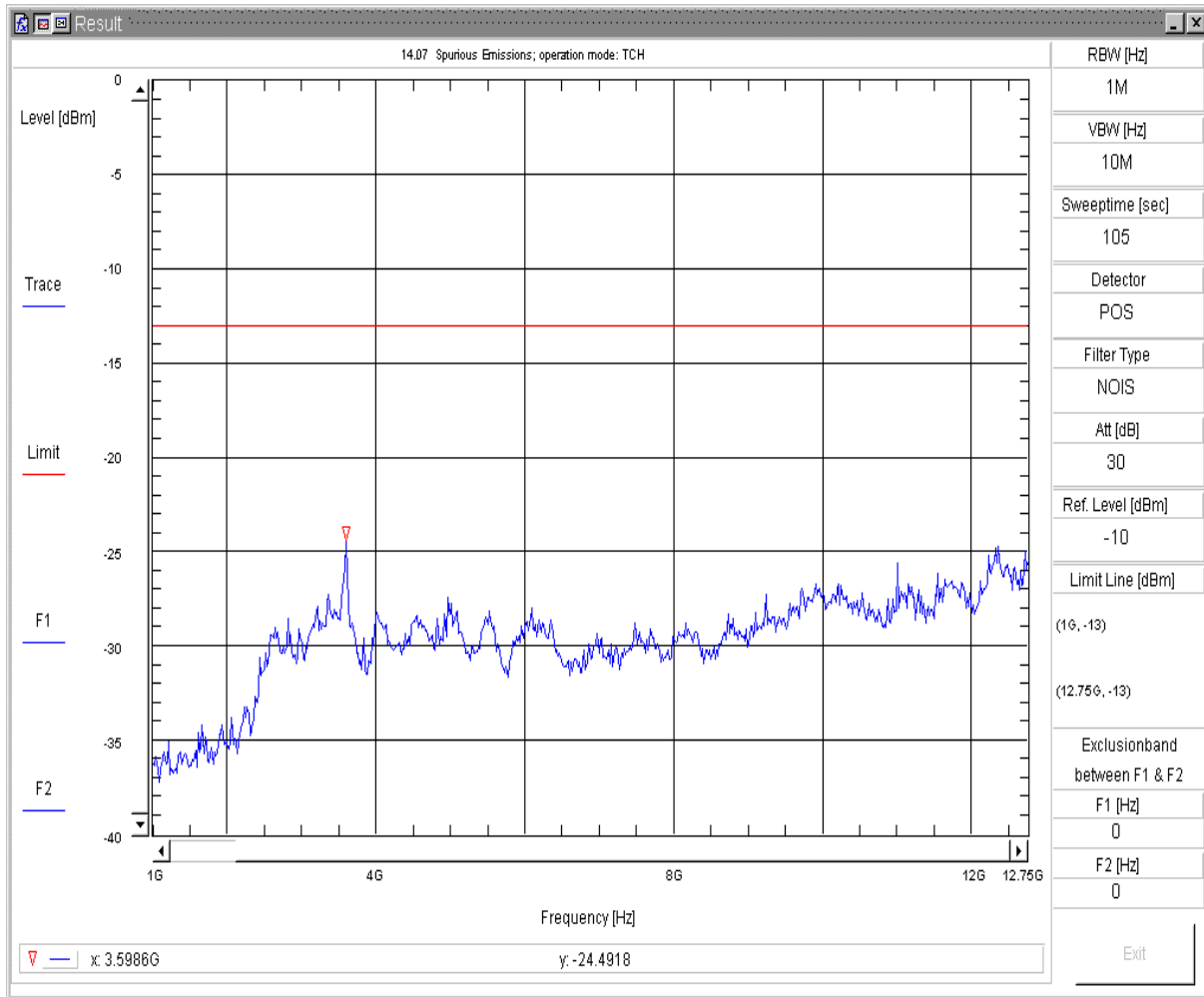

14.07 Conducted Spurious Emission

Transducer: c:\vee\_user\spuri\_V7\conducted\FCC\_Part\_22\_850\TD\_TX  
 Sweepnr: Sweep3  
 EUT OP Mode: FCC\_Part\_22\_850 TCH  
 UE Power: 27.7 dBm / 27.7 dBm  
 UE Status: Connection established (observed by operator)  
 EUT Description: MC55i + Board  
 EUT Hardware:  
 EUT Software: Rev. 00.303  
 EUT Config: C03  
 EUT S/N:  
 Battery: Power Supply (internal); Nominal Voltage; 4.8 VDC  
 Remark: Channel 192  
 Operator: x\_Hol  
 Testing Site: Radio Laboratory; CETECOM Essen

Tue 27/Nov/2007 22:14:190

Conducted Spurious Emissions V7.1.5

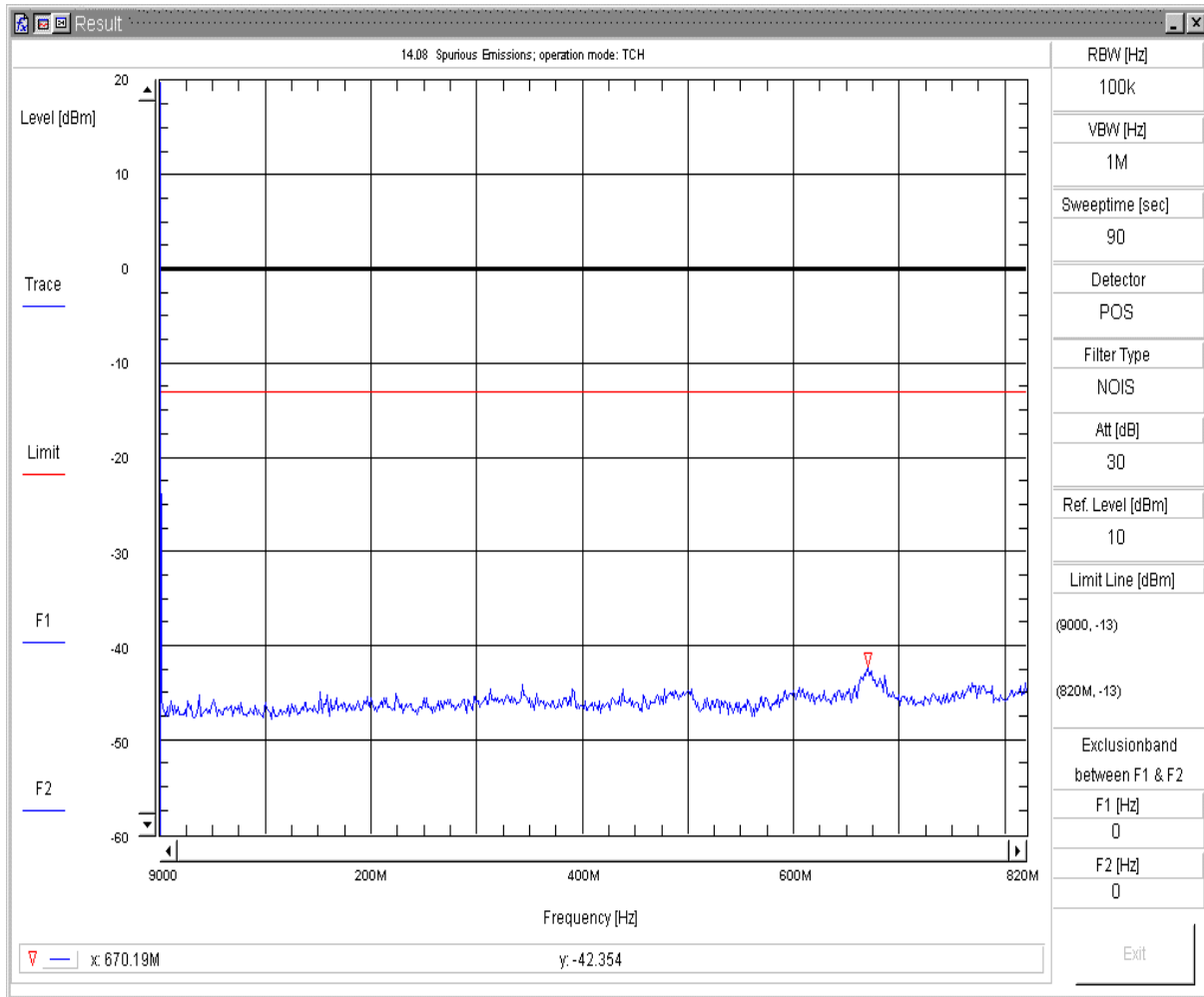

14.08 Conducted Spurious Emission

Transducer: c:\vee\_user\spuri\_V7\conducted\FCC\_Part\_22\_850\TD\_TX  
 Sweepnr: Sweep1  
 EUT OP Mode: FCC\_Part\_22\_850 TCH  
 UE Power: 27.7 dBm / 27.7 dBm  
 UE Status: Connection established (observed by operator)  
 EUT Description: MC55i + Board  
 EUT Hardware:  
 EUT Software: Rev. 00.303  
 EUT Config: C03  
 EUT S/N:  
 Battery: Power Supply (internal); Nominal Voltage; 4.8 VDC  
 Remark: Channel 251  
 Operator: x\_Hol  
 Testing Site: Radio Laboratory; CETECOM Essen

Tue 27/Nov/2007 22:17:530

Conducted Spurious Emissions V7.1.5

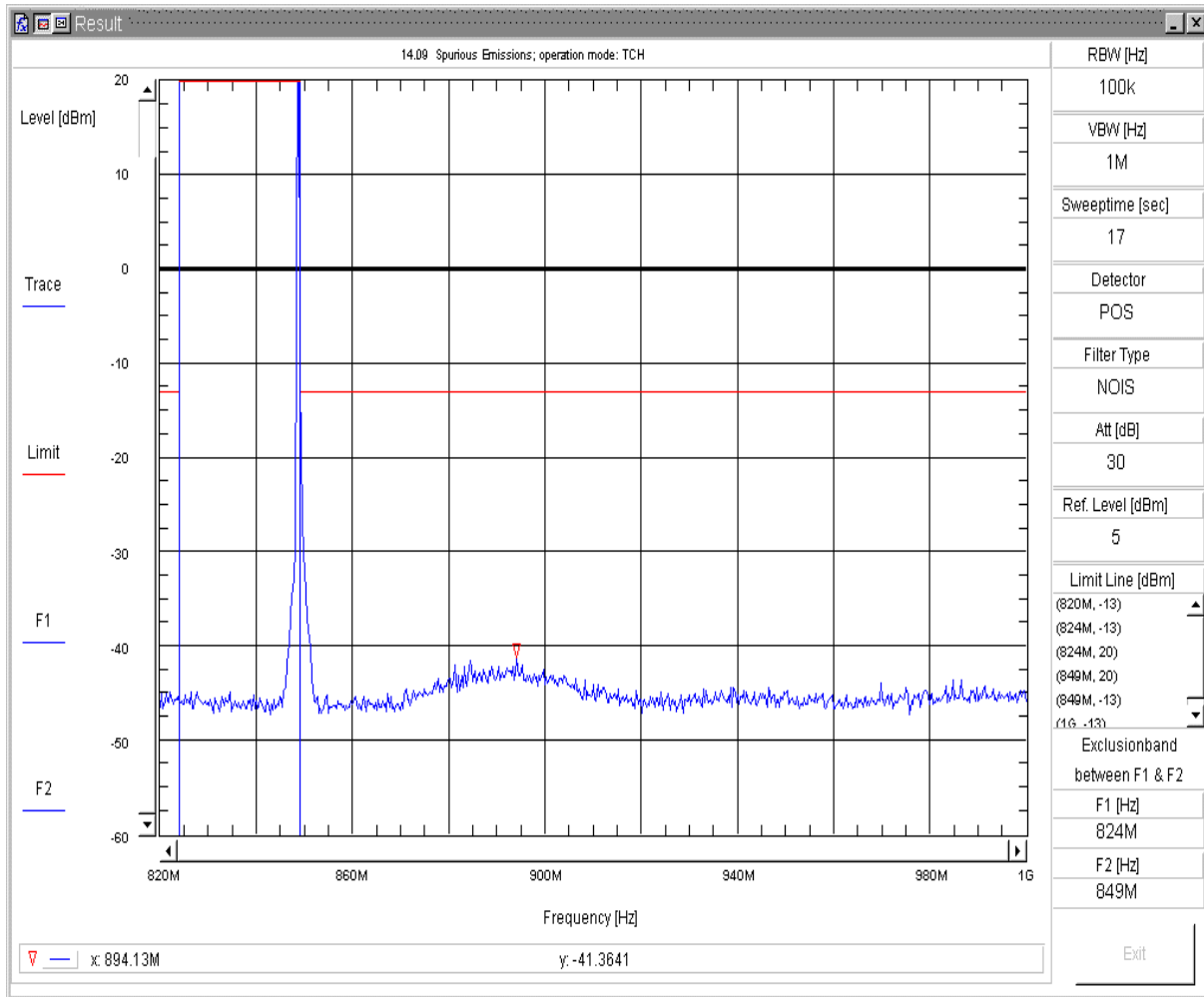

14.09 Conducted Spurious Emission

Transducer: c:\vee\_user\spuri\_V7\conducted\FCC\_Part\_22\_850\TD\_TX  
 Sweepnr: Sweep2  
 EUT OP Mode: FCC\_Part\_22\_850 TCH  
 UE Power: 28.9 dBm / 28.9 dBm  
 UE Status: Connection established (observed by operator)  
 EUT Description: MC55i + Board  
 EUT Hardware:  
 EUT Software: Rev. 00.303  
 EUT Config: C03  
 EUT S/N:  
 Battery: Power Supply (internal); Nominal Voltage; 4.8 VDC  
 Remark: Channel 251  
 Operator: x\_Hol  
 Testing Site: Radio Laboratory; CETECOM Essen

Tue 27/Nov/2007 22:20:370

Conducted Spurious Emissions V7.1.5

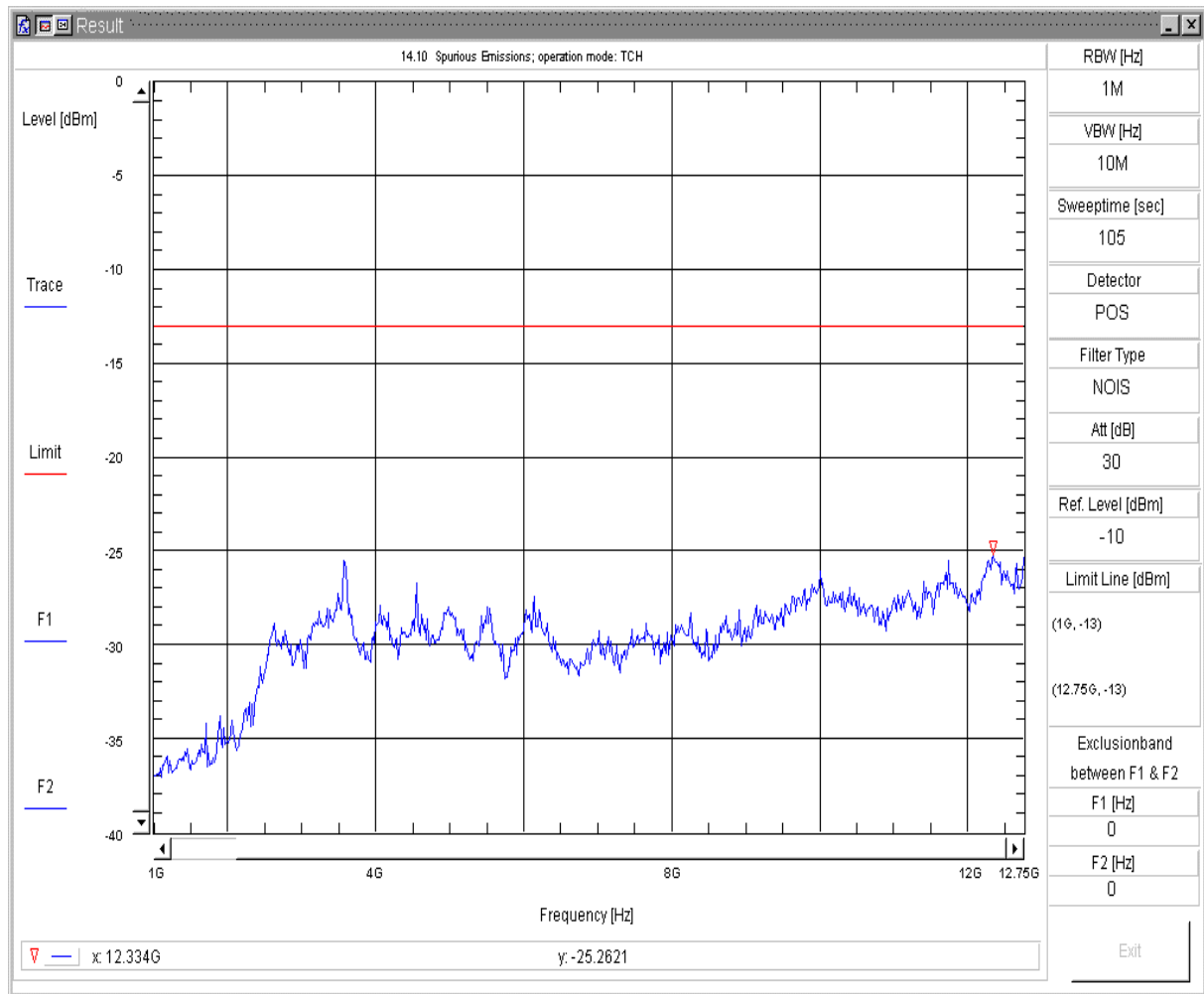

#### 14.10 Conducted Spurious Emission

Transducer: c:\vee\_user\spuri\_V7\conducted\FCC\_Part\_22\_850\TD\_TX  
 Sweepnr: Sweep3  
 EUT OP Mode: FCC\_Part\_22\_850 TCH  
 UE Power: 28.9 dBm / 28.9 dBm  
 UE Status: Connection established (observed by operator)  
 EUT Description: MC55i + Board  
 EUT Hardware:  
 EUT Software: Rev. 00.303  
 EUT Config: C03  
 EUT S/N:  
 Battery: Power Supply (internal); Nominal Voltage; 4.8 VDC  
 Remark: Channel 251  
 Operator: x\_Hol  
 Testing Site: Radio Laboratory; CETECOM Essen

Tue 27/Nov/2007 22:21:510

Conducted Spurious Emissions V7.1.5

### 9.3.2. Band-Edge Channel 128

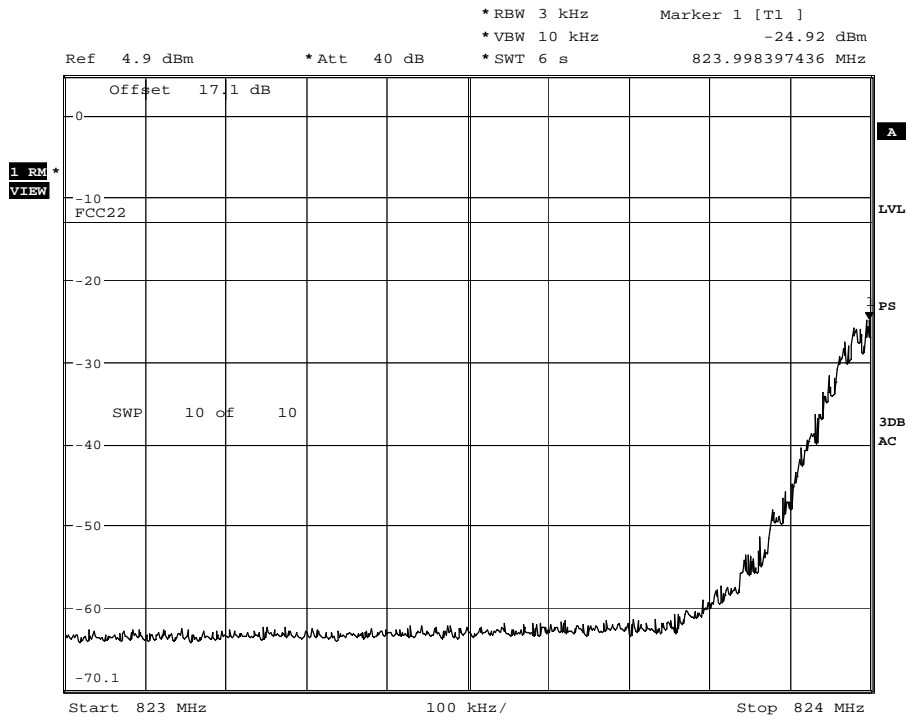

Date: 28.NOV.2007 09:17:38

### 9.3.3. Band-Edge Channel 251

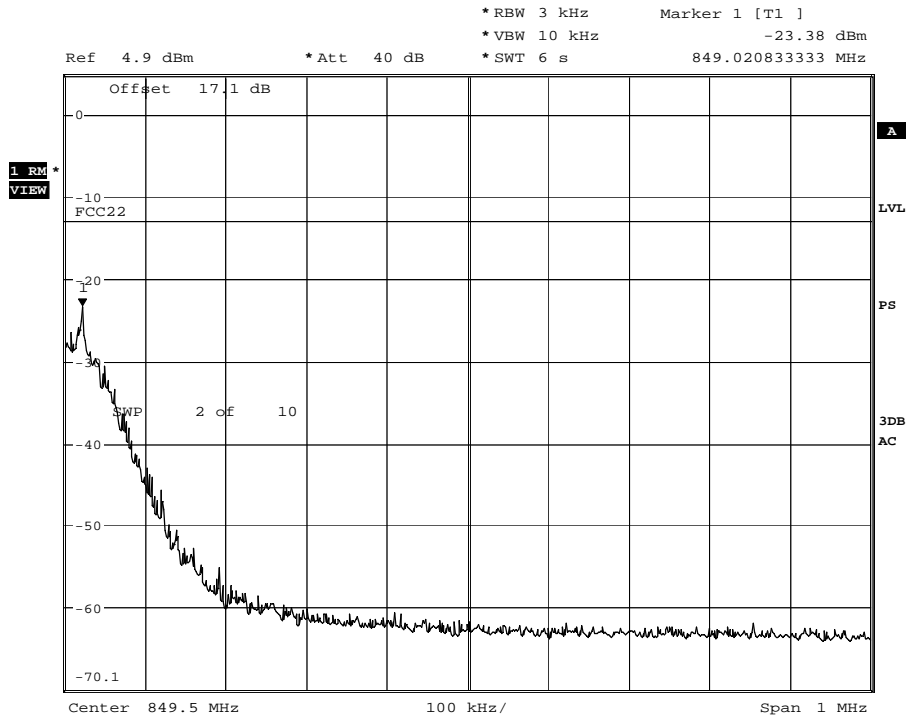

Date: 28.NOV.2007 09:15:28



### 9.3.4. GSM 850 IDLE MODE

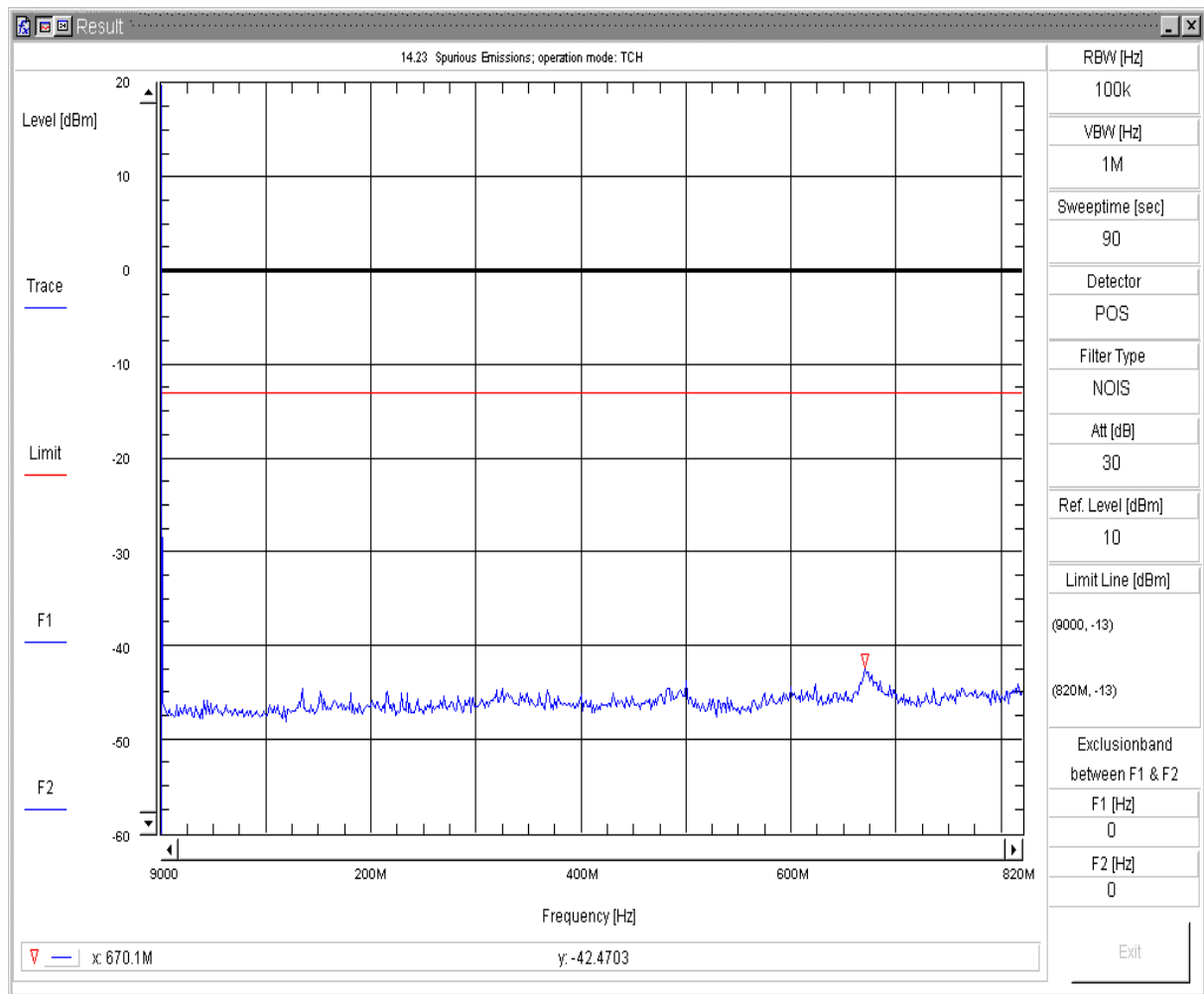

14.23 Conducted Spurious Emission

Transducer: c:\vee\_user\spuri\_V7\conducted\FCC\_Part\_22\_850\TD\_TX  
 Sweepnr: Sweep1  
 EUT OP Mode: FCC\_Part\_22\_850 TCH  
 UE Power: 25.1 dBm / 25.1 dBm  
 UE Status: Connection established (observed by operator)  
 EUT Description: MC55i  
 EUT Hardware: B2.1  
 EUT Software:  
 EUT Config: C03  
 EUT S/N: IMEI: 004401080149509  
 Battery: Power Supply (external); Maximum Voltage; 4.8 VDC  
 Remark: Channel 192  
 Operator: LOR  
 Testing Site: Radio Laboratory; CETECOM Essen

Wed 28/Nov/2007 15:16:090

Conducted Spurious Emissions V7.1.5

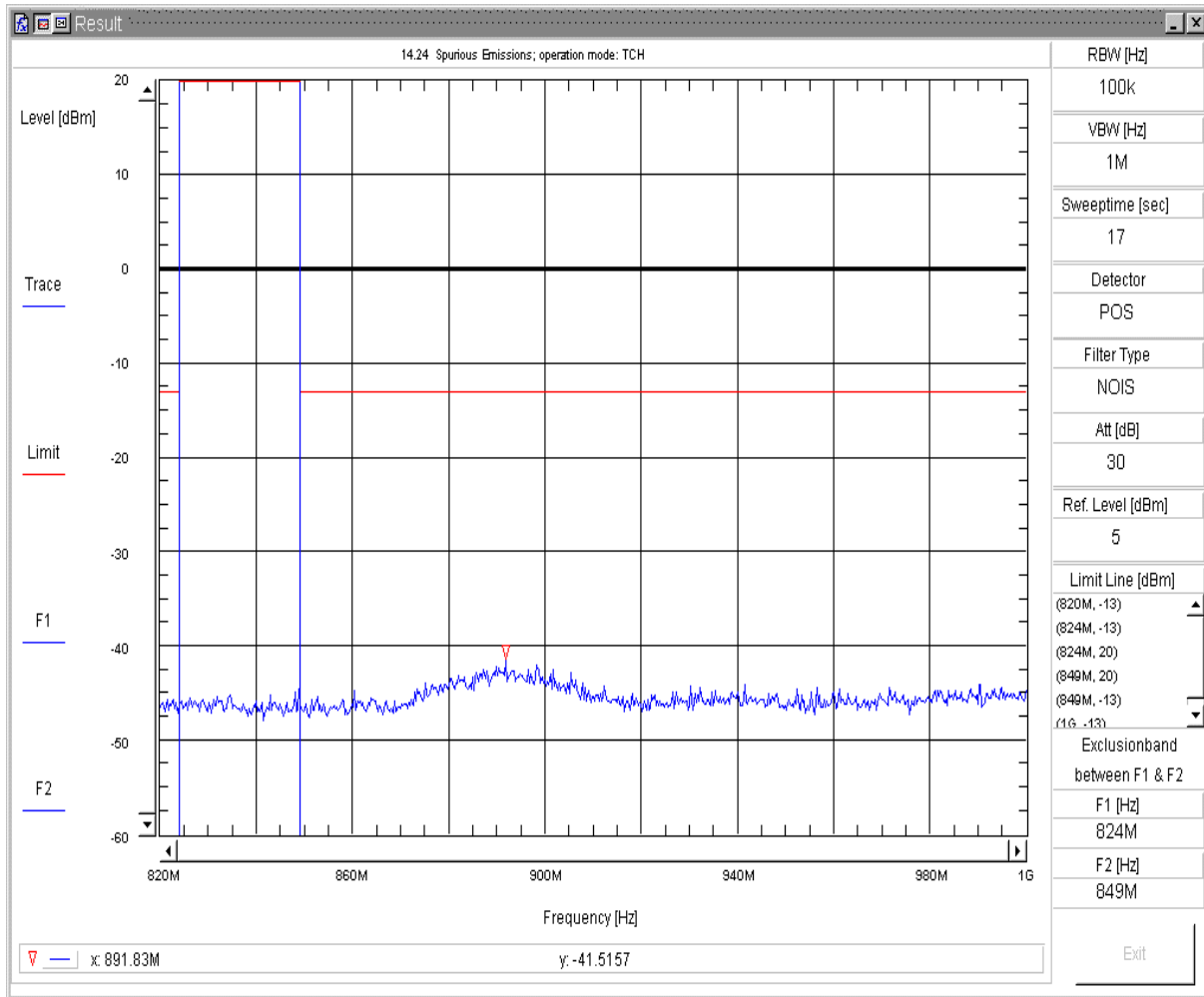

14.24 Conducted Spurious Emission

Transducer: c:\vee\_user\spuri\_V7\conducted\FCC\_Part\_22\_850\TD\_TX  
 Sweepnr: Sweep2  
 EUT OP Mode: FCC\_Part\_22\_850 TCH  
 UE Power: 25.1 dBm / 25.1 dBm  
 UE Status: Connection established (observed by operator)  
 EUT Description: MC55i  
 EUT Hardware: B2.1  
 EUT Software:  
 EUT Config: C03  
 EUT S/N: IMEI: 004401080149509  
 Battery: Power Supply (external); Maximum Voltage; 4.8 VDC  
 Remark: Channel 192  
 Operator: LOR  
 Testing Site: Radio Laboratory; CETECOM Essen

Wed 28/Nov/2007 15:19:150

Conducted Spurious Emissions V7.1.5

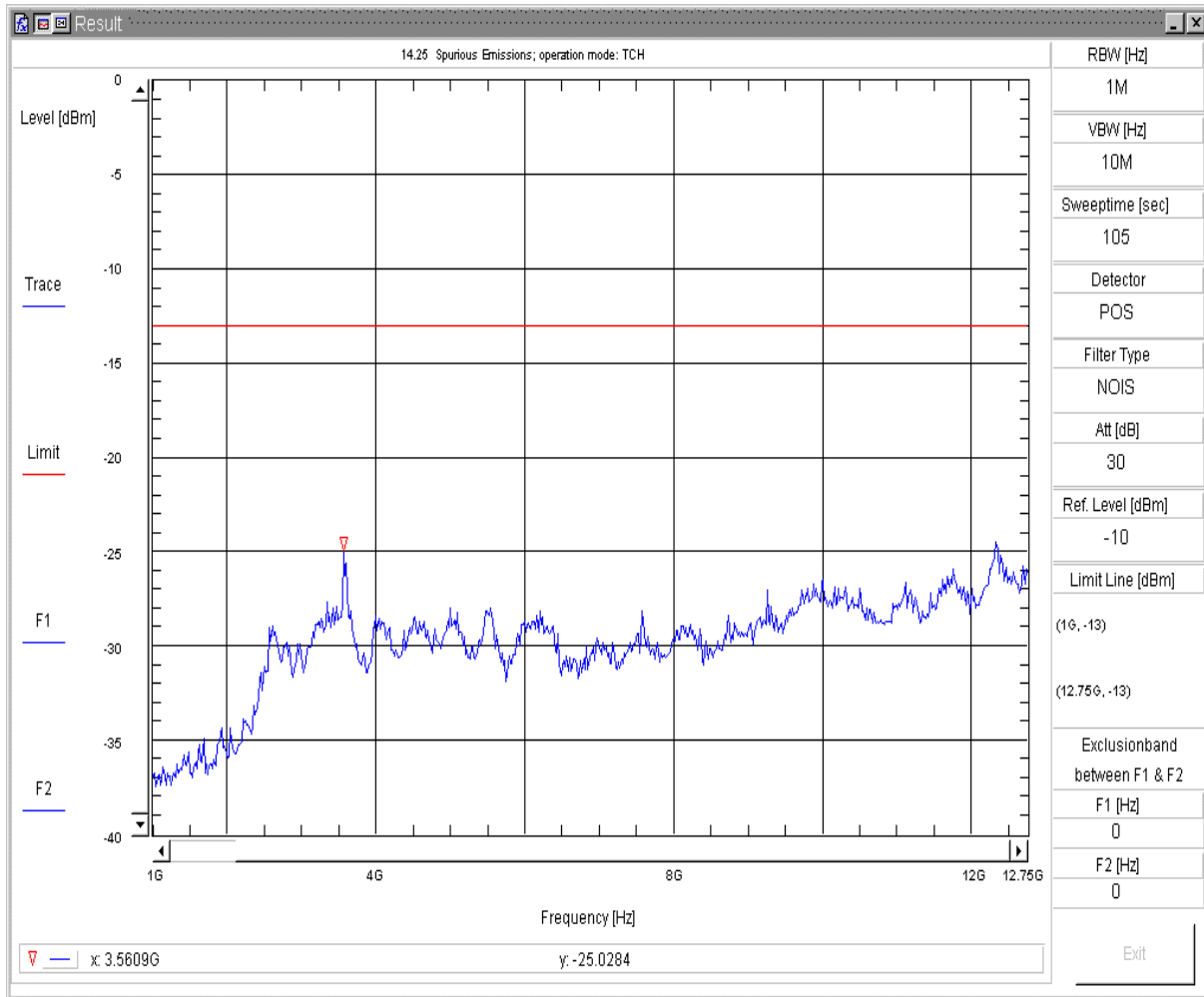

14.25 Conducted Spurious Emission

Transducer: c:\vee\_user\spuri\_V7\conducted\FCC\_Part\_22\_850\TD\_TX  
 Sweepnr: Sweep3  
 EUT OP Mode: FCC\_Part\_22\_850 TCH  
 UE Power: 25.1 dBm / 25.1 dBm  
 UE Status: Connection established (observed by operator)  
 EUT Description: MC55i  
 EUT Hardware: B2.1  
 EUT Software:  
 EUT Config: C03  
 EUT S/N: IMEI: 004401080149509  
 Battery: Power Supply (external); Maximum Voltage; 4.8 VDC  
 Remark: Channel 192  
 Operator: LOR  
 Testing Site: Radio Laboratory; CETECOM Essen

Wed 28/Nov/2007 15:20:280

Conducted Spurious Emissions V7.1.5

### 9.3.5. GSM TCH 1900 MODE

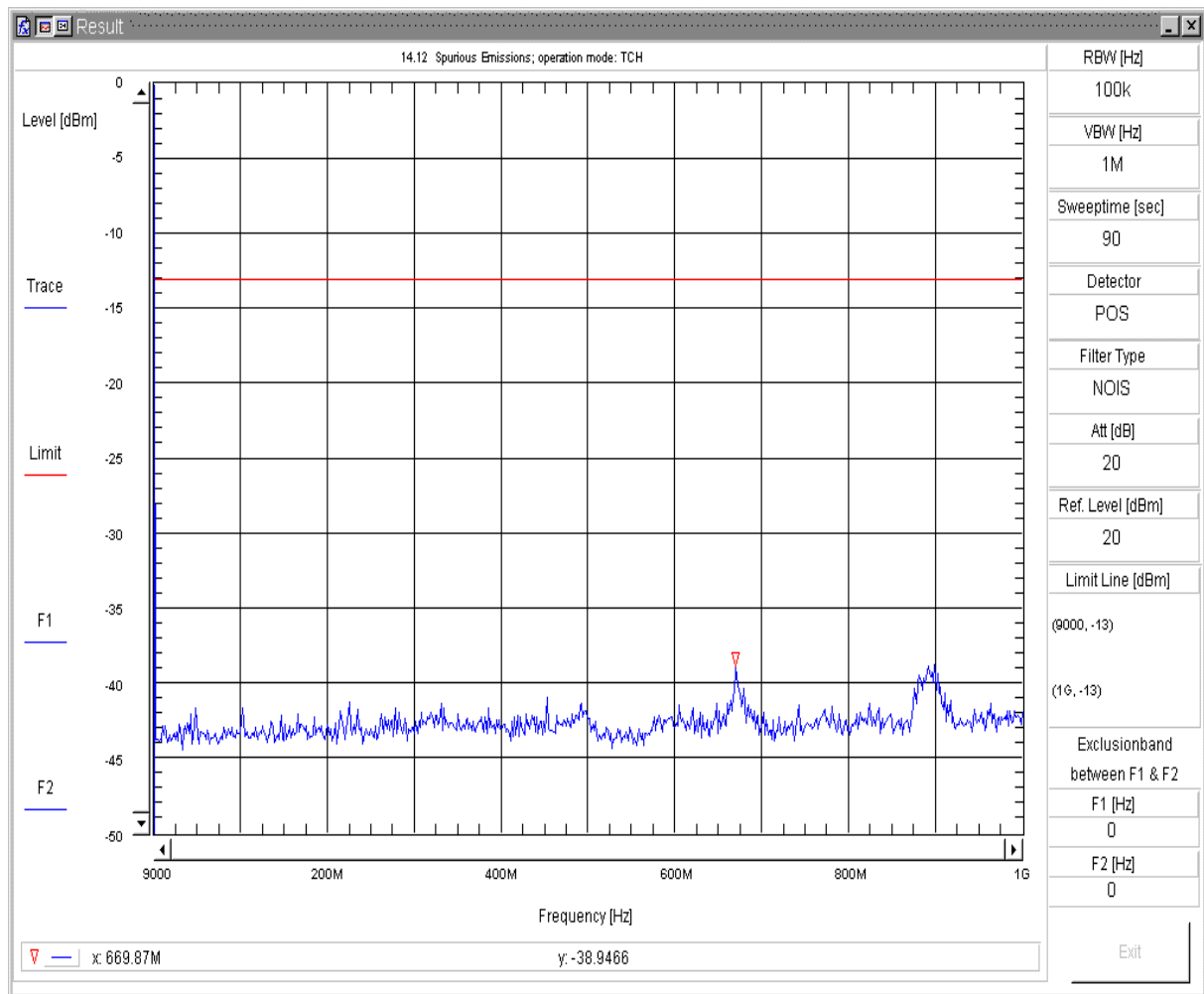

14.12 Conducted Spurious Emission

Transducer: c:\vee\_user\spuri\_V7\conducted\FCC\_Part\_24\_1900\TD\_TX  
 Sweepnr: Sweep1  
 EUT OP Mode: FCC\_Part\_24\_1900 TCH  
 UE Power: 31.4 dBm / 31.4 dBm  
 UE Status: Connection established (observed by operator)  
 EUT Description: MC55i  
 EUT Hardware: B2.1  
 EUT Software: Rev 00.303  
 EUT Config: C03  
 EUT S/N: IMEI 004401080149475  
 Battery: Power Supply (external); Maximum Voltage; 4.8 VDC  
 Remark: Channel 512  
 Operator: LOR  
 Testing Site: Radio Laboratory; CETECOM Essen

Mon 26/Nov/2007 13:17:210

Conducted Spurious Emissions V7.1.5

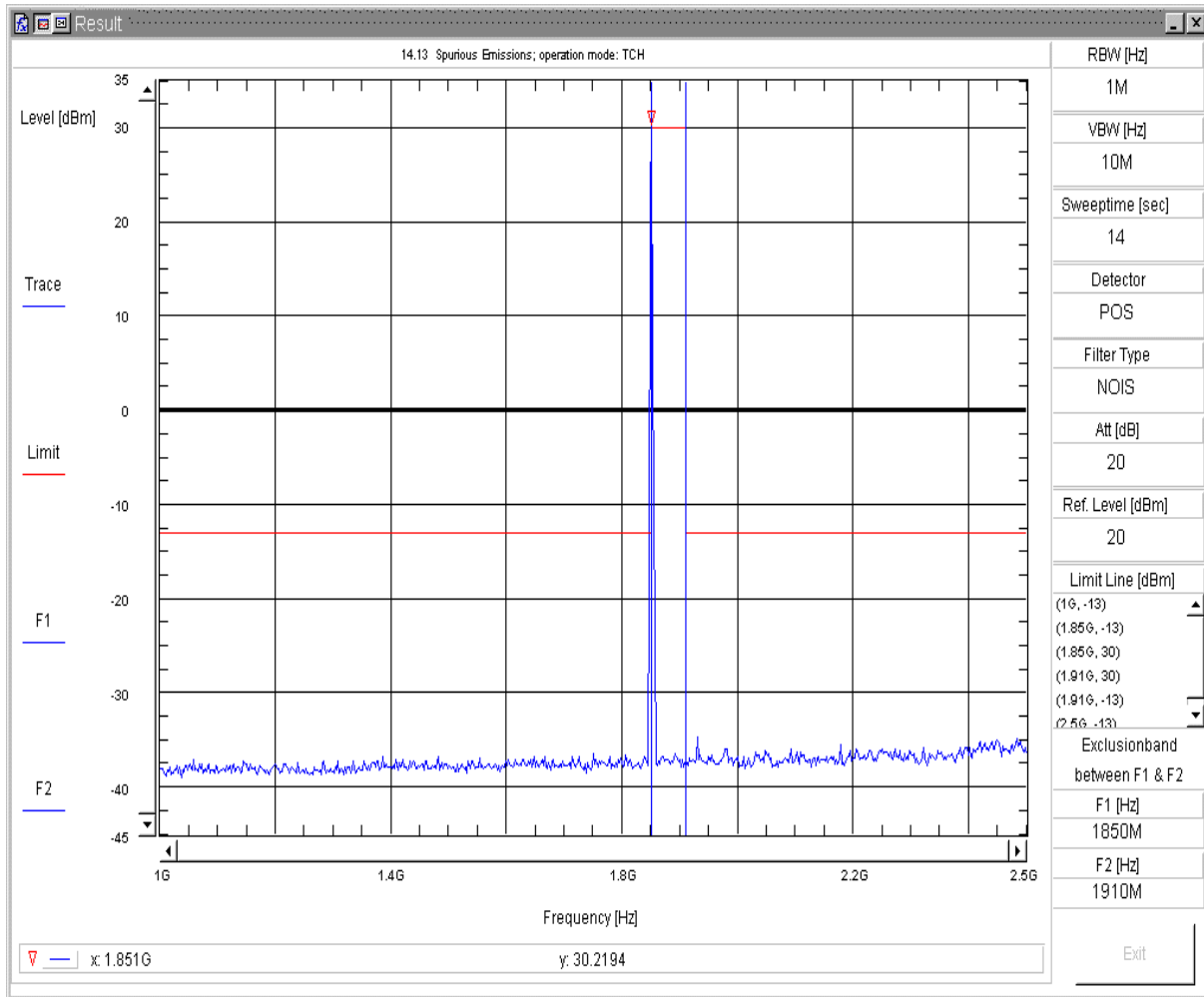

14.13 Conducted Spurious Emission

Transducer: c:\vee\_user\spuri\_V7\conducted\FCC\_Part\_24\_1900\TD\_TX  
 Sweepnr: Sweep2  
 EUT OP Mode: FCC\_Part\_24\_1900 TCH  
 UE Power: 30.0 dBm / 30.0 dBm  
 UE Status: Connection established (observed by operator)  
 EUT Description: MC55i  
 EUT Hardware: B2.1  
 EUT Software: Rev 00.303  
 EUT Config: C03  
 EUT S/N: IMEI 004401080149475  
 Battery: Power Supply (external); Maximum Voltage; 4.8 VDC  
 Remark: Channel 512  
 Operator: LOR  
 Testing Site: Radio Laboratory; CETECOM Essen

Mon 26/Nov/2007 13:19:550

Conducted Spurious Emissions V7.1.5

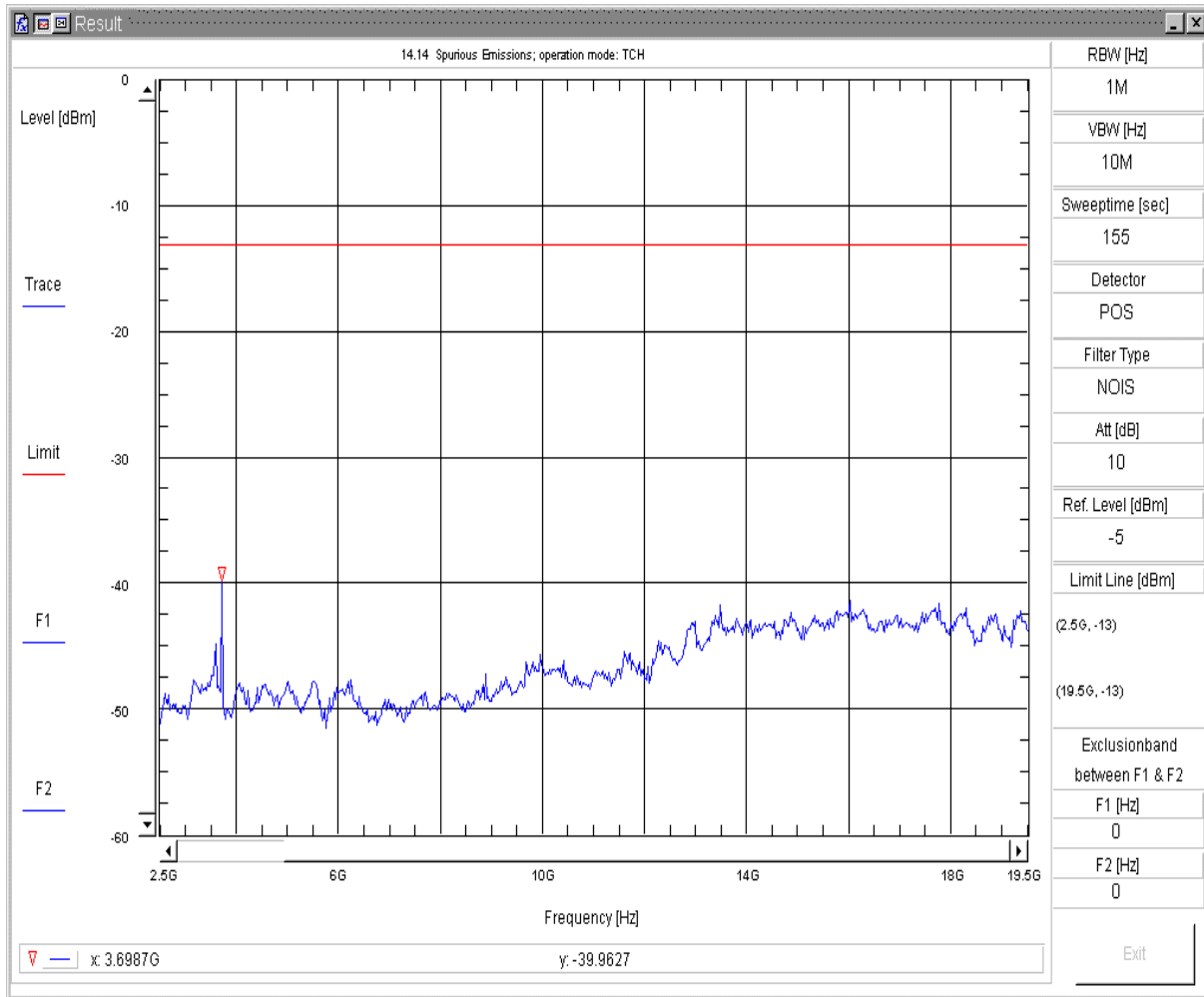

14.14 Conducted Spurious Emission

Transducer: c:\vee\_user\spuri\_V7\conducted\FCC\_Part\_24\_1900\TD\_TX  
 Sweepnr: Sweep3  
 EUT OP Mode: FCC\_Part\_24\_1900 TCH  
 UE Power: 30.0 dBm / 30.0 dBm  
 UE Status: Connection established (observed by operator)  
 EUT Description: MC55i  
 EUT Hardware: B2.1  
 EUT Software: Rev 00.303  
 EUT Config: C03  
 EUT S/N: IMEI 004401080149475  
 Battery: Power Supply (external); Maximum Voltage; 4.8 VDC  
 Remark: Channel 512  
 Operator: LOR  
 Testing Site: Radio Laboratory; CETECOM Essen

Mon 26/Nov/2007 13:21:140

Conducted Spurious Emissions V7.1.5

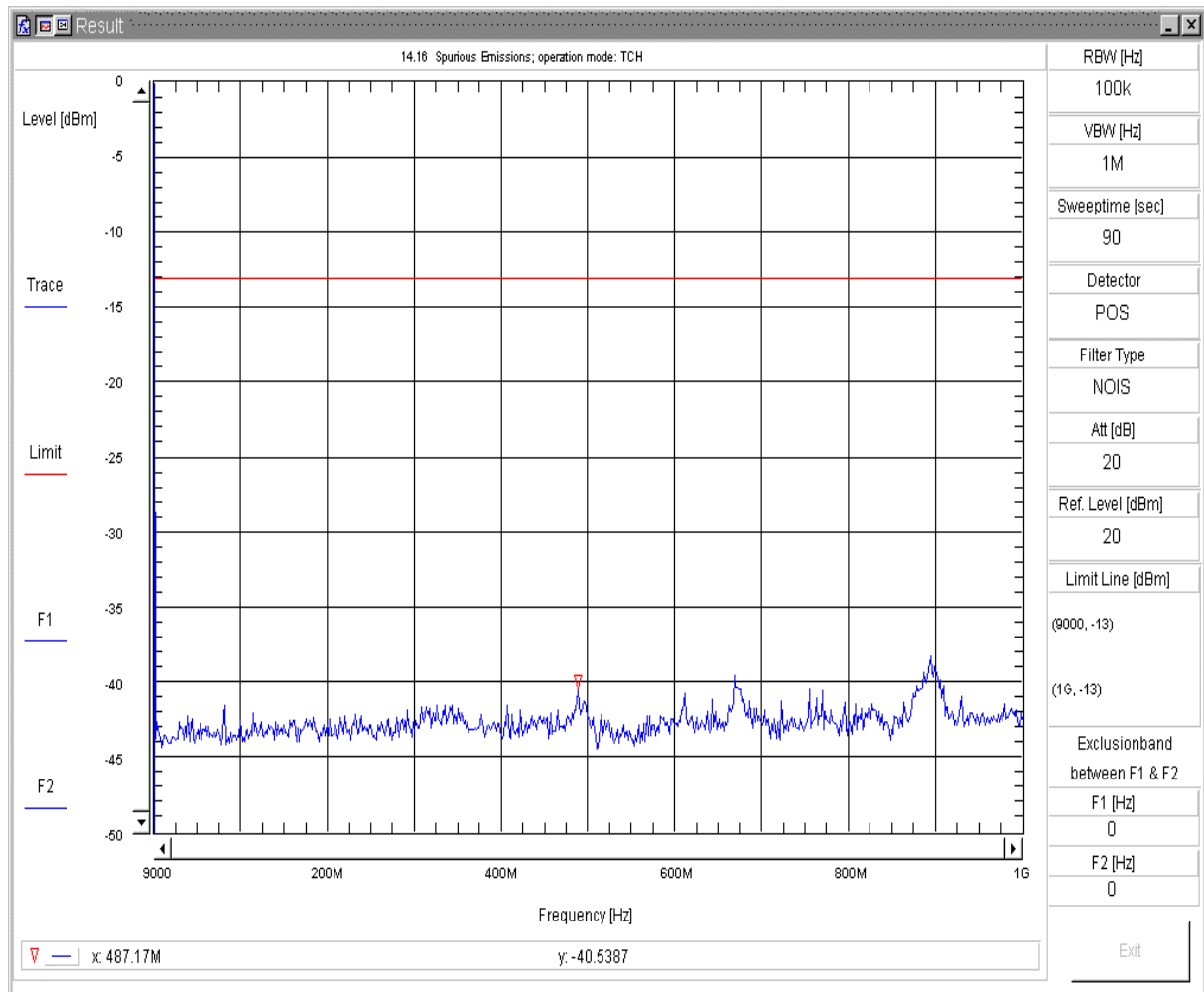

#### 14.16 Conducted Spurious Emission

Transducer: c:\vee\_user\spuri\_V7\conducted\FCC\_Part\_24\_1900\TD\_TX  
 Sweepnr: Sweep1  
 EUT OP Mode: FCC\_Part\_24\_1900 TCH  
 UE Power: 30.0 dBm / 30.0 dBm  
 UE Status: Connection established (observed by operator)  
 EUT Description: MC55i  
 EUT Hardware: B2.1  
 EUT Software: Rev 00.303  
 EUT Config: C03  
 EUT S/N: IMEI 004401080149475  
 Battery: Power Supply (external); Maximum Voltage; 4.8 VDC  
 Remark: Channel 661  
 Operator: LOR  
 Testing Site: Radio Laboratory; CETECOM Essen

Mon 26/Nov/2007 13:33:430

Conducted Spurious Emissions V7.1.5

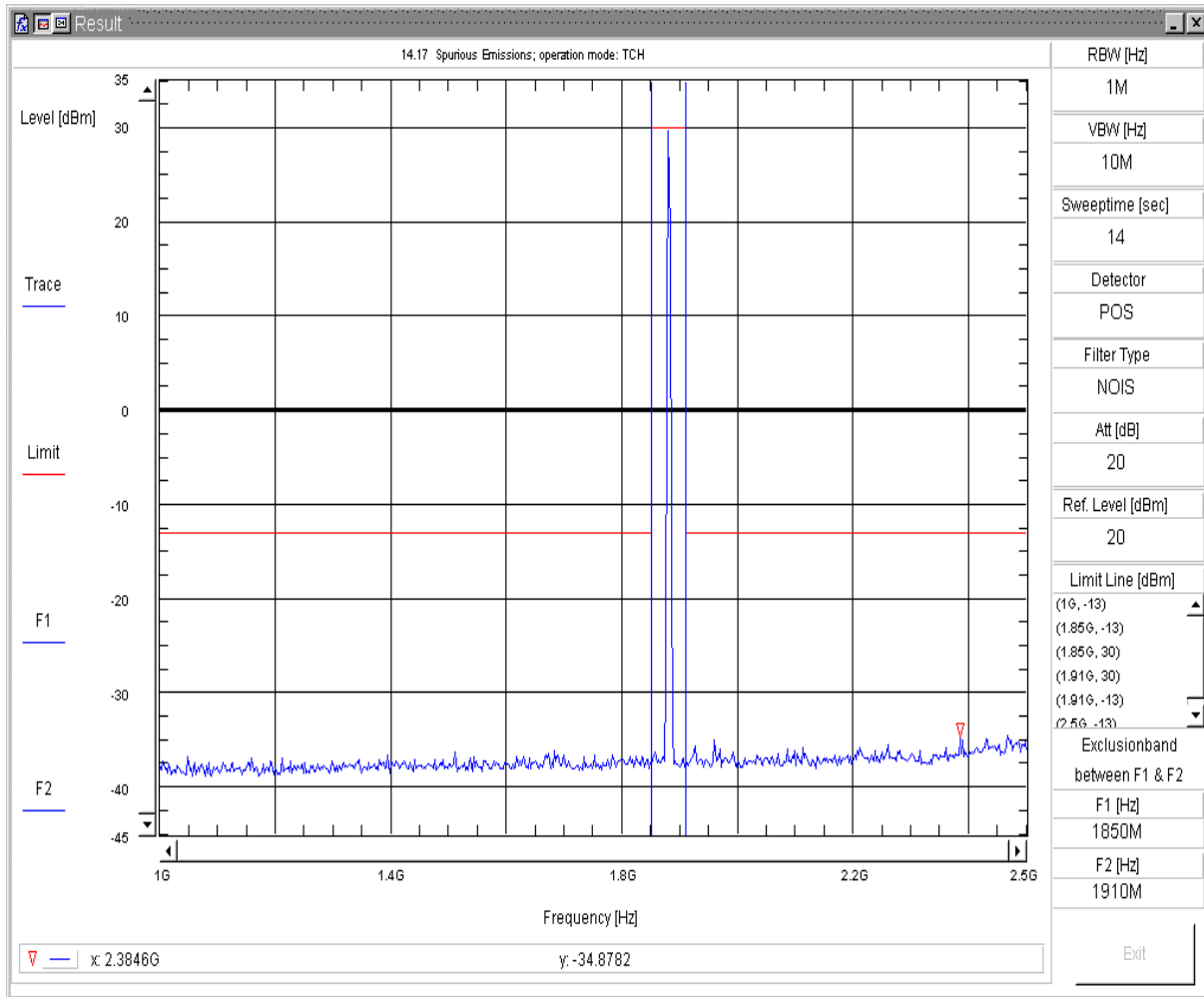

14.17 Conducted Spurious Emission

Transducer: c:\vee\_user\spuri\_V7\conducted\FCC\_Part\_24\_1900\TD\_TX  
 Sweepnr: Sweep2  
 EUT OP Mode: FCC\_Part\_24\_1900 TCH  
 UE Power: 30.0 dBm / 30.0 dBm  
 UE Status: Connection established (observed by operator)  
 EUT Description: MC55i  
 EUT Hardware: B2.1  
 EUT Software: Rev 00.303  
 EUT Config: C03  
 EUT S/N: IMEI 004401080149475  
 Battery: Power Supply (external); Maximum Voltage; 4.8 VDC  
 Remark: Channel 661  
 Operator: LOR  
 Testing Site: Radio Laboratory; CETECOM Essen

Mon 26/Nov/2007 13:37:140

Conducted Spurious Emissions V7.1.5



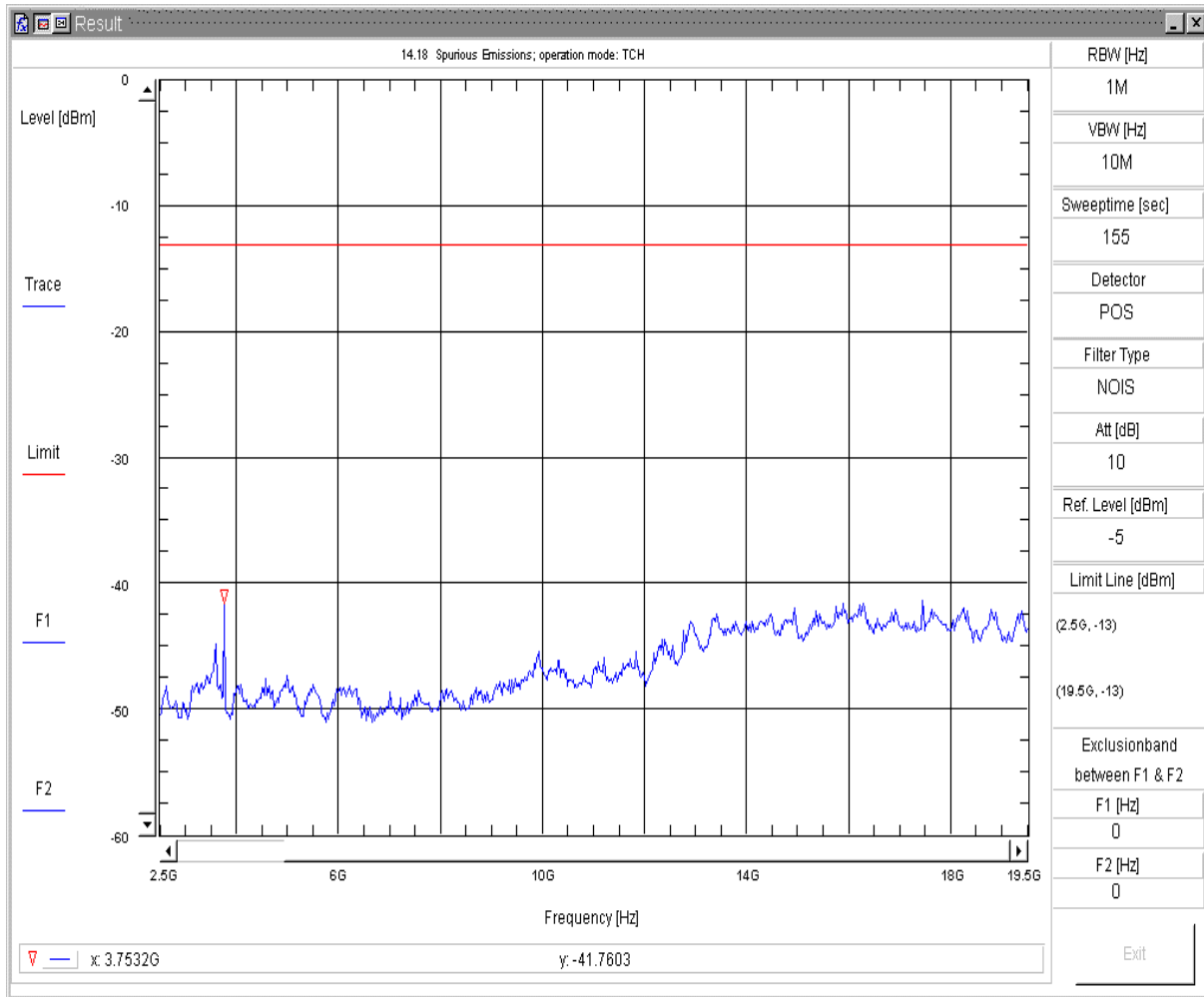

14.18 Conducted Spurious Emission

Transducer: c:\vee\_user\spuri\_V7\conducted\FCC\_Part\_24\_1900\TD\_TX  
 Sweepnr: Sweep3  
 EUT OP Mode: FCC\_Part\_24\_1900 TCH  
 UE Power: 30.0 dBm / 30.0 dBm  
 UE Status: Connection established (observed by operator)  
 EUT Description: MC55i  
 EUT Hardware: B2.1  
 EUT Software: Rev 00.303  
 EUT Config: C03  
 EUT S/N: IMEI 004401080149475  
 Battery: Power Supply (external); Maximum Voltage; 4.8 VDC  
 Remark: Channel 661  
 Operator: LOR  
 Testing Site: Radio Laboratory; CETECOM Essen

Mon 26/Nov/2007 13:39:080

Conducted Spurious Emissions V7.1.5

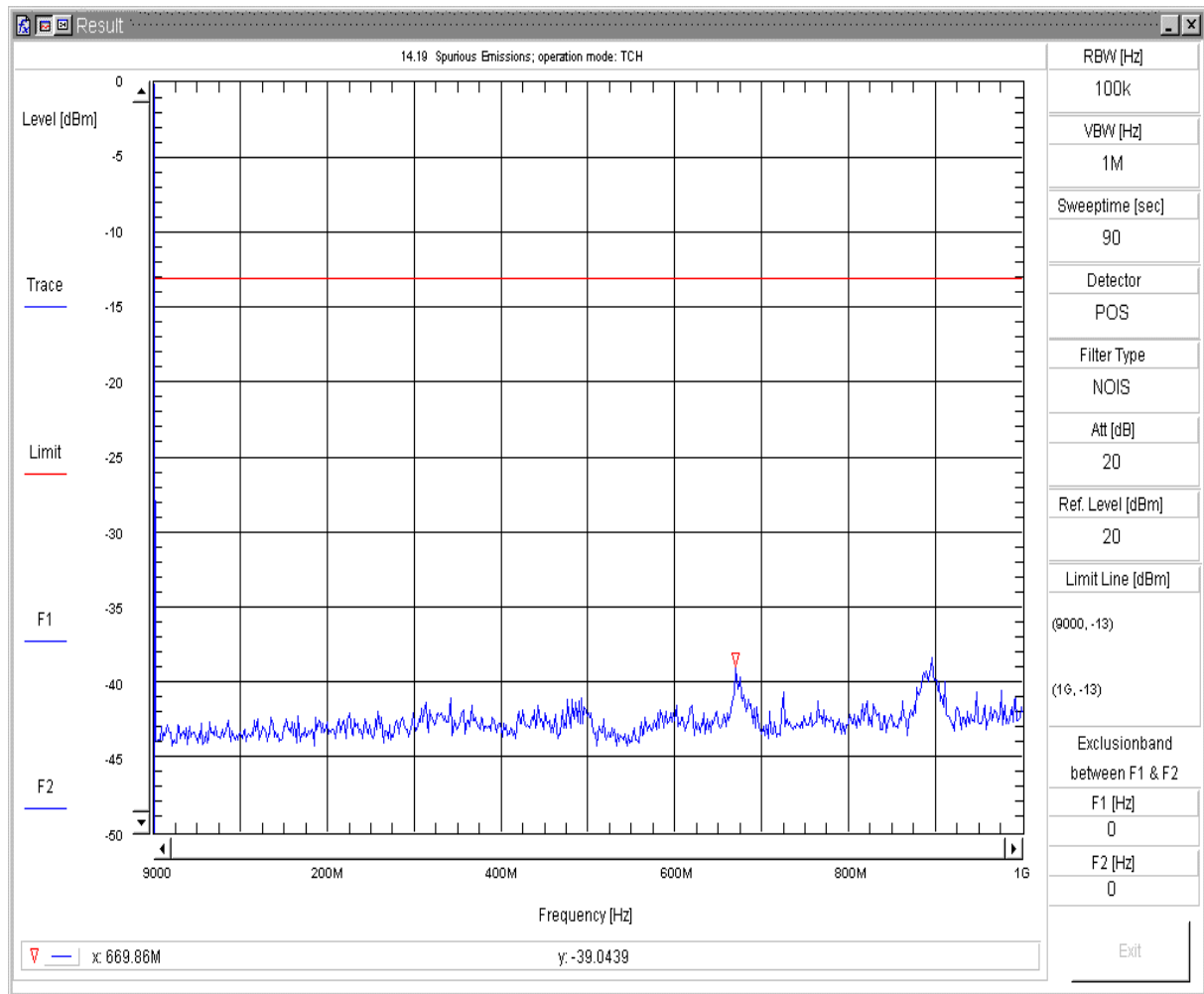

#### 14.19 Conducted Spurious Emission

Transducer: c:\vee\_user\spuri\_V7\conducted\FCC\_Part\_24\_1900\TD\_TX  
 Sweepnr: Sweep1  
 EUT OP Mode: FCC\_Part\_24\_1900 TCH  
 UE Power: 30.0 dBm / 30.0 dBm  
 UE Status: Connection established (observed by operator)  
 EUT Description: MC55i  
 EUT Hardware: B2.1  
 EUT Software: Rev 00.303  
 EUT Config: C03  
 EUT S/N: IMEI 004401080149475  
 Battery: Power Supply (external); Maximum Voltage; 4.8 VDC  
 Remark: Channel 810  
 Operator: LOR  
 Testing Site: Radio Laboratory; CETECOM Essen

Mon 26/Nov/2007 13:46:080

Conducted Spurious Emissions V7.1.5

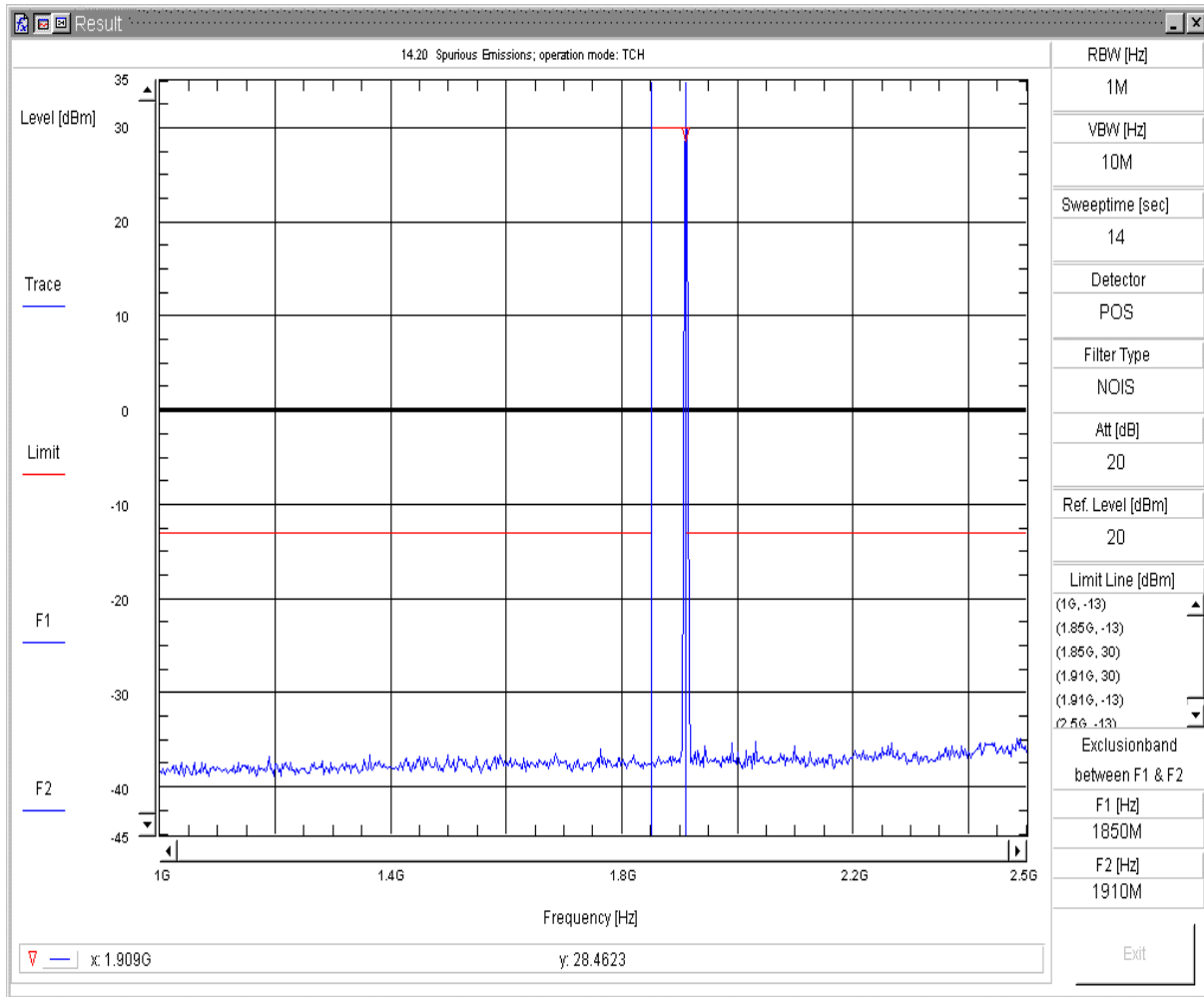

14.20 Conducted Spurious Emission

Transducer: c:\vee\_user\spuri\_V7\conducted\FCC\_Part\_24\_1900\TD\_TX  
 Sweepnr: Sweep2  
 EUT OP Mode: FCC\_Part\_24\_1900 TCH  
 UE Power: 30.0 dBm / 30.0 dBm  
 UE Status: Connection established (observed by operator)  
 EUT Description: MC55i  
 EUT Hardware: B2.1  
 EUT Software: Rev 00.303  
 EUT Config: C03  
 EUT S/N: IMEI 004401080149475  
 Battery: Power Supply (external); Maximum Voltage; 4.8 VDC  
 Remark: Channel 810  
 Operator: LOR  
 Testing Site: Radio Laboratory; CETECOM Essen

Mon 26/Nov/2007 13:48:590

Conducted Spurious Emissions V7.1.5

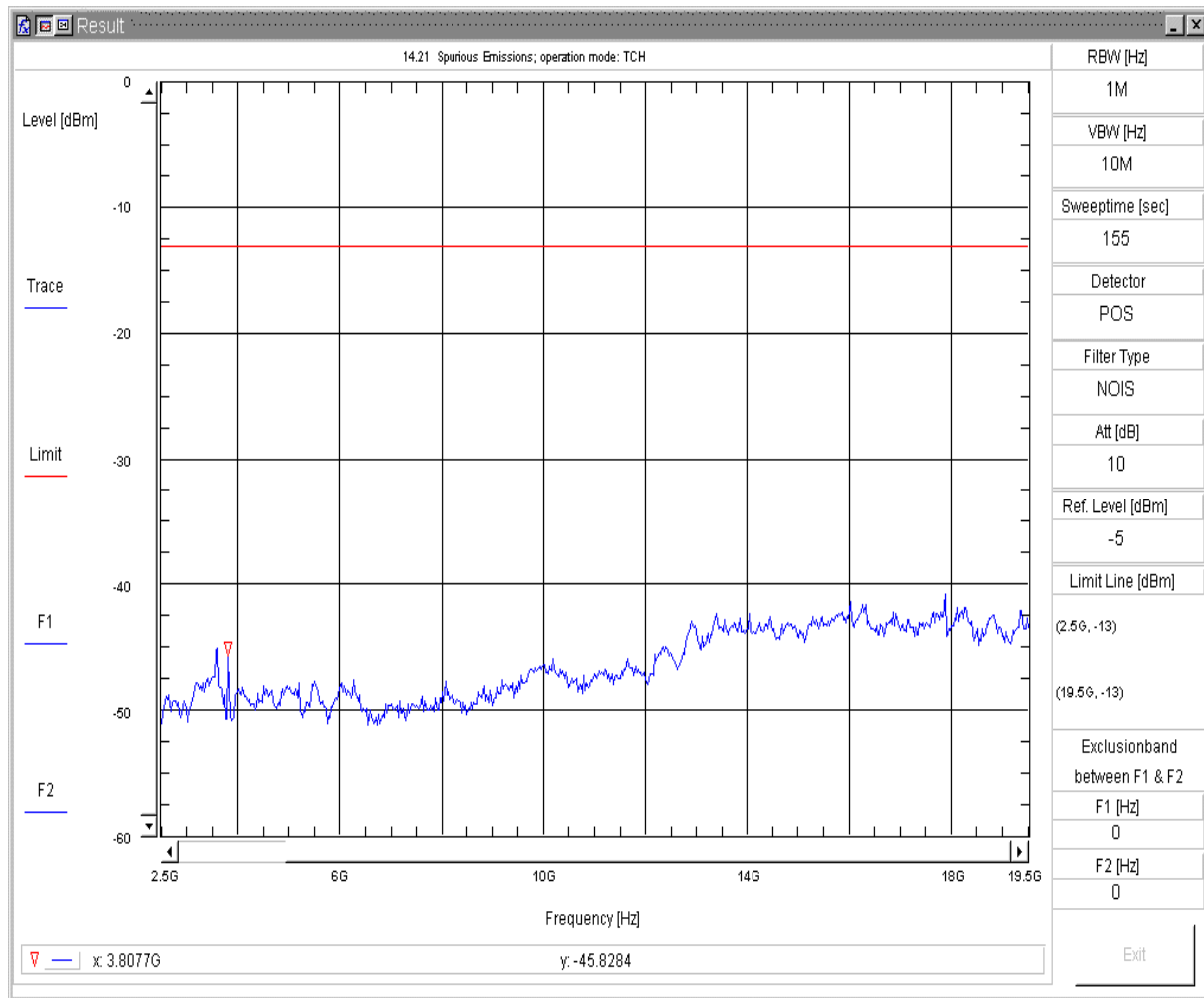

14.21 Conducted Spurious Emission

Transducer: c:\vee\_user\spuri\_V7\conducted\FCC\_Part\_24\_1900\TD\_TX  
 Sweepnr: Sweep3  
 EUT OP Mode: FCC\_Part\_24\_1900 TCH  
 UE Power: 30.0 dBm / 30.0 dBm  
 UE Status: Connection established (observed by operator)  
 EUT Description: MC55i  
 EUT Hardware: B2.1  
 EUT Software: Rev 00.303  
 EUT Config: C03  
 EUT S/N: IMEI 004401080149475  
 Battery: Power Supply (external); Maximum Voltage; 4.8 VDC  
 Remark: -  
 Operator: LOR  
 Testing Site: Radio Laboratory; CETECOM Essen

Mon 26/Nov/2007 13:51:250

Conducted Spurious Emissions V7.1.5

### 9.3.6. Band-Edge Channel 512

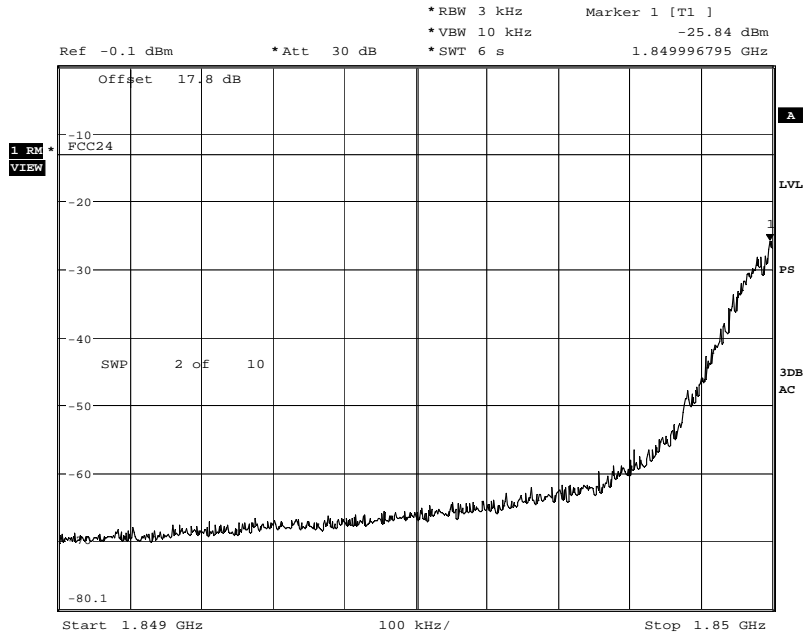

Date: 26.NOV.2007 14:37:42

### 9.3.7. Band-Edge Channel 810

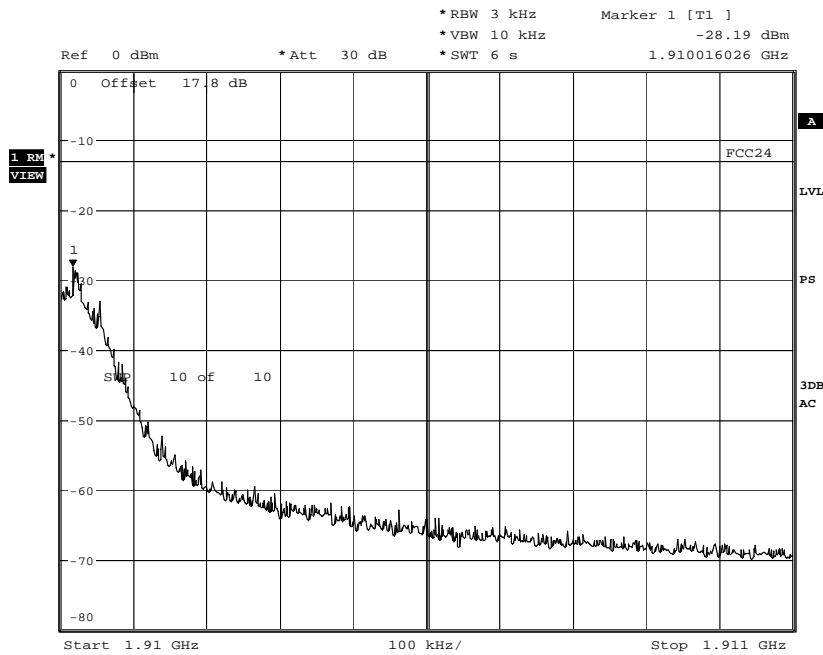

Date: 26.NOV.2007 14:44:28

### 9.3.8. GSM 1900 IDLE MODE

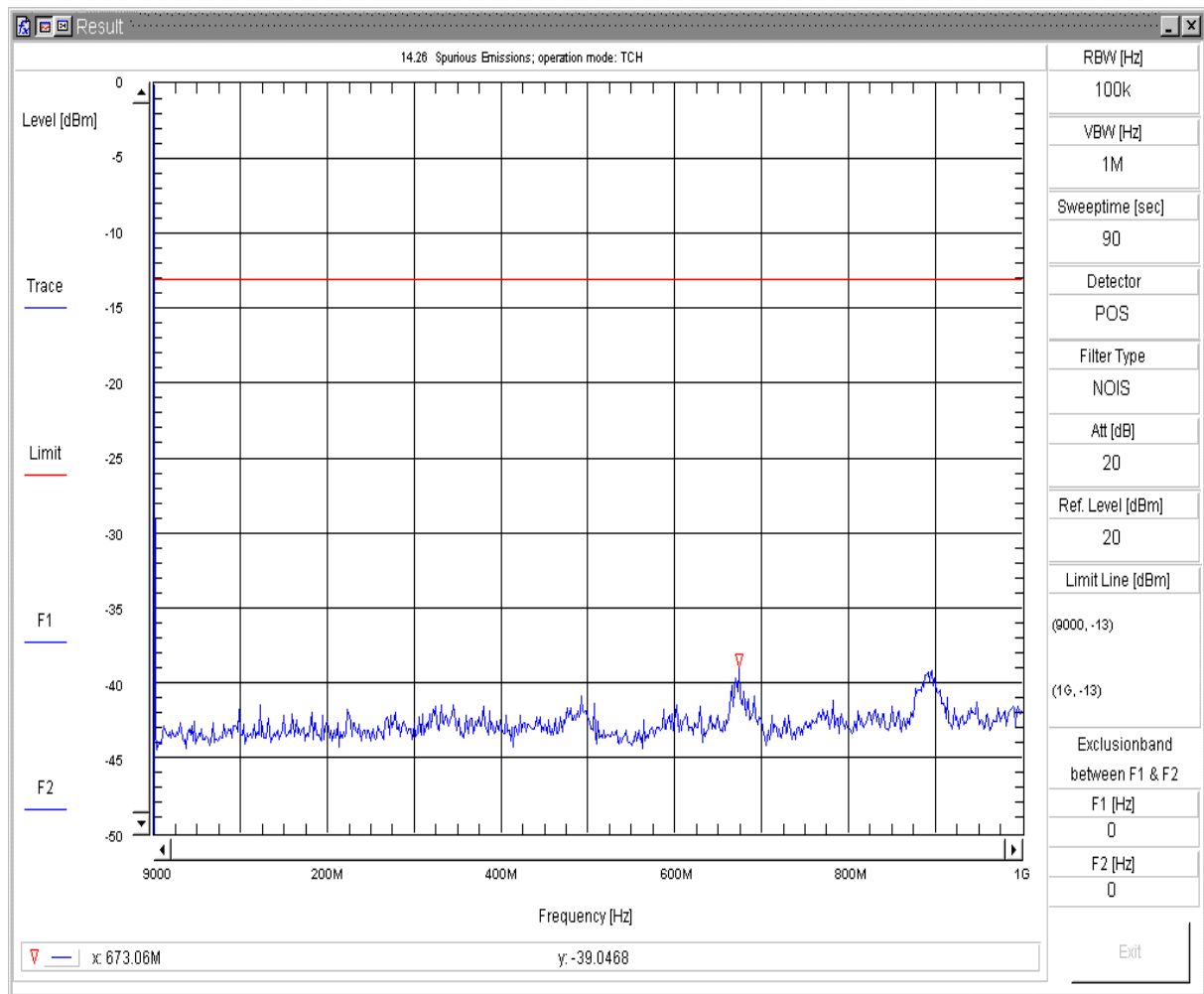

14.26 Conducted Spurious Emission

Transducer: c:\vee\_user\spuri\_V7\conducted\FCC\_Part\_24\_1900\TD\_TX  
 Sweepnr: Sweep1  
 EUT OP Mode: FCC\_Part\_24\_1900 TCH  
 UE Power: 25.1 dBm / 25.1 dBm  
 UE Status: Connection established (observed by operator)  
 EUT Description: MC55i  
 EUT Hardware: B2.1  
 EUT Software:  
 EUT Config: C03  
 EUT S/N: IMEI: 004401080149509  
 Battery: Power Supply (external); Maximum Voltage; 4.8 VDC  
 Remark: Channel 661  
 Operator: LOR  
 Testing Site: Radio Laboratory; CETECOM Essen

Wed 28/Nov/2007 15:32:200

Conducted Spurious Emissions V7.1.5

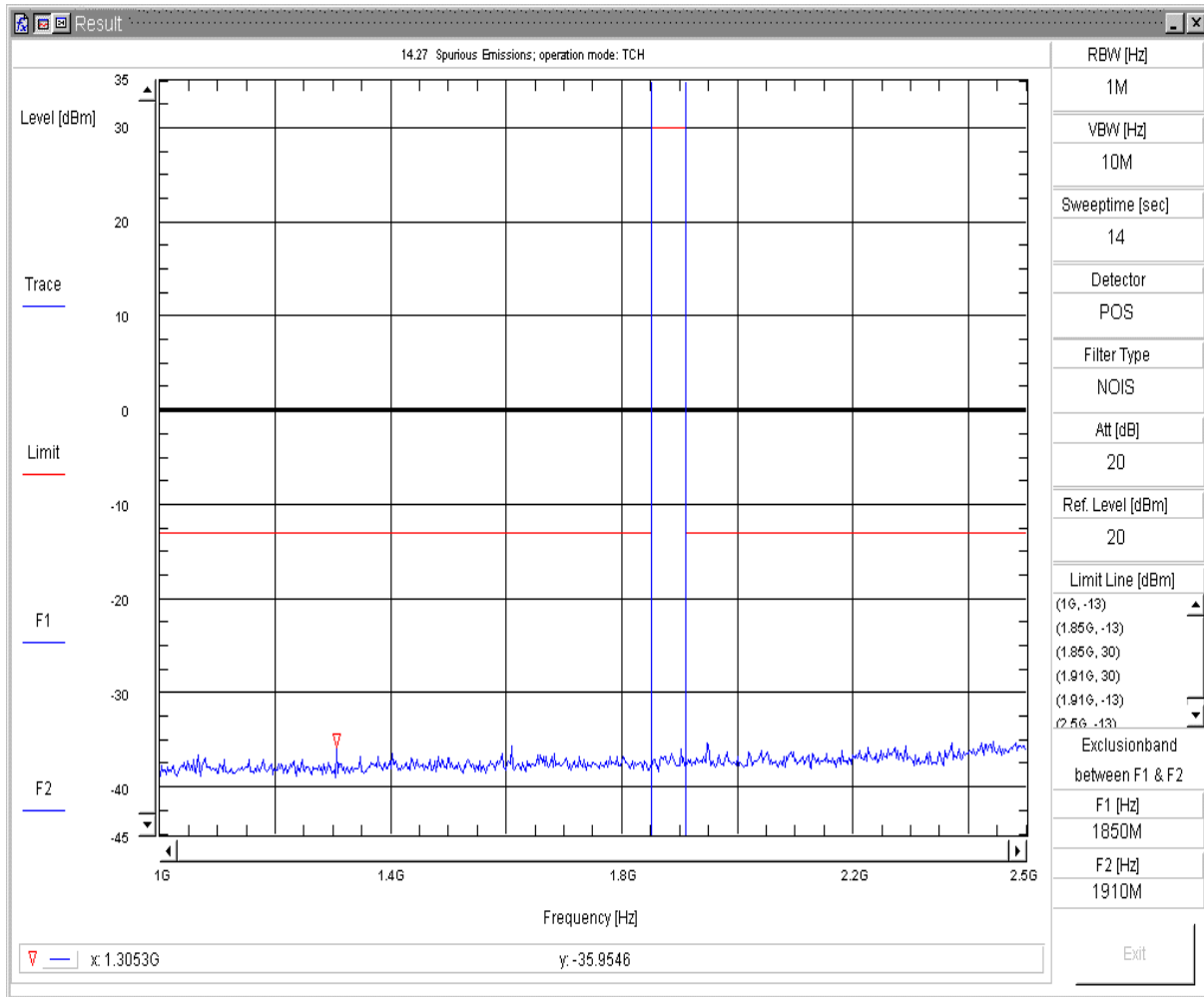

14.27 Conducted Spurious Emission

Transducer: c:\vee\_user\spuri\_V7\conducted\FCC\_Part\_24\_1900\TD\_TX  
 Sweepnr: Sweep2  
 EUT OP Mode: FCC\_Part\_24\_1900 TCH  
 UE Power: 25.1 dBm / 25.1 dBm  
 UE Status: Connection established (observed by operator)  
 EUT Description: MC55i  
 EUT Hardware: B2.1  
 EUT Software:  
 EUT Config: C03  
 EUT S/N: IMEI: 004401080149509  
 Battery: Power Supply (external); Maximum Voltage; 4.8 VDC  
 Remark: Channel 661  
 Operator: LOR  
 Testing Site: Radio Laboratory; CETECOM Essen

Wed 28/Nov/2007 15:35:090

Conducted Spurious Emissions V7.1.5

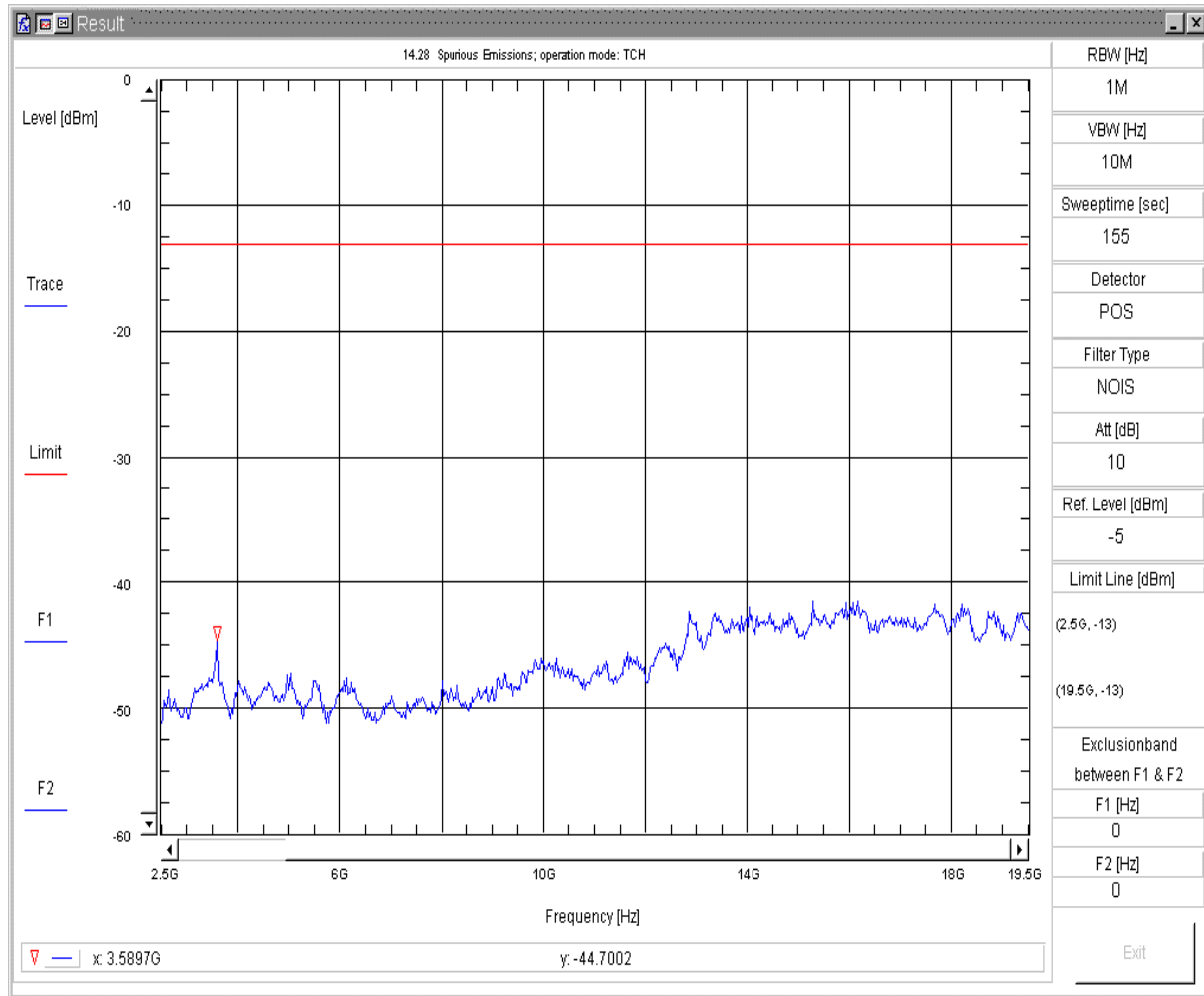

14.28 Conducted Spurious Emission

Transducer: c:\vee\_user\spuri\_V7\conducted\FCC\_Part\_24\_1900\TD\_TX  
 Sweepnr: Sweep3  
 EUT OP Mode: FCC\_Part\_24\_1900 TCH  
 UE Power: 25.1 dBm / 25.1 dBm  
 UE Status: Connection established (observed by operator)  
 EUT Description: MC55i  
 EUT Hardware: B2.1  
 EUT Software:  
 EUT Config: C03  
 EUT S/N: IMEI: 004401080149509  
 Battery: Power Supply (external); Maximum Voltage; 4.8 VDC  
 Remark: Channel 661  
 Operator: LOR  
 Testing Site: Radio Laboratory; CETECOM Essen

Wed 28/Nov/2007 15:36:320

Conducted Spurious Emissions V7.1.5



## 9.4. RADIATED SPURIOUS EMISSIONS

### 9.4.1. GSM 850 MODE

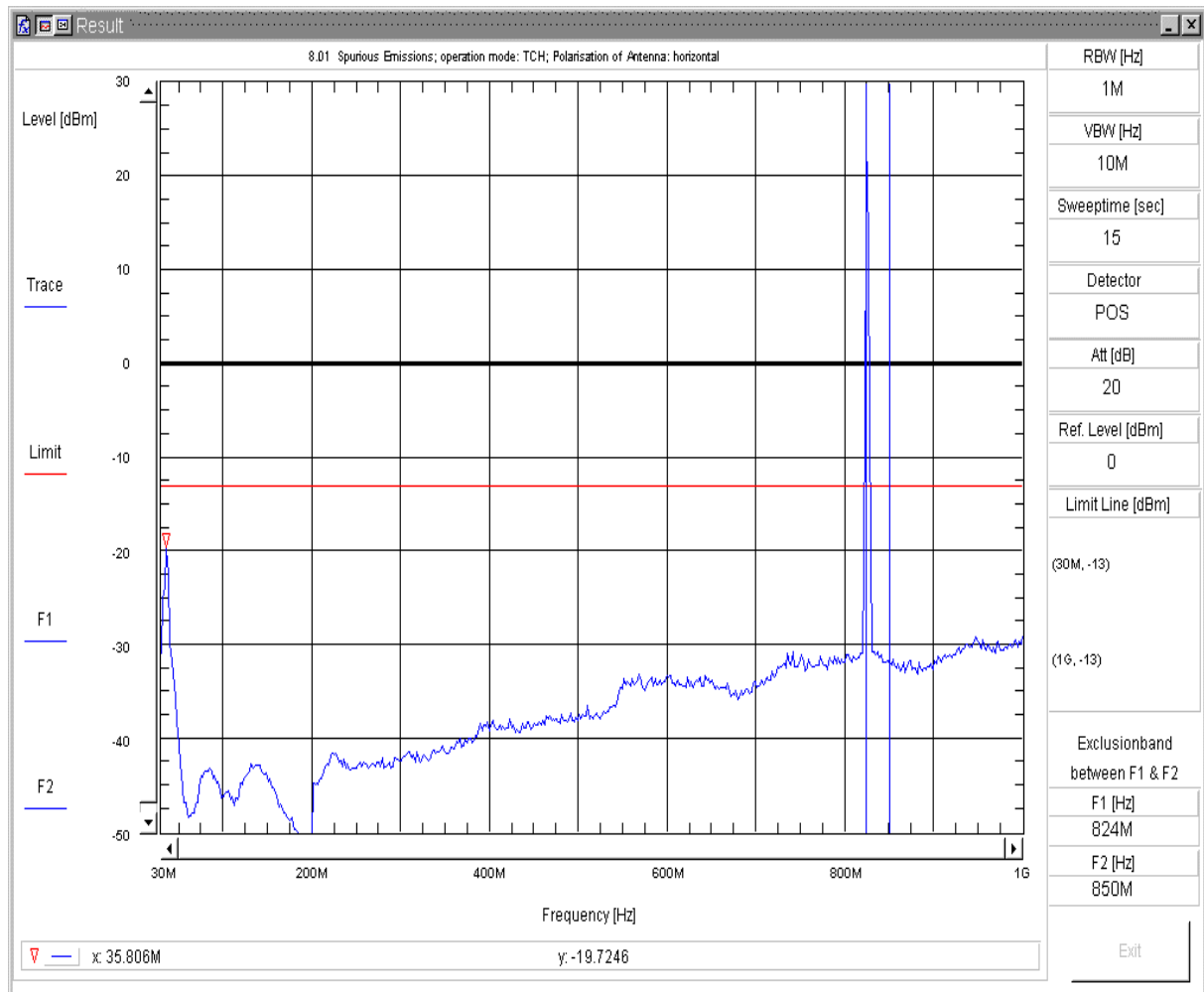

8.01 Radiated Spurious Emission

Transducer: c:\vee\_user\spuri\_V7\FCC\_Part22\_850\TD\_TX\_H  
 Sweepnr: Sweep1  
 Pol. of Antenna: horizontal  
 EUT Position: EUT\_vertical+horizontal  
 EUT OP Mode: FCC\_Part22\_850 TCH  
 EUT Description: MC55i + Board + Headset, Project 040194  
 EUT Hardware: B2.1  
 EUT Software: Rev. 00.303  
 EUT Config: C03  
 EUT S/N: IMEI: 004401080149475  
 Battery: Power Supply (external); Maximum Voltage; 4.8 VDC  
 Remark: Channel 128  
 Operator: Lor  
 Testing Site: Fully Anechoic Room (FAR); CETECOM Essen

Tue 20/Nov/2007 13:49:23pff

Spurious Emissions V7.1.1

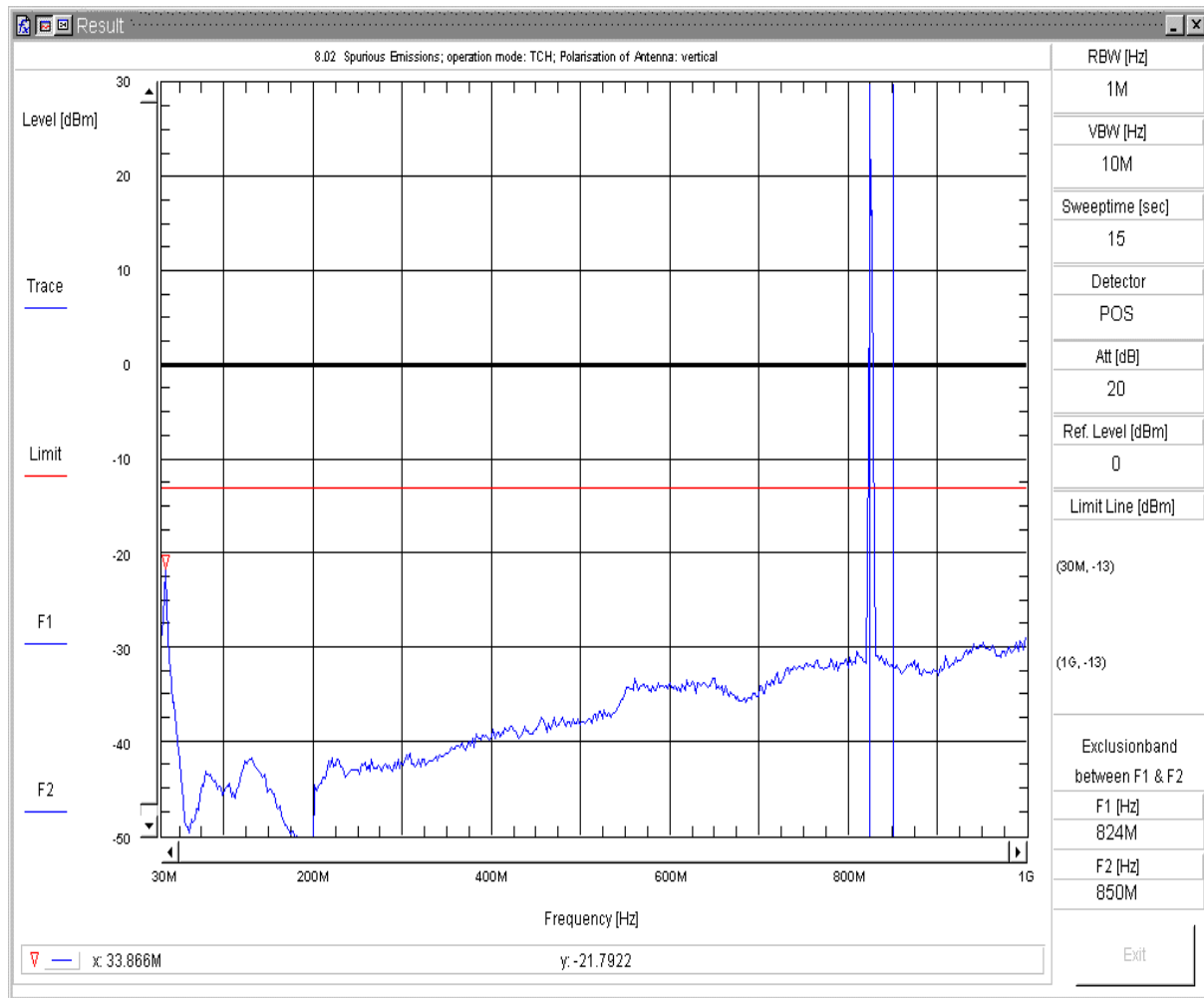

8.02 Radiated Spurious Emission

Transducer: c:\vee\_user\spuri\_V7\FCC\_Part22\_850\TD\_TX\_V  
 Sweepnr: Sweep1  
 Pol. of Antenna: vertikal  
 EUT Position: EUT\_vertical+horizontal  
 EUT OP Mode: FCC\_Part22\_850 TCH  
 EUT Description: MC55i + Board + Headset, Project 040194  
 EUT Hardware: B2.1  
 EUT Software: Rev. 00.303  
 EUT Config: C03  
 EUT S/N: IMEI: 004401080149475  
 Battery: Power Supply (external); Maximum Voltage; 4.8 VDC  
 Remark: Channel 128  
 Operator: Lor  
 Testing Site: Fully Anechoic Room (FAR); CETECOM Essen

Tue 20/Nov/2007 13:53:50ppf

Spurious Emissions V7.1.1

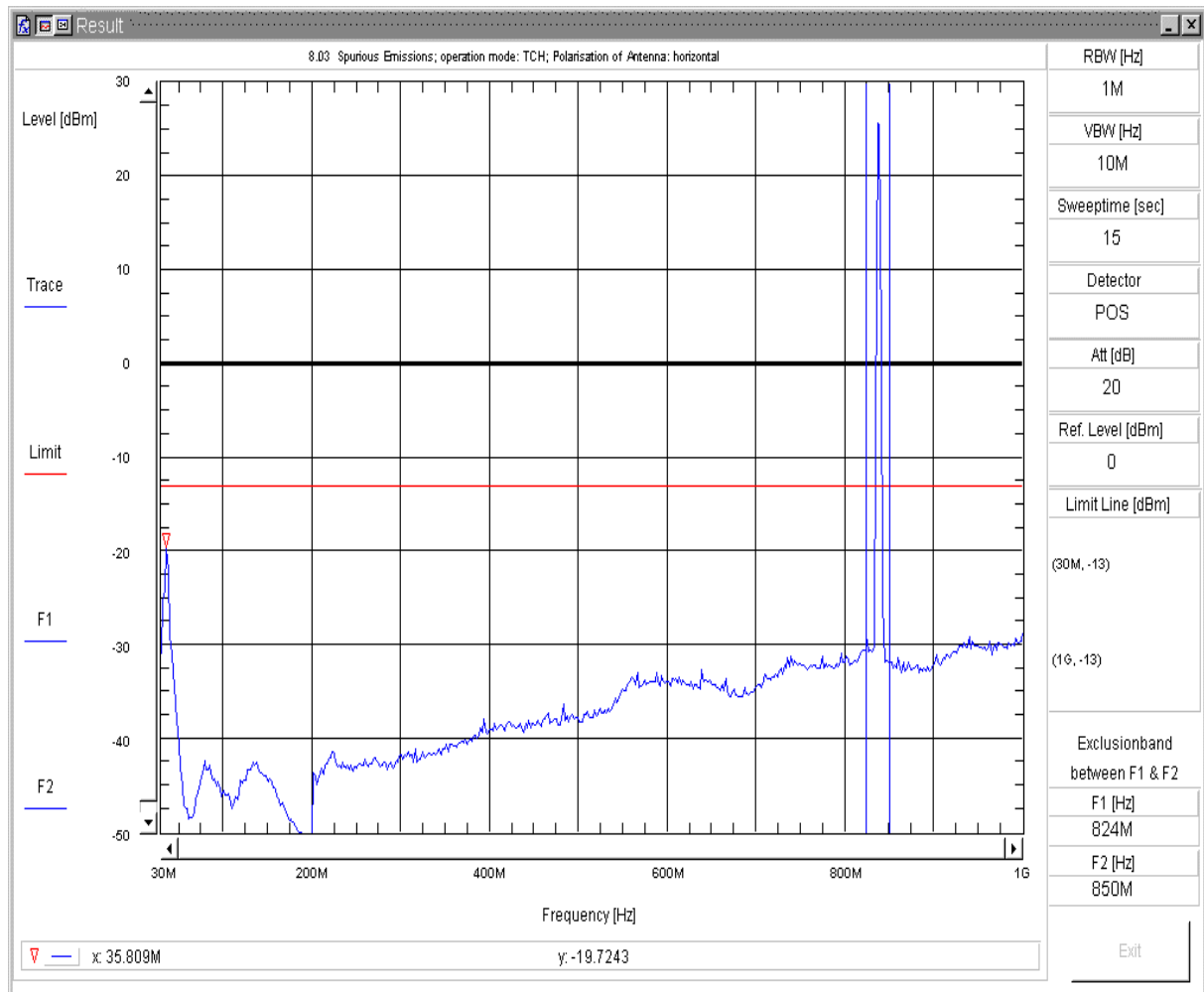

### 8.03 Radiated Spurious Emission

Transducer: c:\vee\_user\spuri\_V7\FCC\_Part22\_850\TD\_TX\_H  
 Sweepnr: Sweep1  
 Pol. of Antenna: horizontal  
 EUT Position: EUT\_vertical+horizontal  
 EUT OP Mode: FCC\_Part22\_850 TCH  
 EUT Description: MC55i + Board + Headset, Project 040194  
 EUT Hardware: B2.1  
 EUT Software: Rev. 00.303  
 EUT Config: C03  
 EUT S/N: IMEI: 004401080149475  
 Battery: Power Supply (external); Maximum Voltage; 4.8 VDC  
 Remark: Channel 192  
 Operator: Lor  
 Testing Site: Fully Anechoic Room (FAR); CETECOM Essen

Tue 20/Nov/2007 13:58:16ppf

Spurious Emissions V7.1.1

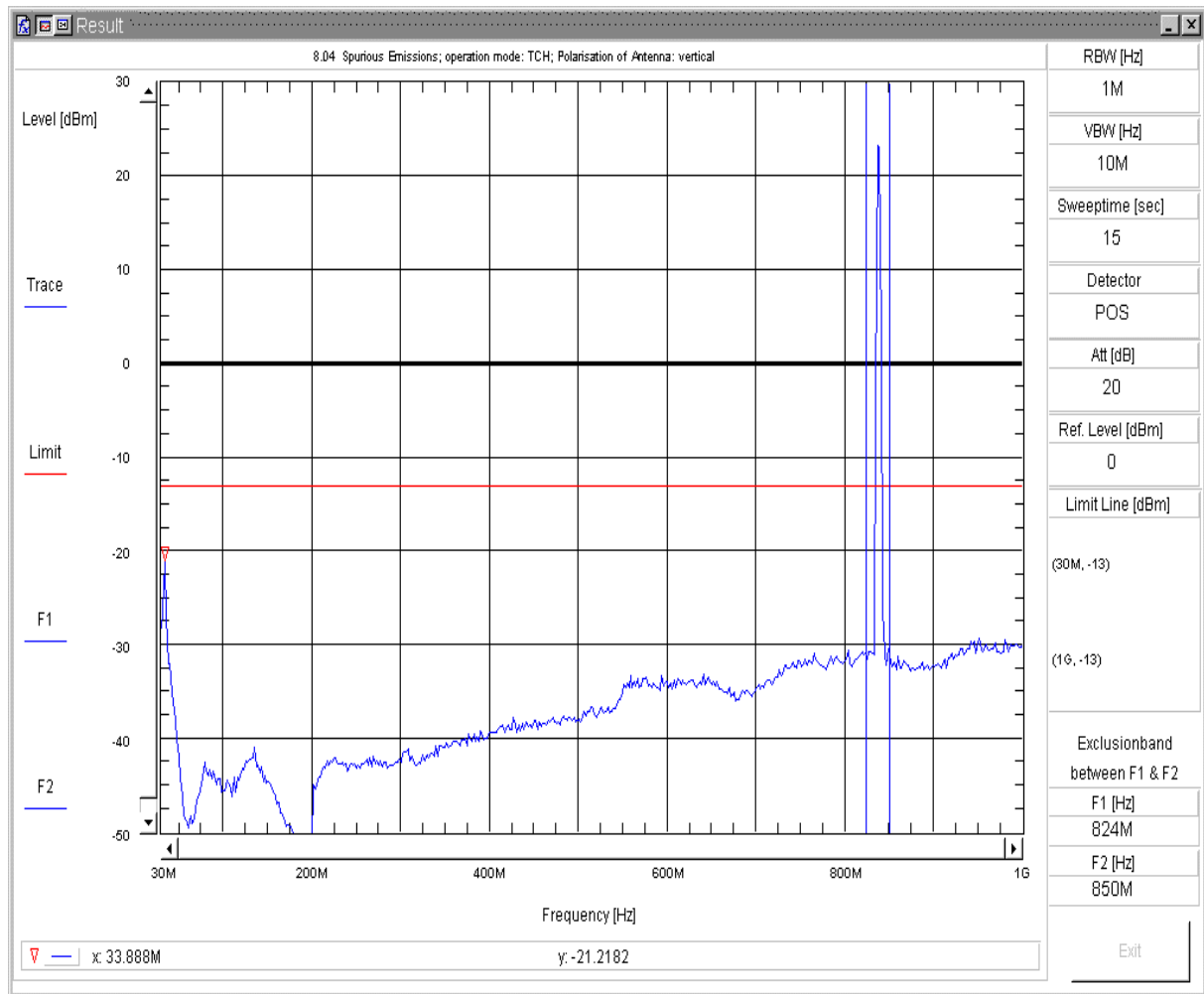

#### 8.04 Radiated Spurious Emission

Transducer: c:\vee\_user\spuri\_V7\FCC\_Part22\_850\TD\_TX\_V  
 Sweepnr: Sweep1  
 Pol. of Antenna: vertikal  
 EUT Position: EUT\_vertical+horizontal  
 EUT OP Mode: FCC\_Part22\_850 TCH  
 EUT Description: MC55i + Board + Headset, Project 040194  
 EUT Hardware: B2.1  
 EUT Software: Rev. 00.303  
 EUT Config: C03  
 EUT S/N: IMEI: 004401080149475  
 Battery: Power Supply (external); Maximum Voltage; 4.8 VDC  
 Remark: Channel 192  
 Operator: Lor  
 Testing Site: Fully Anechoic Room (FAR); CETECOM Essen

Tue 20/Nov/2007 14:04:56ppf

Spurious Emissions V7.1.1

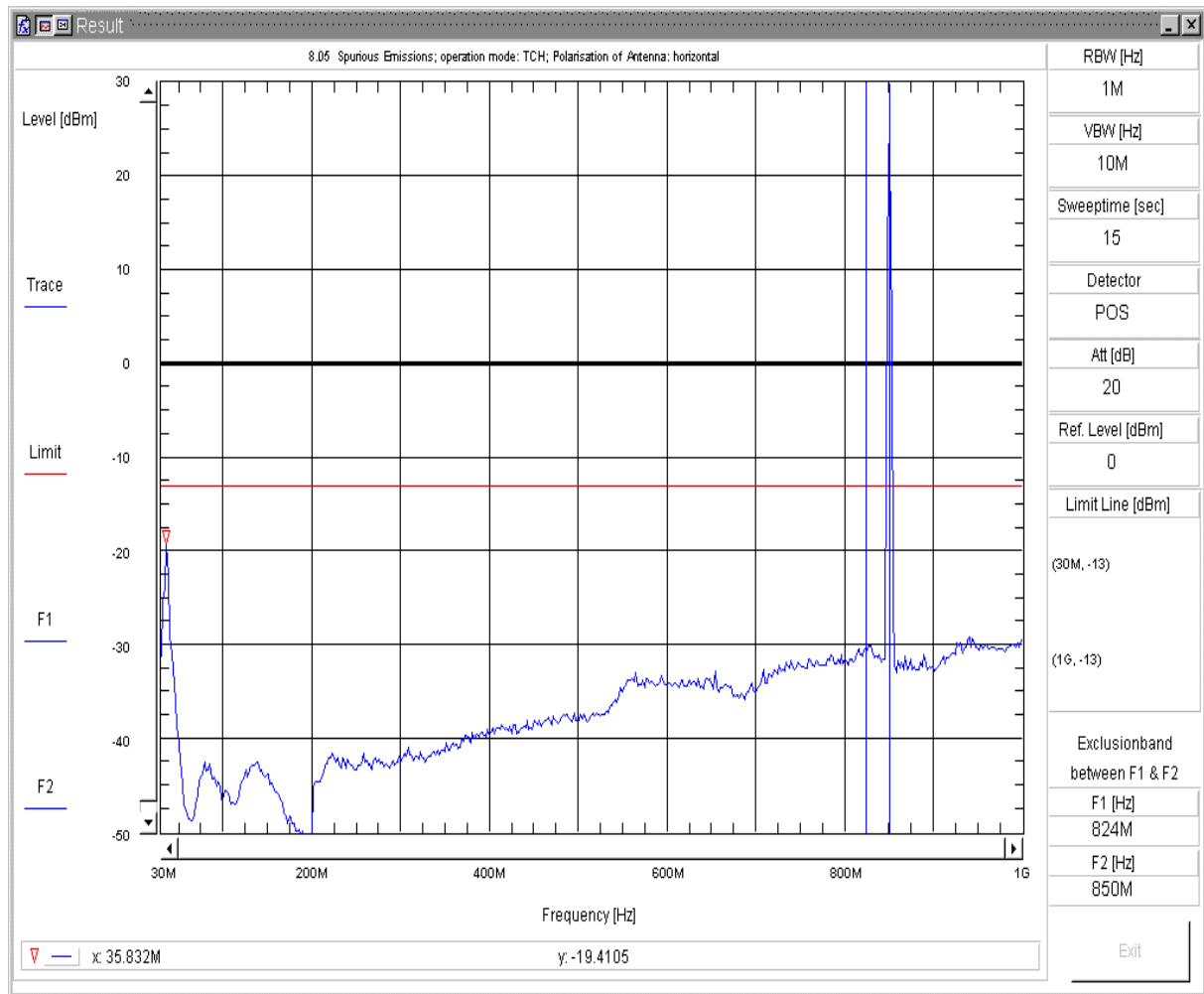

### 8.05 Radiated Spurious Emission

Transducer: c:\vee\_user\spuri\_V7\FCC\_Part22\_850\TD\_TX\_H  
 Sweepnr: Sweep1  
 Pol. of Antenna: horizontal  
 EUT Position: EUT\_vertical+horizontal  
 EUT OP Mode: FCC\_Part22\_850 TCH  
 EUT Description: MC55i + Board + Headset, Project 040194  
 EUT Hardware: B2.1  
 EUT Software: Rev. 00.303  
 EUT Config: C03  
 EUT S/N: IMEI: 004401080149475  
 Battery: Power Supply (external); Maximum Voltage; 4.8 VDC  
 Remark: Channel 251  
 Operator: Lor  
 Testing Site: Fully Anechoic Room (FAR); CETECOM Essen

Tue 20/Nov/2007 14:09:02ppf

Spurious Emissions V7.1.1

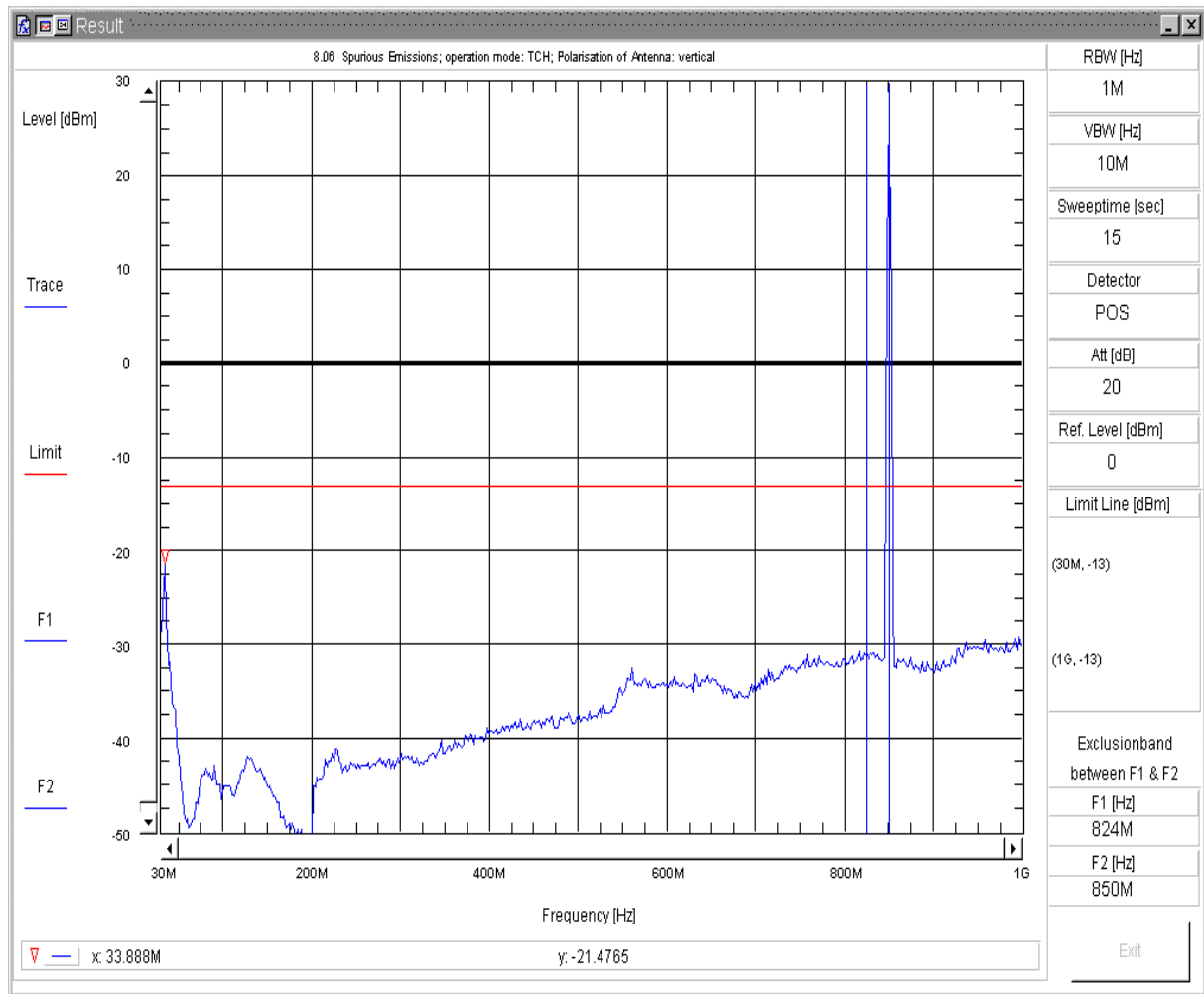

### 8.06 Radiated Spurious Emission

Transducer: c:\vee\_user\spuri\_V7\FCC\_Part22\_850\TD\_TX\_V  
 Sweepnr: Sweep1  
 Pol. of Antenna: vertikal  
 EUT Position: EUT\_vertical+horizontal  
 EUT OP Mode: FCC\_Part22\_850 TCH  
 EUT Description: MC55i + Board + Headset, Project 040194  
 EUT Hardware: B2.1  
 EUT Software: Rev. 00.303  
 EUT Config: C03  
 EUT S/N: IMEI: 004401080149475  
 Battery: Power Supply (external); Maximum Voltage; 4.8 VDC  
 Remark: Channel 251  
 Operator: Lor  
 Testing Site: Fully Anechoic Room (FAR); CETECOM Essen

Tue 20/Nov/2007 14:12:49ppf

Spurious Emissions V7.1.1

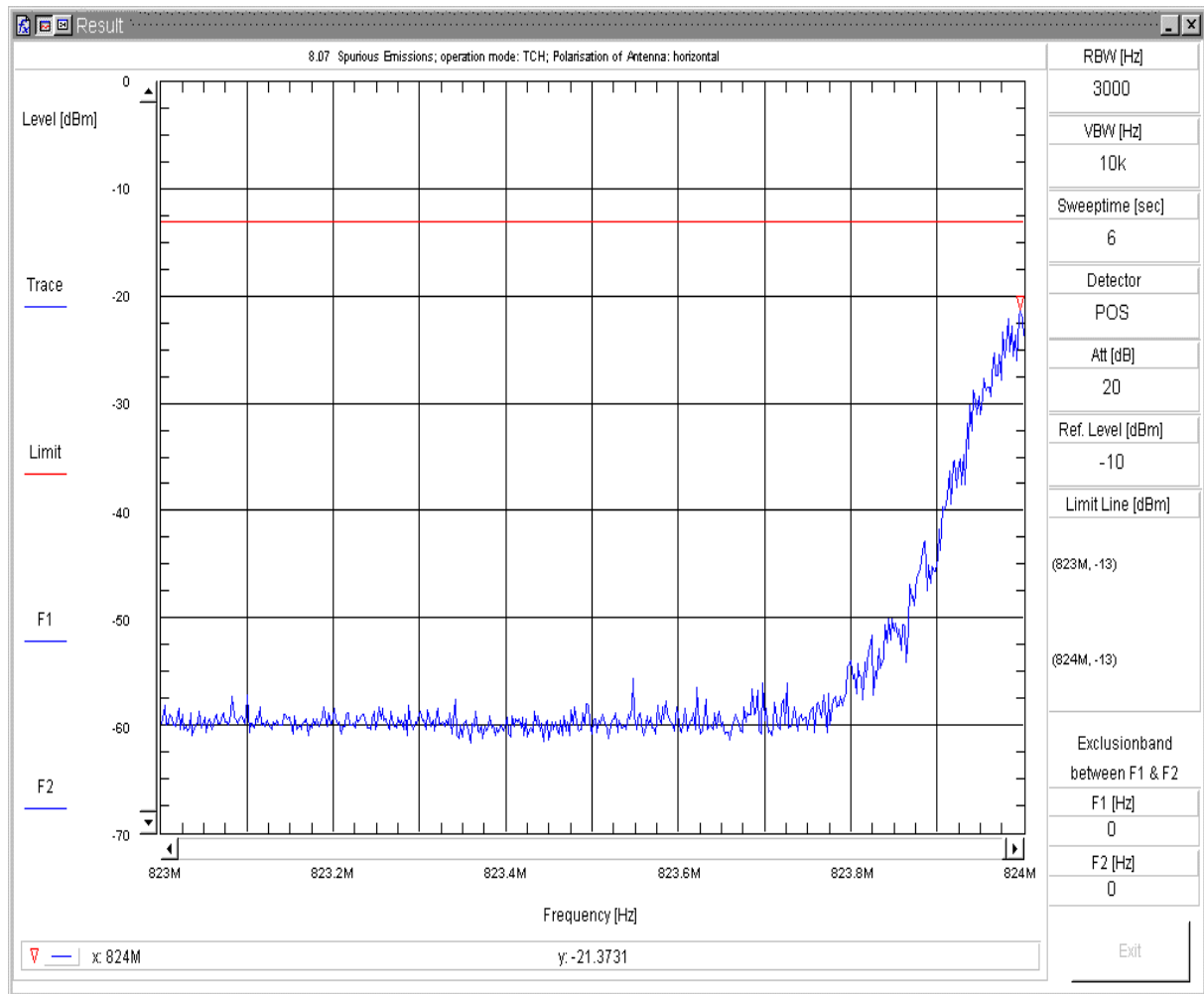

### 8.07 Radiated Spurious Emission

Transducer: c:\vee\_user\spuri\_V7\FCC\_Part22\_850\TD\_TX\_H  
 Sweepnr: Sweep2  
 Pol. of Antenna: horizontal  
 EUT Position: EUT\_vertical+horizontal  
 EUT OP Mode: FCC\_Part22\_850 TCH  
 EUT Description: MC55i + Board + Headset, Project 040194  
 EUT Hardware: B2.1  
 EUT Software: Rev. 00.303  
 EUT Config: C03  
 EUT S/N: IMEI: 004401080149475  
 Battery: Power Supply (external); Maximum Voltage; 4.8 VDC  
 Remark: Channel 128  
 Operator: Lor  
 Testing Site: Fully Anechoic Room (FAR); CETECOM Essen

Tue 20/Nov/2007 14:16:57ppf

Spurious Emissions V7.1.1

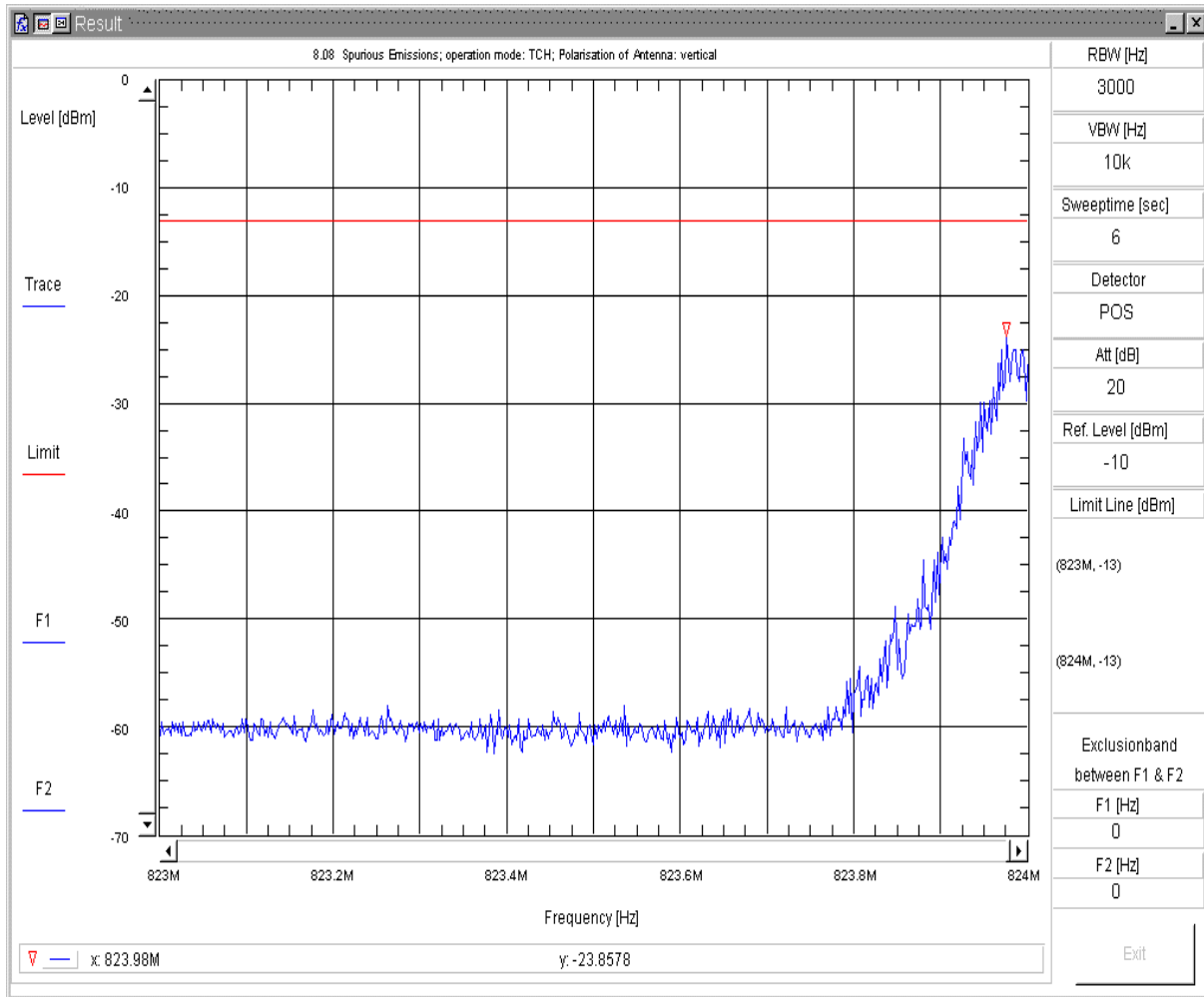

8.08 Radiated Spurious Emission

Transducer: c:\vee\_user\spuri\_V7\FCC\_Part22\_850\TD\_TX\_V  
 Sweepnr: Sweep2  
 Pol. of Antenna: vertikal  
 EUT Position: EUT\_vertical+horizontal  
 EUT OP Mode: FCC\_Part22\_850 TCH  
 EUT Description: MC55i + Board + Headset, Project 040194  
 EUT Hardware: B2.1  
 EUT Software: Rev. 00.303  
 EUT Config: C03  
 EUT S/N: IMEI: 004401080149475  
 Battery: Power Supply (external); Maximum Voltage; 4.8 VDC  
 Remark: Channel 128  
 Operator: Lor  
 Testing Site: Fully Anechoic Room (FAR); CETECOM Essen

Tue 20/Nov/2007 14:20:08ppf

Spurious Emissions V7.1.1



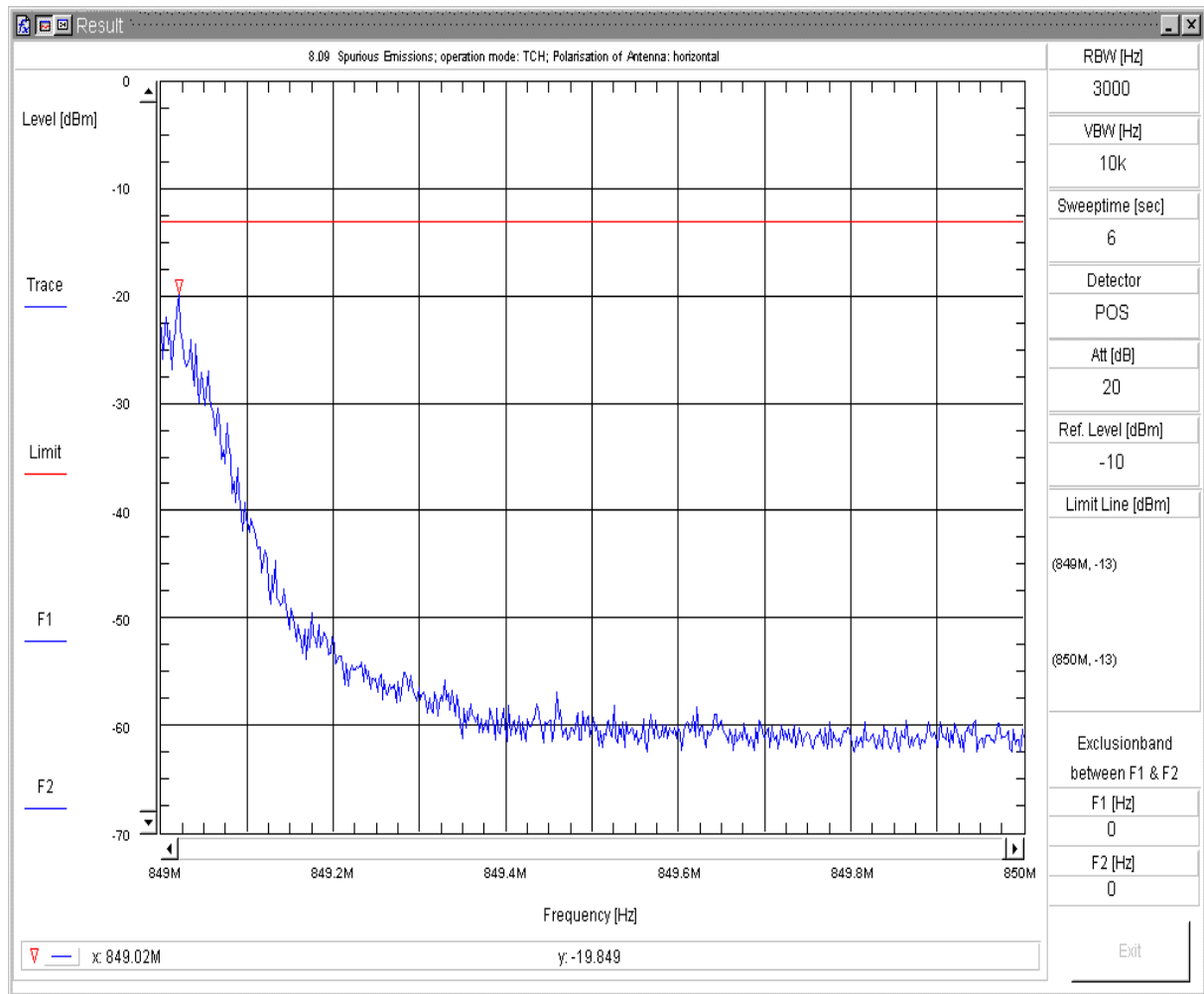

### 8.09 Radiated Spurious Emission

Transducer: c:\vee\_user\spuri\_V7\FCC\_Part22\_850\TD\_TX\_H  
 Sweepnr: Sweep3  
 Pol. of Antenna: horizontal  
 EUT Position: EUT\_vertical+horizontal  
 EUT OP Mode: FCC\_Part22\_850 TCH  
 EUT Description: MC55i + Board + Headset, Project 040194  
 EUT Hardware: B2.1  
 EUT Software: Rev. 00.303  
 EUT Config: C03  
 EUT S/N: IMEI: 004401080149475  
 Battery: Power Supply (external); Maximum Voltage; 4.8 VDC  
 Remark: Channel 251  
 Operator: Lor  
 Testing Site: Fully Anechoic Room (FAR); CETECOM Essen

Tue 20/Nov/2007 14:23:29ppf

Spurious Emissions V7.1.1

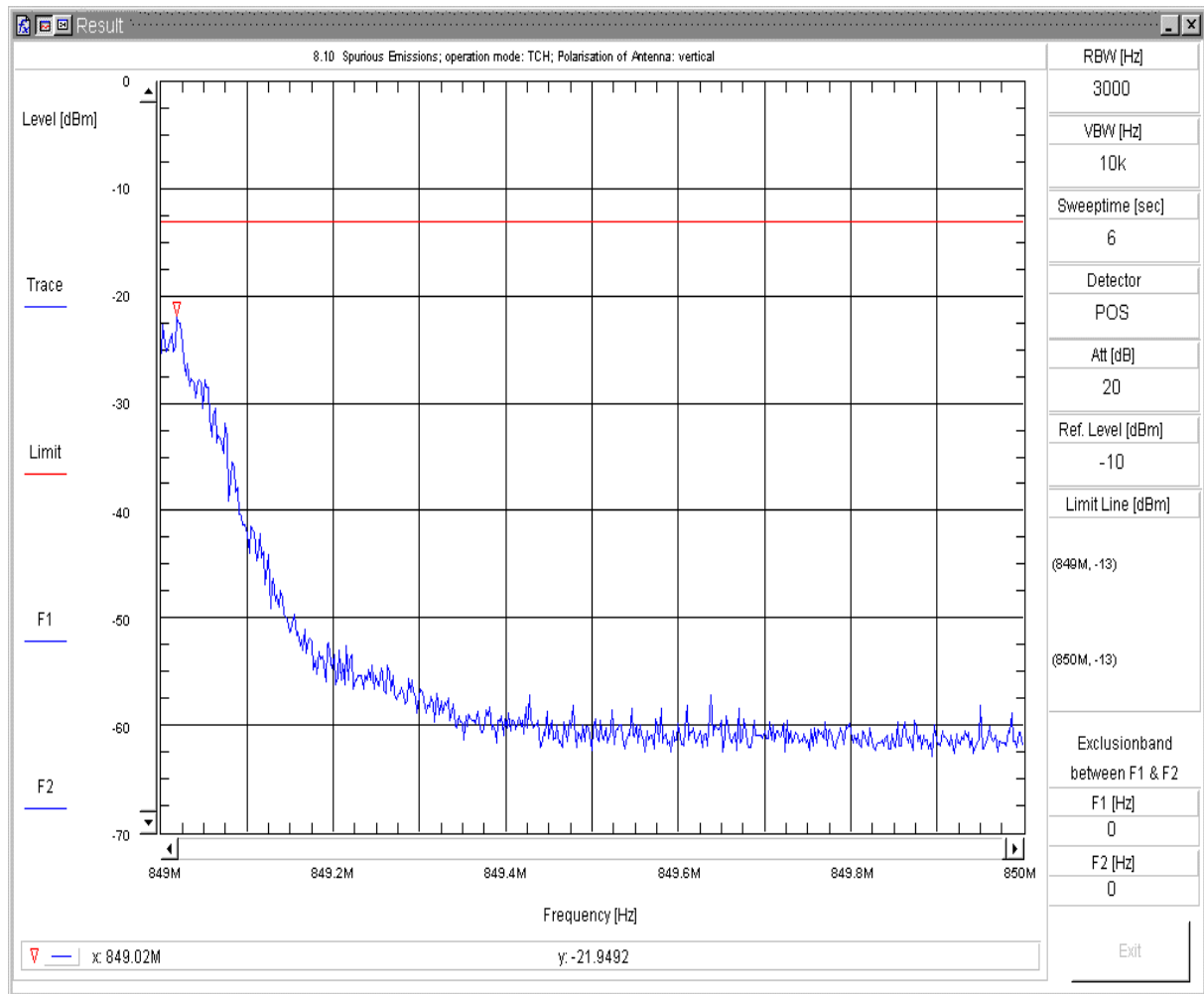

### 8.10 Radiated Spurious Emission

Transducer: c:\vee\_user\spuri\_V7\FCC\_Part22\_850\TD\_TX\_V  
 Sweepnr: Sweep3  
 Pol. of Antenna: vertikal  
 EUT Position: EUT\_vertical+horizontal  
 EUT OP Mode: FCC\_Part22\_850 TCH  
 EUT Description: MC55i + Board + Headset, Project 040194  
 EUT Hardware: B2.1  
 EUT Software: Rev. 00.303  
 EUT Config: C03  
 EUT S/N: IMEI: 004401080149475  
 Battery: Power Supply (external); Maximum Voltage; 4.8 VDC  
 Remark: Channel 251  
 Operator: Lor  
 Testing Site: Fully Anechoic Room (FAR); CETECOM Essen

Tue 20/Nov/2007 14:26:27ppf

Spurious Emissions V7.1.1

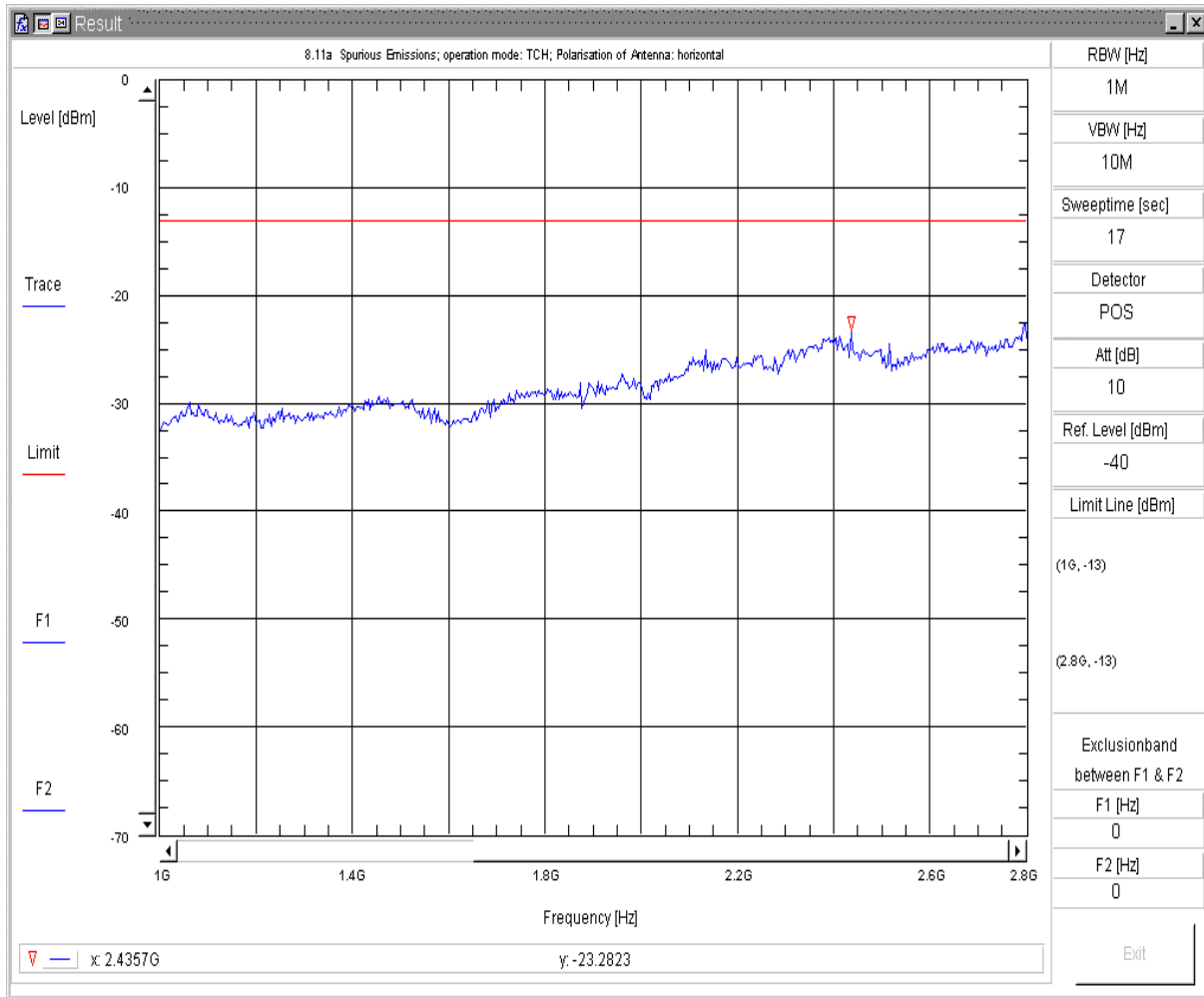

8.11a Radiated Spurious Emission

Transducer: c:\vee\_user\spuri\_V7\FCC\_Part22\_850\TD\_TX\_H  
 Sweepnr: Sweep4  
 Pol. of Antenna: horizontal  
 EUT Position: EUT\_vertical+horizontal  
 EUT OP Mode: FCC\_Part22\_850 TCH  
 EUT Description: MC55i + Board + Handset  
 EUT Hardware: B2.1  
 EUT Software: Rev. 00.303  
 EUT Config: C03  
 EUT S/N: IMEI: 004401080149475  
 Battery: AC/DC Charger; Maximum Voltage; 4.8 VDC  
 Remark: Channel 128  
 Operator: x\_Fto  
 Testing Site: Fully Anechoic Room (FAR); CETECOM Essen

Wed 28/Nov/2007 15:12:19fp

Spurious Emissions V7.1.1

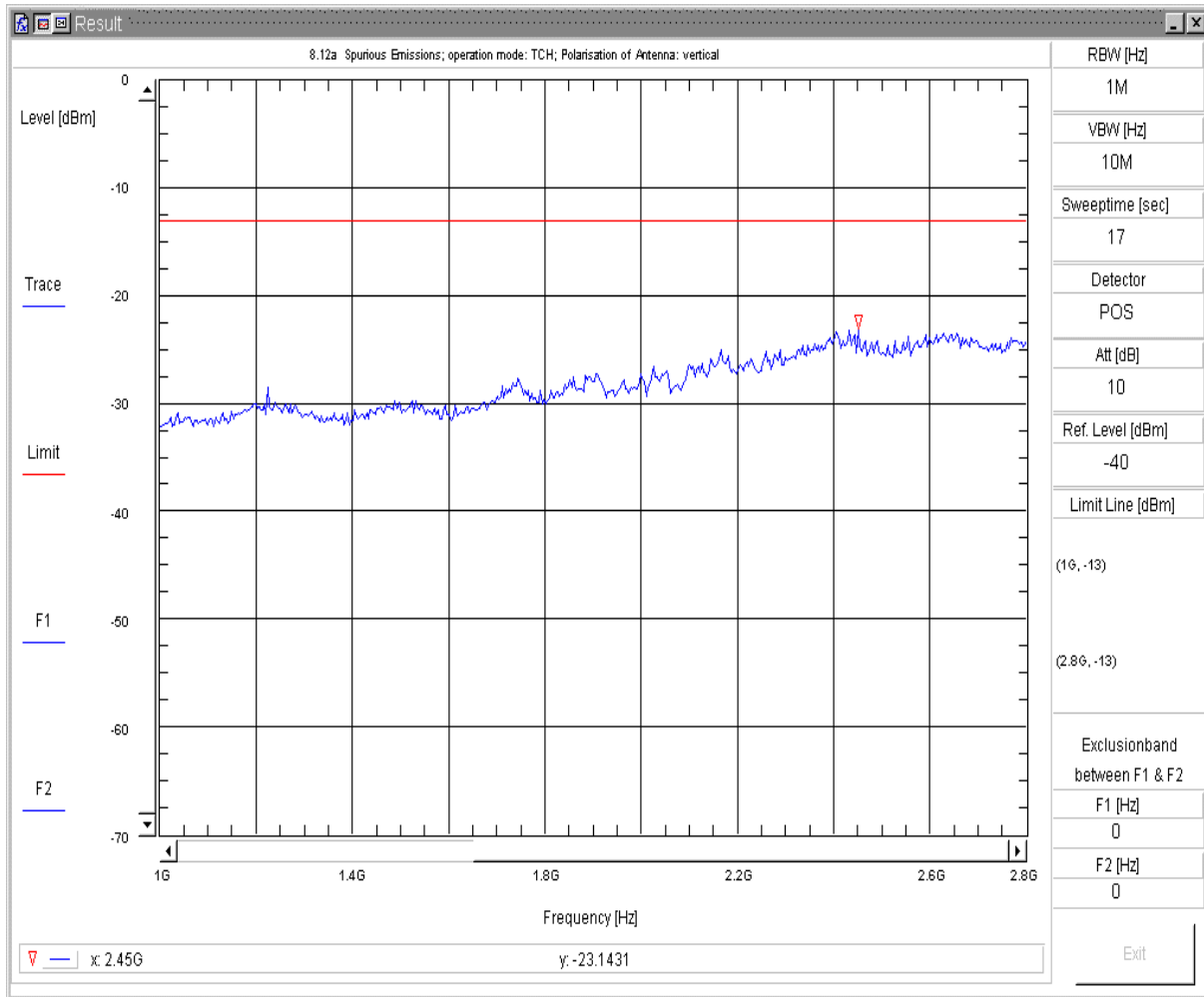

8.12a Radiated Spurious Emission

Transducer: c:\vee\_user\spuri\_V7\FCC\_Part22\_850\TD\_TX\_V  
 Sweepnr: Sweep4  
 Pol. of Antenna: vertikal  
 EUT Position: EUT\_vertikal+horizontal  
 EUT OP Mode: FCC\_Part22\_850 TCH  
 EUT Description: MC55i + Board + Handset  
 EUT Hardware: B2.1  
 EUT Software: Rev. 00.303  
 EUT Config: C03  
 EUT S/N: IMEI: 004401080149475  
 Battery: AC/DC Charger; Maximum Voltage; 4.8 VDC  
 Remark: Channel 128  
 Operator: x\_Fto  
 Testing Site: Fully Anechoic Room (FAR); CETECOM Essen

Wed 28/Nov/2007 15:20:08pp

Spurious Emissions V7.1.1

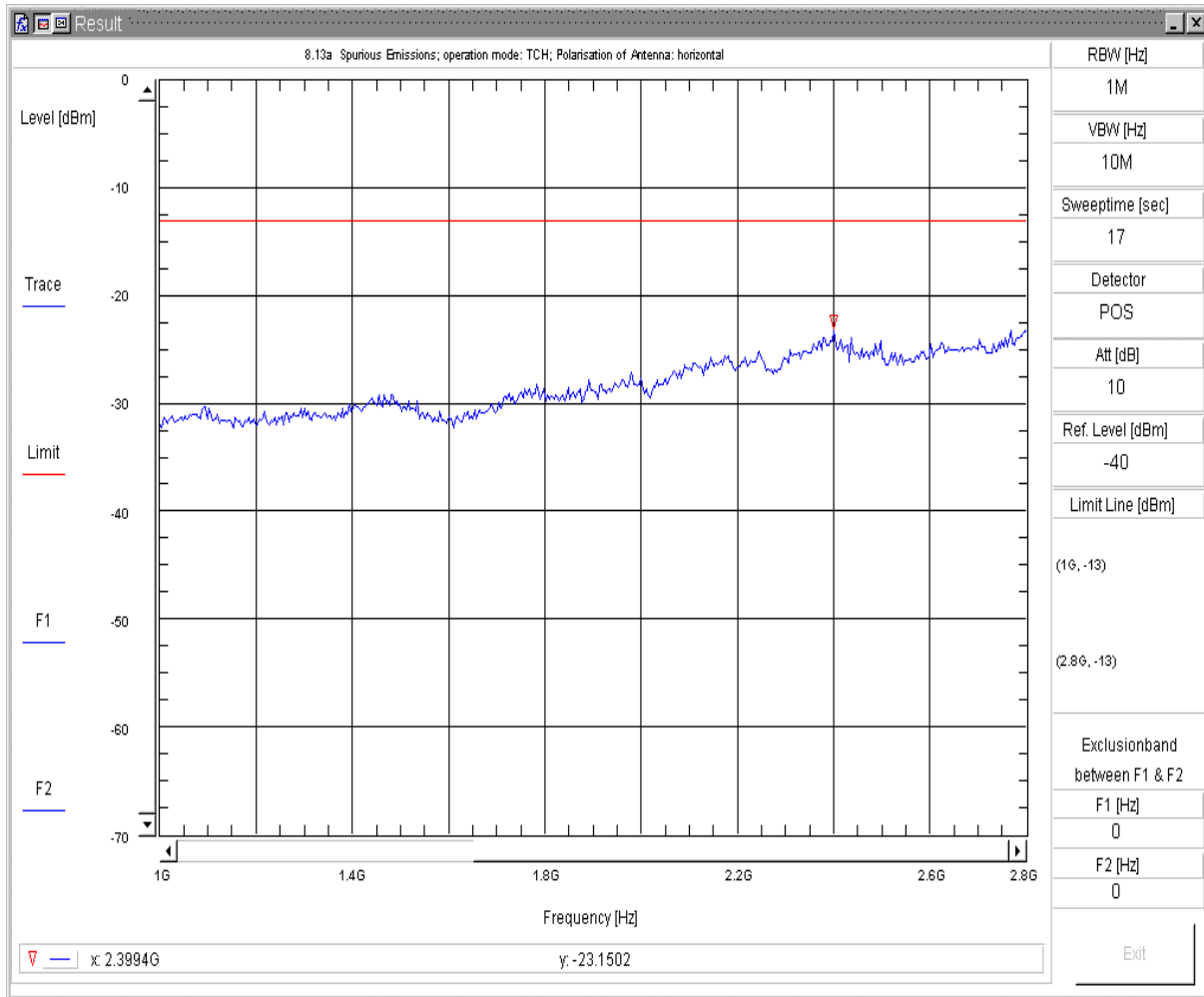

8.13a Radiated Spurious Emission

Transducer: c:\vee\_user\spuri\_V7\FCC\_Part22\_850\TD\_TX\_H  
 Sweepnr: Sweep4  
 Pol. of Antenna: horizontal  
 EUT Position: EUT\_vertical+horizontal  
 EUT OP Mode: FCC\_Part22\_850 TCH  
 EUT Description: MC55i + Board + Handset  
 EUT Hardware: B2.1  
 EUT Software: Rev. 00.303  
 EUT Config: C03  
 EUT S/N: IMEI: 004401080149475  
 Battery: AC/DC Charger; Maximum Voltage; 4.8 VDC  
 Remark: Channel 192  
 Operator: x\_Fto  
 Testing Site: Fully Anechoic Room (FAR); CETECOM Essen

Wed 28/Nov/2007 15:30:07fp

Spurious Emissions V7.1.1

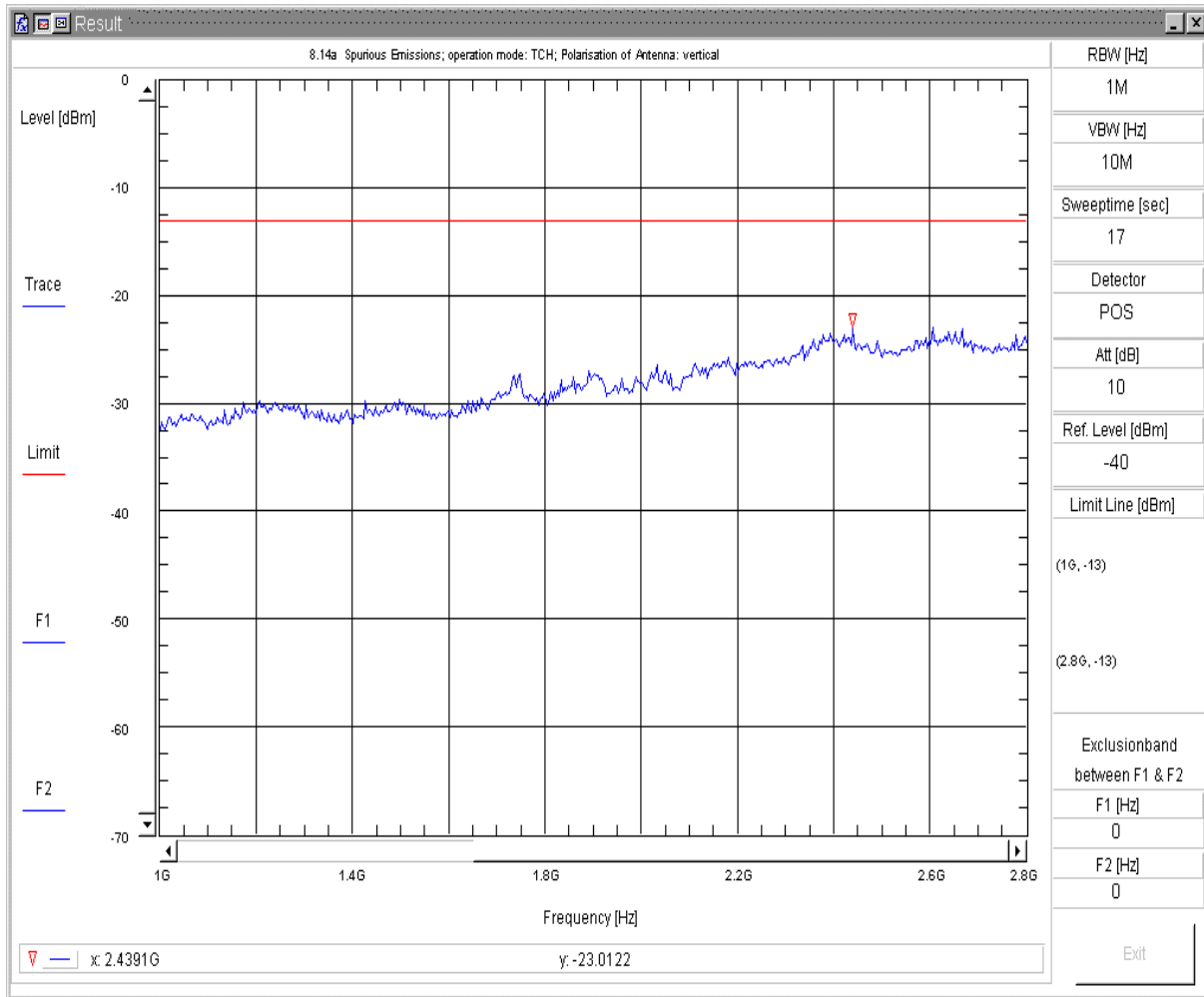

8.14a Radiated Spurious Emission

Transducer: c:\vee\_user\spuri\_V7\FCC\_Part22\_850\TD\_TX\_V  
 Sweepnr: Sweep4  
 Pol. of Antenna: vertikal  
 EUT Position: EUT\_vertikal+horizontal  
 EUT OP Mode: FCC\_Part22\_850 TCH  
 EUT Description: MC55i + Board + Handset  
 EUT Hardware: B2.1  
 EUT Software: Rev. 00.303  
 EUT Config: C03  
 EUT S/N: IMEI: 004401080149475  
 Battery: AC/DC Charger; Maximum Voltage; 4.8 VDC  
 Remark: Channel 192  
 Operator: x\_Fto  
 Testing Site: Fully Anechoic Room (FAR); CETECOM Essen

Wed 28/Nov/2007 15:36:57pp

Spurious Emissions V7.1.1

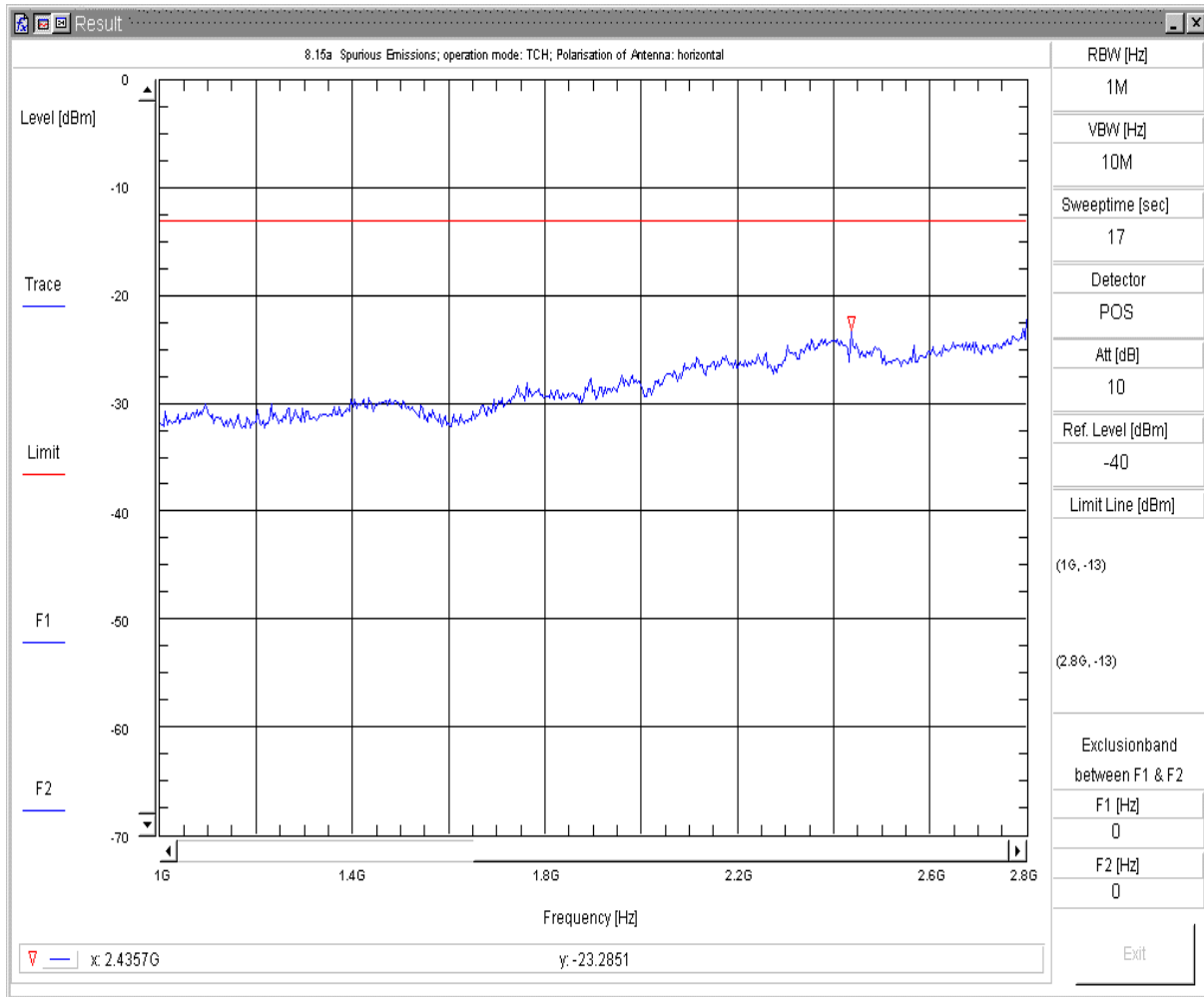

8.15a Radiated Spurious Emission

Transducer: c:\vee\_user\spuri\_V7\FCC\_Part22\_850\TD\_TX\_H  
 Sweepnr: Sweep4  
 Pol. of Antenna: horizontal  
 EUT Position: EUT\_vertical+horizontal  
 EUT OP Mode: FCC\_Part22\_850 TCH  
 EUT Description: MC55i + Board + Handset  
 EUT Hardware: B2.1  
 EUT Software: Rev. 00.303  
 EUT Config: C03  
 EUT S/N: IMEI: 004401080149475  
 Battery: AC/DC Charger; Maximum Voltage; 4.8 VDC  
 Remark: Channel 251  
 Operator: x\_Fto  
 Testing Site: Fully Anechoic Room (FAR); CETECOM Essen

Wed 28/Nov/2007 15:43:55fp

Spurious Emissions V7.1.1

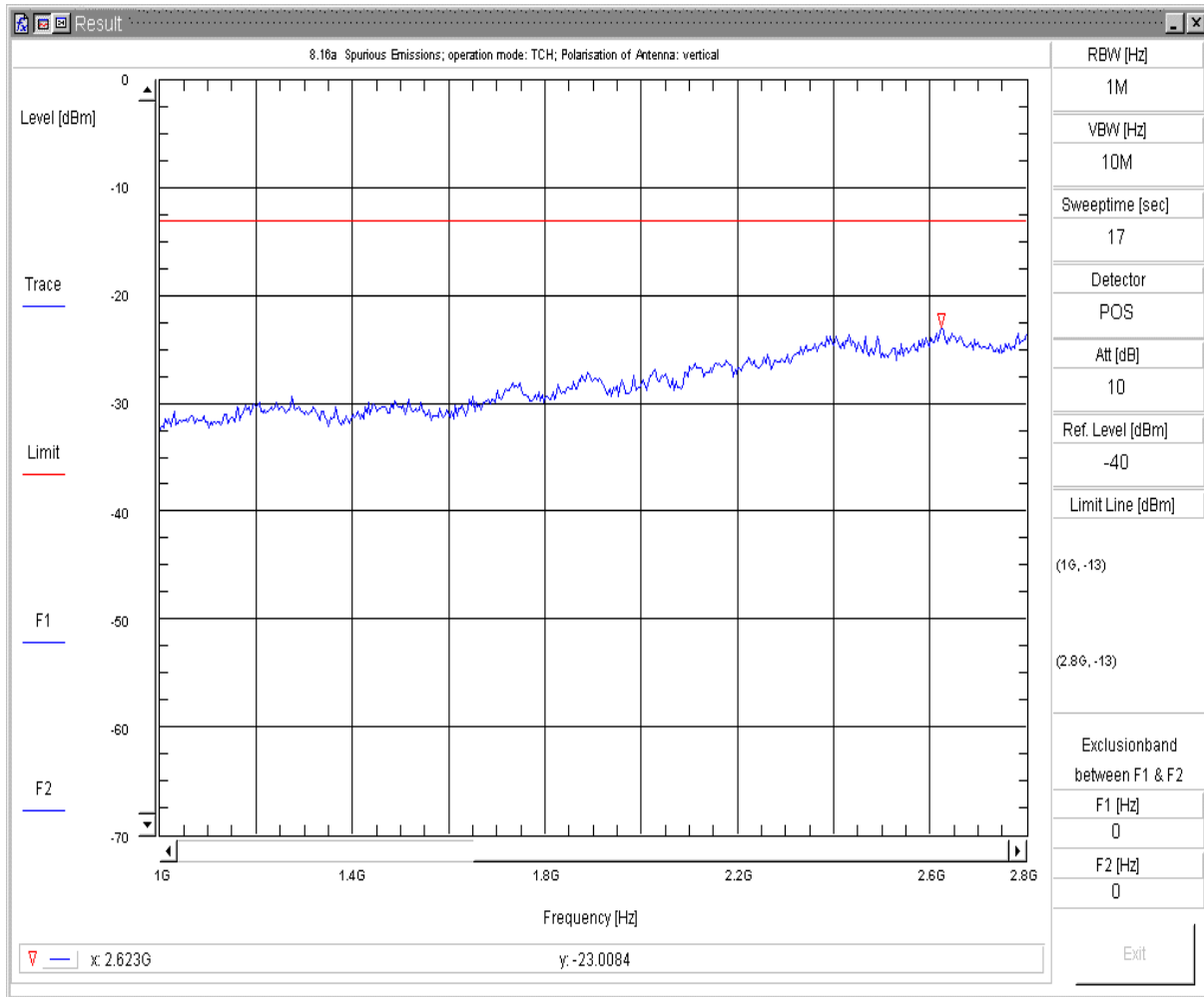

8.16a Radiated Spurious Emission

Transducer: c:\vee\_user\spuri\_V7\FCC\_Part22\_850\TD\_TX\_V  
 Sweepnr: Sweep4  
 Pol. of Antenna: vertikal  
 EUT Position: EUT\_vertical+horizontal  
 EUT OP Mode: FCC\_Part22\_850 TCH  
 EUT Description: MC55i + Board + Handset  
 EUT Hardware: B2.1  
 EUT Software: Rev. 00.303  
 EUT Config: C03  
 EUT S/N: IMEI: 004401080149475  
 Battery: AC/DC Charger; Maximum Voltage; 4.8 VDC  
 Remark: Channel 251  
 Operator: x\_Fto  
 Testing Site: Fully Anechoic Room (FAR); CETECOM Essen

Wed 28/Nov/2007 15:50:42pp

Spurious Emissions V7.1.1



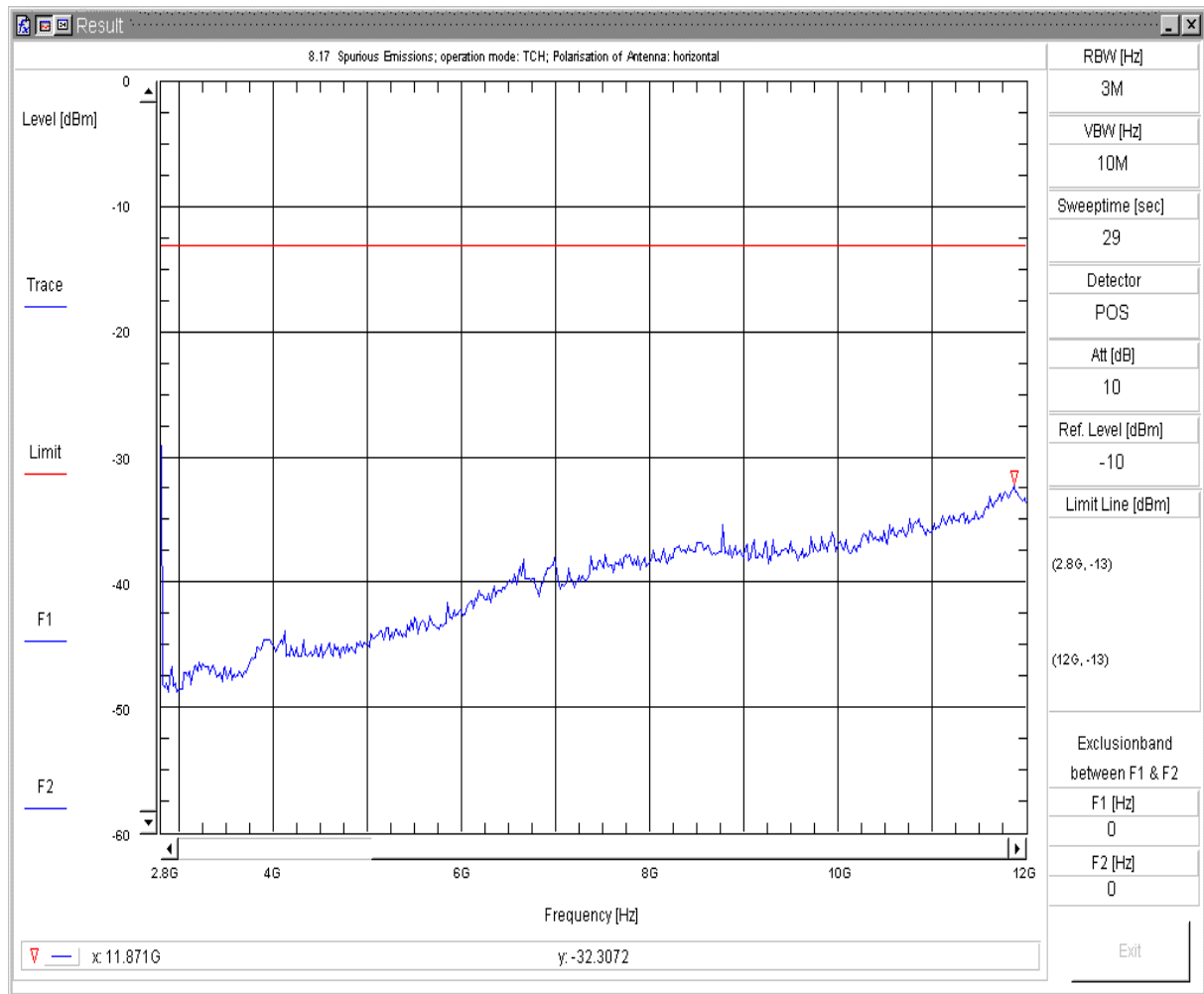

### 8.17 Radiated Spurious Emission

Transducer: c:\vee\_user\spuri\_V7\FCC\_Part22\_850\TD\_TX\_H  
 Sweepnr: Sweep5  
 Pol. of Antenna: horizontal  
 EUT Position: EUT\_vertical+horizontal  
 EUT OP Mode: FCC\_Part22\_850 TCH  
 EUT Description: MC55i + Board + Headset, Project 040194  
 EUT Hardware: B2.1  
 EUT Software: Rev. 00.303  
 EUT Config: C03  
 EUT S/N: IMEI: 004401080149475  
 Battery: Power Supply (external); Maximum Voltage; 4.8 VDC  
 Remark: Channel 128  
 Operator: Lor  
 Testing Site: Fully Anechoic Room (FAR); CETECOM Essen

Tue 20/Nov/2007 15:30:00fp

Spurious Emissions V7.1.1

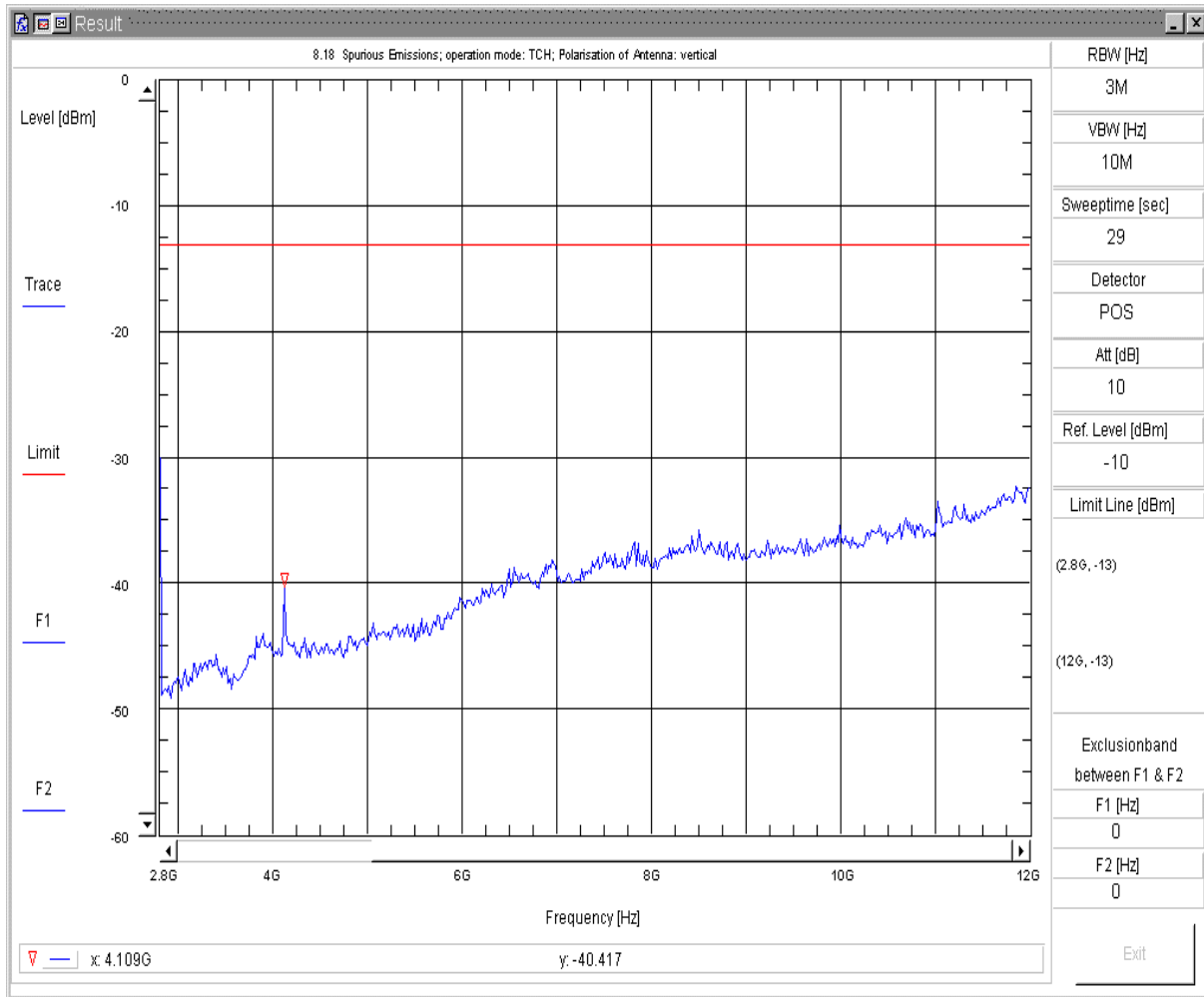

8.18 Radiated Spurious Emission

Transducer: c:\vee\_user\spuri\_V7\FCC\_Part22\_850\TD\_TX\_V  
 Sweepnr: Sweep5  
 Pol. of Antenna: vertikal  
 EUT Position: EUT\_vertical+horizontal  
 EUT OP Mode: FCC\_Part22\_850 TCH  
 EUT Description: MC55i + Board + Headset, Project 040194  
 EUT Hardware: B2.1  
 EUT Software: Rev. 00.303  
 EUT Config: C03  
 EUT S/N: IMEI: 004401080149475  
 Battery: Power Supply (external); Maximum Voltage; 4.8 VDC  
 Remark: Channel 128  
 Operator: Lor  
 Testing Site: Fully Anechoic Room (FAR); CETECOM Essen

Tue 20/Nov/2007 15:39:41ff

Spurious Emissions V7.1.1

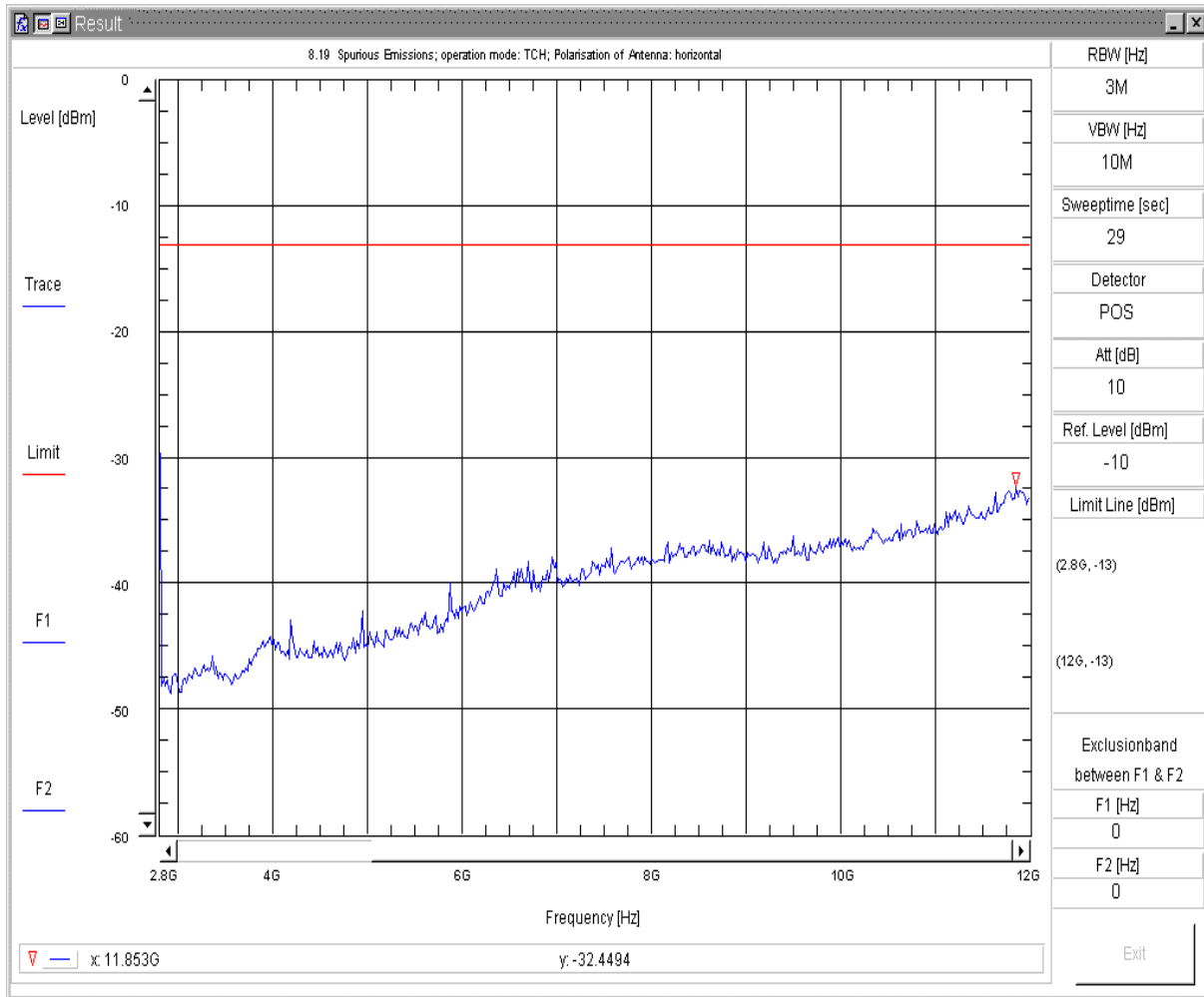

8.19 Radiated Spurious Emission

Transducer: c:\vee\_user\spuri\_V7\FCC\_Part22\_850\TD\_TX\_H  
 Sweepnr: Sweep5  
 Pol. of Antenna: horizontal  
 EUT Position: EUT\_vertical+horizontal  
 EUT OP Mode: FCC\_Part22\_850 TCH  
 EUT Description: MC55i + Board + Headset, Project 040194  
 EUT Hardware: B2.1  
 EUT Software: Rev. 00.303  
 EUT Config: C03  
 EUT S/N: IMEI: 004401080149475  
 Battery: Power Supply (external); Maximum Voltage; 4.8 VDC  
 Remark: Channel 192  
 Operator: Lor  
 Testing Site: Fully Anechoic Room (FAR); CETECOM Essen

Tue 20/Nov/2007 15:49:42fp

Spurious Emissions V7.1.1

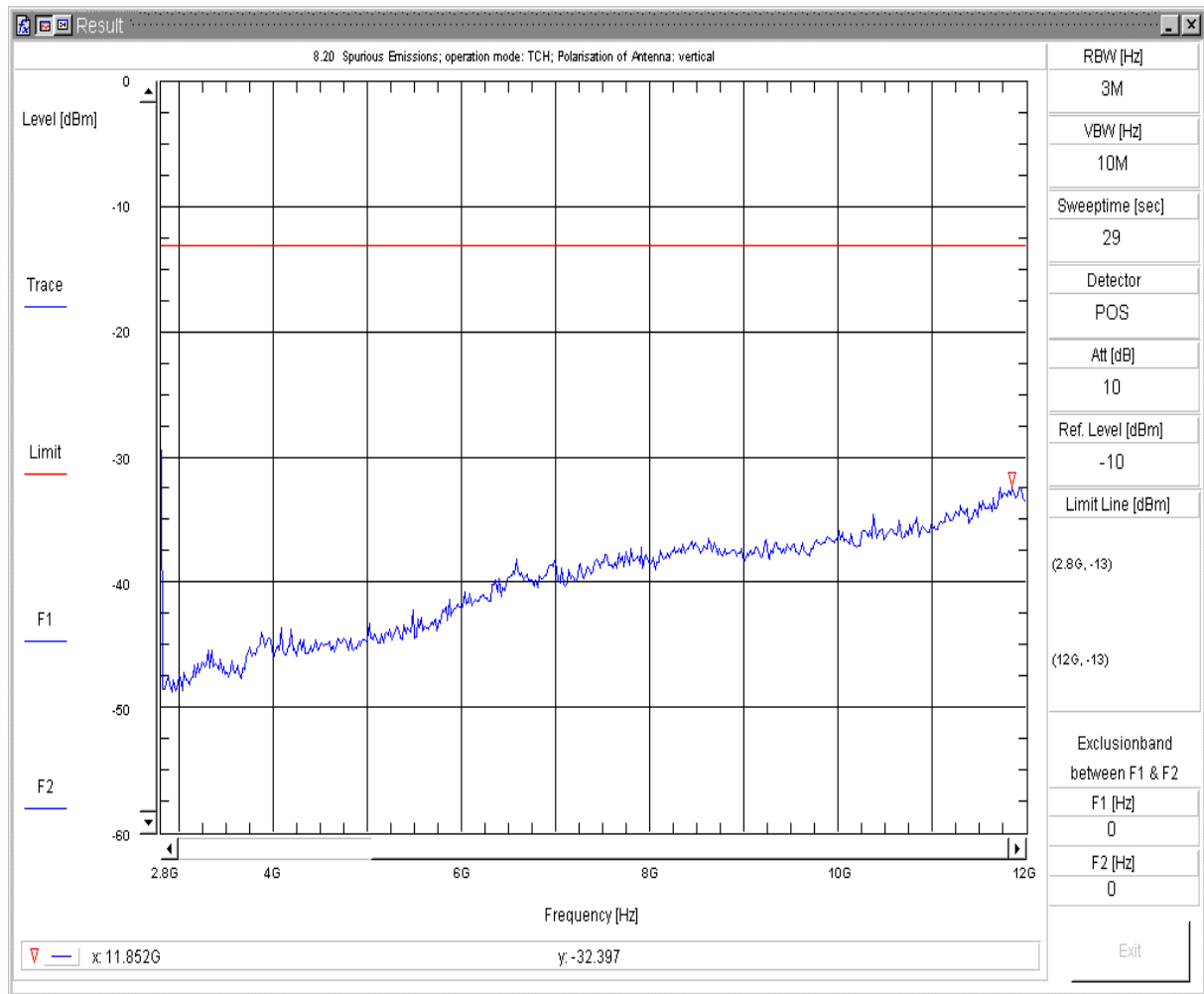

### 8.20 Radiated Spurious Emission

Transducer: c:\vee\_user\spuri\_V7\FCC\_Part22\_850\TD\_TX\_V  
 Sweepnr: Sweep5  
 Pol. of Antenna: vertikal  
 EUT Position: EUT\_vertical+horizontal  
 EUT OP Mode: FCC\_Part22\_850 TCH  
 EUT Description: MC55i + Board + Headset, Project 040194  
 EUT Hardware: B2.1  
 EUT Software: Rev. 00.303  
 EUT Config: C03  
 EUT S/N: IMEI: 004401080149475  
 Battery: Power Supply (external); Maximum Voltage; 4.8 VDC  
 Remark: Channel 192  
 Operator: Lor  
 Testing Site: Fully Anechoic Room (FAR); CETECOM Essen

Tue 20/Nov/2007 15:59:19fp

Spurious Emissions V7.1.1

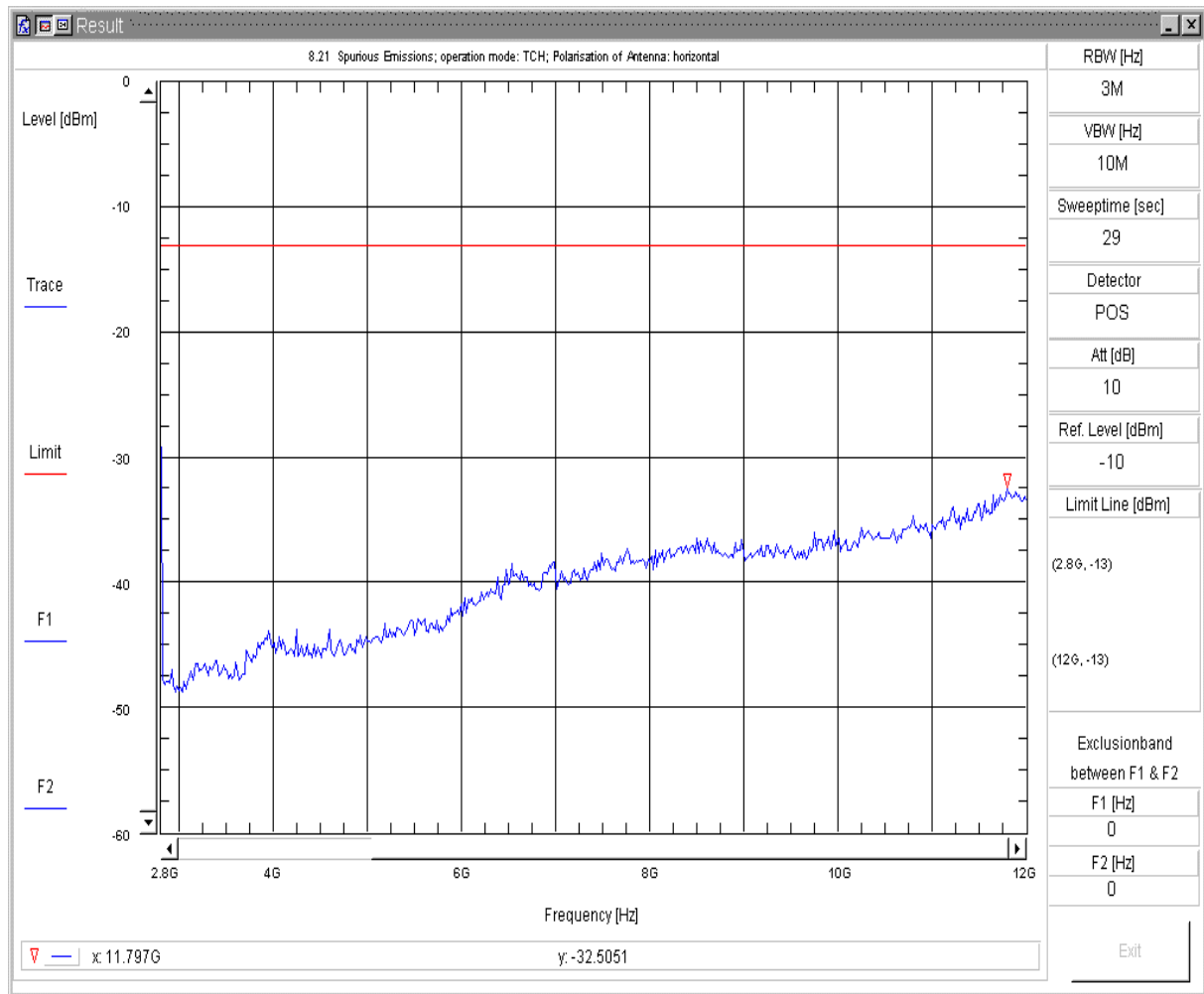

### 8.21 Radiated Spurious Emission

Transducer: c:\vee\_user\spuri\_V7\FCC\_Part22\_850\TD\_TX\_H  
 Sweepnr: Sweep5  
 Pol. of Antenna: horizontal  
 EUT Position: EUT\_vertical+horizontal  
 EUT OP Mode: FCC\_Part22\_850 TCH  
 EUT Description: MC55i + Board + Headset, Project 040194  
 EUT Hardware: B2.1  
 EUT Software: Rev. 00.303  
 EUT Config: C03  
 EUT S/N: IMEI: 004401080149475  
 Battery: Power Supply (external); Maximum Voltage; 4.8 VDC  
 Remark: Channel 251  
 Operator: Lor  
 Testing Site: Fully Anechoic Room (FAR); CETECOM Essen

Tue 20/Nov/2007 16:09:13ff

Spurious Emissions V7.1.1

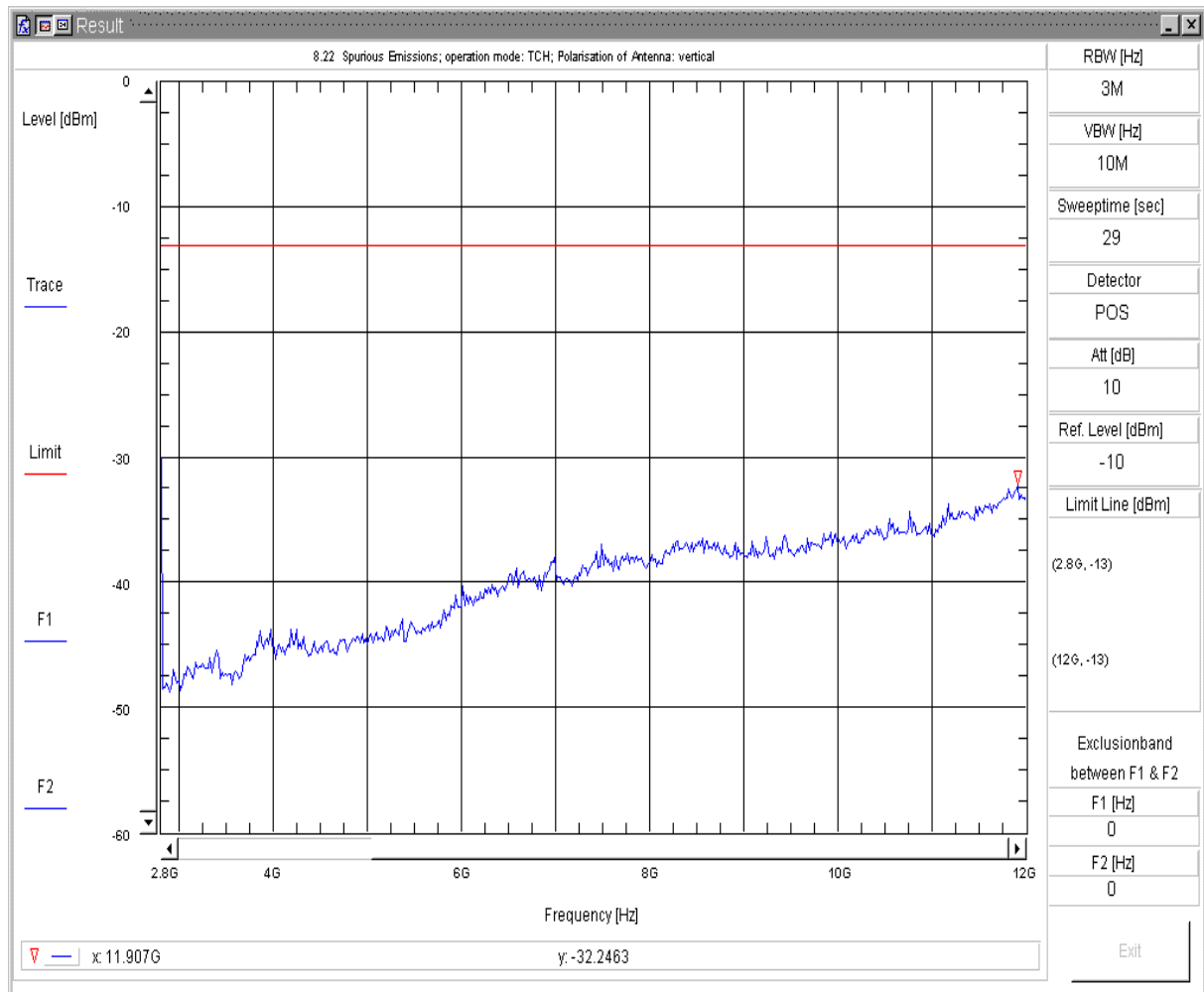

### 8.22 Radiated Spurious Emission

Transducer: c:\vee\_user\spuri\_V7\FCC\_Part22\_850\TD\_TX\_V  
 Sweepnr: Sweep5  
 Pol. of Antenna: vertikal  
 EUT Position: EUT\_vertical+horizontal  
 EUT OP Mode: FCC\_Part22\_850 TCH  
 EUT Description: MC55i + Board + Headset, Project 040194  
 EUT Hardware: B2.1  
 EUT Software: Rev. 00.303  
 EUT Config: C03  
 EUT S/N: IMEI: 004401080149475  
 Battery: Power Supply (external); Maximum Voltage; 4.8 VDC  
 Remark: Channel 251  
 Operator: Lor  
 Testing Site: Fully Anechoic Room (FAR); CETECOM Essen

Tue 20/Nov/2007 16:19:43ff

Spurious Emissions V7.1.1

## 9.4.2. GSM 1900 MODE

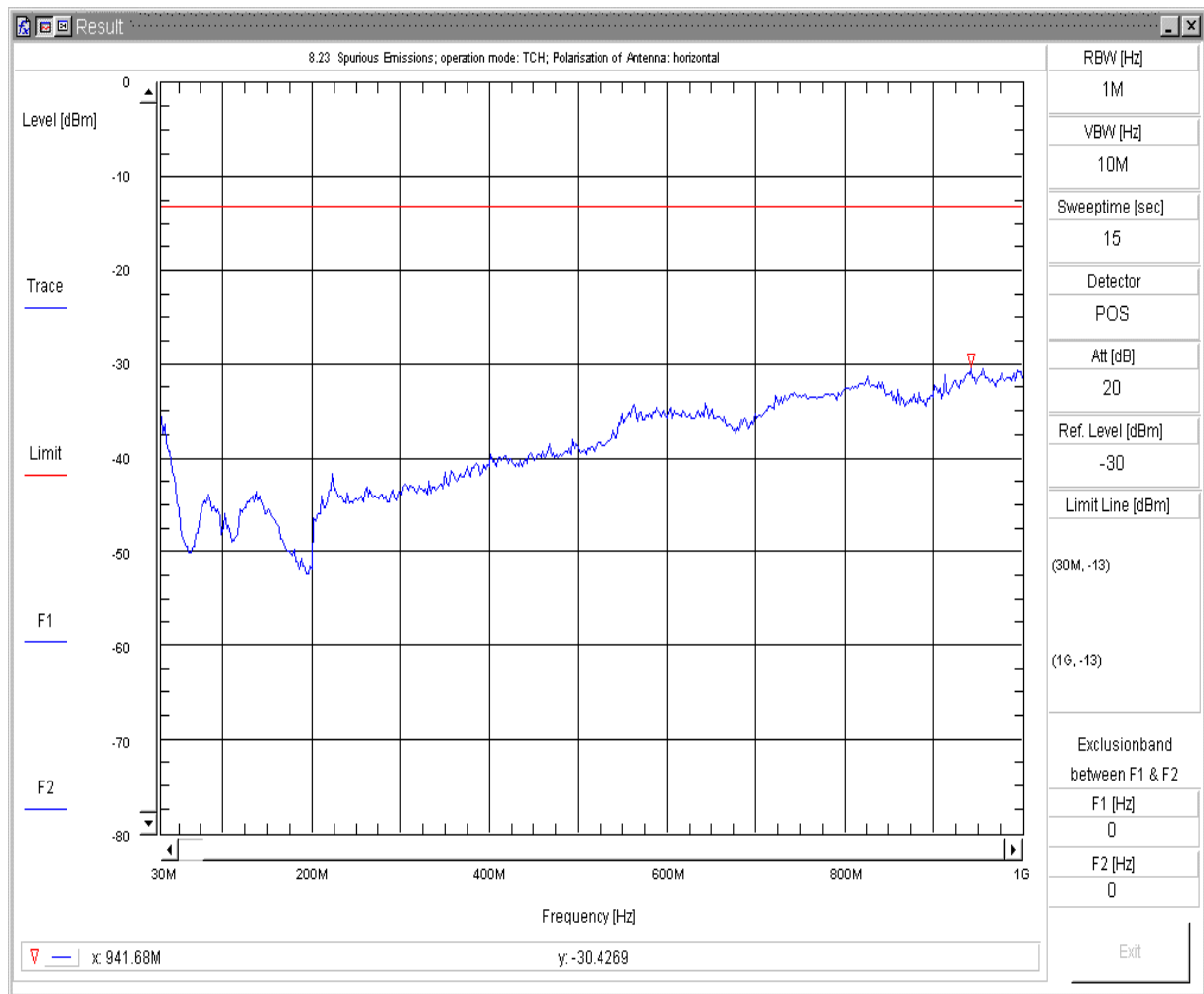

8.23 Radiated Spurious Emission

Transducer: c:\vee\_user\spuri\_V7\FCC\_Part24\_1900\TD\_TX\_H  
 Sweepnr: Sweep1  
 Pol. of Antenna: horizontal  
 EUT Position: EUT\_vertical+horizontal  
 EUT OP Mode: FCC\_Part24\_1900 TCH  
 EUT Description: MC55i + Board + Headset, Project 040194  
 EUT Hardware: B2.1  
 EUT Software: Rev. 00.303  
 EUT Config: C03  
 EUT S/N: IMEI: 004401080149475  
 Battery: Power Supply (external); Maximum Voltage; 4.8 VDC  
 Remark: Channel 512  
 Operator: x\_Hol  
 Testing Site: Fully Anechoic Room (FAR); CETECOM Essen

Tue 20/Nov/2007 16:33:20ppp

Spurious Emissions V7.1.1

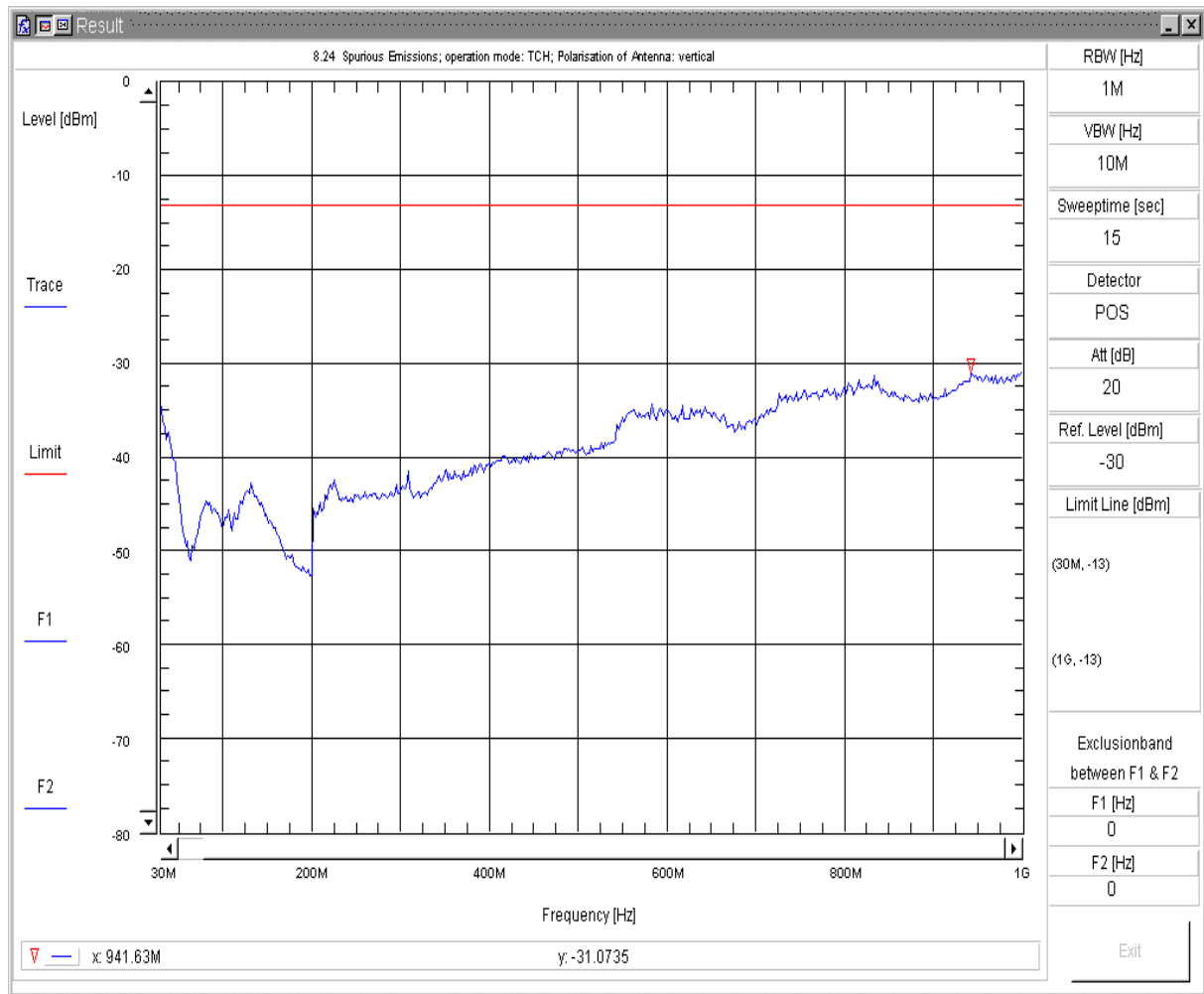

### 8.24 Radiated Spurious Emission

Transducer: c:\vee\_user\spuri\_V7\FCC\_Part24\_1900\TD\_TX\_V  
 Sweepnr: Sweep1  
 Pol. of Antenna: vertikal  
 EUT Position: EUT\_vertical+horizontal  
 EUT OP Mode: FCC\_Part24\_1900 TCH  
 EUT Description: MC55i + Board + Headset, Project 040194  
 EUT Hardware: B2.1  
 EUT Software: Rev. 00.303  
 EUT Config: C03  
 EUT S/N: IMEI: 004401080149475  
 Battery: Power Supply (external); Maximum Voltage; 4.8 VDC  
 Remark: Channel 512  
 Operator: x\_Hol  
 Testing Site: Fully Anechoic Room (FAR); CETECOM Essen

Tue 20/Nov/2007 16:37:39ppf

Spurious Emissions V7.1.1



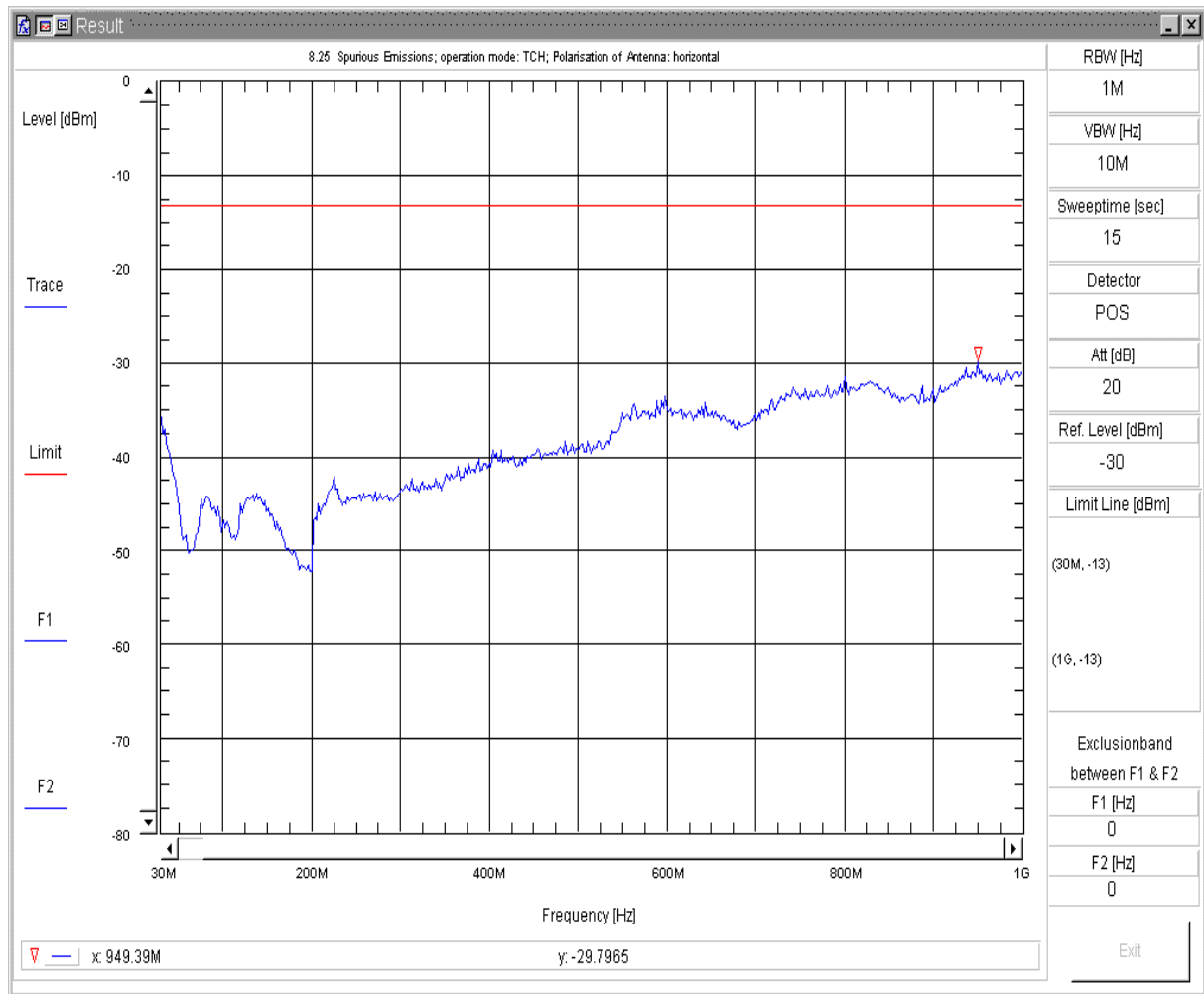

### 8.25 Radiated Spurious Emission

Transducer: c:\vee\_user\spuri\_V7\FCC\_Part24\_1900\TD\_TX\_H  
 Sweepnr: Sweep1  
 Pol. of Antenna: horizontal  
 EUT Position: EUT\_vertical+horizontal  
 EUT OP Mode: FCC\_Part24\_1900 TCH  
 EUT Description: MC55i + Board + Headset, Project 040194  
 EUT Hardware: B2.1  
 EUT Software: Rev. 00.303  
 EUT Config: C03  
 EUT S/N: IMEI: 004401080149475  
 Battery: Power Supply (external); Maximum Voltage; 4.8 VDC  
 Remark: Channel 661  
 Operator: x\_Hol  
 Testing Site: Fully Anechoic Room (FAR); CETECOM Essen

Tue 20/Nov/2007 16:44:03ppp

Spurious Emissions V7.1.1

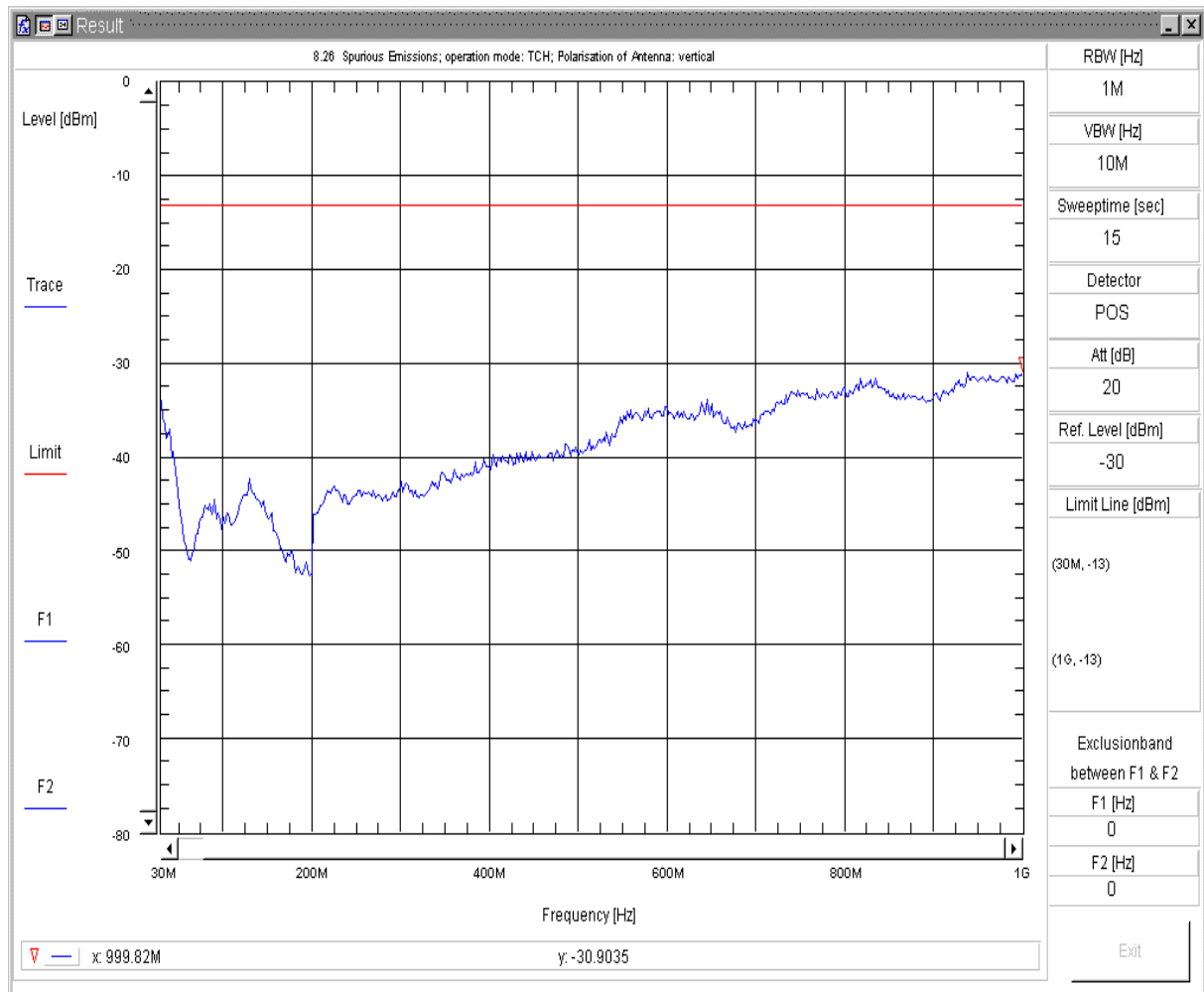

### 8.26 Radiated Spurious Emission

Transducer: c:\vee\_user\spuri\_V7\FCC\_Part24\_1900\TD\_TX\_V  
 Sweepnr: Sweep1  
 Pol. of Antenna: vertikal  
 EUT Position: EUT\_vertical+horizontal  
 EUT OP Mode: FCC\_Part24\_1900 TCH  
 EUT Description: MC55i + Board + Headset, Project 040194  
 EUT Hardware: B2.1  
 EUT Software: Rev. 00.303  
 EUT Config: C03  
 EUT S/N: IMEI: 004401080149475  
 Battery: Power Supply (external); Maximum Voltage; 4.8 VDC  
 Remark: Channel 661  
 Operator: x\_Hol  
 Testing Site: Fully Anechoic Room (FAR); CETECOM Essen

Tue 20/Nov/2007 16:47:44ppf

Spurious Emissions V7.1.1

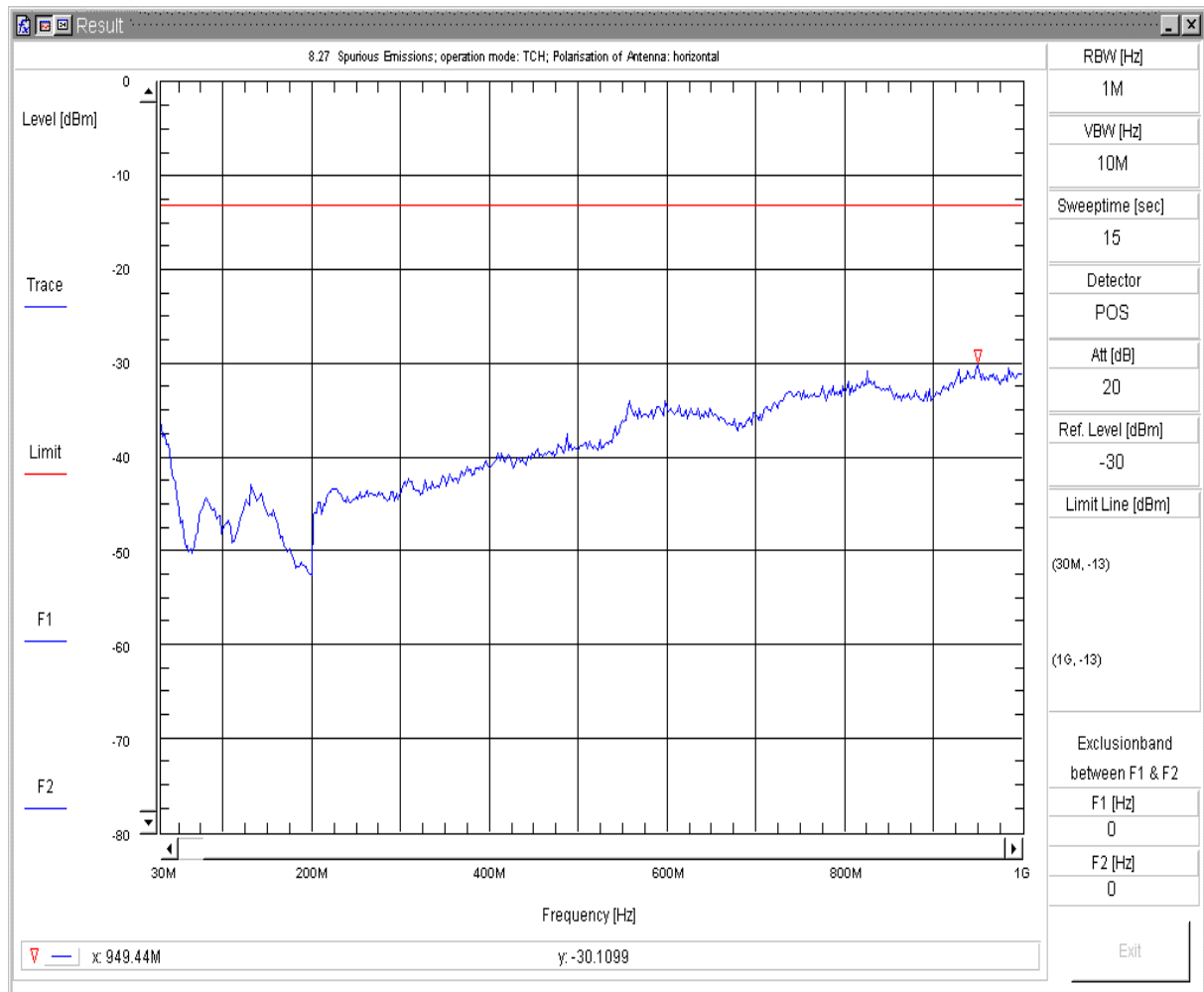

### 8.27 Radiated Spurious Emission

Transducer: c:\vee\_user\spuri\_V7\FCC\_Part24\_1900\TD\_TX\_H  
 Sweepnr: Sweep1  
 Pol. of Antenna: horizontal  
 EUT Position: EUT\_vertical+horizontal  
 EUT OP Mode: FCC\_Part24\_1900 TCH  
 EUT Description: MC55i + Board + Headset, Project 040194  
 EUT Hardware: B2.1  
 EUT Software: Rev. 00.303  
 EUT Config: C03  
 EUT S/N: IMEI: 004401080149475  
 Battery: Power Supply (external); Maximum Voltage; 4.8 VDC  
 Remark: Channel 810  
 Operator: x\_Hol  
 Testing Site: Fully Anechoic Room (FAR); CETECOM Essen

Tue 20/Nov/2007 16:51:52ppp

Spurious Emissions V7.1.1

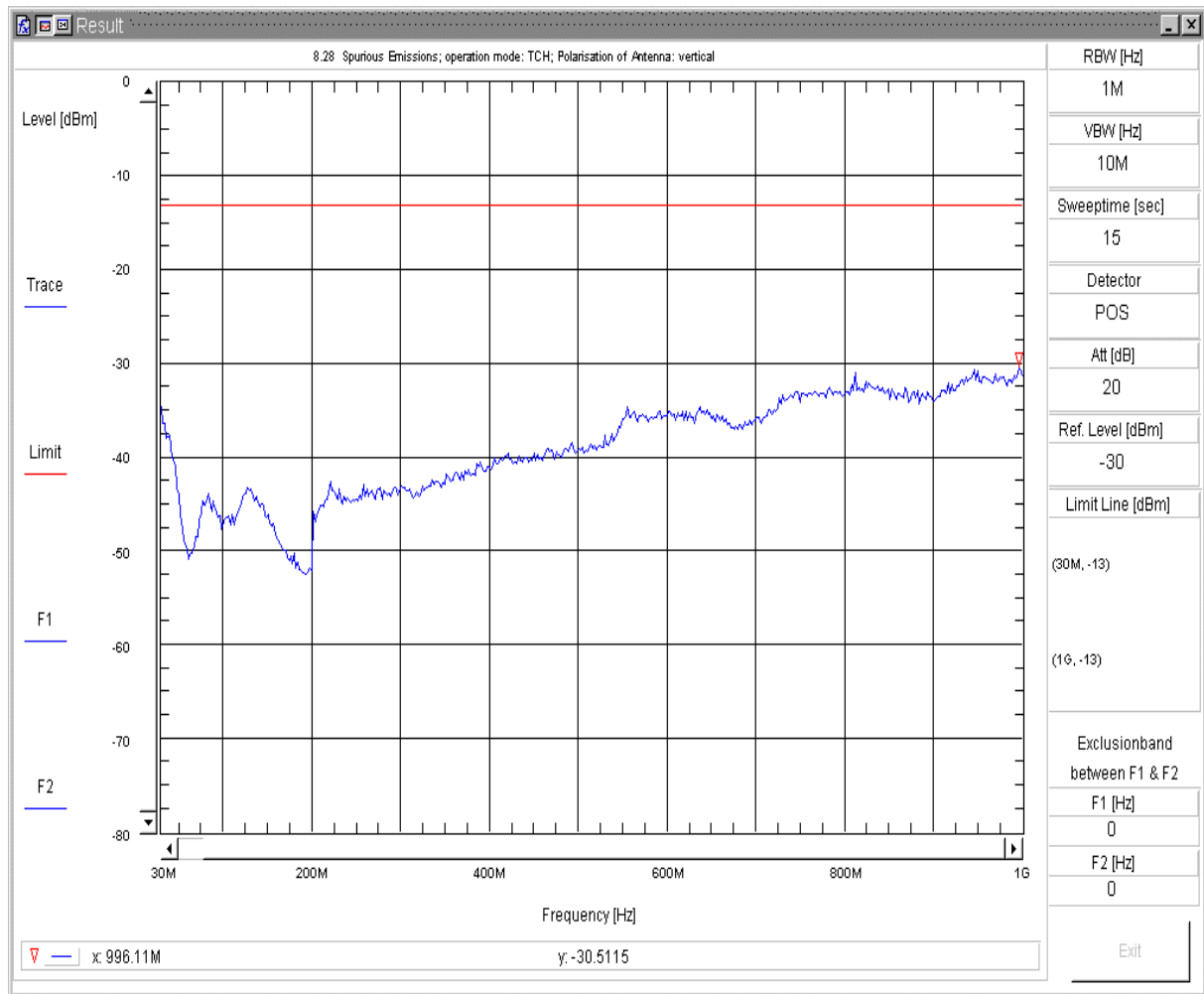

### 8.28 Radiated Spurious Emission

Transducer: c:\vee\_user\spuri\_V7\FCC\_Part24\_1900\TD\_TX\_V  
 Sweepnr: Sweep1  
 Pol. of Antenna: vertikal  
 EUT Position: EUT\_vertical+horizontal  
 EUT OP Mode: FCC\_Part24\_1900 TCH  
 EUT Description: MC55i + Board + Headset, Project 040194  
 EUT Hardware: B2.1  
 EUT Software: Rev. 00.303  
 EUT Config: C03  
 EUT S/N: IMEI: 004401080149475  
 Battery: Power Supply (external); Maximum Voltage; 4.8 VDC  
 Remark: Channel 810  
 Operator: x\_Hol  
 Testing Site: Fully Anechoic Room (FAR); CETECOM Essen

Tue 20/Nov/2007 16:55:34ppf

Spurious Emissions V7.1.1

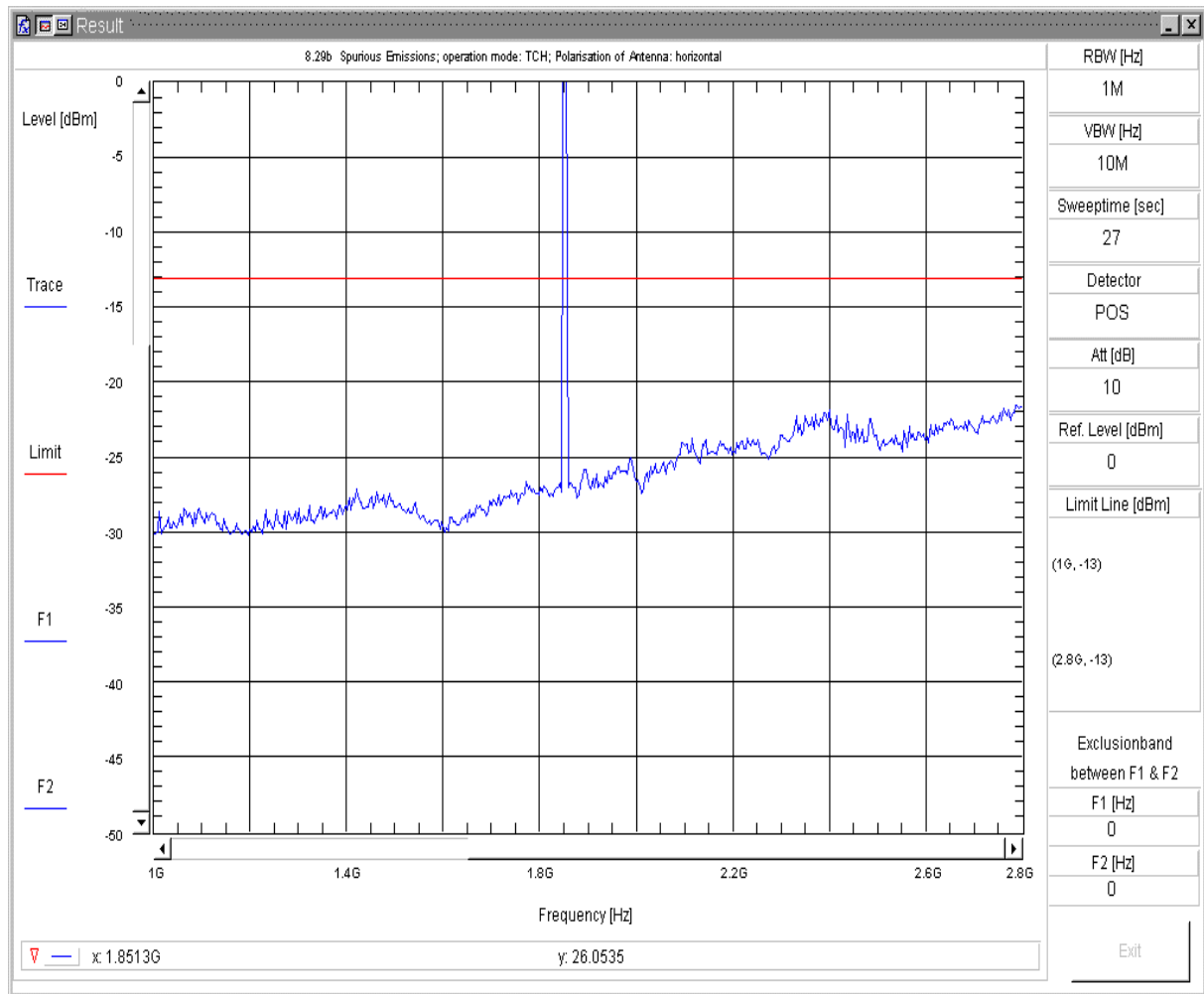

### 8.29b Radiated Spurious Emission

Transducer: c:\vee\_user\spuri\_V7\FCC\_Part24\_1900\TD\_TX\_H  
 Sweepnr: Sweep2  
 Pol. of Antenna: horizontal  
 EUT Position: EUT\_vertical+horizontal  
 EUT OP Mode: FCC\_Part24\_1900 TCH  
 EUT Description: MC55i + Board + Handset  
 EUT Hardware: B2.1  
 EUT Software: Rev. 00.303  
 EUT Config: C03  
 EUT S/N: IMEI: 004401080149475  
 Battery: AC/DC Charger; Maximum Voltage; 4.8 VDC  
 Remark: Channel 512  
 Operator: x\_Fto  
 Testing Site: Fully Anechoic Room (FAR); CETECOM Essen

Wed 28/Nov/2007 14:01:40pp

Spurious Emissions V7.1.1

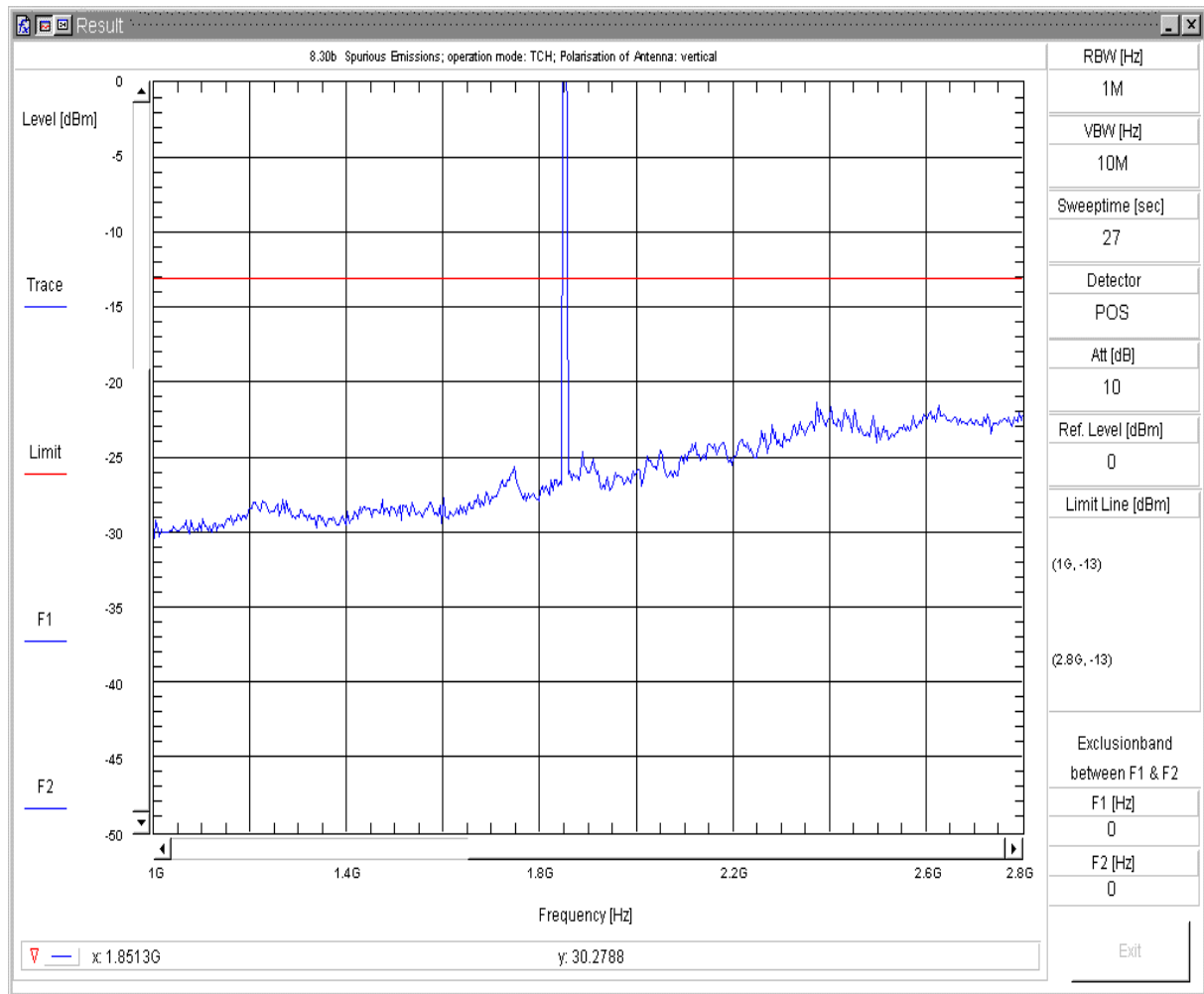

### 8.30b Radiated Spurious Emission

Transducer: c:\vee\_user\spuri\_V7\FCC\_Part24\_1900\TD\_TX\_V  
 Sweepnr: Sweep2  
 Pol. of Antenna: vertikal  
 EUT Position: EUT\_vertikal+horizontal  
 EUT OP Mode: FCC\_Part24\_1900 TCH  
 EUT Description: MC55i + Board + Handset  
 EUT Hardware: B2.1  
 EUT Software: Rev. 00.303  
 EUT Config: C03  
 EUT S/N: IMEI: 004401080149475  
 Battery: AC/DC Charger; Maximum Voltage; 4.8 VDC  
 Remark: Channel 512  
 Operator: x\_Fto  
 Testing Site: Fully Anechoic Room (FAR); CETECOM Essen

Wed 28/Nov/2007 14:11:19pp

Spurious Emissions V7.1.1

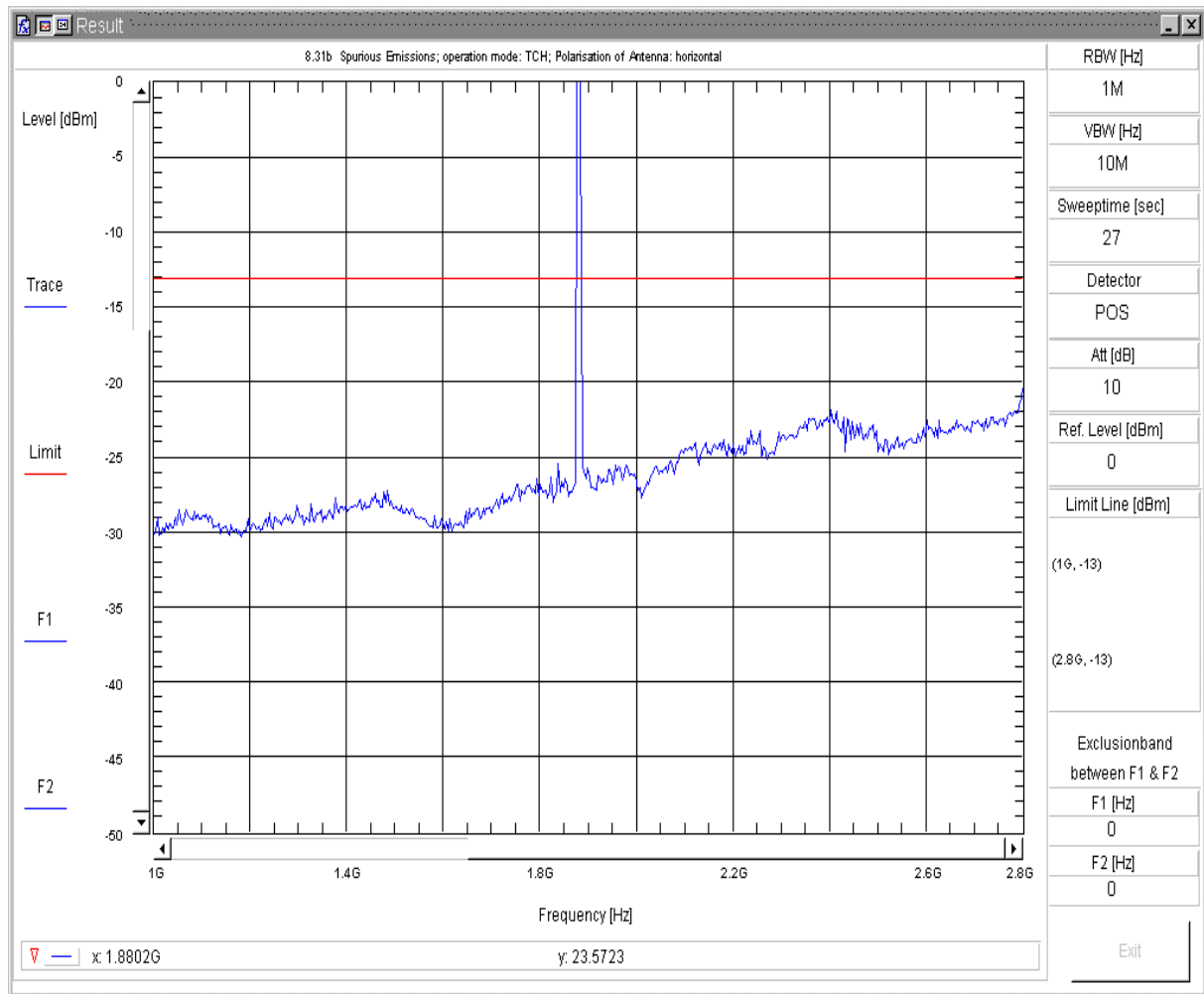

### 8.31b Radiated Spurious Emission

Transducer: c:\vee\_user\spuri\_V7\FCC\_Part24\_1900\TD\_TX\_H  
 Sweepnr: Sweep2  
 Pol. of Antenna: horizontal  
 EUT Position: EUT\_vertical+horizontal  
 EUT OP Mode: FCC\_Part24\_1900 TCH  
 EUT Description: MC55i + Board + Handset  
 EUT Hardware: B2.1  
 EUT Software: Rev. 00.303  
 EUT Config: C03  
 EUT S/N: IMEI: 004401080149475  
 Battery: AC/DC Charger; Maximum Voltage; 4.8 VDC  
 Remark: Channel 661  
 Operator: x\_Fto  
 Testing Site: Fully Anechoic Room (FAR); CETECOM Essen

Wed 28/Nov/2007 14:31:47pp

Spurious Emissions V7.1.1

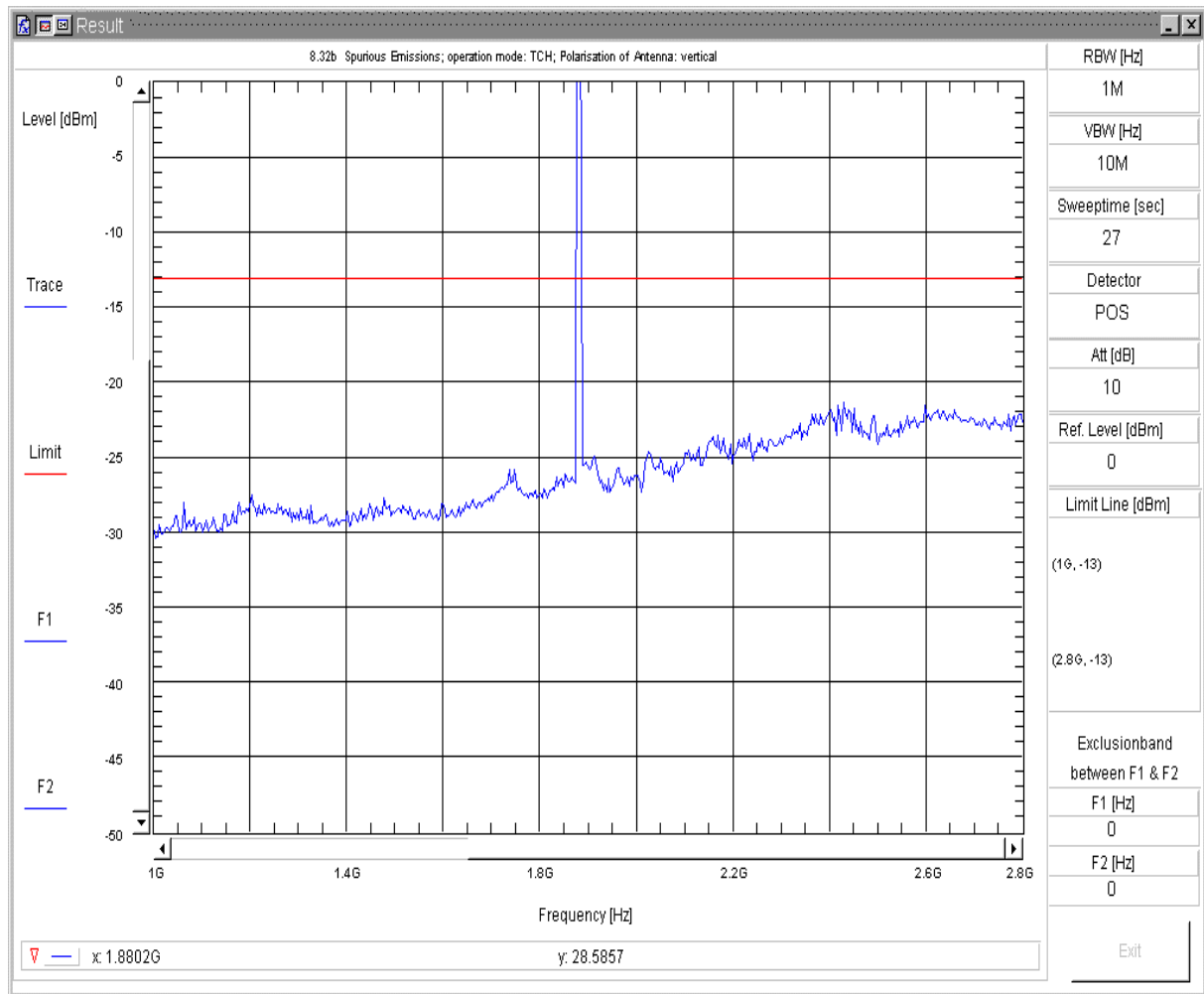

### 8.32b Radiated Spurious Emission

Transducer: c:\vee\_user\spuri\_V7\FCC\_Part24\_1900\TD\_TX\_V  
 Sweepnr: Sweep2  
 Pol. of Antenna: vertikal  
 EUT Position: EUT\_vertikal+horizontal  
 EUT OP Mode: FCC\_Part24\_1900 TCH  
 EUT Description: MC55i + Board + Handset  
 EUT Hardware: B2.1  
 EUT Software: Rev. 00.303  
 EUT Config: C03  
 EUT S/N: IMEI: 004401080149475  
 Battery: AC/DC Charger; Maximum Voltage; 4.8 VDC  
 Remark: Channel 661  
 Operator: x\_Fto  
 Testing Site: Fully Anechoic Room (FAR); CETECOM Essen

Wed 28/Nov/2007 14:20:47pp

Spurious Emissions V7.1.1



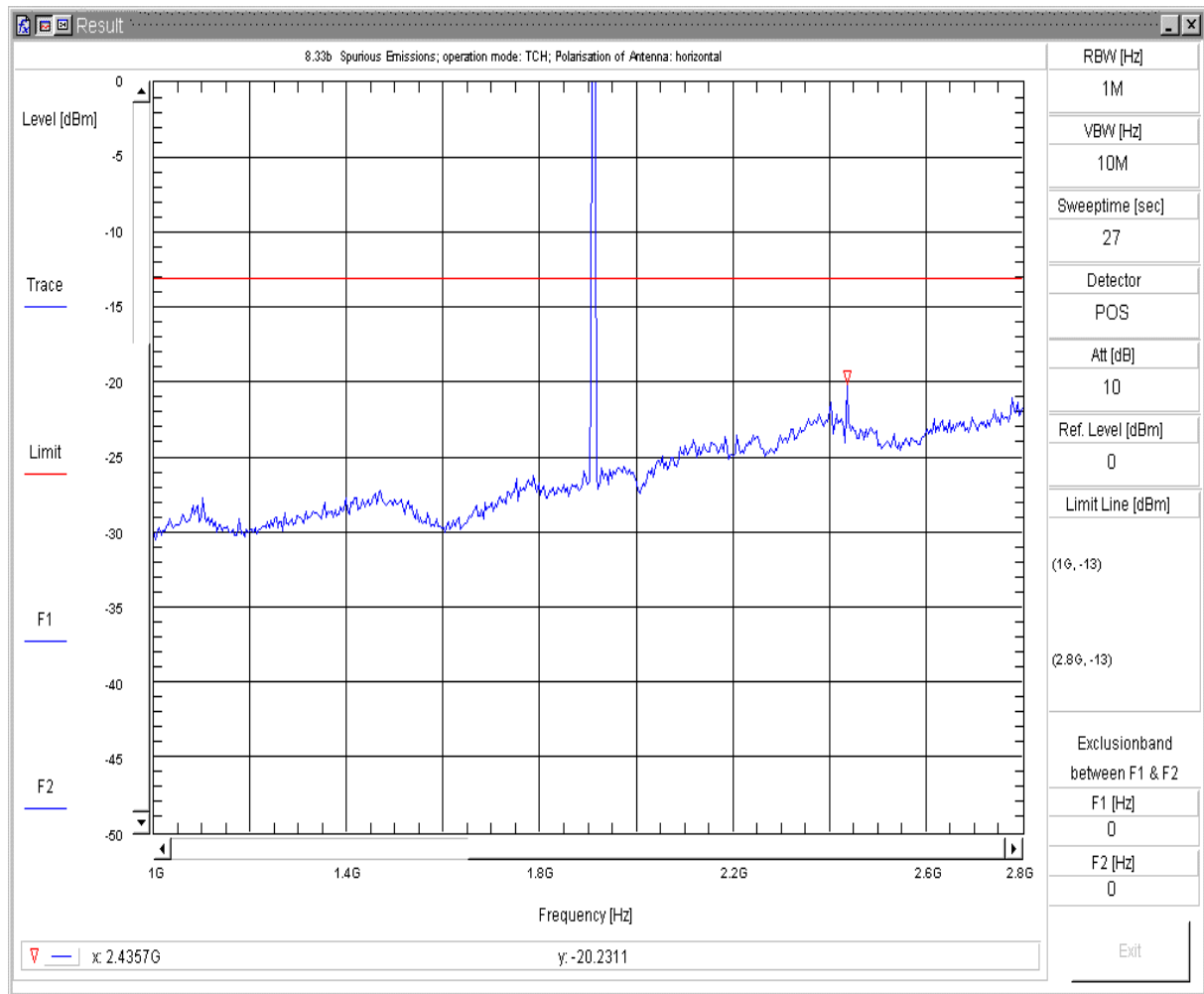

### 8.33b Radiated Spurious Emission

Transducer: c:\vee\_user\spuri\_V7\FCC\_Part24\_1900\TD\_TX\_H  
 Sweepnr: Sweep2  
 Pol. of Antenna: horizontal  
 EUT Position: EUT\_vertical+horizontal  
 EUT OP Mode: FCC\_Part24\_1900 TCH  
 EUT Description: MC55i + Board + Handset  
 EUT Hardware: B2.1  
 EUT Software: Rev. 00.303  
 EUT Config: C03  
 EUT S/N: IMEI: 004401080149475  
 Battery: AC/DC Charger; Maximum Voltage; 4.8 VDC  
 Remark: Channel 810  
 Operator: x\_Fto  
 Testing Site: Fully Anechoic Room (FAR); CETECOM Essen

Wed 28/Nov/2007 14:44:09pp

Spurious Emissions V7.1.1

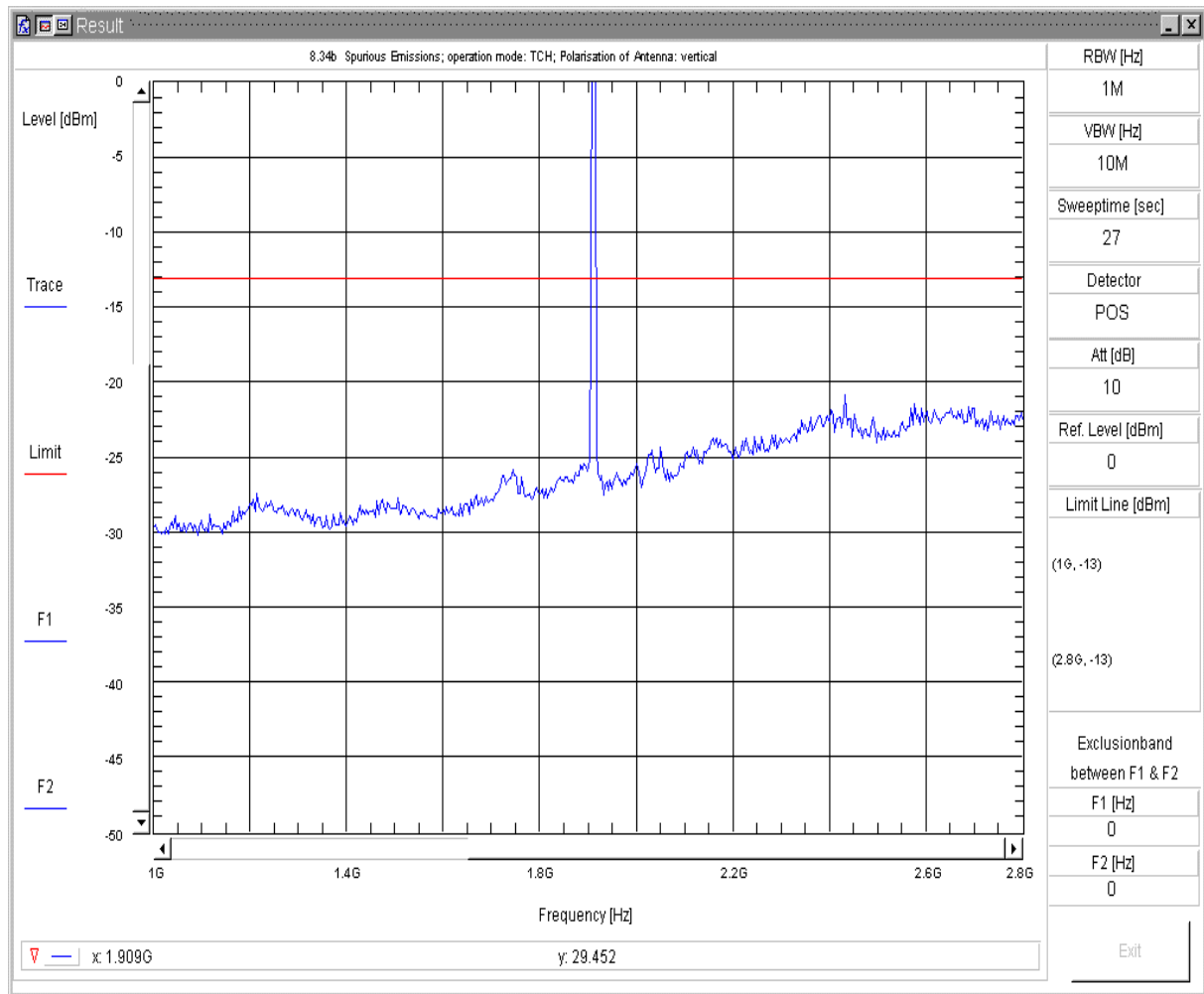

### 8.34b Radiated Spurious Emission

Transducer: c:\vee\_user\spuri\_V7\FCC\_Part24\_1900\TD\_TX\_V  
 Sweepnr: Sweep2  
 Pol. of Antenna: vertikal  
 EUT Position: EUT\_vertikal+horizontal  
 EUT OP Mode: FCC\_Part24\_1900 TCH  
 EUT Description: MC55i + Board + Handset  
 EUT Hardware: B2.1  
 EUT Software: Rev. 00.303  
 EUT Config: C03  
 EUT S/N: IMEI: 004401080149475  
 Battery: AC/DC Charger; Maximum Voltage; 4.8 VDC  
 Remark: Channel 810  
 Operator: x\_Fto  
 Testing Site: Fully Anechoic Room (FAR); CETECOM Essen

Wed 28/Nov/2007 14:54:24pp

Spurious Emissions V7.1.1

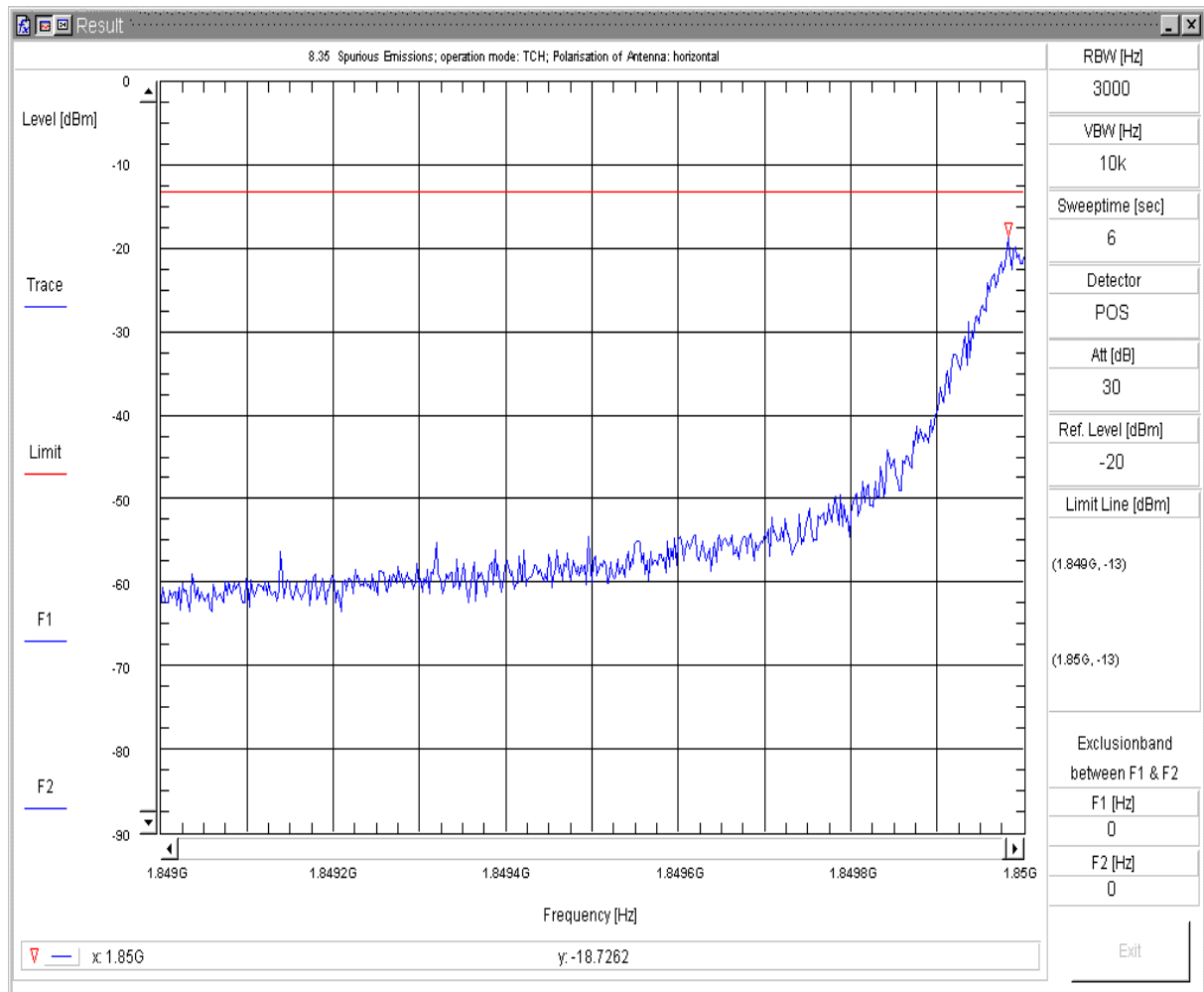

### 8.35 Radiated Spurious Emission

Transducer: c:\vee\_user\spuri\_V7\FCC\_Part24\_1900\TD\_TX\_H  
 Sweepnr: Sweep3  
 Pol. of Antenna: horizontal  
 EUT Position: EUT\_vertical+horizontal  
 EUT OP Mode: FCC\_Part24\_1900 TCH  
 EUT Description: MC55i + Board + Headset, Project 040194  
 EUT Hardware: B2.1  
 EUT Software: Rev. 00.303  
 EUT Config: C03  
 EUT S/N: IMEI: 004401080149475  
 Battery: Power Supply (external); Maximum Voltage; 4.8 VDC  
 Remark: Channel 512  
 Operator: x\_Hol  
 Testing Site: Fully Anechoic Room (FAR); CETECOM Essen

Tue 20/Nov/2007 17:55:07pp

Spurious Emissions V7.1.1

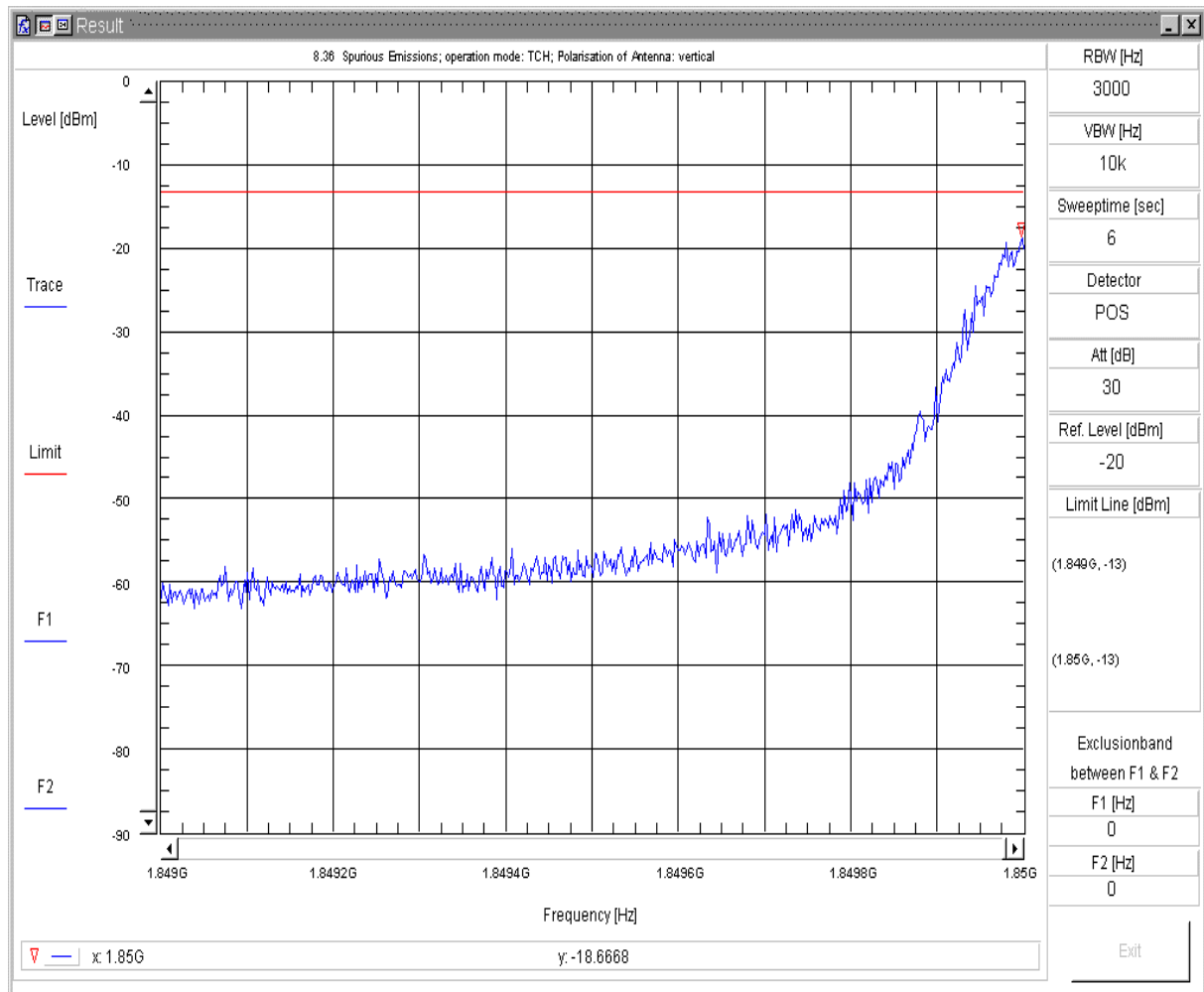

### 8.36 Radiated Spurious Emission

Transducer: c:\vee\_user\spuri\_V7\FCC\_Part24\_1900\TD\_TX\_V  
 Sweepnr: Sweep3  
 Pol. of Antenna: vertikal  
 EUT Position: EUT\_vertical+horizontal  
 EUT OP Mode: FCC\_Part24\_1900 TCH  
 EUT Description: MC55i + Board + Headset, Project 040194  
 EUT Hardware: B2.1  
 EUT Software: Rev. 00.303  
 EUT Config: C03  
 EUT S/N: IMEI: 004401080149475  
 Battery: Power Supply (external); Maximum Voltage; 4.8 VDC  
 Remark: Channel 512  
 Operator: x\_Hol  
 Testing Site: Fully Anechoic Room (FAR); CETECOM Essen

Tue 20/Nov/2007 17:59:13pf

Spurious Emissions V7.1.1

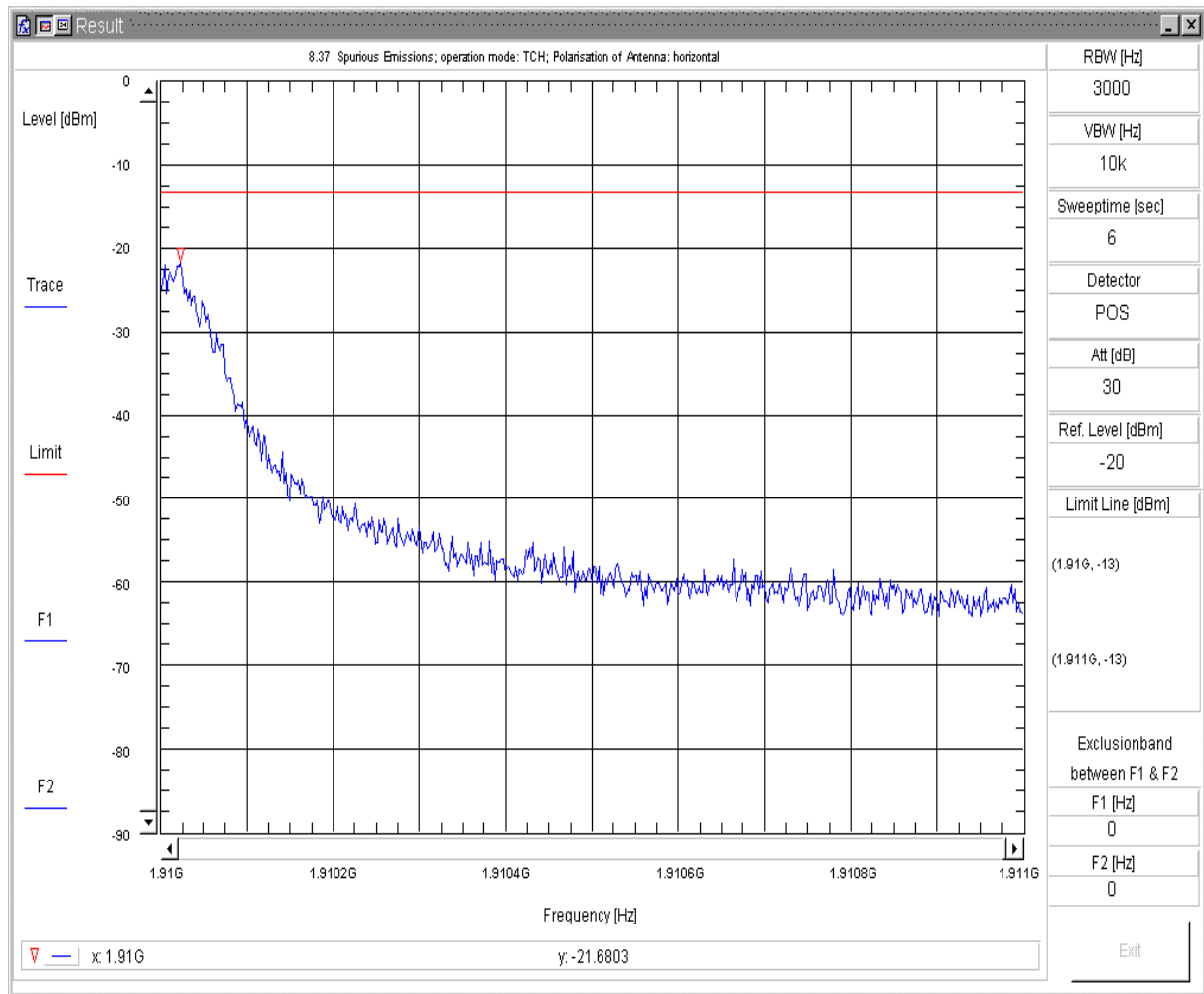

### 8.37 Radiated Spurious Emission

Transducer: c:\vee\_user\spuri\_V7\FCC\_Part24\_1900\TD\_TX\_H  
 Sweepnr: Sweep4  
 Pol. of Antenna: horizontal  
 EUT Position: EUT\_vertical+horizontal  
 EUT OP Mode: FCC\_Part24\_1900 TCH  
 EUT Description: MC55i + Board + Headset, Project 040194  
 EUT Hardware: B2.1  
 EUT Software: Rev. 00.303  
 EUT Config: C03  
 EUT S/N: IMEI: 004401080149475  
 Battery: Power Supply (external); Maximum Voltage; 4.8 VDC  
 Remark: Channel 810  
 Operator: x\_Hol  
 Testing Site: Fully Anechoic Room (FAR); CETECOM Essen

Tue 20/Nov/2007 18:05:43pp

Spurious Emissions V7.1.1

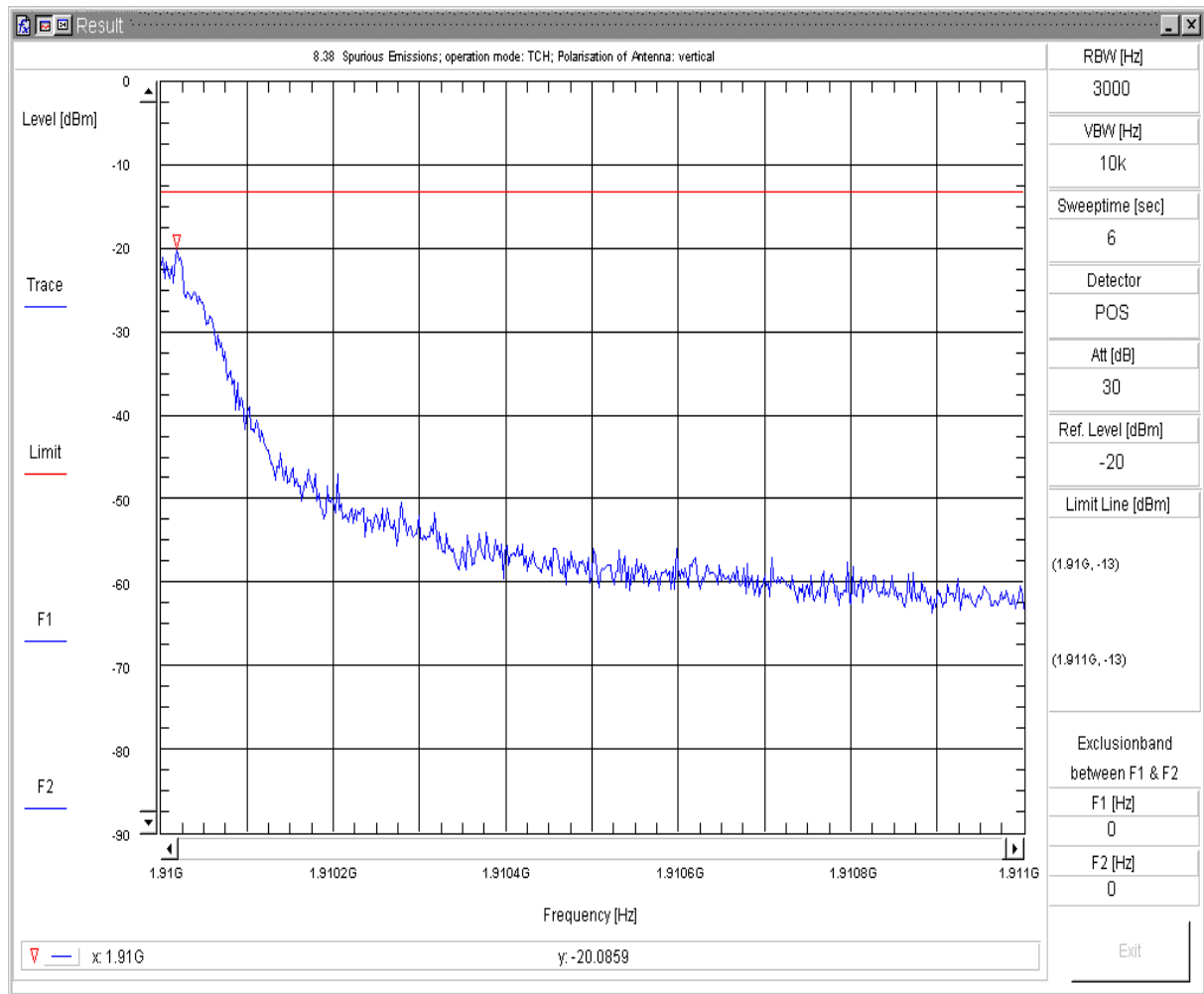

### 8.38 Radiated Spurious Emission

Transducer: c:\vee\_user\spuri\_V7\FCC\_Part24\_1900\TD\_TX\_V  
 Sweepnr: Sweep4  
 Pol. of Antenna: vertikal  
 EUT Position: EUT\_vertical+horizontal  
 EUT OP Mode: FCC\_Part24\_1900 TCH  
 EUT Description: MC55i + Board + Headset, Project 040194  
 EUT Hardware: B2.1  
 EUT Software: Rev. 00.303  
 EUT Config: C03  
 EUT S/N: IMEI: 004401080149475  
 Battery: Power Supply (external); Maximum Voltage; 4.8 VDC  
 Remark: Channel 810  
 Operator: x\_Hol  
 Testing Site: Fully Anechoic Room (FAR); CETECOM Essen

Tue 20/Nov/2007 18:09:48pf

Spurious Emissions V7.1.1

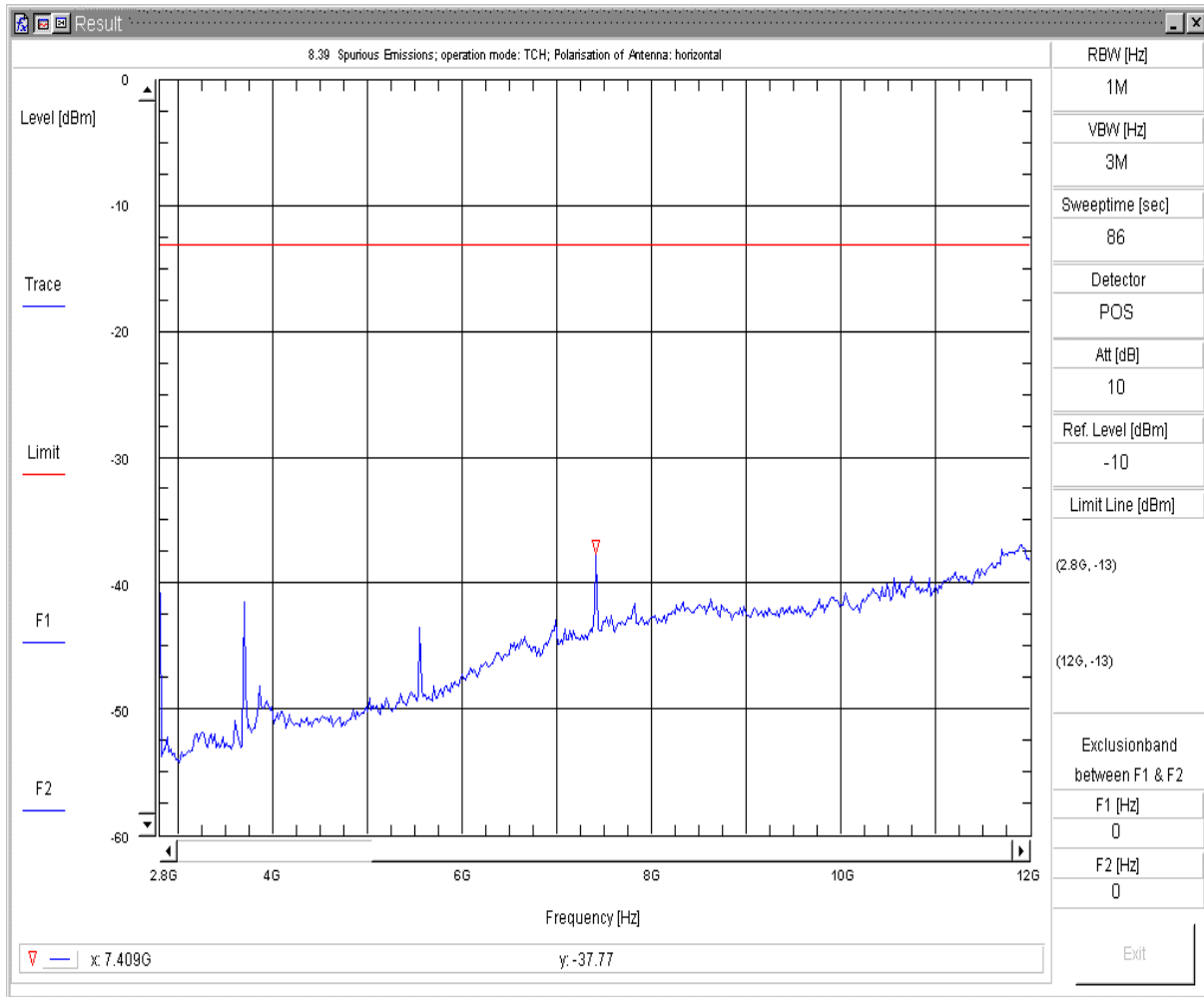

8.39 Radiated Spurious Emission

Transducer: c:\vee\_user\spuri\_V7\FCC\_Part24\_1900\TD\_TX\_H  
 Sweepnr: Sweep5  
 Pol. of Antenna: horizontal  
 EUT Position: EUT\_vertical+horizontal  
 EUT OP Mode: FCC\_Part24\_1900 TCH  
 EUT Description: MC55i + Board + Headset, Project 040194  
 EUT Hardware: B2.1  
 EUT Software: Rev. 00.303  
 EUT Config: C03  
 EUT S/N: IMEI: 004401080149475  
 Battery: Power Supply (external); Maximum Voltage; 4.8 VDC  
 Remark: Channel 512  
 Operator: x\_Hol  
 Testing Site: Fully Anechoic Room (FAR); CETECOM Essen

Tue 20/Nov/2007 18:14:14fp

Spurious Emissions V7.1.1

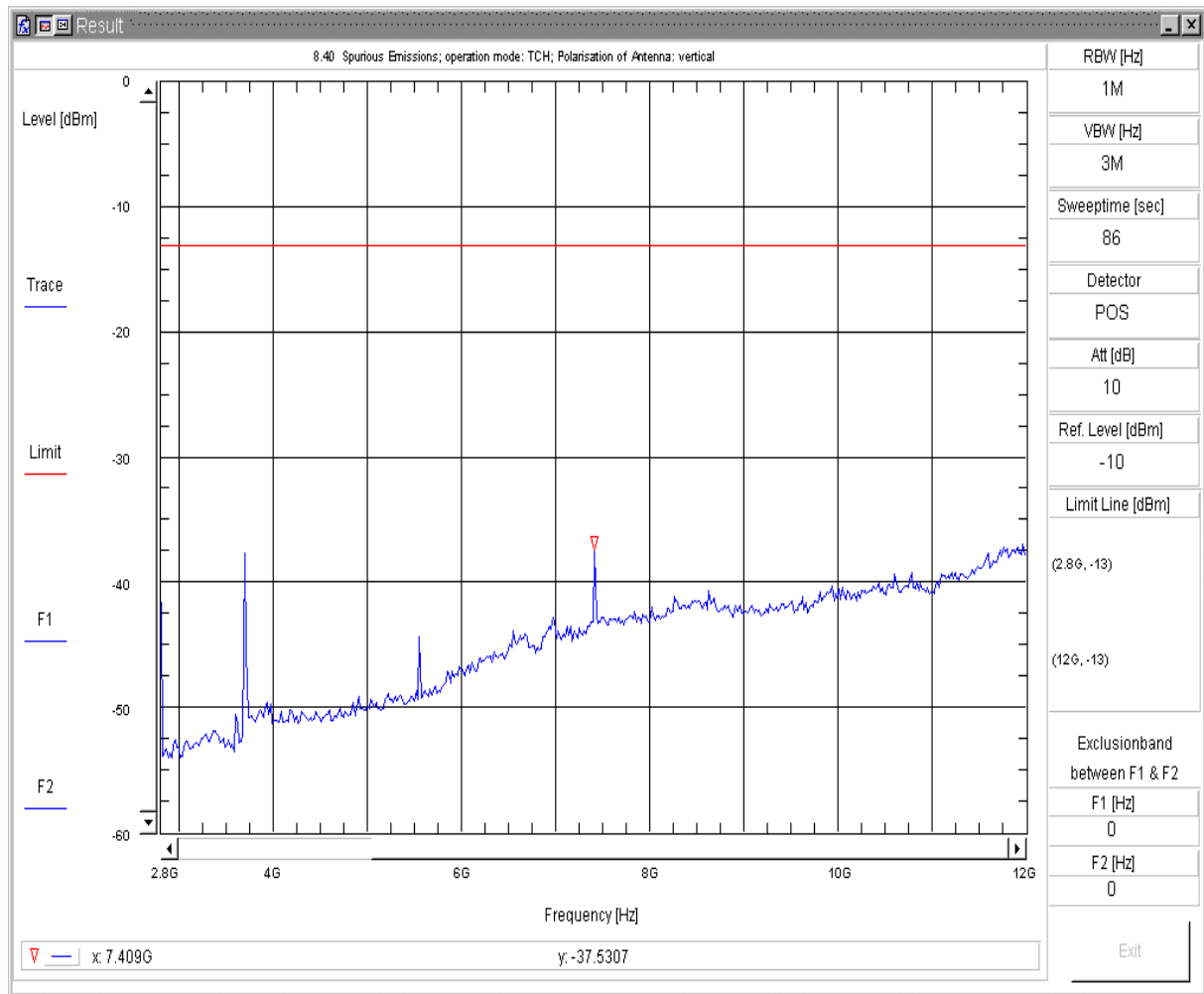

#### 8.40 Radiated Spurious Emission

Transducer: c:\vee\_user\spuri\_V7\FCC\_Part24\_1900\TD\_TX\_V  
 Sweepnr: Sweep5  
 Pol. of Antenna: vertikal  
 EUT Position: EUT\_vertical+horizontal  
 EUT OP Mode: FCC\_Part24\_1900 TCH  
 EUT Description: MC55i + Board + Headset, Project 040194  
 EUT Hardware: B2.1  
 EUT Software: Rev. 00.303  
 EUT Config: C03  
 EUT S/N: IMEI: 004401080149475  
 Battery: Power Supply (external); Maximum Voltage; 4.8 VDC  
 Remark: Channel 512  
 Operator: x\_Hol  
 Testing Site: Fully Anechoic Room (FAR); CETECOM Essen

Tue 20/Nov/2007 18:37:20fp

Spurious Emissions V7.1.1



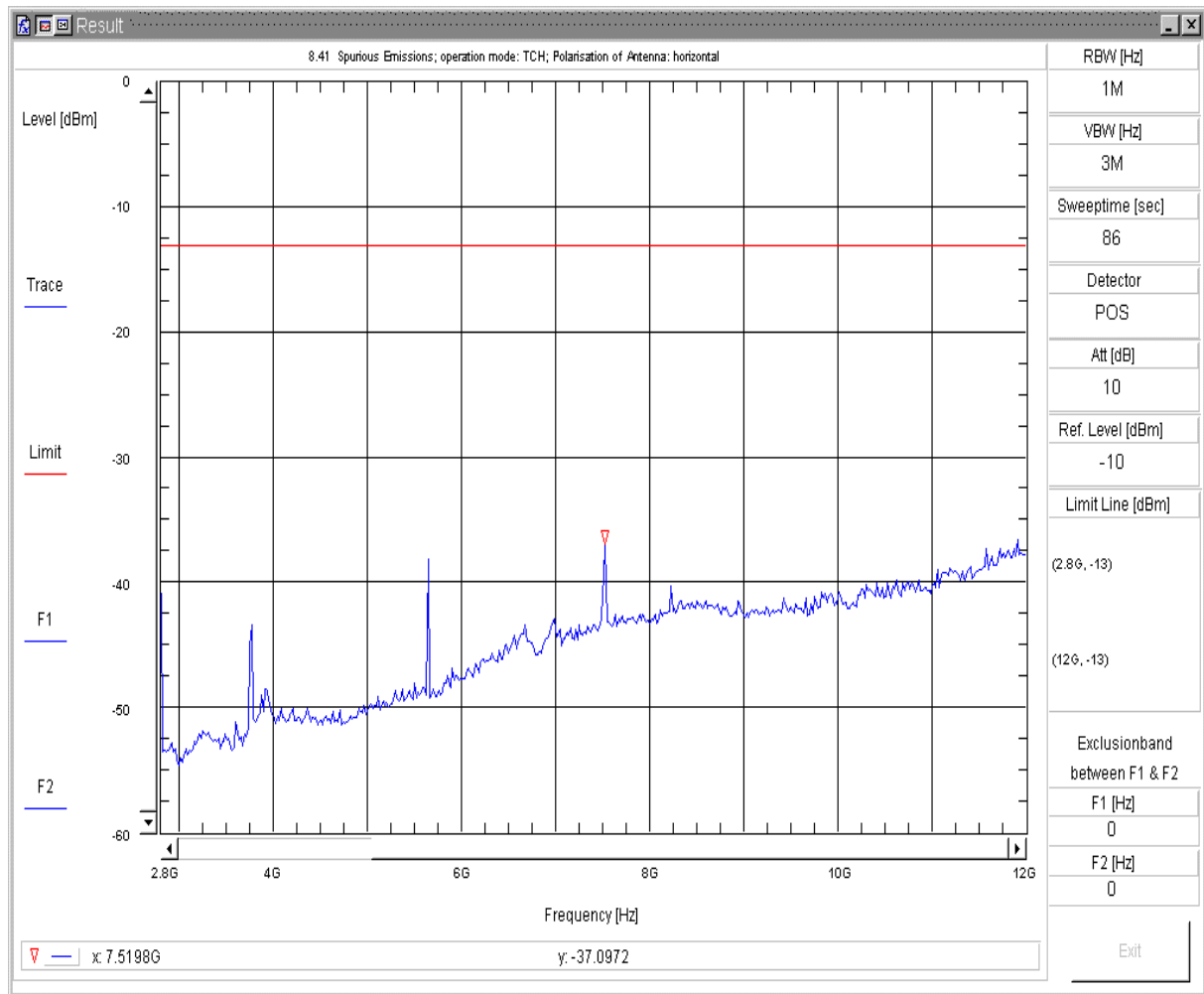

#### 8.41 Radiated Spurious Emission

Transducer: c:\vee\_user\spuri\_V7\FCC\_Part24\_1900\TD\_TX\_H  
 Sweepnr: Sweep5  
 Pol. of Antenna: horizontal  
 EUT Position: EUT\_vertical+horizontal  
 EUT OP Mode: FCC\_Part24\_1900 TCH  
 EUT Description: MC55i + Board + Headset, Project 040194  
 EUT Hardware: B2.1  
 EUT Software: Rev. 00.303  
 EUT Config: C03  
 EUT S/N: IMEI: 004401080149475  
 Battery: Power Supply (external); Maximum Voltage; 4.8 VDC  
 Remark: Channel 661  
 Operator: x\_Hol  
 Testing Site: Fully Anechoic Room (FAR); CETECOM Essen

Tue 20/Nov/2007 19:00:25fp

Spurious Emissions V7.1.1

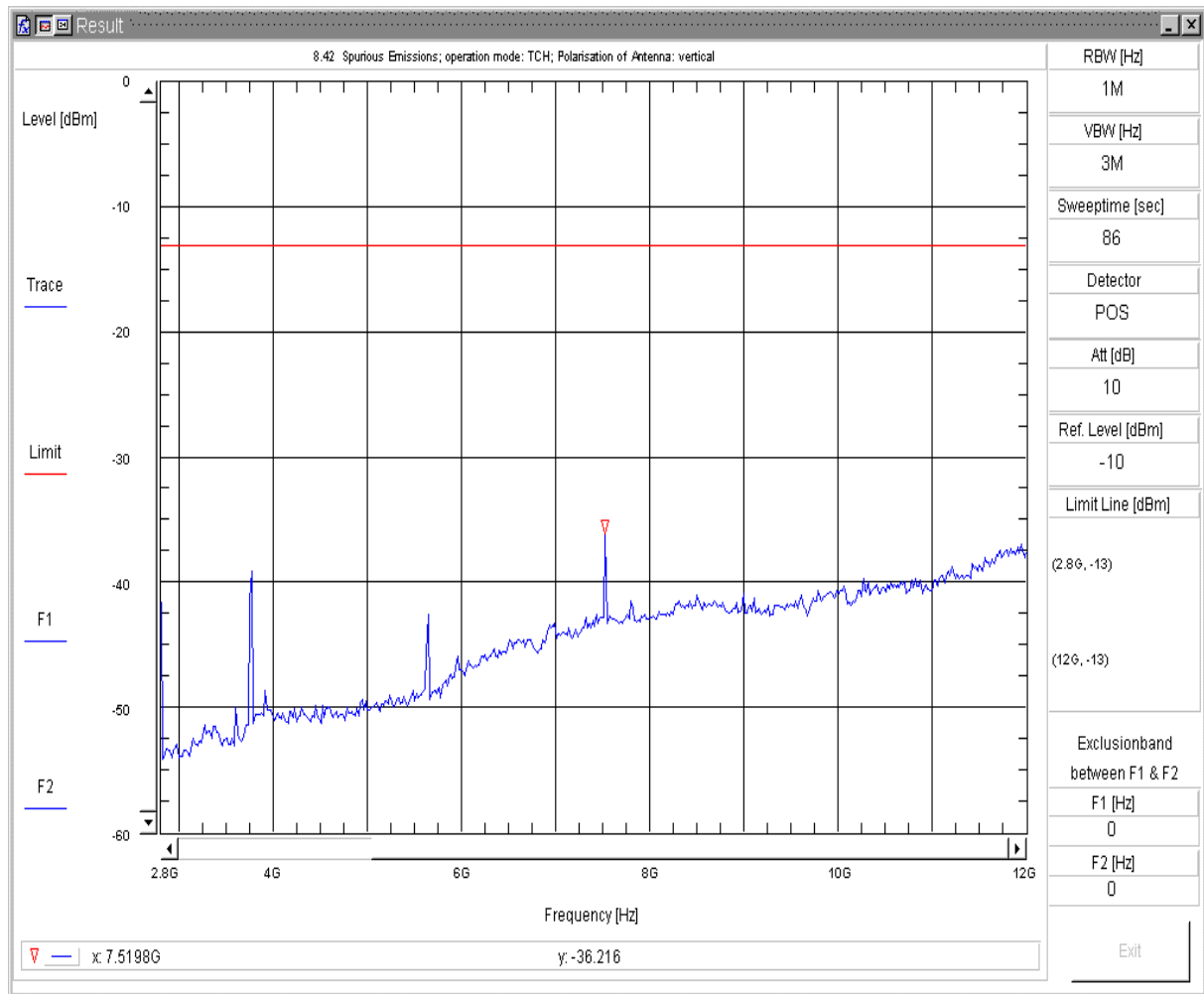

#### 8.42 Radiated Spurious Emission

Transducer: c:\vee\_user\spuri\_V7\FCC\_Part24\_1900\TD\_TX\_V  
 Sweepnr: Sweep5  
 Pol. of Antenna: vertikal  
 EUT Position: EUT\_vertical+horizontal  
 EUT OP Mode: FCC\_Part24\_1900 TCH  
 EUT Description: MC55i + Board + Headset, Project 040194  
 EUT Hardware: B2.1  
 EUT Software: Rev. 00.303  
 EUT Config: C03  
 EUT S/N: IMEI: 004401080149475  
 Battery: Power Supply (external); Maximum Voltage; 4.8 VDC  
 Remark: Channel 661  
 Operator: x\_Hol  
 Testing Site: Fully Anechoic Room (FAR); CETECOM Essen

Tue 20/Nov/2007 19:23:23fp

Spurious Emissions V7.1.1

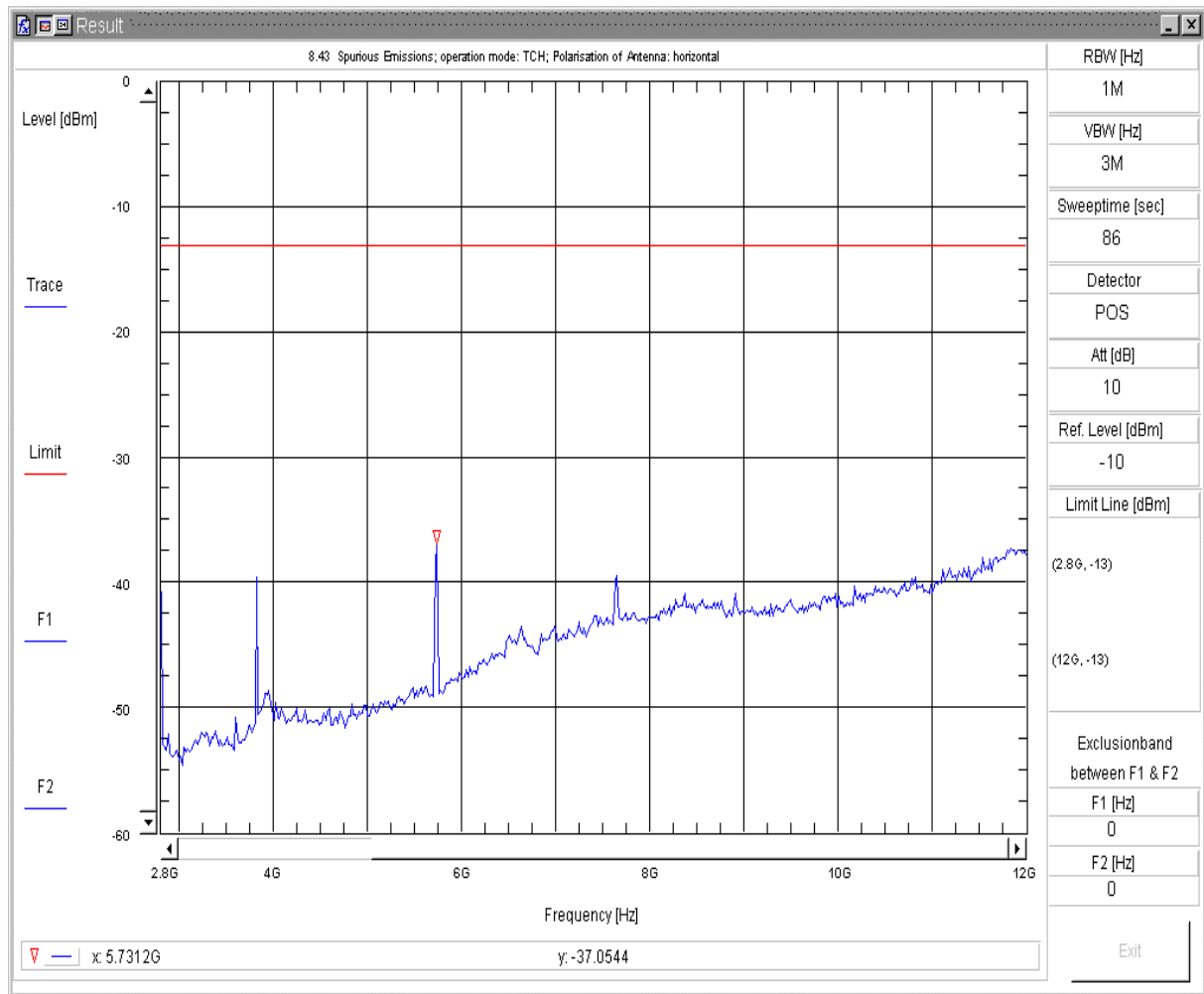

### 8.43 Radiated Spurious Emission

Transducer: c:\vee\_user\spuri\_V7\FCC\_Part24\_1900\TD\_TX\_H  
 Sweepnr: Sweep5  
 Pol. of Antenna: horizontal  
 EUT Position: EUT\_vertical+horizontal  
 EUT OP Mode: FCC\_Part24\_1900 TCH  
 EUT Description: MC55i + Board + Headset, Project 040194  
 EUT Hardware: B2.1  
 EUT Software: Rev. 00.303  
 EUT Config: C03  
 EUT S/N: IMEI: 004401080149475  
 Battery: Power Supply (external); Maximum Voltage; 4.8 VDC  
 Remark: Channel 810  
 Operator: x\_Hol  
 Testing Site: Fully Anechoic Room (FAR); CETECOM Essen

Tue 20/Nov/2007 19:47:26fp

Spurious Emissions V7.1.1

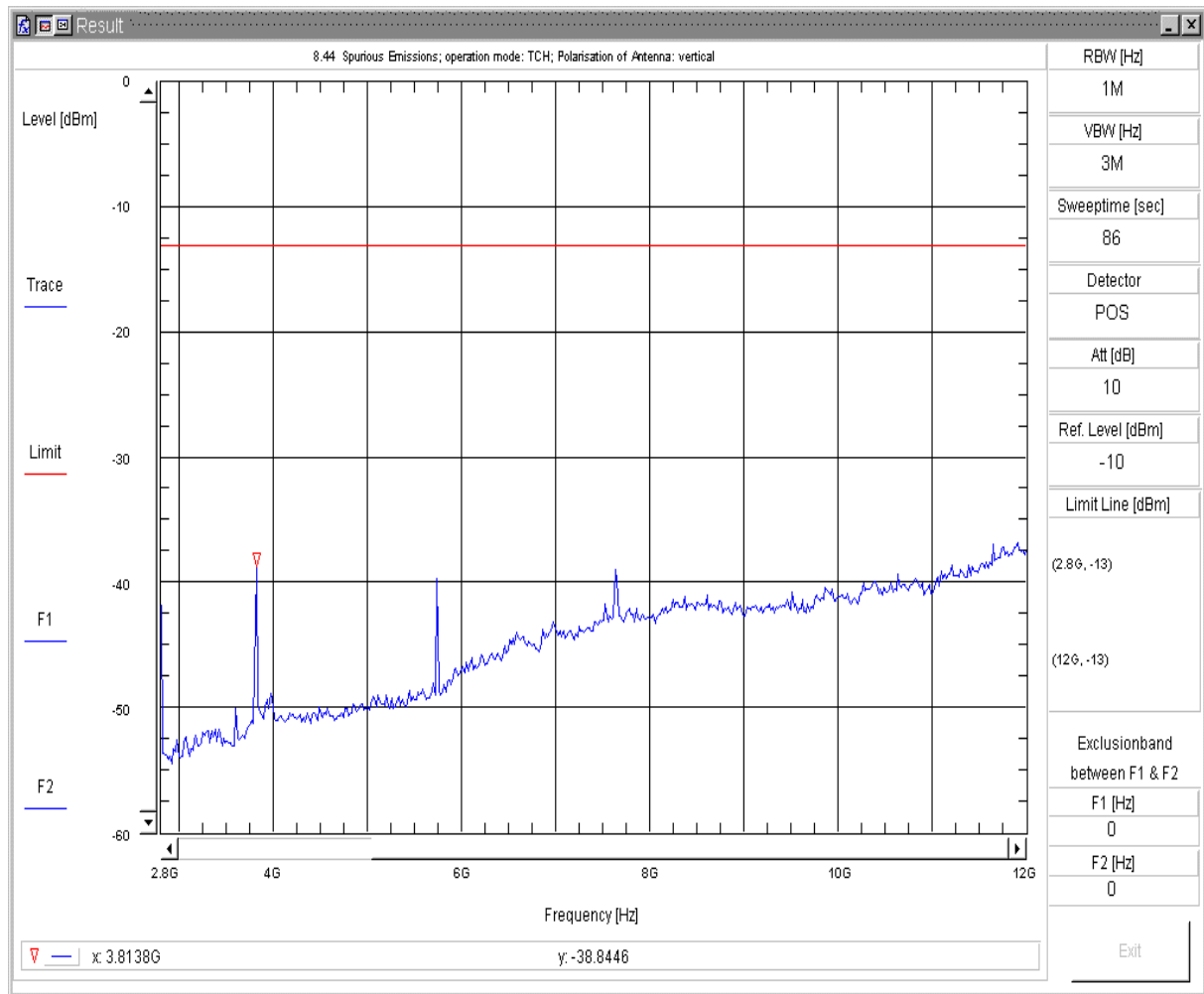

#### 8.44 Radiated Spurious Emission

Transducer: c:\vee\_user\spuri\_V7\FCC\_Part24\_1900\TD\_TX\_V  
 Sweepnr: Sweep5  
 Pol. of Antenna: vertikal  
 EUT Position: EUT\_vertical+horizontal  
 EUT OP Mode: FCC\_Part24\_1900 TCH  
 EUT Description: MC55i + Board + Headset, Project 040194  
 EUT Hardware: B2.1  
 EUT Software: Rev. 00.303  
 EUT Config: C03  
 EUT S/N: IMEI: 004401080149475  
 Battery: Power Supply (external); Maximum Voltage; 4.8 VDC  
 Remark: Channel 810  
 Operator: x\_Hol  
 Testing Site: Fully Anechoic Room (FAR); CETECOM Essen

Tue 20/Nov/2007 20:10:33fp

Spurious Emissions V7.1.1

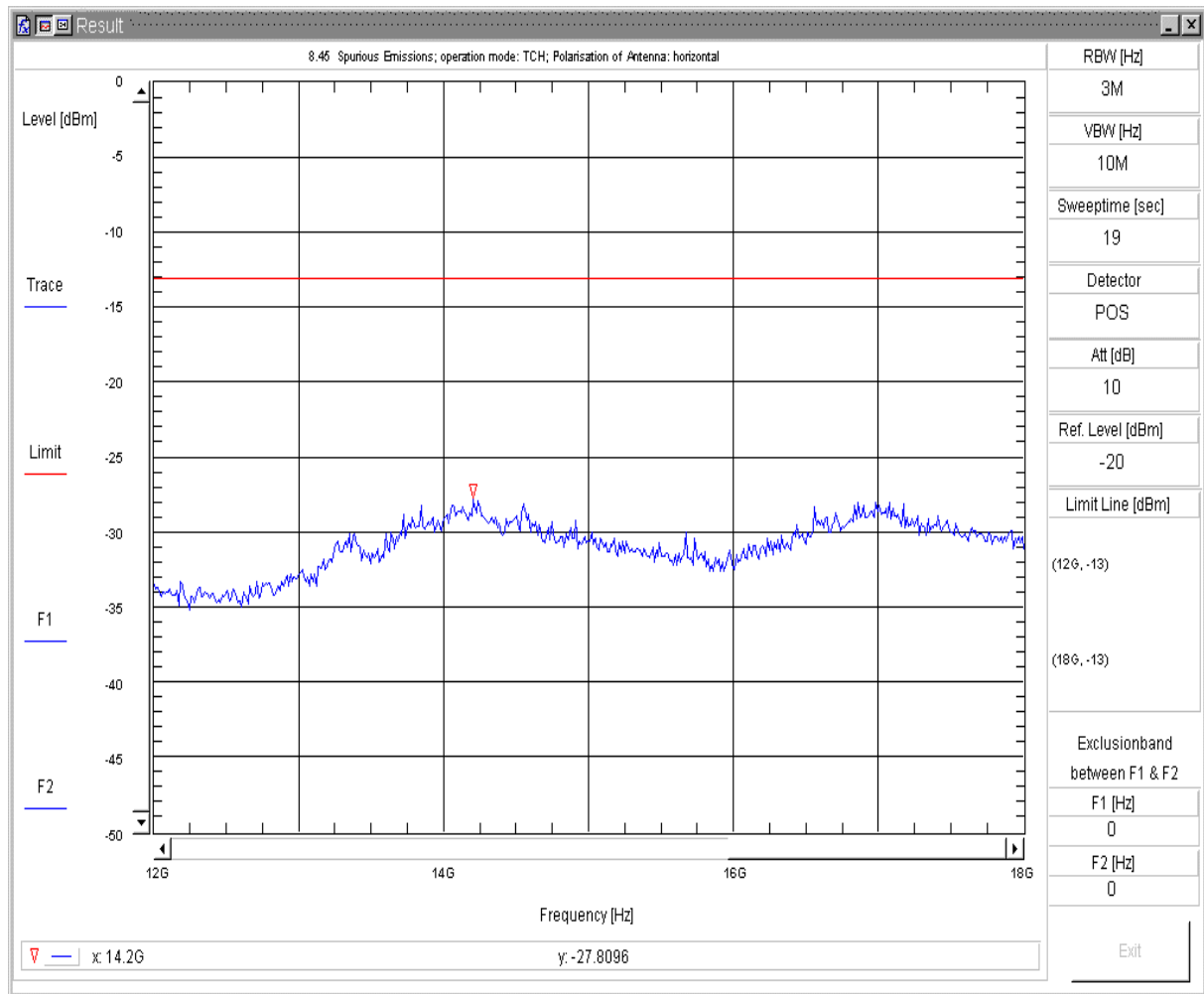

#### 8.45 Radiated Spurious Emission

Transducer: c:\vee\_user\spuri\_V7\FCC\_Part24\_1900\TD\_TX\_H  
 Sweepnr: Sweep6  
 Pol. of Antenna: horizontal  
 EUT Position: EUT\_vertical+horizontal  
 EUT OP Mode: FCC\_Part24\_1900 TCH  
 EUT Description: MC55i + Board + Headset, Project 040194  
 EUT Hardware: B2.1  
 EUT Software: Rev. 00.303  
 EUT Config: C03  
 EUT S/N: IMEI: 004401080149475  
 Battery: Power Supply (external); Maximum Voltage; 4.8 VDC  
 Remark: Channel 512  
 Operator: x\_Hol  
 Testing Site: Fully Anechoic Room (FAR); CETECOM Essen

Tue 20/Nov/2007 20:33:45fp

Spurious Emissions V7.1.1

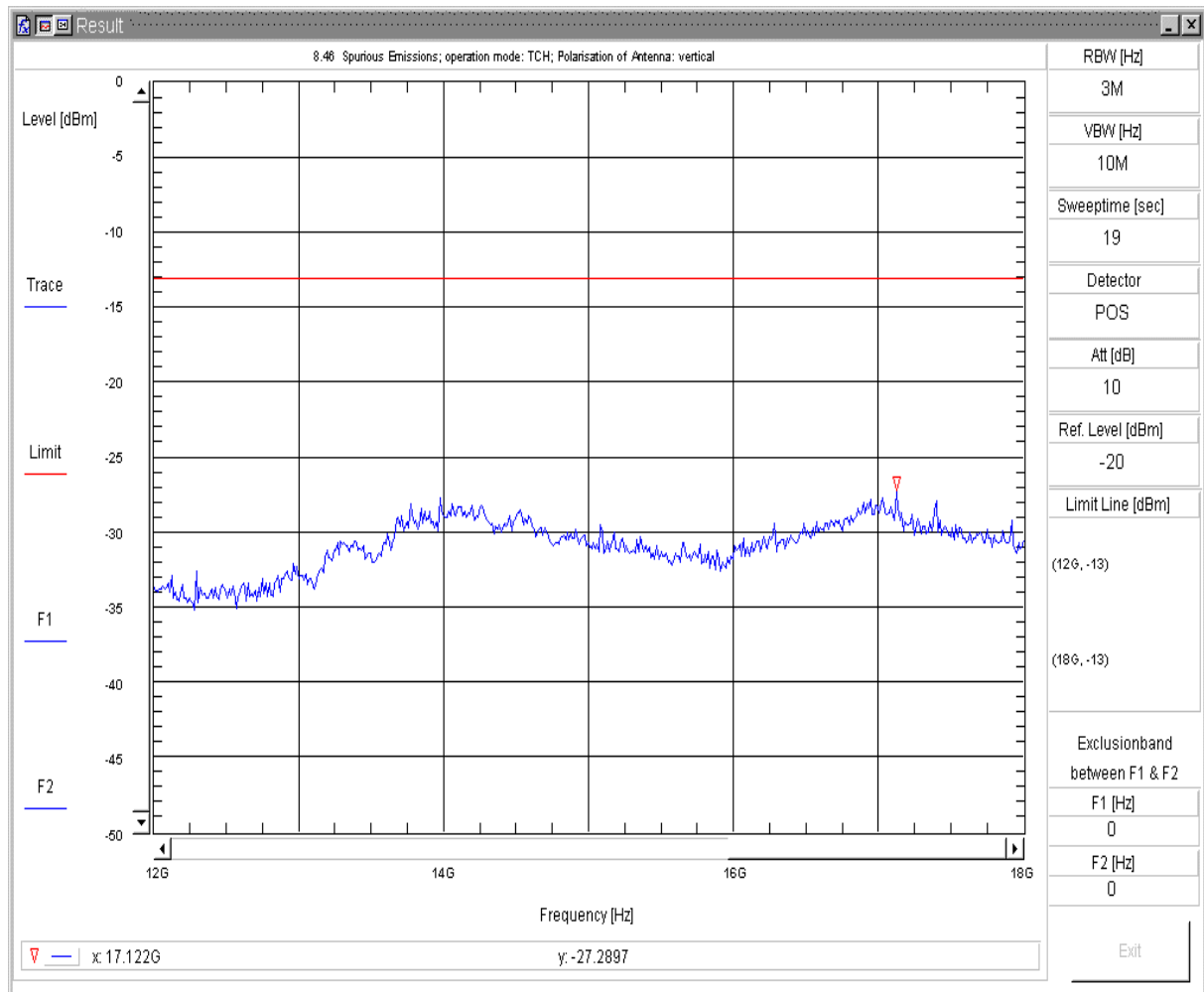

#### 8.46 Radiated Spurious Emission

Transducer: c:\vee\_user\spuri\_V7\FCC\_Part24\_1900\TD\_TX\_V  
 Sweepnr: Sweep6  
 Pol. of Antenna: vertikal  
 EUT Position: EUT\_vertical+horizontal  
 EUT OP Mode: FCC\_Part24\_1900 TCH  
 EUT Description: MC55i + Board + Headset, Project 040194  
 EUT Hardware: B2.1  
 EUT Software: Rev. 00.303  
 EUT Config: C03  
 EUT S/N: IMEI: 004401080149475  
 Battery: Power Supply (external); Maximum Voltage; 4.8 VDC  
 Remark: Channel 512  
 Operator: x\_Hol  
 Testing Site: Fully Anechoic Room (FAR); CETECOM Essen

Tue 20/Nov/2007 20:41:08fp

Spurious Emissions V7.1.1

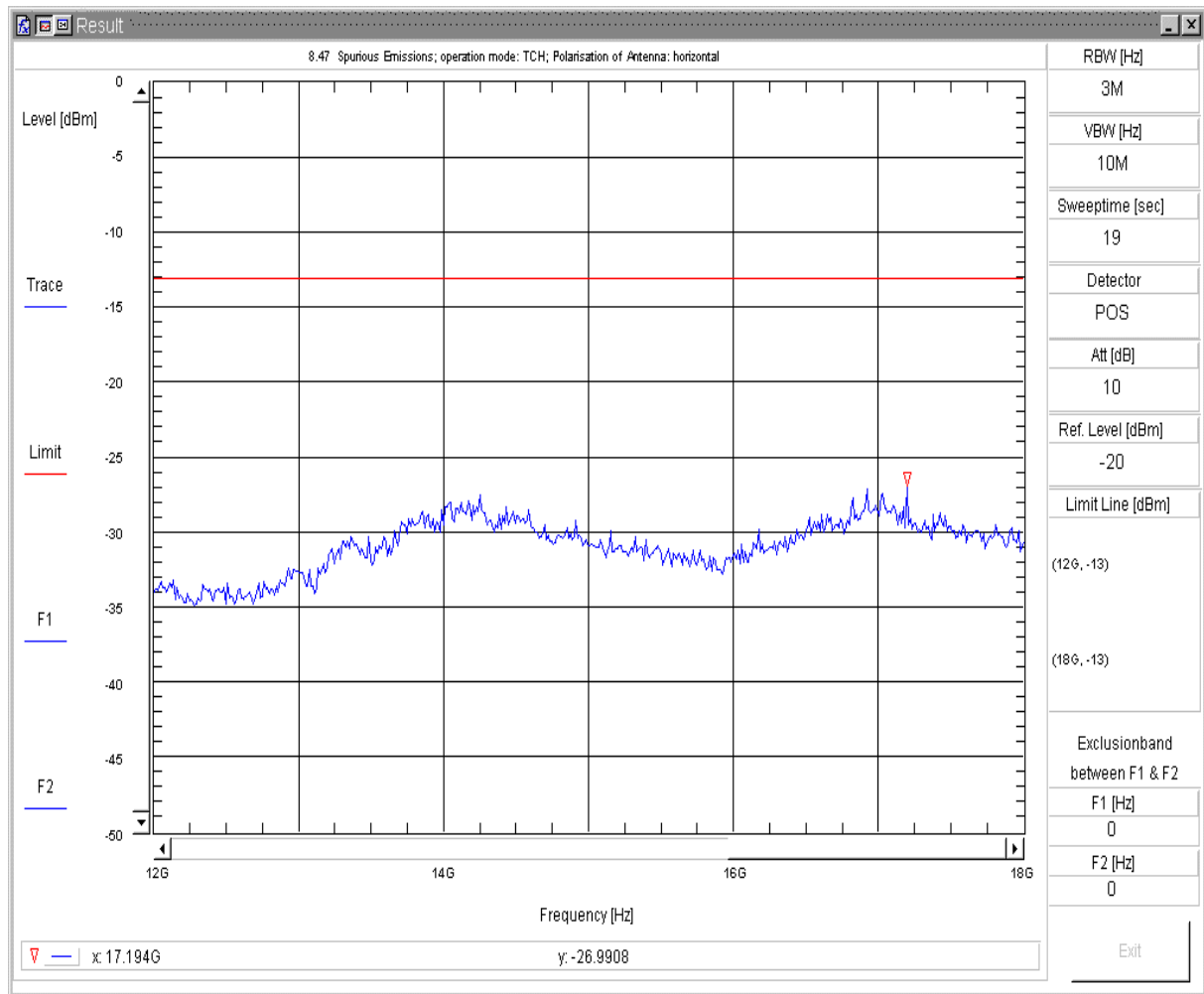

#### 8.47 Radiated Spurious Emission

Transducer: c:\vee\_user\spuri\_V7\FCC\_Part24\_1900\TD\_TX\_H  
 Sweepnr: Sweep6  
 Pol. of Antenna: horizontal  
 EUT Position: EUT\_vertical+horizontal  
 EUT OP Mode: FCC\_Part24\_1900 TCH  
 EUT Description: MC55i + Board + Headset, Project 040194  
 EUT Hardware: B2.1  
 EUT Software: Rev. 00.303  
 EUT Config: C03  
 EUT S/N: IMEI: 004401080149475  
 Battery: Power Supply (external); Maximum Voltage; 4.8 VDC  
 Remark: Channel 661  
 Operator: x\_Hol  
 Testing Site: Fully Anechoic Room (FAR); CETECOM Essen

Tue 20/Nov/2007 20:48:39fp

Spurious Emissions V7.1.1

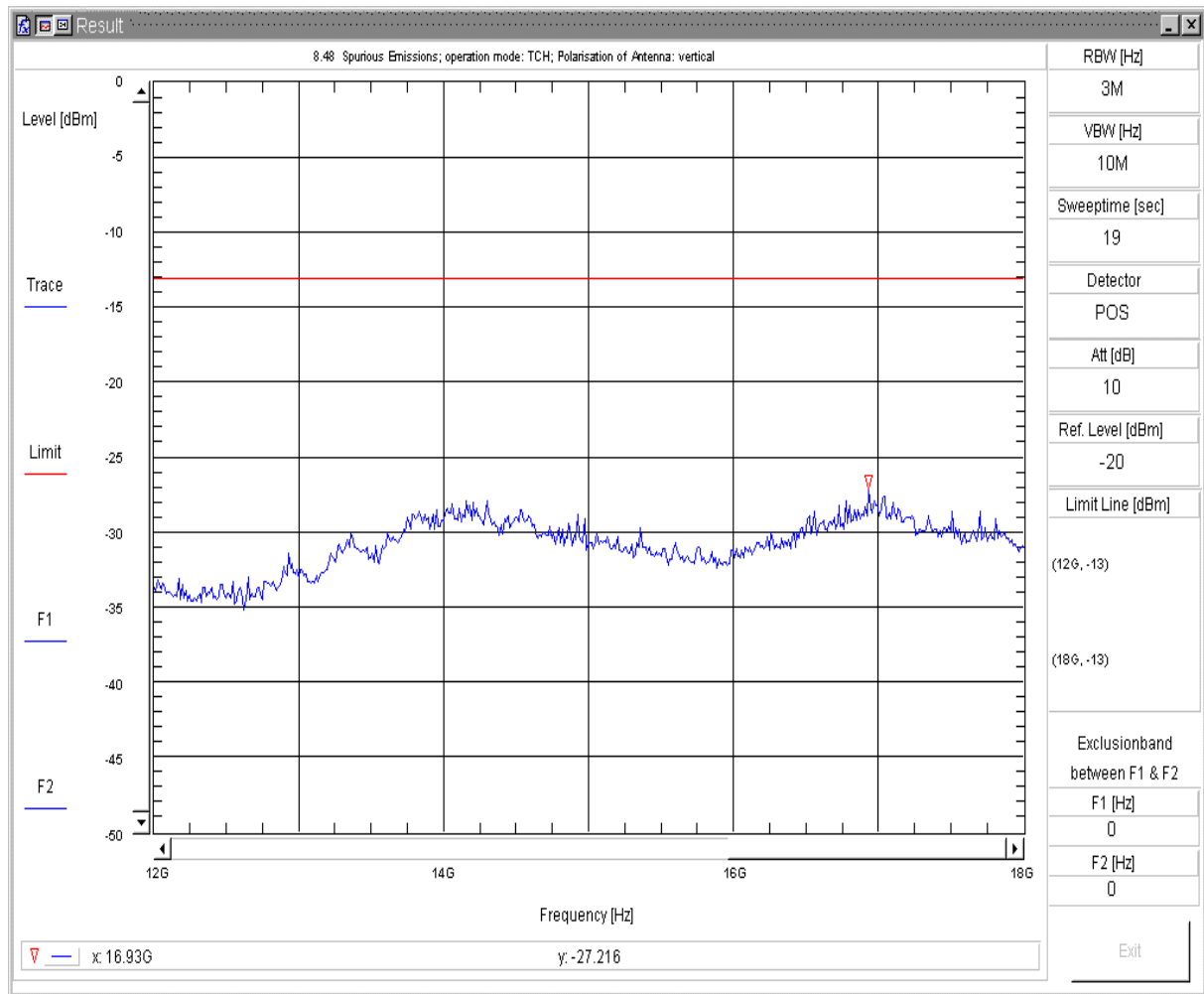

#### 8.48 Radiated Spurious Emission

Transducer: c:\vee\_user\spuri\_V7\FCC\_Part24\_1900\TD\_TX\_V  
 Sweepnr: Sweep6  
 Pol. of Antenna: vertikal  
 EUT Position: EUT\_vertikal+horizontal  
 EUT OP Mode: FCC\_Part24\_1900 TCH  
 EUT Description: MC55i + Board + Headset, Project 040194  
 EUT Hardware: B2.1  
 EUT Software: Rev. 00.303  
 EUT Config: C03  
 EUT S/N: IMEI: 004401080149475  
 Battery: Power Supply (external); Maximum Voltage; 4.8 VDC  
 Remark: Channel 661  
 Operator: x\_Hol  
 Testing Site: Fully Anechoic Room (FAR); CETECOM Essen

Tue 20/Nov/2007 20:55:51fp

Spurious Emissions V7.1.1



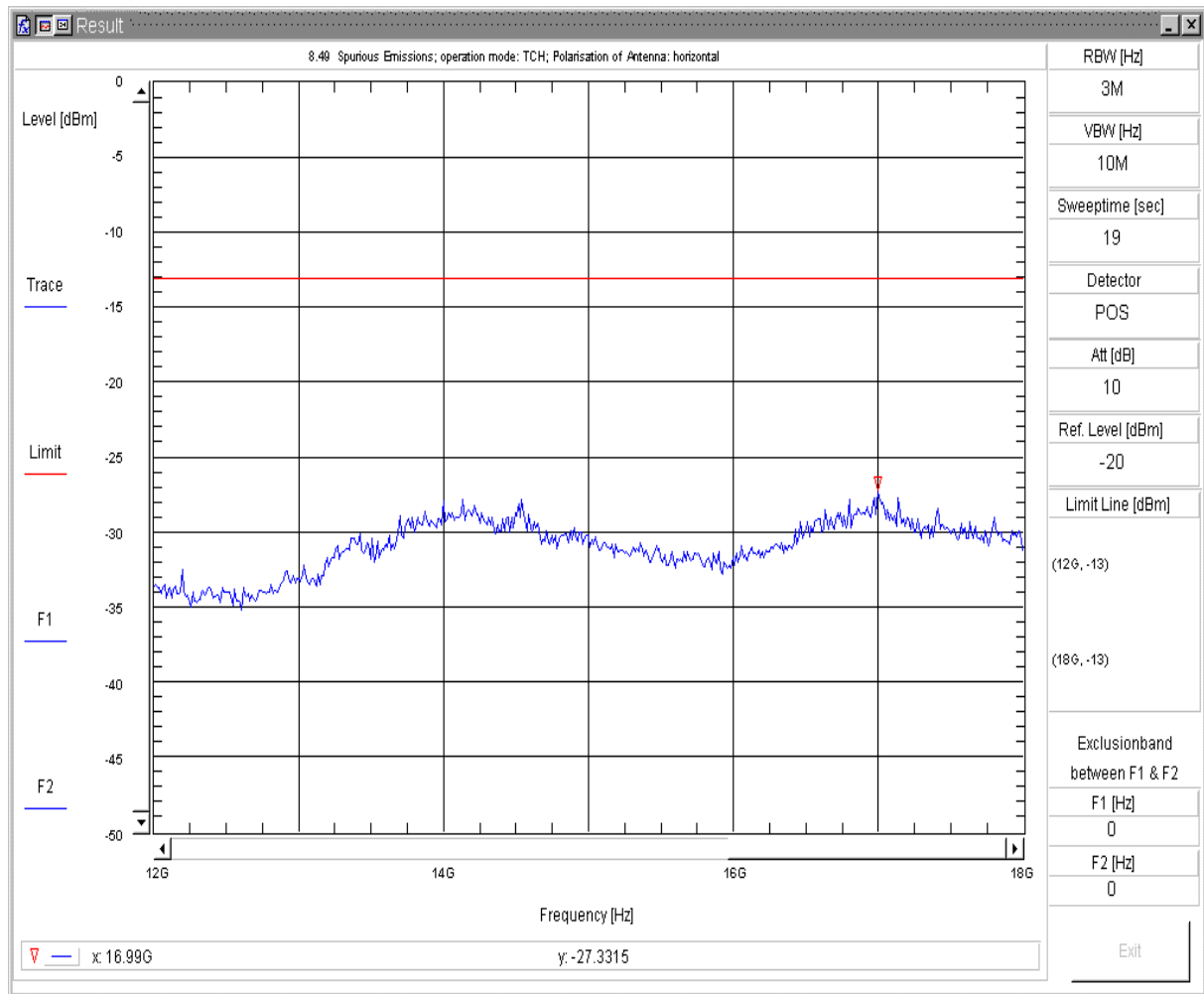

#### 8.49 Radiated Spurious Emission

Transducer: c:\vee\_user\spuri\_V7\FCC\_Part24\_1900\TD\_TX\_H  
 Sweepnr: Sweep6  
 Pol. of Antenna: horizontal  
 EUT Position: EUT\_vertical+horizontal  
 EUT OP Mode: FCC\_Part24\_1900 TCH  
 EUT Description: MC55i + Board + Headset, Project 040194  
 EUT Hardware: B2.1  
 EUT Software: Rev. 00.303  
 EUT Config: C03  
 EUT S/N: IMEI: 004401080149475  
 Battery: Power Supply (external); Maximum Voltage; 4.8 VDC  
 Remark: Channel 810  
 Operator: x\_Hol  
 Testing Site: Fully Anechoic Room (FAR); CETECOM Essen

Tue 20/Nov/2007 21:03:50fp

Spurious Emissions V7.1.1

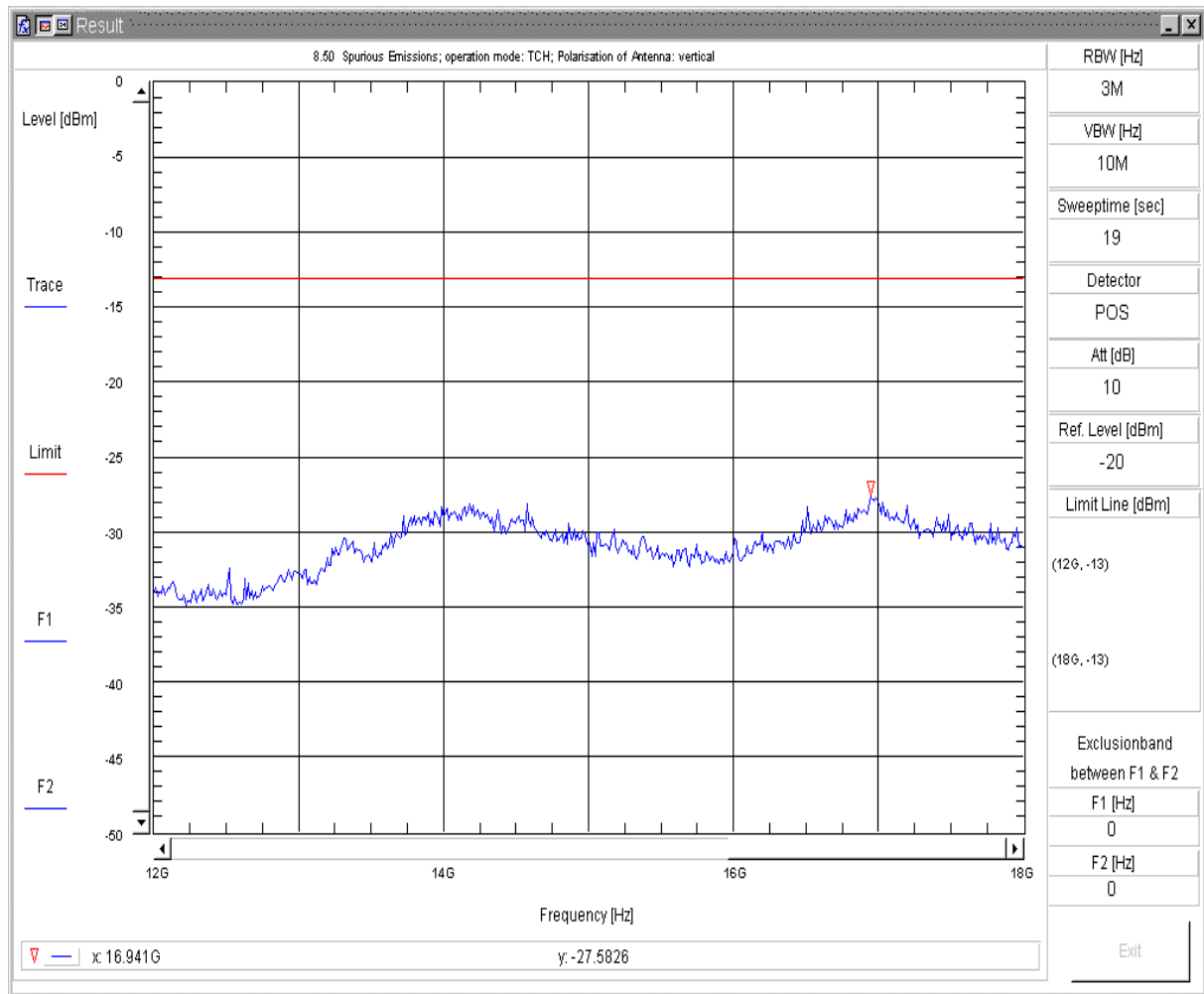

### 8.50 Radiated Spurious Emission

Transducer: c:\vee\_user\spuri\_V7\FCC\_Part24\_1900\TD\_TX\_V  
 Sweepnr: Sweep6  
 Pol. of Antenna: vertikal  
 EUT Position: EUT\_vertical+horizontal  
 EUT OP Mode: FCC\_Part24\_1900 TCH  
 EUT Description: MC55i + Board + Headset, Project 040194  
 EUT Hardware: B2.1  
 EUT Software: Rev. 00.303  
 EUT Config: C03  
 EUT S/N: IMEI: 004401080149475  
 Battery: Power Supply (external); Maximum Voltage; 4.8 VDC  
 Remark: Channel 810  
 Operator: x\_Hol  
 Testing Site: Fully Anechoic Room (FAR); CETECOM Essen

Tue 20/Nov/2007 21:13:38fp

Spurious Emissions V7.1.1

## 9.5. MAGNETIC FIELD STRENGTH MEASUREMENTS (RADIATED)

### Diagram No. 02.07

#### Common Information

Test description:	Magnetic Fieldstrength Measurement related to 3 m distance
Test site and distance:	Semi Anechoic Room (SAR) with 3 m measurement distance
Distance correction:	
Measured sides of EUT:	front, right, rear, left, op, under
Turntable step:	90° during pre-scan, continuously turning during final measurement
Used filter:	
Test specification.:	FCC 15_209, Intentional Transmitter
EUT:	MC55i + Board+ Headset
Manufacturer:	Siemens
Operator:	Lor
Operating conditions:	TCH 850
Signalling:	Channel 128
Comment 1:	Antenna vector in direction of EUT

#### FCC\_MG\_FELD\_PK\_FAST\_H&V\_EUT

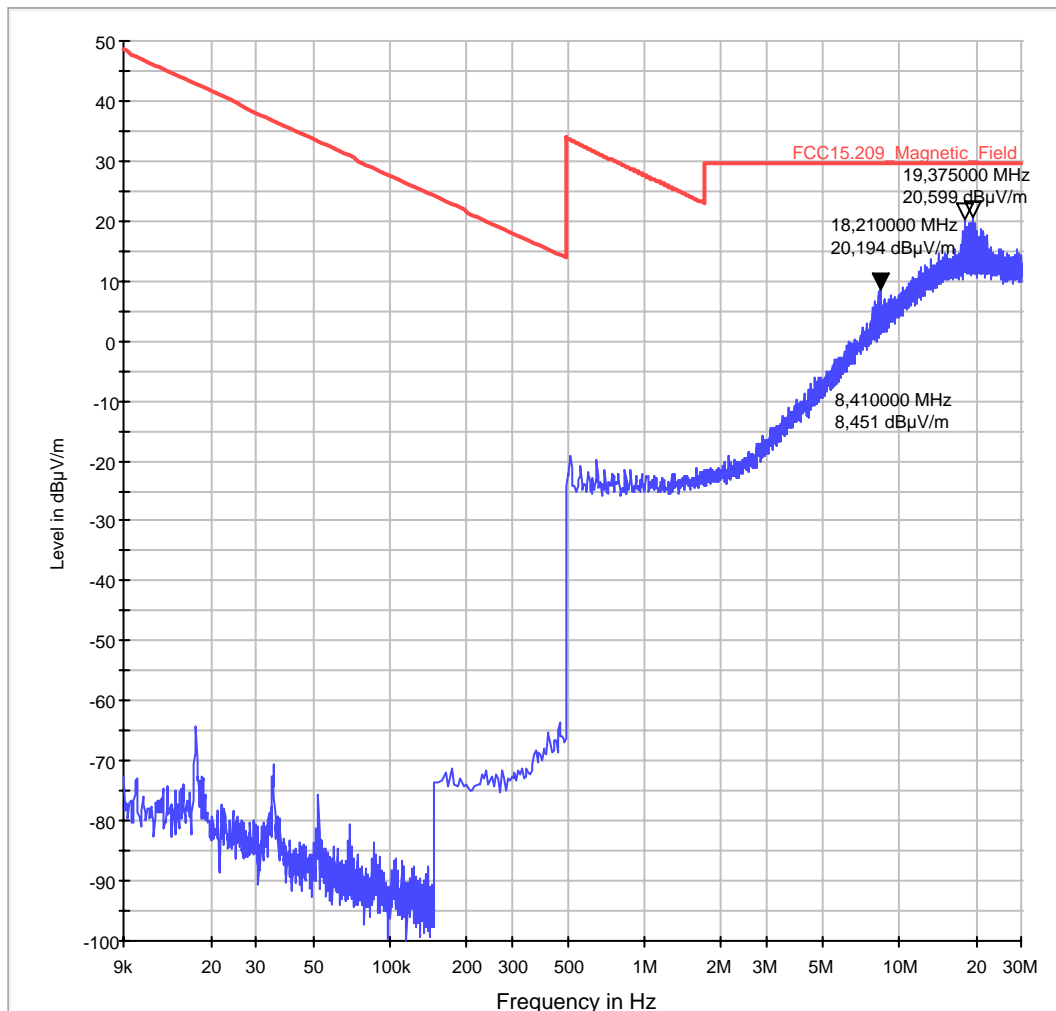

## Diagram No. 02.08

### Common Information

Test description:	Magnetic Fieldstrength Measurement related to 3 m distance
Test site and distance:	Semi Anechoic Room (SAR) with 3 m measurement distance
Distance correction:	
Measured sides of EUT:	front, right, rear, left, top, under
Turntable step:	90° during pre-scan, continuously turning during final measurement
Used filter:	no
Test specification.:	FCC 15_209, Intentional radiator

EUT:	MC55i + Board+Headset
Manufacturer:	Siemens
Operator:	Lor
Operating conditions:	TCH 850
Signalling:	Channel 128
Comment 1:	Antenna right angle to EUT

### FCC\_MG\_FELD\_PK\_FAST\_H&V\_EUT

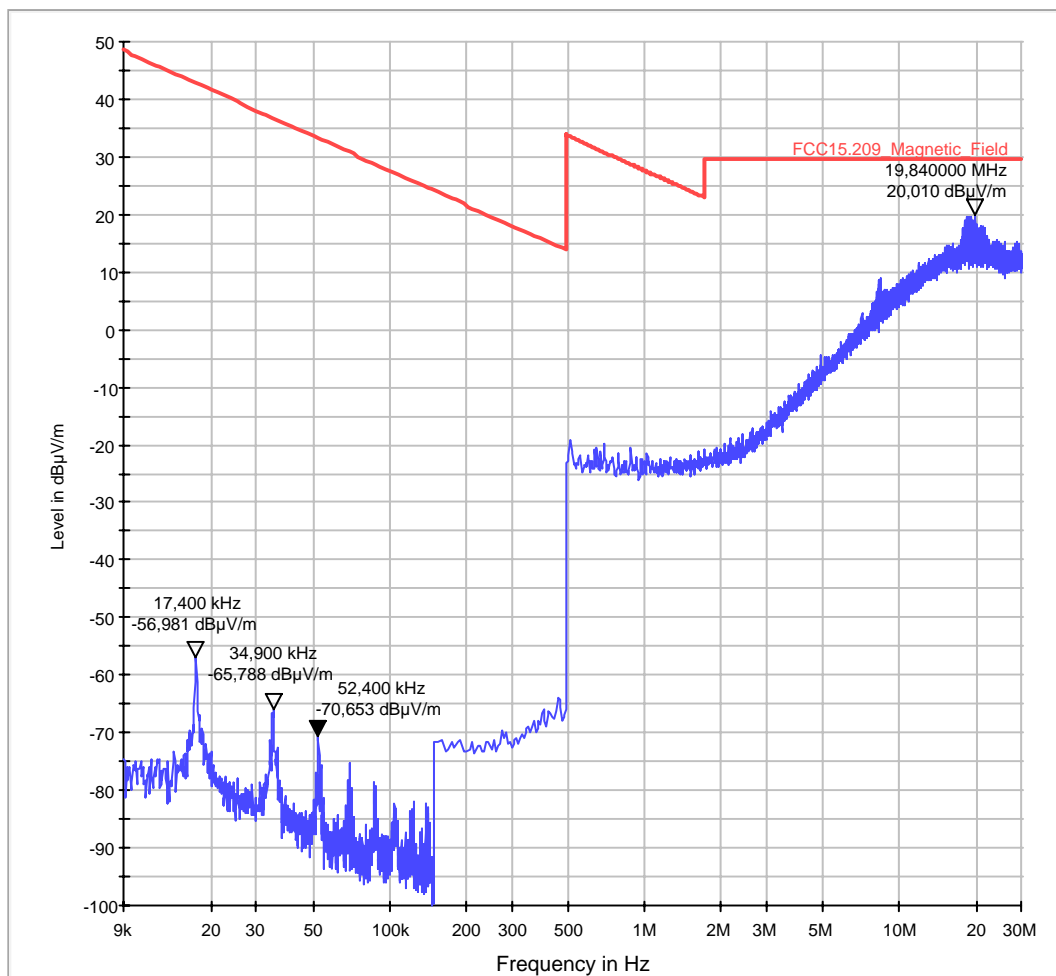

## Diagram No. 02.09

### Common Information

Test site and distance:	Semi Anechoic Room (SAR) with 3 m measurement distance
Distance correction:	
Measured sides of EUT:	front, right, rear, left, top, under
Rec. antenna:	height 1.00 m
Turntable step:	90° during pre-scan, continuously turning during final measurement
Test specification.:	FCC 15_209 Intentional Radiator
EUT:	MC55i + Board + Headset
Manufacturer:	Siemens
Operator:	Lor
Operating conditions:	TCH 850
Signalling:	channel 192+ 251
Remark:	Antenna vector right angle to EUT

### FCC\_MG\_FELD\_PK\_FAST\_H&V\_EUT

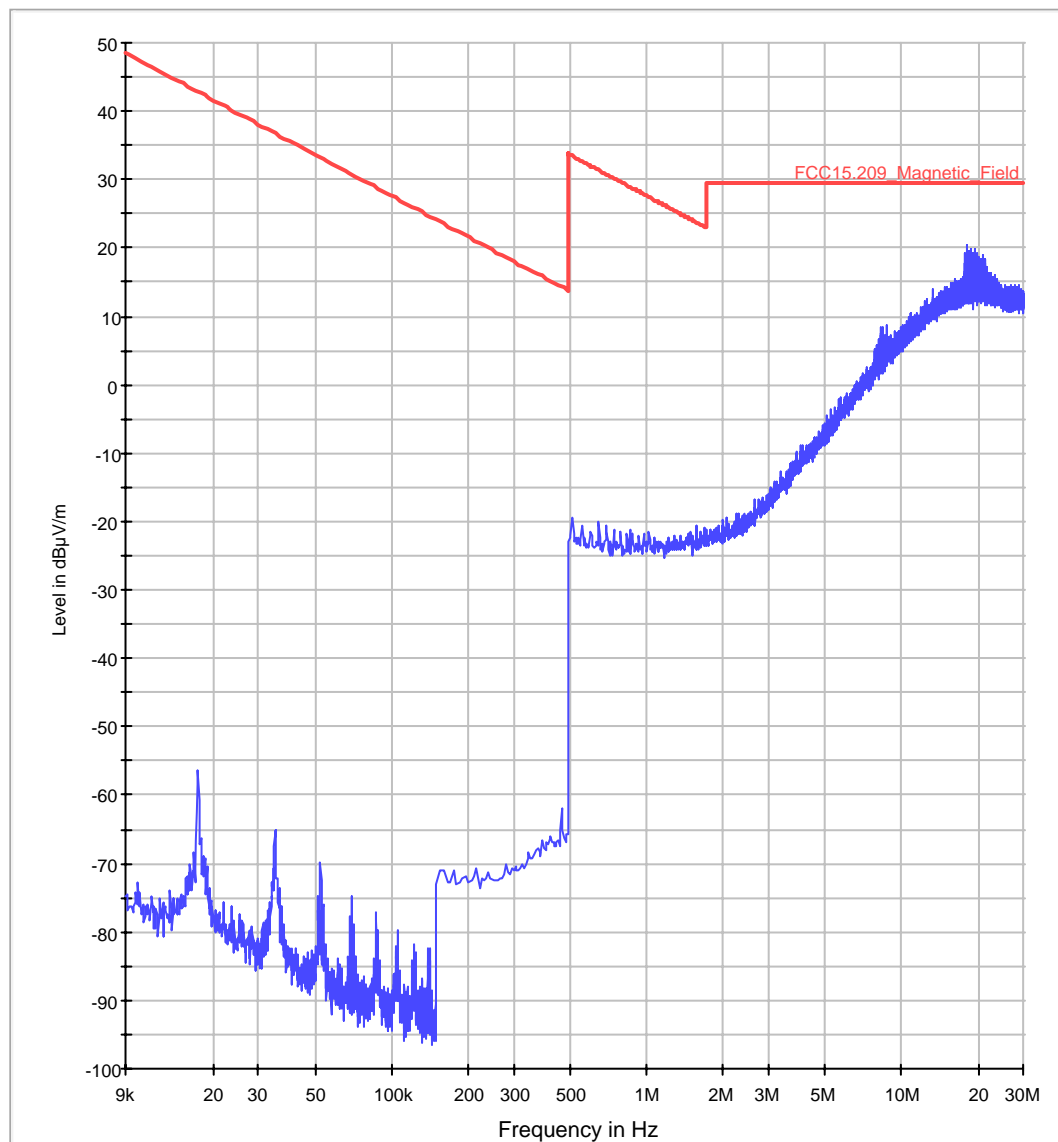

## Diagram No. 02.10

### Common Information

Test description:	Magnetic Fieldstrength Measurement related to 3 m distance
Test site and distance:	Semi Anechoic Room (SAR) with 3 m measurement distance
Rec. antenna:	height 1.00 m
Turntable step:	90° during pre-scan, continuously turning during final measurement
EUT:	MC55i + board + Headset
Manufacturer:	Siemens
Operator:	Lor
Operating conditions:	TCH 850
Signalling:	Channel 192+251
Comment 1:	Antenna vector in direction of EUT

### FCC\_MG\_FELD\_PK\_FAST\_H&V\_EUT

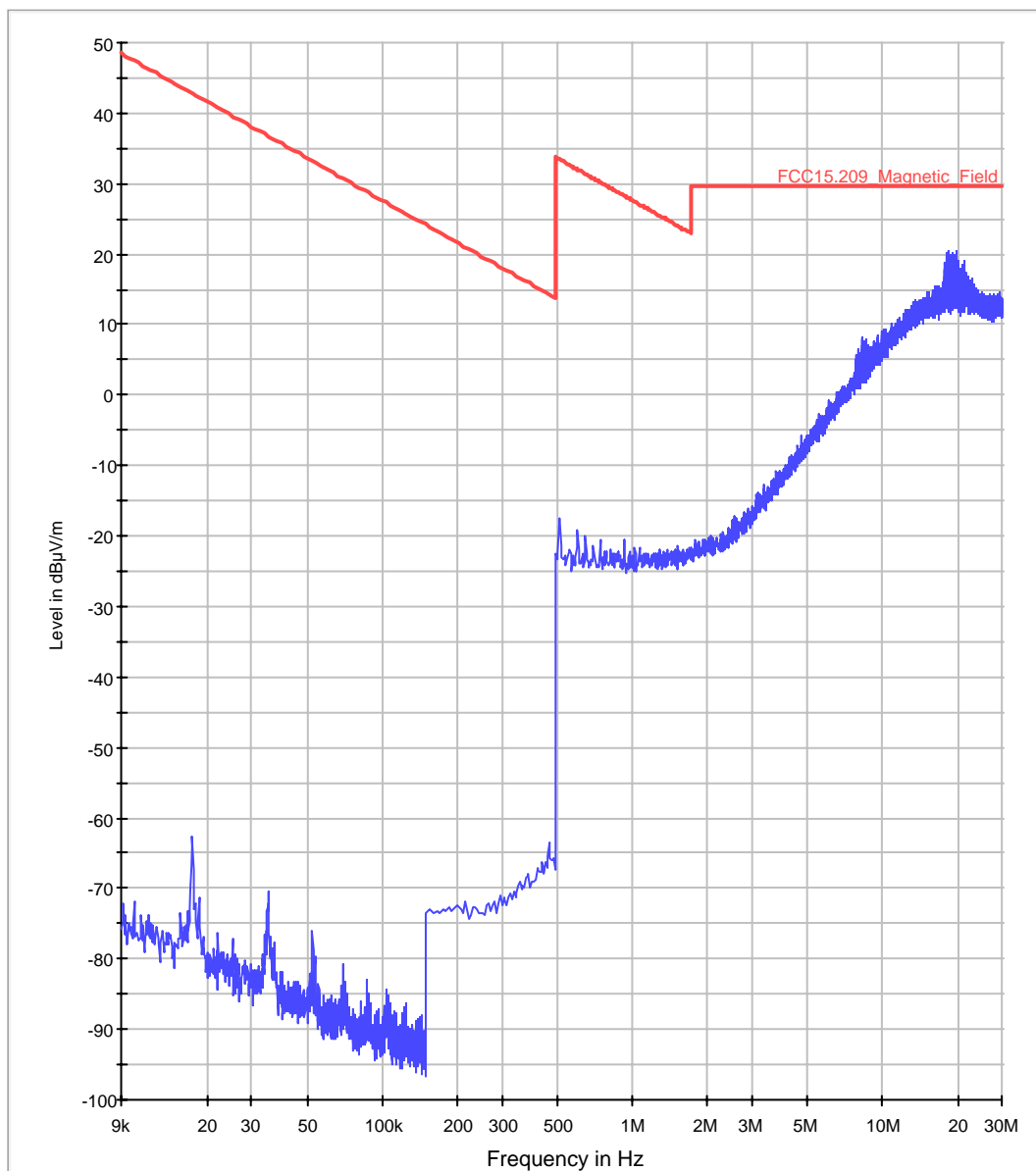

## Diagram No. 02.11

### Common Information

Test description:	Magnetic Fieldstrength Measurement related to 3 m distance
Test site and distance:	Semi Anechoic Room (SAR) with 3 m measurement distance
Rec. antenna (pre-scan):	front, right, rear, left, top, under
Rec. antenna:	1m
Turntable step:	90° during pre-scan, continuously turning during final measurement
Test specification.:	FCC 15_209 Intentional radiator
EUT:	MC55i + Board + Headset
Manufacturer:	Siemens
Operator:	Lor
Operating conditions:	TCH 1900
Signalling:	Channel 512 / 661/ 810

### FCC\_MG\_FELD\_PK\_FAST\_H&V\_EUT

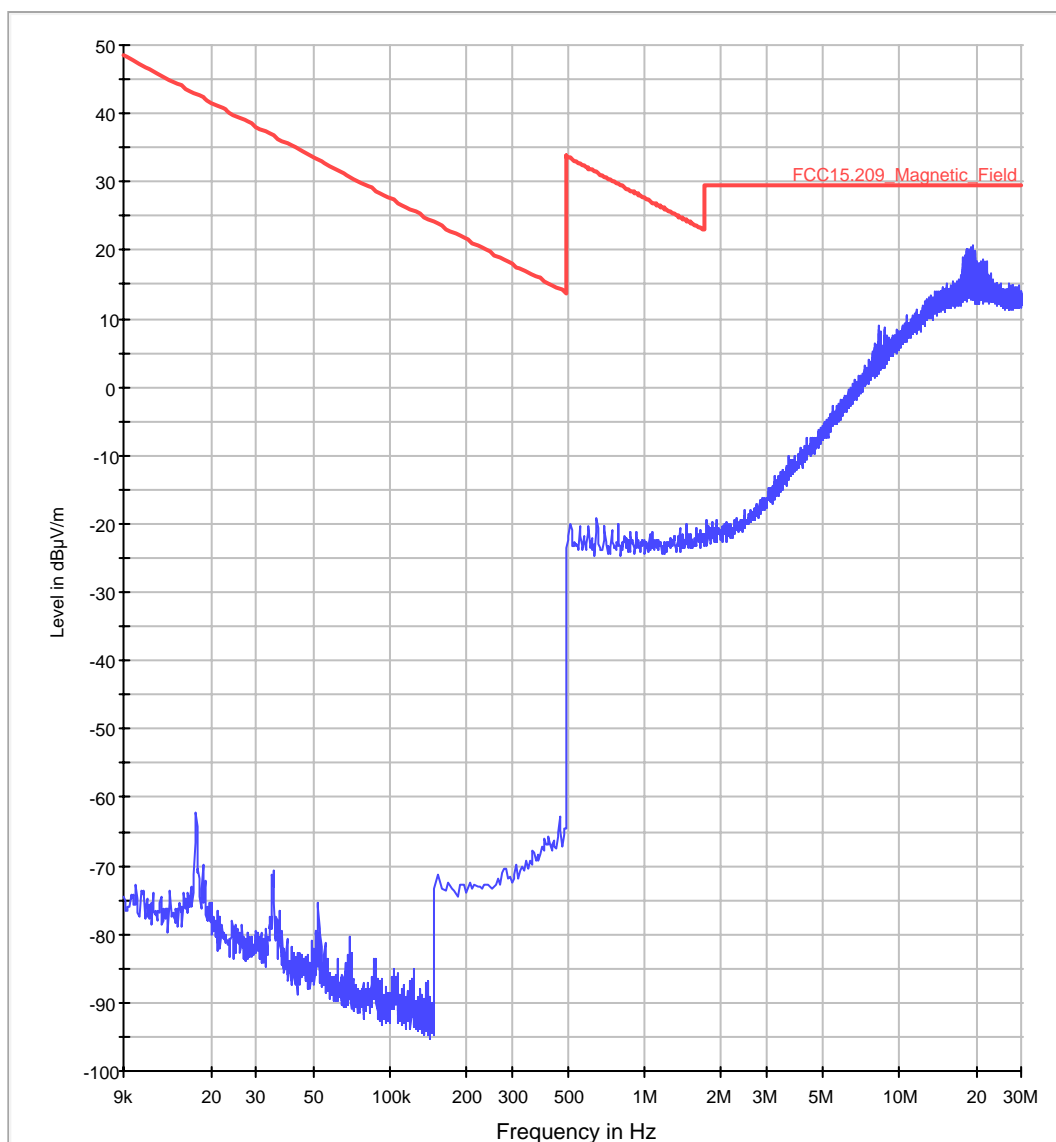

## Diagram No. 02.12

### Common Information

Test description:	Magnetic Fieldstrength Measurement related to 3 m distance
Test site and distance:	Semi Anechoic Room (SAR) with 3 m measurement distance
Measured sides of EUT:	front, right, rear, left, top, under
Rec. antenna :	height 1.00 m
Turntable step:	90° during pre-scan, continuously turning during final measurement
Test specification.:	FCC 15_209 Intentional radiator

EUT:	MC55i + Board + Headset
Manufacturer:	Siemens
Operator:	Lor
Operating conditions:	TCH 1900
Signalling:	Channel 512/661/810
Remark	antenna vector right angle to EUT

### FCC\_MG\_FELD\_PK\_FAST\_H&V\_EUT

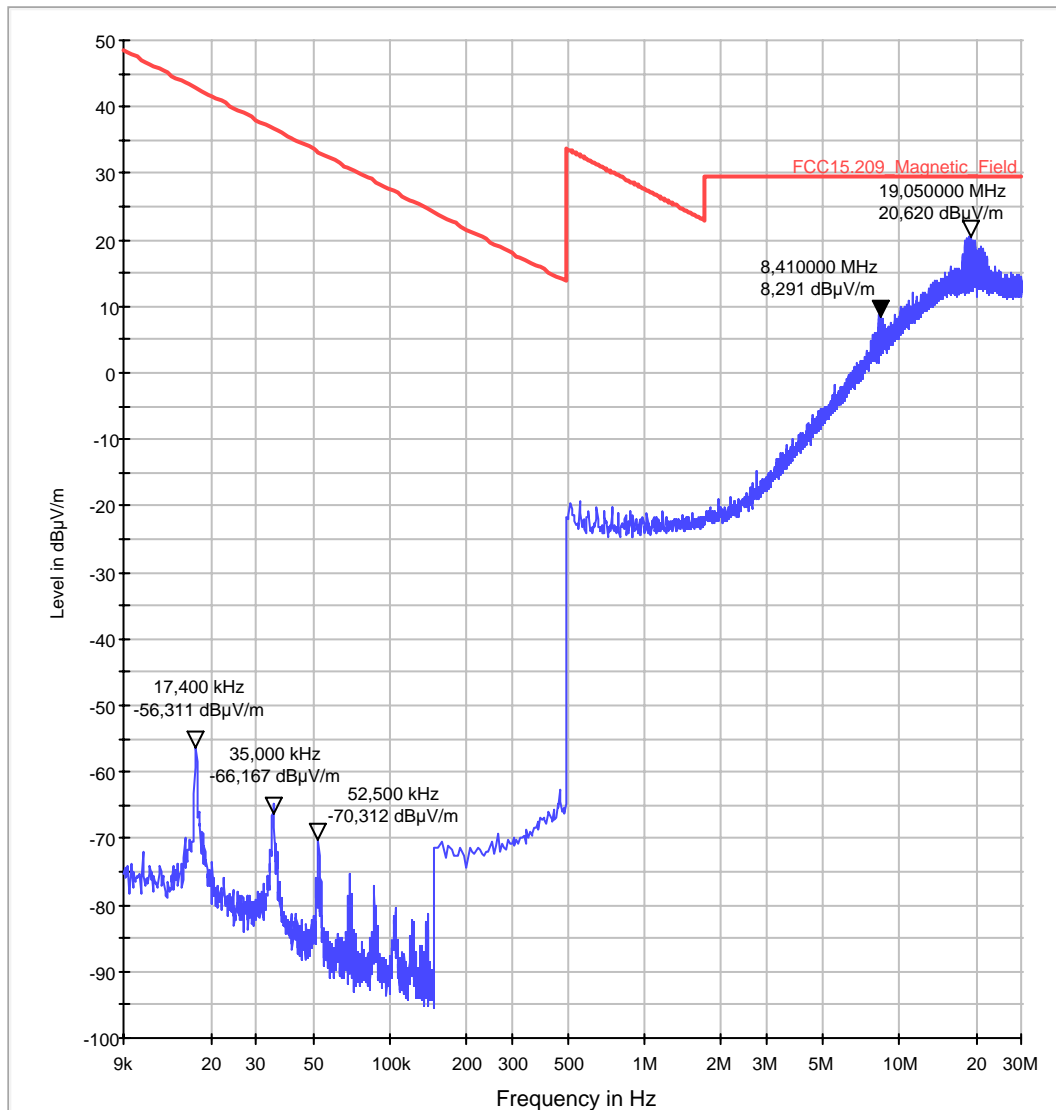



### 9.6. IC : CONDUCTED MEASUREMENTS IN RX-MODE 850MHZ, RSS-132-ISSUE 2, CHAPTER 4.6

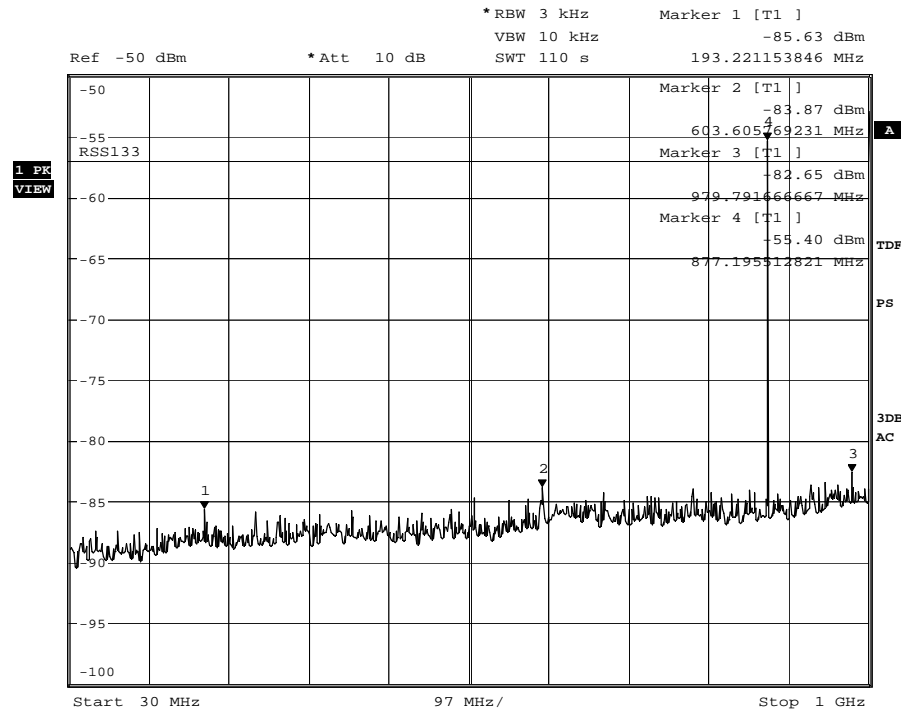

Date: 7.DEC.2007 16:34:48

Diagram 8.302

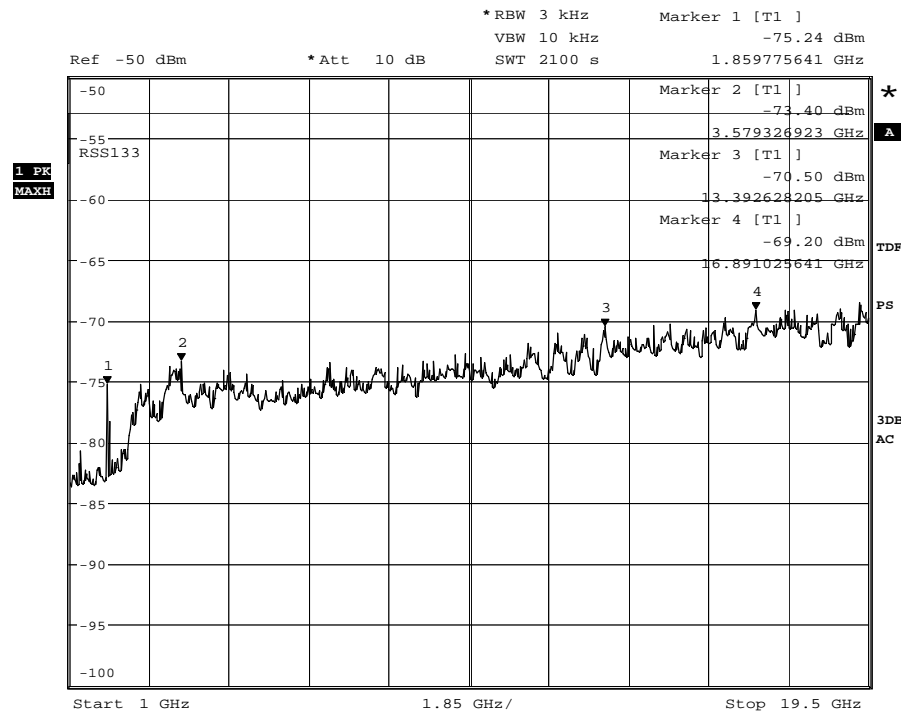

Date: 7.DEC.2007 17:12:19

Diagram 8.302

### 9.7. IC: CONDUCTED MEASUREMENTS IN RX-MODE 1900 MODE: RSS-133- ISSUE 3, CHAPTER 6.7(B)

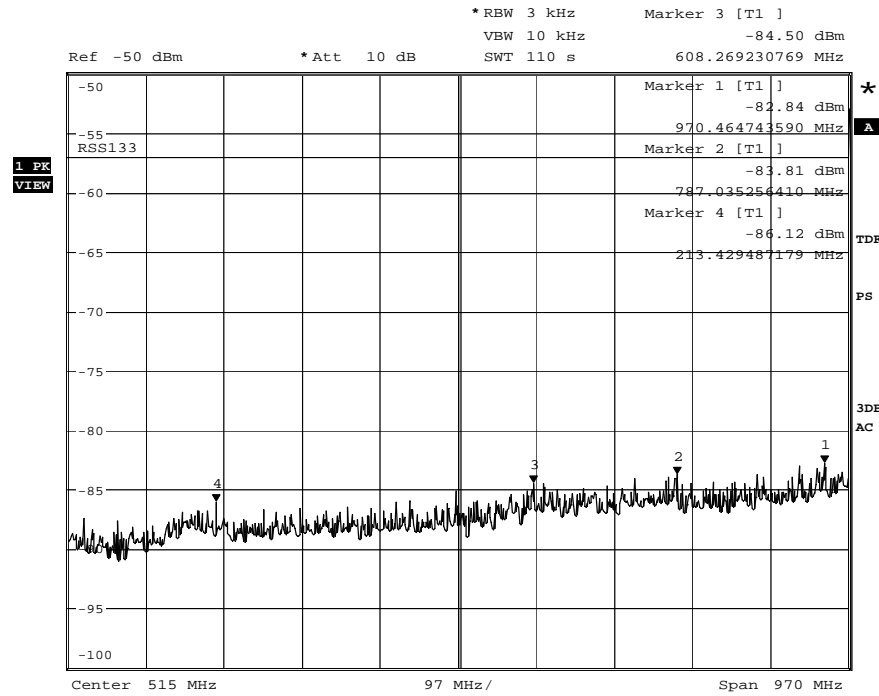

Date: 7.DEC.2007 15:50:06

Diagram 8.300

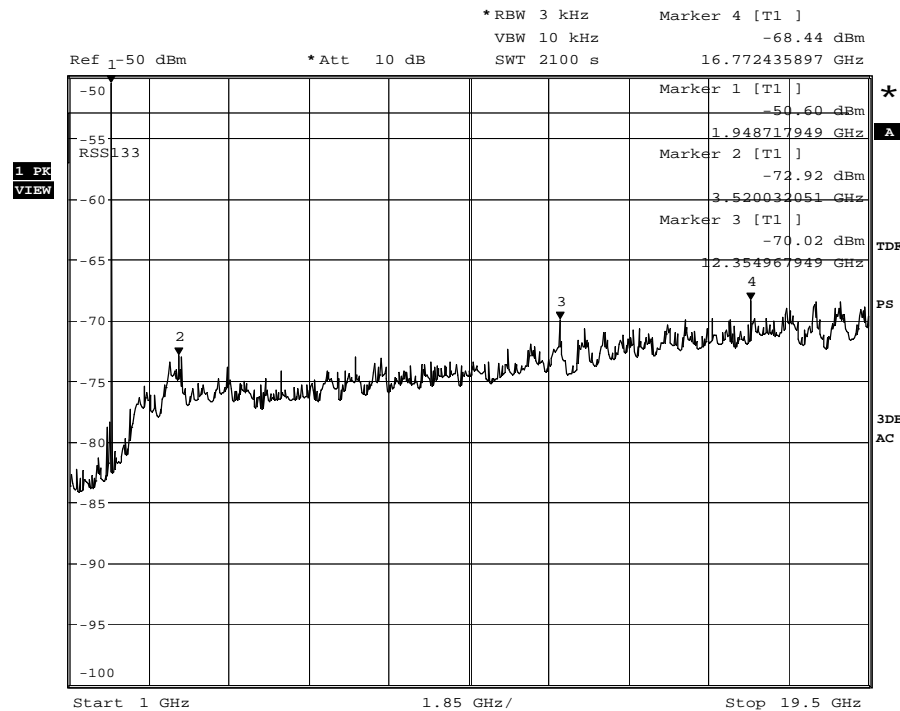

Date: 7.DEC.2007 16:27:54

Diagram 8.301

## **10. ANNEX A - Photos: EUT and accessories**

See separate document

## **11. ANNEX B - Photos: Test Set-up**

See separate document