



RF TEST REPORT

Applicant Bluebird Inc.
FCC ID SS4CF550
Product Cost-Effective Full TouchHandheld Computer
Brand BLUEBIRD
Model CF550
Report No. R2111A0957-R8
Issue Date January 7, 2022

TA Technology (Shanghai) Co., Ltd. tested the above equipment in accordance with the requirements in **FCC CFR47 Part 2 (2020)/ FCC CFR 47 Part 90S (2020)**. The test results show that the equipment tested is capable of demonstrating compliance with the requirements as documented in this report.

Prepared by: Peng Tao

Approved by: Kai Xu

TA Technology (Shanghai) Co., Ltd.

No.145, Jintang Rd, Tangzhen Industry Park, Pudong Shanghai, China

TEL: +86-021-50791141/2/3

FAX: +86-021-50791141/2/3-8000



TABLE OF CONTENT

1. Test Laboratory	4
1.1. Notes of the Test Report	4
1.2. Test facility	4
1.3. Testing Location	4
2. General Description of Equipment under Test.....	5
2.3. Applicant and Manufacturer Information	5
2.4. General Information.....	5
3. Applied Standards	6
4. Test Configuration.....	7
5. Test Case Results.....	8
5.1. RF Power Output and Effective Radiated Power	8
5.2. Occupied Bandwidth	14
5.3. Emission Mask	22
5.4. Peak-to-Average Power Ratio (PAPR)	31
5.5. Frequency Stability.....	33
5.6. Spurious Emissions at Antenna Terminals	37
5.7. Radiates Spurious Emission	40
6. Main Test Instruments	45
ANNEX A: The EUT Appearance	46
ANNEX B: Test Setup Photos	47



Summary of measurement results

No.	Test Case	Clause in FCC rules	Verdict
1	RF Power Output and Effective Radiated Power	2.1046/90.635(b)	PASS
2	Occupied Bandwidth	2.1049/ 90.209	PASS
3	Emission Masks	2.1051 / 90.691	PASS
4	Peak-to-Average Power Ratio	KDB 971168 D01(5.7)	PASS
5	Frequency Stability	2.1055 / 90.213	PASS
6	Spurious Emissions at Antenna Terminals	2.1051 / 90.691	PASS
7	Radiates Spurious Emission	2.1053 /90.691	PASS

Date of Testing: November 17, 2021 ~ December 1, 2021
Date of Sample Received: November 9, 2021

Note: PASS: The EUT complies with the essential requirements in the standard.
FAIL: The EUT does not comply with the essential requirements in the standard.
All indications of Pass/Fail in this report are opinions expressed by TA Technology (Shanghai) Co., Ltd. based on interpretations and/or observations of test results. Measurement Uncertainties were not taken into account and are published for informational purposes only.



1. Test Laboratory

1.1. Notes of the Test Report

This report shall not be reproduced in full or partial, without the written approval of **TA technology (shanghai) co., Ltd.** The results documented in this report apply only to the tested sample, under the conditions and modes of operation as described herein .Measurement Uncertainties were not taken into account and are published for informational purposes only. This report is written to support regulatory compliance of the applicable standards stated above.

1.2. Test facility

FCC (Designation number: CN1179, Test Firm Registration Number: 446626)

TA Technology (Shanghai) Co., Ltd. has been listed on the US Federal Communications Commission list of test facilities recognized to perform electromagnetic emissions measurements.

A2LA (Certificate Number: 3857.01)

TA Technology (Shanghai) Co., Ltd. has been listed by American Association for Laboratory Accreditation to perform electromagnetic emission measurement.

1.3. Testing Location

Company: TA Technology (Shanghai) Co., Ltd.
Address: No.145, Jintang Rd, Tangzhen Industry Park, Pudong
City: Shanghai
Post code: 201201
Country: P. R. China
Contact: Xu Kai
Telephone: +86-021-50791141/2/3
Fax: +86-021-50791141/2/3-8000
Website: <http://www.ta-shanghai.com>
E-mail: xukai@ta-shanghai.com

2. General Description of Equipment under Test

2.3. Applicant and Manufacturer Information

Applicant	Bluebird Inc.
Applicant address	3F, 115, Irwon-ro, Gangnam-gu, Seoul, Republic of Korea
Manufacturer	Bluebird Inc.
Manufacturer address	3F, 115, Irwon-ro, Gangnam-gu, Seoul, Republic of Korea

2.4. General Information

EUT Description			
Model	CF550		
IMEI	IMEI 1: 358671240002572 IMEI 2: 358671240002580		
Hardware Version	V1.0		
Software Version	20211026_R1.00		
Power Supply	AC adapter		
Antenna Type	Coupling type (LDS)		
Antenna Gain	2 dBi		
Test Mode(s)	LTE Band 26;		
Test Modulation	QPSK, 16QAM, 64QAM;		
LTE Category	M1		
Maximum E.R.P.	LTE Band 26:	25.56dBm	
Rated Power Supply Voltage	3.85V		
Operating Voltage	Minimum: 3.4V Maximum: 4.33V		
Operating Temperature	Lowest: -20°C Highest: +50°C		
Testing Temperature	Lowest: -30°C Highest: +50°C		
Operating Frequency Range(s)	Band	Tx (MHz)	Rx (MHz)
	LTE Band 26	814 ~ 824	859 ~ 869
EUT Accessory			
Adapter	Manufacturer: Kuantech (Beihai) Co., Ltd. Model: KSA29B0500200D5		
Battery	Manufacturer: Ningbo Veken Battery Co.,Ltd. Model: BAT-435001B		
USB Cable	Manufacturer: GAC Model: GAC-BBD20-002 100cm Cable, Shielded		
Note: 1. The EUT is sent from the applicant to TA and the information of the EUT is declared by the applicant.			



3. Applied Standards

According to the specifications of the manufacturer, it must comply with the requirements of the following standards:

Test standards:

FCC CFR 47 Part 90S (2020)

ANSI C63.26 (2015)

Reference standard:

FCC CFR47 Part 2 (2020)

KDB 971168 D01 Power Meas License Digital Systems v03r01

4. Test Configuration

Radiated measurements are performed by rotating the EUT in three different orthogonal test planes. EUT stand-up position (Z axis), lie-down position (X, Y axis). Receiver antenna polarization (horizontal and vertical), the worst emission was found in position (Z axis, vertical polarization) and the worst case was recorded.

All mode and data rates and positions were investigated.

The following testing in LTE is set based on the maximum RF Output Power.

Test modes are chosen as the worst case configuration below for LTE Band 26.

Test items	Bandwidth (MHz)					Modulation		RB			Test Channel		
	1.4	3	5	10	15	QPSK	16QAM/ 64QAM	1	50%	100%	L	M	H
RF Power Output and Effective Radiated Power	O	O	O	O	O	O	O	O	O	O	O	O	O
Occupied Bandwidth	O	O	O	O	O	O	O	-	-	O	O	O	O
Emission Mask	O	O	O	O	O	O	O	O	-	O	O	-	O
Peak-to-Average Power Ratio	O	O	O	O	O	O	O	-	-	O	O	O	O
Frequency Stability	O	O	O	O	O	O	O	O	-	-	-	O	-
Spurious Emissions at Antenna Terminals	O	O	O	O	O	O	-	O	-	-	O	O	O
Radiates Spurious Emission	O	O	O	O	O	O	-	O	-	-	-	O	-
Note	1. The mark "O" means that this configuration is chosen for testing. 2. The mark "-" means that this configuration is not testing.												

5. Test Case Results

5.1. RF Power Output and Effective Radiated Power

Ambient condition

Temperature	Relative humidity
21°C ~25°C	40%~60%

Methods of Measurement

During the process of the testing, The EUT was connected to the Base Station Simulator with a known loss. The EUT is controlled by the Base Station Simulator test set to ensure max power transmission with proper modulation.

ERP can then be calculated as follows:

$$\text{EIRP (dBm)} = \text{Output Power (dBm)} - \text{Losses (dB)} + \text{Antenna Gain (dBi)}$$

where:dBd refers to gain relative to an ideal dipole.

$$\text{EIRP (dBm)} = \text{ERP (dBm)} + 2.15 \text{ (dB.)}$$

Test Setup

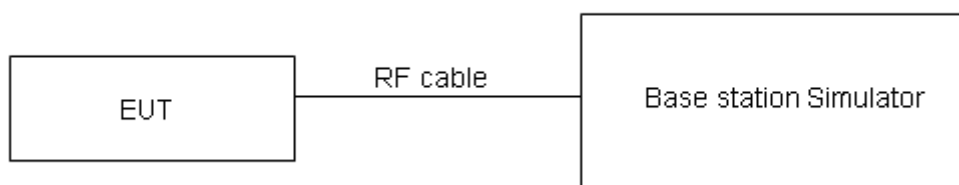

Limits

Part 90.635 (b) the maximum output power of the transmitter for mobile stations is 100 watts.

Rule Part 90.635(b) specifies that “The maximum output power of the transmitter for mobile stations is 100 watts”.

Limit	≤ 100 W (50 dBm)

Measurement Uncertainty

The assessed measurement uncertainty to ensure 95% confidence level for the normal distribution is with the coverage factor k = 2, U= 0.4 dB for RF power output, k = 2, U= 1.19 dB for ERP.



Test Results

Band	Bandwidth (MHz)	UL Channel	RB Size	RB Position	Modulation	Power (dBm)	ERP (dBm)	Verdict
LTE band 26	1.4	26697	1	#0	QPSK	23.28	25.28	PASS
	1.4	26697	1	#Mid	QPSK	23.48	25.48	PASS
	1.4	26697	1	#Max	QPSK	23.26	25.26	PASS
	1.4	26697	3	#0	QPSK	23.34	25.34	PASS
	1.4	26697	3	#Mid	QPSK	23.32	25.32	PASS
	1.4	26697	3	#Max	QPSK	23.31	25.31	PASS
	1.4	26697	6	#0	QPSK	22.26	24.26	PASS
	1.4	26697	1	#0	QAM16	22.30	24.30	PASS
	1.4	26697	1	#Mid	QAM16	22.52	24.52	PASS
	1.4	26697	1	#Max	QAM16	22.33	24.33	PASS
	1.4	26697	3	#0	QAM16	22.44	24.44	PASS
	1.4	26697	3	#Mid	QAM16	22.47	24.47	PASS
	1.4	26697	3	#Max	QAM16	22.53	24.53	PASS
	1.4	26697	6	#0	QAM16	21.34	23.34	PASS
	1.4	26740	1	#0	QPSK	23.24	25.24	PASS
	1.4	26740	1	#Mid	QPSK	23.50	25.50	PASS
	1.4	26740	1	#Max	QPSK	23.28	25.28	PASS
	1.4	26740	3	#0	QPSK	23.35	25.35	PASS
	1.4	26740	3	#Mid	QPSK	23.33	25.33	PASS
	1.4	26740	3	#Max	QPSK	23.30	25.30	PASS
	1.4	26740	6	#0	QPSK	22.26	24.26	PASS
	1.4	26740	1	#0	QAM16	22.42	24.42	PASS
	1.4	26740	1	#Mid	QAM16	22.66	24.66	PASS
	1.4	26740	1	#Max	QAM16	22.45	24.45	PASS
	1.4	26740	3	#0	QAM16	22.34	24.34	PASS
	1.4	26740	3	#Mid	QAM16	22.39	24.39	PASS
	1.4	26740	3	#Max	QAM16	22.39	24.39	PASS
	1.4	26740	6	#0	QAM16	21.28	23.28	PASS
	1.4	26783	1	#0	QPSK	23.24	25.24	PASS
	1.4	26783	1	#Mid	QPSK	23.49	25.49	PASS
	1.4	26783	1	#Max	QPSK	23.26	25.26	PASS
	1.4	26783	3	#0	QPSK	23.34	25.34	PASS
	1.4	26783	3	#Mid	QPSK	23.31	25.31	PASS
1.4	26783	3	#Max	QPSK	23.30	25.30	PASS	
1.4	26783	6	#0	QPSK	22.27	24.27	PASS	
1.4	26783	1	#0	QAM16	22.12	24.12	PASS	
1.4	26783	1	#Mid	QAM16	22.43	24.43	PASS	
1.4	26783	1	#Max	QAM16	22.14	24.14	PASS	
1.4	26783	3	#0	QAM16	22.26	24.26	PASS	



1.4	26783	3	#Mid	QAM16	22.25	24.25	PASS
1.4	26783	3	#Max	QAM16	22.28	24.28	PASS
1.4	26783	6	#0	QAM16	21.26	23.26	PASS
3	26705	1	#0	QPSK	23.38	25.38	PASS
3	26705	1	#Mid	QPSK	23.33	25.33	PASS
3	26705	1	#Max	QPSK	23.33	25.33	PASS
3	26705	8	#0	QPSK	22.29	24.29	PASS
3	26705	8	#Mid	QPSK	22.29	24.29	PASS
3	26705	8	#Max	QPSK	22.32	24.32	PASS
3	26705	15	#0	QPSK	22.31	24.31	PASS
3	26705	1	#0	QAM16	22.25	24.25	PASS
3	26705	1	#Mid	QAM16	22.22	24.22	PASS
3	26705	1	#Max	QAM16	22.19	24.19	PASS
3	26705	8	#0	QAM16	21.35	23.35	PASS
3	26705	8	#Mid	QAM16	21.34	23.34	PASS
3	26705	8	#Max	QAM16	21.37	23.37	PASS
3	26705	15	#0	QAM16	21.34	23.34	PASS
3	26740	1	#0	QPSK	23.33	25.33	PASS
3	26740	1	#Mid	QPSK	23.30	25.30	PASS
3	26740	1	#Max	QPSK	23.28	25.28	PASS
3	26740	8	#0	QPSK	22.32	24.32	PASS
3	26740	8	#Mid	QPSK	22.32	24.32	PASS
3	26740	8	#Max	QPSK	22.30	24.30	PASS
3	26740	15	#0	QPSK	22.31	24.31	PASS
3	26740	1	#0	QAM16	22.65	24.65	PASS
3	26740	1	#Mid	QAM16	22.58	24.58	PASS
3	26740	1	#Max	QAM16	22.57	24.57	PASS
3	26740	8	#0	QAM16	21.36	23.36	PASS
3	26740	8	#Mid	QAM16	21.35	23.35	PASS
3	26740	8	#Max	QAM16	21.35	23.35	PASS
3	26740	15	#0	QAM16	21.30	23.30	PASS
3	26775	1	#0	QPSK	23.34	25.34	PASS
3	26775	1	#Mid	QPSK	23.29	25.29	PASS
3	26775	1	#Max	QPSK	23.31	25.31	PASS
3	26775	8	#0	QPSK	22.25	24.25	PASS
3	26775	8	#Mid	QPSK	22.26	24.26	PASS
3	26775	8	#Max	QPSK	22.28	24.28	PASS
3	26775	15	#0	QPSK	22.28	24.28	PASS
3	26775	1	#0	QAM16	22.49	24.49	PASS
3	26775	1	#Mid	QAM16	22.44	24.44	PASS
3	26775	1	#Max	QAM16	22.47	24.47	PASS
3	26775	8	#0	QAM16	21.32	23.32	PASS
3	26775	8	#Mid	QAM16	21.33	23.33	PASS



3	26775	8	#Max	QAM16	21.31	23.31	PASS
3	26775	15	#0	QAM16	21.21	23.21	PASS
5	26715	1	#0	QPSK	23.21	25.21	PASS
5	26715	1	#Mid	QPSK	23.29	25.29	PASS
5	26715	1	#Max	QPSK	23.20	25.20	PASS
5	26715	12	#0	QPSK	22.28	24.28	PASS
5	26715	12	#Mid	QPSK	22.27	24.27	PASS
5	26715	12	#Max	QPSK	22.28	24.28	PASS
5	26715	25	#0	QPSK	22.32	24.32	PASS
5	26715	1	#0	QAM16	22.53	24.53	PASS
5	26715	1	#Mid	QAM16	22.69	24.69	PASS
5	26715	1	#Max	QAM16	22.54	24.54	PASS
5	26715	12	#0	QAM16	21.27	23.27	PASS
5	26715	12	#Mid	QAM16	21.24	23.24	PASS
5	26715	12	#Max	QAM16	21.25	23.25	PASS
5	26715	25	#0	QAM16	21.36	23.36	PASS
5	26740	1	#0	QPSK	23.23	25.23	PASS
5	26740	1	#Mid	QPSK	23.36	25.36	PASS
5	26740	1	#Max	QPSK	23.24	25.24	PASS
5	26740	12	#0	QPSK	22.32	24.32	PASS
5	26740	12	#Mid	QPSK	22.25	24.25	PASS
5	26740	12	#Max	QPSK	22.36	24.36	PASS
5	26740	25	#0	QPSK	22.33	24.33	PASS
5	26740	1	#0	QAM16	22.45	24.45	PASS
5	26740	1	#Mid	QAM16	22.56	24.56	PASS
5	26740	1	#Max	QAM16	22.39	24.39	PASS
5	26740	12	#0	QAM16	21.23	23.23	PASS
5	26740	12	#Mid	QAM16	21.31	23.31	PASS
5	26740	12	#Max	QAM16	21.33	23.33	PASS
5	26740	25	#0	QAM16	21.39	23.39	PASS
5	26765	1	#0	QPSK	23.18	25.18	PASS
5	26765	1	#Mid	QPSK	23.27	25.27	PASS
5	26765	1	#Max	QPSK	23.18	25.18	PASS
5	26765	12	#0	QPSK	22.28	24.28	PASS
5	26765	12	#Mid	QPSK	22.29	24.29	PASS
5	26765	12	#Max	QPSK	22.30	24.30	PASS
5	26765	25	#0	QPSK	22.30	24.30	PASS
5	26765	1	#0	QAM16	22.44	24.44	PASS
5	26765	1	#Mid	QAM16	22.64	24.64	PASS
5	26765	1	#Max	QAM16	22.44	24.44	PASS
5	26765	12	#0	QAM16	21.36	23.36	PASS
5	26765	12	#Mid	QAM16	21.37	23.37	PASS
5	26765	12	#Max	QAM16	21.30	23.30	PASS



5	26765	25	#0	QAM16	21.40	23.40	PASS
10	26740	1	#0	QPSK	23.37	25.37	PASS
10	26740	1	#Mid	QPSK	23.56	25.56	PASS
10	26740	1	#Max	QPSK	23.30	25.30	PASS
10	26740	25	#0	QPSK	22.34	24.34	PASS
10	26740	25	#Mid	QPSK	22.34	24.34	PASS
10	26740	25	#Max	QPSK	22.46	24.46	PASS
10	26740	50	#0	QPSK	22.35	24.35	PASS
10	26740	1	#0	QAM16	22.51	24.51	PASS
10	26740	1	#Mid	QAM16	22.63	24.63	PASS
10	26740	1	#Max	QAM16	22.44	24.44	PASS
10	26740	25	#0	QAM16	21.41	23.41	PASS
10	26740	25	#Mid	QAM16	21.42	23.42	PASS
10	26740	25	#Max	QAM16	21.50	23.50	PASS
10	26740	50	#0	QAM16	21.37	23.37	PASS
1.4	26697	1	#0	QAM64	21.70	23.70	PASS
1.4	26697	1	#Mid	QAM64	21.72	23.72	PASS
1.4	26697	1	#Max	QAM64	21.64	23.64	PASS
1.4	26697	3	#0	QAM64	21.74	23.74	PASS
1.4	26697	3	#Mid	QAM64	21.70	23.70	PASS
1.4	26697	3	#Max	QAM64	21.31	23.31	PASS
1.4	26697	6	#0	QAM64	20.36	22.36	PASS
1.4	26740	1	#0	QAM64	21.28	23.28	PASS
1.4	26740	1	#Mid	QAM64	21.53	23.53	PASS
1.4	26740	1	#Max	QAM64	21.30	23.30	PASS
1.4	26740	3	#0	QAM64	21.49	23.49	PASS
1.4	26740	3	#Mid	QAM64	21.48	23.48	PASS
1.4	26740	3	#Max	QAM64	21.52	23.52	PASS
1.4	26740	6	#0	QAM64	20.36	22.36	PASS
1.4	26783	1	#0	QAM64	21.40	23.40	PASS
1.4	26783	1	#Mid	QAM64	21.56	23.56	PASS
1.4	26783	1	#Max	QAM64	21.38	23.38	PASS
1.4	26783	3	#0	QAM64	21.27	23.27	PASS
1.4	26783	3	#Mid	QAM64	21.28	23.28	PASS
1.4	26783	3	#Max	QAM64	21.31	23.31	PASS
1.4	26783	6	#0	QAM64	20.23	22.23	PASS
3	26705	1	#0	QAM64	21.61	23.61	PASS
3	26705	1	#Mid	QAM64	21.61	23.61	PASS
3	26705	1	#Max	QAM64	21.57	23.57	PASS
3	26705	8	#0	QAM64	20.35	22.35	PASS
3	26705	8	#Mid	QAM64	20.36	22.36	PASS
3	26705	8	#Max	QAM64	20.35	22.35	PASS
3	26705	15	#0	QAM64	20.25	22.25	PASS



3	26740	1	#0	QAM64	21.53	23.53	PASS
3	26740	1	#Mid	QAM64	21.50	23.50	PASS
3	26740	1	#Max	QAM64	21.47	23.47	PASS
3	26740	8	#0	QAM64	20.34	22.34	PASS
3	26740	8	#Mid	QAM64	20.33	22.33	PASS
3	26740	8	#Max	QAM64	20.33	22.33	PASS
3	26740	15	#0	QAM64	20.25	22.25	PASS
3	26775	1	#0	QAM64	21.19	23.19	PASS
3	26775	1	#Mid	QAM64	21.14	23.14	PASS
3	26775	1	#Max	QAM64	21.17	23.17	PASS
3	26775	8	#0	QAM64	20.29	22.29	PASS
3	26775	8	#Mid	QAM64	20.29	22.29	PASS
3	26775	8	#Max	QAM64	20.29	22.29	PASS
3	26775	15	#0	QAM64	20.31	22.31	PASS
5	26715	1	#0	QAM64	21.47	23.47	PASS
5	26715	1	#Mid	QAM64	21.55	23.55	PASS
5	26715	1	#Max	QAM64	21.44	23.44	PASS
5	26715	12	#0	QAM64	20.24	22.24	PASS
5	26715	12	#Mid	QAM64	20.28	22.28	PASS
5	26715	12	#Max	QAM64	20.29	22.29	PASS
5	26715	25	#0	QAM64	20.36	22.36	PASS
5	26740	1	#0	QAM64	21.49	23.49	PASS
5	26740	1	#Mid	QAM64	21.58	23.58	PASS
5	26740	1	#Max	QAM64	21.46	23.46	PASS
5	26740	12	#0	QAM64	20.36	22.36	PASS
5	26740	12	#Mid	QAM64	20.38	22.38	PASS
5	26740	12	#Max	QAM64	20.38	22.38	PASS
5	26740	25	#0	QAM64	20.43	22.43	PASS
5	26765	1	#0	QAM64	21.52	23.52	PASS
5	26765	1	#Mid	QAM64	21.57	23.57	PASS
5	26765	1	#Max	QAM64	21.48	23.48	PASS
5	26765	12	#0	QAM64	20.26	22.26	PASS
5	26765	12	#Mid	QAM64	20.26	22.26	PASS
5	26765	12	#Max	QAM64	20.25	22.25	PASS
5	26765	25	#0	QAM64	20.38	22.38	PASS
10	26740	1	#0	QAM64	21.61	23.61	PASS
10	26740	1	#Mid	QAM64	21.79	23.79	PASS
10	26740	1	#Max	QAM64	21.55	23.55	PASS
10	26740	25	#0	QAM64	20.44	22.44	PASS
10	26740	25	#Mid	QAM64	20.43	22.43	PASS
10	26740	25	#Max	QAM64	20.51	22.51	PASS
10	26740	50	#0	QAM64	20.39	22.39	PASS

5.2. Occupied Bandwidth

Ambient condition

Temperature	Relative humidity
21°C ~25°C	40%~60%

Method of Measurement

The EUT was connected to Spectrum Analyzer and Base Station Simulator via power Splitter. The occupied bandwidth is measured using spectrum analyzer.

RBW is set to 30 kHz, VBW is set to 91 kHz for LTE Band 26 (1.4MHz),

RBW is set to 62 kHz, VBW is set to 180 kHz for LTE Band 26 (3MHz).

RBW is set to 100 kHz, VBW is set to 300 kHz for LTE Band 26 (5MHz).

RBW is set to 200 kHz, VBW is set to 620kHz for LTE Band 26 (10MHz). .

99% power and -26dBc occupied bandwidths are recorded. Spectrum analyzer plots are included on the following pages.

Test Setup

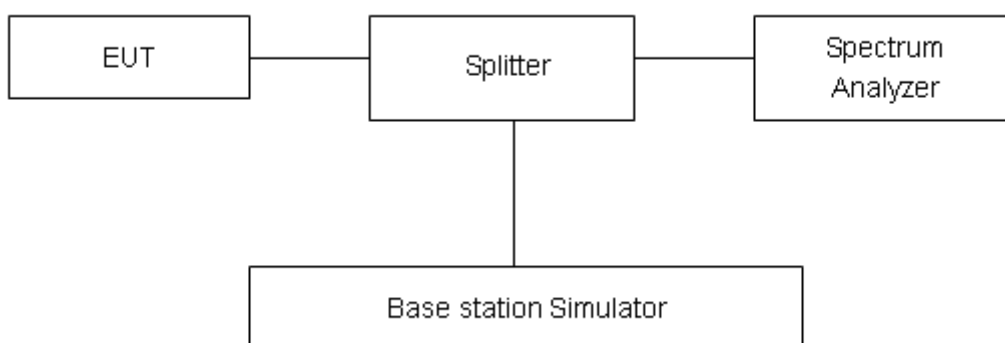

Limits

No specific occupied bandwidth requirements in part 2.1049.

Part 90.209 (a) Each authorization issued to a station licensed under this part will show an emission designator representing the class of emission authorized. The designator will be prefixed by a specified necessary bandwidth. This number does not necessarily indicate the bandwidth occupied by the emission at any instant. In those cases where part 2.202 of this chapter does not provide a formula for the computation of necessary bandwidth, the occupied bandwidth, as defined in part 2 of this chapter, may be used in lieu of the necessary bandwidth.

Measurement Uncertainty

The assessed measurement uncertainty to ensure 95% confidence level for the normal distribution is with the coverage factor $k = 2$, $U = 624\text{Hz}$.



Test Result

LTE Band 26							
RB	Modulation	Bandwidth (MHz)	Channel	Frequency (MHz)	99% Power Bandwidth(MHz)	-26dBc Bandwidth(MHz)	
100%	QPSK	1.4	26697	814.7	1.096	1.275	
			26740	819	1.089	1.273	
			26783	823.3	1.093	1.302	
		3	26705	815.5	2.688	2.923	
			26740	819	2.695	2.904	
			26775	822.5	2.690	2.918	
		5	26715	816.5	4.503	4.918	
			26740	819	4.514	4.900	
			26765	821.5	4.501	4.856	
		10	26740	819	8.975	9.747	
		16QAM	1.4	26697	814.7	1.098	1.279
				26740	819	1.098	1.275
	26783			823.3	1.094	1.268	
	3		26705	815.5	2.681	2.907	
			26740	819	2.690	2.913	
			26775	822.5	2.690	2.932	
	5		26715	816.5	4.495	4.883	
			26740	819	4.522	4.933	
			26765	821.5	4.512	4.902	
	10		26740	819	8.985	9.722	
	64QAM		1.4	26697	814.7	1.094	1.267
				26740	819	1.099	1.284
		26783		823.3	1.095	1.279	
		3	26705	815.5	2.684	2.934	
			26740	819	2.688	2.907	
			26775	822.5	2.697	3.003	
		5	26715	816.5	4.505	4.920	
			26740	819	4.518	4.920	
			26765	821.5	4.500	4.891	
		10	26740	819	8.994	9.676	

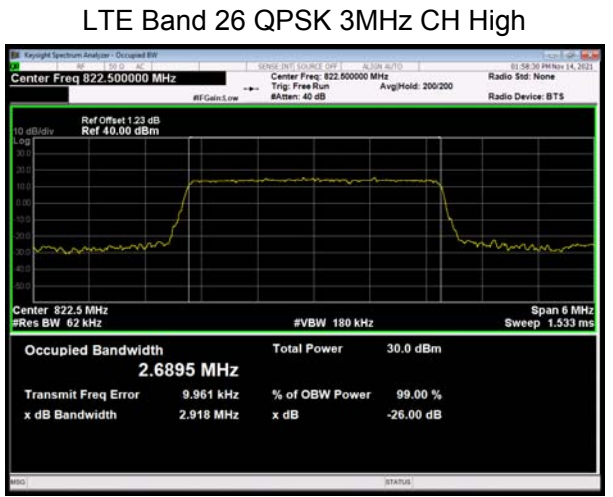
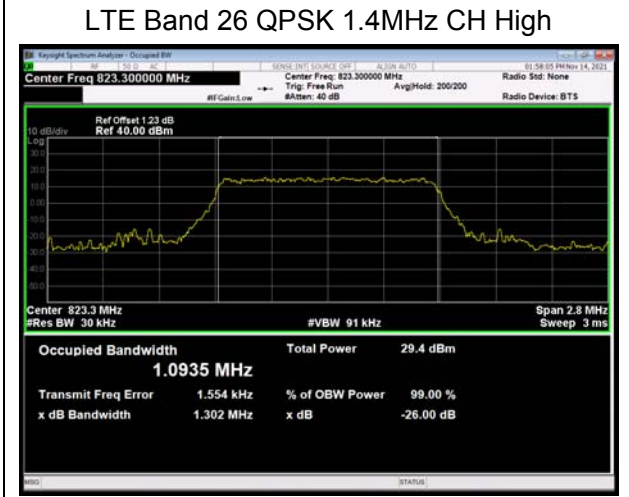
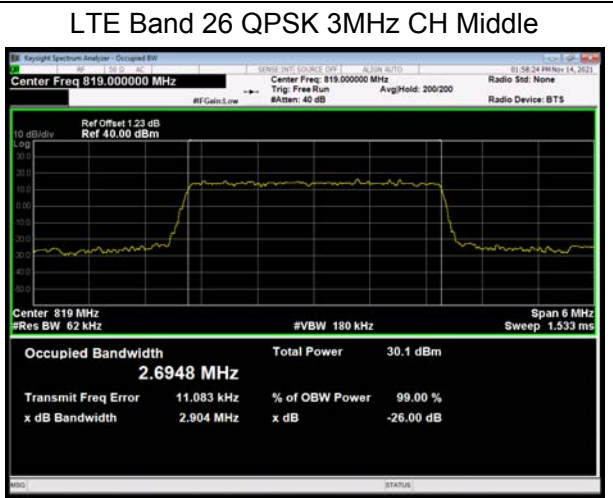
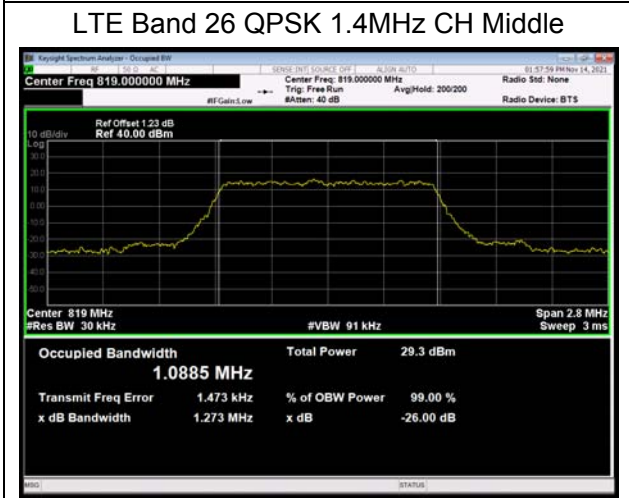
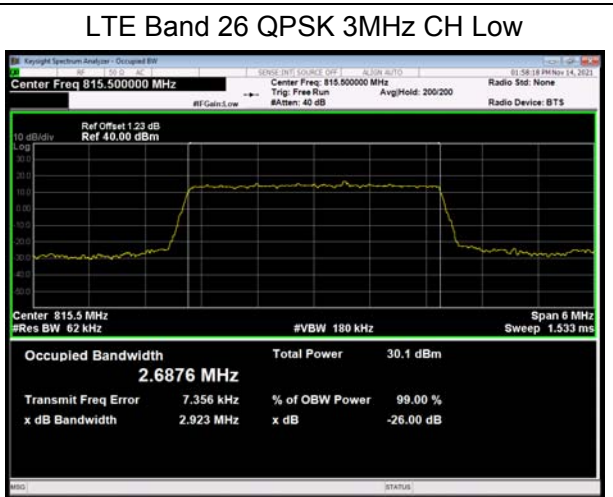
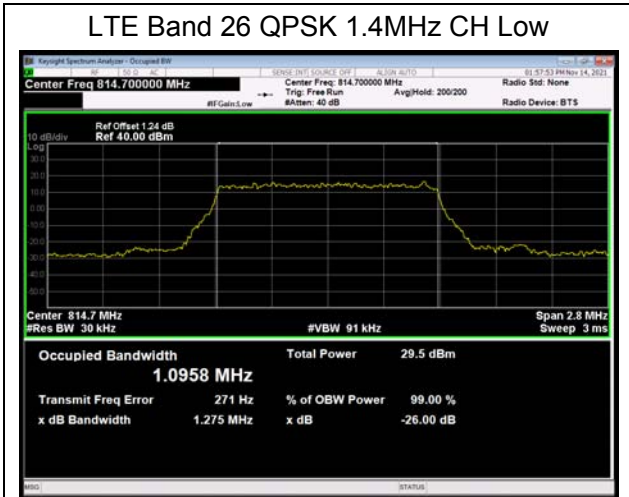

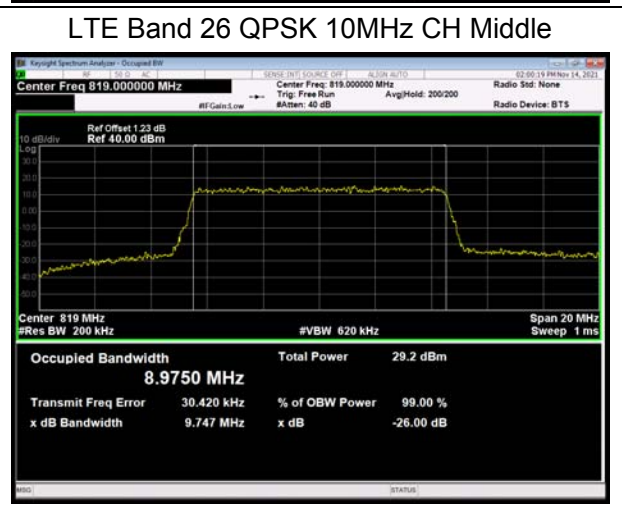
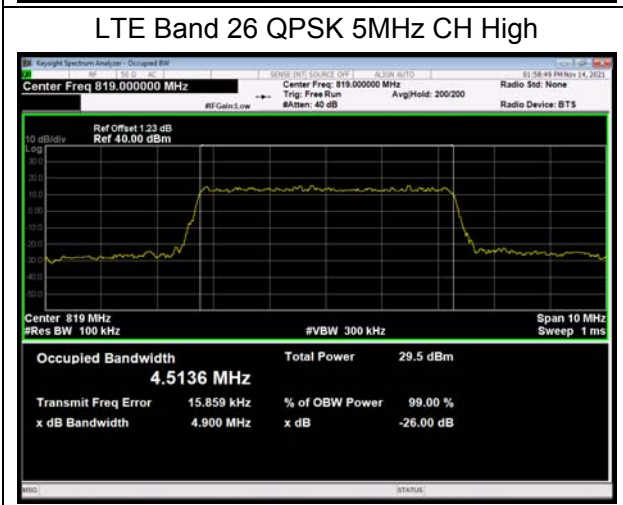
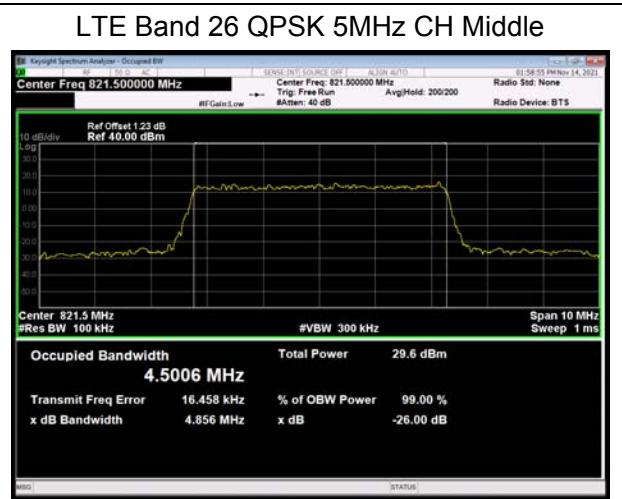
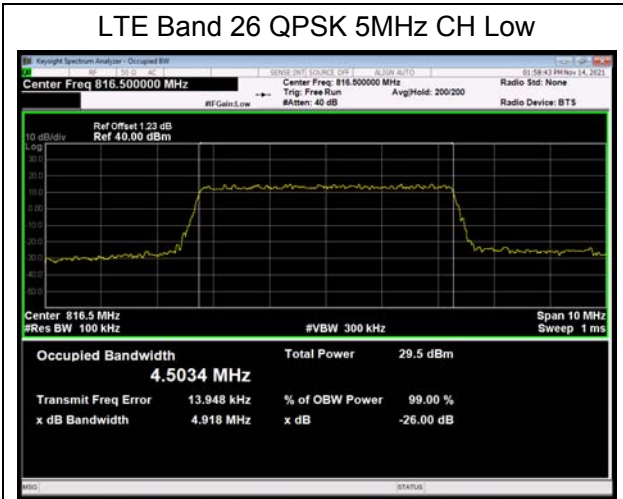

LTE Band 26 16QAM 1.4MHz CH Low



LTE Band 26 16QAM 3MHz CH Low



LTE Band 26 16QAM 1.4MHz CH Middle



LTE Band 26 16QAM 3MHz CH Middle

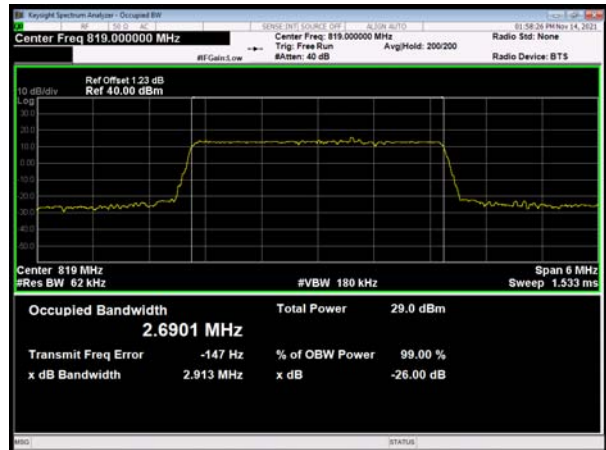

LTE Band 26 16QAM 1.4MHz CH High



LTE Band 26 16QAM 3MHz CH High





LTE Band 26 16QAM 5MHz CH Low



LTE Band 26 16QAM 5MHz CH Middle

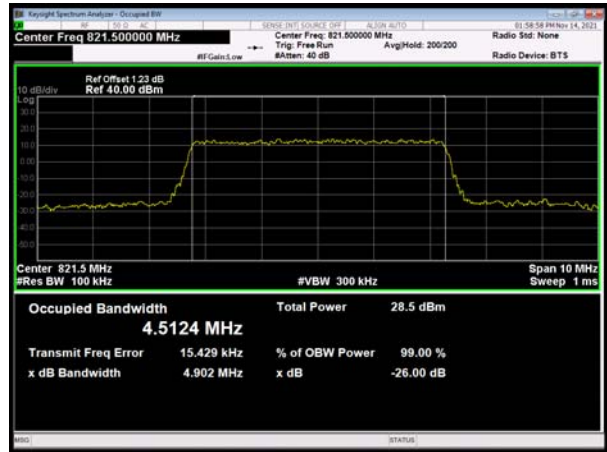

LTE Band 26 16QAM 5MHz CH High

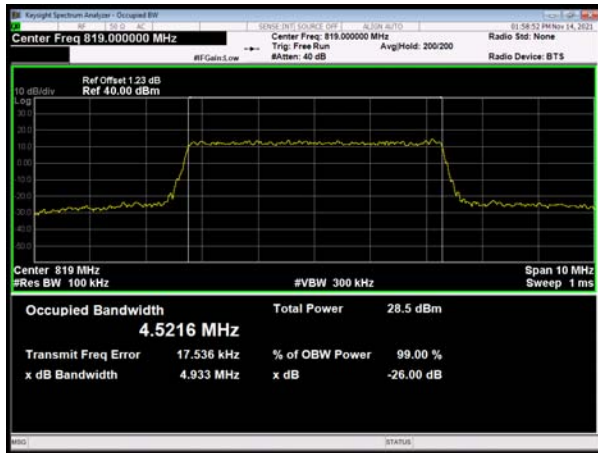

LTE Band 26 16QAM 10MHz CH Middle



LTE Band 26 64QAM 1.4MHz CH Low



LTE Band 26 64QAM 3MHz CH Low

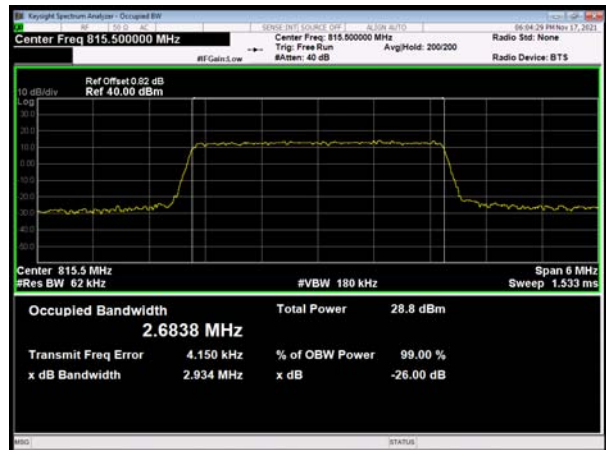

LTE Band 26 64QAM 1.4MHz CH Middle

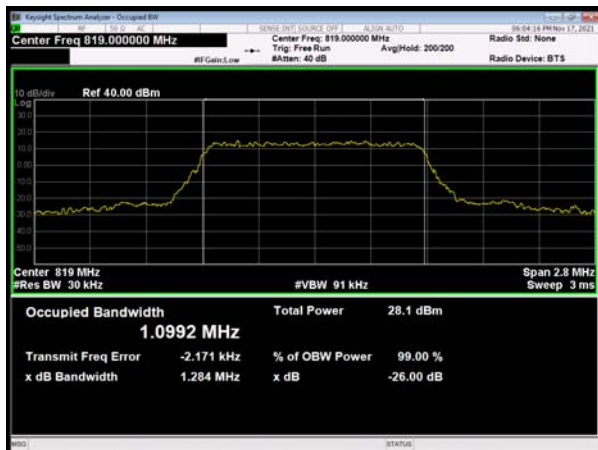

LTE Band 26 64QAM 3MHz CH Middle

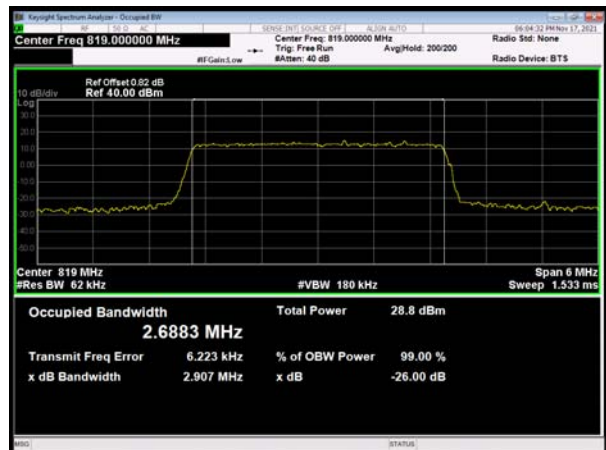

LTE Band 26 64QAM 1.4MHz CH High

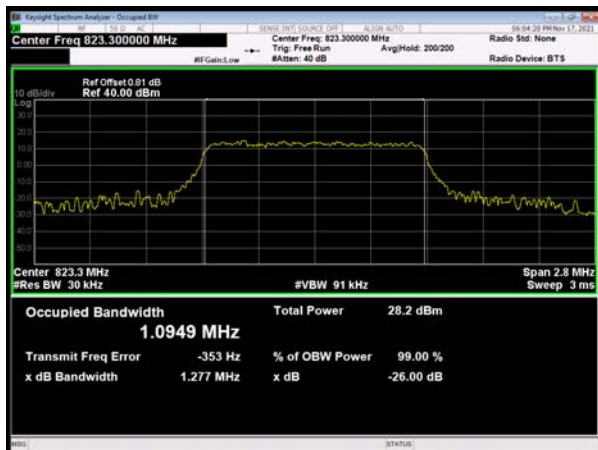

LTE Band 26 64QAM 3MHz CH High

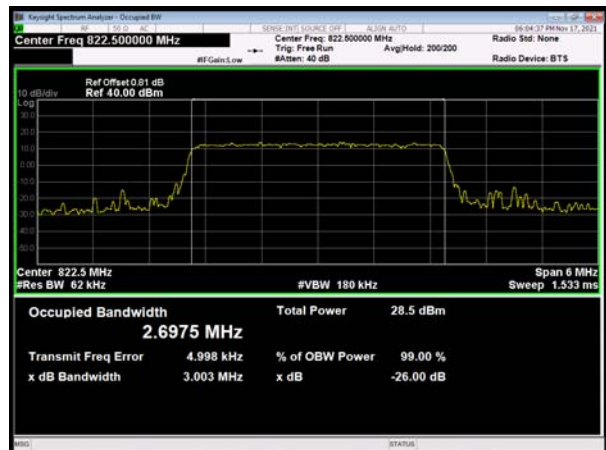



LTE Band 26 64QAM 5MHz CH Low



LTE Band 26 64QAM 5MHz CH Middle



LTE Band 26 64QAM 5MHz CH High



LTE Band 26 64QAM 10MHz CH Middle



5.3. Emission Mask

Ambient condition

Temperature	Relative humidity
21°C ~25°C	40%~60%

Method of Measurement

The EUT was connected to Spectrum Analyzer and Base Station Simulator via power Splitter. The band edge of the lowest and highest channels were measured. The average detector is used. For Section 90.691(a) compliance testing, use RBW = 300 Hz for offsets less than 37.5 kHz from a channel edge; RBW = 100 kHz for offsets greater than 37.5 kHz is allowed.

Spectrum analyzer plots are included on the following pages.

Test Setup

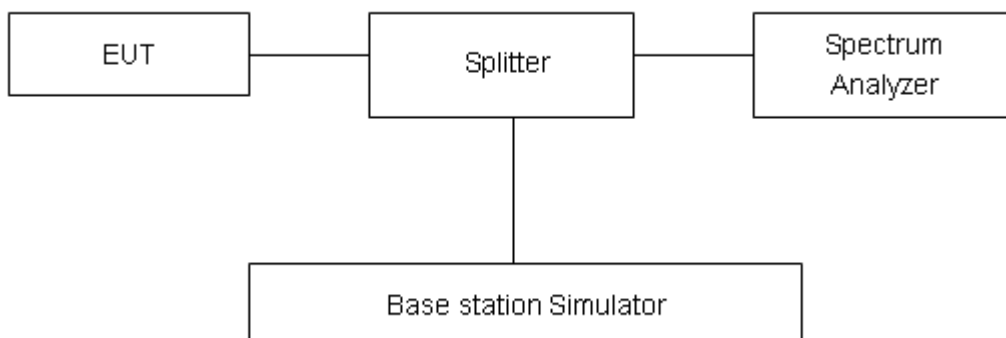

Limits

Rule Part 90.691(a) specifies that “ For any frequency removed from the EA licensee's frequency block by up to and including 37.5 kHz, the power of any emission shall be attenuated below the transmitter power (P) in watts by at least $116 \text{ Log}_{10}(f/6.1)$ decibels or $50 + 10 \text{ Log}_{10}(P)$ decibels or 80 decibels, whichever is the lesser attenuation, where f is the frequency removed from the center of the outer channel in the block in kilohertz and where f is greater than 12.5 kHz.”

Measurement Uncertainty

The assessed measurement uncertainty to ensure 95% confidence level for the normal distribution is with the coverage factor $k = 1.96$, $U=0.684\text{dB}$.

Test Result:

LTE Band 26 QPSK 1.4MHz CH-Low 1RB

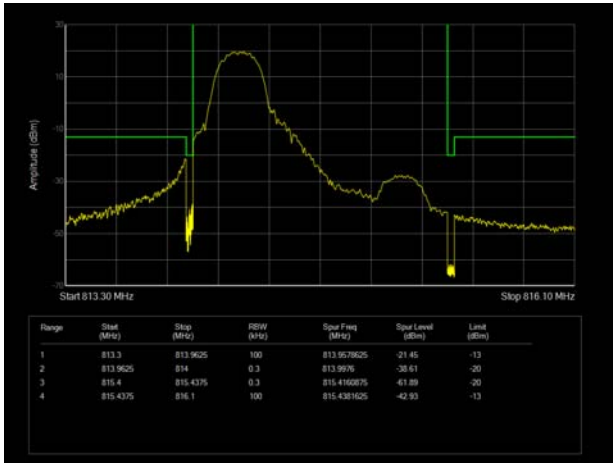

LTE Band 26 QPSK 1.4MHz CH-High 1RB

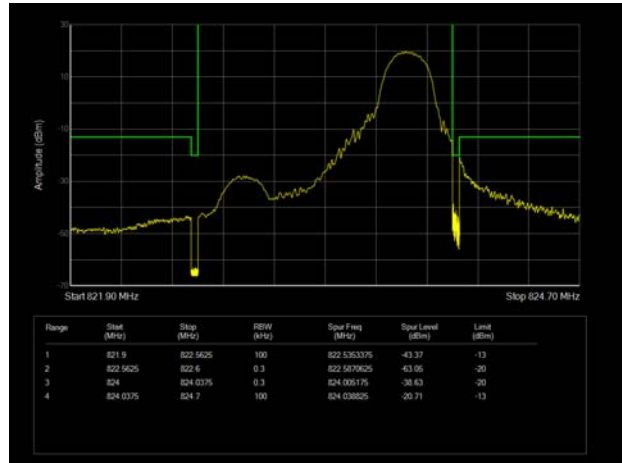

LTE Band 26 QPSK 1.4MHz CH-Low 100%RB

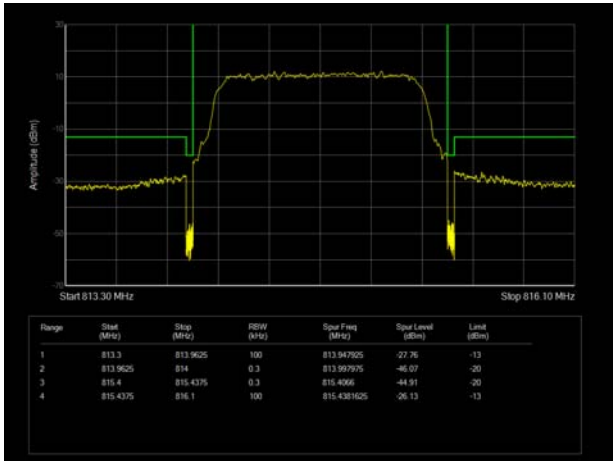

LTE Band 26 QPSK 1.4MHz CH-High 100%RB

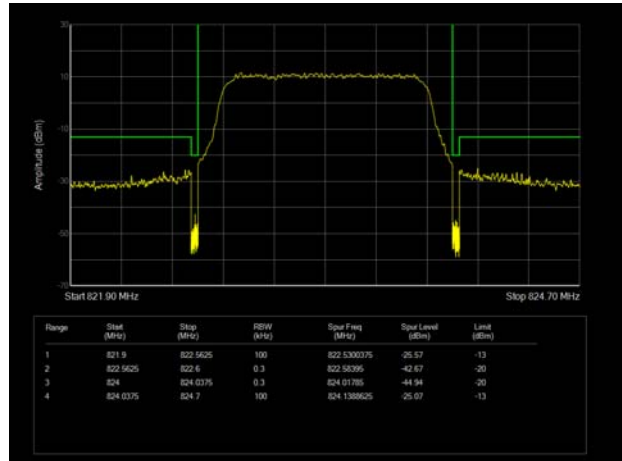

LTE Band 26 QPSK 3MHz CH-Low 1RB

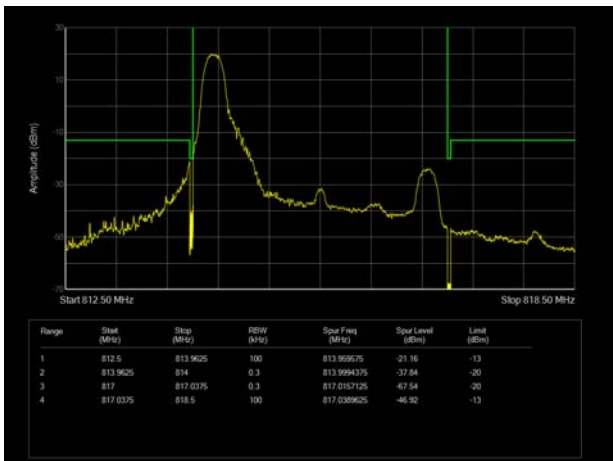

LTE Band 26 QPSK 3MHz CH-High 1RB

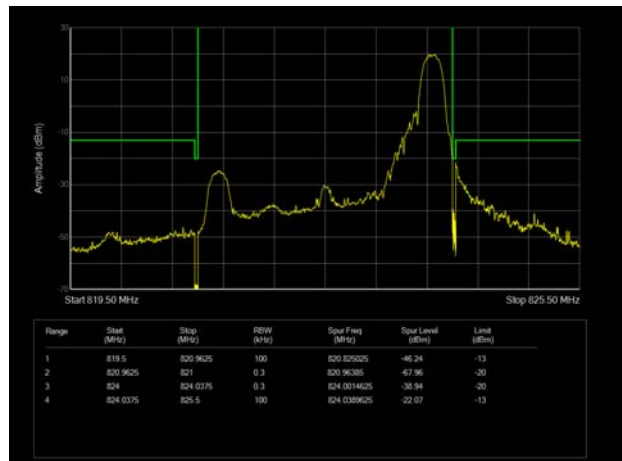

LTE Band 26 QPSK 3MHz CH-Low 100%RB

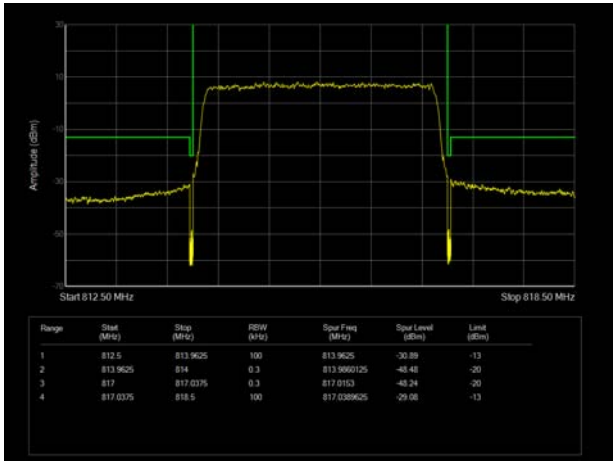

LTE Band 26 QPSK 3MHz CH-High 100%RB

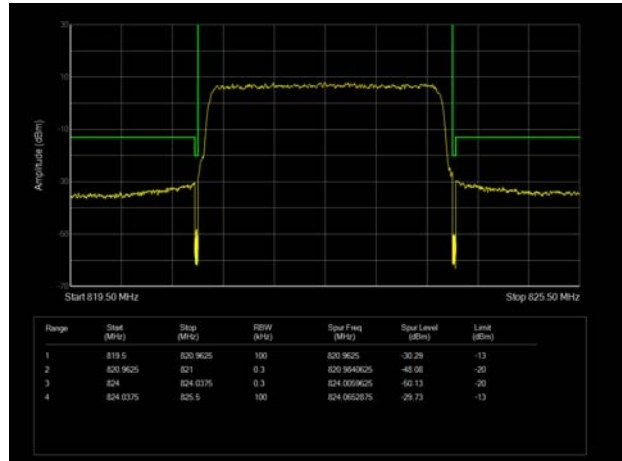

LTE Band 26 QPSK 5MHz CH-Low 1RB

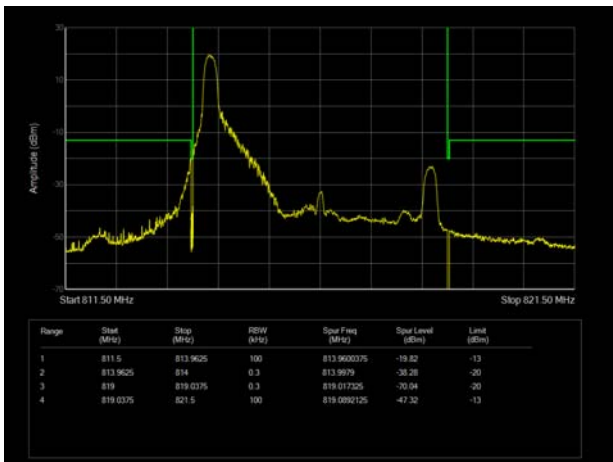

LTE Band 26 QPSK 5MHz CH-High 1RB

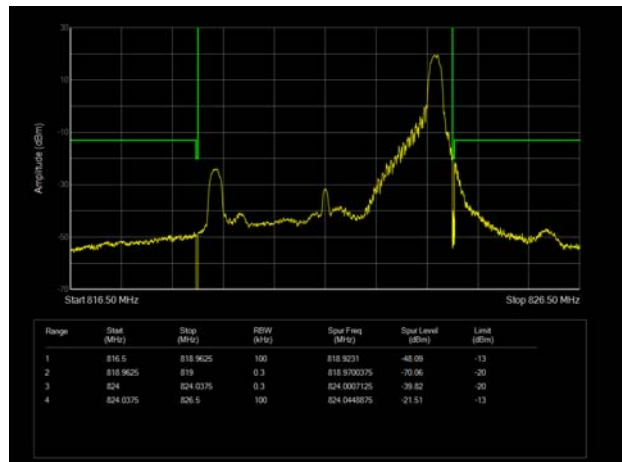

LTE Band 26 QPSK 5MHz CH-Low 100%RB

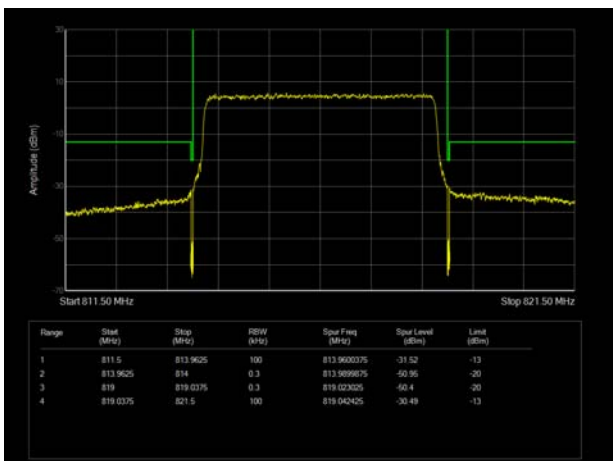

LTE Band 26 QPSK 5MHz CH-High 100%RB

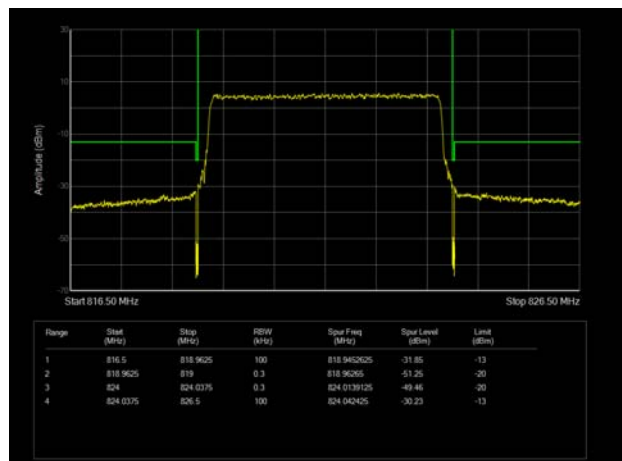

LTE Band 26 QPSK 10MHz CH-Low 1RB

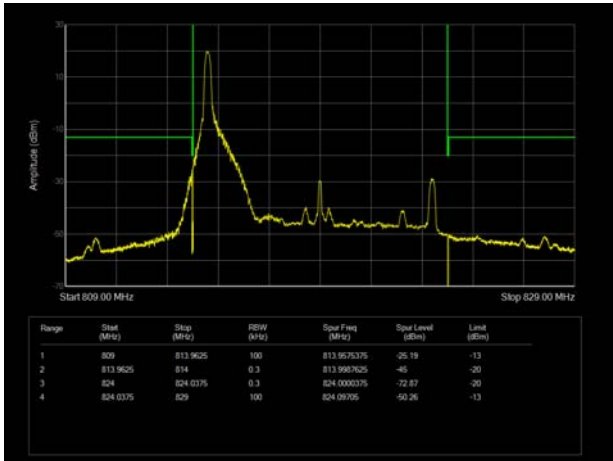

LTE Band 26 QPSK 10MHz CH-High 1RB

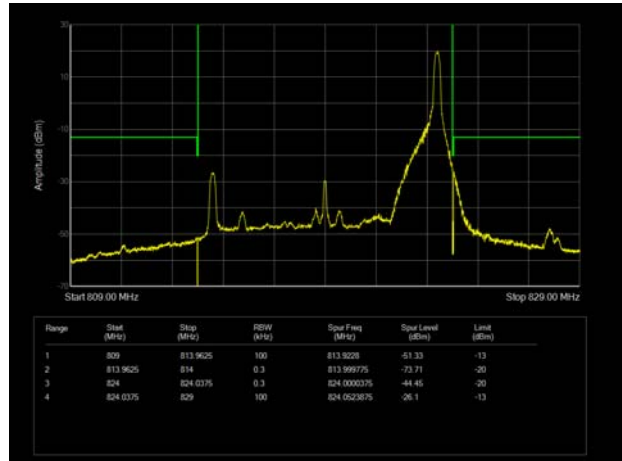

LTE Band 26 QPSK 10MHz CH-Low 100%RB

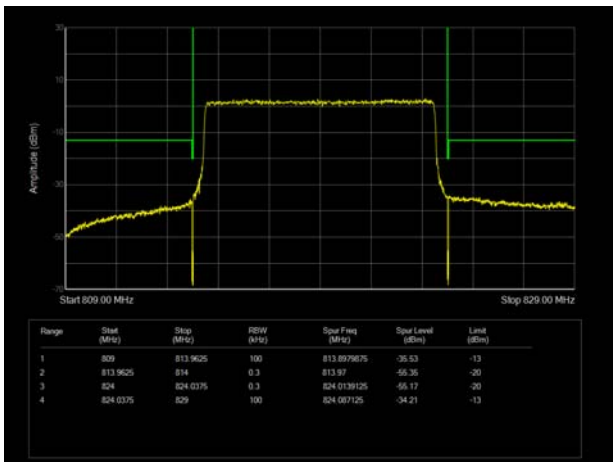

LTE Band 26 QPSK 10MHz CH-High 100%RB

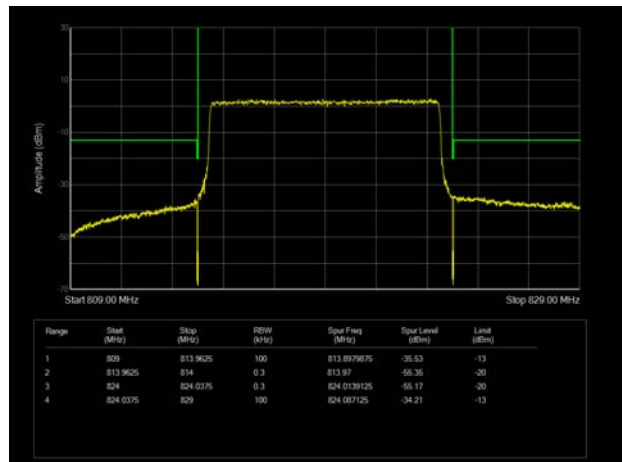

LTE Band 26 16QAM 1.4MHz CH-Low 1RB

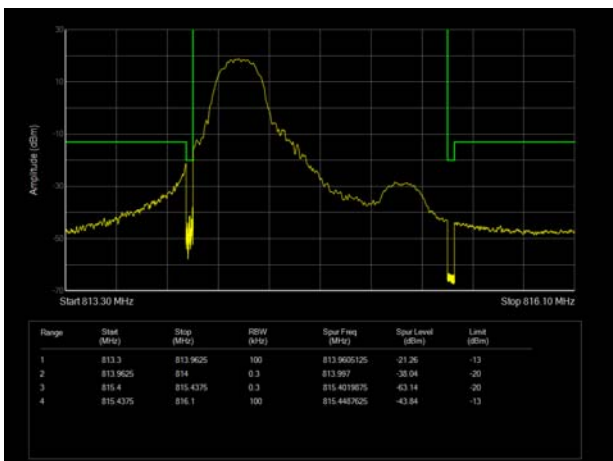

LTE Band 26 16QAM 1.4MHz CH-High 1RB

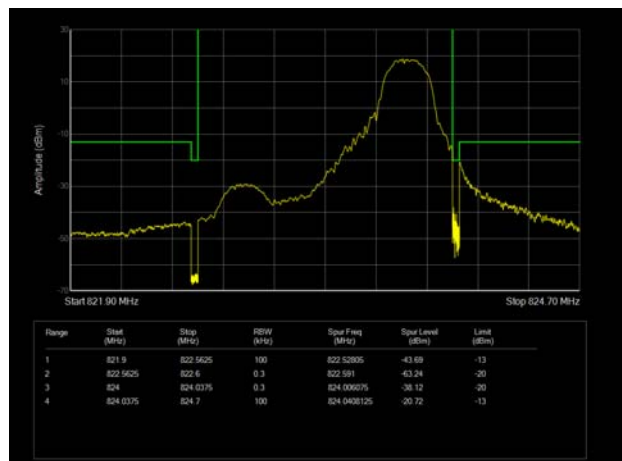

LTE Band 26 16QAM 1.4MHz CH-Low 100%RB

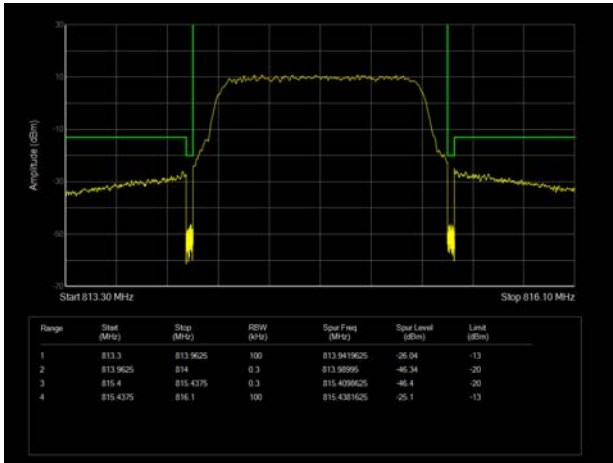

LTE Band 26 16QAM 1.4MHz CH-High 100%RB

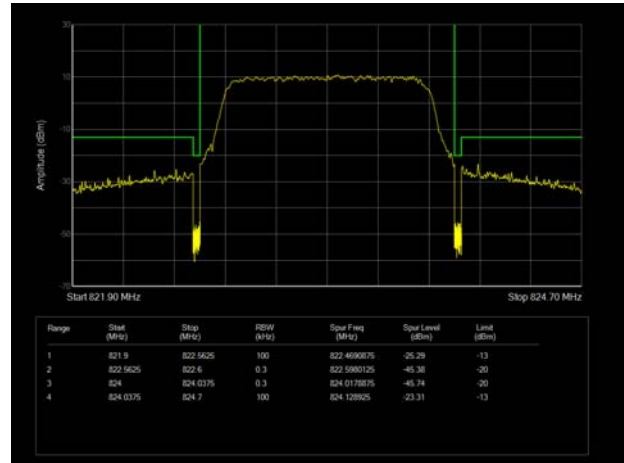

LTE Band 26 16QAM 3MHz CH-Low 1RB

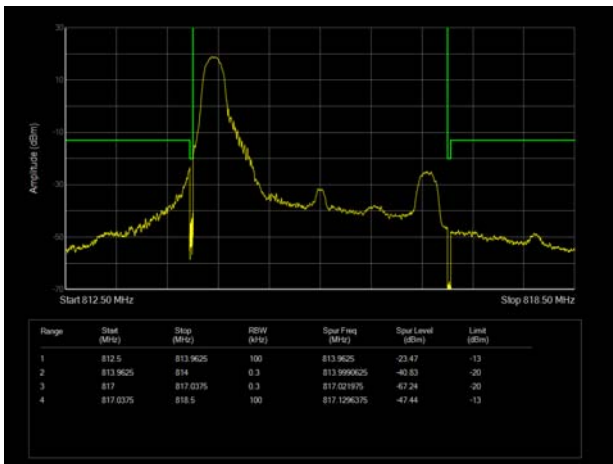

LTE Band 26 16QAM 3MHz CH-High 1RB

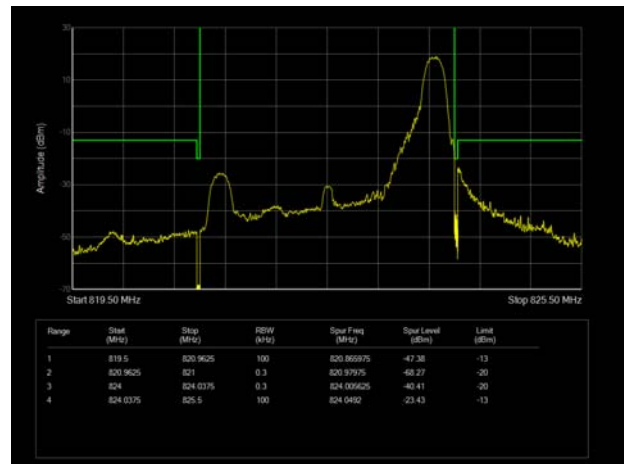

LTE Band 26 16QAM 3MHz CH-Low 100%RB

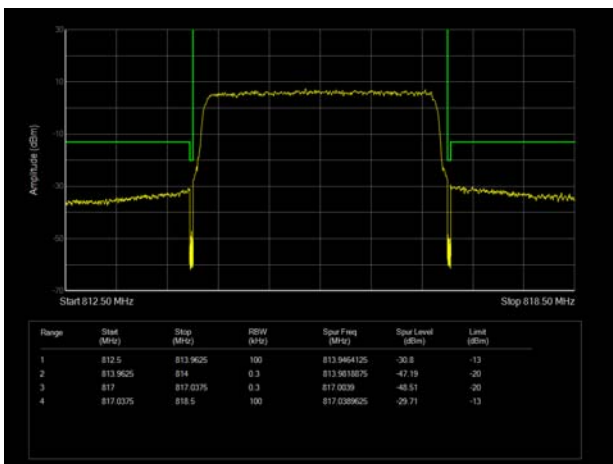

LTE Band 26 16QAM 3MHz CH-High 100%RB

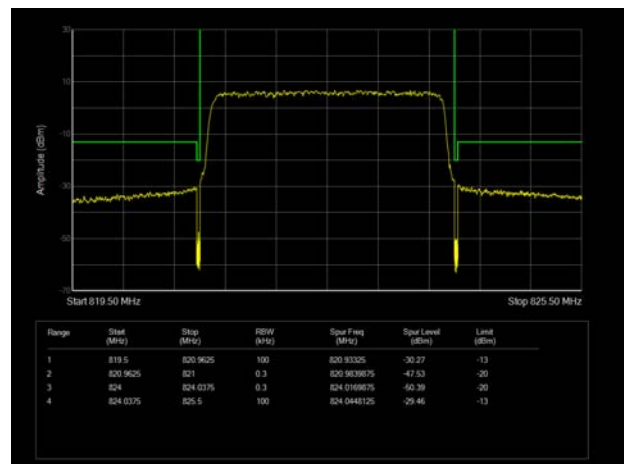

LTE Band 26 16QAM 5MHz CH-Low 1RB

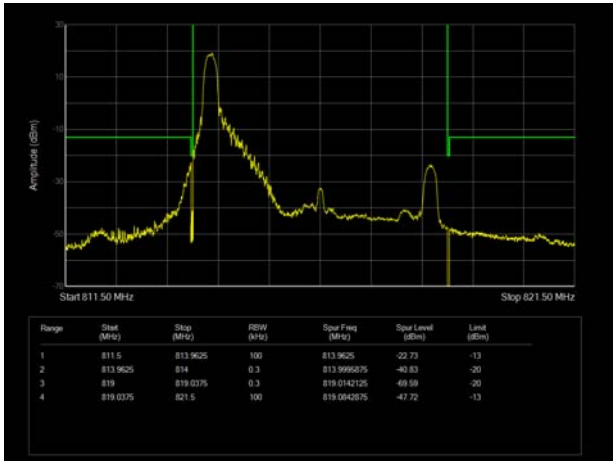

LTE Band 26 16QAM 5MHz CH-High 1RB

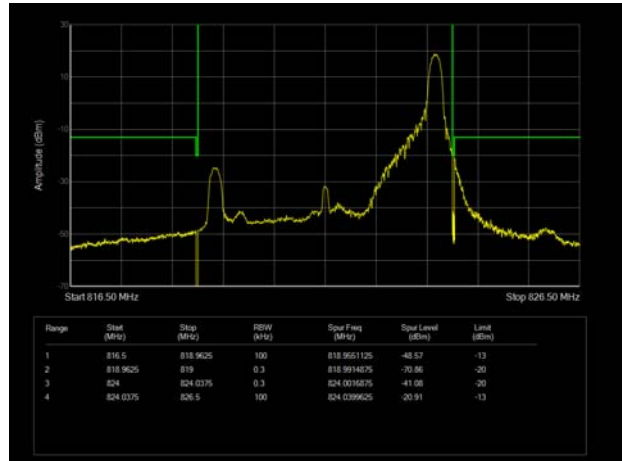

LTE Band 26 16QAM 5MHz CH-Low 100%RB

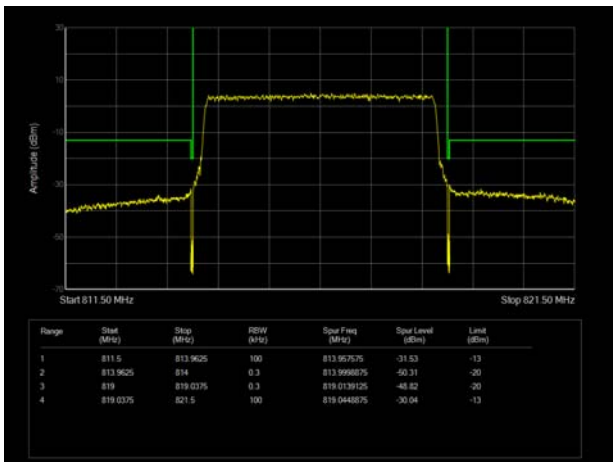

LTE Band 26 16QAM 5MHz CH-High 100%RB

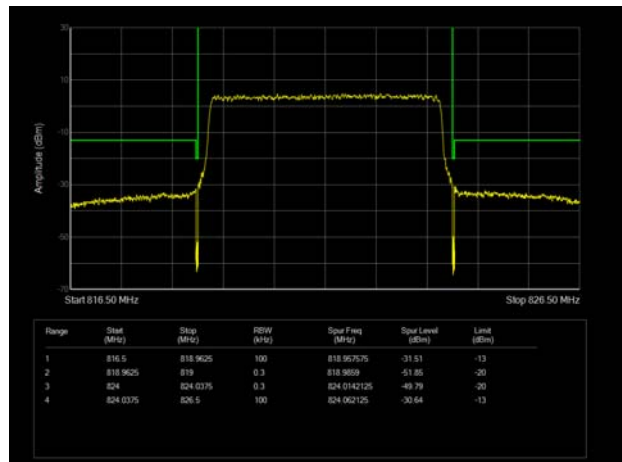

LTE Band 26 16QAM 10MHz CH-Low 1RB

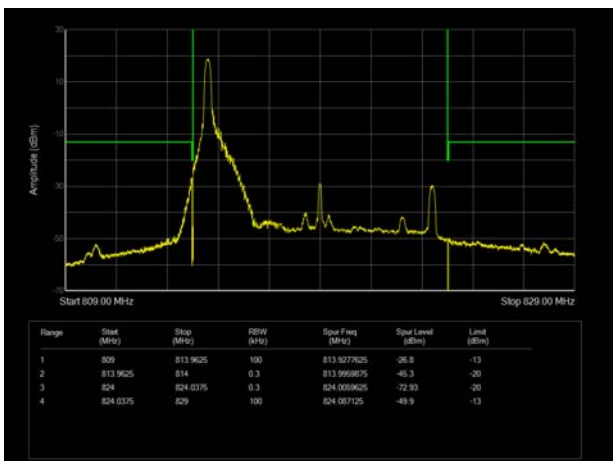

LTE Band 26 16QAM 10MHz CH-High 1RB

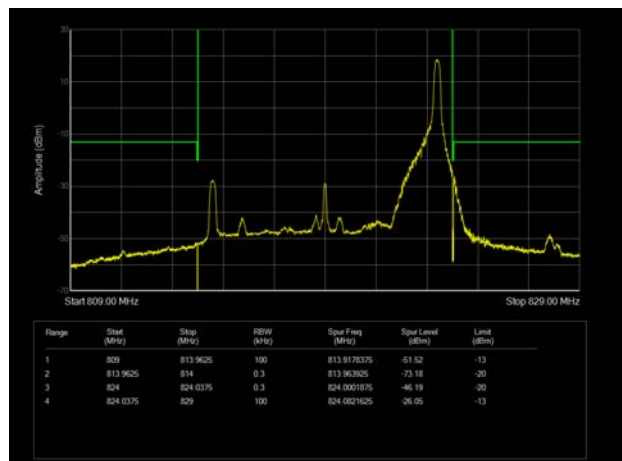



LTE Band 26 16QAM 10MHz CH-Low 100%RB

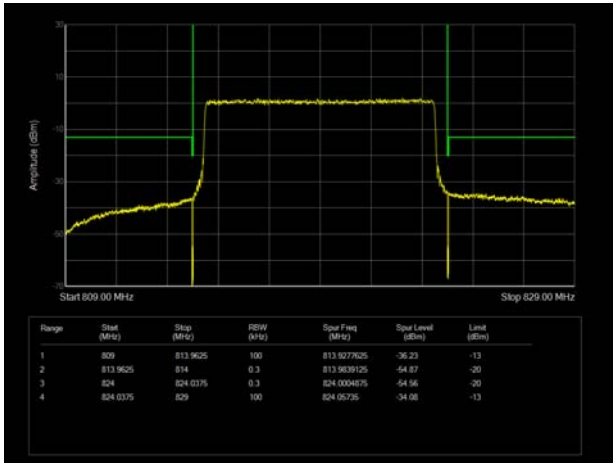

LTE Band 26 16QAM 10MHz CH-High 100%RB

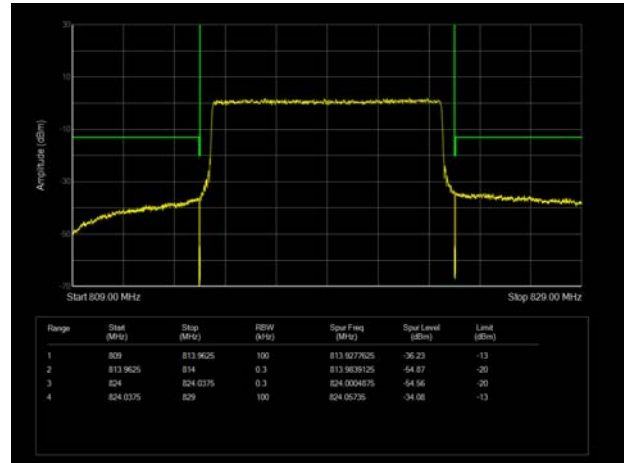

LTE Band 26 64QAM 1.4MHz CH-Low 1RB

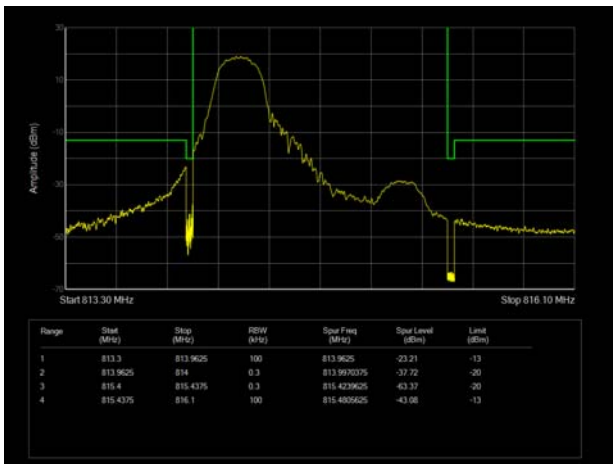

LTE Band 26 64QAM 1.4MHz CH-High 1RB

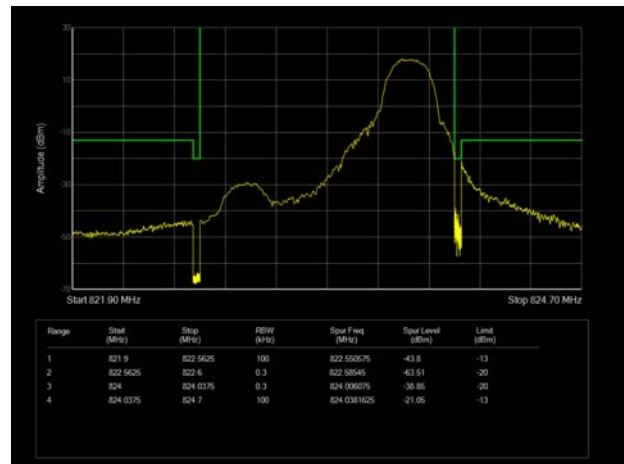

LTE Band 26 64QAM 1.4MHz CH-Low 100%RB

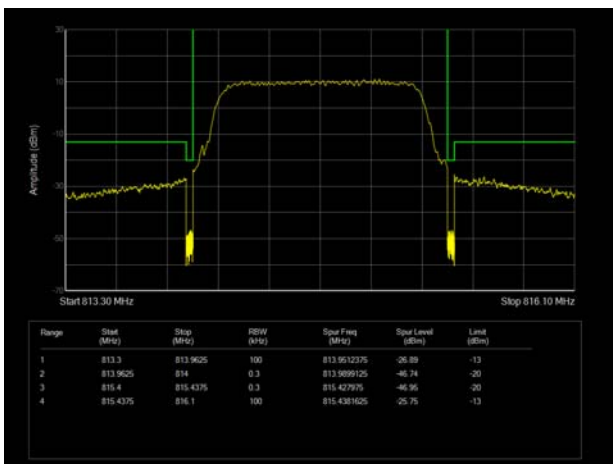

LTE Band 26 64QAM 1.4MHz CH-High 100%RB

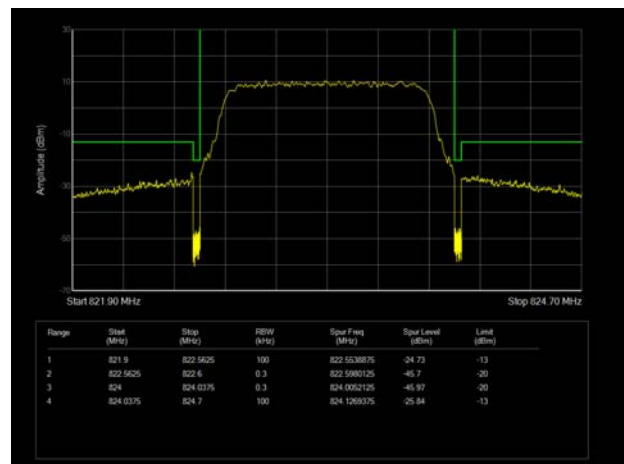

LTE Band 26 64QAM 3MHz CH-Low 1RB

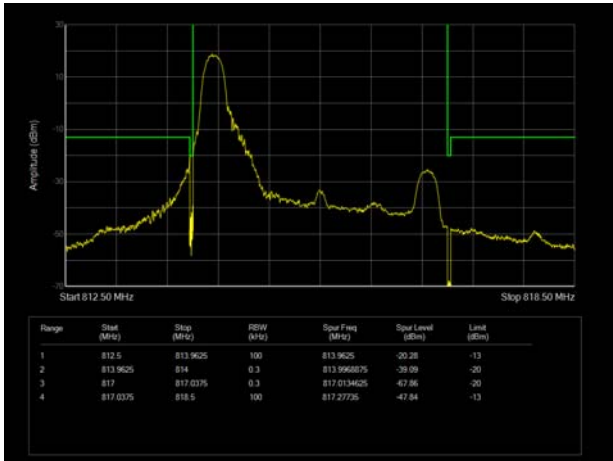

LTE Band 26 64QAM 3MHz CH-High 1RB

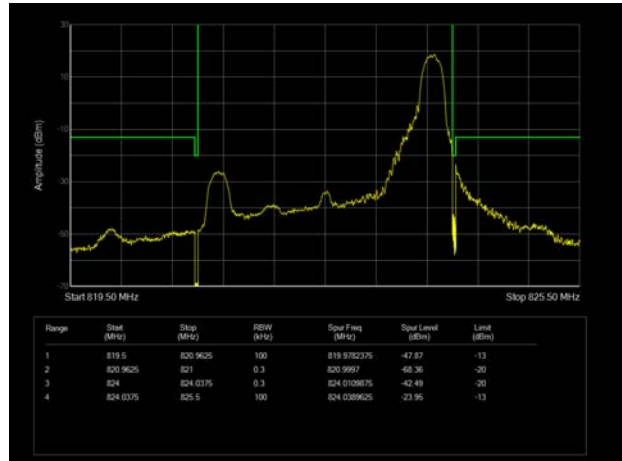

LTE Band 26 64QAM 3MHz CH-Low 100%RB

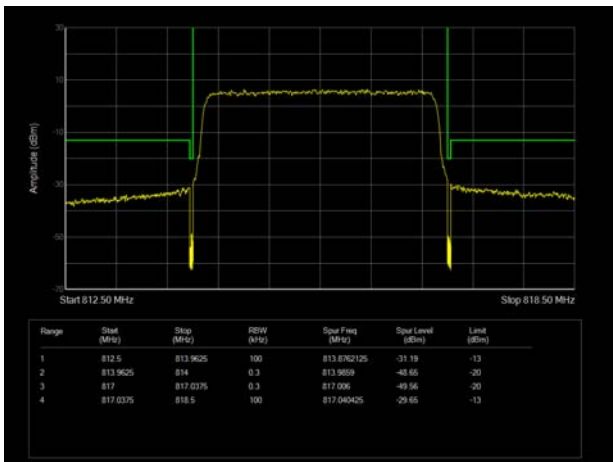

LTE Band 26 64QAM 3MHz CH-High 100%RB

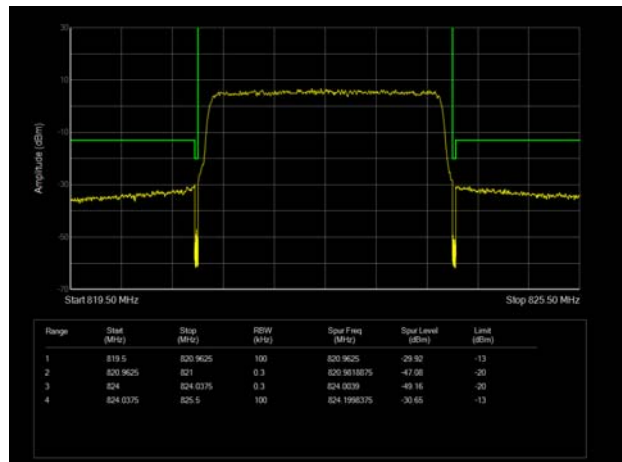

LTE Band 26 64QAM 5MHz CH-Low 1RB

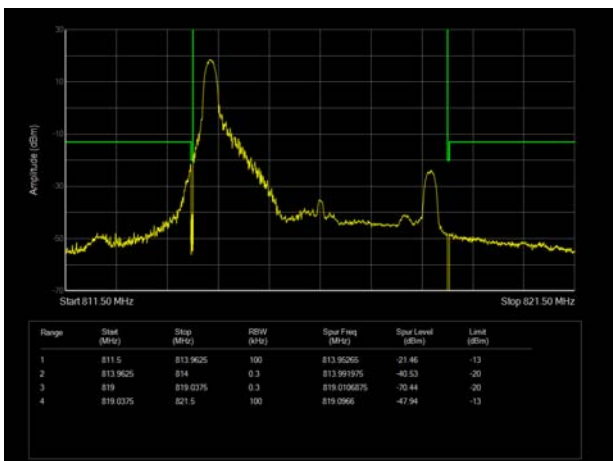

LTE Band 26 64QAM 5MHz CH-High 1RB

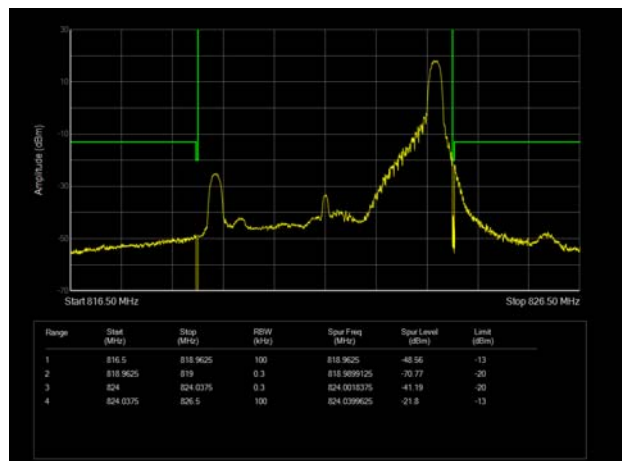

LTE Band 26 64QAM 5MHz CH-Low 100%RB

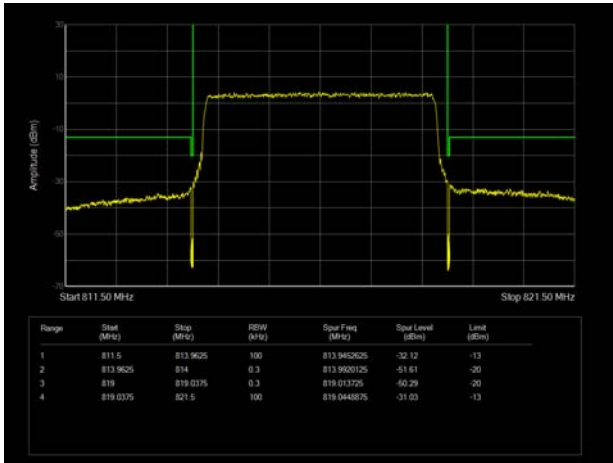

LTE Band 26 64QAM 5MHz CH-High 100%RB

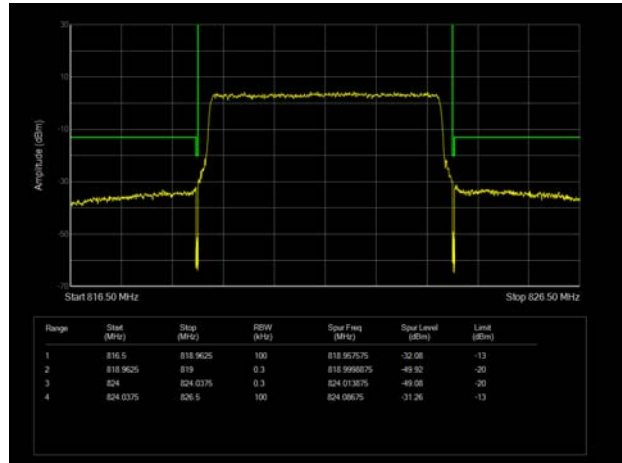

LTE Band 26 64QAM 10MHz CH-Low 1RB

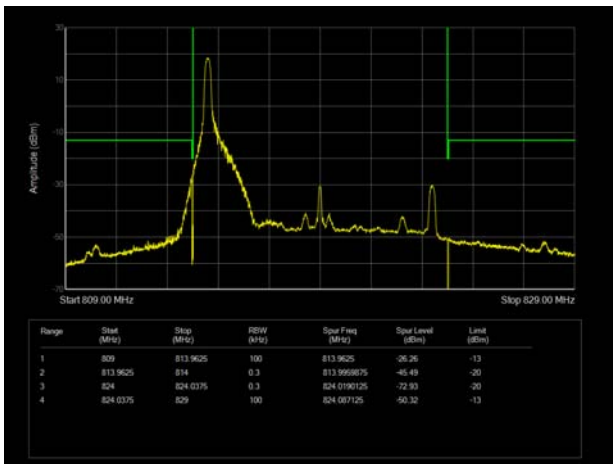

LTE Band 26 64QAM 10MHz CH-High 1RB

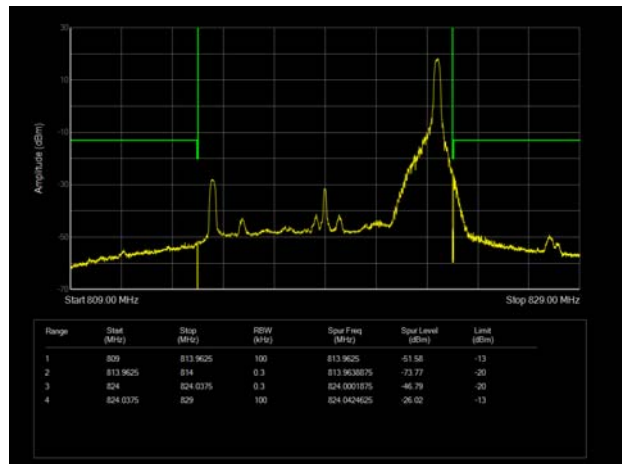

LTE Band 26 64QAM 10MHz CH-Low 100%RB

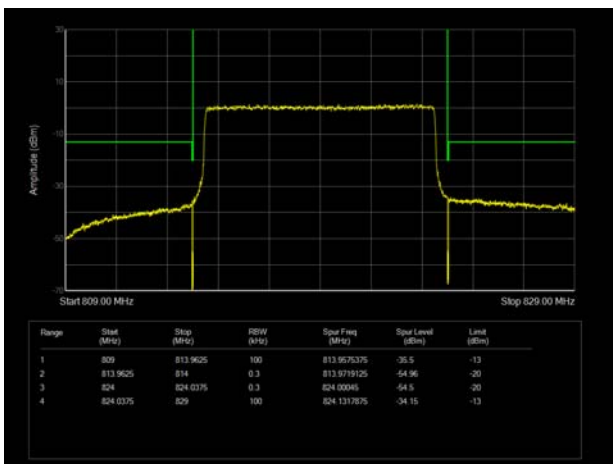

LTE Band 26 64QAM 10MHz CH-High 100%RB

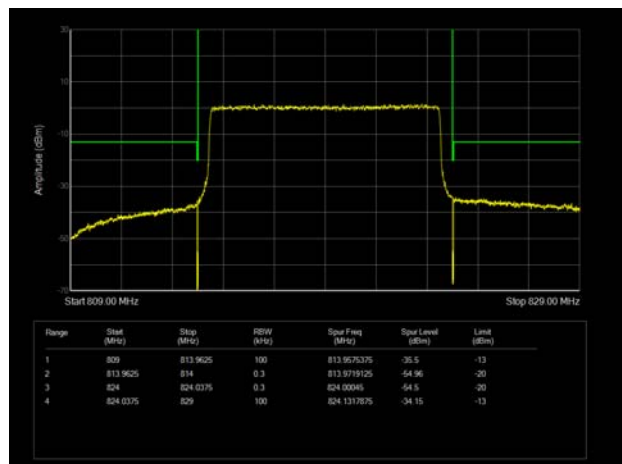

5.4. Peak-to-Average Power Ratio (PAPR)

Ambient condition

Temperature	Relative humidity
21°C ~25°C	40%~60%

Methods of Measurement

Measure the total peak power and record as P_{Pk}. And measure the total average power and record as P_{Avg}. Both the peak and average power levels must be expressed in the same logarithmic units (e.g., dBm). Determine the PAPR from:

$$PAPR (dB) = P_{Pk} (dBm) - P_{Avg} (dBm).$$

Test Setup

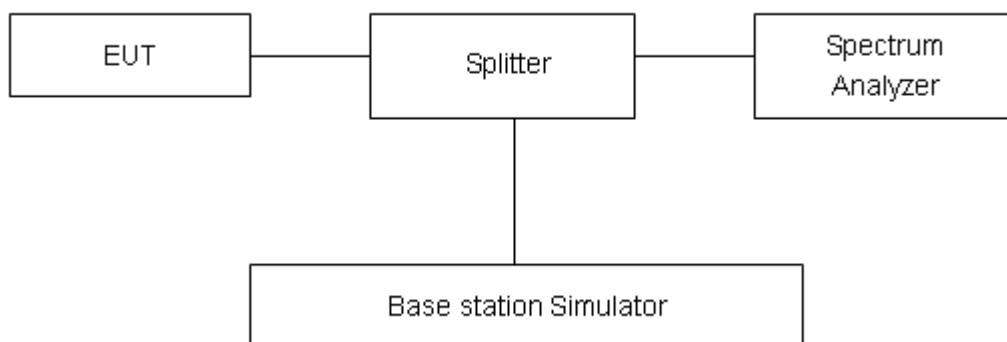

Limits

In measuring transmissions in this band using an average power technique, the peak-to-average ratio (PAR) of the transmission may not exceed 13 dB in 24.232(d).

Measurement Uncertainty

The assessed measurement uncertainty to ensure 95% confidence level for the normal distribution is with the coverage factor $k = 2$, $U = 0.4$ dB.

Test Results

LTE band 26							
Modulation	Bandwidth (MHz)	Channel	Peak (dBm)	Avg (dBm)	PAPR (dB)	Limit (dB)	Conclusion
QPSK	1.4	L	27.07	21.52	5.55	≤13	PASS
		M	27.16	21.47	5.69	≤13	PASS
		H	27.01	21.46	5.55	≤13	PASS
	3	L	27.08	21.53	5.55	≤13	PASS
		M	27.14	21.50	5.64	≤13	PASS
		H	27.13	21.44	5.69	≤13	PASS
	5	L	27.19	21.52	5.67	≤13	PASS
		M	27.31	21.54	5.77	≤13	PASS
		H	27.30	21.51	5.79	≤13	PASS
	10	M	27.19	21.53	5.66	≤13	PASS
16QAM	1.4	L	26.87	20.53	6.34	≤13	PASS
		M	26.95	20.53	6.42	≤13	PASS
		H	26.91	20.53	6.38	≤13	PASS
	3	L	26.92	20.56	6.36	≤13	PASS
		M	27.01	20.57	6.44	≤13	PASS
		H	26.95	20.50	6.45	≤13	PASS
	5	L	26.95	20.57	6.38	≤13	PASS
		M	27.01	20.60	6.41	≤13	PASS
		H	26.96	20.55	6.41	≤13	PASS
	10	M	26.99	20.56	6.43	≤13	PASS
64QAM	1.4	L	26.11	19.71	6.40	≤13	PASS
		M	26.11	19.71	6.40	≤13	PASS
		H	26.11	19.69	6.42	≤13	PASS
	3	L	26.63	20.24	6.39	≤13	PASS
		M	26.19	19.71	6.48	≤13	PASS
		H	26.13	19.68	6.45	≤13	PASS
	5	L	26.63	20.23	6.40	≤13	PASS
		M	26.28	19.76	6.52	≤13	PASS
		H	26.21	19.72	6.49	≤13	PASS
	10	M	26.71	20.25	6.46	≤13	PASS

5.5. Frequency Stability

Ambient condition

Temperature	Relative humidity
21°C ~25°C	40%~60%

Method of Measurement

1. Frequency Stability (Temperature Variation)

The temperature inside the climate chamber is varied from -30°C to +50°C in 10°C step size,

(1) With all power removed, the temperature was decreased to 0°C and permitted to stabilize for three hours.

(2) Measure the carrier frequency with the test equipment in a “call mode”. These measurements should be made within 1 minute of powering up the mobile station, to prevent significant self warming.

(3) Repeat the above measurements at 10°C increments from -30°C to +50°C. Allow at least 1.5 hours at each temperature, un-powered, before making measurements.

2. Frequency Stability (Voltage Variation)

The frequency stability shall be measured with variation of primary supply voltage as follows:

Primary Supply Voltage: The primary supply voltage is varied from 85% to 115% of the nominal value for non hand-carried battery and AC powered equipment. For hand-carried, battery-powered equipment, primary supply voltage is reduced to the battery operating end point which shall be specified by the manufacturer.

This transceiver is specified to operate with an input voltage of between 3.4 V and 4.33 V, with a nominal voltage of 3.85V.

Test setup

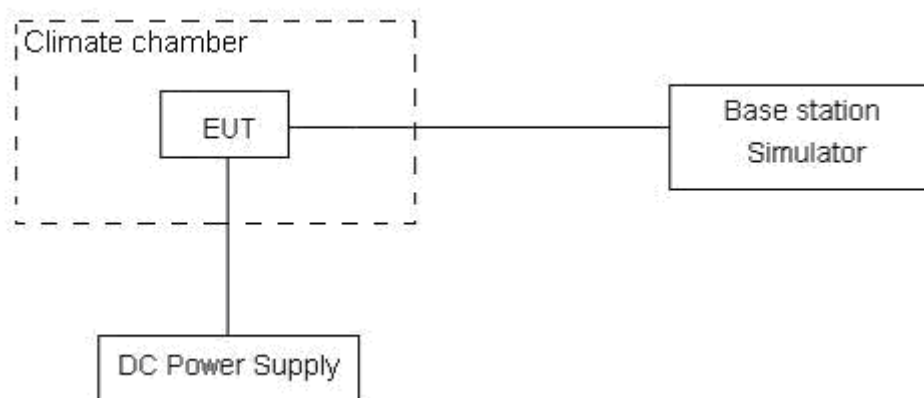

Limits

According to the Sec. 90.213.(a) Unless noted elsewhere, transmitters used in the services governed by this part must have a minimum frequency stability as specified in the following table.

Minimum Frequency Stability

[Parts per million (ppm)]

Frequency range (MHz)	Fixed and base stations	Mobile stations	
		Over 2 watts output power	2 watts or less output power
814 ~ 824	1.5	2.5	2.5

Measurement Uncertainty

The assessed measurement uncertainty to ensure 99.75% confidence level for the normal distribution is with the coverage factor $k = 3$, $U = 0.01$ ppm.



Test Result

LTE Band 26								
Condition		Freq.Error (Hz)	Freq.Error (Hz)	Freq.Error (Hz)	Frequency Stability (ppm)	Frequency Stability (ppm)	Frequency Stability (ppm)	Verdict
BANDWIDTH	1.4MHz							
Temperature	Voltage	64QAM	16QAM	QPSK	64QAM	16QAM	QPSK	
Normal (25°C)	Normal	13.90	3.62	12.44	0.01697	0.00442	0.01519	PASS
Extreme (50°C)		9.06	9.70	6.72	0.01107	0.01184	0.00820	PASS
Extreme (40°C)		4.57	16.91	2.70	0.00558	0.02065	0.00330	PASS
Extreme (30°C)		9.95	16.39	12.64	0.01215	0.02001	0.01543	PASS
Extreme (20°C)		3.26	15.17	14.61	0.00398	0.01853	0.01784	PASS
Extreme (10°C)		9.88	13.03	9.37	0.01206	0.01591	0.01144	PASS
Extreme (0°C)		14.04	3.01	8.77	0.01714	0.00368	0.01070	PASS
Extreme (-10°C)		15.44	5.69	3.89	0.01885	0.00695	0.00475	PASS
Extreme (-20°C)		5.98	6.26	11.50	0.00730	0.00764	0.01404	PASS
Extreme (-30°C)		17.49	1.04	15.20	0.02135	0.00127	0.01856	PASS
25°C	LV	15.44	13.35	3.66	0.01885	0.01629	0.00447	PASS
	HV	15.51	12.60	14.54	0.01894	0.01538	0.01775	PASS
Condition		Freq.Error (Hz)	Freq.Error (Hz)	Freq.Error (Hz)	Frequency Stability (ppm)	Frequency Stability (ppm)	Frequency Stability (ppm)	Verdict
BANDWIDTH	3MHz							
Temperature	Voltage	64QAM	16QAM	QPSK	64QAM	16QAM	QPSK	
Normal (25°C)	Normal	7.63	4.41	5.01	0.00932	0.00538	0.00612	PASS
Extreme (50°C)		11.34	15.97	4.87	0.01385	0.01950	0.00594	PASS
Extreme (40°C)		11.43	16.52	7.05	0.01396	0.02017	0.00861	PASS
Extreme (30°C)		13.44	10.89	9.03	0.01641	0.01329	0.01102	PASS
Extreme (20°C)		1.39	17.81	8.93	0.00170	0.02175	0.01090	PASS
Extreme (10°C)		9.90	6.80	2.37	0.01208	0.00831	0.00289	PASS
Extreme (0°C)		7.62	6.45	1.18	0.00930	0.00788	0.00144	PASS
Extreme (-10°C)		7.46	13.35	7.56	0.00911	0.01630	0.00923	PASS
Extreme (-20°C)		8.73	6.06	7.30	0.01066	0.00740	0.00891	PASS
Extreme (-30°C)		2.57	10.00	6.32	0.00314	0.01221	0.00771	PASS
25°C	LV	15.95	6.07	4.43	0.01948	0.00741	0.00541	PASS
	HV	17.32	3.41	17.27	0.02114	0.00416	0.02109	PASS
Condition		Freq.Error (Hz)	Freq.Error (Hz)	Freq.Error (Hz)	Frequency Stability (ppm)	Frequency Stability (ppm)	Frequency Stability (ppm)	Verdict
BANDWIDTH	5MHz							
Temperature	Voltage	64QAM	16QAM	QPSK	64QAM	16QAM	QPSK	
Normal (25°C)	Normal	6.66	7.12	5.38	0.00814	0.00869	0.00657	PASS
Extreme (50°C)		2.12	7.08	17.03	0.00259	0.00865	0.02079	PASS



Extreme (40°C)		3.43	2.92	1.03	0.00418	0.00357	0.00126	PASS
Extreme (30°C)		15.40	17.76	13.90	0.01881	0.02168	0.01697	PASS
Extreme (20°C)		7.64	14.51	6.36	0.00932	0.01772	0.00776	PASS
Extreme (10°C)		3.13	17.25	7.29	0.00383	0.02106	0.00890	PASS
Extreme (0°C)		2.98	8.69	5.44	0.00364	0.01062	0.00665	PASS
Extreme (-10°C)		14.32	15.73	14.35	0.01748	0.01920	0.01752	PASS
Extreme (-20°C)		13.34	11.18	13.25	0.01629	0.01365	0.01618	PASS
Extreme (-30°C)		17.23	17.82	10.74	0.02103	0.02176	0.01312	PASS
25°C	LV	13.50	14.67	10.19	0.01649	0.01791	0.01244	PASS
	HV	12.21	4.20	10.46	0.01491	0.00513	0.01277	PASS
Condition		Freq.Error (Hz)	Freq.Error (Hz)	Freq.Error (Hz)	Frequency Stability (ppm)	Frequency Stability (ppm)	Frequency Stability (ppm)	Verdict
BANDWIDTH	10MHz							
Temperature	Voltage	64QAM	16QAM	QPSK	64QAM	16QAM	QPSK	
Normal (25°C)	Normal	7.06	6.47	12.98	0.00861	0.00790	0.01584	PASS
Extreme (50°C)		14.34	10.20	4.77	0.01751	0.01246	0.00582	PASS
Extreme (40°C)		1.53	12.27	14.99	0.00187	0.01498	0.01831	PASS
Extreme (30°C)		13.69	14.94	10.33	0.01672	0.01825	0.01261	PASS
Extreme (20°C)		6.60	6.64	1.22	0.00806	0.00811	0.00150	PASS
Extreme (10°C)		12.97	17.33	15.66	0.01584	0.02116	0.01912	PASS
Extreme (0°C)		15.20	14.28	5.30	0.01856	0.01744	0.00647	PASS
Extreme (-10°C)		15.69	12.61	12.06	0.01916	0.01540	0.01473	PASS
Extreme (-20°C)		17.66	4.75	13.52	0.02156	0.00580	0.01650	PASS
Extreme (-30°C)		1.16	10.12	17.03	0.00142	0.01236	0.02079	PASS
25°C	LV	2.12	5.31	14.95	0.00259	0.00648	0.01825	PASS
	HV	6.18	4.10	16.37	0.00754	0.00501	0.01999	PASS

5.6. Spurious Emissions at Antenna Terminals

Ambient condition

Temperature	Relative humidity
21°C ~25°C	40%~60%

Method of Measurement

The EUT was connected to Spectrum Analyzer and Base Station Simulator via power Splitter. The measurement is carried out using a spectrum analyzer. The spectrum analyzer scans from 30MHz to the 10th harmonic of the carrier. The peak detector is used. RBW and VBW are set to 100 kHz, RBW is set to 1 kHz (0.009MHz~ 0.15 MHz), RBW is set to 10 kHz (0.15 MHz~ 30 MHz) RBW is set to 100 kHz (30MHz~1000 MHz) RBW is set to 1000 kHz (above 1000MHz) Sweep is set to ATUO.

Test setup

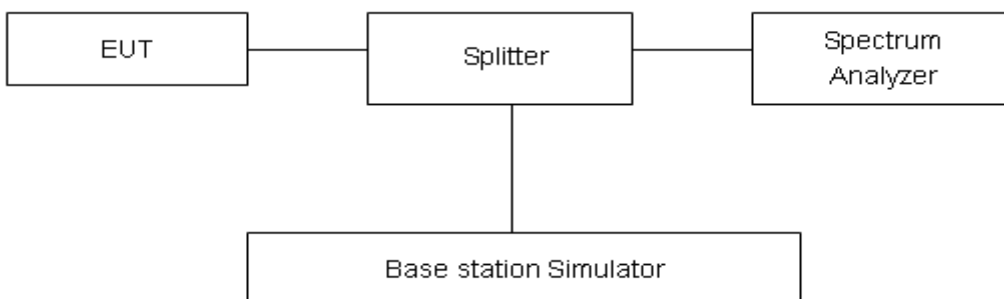

Limits

Rule Part 90.691 specifies that “The power of any emission outside of the authorized operating frequency ranges must be attenuated below the transmitting power (P) by a factor of at least 43 + 10 log (P) dB.”

Limit	-13 dBm
-------	---------

Measurement Uncertainty

The assessed measurement uncertainty to ensure 99.75% confidence level for the normal distribution is with the coverage factor $k = 1.96$.

Frequency	Uncertainty
9kHz-1GHz	0.684 dB
1GHz-12.75GHz	1.407 dB

Test Result

If disturbances were found more than 20dB below limit line, the mark is not required for the EUT.
The signal beyond the limit is carrier.

LTE Band 26 1.4MHz CH-Low 9kHz~10GHz

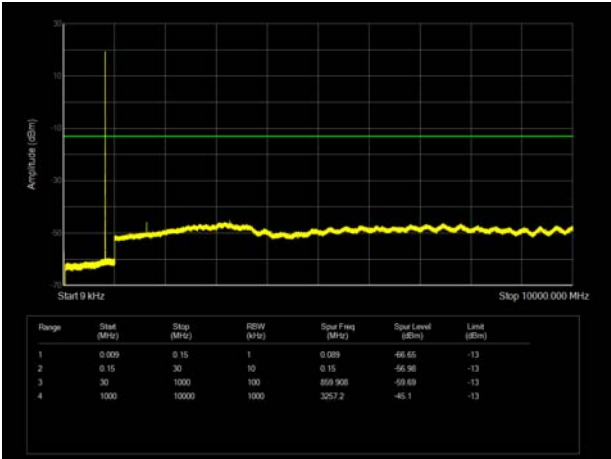

LTE Band 26 3MHz CH-Low 9kHz~10GHz

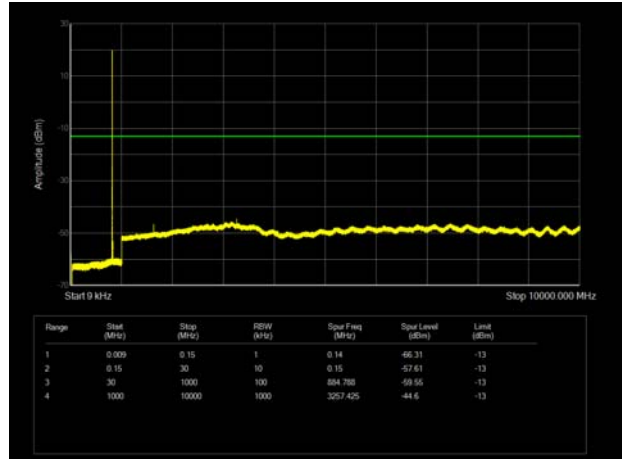

LTE Band 26 1.4MHz CH-Middle 9kHz~10GHz

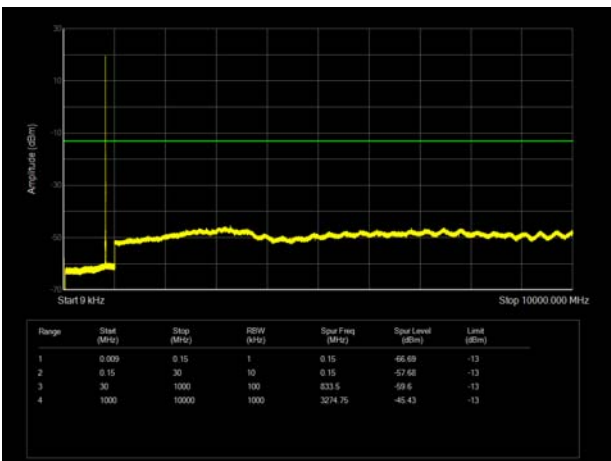

LTE Band 26 3MHz CH-Middle 9kHz~10GHz

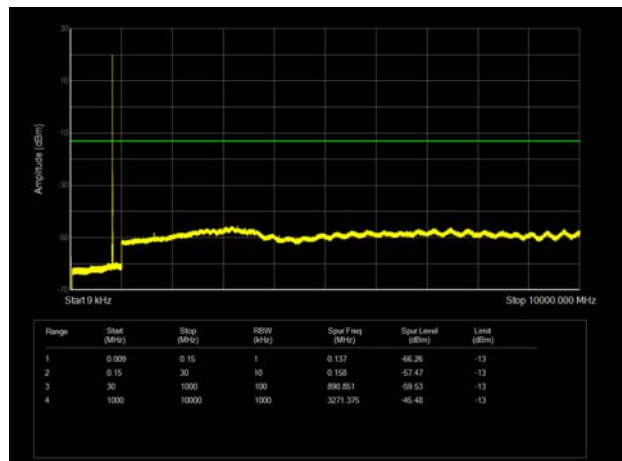

LTE Band 26 1.4MHz CH-High 9kHz~10GHz

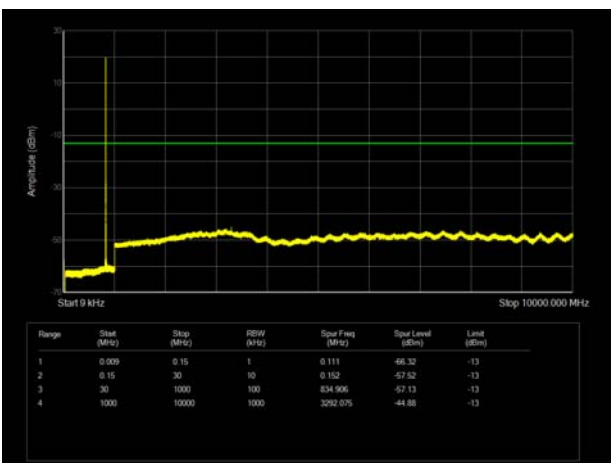

LTE Band 26 3MHz CH-High 9kHz~10GHz

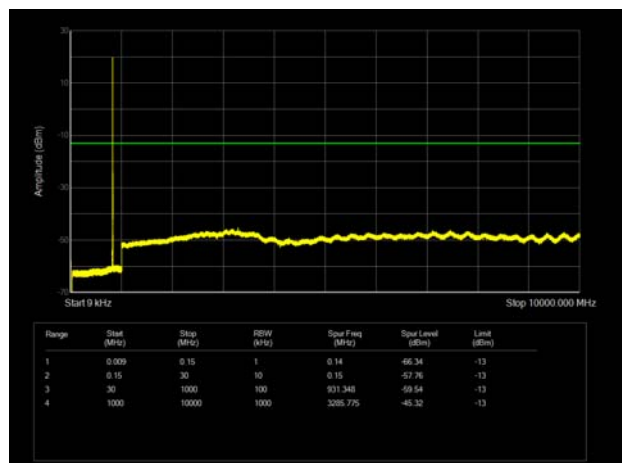

LTE Band 26 5MHz CH-Low 9kHz~10GHz

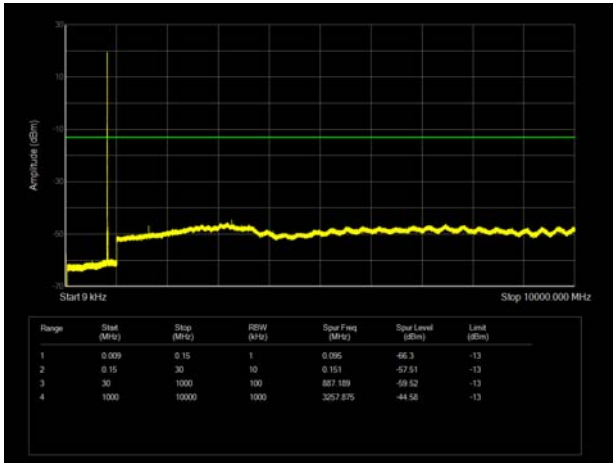

LTE Band 26 5MHz CH-High 9kHz~10GHz

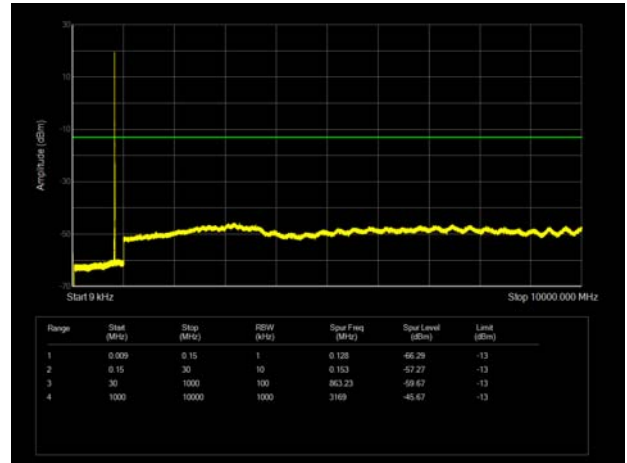

LTE Band 26 5MHz CH-Middle 9kHz~10GHz

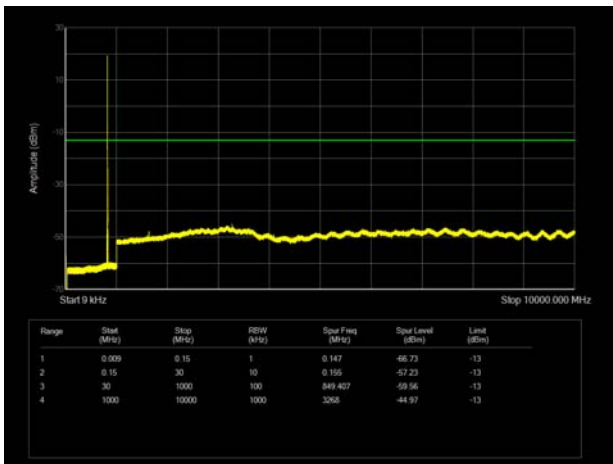

LTE Band 26 10MHz CH-Middle 9kHz~10GHz

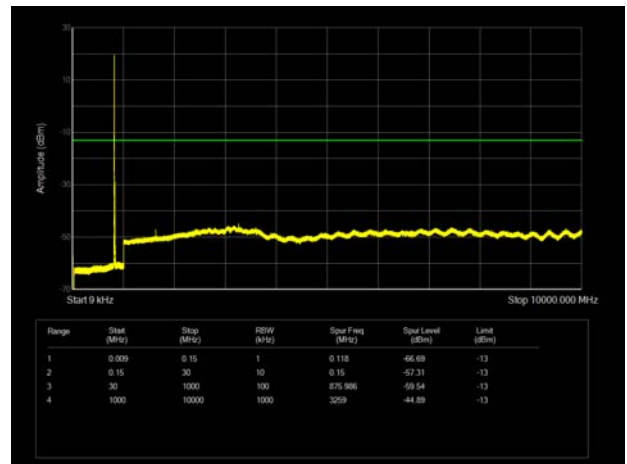

5.7. Radiates Spurious Emission

Ambient condition

Temperature	Relative humidity
21°C ~25°C	40%~60%

Method of Measurement

1. The testing follows FCC KDB 971168 v03r01 Section 5.8 and ANSI C63.26 (2015).
2. Below 1GHz: The EUT is placed on a turntable 0.8 meters above the ground in the chamber, 3 meter away from the antenna. The maximal emission value is acquired by adjusting the antenna height, polarisation and turntable azimuth. Normally, the height range of antenna is 1 m to 4 m, the azimuth range of turntable is 0° to 360°, and the receive antenna has two polarizations Vertical (V) and Horizontal (H). Above 1GHz: (Note: the FCC's permission to use 1.5m as an alternative per TCBC Conf call of Dec. 2, 2014.) The EUT is placed on a turntable 1.5 meters above the ground in the chamber, 3 meter away from the antenna. The maximal emission value is acquired by adjusting the antenna height, polarisation and turntable azimuth. Normally, the height range of antenna is 1 m to 4 m, the azimuth range of turntable is 0° to 360°, and the receive antenna has two polarizations Vertical (V) and Horizontal (H).
3. A loop antenna, A log-periodic antenna or horn antenna shall be substituted in place of the EUT. The log-periodic antenna will be driven by a signal generator and the level will be adjusted till the same power value on the spectrum analyzer or receiver. The level of the spurious emissions can be calculated through the level of the signal generator, cable loss, the gain of the substitution antenna and the reading of the spectrum analyzer or receiver.
4. The EUT is then put into continuously transmitting mode at its maximum power level during the test. Set Test Receiver or Spectrum RBW=100kHz,VBW=300kHz, and the maximum value of the receiver should be recorded as (Pr).
5. The EUT shall be replaced by a substitution antenna. In the chamber, an substitution antenna for the frequency band of interest is placed at the reference point of the chamber. An RF Signal source for the frequency band of interest is connected to the substitution antenna with a cable that has been constructed to not interfere with the radiation pattern of the antenna. A power (PMea) is applied to the input of the substitution antenna, and adjust the level of the signal generator output until the value of the receiver reach the previously recorded (Pr). The power of signal source (PMea) is recorded. The test should be performed by rotating the test item and adjusting the receiving antenna polarization.
6. A amplifier should be connected to the Signal Source output port. And the cable should be connect between the Amplifier and the Substitution Antenna. The cable loss (Pcl) ,the Substitution Antenna Gain (Ga) and the Amplifier Gain (PAg) should be recorded after test.
7. The measurement results are obtained as described below:
$$\text{Power(EIRP)} = \text{PMea} - \text{PAg} - \text{Pcl} + \text{Ga}$$

The measurement results are amend as described below:
$$\text{Power(EIRP)} = \text{PMea} - \text{Pcl} + \text{Ga}$$
8. This value is EIRP since the measurement is calibrated using an antenna of known gain (2.15 dBi) and known input power. ERP can be calculated from EIRP by subtracting the gain of the dipole, ERP

= EIRP-2.15dBi.

The modulation mode and RB allocation refer to section 5.1, using the maximum output power configuration.

Test setup

9KHz ~ 30MHz

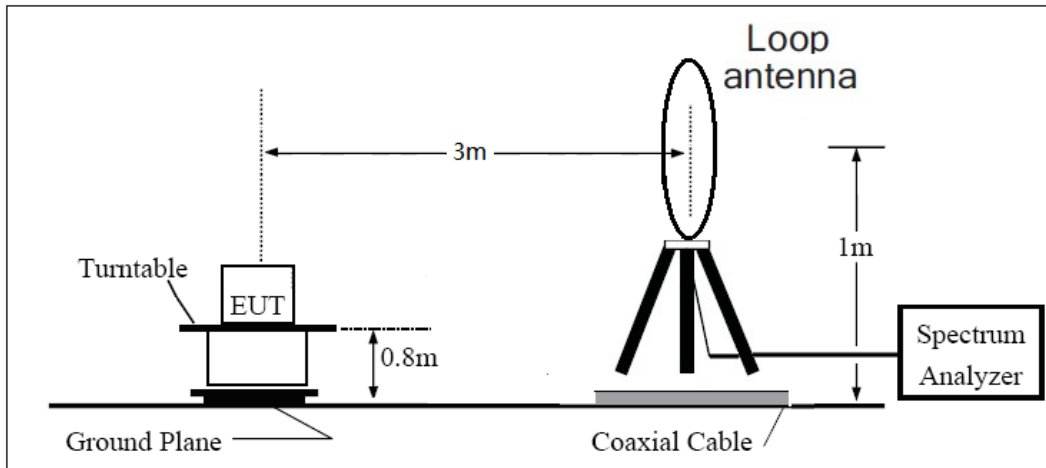

30MHz ~ 1GHz

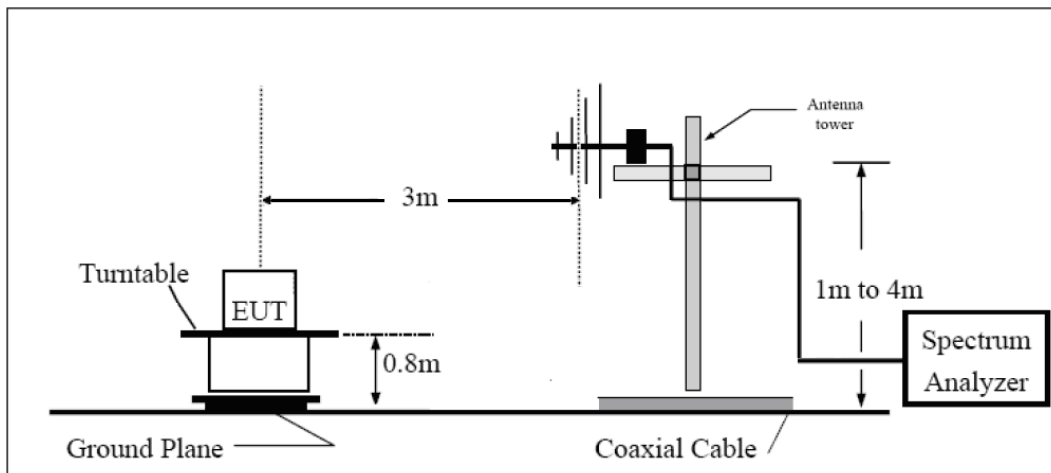

Above 1GHz

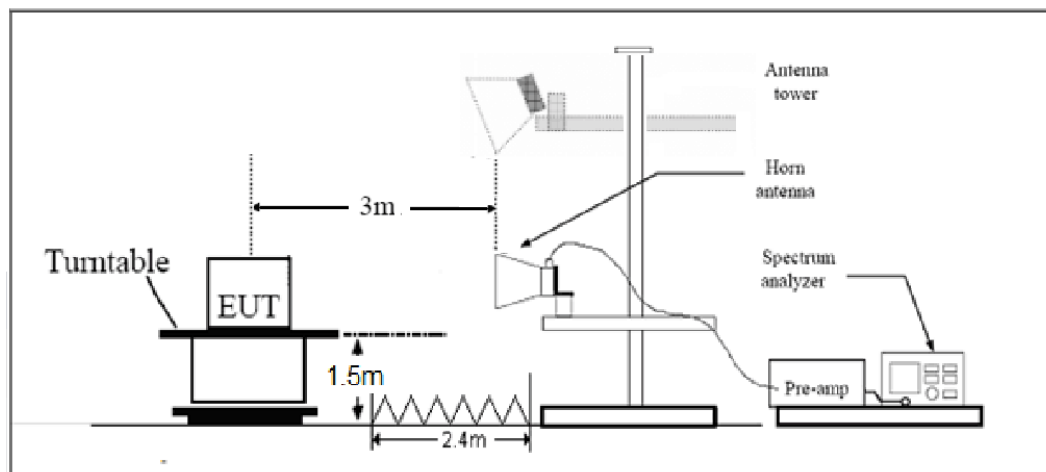

**Limits**

Rule Part 90.691 specifies that “The power of any emission outside of the authorized operating frequency ranges must be attenuated below the transmitting power (P) by a factor of at least $43 + 10 \log(P)$ dB.”

Limit	-13 dBm
-------	---------

Measurement Uncertainty

The assessed measurement uncertainty to ensure 95% confidence level for the normal distribution is with the coverage factor $k = 1.96$, $U = 3.55$ dB.

**Test Result**

Sweep the whole frequency band through the range from 30MHz to the 10th harmonic of the carrier, the emissions below the noise floor will not be recorded in the report.

LTE Band 26 1.4MHz CH Middle

Harmonic	Frequency (MHz)	SG (dBm)	Cable Loss (dB)	Gain (dBi)	Antenna Polarization	ERP Level (dBm)	Limit (dBm)	Margin (dB)	Azimuth (deg)
2	1636.60	-46.25	1.70	8.70	Vertical	-41.40	-13.00	28.40	45
3	2454.90	-41.07	2.30	12.00	Vertical	-33.52	-13.00	20.52	135
4	3276.00	-54.62	2.20	13.10	Vertical	-45.87	-13.00	32.87	315
5	4095.00	-55.81	3.00	12.50	Vertical	-48.46	-13.00	35.46	45
6	4914.00	-54.48	3.10	12.50	Vertical	-47.23	-13.00	34.23	270
7	5733.00	-54.27	3.40	12.50	Vertical	-47.32	-13.00	34.32	0
8	6552.00	-58.47	3.80	11.50	Vertical	-52.92	-13.00	39.92	180
9	7371.00	-48.57	4.20	12.20	Vertical	-42.72	-13.00	29.72	90
10	8190.00	-51.72	4.30	12.30	Vertical	-45.87	-13.00	32.87	315

Note: 1.The other Spurious RF Radiated emissions level is no more than noise floor.

2.The worst emission was found in the antenna is Vertical position.

LTE Band 26 5MHz CH Middle

Harmonic	Frequency (MHz)	SG (dBm)	Cable Loss (dB)	Gain (dBi)	Antenna Polarization	ERP Level (dBm)	Limit (dBm)	Margin (dB)	Azimuth (deg)
2	1633.00	-46.76	1.70	8.70	Vertical	-41.91	-13.00	28.91	0
3	2449.50	-41.03	2.30	12.00	Vertical	-33.48	-13.00	20.48	180
4	3266.00	-53.06	2.20	13.10	Vertical	-44.31	-13.00	31.31	45
5	4083.00	-54.87	3.00	12.50	Vertical	-47.52	-13.00	34.52	180
6	4903.00	-54.48	3.10	12.50	Vertical	-47.23	-13.00	34.23	0
7	5715.50	-54.24	3.40	12.50	Vertical	-47.29	-13.00	34.29	225
8	6538.00	-58.13	3.80	11.50	Vertical	-52.58	-13.00	39.58	45
9	7348.50	-51.11	4.20	12.20	Vertical	-45.26	-13.00	32.26	90
10	8165.00	-48.09	4.30	12.30	Vertical	-42.24	-13.00	29.24	135

Note: 1.The other Spurious RF Radiated emissions level is no more than noise floor.

2.The worst emission was found in the antenna is Vertical position.



LTE Band 26 10MHz CH Middle

Harmonic	Frequency (MHz)	SG (dBm)	Cable Loss (dB)	Gain (dBi)	Antenna Polarization	ERP Level (dBm)	Limit (dBm)	Margin (dB)	Azimuth (deg)
2	1628.00	-50.47	1.70	8.70	Vertical	-45.62	-13.00	32.62	315
3	2442.00	-40.66	2.30	12.00	Vertical	-33.11	-13.00	20.11	45
4	3256.00	-55.14	2.20	13.10	Vertical	-46.39	-13.00	33.39	45
5	4070.00	-54.00	3.00	12.50	Vertical	-46.65	-13.00	33.65	225
6	4884.00	-62.61	3.10	12.50	Vertical	-55.36	-13.00	42.36	180
7	5698.00	-54.01	3.40	12.50	Vertical	-47.06	-13.00	34.06	270
8	6512.00	-59.63	3.80	11.50	Vertical	-54.08	-13.00	41.08	315
9	7326.00	-47.88	4.20	12.20	Vertical	-42.03	-13.00	29.03	90
10	8140.00	-47.52	4.30	12.30	Vertical	-41.67	-13.00	28.67	0

Note: 1. The other Spurious RF Radiated emissions level is no more than noise floor.

2. The worst emission was found in the antenna is Vertical position.



6. Main Test Instruments

Name	Manufacturer	Type	Serial Number	Calibration Date	Expiration Date
Base Station Simulator	R&S	CMW500	113645	2021-05-15	2022-05-14
Spectrum Analyzer	Key sight	N9020A	MY52330084	2021-05-15	2022-05-14
Universal Radio Communication Tester	Key sight	E5515C	MY48367192	2021-05-15	2022-05-14
Signal Analyzer	R&S	FSV30	104028	2021-05-15	2022-05-14
Signal Analyzer	R&S	FSV3030	101411	2020-12-13	2021-12-12
Horn Antenna	Schwarzbeck	BBHA 9120D	1594	2020-12-17	2021-12-16
Software	R&S	EMC32	10.35.10	/	/

*****END OF REPORT *****



ANNEX A: The EUT Appearance

The EUT Appearance are submitted separately.



ANNEX B: Test Setup Photos

The Test Setup Photos are submitted separately.