

Product Specification

Comata 2.4 GHz SMD Antenna

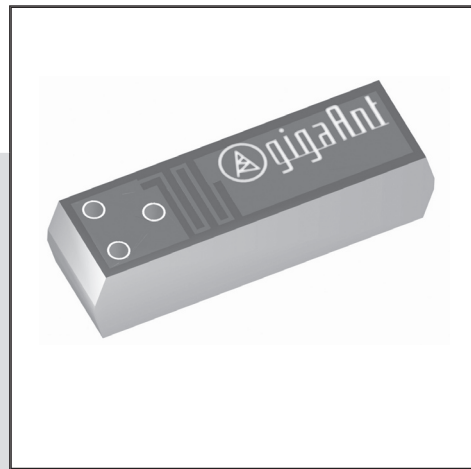

TABLE OF CONTENT

1. Features	2
2. Description	2
3. Application	2
4. Model name	3
5. General data	3
6. Electrical characteristics	3
7. Electrical performance	4
7.1 Voltage Standing Wave Ratio	4
7.2 3D-Radiation	4
7.3 Radiation patterns	4
8. Antenna Dimensions	5
9. Antenna Foot print	5
10. Electrical interface	6
10.1 Transmission line and matching	6
10.2 Test board dimensions	6
10.3 Test board matching	6
11. Soldering	6
11.1 Recommended soldering conditions	6
11.2 Leadfree soldering	6
12. Reliability	7
12.1 Temperature and Humidity	7
12.2 Mechanical	7
12.3 Miscellaneous	7
12.4 Judgement standard	7
13. Hazardous Material Regulation Conformance	7
14. Application example	8
15. Packaging	9
15.1 Shelf storage recommendation	9
15.2 Tape characteristics	9
15.3 Reel dimension	9
15.4 Box dimension	9
15.5 Bag properties	9
15.6 Reel label information	9
16. Contact information	10

1. FEATURES

- Designed for 2.4 GHz applications [Bluetooth™, WiFi™ (802.11b/g), Zigbee™, WiMedia™ etc.]
- Intended for SMD mounting
- Supplied in tape on reel

2. DESCRIPTION

The Comata antenna is intended for use with all 2.4 GHz applications. The antenna requires a groundplane, i.e your device acts as an active part of the antenna and thus demand careful consideration concerning its placement

3. APPLICATION

- Handheld devices
- Headsets
- Laptops
- Sensors

4. MODEL NAME

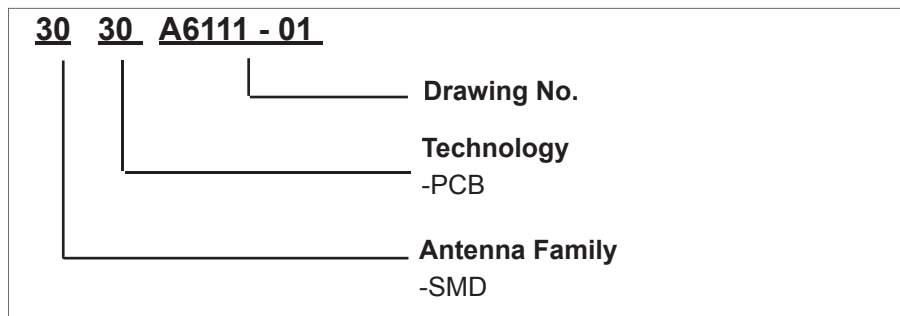

5. GENERAL DATA

Product Name	Comata 2.4 GHz
Article No.	3030A6111-01
Frequency	2.4-2.5 GHz
Polarization	Linear
Peak Gain	1.9 dBi
Impedance	50 Ohm

6. ELECTRICAL CHARACTERISTICS

	Characteristics			Conditions*
	Min	Typ	Max	
Peak Gain	dBi	dBi	dBi	Frequency 2.4-2.5 GHz, Measured in 3D chamber (near field)
Efficiency	50%	55%	60%	
VSWR	2:1	2:1	2:1	Frequency 2.4-2.5 GHz, Measured in Network Analyzer

7. ELECTRICAL PERFORMANCE

7.1 Voltage Standing Wave Ratio

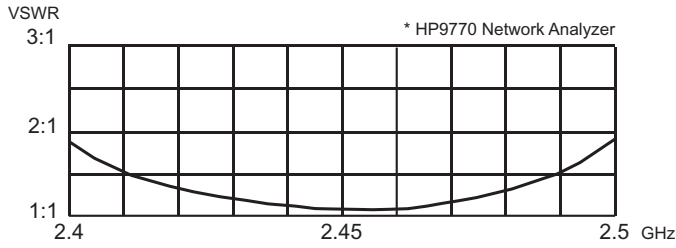

7.2 3D-Radiation

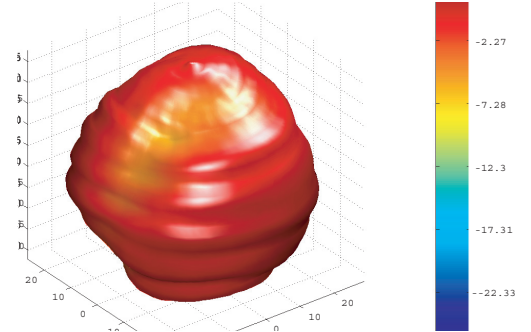

7.3 Radiation patterns

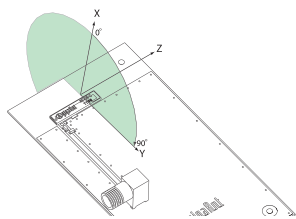

XY- Plane

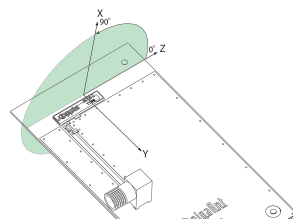

XZ- Plane

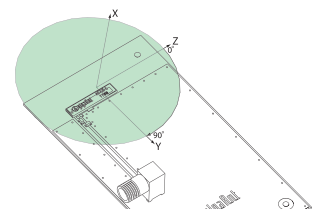

YZ- Plane

Total polarization

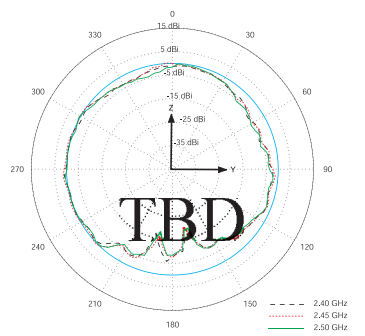
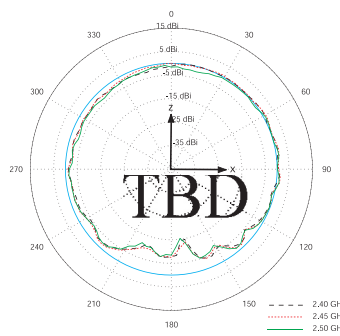
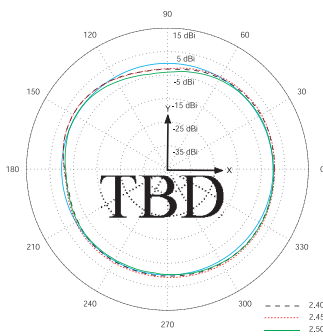

Vertical polarization

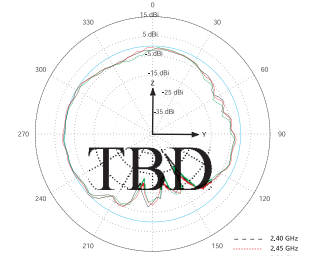
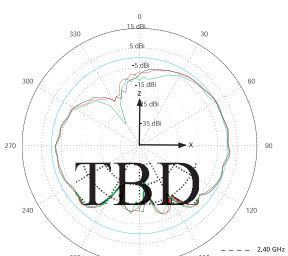
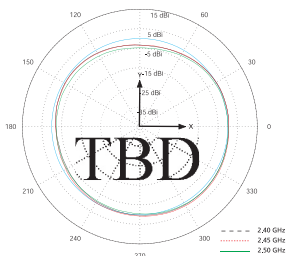

Horizontal polarization

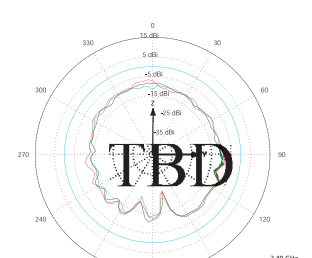
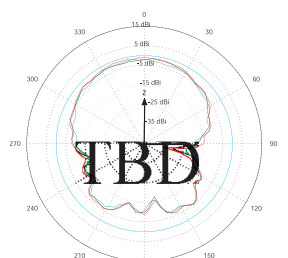
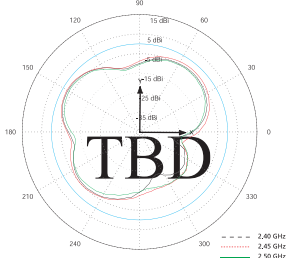

8. ANTENNA DIMENSIONS

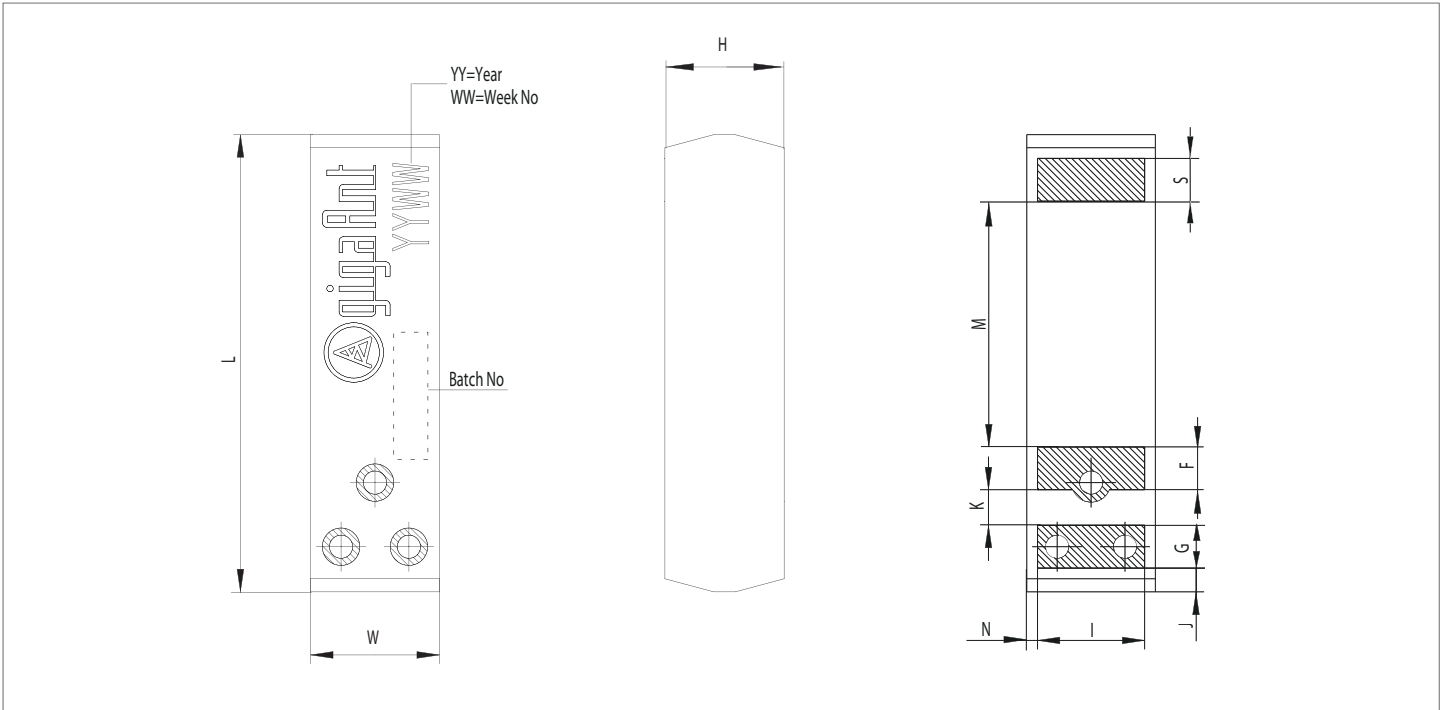

L	W	H	G	F	S	I	J	K	M	N
Length	Width	Height	Ground	Feed	Solder					
12.8 ±0.3	3.6 ±0.2	3.3±0.2	1.2±0.1	1.2±0.1	1.2±0.1	3.0±0.1	0.65±0.25	1.0±0.1	6.9±0.2	0.3±0.1

Dimensions in millimeter

9. ANTENNA FOOT PRINT

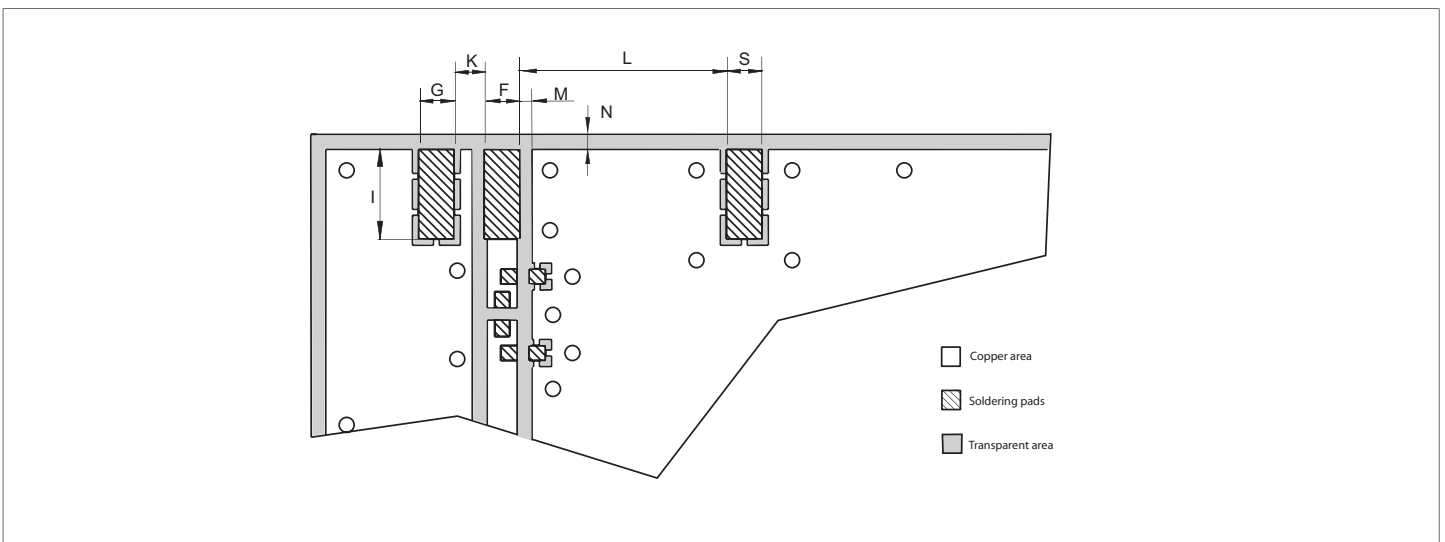

G	F	S	I	K	L	M	N
Ground	Feed	Solder					
1.2±0.1	1.2±0.1	1.2±0.1	3.0±0.1	1.0±0.1	6.9±0.2	0.4±0.1	0.5±0.1

Dimensions in millimeter

10. ELECTRICAL INTERFACE

10.1 Transmission line and matching

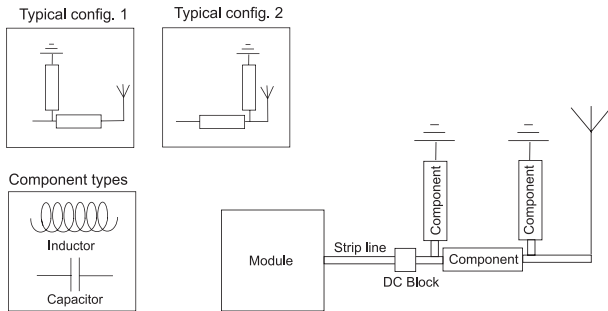

The matching network has to be individually designed using one, two or three components.

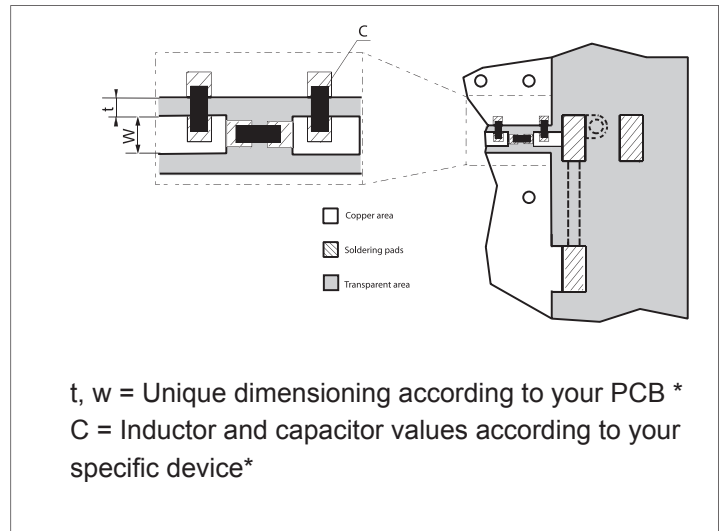

t, w = Unique dimensioning according to your PCB *
 C = Inductor and capacitor values according to your specific device*

* gigaAnt provides this service upon request

10.2 Test board dimensions

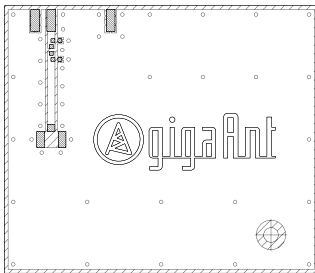

The testboard is designed for evaluation purposes for Comata 2.4 GHz SMD antenna. The board has the same size as a typical CF card and is fitted with an U.FL connector.

10.3 Test board matching

The testboard is matched with above specified component. Note! The component value(s) will vary depending on size of PCB, surrounding components etc.

11. SOLDERING

11.1 Recommended soldering conditions

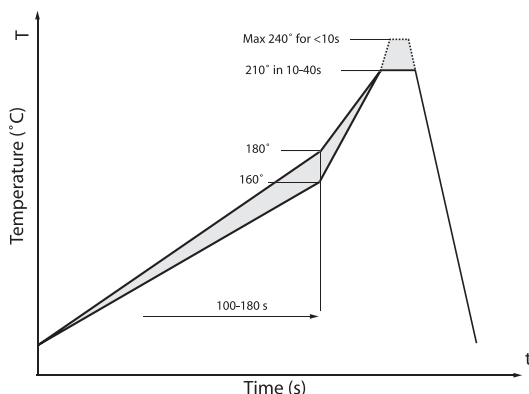

11.2 Leadfree soldering

The antenna has been tested and approved for leadfree soldering. The reflow curve and solder paste used is listed below.

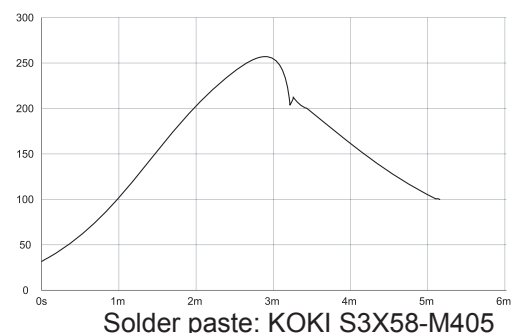

12. RELIABILITY

12.1 Temperature and Humidity

Item	Standard	Low	High	Duration
Operating temperature	EN/IEC 60068-2-2, Test Bd: Dry heat	-30 degC	+90 degC	-
Temperature cycling	EN/IEC 60068-2-14, Test Na: Change of temperature	-40 degC	+90 degC	500 cycles /10 min
Storage life Humidity	EN/IEC 60068-2-1, Test Ca: Damp heat	+60 degC / 90% RH		500 h

12.2 Mechanical

Item	Standard	Low	High	Duration
Bending	IEC 60068-2-21, Test Ue1: Bending	Bending 1 mm at a rate of 1 mm/s with support at end of PCB 1mm depth on reference board		
Shear	IEC 60068-2-21, Test Ue3: Shear	Force of 5 N applied to the side of the antenna.		
Drop test		Dummy weight: 150g Height: 170cm		One drop at each side, total drops: 6

12.3 Miscellaneous

Item	Standard	Low	High	Duration
Solderability	EN/IEC 60068-2-58, Test Td	Visual inspection of soldering pads. Estimation of how many % of the pads that are well tin plated.		

12.4 Judgement standard

The judgement of the above tests should be made as follows:

1. Visual inspection - Normal appearance with no obvious cracking, peeling-off.
2. Electrical inspection - The DUT satisfies the VSWR specification throughout the 2.4-2.5 GHz band

13. HAZARDOUS MATERIAL REGULATION CONFORMANCE

Cadmium and cadmium compound.	Lead and lead compound
Organic brominated compound (PBB, PBDE)	Mercury and mercury compound
Polychlorinated biphenyl (PCB)	Sexivalent chrome compound
Polychlorinated naphthalene (PCN)	Chlorinated paraffin (CP)
Organic tin compound	Mirex
Asbestos	Formaldehyde
Azo compound	Tetra-bromo-bisphenol-A-bis (TBBP-A-bis)

14. APPLICATION EXAMPLE

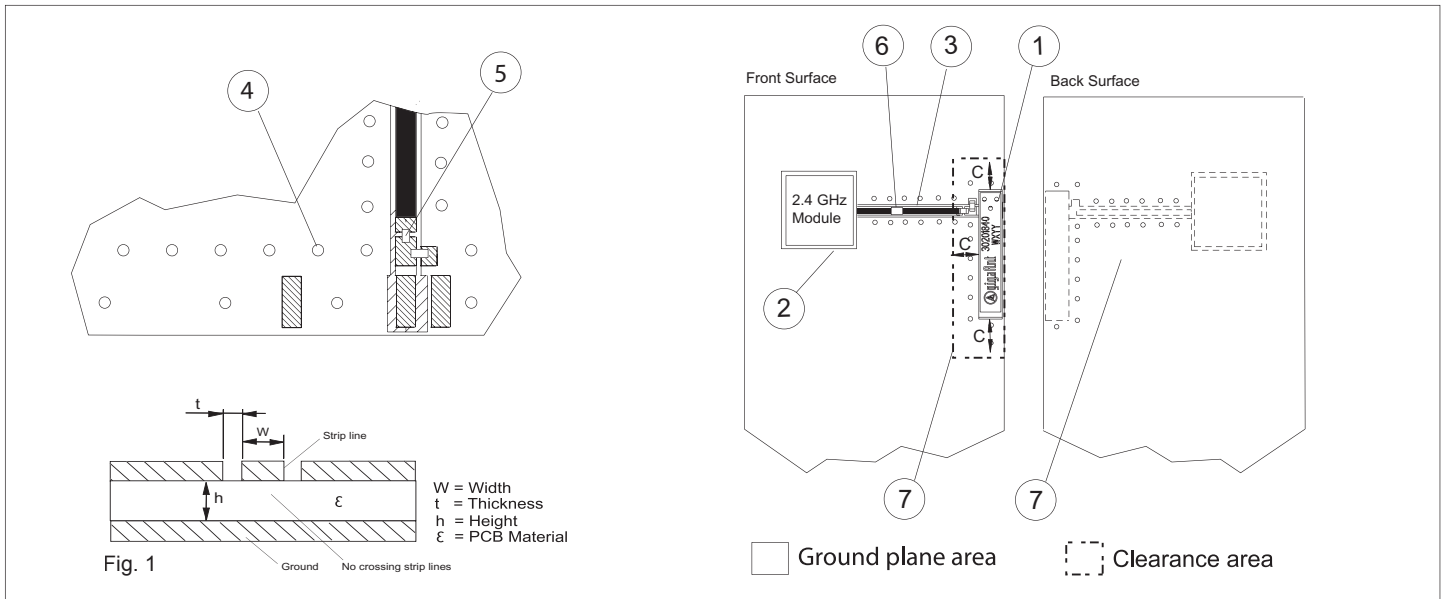

The antenna is of a quarter wave type and is dependent on the groundplane area to complete the antenna function. The antenna performance is also dependent on the size of the groundplane.

1.	<p>Placement of the antenna</p> <p>The antenna shall be placed on a groundplane area, preferably at the edge of the PCB oriented as above.</p>
2.	<p>Placement of 2.4 GHz module</p> <p>To avoid losses in the strip line, the module shall be placed as close to the antenna as possible.</p>
3.	<p>Strip line</p> <p>The strip line must be dimensioned according to your specific PCB. (see fig 1). No crossing strip lines are allowed between the strip line and its ground plane.</p>
4.	<p>Via connections</p> <p>To avoid spurious effects, via connections must be made to analogue ground.</p>
5.	<p>Component matching</p> <p>Component values are depending on antenna placement, PCB dimensions and location of other components.</p>
6.	<p>DC Block</p> <p>Might be needed depending on RF Module configuration.</p>
7.	<p>Clearance</p> <p>Front surface: Minimum clearance to other components, C = 2-5 mm. Back surface: Components allowed.</p>
8.	<p>Casing material</p> <p>No metal casing or plastics using metal flakes shall be used, avoid also metallic based paint or laquer.</p>

**Note ! Incorrect implementation of the antenna will affect the performance.
Contact gigaAnt for implementation services**

15. PACKAGING

15.1 Shelf storage recommendation

Temperature	-10 to +40 degree C
Humidity	Less than 75% RH
Shelf Life	18 Months
Storage place	Away from corrosive gas and direct sunlight

15.2 Tape characteristics

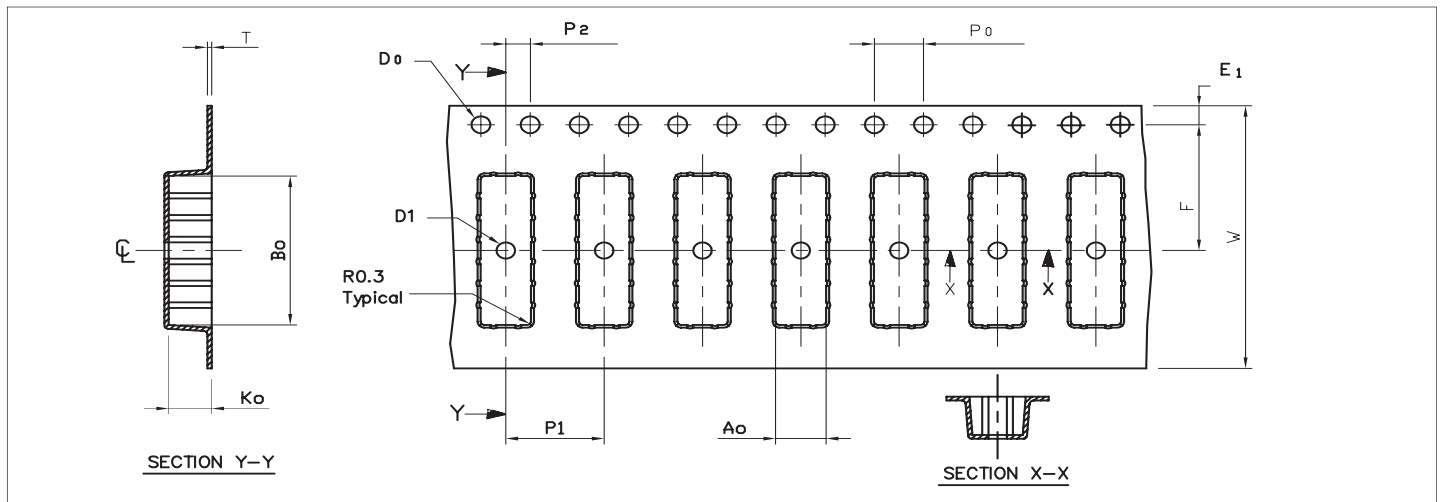

W	F	E ₁	P ₀	P ₁	P ₂	A ₀	B ₀	K ₀	T	D ₀	D ₁
24±0.3	11.50±0.1	1.75±0.1	4.0±0.1	8.0±0.1	2.0±0.1	4.1±0.1	13.6±0.1	3.50±0.1	0.35±0.05	1.55±0.05	1.5 Min

Dimensions in millimeter

Quantity	Leading space	Trailing space
2000 Pcs / reel	50 blank antenna holders	37 blank antenna holders

15.3 Reel dimension

Material:	Conductive Polystyrene	
Width [mm]	W: 32	
Reel dia [mm]	D: 330(13")	
Hub dia [mm]	H: 100(4")	
Shaft dia [mm]	C: 13	

15.4 Box dimension

Material:	Cardboard	
Width [mm]	W: 345	
Breadth [mm]	B: 345	
Thickness [mm]	H: 45	

15.5 Bag properties

Antistatic Aluminium Moisture Barrier Bag
Thickness [mil] T: 3.2

15.6 Reel label information

gigaAnt Article number : XXXXXXXX-XX Description : Product name, Frequency Hz Reel Quantity : XXXX Pcs. Order No: Customer PO number Date: YYMMDD

16. CONTACT INFORMATION

www.gigaAnt.com

Europe & Africa

e-mail: info.EU@gigaAnt.com

Tel: +46 46 286 4177

America

e-mail: info.US@gigaAnt.com

Tel: +1 817 430 7291

Asia and Pacific

e-mail: info.ASIA@gigaAnt.com

Tel: +656 890 6200

Or your local gigaAnt representative