



FCC PART 15.247

TEST REPORT

For

SZ DJI TECHNOLOGY CO., LTD

14th floor, West Wing, Skyworth Semiconductor Design Building NO.18 Gaoxin South 4th Ave,
Nanshan, Shenzhen, Guangdong, China

FCC ID: SS3-ZT300A1604

Report Type: Original Report	Product Type: DATALINK PRO 900
Test Engineer: <u>Emily Wang</u>	<i>Emily Wang</i>
Report Number: <u>RDG160406002-00</u>	
Report Date: <u>2016-05-20</u>	
Reviewed By: <u>Jerry Zhang EMC Manager</u>	<i>Jerry Zhang</i>
Test Laboratory:	Bay Area Compliance Laboratories Corp. (Dongguan) No.69 Pulongcun, Puxinhu Industrial Zone, Tangxia, Dongguan, Guangdong, China Tel: +86-769-86858888 Fax: +86-769-86858891 www.baclcorp.com.cn

Note: This test report is prepared for the customer shown above and for the device described herein. It may not be duplicated or used in part without prior written consent from Bay Area Compliance Laboratories Corp. (Dongguan).

TABLE OF CONTENTS

GENERAL INFORMATION.....	4
PRODUCT DESCRIPTION FOR EQUIPMENT UNDER TEST (EUT).....	4
OBJECTIVE	4
RELATED SUBMITTAL(S)/GRANT(S).....	4
TEST METHODOLOGY	4
TEST FACILITY	4
SYSTEM TEST CONFIGURATION.....	5
DESCRIPTION OF TEST CONFIGURATION	5
EUT EXERCISE SOFTWARE	5
EQUIPMENT MODIFICATIONS	5
SUPPORT EQUIPMENT LIST AND DETAILS	5
EXTERNAL CABLE.....	5
BLOCK DIAGRAM OF TEST SETUP	6
SUMMARY OF TEST RESULTS	8
FCC§1.1310 & §2.1091- MAXIMUM PERMISSIBLE EXPOSURE (MPE)	9
APPLICABLE STANDARD	9
FCC §15.203 - ANTENNA REQUIREMENT.....	10
APPLICABLE STANDARD	10
ANTENNA CONNECTOR CONSTRUCTION	10
FCC §15.207 (a) – AC LINE CONDUCTED EMISSIONS	11
APPLICABLE STANDARD	11
MEASUREMENT UNCERTAINTY.....	11
EUT SETUP.....	11
EMI TEST RECEIVER SETUP.....	12
TEST PROCEDURE	12
CORRECTED AMPLITUDE & MARGIN CALCULATION	12
TEST EQUIPMENT LIST AND DETAILS.....	13
TEST RESULTS SUMMARY	13
TEST DATA	13
FCC §15.209, §15.205 & §15.247(d) - SPURIOUS EMISSIONS.....	16
APPLICABLE STANDARD	16
MEASUREMENT UNCERTAINTY.....	16
EUT SETUP.....	16
EMI TEST RECEIVER & SPECTRUM ANALYZER SETUP	17
TEST PROCEDURE	17
TEST EQUIPMENT LIST AND DETAILS.....	18
CORRECTED AMPLITUDE & MARGIN CALCULATION	18
TEST DATA	18
FCC §15.247(a) (1) - CHANNEL SEPARATION TEST	26
APPLICABLE STANDARD	26
TEST EQUIPMENT LIST AND DETAILS.....	26
TEST PROCEDURE	26
TEST DATA	26
FCC §15.247(a) (1) – 20 dB BANDWIDTH TESTING.....	31

APPLICABLE STANDARD31
 TEST PROCEDURE31
 TEST EQUIPMENT LIST AND DETAILS.....31
 TEST DATA32

FCC §15.247(a) (1) - QUANTITY OF HOPPING CHANNEL TEST36
 APPLICABLE STANDARD36
 TEST PROCEDURE36
 TEST EQUIPMENT LIST AND DETAILS.....36
 TEST DATA36

FCC §15.247(a) (1) - TIME OF OCCUPANCY (DWELL TIME).....39
 APPLICABLE STANDARD39
 TEST PROCEDURE39
 TEST EQUIPMENT LIST AND DETAILS.....39
 TEST DATA39

FCC §15.247(b) (2) - PEAK OUTPUT POWER MEASUREMENT47
 APPLICABLE STANDARD47
 TEST PROCEDURE47
 TEST EQUIPMENT LIST AND DETAILS.....47
 TEST DATA47

FCC §15.247(d) - BAND EDGES TESTING52
 APPLICABLE STANDARD52
 TEST PROCEDURE52
 TEST EQUIPMENT LIST AND DETAILS.....52
 TEST DATA52

GENERAL INFORMATION

Product Description for Equipment under Test (EUT)

The *SZ DJI TECHNOLOGY CO., LTD*'s product, model number: *DL900ANA (FCC ID: SS3-ZT300A1604)* (the "EUT") in this report was a *DATALINK PRO 900*, which was measured approximately: 5.8cm (L) x 4.2cm (W) x 0.9cm (H), DC 9 V from CAN port, or DC 5V from USB port.

All measurement and test data in this report was gathered from production sample serial number: 160406002 (Assigned by BAACL, Dongguan). The EUT was received on 2016-04-06.

Objective

This report is prepared on behalf of *SZ DJI TECHNOLOGY CO., LTD* in accordance with Part 2, Subpart J, Part 15, Subparts A, B and C of the Federal Communications Commission's rules

The tests were performed in order to determine the EUT compliance with FCC Part 15, Subpart C, and section 15.203, 15.205, 15.207, 15.209 and 15.247 rules.

Related Submittal(s)/Grant(s)

Submitted with the Part of a system with FCC ID: SS3-ZT300G1604.

Test Methodology

All measurements contained in this report were conducted with ANSI C63.10-2013, American National Standard of Procedures for Compliance Testing of Unlicensed Wireless Devices.

All emissions measurement was performed and Bay Area Compliance Laboratories Corp. (Dongguan).

Test Facility

The Test site used by Bay Area Compliance Laboratories Corp. (Dongguan) to collect test data is located on the No.69 Pulongcun, Puxinhu Industrial Zone, Tangxia, Dongguan, Guangdong, China

Test site at Bay Area Compliance Laboratories Corp. (Dongguan) has been fully described in reports submitted to the Federal Communications Commission (FCC). The details of these reports have been found to be in compliance with the requirements of Section 2.948 of the FCC Rules on February 06, 2015.

The Federal Communications Commission has the reports on file and is listed under FCC Registration No.: 273710. The test site has been approved by the FCC for public use and is listed in the FCC Public Access Link (PAL) database.

SYSTEM TEST CONFIGURATION

Description of Test Configuration

The system was configured for testing in Engineering Mode, which was provided by the manufacturer.

The system employed 51 channels as below table:

Channel	Frequency (MHz)	Channel	Frequency (MHz)
1	903	27	914.7
2	903.45	28	915.15
3	903.9	29	915.6
~	~	~	~
~	~	50	925.05
25	913.8	51	925.5
26	914.25	/	/

3channels were tested: 903 MHz, 914.25MHz and 925.5 MHz

The device employed two antennas and only support SISO mode, the system can choose one of them to use depend on which one is the better performance.

EUT Exercise Software

Test Software: 'DJI-RF-Certification', was used in test. The maximum power was configured by system as default setting.

Equipment Modifications

No modification was made to the EUT.

Support Equipment List and Details

Manufacturer	Description	Model	Serial Number
Lenovo	Laptop	G510	HY1482

External Cable

Cable Description	Shielding Type	Ferrite Core	Length (m)	From Port	To
USB Cable	Yes	yes	0.57	Laptop	EUT
DC Cable	Yes	yes	1.0	adapter	Laptop

Block Diagram of Test Setup

Conduction:

USB Mode:

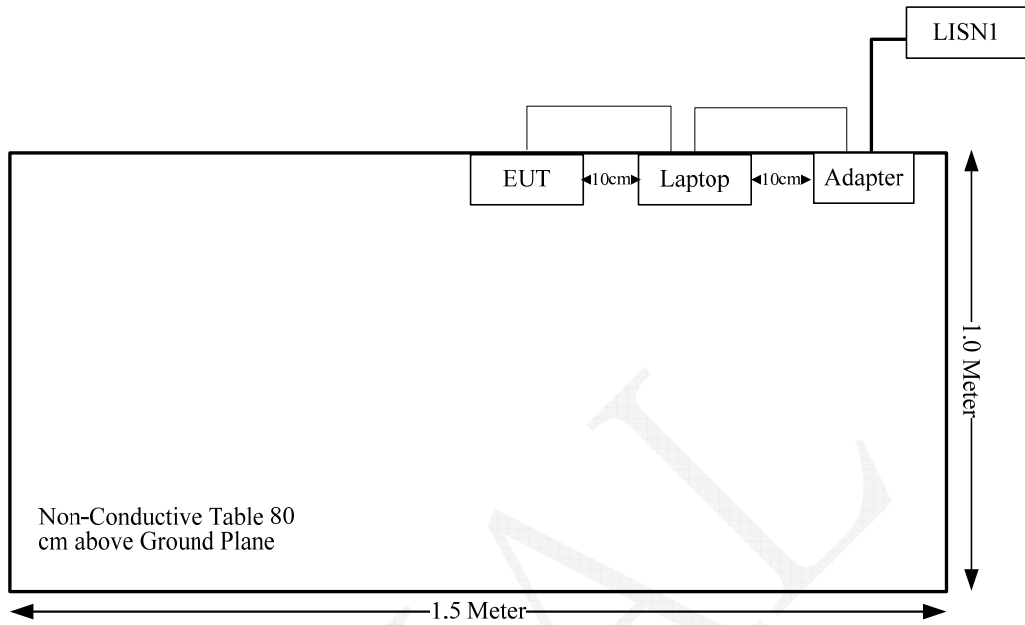

Radiation:

Battery Mode:

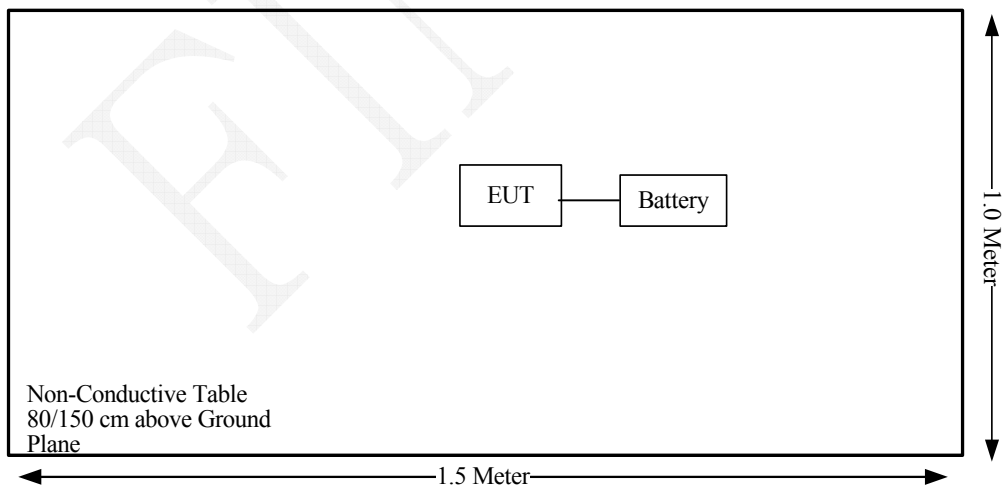

USB Mode:

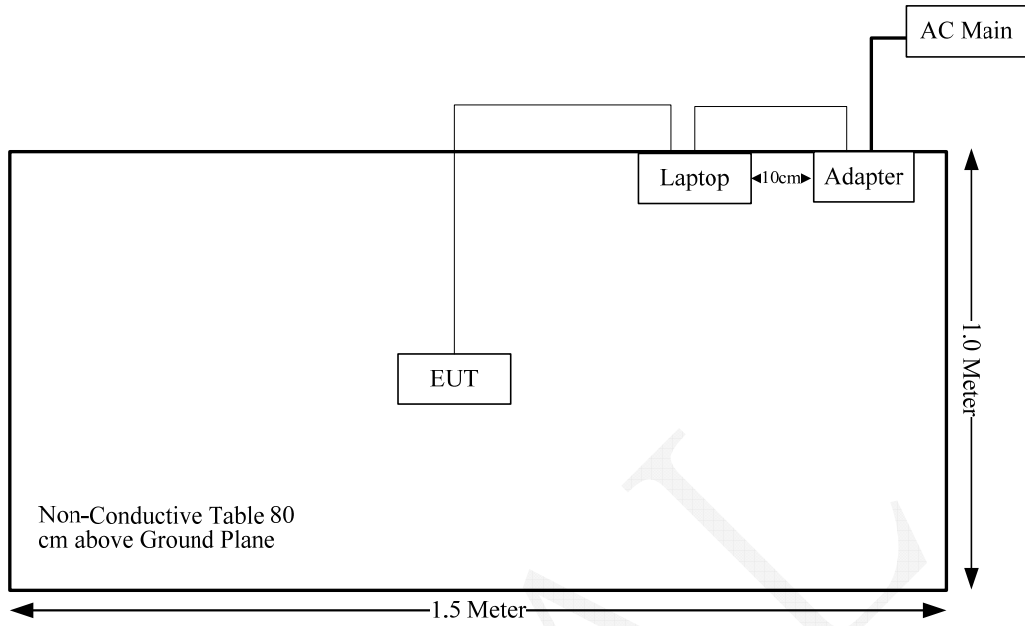

SUMMARY OF TEST RESULTS

FCC Rules	Description of Test	Result
FCC §15.247 (i) & §1.1310 & §2.1091	RF Exposure	Compliance
§15.203	Antenna Requirement	Compliance
§15.207 (a)	Conducted Emissions	Compliance
§15.205, §15.209, §15.247(d)	Spurious Emissions	Compliance
§15.247 (a)(1)	20 dB Bandwidth	Compliance
§15.247(a)(1)	Channel Separation Test	Compliance
§15.247(a)(1)(i)	Time of Occupancy (Dwell Time)	Compliance
§15.247(a)(1)(i)	Quantity of hopping channel Test	Compliance
§15.247(b)(2)	Peak Output Power Measurement	Compliance
§15.247(d)	Band Edges	Compliance

FCC§1.1310 & §2.1091- MAXIMUM PERMISSIBLE EXPOSURE (MPE)

Applicable Standard

According to subpart §1.1310, systems operating under the provisions of this section shall be operated in a manner that ensures that the public is not exposed to radio frequency energy level in excess of the Commission’s guidelines.

Limits for Maximum Permissible Exposure (MPE) (§1.1310, §2.1091)

(B) Limits for General Population/Uncontrolled Exposure				
Frequency Range (MHz)	Electric Field Strength (V/m)	Magnetic Field Strength (A/m)	Power Density (mW/cm ²)	Averaging Time (minutes)
0.3–1.34	614	1.63	*(100)	30
1.34–30	824/f	2.19/f	*(180/f ²)	30
30–300	27.5	0.073	0.2	30
300–1500	/	/	f/1500	30
1500–100,000	/	/	1.0	30

f = frequency in MHz; * = Plane-wave equivalent power density;

According to §1.1310 and §2.1091 RF exposure is calculated.

Calculated Formulary:

Predication of MPE limit at a given distance

$S = PG/4\pi R^2$ = power density (in appropriate units, e.g. mW/cm²);

P = power input to the antenna (in appropriate units, e.g., mW);

G = power gain of the antenna in the direction of interest relative to an isotropic radiator, the power gain factor, is normally numeric gain;

R = distance to the center of radiation of the antenna (appropriate units, e.g., cm);

Calculated Data:

Frequency (MHz)	Antenna Gain		Max. Target Power		Evaluation Distance (cm)	Power Density (mW/cm ²)	MPE Limit (mW/cm ²)
	(dBi)	(numeric)	(dBm)	(mW)			
903-925.5	2.90	1.95	27	501.19	20.00	0.19	0.6

Note: The tune-up conducted power is 25+/-2dBm, which declared by the manufacturer.

Result: The device meet FCC MPE at 20 cm distance

FCC §15.203 - ANTENNA REQUIREMENT

Applicable Standard

According to FCC § 15.203, an intentional radiator shall be designed to ensure that no antenna other than that furnished by the responsible party shall be used with the device. The use of a permanently attached antenna or of an antenna that uses a unique coupling to the intentional radiator shall be considered sufficient to comply with the provisions of this Section. The manufacturer may design the unit so that a broken antenna can be replaced by the user, but the use of a standard antenna jack or electrical connector is prohibited.

Antenna Connector Construction

The EUT have two detachable antennas uses a unique coupling to the EUT, and the antenna gain is 2.9 dBi, fulfill the requirement of this section. Please refer to the EUT photos.

Result: Compliance.

FCC §15.207 (a) – AC LINE CONDUCTED EMISSIONS

Applicable Standard

FCC§15.207

Measurement Uncertainty

Compliance or non-compliance with a disturbance limit shall be determined in the following manner:

If U_{lab} is less than or equal to U_{cispr} of Table 1, then:

- compliance is deemed to occur if no measured disturbance level exceeds the disturbance limit;
- non-compliance is deemed to occur if any measured disturbance level exceeds the disturbance limit.

If U_{lab} is greater than U_{cispr} of Table 1, then:

- compliance is deemed to occur if no measured disturbance level, increased by $(U_{lab} - U_{cispr})$, exceeds the disturbance limit;
- non-compliance is deemed to occur if any measured disturbance level, increased by $(U_{lab} - U_{cispr})$, exceeds the disturbance limit.

Based on CISPR 16-4-2: 2011, measurement uncertainty of conducted disturbance at mains port using AMN at Bay Area Compliance Laboratories Corp. (Dongguan) is 3.12 dB (150 kHz to 30 MHz).

Table 1 – Values of U_{cispr}

Measurement	U_{cispr}
Conducted disturbance at mains port using AMN (150 kHz to 30 MHz)	3.4 dB

EUT Setup

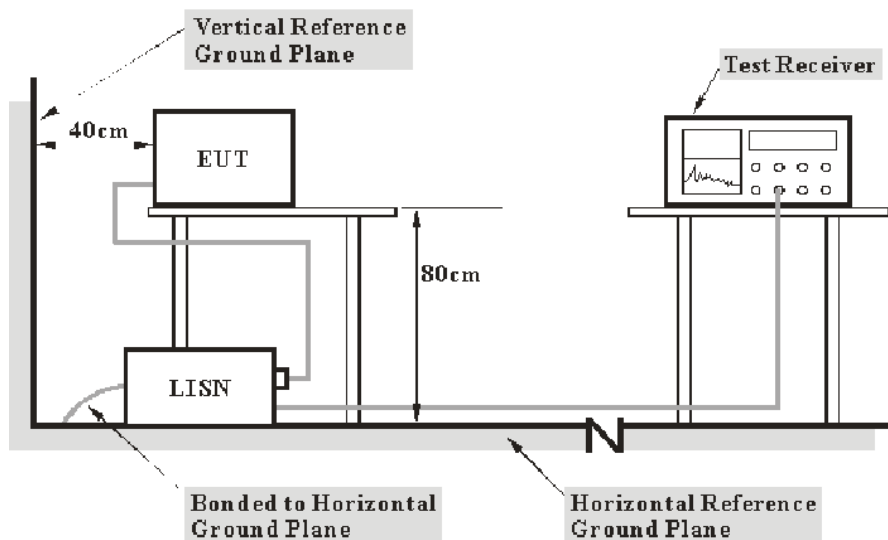

- Note: 1. Support units were connected to second LISN.
 2. Both of LISNs (AMN) 80 cm from EUT and at the least 80 cm from other units and other metal planes support units.

The setup of EUT is according with per ANSI C63.10-2013 measurement procedure. The specification used was with the FCC Part 15.207 limits.

The spacing between the peripherals was 10 cm.

The adapter was connected to a 120 VAC/60 Hz power source.

EMI Test Receiver Setup

The EMI test receiver was set to investigate the spectrum from 150 kHz to 30 MHz.

During the conducted emission test, the EMI test receiver was set with the following configurations:

Frequency Range	IF B/W
150 kHz – 30 MHz	9 kHz

Test Procedure

During the conducted emission test, the adapter was connected to the outlet of the first LISN.

Maximizing procedure was performed on the six (6) highest emissions of the EUT.

All data was recorded in the Quasi-peak and average detection mode.

Corrected Amplitude & Margin Calculation

The basic equation is as follows:

$$V_C = V_R + A_C + VDF$$

Herein,

V_C : corrected voltage amplitude

V_R : reading voltage amplitude

A_C : attenuation caused by cable loss

VDF : voltage division factor of AMN or ISN

The “**Margin**” column of the following data tables indicates the degree of compliance within the applicable limit. For example, a margin of 7dB means the emission is 7dB below the maximum limit. The equation for margin calculation is as follows:

$$\text{Margin} = \text{Limit} - \text{Corrected Amplitude}$$

Test Equipment List and Details

Manufacturer	Description	Model	Serial Number	Calibration Date	Calibration Due Date
R&S	EMI Test Receiver	ESCS 30	830245/006	2015-10-20	2016-10-20
R&S	L.I.S.N	ESH2-Z5	892107/021	2015-06-09	2016-06-09
R&S	Two-line V-network	ENV 216	3560.6550.12	2015-11-26	2016-11-25
N/A	Coaxial Cable	1.8m	N/A	2015-05-06	2016-05-06
R&S	Test Software	EMC32	Version8.53.0	N/A	N/A

* **Statement of Traceability:** Bay Area Compliance Laboratories Corp. (Dongguan) attests that all calibrations have been performed, traceable to National Primary Standards and International System of Units (SI).

Test Results Summary

According to the recorded data in following table, the EUT complied with the FCC Part 15.207, with the worst margin reading of:

8.4 dB at 0.307284 MHz in the **Neutral** conducted mode

Test Data

Environmental Conditions

Temperature:	27.9°C
Relative Humidity:	61 %
ATM Pressure:	100.3 kPa

The testing was performed by Emily Wang on 2016-05-05

Test Mode: Transmitting

AC120 V, 60 Hz, Line:

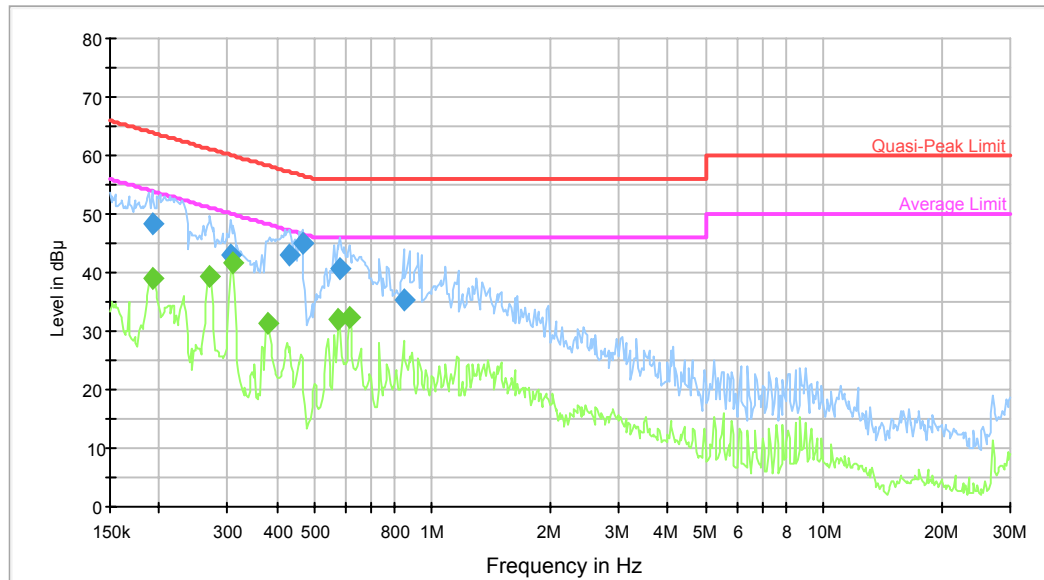

Frequency (MHz)	QuasiPeak (dBµV)	Bandwidth (kHz)	Line	Corr. (dB)	Margin (dB)	Limit (dBµV)	Comment
0.192030	48.4	9.000	L1	10.2	15.5	63.9	Compliance
0.304845	43.1	9.000	L1	10.3	17.0	60.1	Compliance
0.429420	43.1	9.000	L1	10.2	14.2	57.3	Compliance
0.465037	44.9	9.000	L1	10.1	11.7	56.6	Compliance
0.581275	40.7	9.000	L1	10.2	15.3	56.0	Compliance
0.845331	35.3	9.000	L1	10.4	20.7	56.0	Compliance

Frequency (MHz)	Average (dBµV)	Bandwidth (kHz)	Line	Corr. (dB)	Margin (dB)	Limit (dBµV)	Comment
0.193566	38.9	9.000	L1	10.2	14.9	53.8	Compliance
0.270502	39.4	9.000	L1	10.2	11.7	51.1	Compliance
0.307284	41.5	9.000	L1	10.3	8.5	50.0	Compliance
0.381043	31.3	9.000	L1	10.2	17.0	48.3	Compliance
0.576662	32.0	9.000	L1	10.2	14.0	46.0	Compliance
0.614619	32.3	9.000	L1	10.3	13.7	46.0	Compliance

AC120 V, 60 Hz, Neutral:

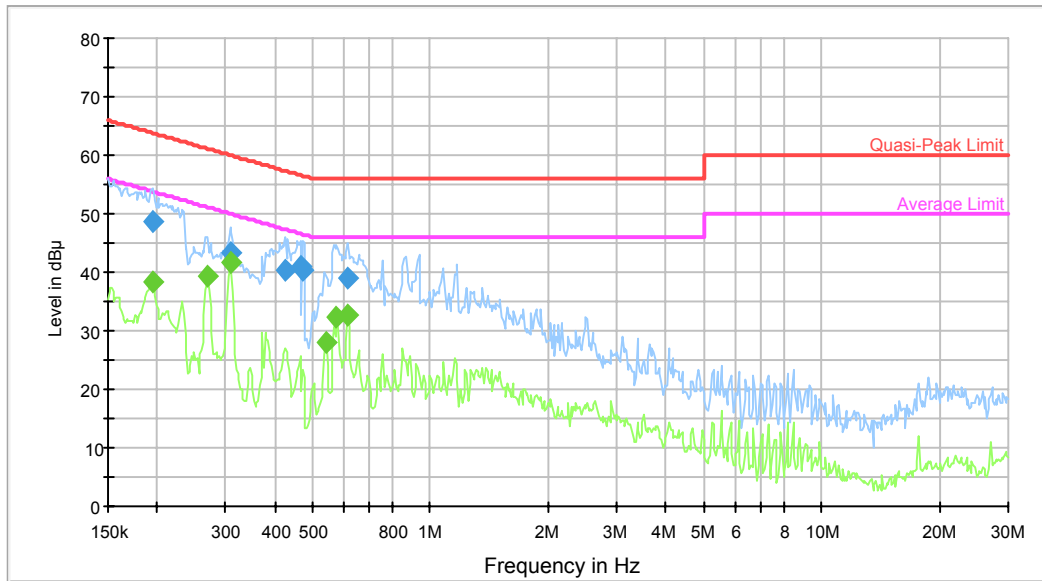

Frequency (MHz)	QuasiPeak (dBµV)	Bandwidth (kHz)	Line	Corr. (dB)	Margin (dB)	Limit (dBµV)	Comment
0.195114	48.7	9.000	N	10.2	15.1	63.8	Compliance
0.307284	43.2	9.000	N	10.3	16.8	60.0	Compliance
0.426011	40.2	9.000	N	10.2	17.1	57.3	Compliance
0.465037	41.0	9.000	N	10.1	15.6	56.6	Compliance
0.472507	40.4	9.000	N	10.1	16.1	56.5	Compliance
0.614619	39.1	9.000	N	10.3	16.9	56.0	Compliance

Frequency (MHz)	Average (dBµV)	Bandwidth (kHz)	Line	Corr. (dB)	Margin (dB)	Limit (dBµV)	Comment
0.195114	38.2	9.000	N	10.2	15.6	53.8	Compliance
0.270502	39.2	9.000	N	10.2	11.9	51.1	Compliance
0.307284	41.6	9.000	N	10.3	8.4	50.0	Compliance
0.541050	28.1	9.000	N	10.1	17.9	46.0	Compliance
0.576662	32.5	9.000	N	10.2	13.5	46.0	Compliance
0.614619	32.6	9.000	N	10.3	13.4	46.0	Compliance

FCC §15.209, §15.205 & §15.247(d) - SPURIOUS EMISSIONS

Applicable Standard

FCC §15.247 (d); §15.209; §15.205;

Measurement Uncertainty

Compliance or non-compliance with a disturbance limit shall be determined in the following manner:

If U_{lab} is less than or equal to U_{cispr} of Table 1, then:

- compliance is deemed to occur if no measured disturbance level exceeds the disturbance limit;
- non-compliance is deemed to occur if any measured disturbance level exceeds the disturbance limit.

If U_{lab} is greater than U_{cispr} of Table 1, then:

- compliance is deemed to occur if no measured disturbance level, increased by $(U_{lab} - U_{cispr})$, exceeds the disturbance limit;
- non-compliance is deemed to occur if any measured disturbance level, increased by $(U_{lab} - U_{cispr})$, exceeds the disturbance limit.

Based on CISPR 16-4-2: 2011, measurement uncertainty of radiated emission at a distance of 3m at Bay Area Compliance Laboratories Corp. (Dongguan) is: 30M~200MHz: 4.58 dB for Horizontal, 4.59 dB for Vertical; 200M~1GHz: 4.83 dB for Horizontal, 5.85 dB for Vertical; 1G~6GHz: 4.45 dB, 6G~18GHz: 5.23 dB

Table 1 – Values of U_{cispr}

Measurement	U_{cispr}
Radiated disturbance (electric field strength at an OATS or in a SAC) (30 MHz to 1000 MHz)	6.3 dB
Radiated disturbance (electric field strength in a FAR) (1 GHz to 6 GHz)	5.2 dB
Radiated disturbance (electric field strength in a FAR) (6 GHz to 18 GHz)	5.5 dB

EUT Setup

Below 1GHz:

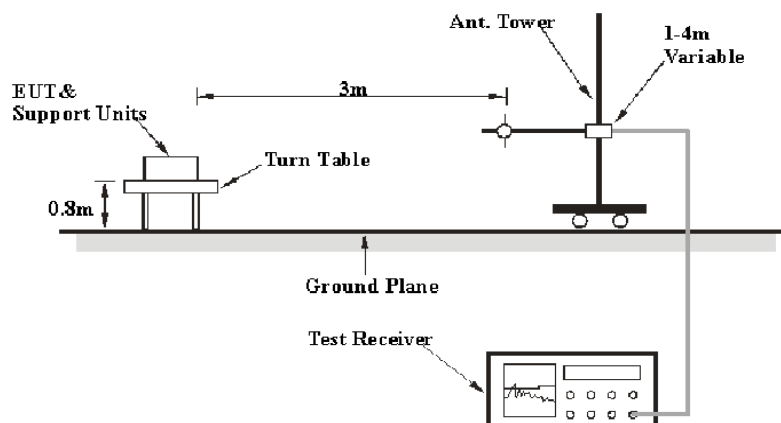

Above 1GHz:

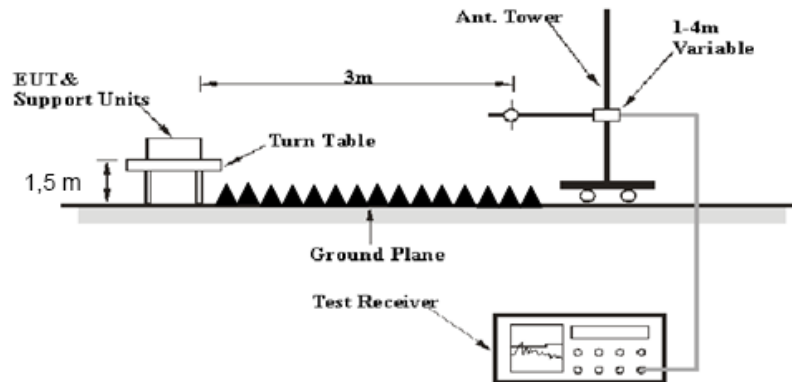

The radiated emission tests were performed in the 3 meters test site, using the setup accordance with the ANSI C63.10-2013. The specification used was the FCC 15.209, and FCC 15.247 limits.

The external I/O cables were draped along the test table and formed a bundle 30 to 40 cm long in the middle.

The spacing between the peripherals was 10 cm.

EMI Test Receiver & Spectrum Analyzer Setup

The system was investigated from 30 MHz to 10 GHz.

During the radiated emission test, the EMI test receiver & Spectrum Analyzer Setup were set with the following configurations:

Frequency Range	RBW	Video B/W	IF B/W	Detector
30 MHz – 1000 MHz	120 kHz	300 kHz	120 kHz	QP
Above 1 GHz	1MHz	3 MHz	/	PK
	1MHz	10 Hz	/	AV

Test Procedure

Maximizing procedure was performed on the highest emissions to ensure that the EUT complied with all installation combinations.

Data was recorded in Quasi-peak detection mode for frequency range of 30 MHz - 1 GHz, peak and average detection modes for frequencies above 1 GHz.

Test Equipment List and Details

Manufacturer	Description	Model	Serial Number	Calibration Date	Calibration Due Date
R&S	EMI Test Receiver	ESCI	100224	2015-08-03	2016-08-02
Sunol Sciences	Antenna	JB3	A060611-3	2014-11-06	2017-11-05
HP	Amplifier	8447E	2434A02181	2015-09-01	2016-09-01
Agilent	Spectrum Analyzer	E4440A	SG43360054	2015-11-23	2016-11-22
ETS-Lindgren	Horn Antenna	3115	9808-5557	2015-09-06	2018-09-06
Mini-Circuit	Amplifier	ZVA-213-S+	054201245	2016-02-19	2017-02-19
R&S	Spectrum Analyzer	FSP 38	100478	2015-11-23	2016-11-22
Ducommun Technologies	Horn Antenna	ARH-4223-02	1007726-01 1304	2014-06-16	2017-06-15
Quinstar	Amplifier	QLW-18405536-JO	15964001001	2015-09-06	2016-09-06
N/A	Coaxial Cable	14m	N/A	2016-05-06	2017-05-06
N/A	Coaxial Cable	8m	N/A	2016-05-06	2017-05-06
N/A	Coaxial Cable	0.1m	N/A	2016-05-06	2017-05-06
E-Microwave	DC Blocking	EMDCB-00036	0E01201047	2016-05-06	2017-05-06

* **Statement of Traceability:** Bay Area Compliance Laboratories Corp. (Dongguan) attests that all calibrations have been performed, traceable to National Primary Standards and International System of Units (SI).

Corrected Amplitude & Margin Calculation

The Corrected Amplitude is calculated by adding the Antenna Factor and Cable Loss, and subtracting the Amplifier Gain from the Meter Reading. The basic equation is as follows:

$$\text{Corrected Amplitude} = \text{Meter Reading} + \text{Antenna Factor} + \text{Cable Loss} - \text{Amplifier Gain}$$

The “**Margin**” column of the following data tables indicates the degree of compliance with the applicable limit. For example, a margin of 7dB means the emission is 7dB below the limit. The equation for margin calculation is as follows:

$$\text{Margin} = \text{Limit} - \text{Corrected Amplitude}$$

Test Data

Environmental Conditions

Temperature:	25.8°C
Relative Humidity:	54 %
ATM Pressure:	100.4 kPa

* The testing was performed by Emily Wang on 2016-05-06

Test Mode: Transmitting (pretest battery mode and USB mode, the USB mode was the worst and record below:)

Chain 0:

Frequency (MHz)	Receiver		Rx Antenna		Cable loss (dB)	Amplifier Gain (dB)	Corrected Amplitude (dBµV/m)	FCC 15.247	
	Reading (dBµV)	Detector (PK/QP/AV)	Polar (H/V)	Factor (dB)				Limit (dBµV/m)	Margin (dB)
Low Channel									
903	90.9	QP	V	22.95	3.70	0.00	117.55	/	/
903	89.5	QP	H	22.95	3.70	0.00	116.15	/	/
902	34.4	QP	V	22.94	3.71	0.00	61.05	97.55	36.50
1806	56.14	PK	H	24.21	2.66	27.53	55.48	74.00	18.52
1806	45.73	AV	H	24.21	2.66	27.53	45.07	54.00	8.93
1806	52.81	PK	V	24.21	2.66	27.53	52.15	74.00	21.85
1806	42.18	AV	V	24.21	2.66	27.53	41.52	54.00	12.48
2709	56	PK	H	26.44	4.48	27.50	59.42	74.00	14.58
2709	46.26	AV	H	26.44	4.48	27.50	49.68	54.00	4.32
2709	54.36	PK	V	26.44	4.48	27.50	57.78	74.00	16.22
2709	45.07	AV	V	26.44	4.48	27.50	48.49	54.00	5.51
5418	44.36	PK	H	31.94	5.50	26.97	54.83	74.00	19.17
5418	33.74	AV	H	31.94	5.50	26.97	44.21	54.00	9.79
5418	41.16	PK	V	31.94	5.50	26.97	51.63	74.00	22.37
5418	30.54	AV	V	31.94	5.50	26.97	41.01	54.00	12.99
6321	48.24	PK	H	32.26	6.04	26.56	59.98	74.00	14.02
6321	37.77	AV	H	32.26	6.04	26.56	49.51	54.00	4.49
6321	43.98	PK	V	32.26	6.04	26.56	55.72	74.00	18.28
6321	33.64	AV	V	32.26	6.04	26.56	45.38	54.00	8.62
362.4	36.8	QP	H	15.64	2.31	21.68	33.07	46.00	12.93
Middle Channel									
914.5	91.6	QP	V	22.91	3.68	0.00	118.19	/	/
914.5	90.6	QP	H	22.91	3.68	0.00	117.19	/	/
1828.5	55.19	PK	H	24.26	2.87	27.52	54.80	74.00	19.20
1828.5	46.12	AV	H	24.26	2.87	27.52	45.73	54.00	8.27
1828.5	50.57	PK	V	24.26	2.87	27.52	50.18	74.00	23.82
1828.5	41.59	AV	V	24.26	2.87	27.52	41.20	54.00	12.80
2742.75	54.36	PK	H	26.53	4.37	27.52	57.74	74.00	16.26
2742.75	44.09	AV	H	26.53	4.37	27.52	47.47	54.00	6.53
2742.75	53.59	PK	V	26.53	4.37	27.52	56.97	74.00	17.03
2742.75	42.73	AV	V	26.53	4.37	27.52	46.11	54.00	7.89
3657	49.25	PK	H	29.15	4.55	27.30	55.65	74.00	18.35
3657	38.89	AV	H	29.15	4.55	27.30	45.29	54.00	8.71
3657	45.29	PK	V	29.15	4.55	27.30	51.69	74.00	22.31
3657	35.3	AV	V	29.15	4.55	27.30	41.70	54.00	12.30
5485.5	45.3	PK	H	32.07	5.49	26.90	55.96	74.00	18.04
5485.5	35.47	AV	H	32.07	5.49	26.90	46.13	54.00	7.87
5485.5	43.48	PK	V	32.07	5.49	26.90	54.14	74.00	19.86
5485.5	33.46	AV	V	32.07	5.49	26.90	44.12	54.00	9.88
6399.75	45.66	PK	H	32.28	6.09	26.43	57.60	74.00	16.40
6399.75	35.09	AV	H	32.28	6.09	26.43	47.03	54.00	6.97
6399.75	46.03	PK	V	32.28	6.09	26.43	57.97	74.00	16.03
6399.75	34.92	AV	V	32.28	6.09	26.43	46.86	54.00	7.14
362.4	36.6	QP	H	15.64	2.31	21.68	32.87	46.00	13.13

Frequency (MHz)	Receiver		Rx Antenna		Cable loss (dB)	Amplifier Gain (dB)	Corrected Amplitude (dBµV/m)	FCC 15.247	
	Reading (dBµV)	Detector (PK/QP/AV)	Polar (H/V)	Factor (dB)				Limit (dBµV/m)	Margin (dB)
High Channel									
925	91.3	QP	V	22.93	3.69	0.00	117.92	/	/
925	91.1	QP	H	22.93	3.69	0.00	117.72	/	/
928	26.9	QP	V	23.00	3.70	0.00	53.60	97.92	44.32
1851	54.98	PK	H	24.30	3.07	27.52	54.83	74.00	19.17
1851	46.11	AV	H	24.30	3.07	27.52	45.96	54.00	8.04
1851	48.41	PK	V	24.30	3.07	27.52	48.26	74.00	25.74
1851	38.91	AV	V	24.30	3.07	27.52	38.76	54.00	15.24
2776.5	53.37	PK	H	26.62	4.42	27.54	56.87	74.00	17.13
2776.5	43.56	AV	H	26.62	4.42	27.54	47.06	54.00	6.94
2776.5	52.56	PK	V	26.62	4.42	27.54	56.06	74.00	17.94
2776.5	42.52	AV	V	26.62	4.42	27.54	46.02	54.00	7.98
3702	47.6	PK	H	29.24	4.64	27.33	54.15	74.00	19.85
3702	37.81	AV	H	29.24	4.64	27.33	44.36	54.00	9.64
3702	46.58	PK	V	29.24	4.64	27.33	53.13	74.00	20.87
3702	36.47	AV	V	29.24	4.64	27.33	43.02	54.00	10.98
4627.5	45.1	PK	H	30.13	5.19	27.34	53.08	74.00	20.92
4627.5	33.86	AV	H	30.13	5.19	27.34	41.84	54.00	12.16
4627.5	45.78	PK	V	30.13	5.19	27.34	53.76	74.00	20.24
4627.5	35.29	AV	V	30.13	5.19	27.34	43.27	54.00	10.73
5553	45.28	PK	H	32.11	5.37	26.82	55.94	74.00	18.06
5553	34.7	AV	H	32.11	5.37	26.82	45.36	54.00	8.64
5553	43.98	PK	V	32.11	5.37	26.82	54.64	74.00	19.36
5553	34.07	AV	V	32.11	5.37	26.82	44.73	54.00	9.27
362.4	36.7	QP	H	15.64	2.31	21.68	32.97	46.00	13.03

Chain 1:

Frequency (MHz)	Receiver		Rx Antenna		Cable loss (dB)	Amplifier Gain (dB)	Corrected Amplitude (dBµV/m)	FCC 15.247	
	Reading (dBµV)	Detector (PK/QP/AV)	Polar (H/V)	Factor (dB)				Limit (dBµV/m)	Margin (dB)
Low Channel									
903	90.3	QP	V	22.95	3.70	0.00	116.95	/	/
903	89.6	QP	H	22.95	3.70	0.00	116.25	/	/
902	33.2	QP	V	22.94	3.71	0.00	59.85	96.95	37.10
1806	56.55	PK	H	24.21	2.66	27.53	55.89	74.00	18.11
1806	47.53	AV	H	24.21	2.66	27.53	46.87	54.00	7.13
1806	52.2	PK	V	24.21	2.66	27.53	51.54	74.00	22.46
1806	42.27	AV	V	24.21	2.66	27.53	41.61	54.00	12.39
2709	55.66	PK	H	26.44	4.48	27.50	59.08	74.00	14.92
2709	45.02	AV	H	26.44	4.48	27.50	48.44	54.00	5.56
2709	54.35	PK	V	26.44	4.48	27.50	57.77	74.00	16.23
2709	44.91	AV	V	26.44	4.48	27.50	48.33	54.00	5.67
3612	47.62	PK	H	29.05	4.61	27.28	54.00	74.00	20.00
3612	37.58	AV	H	29.05	4.61	27.28	43.96	54.00	10.04
3612	46.85	PK	V	29.05	4.61	27.28	53.23	74.00	20.77
3612	36.21	AV	V	29.05	4.61	27.28	42.59	54.00	11.41
4515	45.7	PK	H	29.84	5.06	27.14	53.46	74.00	20.54
4515	34.92	AV	H	29.84	5.06	27.14	42.68	54.00	11.32
4515	43	PK	V	29.84	5.06	27.14	50.76	74.00	23.24
4515	32.54	AV	V	29.84	5.06	27.14	40.30	54.00	13.70
6321	44.18	PK	H	32.26	6.04	26.56	55.92	74.00	18.08
6321	33.92	AV	H	32.26	6.04	26.56	45.66	54.00	8.34
6321	42.97	PK	V	32.26	6.04	26.56	54.71	74.00	19.29
6321	32.82	AV	V	32.26	6.04	26.56	44.56	54.00	9.44
362.4	36.4	QP	H	15.64	2.31	21.68	32.67	46.00	13.33
Middle Channel									
914.5	90.6	QP	V	22.91	3.68	0.00	117.19	/	/
914.5	89.3	QP	H	22.91	3.68	0.00	115.89	/	/
1828.5	54.07	PK	H	24.26	2.87	27.52	53.68	74.00	20.32
1828.5	44.79	AV	H	24.26	2.87	27.52	44.40	54.00	9.60
1828.5	51.64	PK	V	24.26	2.87	27.52	51.25	74.00	22.75
1828.5	41.93	AV	V	24.26	2.87	27.52	41.54	54.00	12.46
2742.75	55.28	PK	H	26.53	4.37	27.52	58.66	74.00	15.34
2742.75	44.9	AV	H	26.53	4.37	27.52	48.28	54.00	5.72
2742.75	52.66	PK	V	26.53	4.37	27.52	56.04	74.00	17.96
2742.75	42.68	AV	V	26.53	4.37	27.52	46.06	54.00	7.94
3657	47.65	PK	H	29.15	4.55	27.30	54.05	74.00	19.95
3657	36.83	AV	H	29.15	4.55	27.30	43.23	54.00	10.77
3657	47.13	PK	V	29.15	4.55	27.30	53.53	74.00	20.47
3657	36.57	AV	V	29.15	4.55	27.30	42.97	54.00	11.03
4571.25	45.15	PK	H	29.99	5.13	27.27	53.00	74.00	21.00
4571.25	34.02	AV	H	29.99	5.13	27.27	41.87	54.00	12.13
4571.25	45.66	PK	V	29.99	5.13	27.27	53.51	74.00	20.49
4571.25	34.95	AV	V	29.99	5.13	27.27	42.80	54.00	11.20
362.4	36.6	QP	H	15.64	2.31	21.68	32.87	46.00	13.13

Frequency (MHz)	Receiver		Rx Antenna		Cable loss (dB)	Amplifier Gain (dB)	Corrected Amplitude (dBµV/m)	FCC 15.247	
	Reading (dBµV)	Detector (PK/QP/AV)	Polar (H/V)	Factor (dB)				Limit (dBµV/m)	Margin (dB)
High Channel									
925	90.5	QP	V	22.93	3.69	0.00	117.12	/	/
925	89.7	QP	H	22.93	3.69	0.00	116.32	/	/
928	25.8	QP	V	23.00	3.70	0.00	52.50	97.12	44.62
1851	54.56	PK	H	24.30	3.07	27.52	54.41	74.00	19.59
1851	45.07	AV	H	24.30	3.07	27.52	44.92	54.00	9.08
1851	49.4	PK	V	24.30	3.07	27.52	49.25	74.00	24.75
1851	40.21	AV	V	24.30	3.07	27.52	40.06	54.00	13.94
2776.5	54.4	PK	H	26.62	4.42	27.54	57.90	74.00	16.10
2776.5	44.17	AV	H	26.62	4.42	27.54	47.67	54.00	6.33
2776.5	53.91	PK	V	26.62	4.42	27.54	57.41	74.00	16.59
2776.5	44.32	AV	V	26.62	4.42	27.54	47.82	54.00	6.18
3702	46.15	PK	H	29.24	4.64	27.33	52.70	74.00	21.30
3702	36.48	AV	H	29.24	4.64	27.33	43.03	54.00	10.97
3702	45.61	PK	V	29.24	4.64	27.33	52.16	74.00	21.84
3702	35.46	AV	V	29.24	4.64	27.33	42.01	54.00	11.99
4627.5	44.41	PK	H	30.13	5.19	27.34	52.39	74.00	21.61
4627.5	33.71	AV	H	30.13	5.19	27.34	41.69	54.00	12.31
4627.5	39.92	PK	V	30.13	5.19	27.34	47.90	74.00	26.10
4627.5	30.17	AV	V	30.13	5.19	27.34	38.15	54.00	15.85
362.4	36.7	QP	H	15.64	2.31	21.68	32.97	46.00	13.03

Conducted Spurious Emissions at Antenna Port

Chain 0:

Low Channel

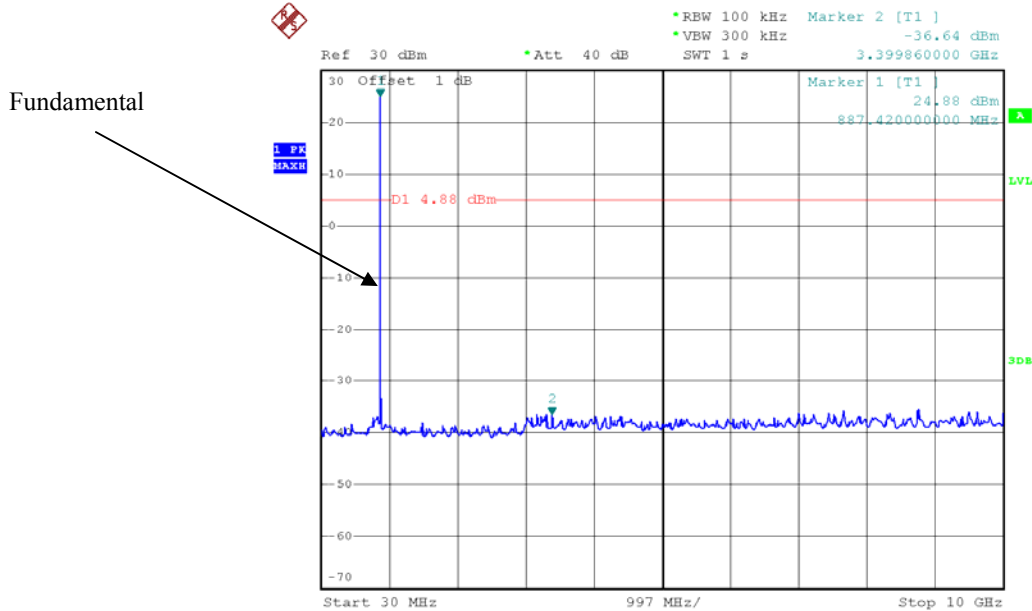

Middle Channel

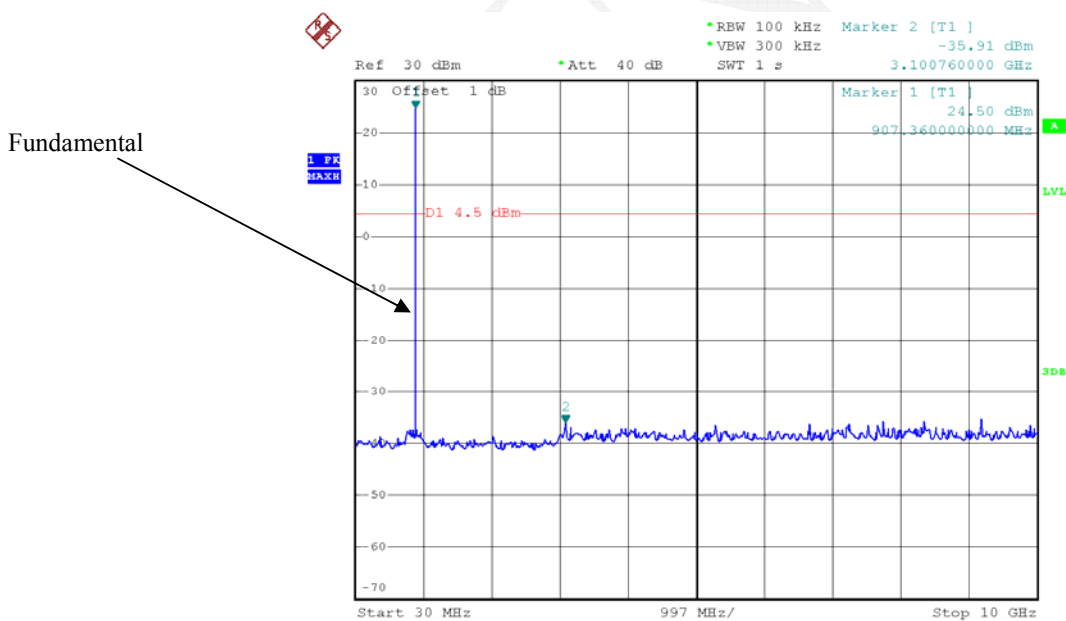

High Channel

Fundamental

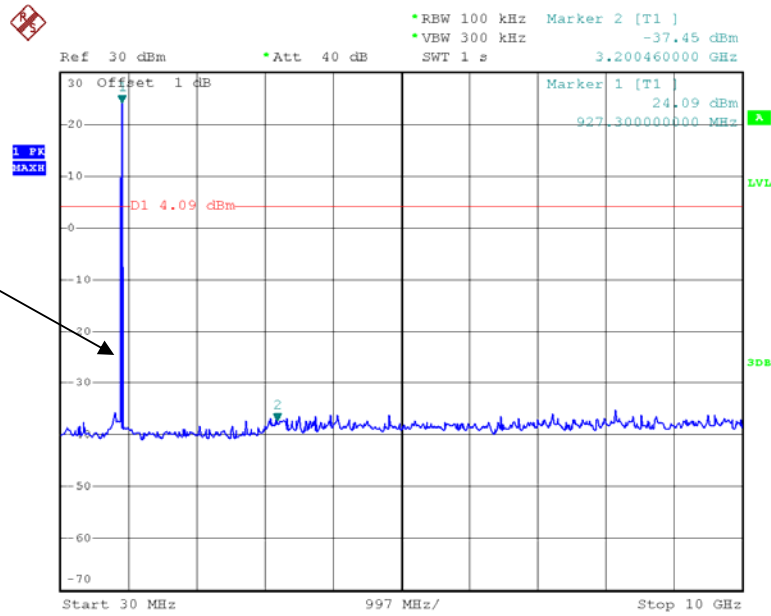

Date: 6.MAY.2016 13:59:16

Chain 1:

Low Channel

Fundamental

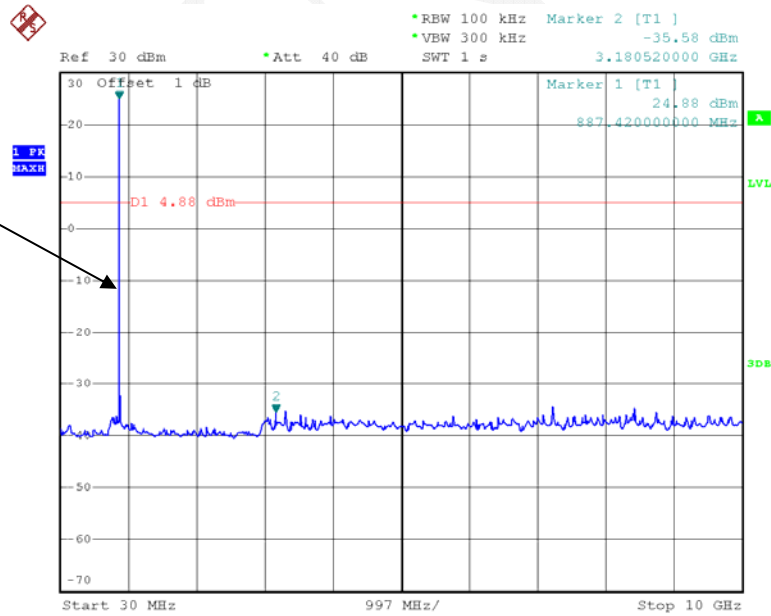

Date: 6.MAY.2016 13:37:22

Middle Channel

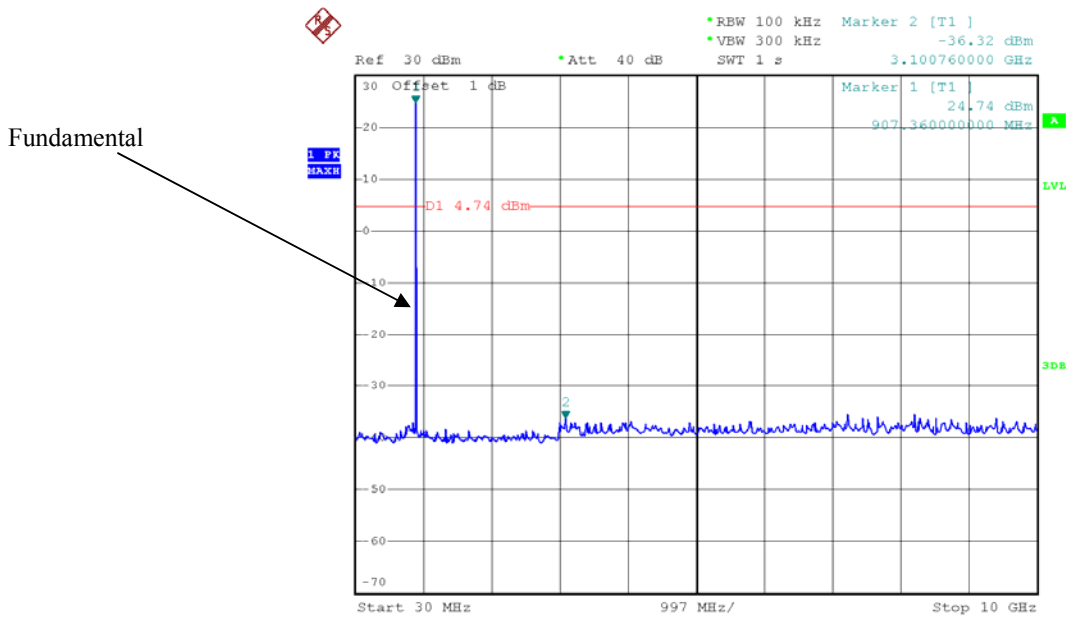

Date: 6.MAY.2016 13:38:24

High Channel

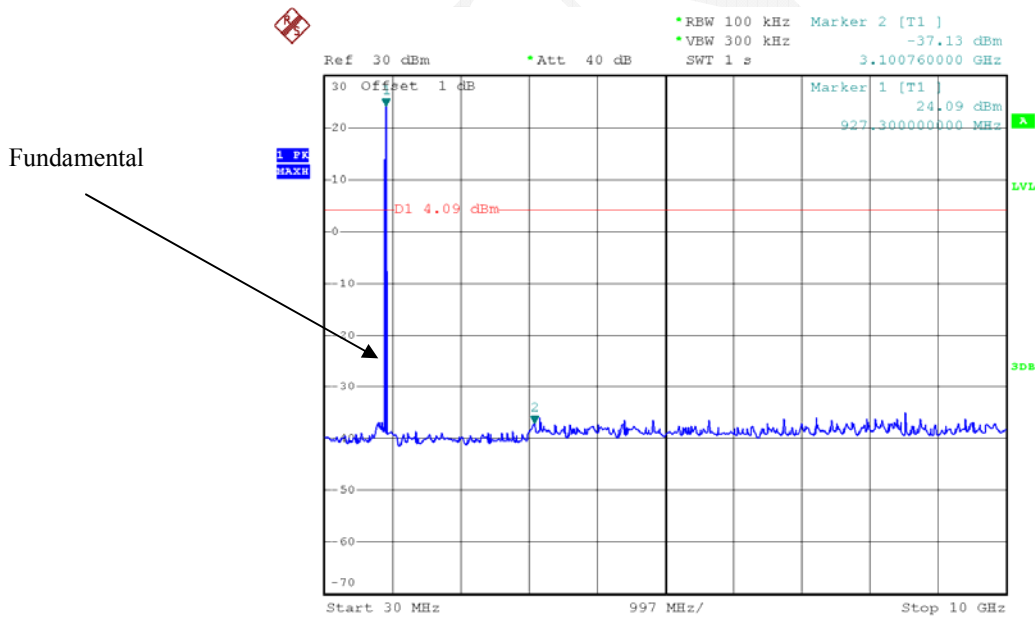

Date: 6.MAY.2016 13:39:11

FCC §15.247(a) (1) - CHANNEL SEPARATION TEST

Applicable Standard

Frequency hopping systems shall have hopping channel carrier frequencies separated by a minimum of 25 kHz or the 20dB bandwidth of the hopping channel, whichever is greater. Alternatively, frequency hopping systems operating in the 2400-2483.50 MHz band may have hopping channel carrier frequencies that are separated by 25 kHz or two-thirds of the 20dB bandwidth of the hopping channel, whichever is greater provided the systems operate with an output power no greater than 125 mW.

Test Equipment List and Details

Manufacturer	Description	Model	Serial Number	Calibration Date	Calibration Due Date
R&S	Spectrum Analyzer	FSP 38	100478	2015-11-23	2016-11-22
N/A	Coaxial Cable	0.1m	N/A	2016-05-06	2017-05-06
E-Microwave	DC Blocking	EMDCB-00036	0E01201047	2016-05-06	2017-05-06

* **Statement of Traceability:** Bay Area Compliance Laboratories Corp. (Dongguan) attests that all calibrations have been performed, traceable to National Primary Standards and International System of Units (SI).

Test Procedure

1. Set the EUT in transmitting mode, spectrum Bandwidth was set at 10 kHz, maxhold the channel.
2. Set the adjacent channel of the EUT maxhold another trace.
3. Measure the channel separation.

Test Data

Environmental Conditions

Temperature:	25.6 °C
Relative Humidity:	54 %
ATM Pressure:	100.4 kPa

* The testing was performed by Emily Wang on 2016-05-06.

Test Result: Compliance.

Please refer to following tables and plots

Test Mode: Transmitting

Antenna Chain	Channel	Frequency	Channel Separation (Chain 0)	Limit
		MHz	MHz	MHz
0	Low	903	0.450	0.430
	Middle	914.25	0.452	0.428
	High	925.5	0.450	0.428
1	Low	903	0.452	0.428
	Middle	914.25	0.450	0.428
	High	925.5	0.450	0.428

Chain 0:

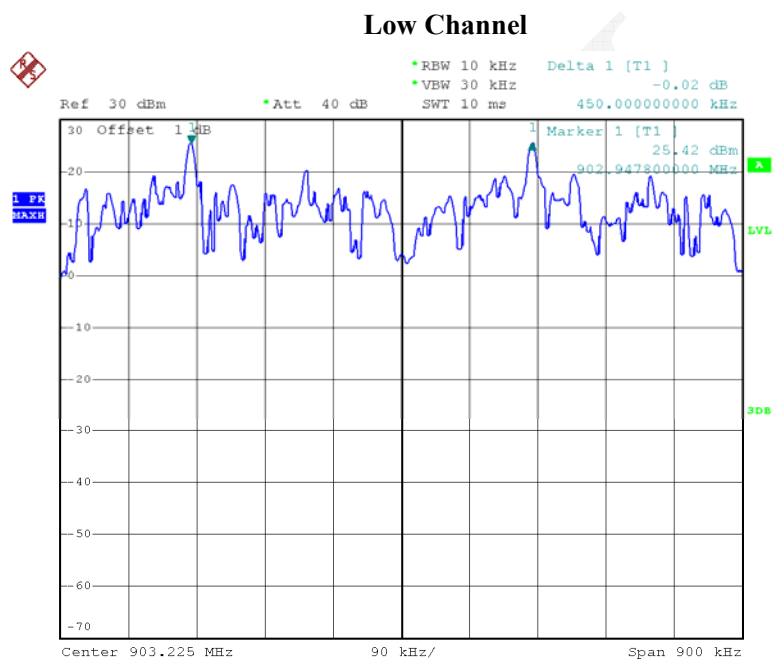

Date: 6.MAY.2016 11:44:01

Middle Channel

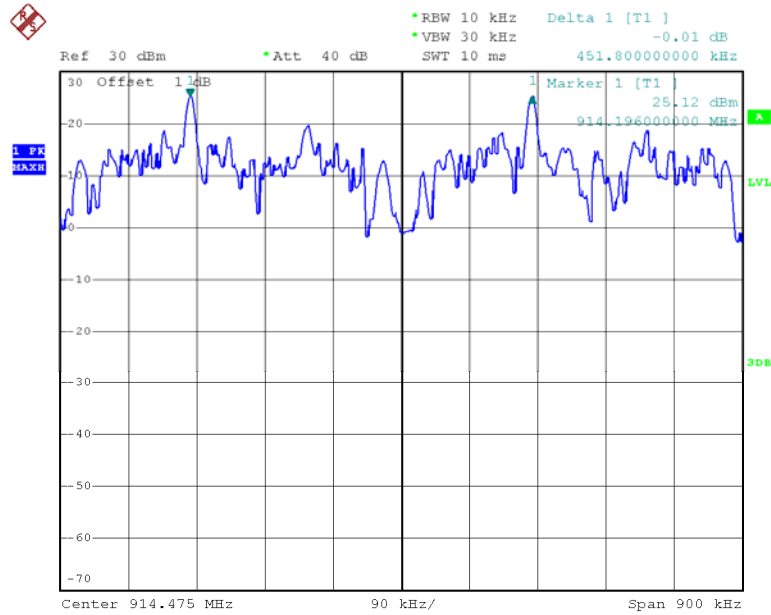

Date: 6.MAY.2016 11:45:08

High Channel

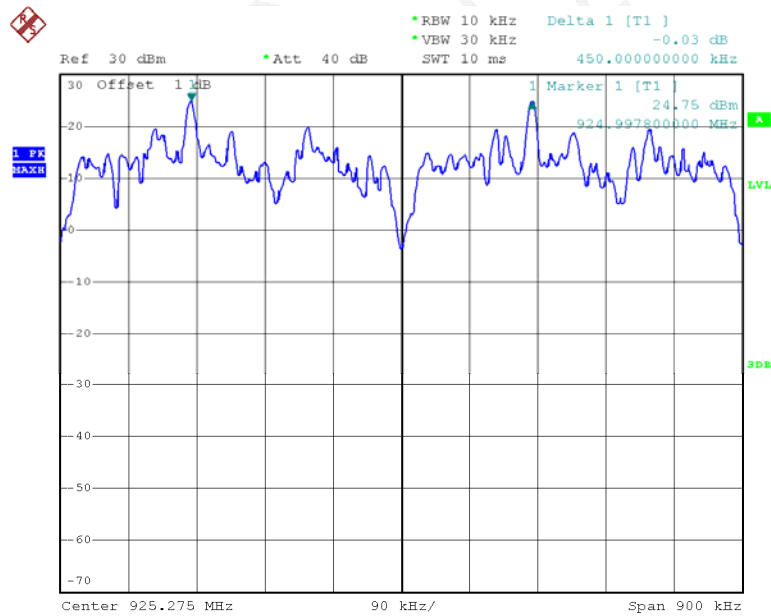

Date: 6.MAY.2016 11:46:52

Chain 1:

Low Channel

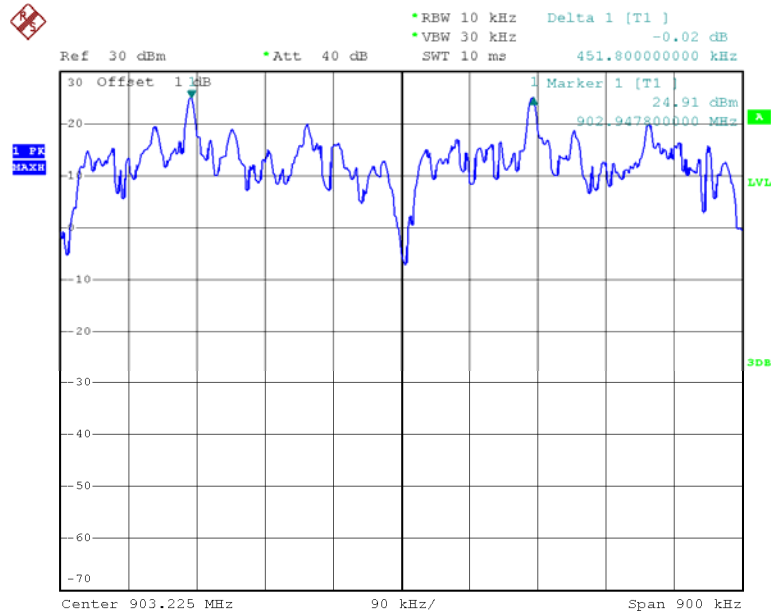

Date: 6.MAY.2016 13:46:37

Middle Channel

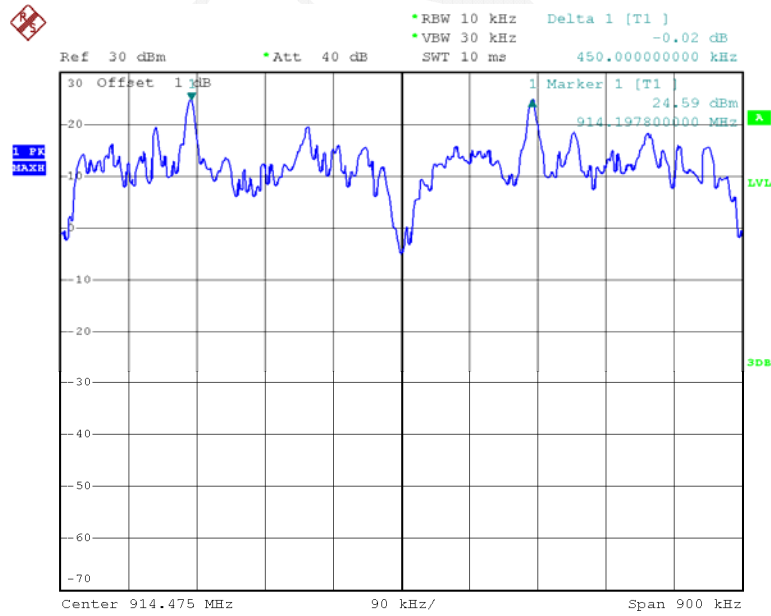

Date: 6.MAY.2016 13:48:26

High Channel

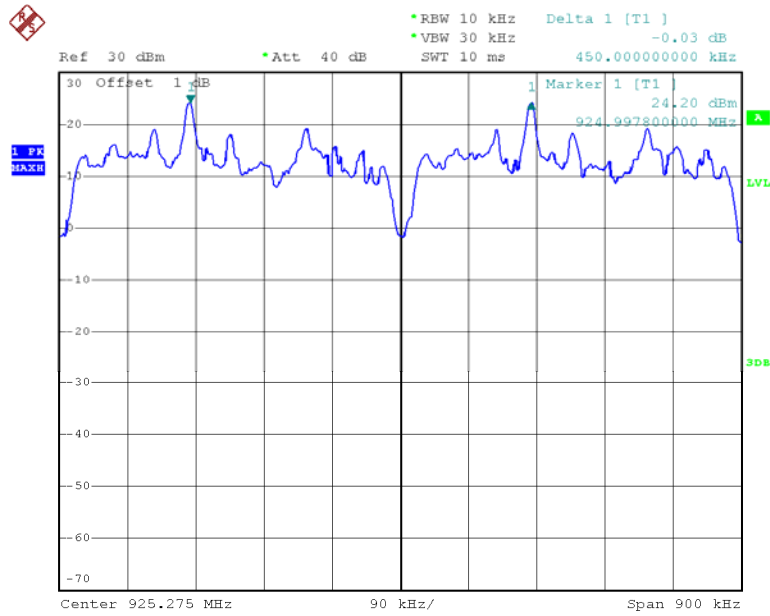

Date: 6.MAY.2016 13:51:48

FCC §15.247(a) (1) – 20 dB BANDWIDTH TESTING

Applicable Standard

(1) Frequency hopping systems shall have hopping channel carrier frequencies separated by a minimum of 25 kHz or the 20 dB bandwidth of the hopping channel, whichever is greater. Alternatively, frequency hopping systems operating in the 2400-2483.5 MHz band may have hopping channel carrier frequencies that are separated by 25 kHz or two-thirds of the 20 dB bandwidth of the hopping channel, whichever is greater, provided the systems operate with an output power no greater than 125 mW. The system shall hop to channel frequencies that are selected at the system hopping rate from a pseudo randomly ordered list of hopping frequencies. Each frequency must be used equally on the average by each transmitter. The system receivers shall have input bandwidths that match the hopping channel bandwidths of their corresponding transmitters and shall shift frequencies in synchronization with the transmitted signals.

(i) For frequency hopping systems operating in the 902-928 MHz band: if the 20 dB bandwidth of the hopping channel is less than 250 kHz, the system shall use at least 50 hopping frequencies and the average time of occupancy on any frequency shall not be greater than 0.4 seconds within a 20 second period; if the 20 dB bandwidth of the hopping channel is 250 kHz or greater, the system shall use at least 25 hopping frequencies and the average time of occupancy on any frequency shall not be greater than 0.4 seconds within a 10 second period. The maximum allowed 20 dB bandwidth of the hopping channel is 500 kHz.

Test Procedure

1. Check the calibration of the measuring instrument using either an internal calibrator or a known signal from an external generator.
2. Position the EUT on the test table without connection to measurement instrument. Turn on the EUT. Then set it to any one convenient frequency within its operating range. Set a reference level on the measuring instrument equal to the highest peak value.
3. Measure the frequency difference of two frequencies that were attenuated 20 dB from the reference level. Record the frequency difference as the emission bandwidth.
4. Repeat above procedures until all frequencies measured were complete.

Test Equipment List and Details

Manufacturer	Description	Model	Serial Number	Calibration Date	Calibration Due Date
R&S	Spectrum Analyzer	FSP 38	100478	2015-11-23	2016-11-22
N/A	Coaxial Cable	0.1m	N/A	2016-05-06	2017-05-06
E-Microwave	DC Blocking	EMDCB-00036	0E01201047	2016-05-06	2017-05-06

* **Statement of Traceability:** Bay Area Compliance Laboratories Corp. (Dongguan) attests that all calibrations have been performed, traceable to National Primary Standards and International System of Units (SI).

Test Data

Environmental Conditions

Temperature:	25.8 °C
Relative Humidity:	54 %
ATM Pressure:	100.4 kPa

* The testing was performed by Emily Wang on 2016-05-06

Test Result: Compliance.

Please refer to following tables and plots

Test Mode: Transmitting

Channel	Frequency (MHz)	20 dB Bandwidth Chain 0 (MHz)	20 dB Bandwidth Chain 1 (MHz)
Low	903	0.430	0.428
Middle	914.25	0.428	0.428
High	925.5	0.428	0.428

Chain 0:

Low Channel



Date: 6.MAY.2016 11:34:30

Middle Channel

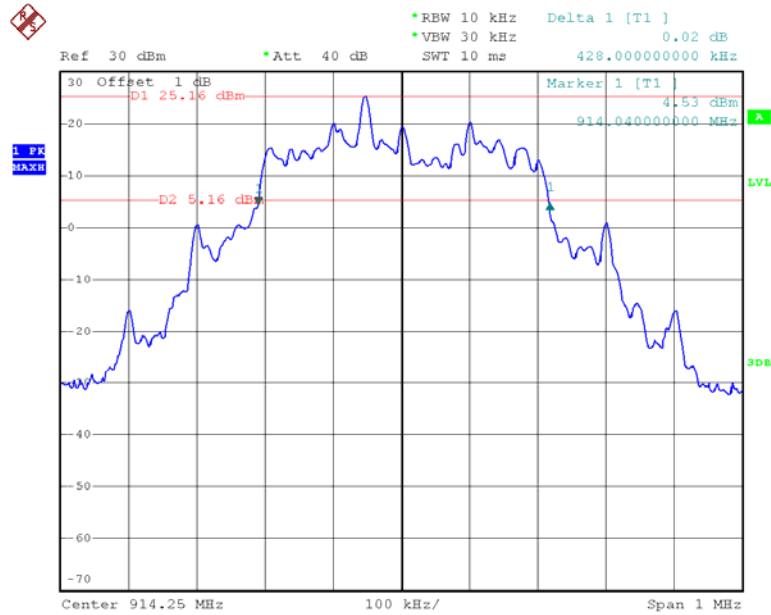

Date: 6.MAY.2016 11:35:55

High Channel

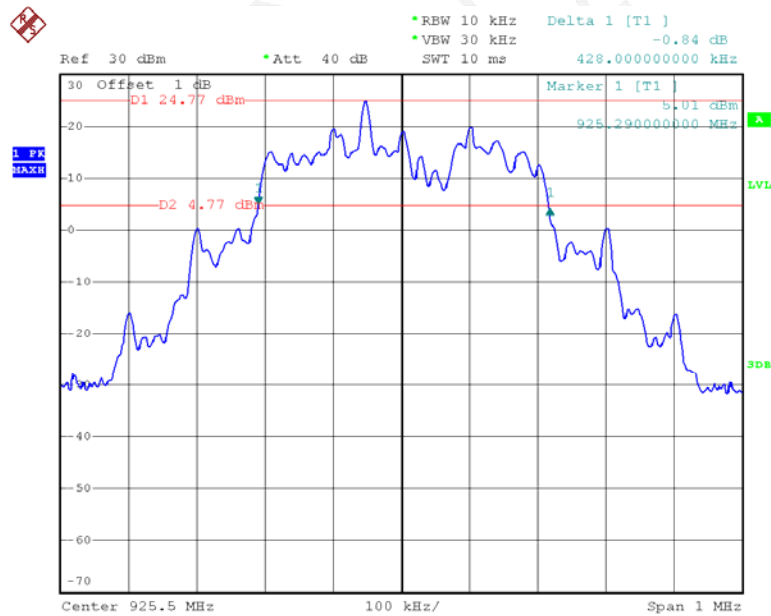

Date: 6.MAY.2016 11:37:09

Chain 1:

Low Channel

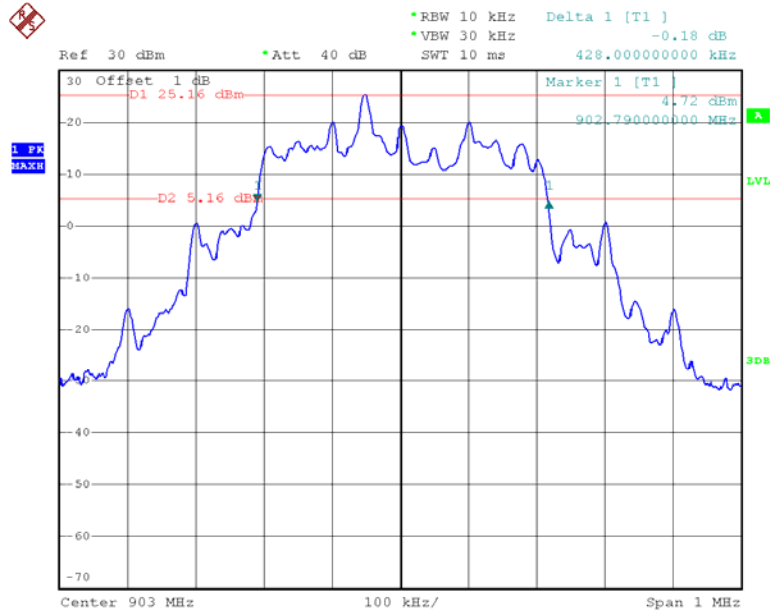

Date: 6.MAY.2016 13:25:46

Middle Channel

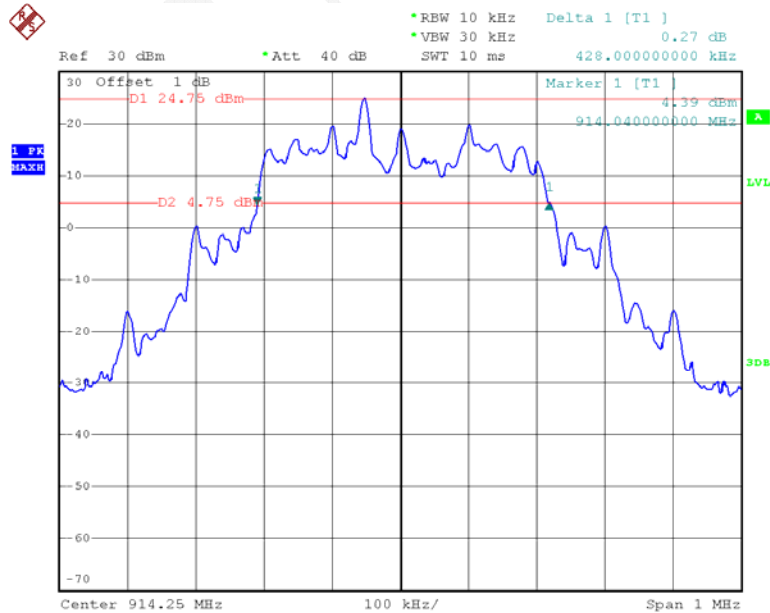

Date: 6.MAY.2016 13:27:04

High Channel

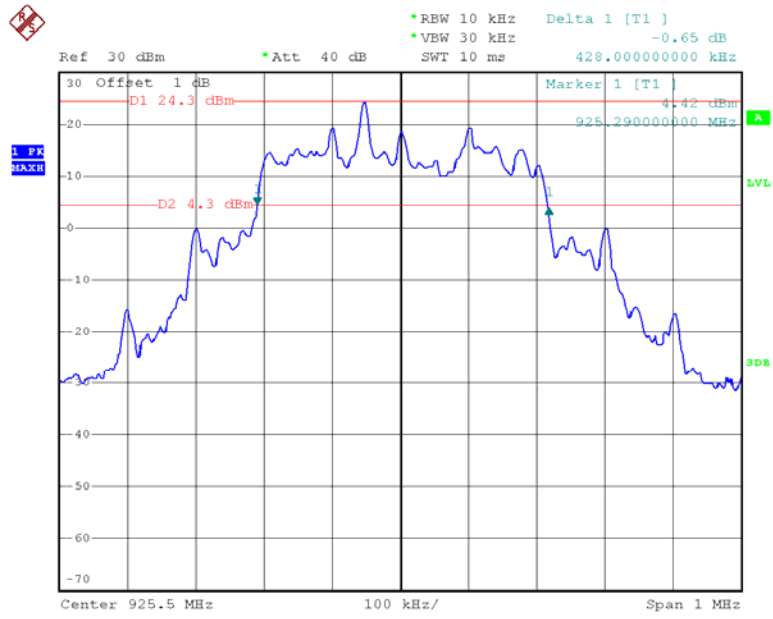

Date: 6.MAY.2016 13:28:30

FEM

FCC §15.247(a) (1) - QUANTITY OF HOPPING CHANNEL TEST

Applicable Standard

(i) For frequency hopping systems operating in the 902-928 MHz band: if the 20 dB bandwidth of the hopping channel is less than 250 kHz, the system shall use at least 50 hopping frequencies and the average time of occupancy on any frequency shall not be greater than 0.4 seconds within a 20 second period; if the 20 dB bandwidth of the hopping channel is 250 kHz or greater, the system shall use at least 25 hopping frequencies and the average time of occupancy on any frequency shall not be greater than 0.4 seconds within a 10 second period. The maximum allowed 20 dB bandwidth of the hopping channel is 500 kHz.

Test Procedure

1. Check the calibration of the measuring instrument (SA) using either an internal calibrator or a known signal from an external generator.
2. Set the EUT in hopping mode from first channel to last.
3. By using the Max-Hold function record the Quantity of the channel.

Test Equipment List and Details

Manufacturer	Description	Model	Serial Number	Calibration Date	Calibration Due Date
R&S	Spectrum Analyzer	FSP 38	100478	2015-11-23	2016-11-22
N/A	Coaxial Cable	0.1m	N/A	2016-05-06	2017-05-06
E-Microwave	DC Blocking	EMDCB-00036	0E01201047	2016-05-06	2017-05-06

* **Statement of Traceability:** Bay Area Compliance Laboratories Corp. (Dongguan) attests that all calibrations have been performed, traceable to National Primary Standards and International System of Units (SI).

Test Data

Environmental Conditions

Temperature:	25.8 °C
Relative Humidity:	54 %
ATM Pressure:	100.4 kPa

* *The testing was performed by Emily Wang on 2016-05-06*

Test Result: Compliance.

Please refer to following tables and plots

Test Mode: Transmitting

BDR Mode (GFSK):

Frequency Range (MHz)	Number of Hopping Channel Chain 0	Number of Hopping Channel Chain 1	Limit
902-928	51	51	≥25

Chain 0:

Number of Hopping Channels

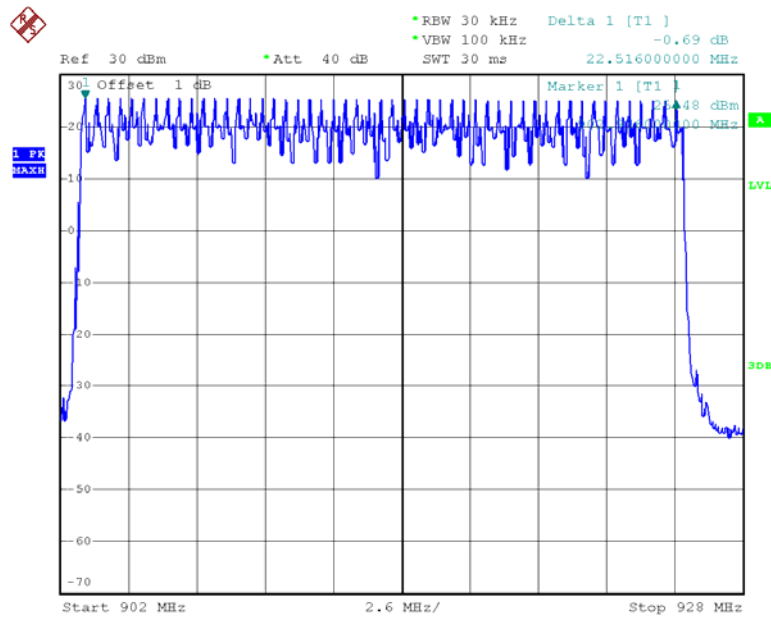

Date: 6.MAY.2016 11:41:54

Chain 1:

Number of Hopping Channels

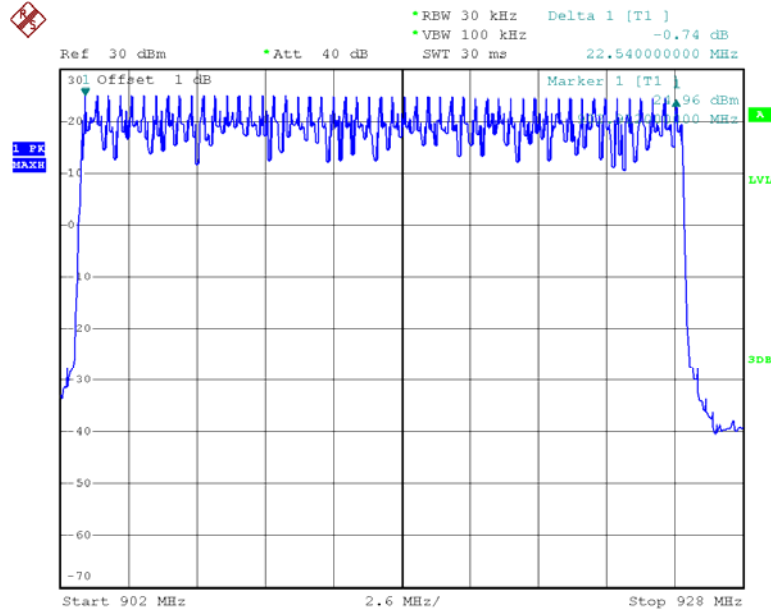

Date: 6.MAY.2016 13:44:37

FCC §15.247(a) (1) - TIME OF OCCUPANCY (DWELL TIME)

Applicable Standard

(i) For frequency hopping systems operating in the 902-928 MHz band: if the 20 dB bandwidth of the hopping channel is less than 250 kHz, the system shall use at least 50 hopping frequencies and the average time of occupancy on any frequency shall not be greater than 0.4 seconds within a 20 second period; if the 20 dB bandwidth of the hopping channel is 250 kHz or greater, the system shall use at least 25 hopping frequencies and the average time of occupancy on any frequency shall not be greater than 0.4 seconds within a 10 second period. The maximum allowed 20 dB bandwidth of the hopping channel is 500 kHz.

Test Procedure

The EUT was worked in channel hopping; Spectrum SPAN was set as 0. Sweep was set as 10s, the quantity of pulse was get from single sweep. In addition, the time of single pulses was tested.

Test Equipment List and Details

Manufacturer	Description	Model	Serial Number	Calibration Date	Calibration Due Date
R&S	Spectrum Analyzer	FSP 38	100478	2015-11-23	2016-11-22
N/A	Coaxial Cable	0.1m	N/A	2016-05-06	2017-05-06
E-Microwave	DC Blocking	EMDCB-00036	0E01201047	2016-05-06	2017-05-06

* **Statement of Traceability:** Bay Area Compliance Laboratories Corp. (Dongguan) attests that all calibrations have been performed, traceable to National Primary Standards and International System of Units (SI).

Test Data

Environmental Conditions

Temperature:	25.8 °C
Relative Humidity:	54 %
ATM Pressure:	100.4 kPa

* *The testing was performed by Emily Wang on 2016-05-06*

Test Result: Compliance.

Please refer to following tables and plots

Test Mode: Transmitting

Chain 0:

Channel	Frequency (MHz)	Occupancy Time For Single Hop (ms)	Real Observed Period(s)	Hops in Observed Period	Dwell Time (s)	Limit (s)	Result
Low	903	2.61	10	49	0.128	0.4	Compliance
Middle	914.25	2.61	10	49	0.127	0.4	Compliance
High	925.5	2.6	10	50	0.131	0.4	Compliance

Note: Dwell time= Occupancy Time For Single Hop (ms) × Hops in Observed Period

Chain 1:

Channel	Frequency (MHz)	Occupancy Time For Single Hop (ms)	Real Observed Period(s)	Hops in Observed Period	Dwell Time (s)	Limit (s)	Result
Low	903	2.61	10	49	0.128	0.4	Compliance
Middle	914.25	2.61	10	50	0.131	0.4	Compliance
High	925.5	2.6	10	50	0.131	0.4	Compliance

Note: Dwell time= Occupancy Time For Single Hop (ms) × Hops in Observed Period

Chain 0:

Low Channel, Hops in Observed Period

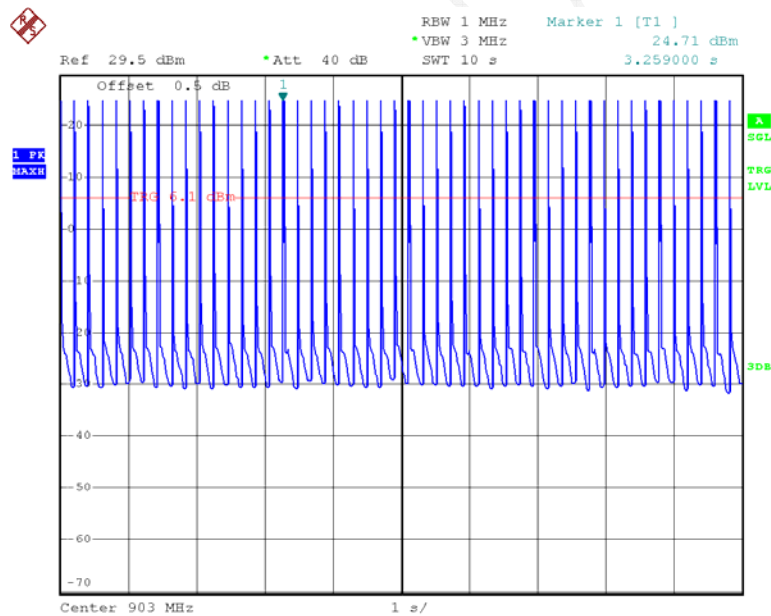

Date: 6.MAY.2016 16:15:40

Low Channel, Occupancy Time For Single Hop

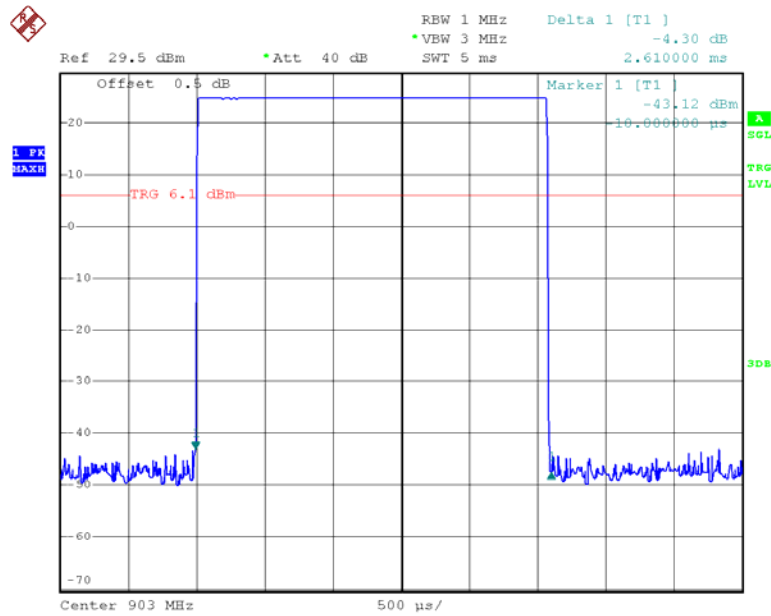

Date: 6.MAY.2016 16:14:59

Middle Channel, Hops in Observed Period

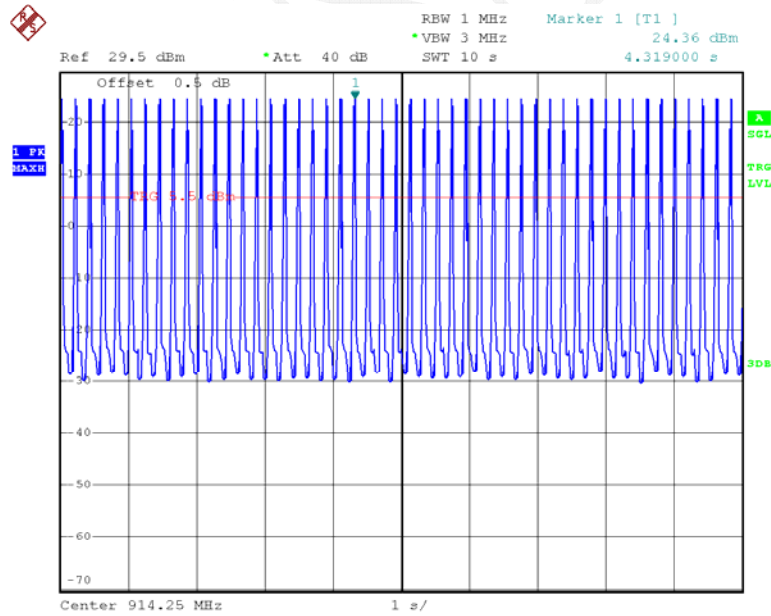

Date: 6.MAY.2016 16:16:46

Middle Channel, Occupancy Time For Single Hop

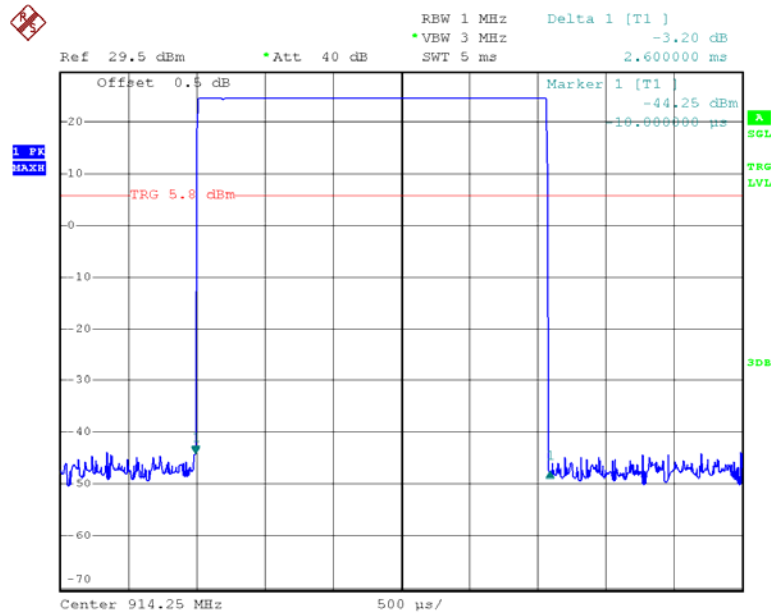

Date: 6.MAY.2016 16:13:23

High Channel, Hops in Observed Period

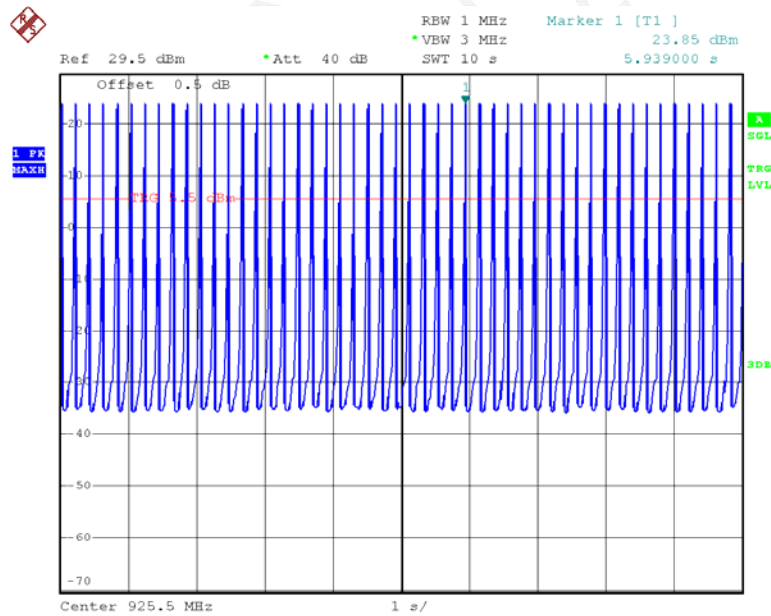

Date: 6.MAY.2016 16:18:11

High Channel, Occupancy Time For Single Hop

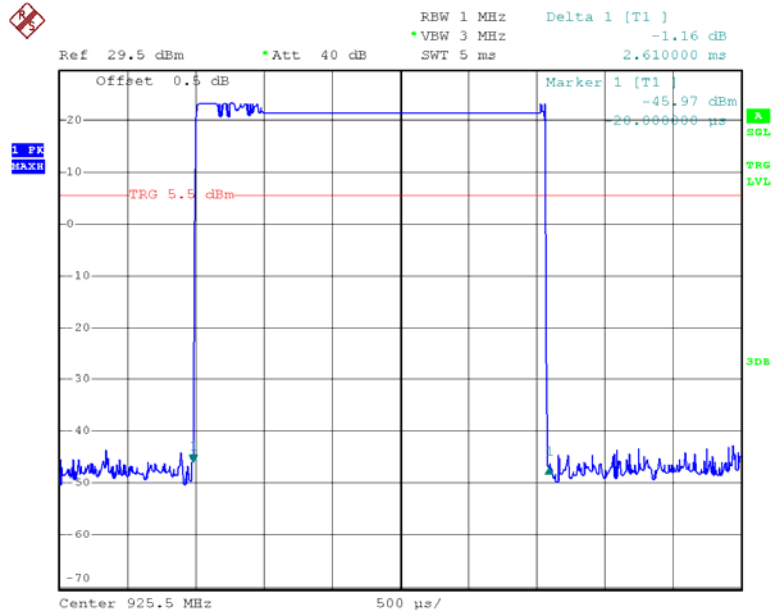

Date: 6.MAY.2016 16:12:25

Chain 1:

Low Channel, Hops in Observed Period

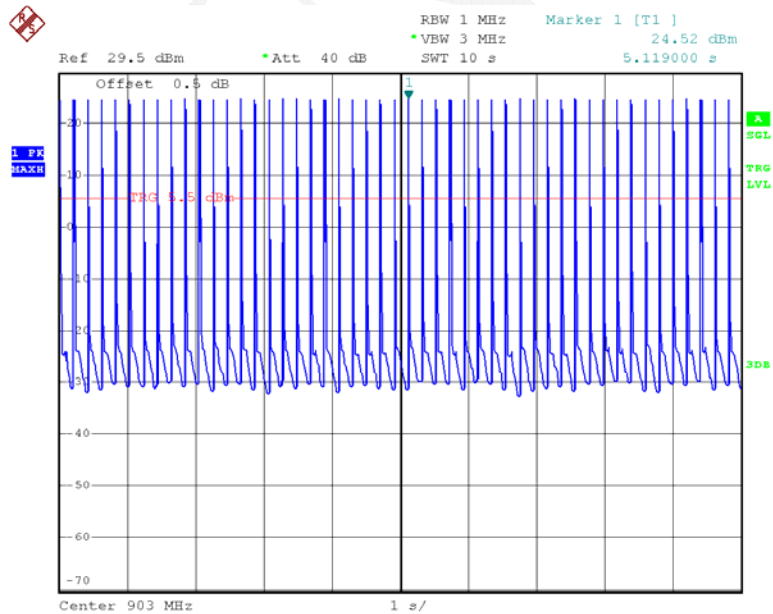

Date: 6.MAY.2016 16:21:10

Low Channel, Occupancy Time For Single Hop

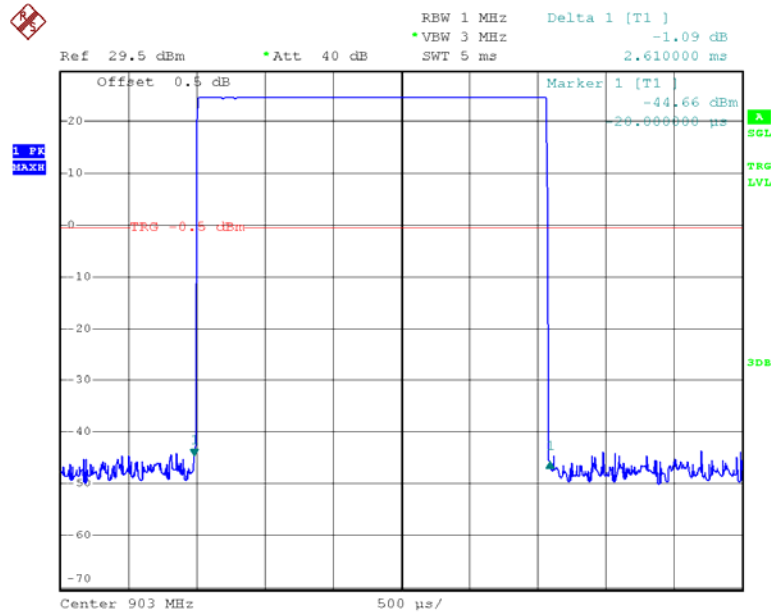

Date: 6.MAY.2016 16:21:55

Middle Channel, Hops in Observed Period

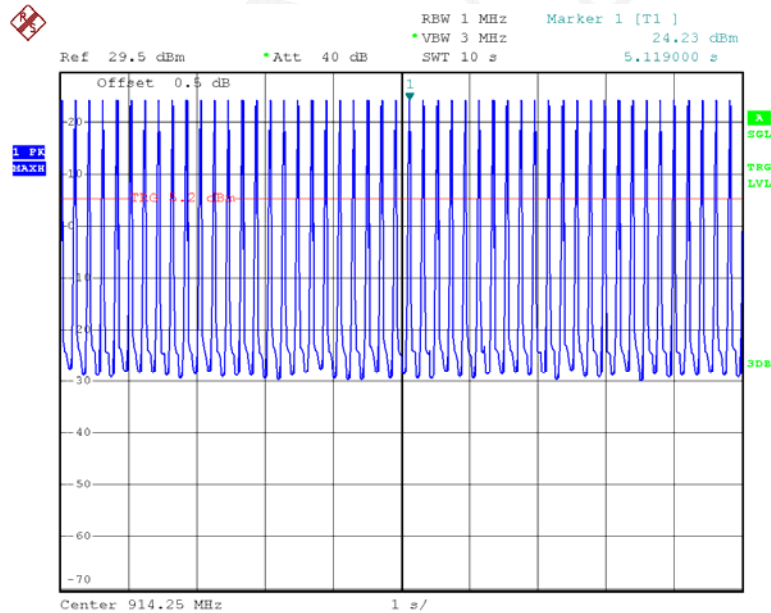

Date: 6.MAY.2016 16:20:42

Middle Channel, Occupancy Time For Single Hop

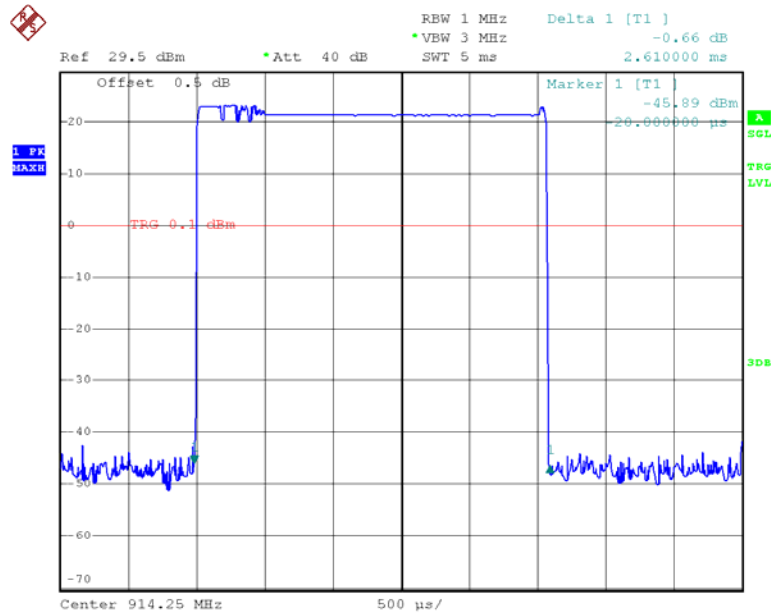

Date: 6.MAY.2016 16:22:23

High Channel, Hops in Observed Period

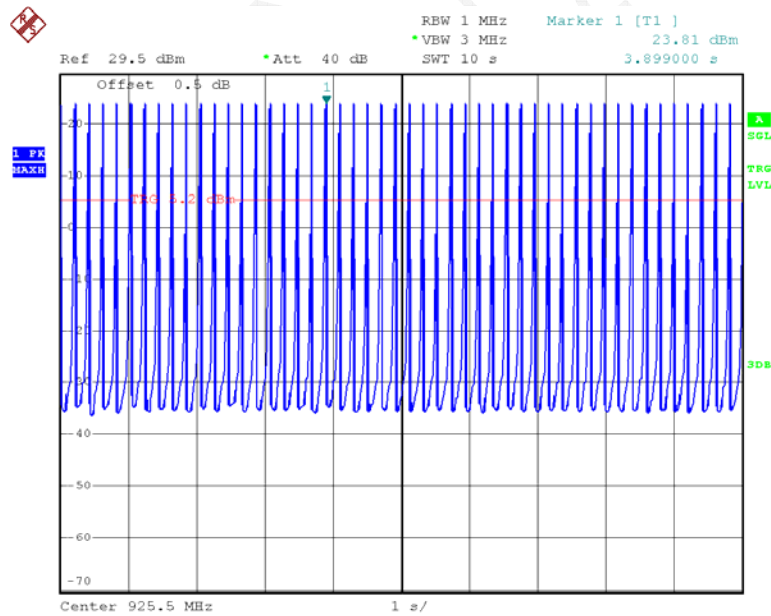

Date: 6.MAY.2016 16:20:10

High Channel, Occupancy Time For Single Hop

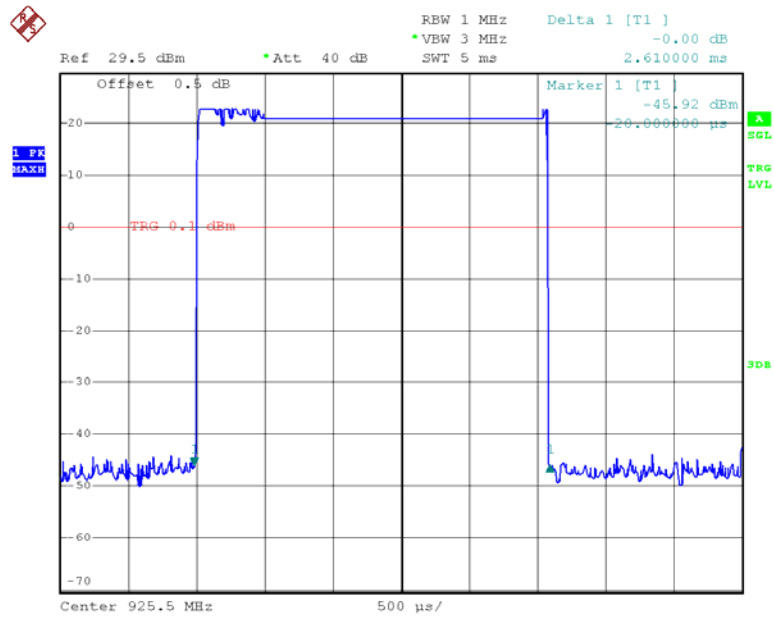

Date: 6.MAY.2016 16:22:44

FCC §15.247(b) (2) - PEAK OUTPUT POWER MEASUREMENT

Applicable Standard

(2) For frequency hopping systems operating in the 902-928 MHz band: 1 watt for systems employing at least 50 hopping channels; and, 0.25 watts for systems employing less than 50 hopping channels, but at least 25 hopping channels, as permitted under paragraph (a)(1)(i) of this section.

Test Procedure

1. Place the EUT on a bench and set in transmitting mode.
2. Remove the antenna from the EUT and then connect a low loss RF cable from the antenna port to one test equipment.
3. Add a correction factor to the display.

Test Equipment List and Details

Manufacturer	Description	Model	Serial Number	Calibration Date	Calibration Due Date
R&S	Spectrum Analyzer	FSP 38	100478	2015-11-23	2016-11-22
N/A	Coaxial Cable	0.1m	N/A	2016-05-06	2017-05-06
E-Microwave	DC Blocking	EMDCB-00036	0E01201047	2016-05-06	2017-05-06

* **Statement of Traceability:** Bay Area Compliance Laboratories Corp. (Dongguan) attests that all calibrations have been performed, traceable to National Primary Standards and International System of Units (SI).

Test Data

Environmental Conditions

Temperature:	25.8 °C
Relative Humidity:	54 %
ATM Pressure:	100.4 kPa

* The testing was performed by Emily Wang on 2016-05-06

Test Result: Compliance.

Test Mode: Transmitting

Channel	Frequency (MHz)	Conducted Output power (dBm)		Limit (dBm)
		Chain 0	Chain 1	
Low	903	25.42	25.39	30
Middle	914.25	25.11	24.9	30
High	925.5	24.71	24.48	30

Note: The data above was tested in conducted mode.

Chain 0:

Output Power, Low Channel

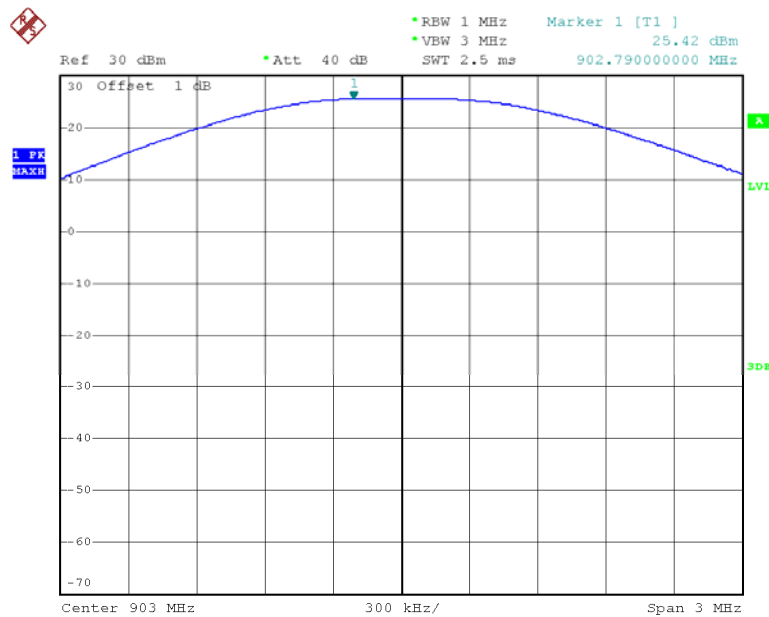

Date: 6.MAY.2016 11:24:22

Output Power, Middle Channel

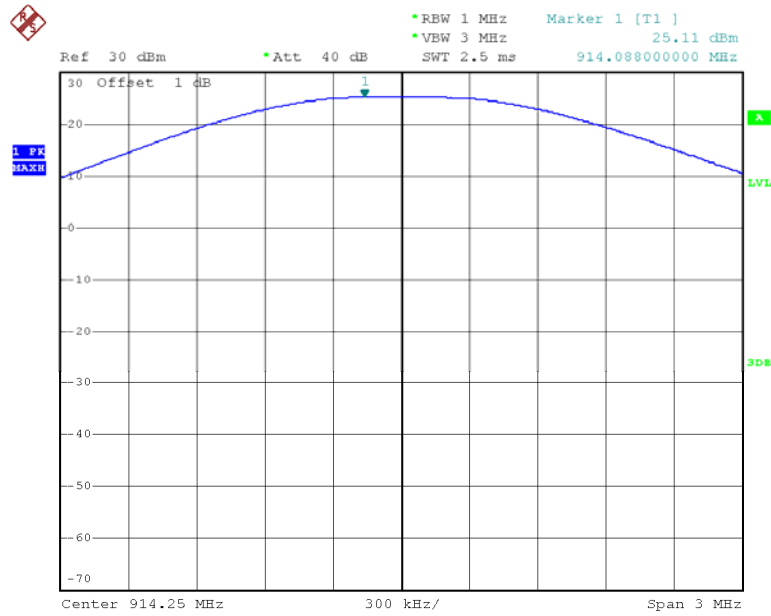

Date: 6.MAY.2016 11:23:56

Output Power, High Channel

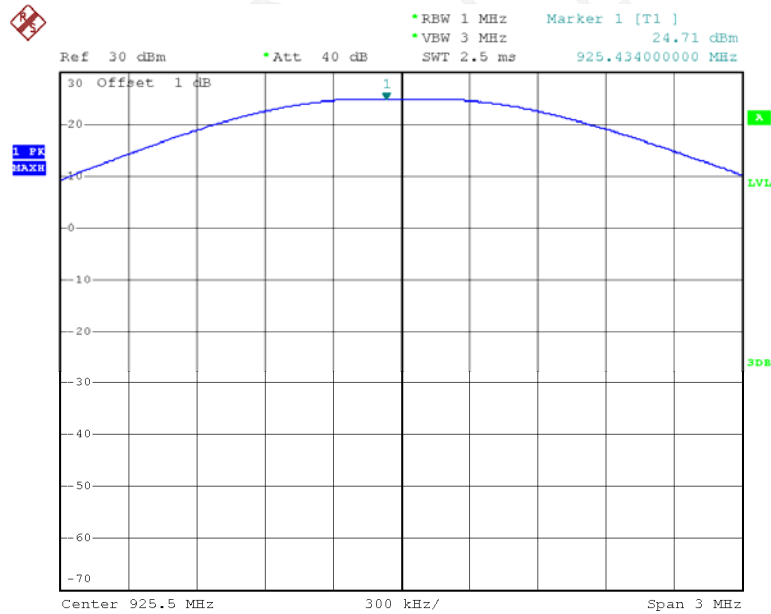

Date: 6.MAY.2016 11:23:24

Chain 1:

Output Power, Low Channel

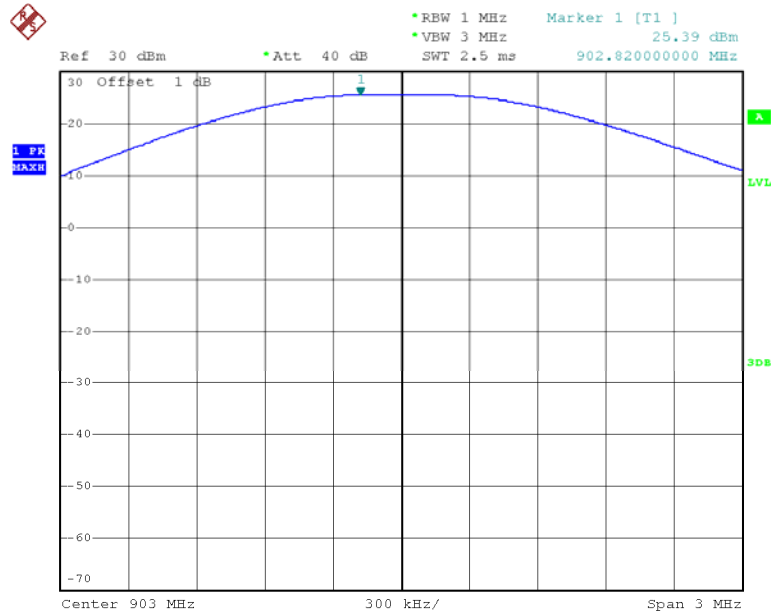

Date: 6.MAY.2016 13:21:10

Output Power, Middle Channel

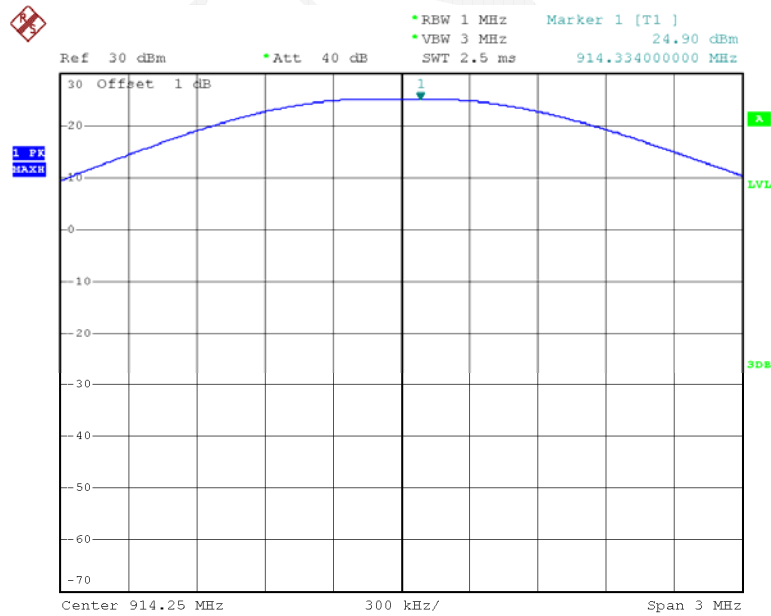

Date: 6.MAY.2016 13:21:42

Output Power, High Channel

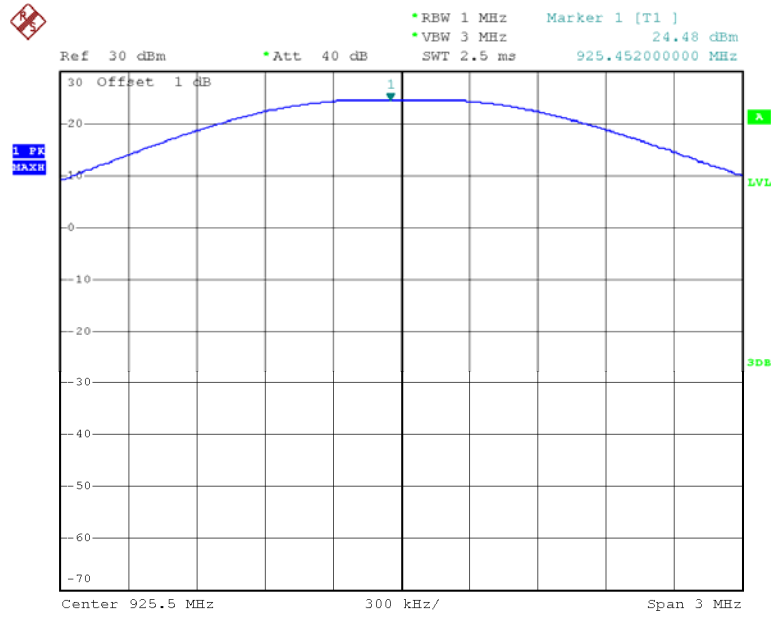

Date: 6.MAY.2016 13:22:22

FULL

FCC §15.247(d) - BAND EDGES TESTING

Applicable Standard

In any 100 kHz bandwidth outside the frequency band in which the spread spectrum or digitally modulated intentional radiator is operating, the radio frequency power that is produced by the intentional radiator shall be at least 20 dB below that in the 100 kHz bandwidth within the band that contains the highest level of the desired power, based on either an RF conducted or a radiated measurement, provided the transmitter demonstrates compliance with the peak conducted power limits. If the transmitter complies with the conducted power limits based on the use of RMS averaging over a time interval, as permitted under paragraph (b)(3) of this section, the attenuation required under this paragraph shall be 30 dB instead of 20 dB. Attenuation below the general limits specified in §15.209(a) is not required. In addition, radiated emissions which fall in the restricted bands, as defined in §15.205(a), must also comply with the radiated emission limits specified in §15.209(a) (see §15.205(c)).

Test Procedure

1. Check the calibration of the measuring instrument using either an internal calibrator or a known signal from an external generator.
2. Remove the antenna from the EUT and then connect to a low loss RF cable from the antenna port to a EMI test receiver, then turn on the EUT and make it operate in transmitting mode. Then set it to Low Channel and High Channel within its operating range, and make sure the instrument is operated in its linear range.
3. Set both RBW and VBW of spectrum analyzer to 100 kHz with a convenient frequency span including 100 kHz bandwidth from band edge.
4. Measure the highest amplitude appearing on spectral display and set it as a reference level. Plot the graph with marking the highest point and edge frequency.
5. Repeat above procedures until all measured frequencies were complete.

Test Equipment List and Details

Manufacturer	Description	Model	Serial Number	Calibration Date	Calibration Due Date
R&S	Spectrum Analyzer	FSP 38	100478	2015-11-23	2016-11-22
N/A	Coaxial Cable	0.1m	N/A	2016-05-06	2017-05-06
E-Microwave	DC Blocking	EMDCB-00036	0E01201047	2016-05-06	2017-05-06

* **Statement of Traceability:** Bay Area Compliance Laboratories Corp. (Dongguan) attests that all calibrations have been performed, traceable to National Primary Standards and International System of Units (SI).

Test Data

Environmental Conditions

Temperature:	25.8 °C
Relative Humidity:	54 %
ATM Pressure:	100.4 kPa

* The testing was performed by Emily Wang on 2016-05-06

Test Result: Compliance
 Chain 0:

Band Edge, Left Side

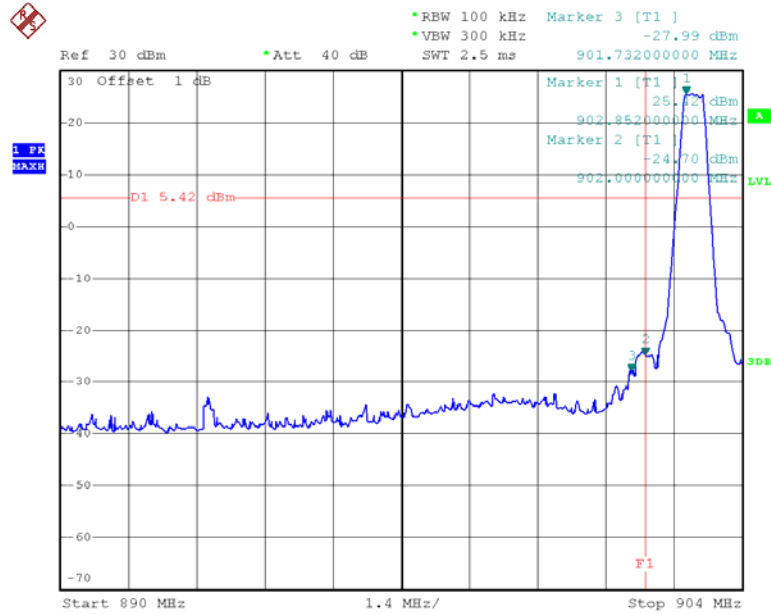

Date: 6.MAY.2016 11:31:39

Band Edge, Right Side

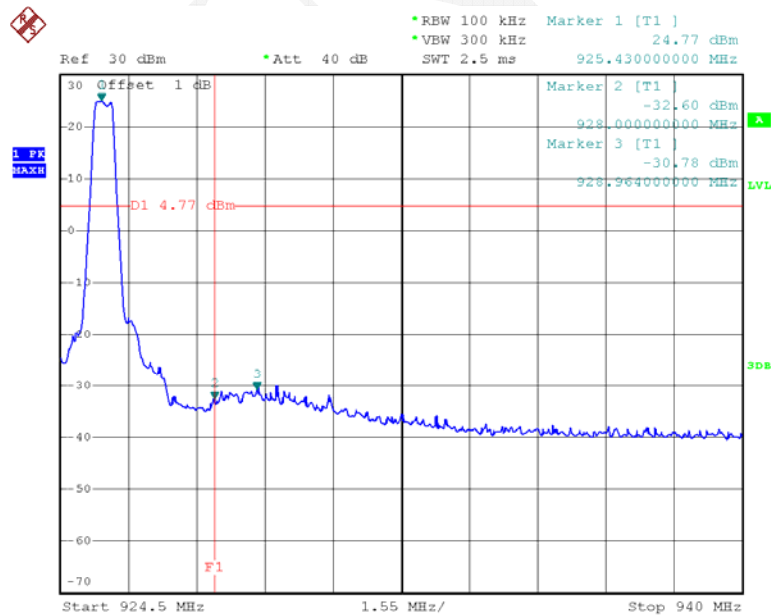

Date: 6.MAY.2016 11:29:45

Chain 1:

Band Edge, Left Side

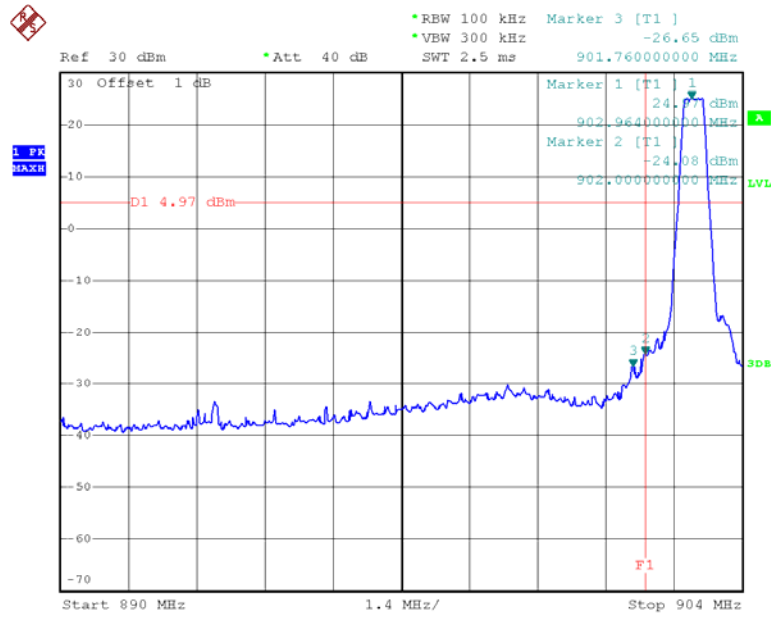

Date: 6.MAY.2016 13:32:52

Band Edge, Right Side

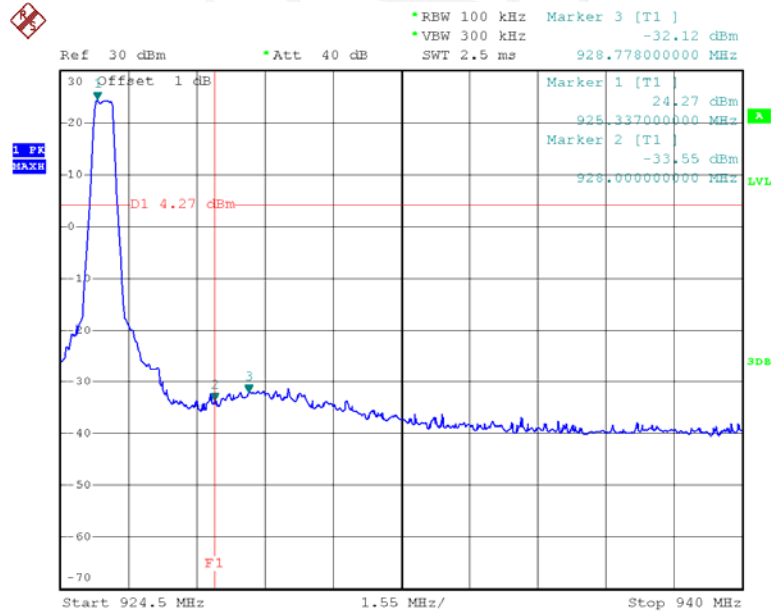

Date: 6.MAY.2016 13:30:40

*******END OF REPORT*******