

Phantom 4 Pro V2.0

Quick Start Guide

V1.0



Phantom 4 Pro V2.0

The DJI PHANTOM™ 4 Pro is a smart prosumer flying camera capable of shooting 4K video at 60fps and at up to 100mbps, and capturing 20 megapixel stills. 4 directions of obstacle avoidance allow it to intelligently avoid obstacles during flight. Using upgraded TapFly™ and ActiveTrack™ through the DJI GOTM 4 app, you can fly anywhere visible on your screen or track a moving subject smoothly and easily with a simple tap. The brand new camera uses a 1-inch CMOS sensor offering unprecedented clarity, lower noise, and better quality images.

In addition to the above features, Phantom 4 Pro V2.0 reduces noise power by 60%, the noise reduced by 4dB, which improved the efficiency significantly.



- | | |
|--|--------------------------------|
| 1. Gimbal and Camera | 9. Motors |
| 2. Downward Vision System* | 10. Propellers |
| 3. Micro USB Port | 11. Aircraft Status Indicators |
| 4. Camera/Linking Status Indicator and Link Button | 12. Antennas |
| 5. Camera Micro SD Card Slot | 13. Rear Vision System |
| 6. Forward Vision System | 14. Intelligent Flight Battery |
| 7. Infrared Sensing System* | 15. Power Button |
| 8. Front LEDs | 16. Battery Level Indicators |



* The Vision and Infrared Sensing Systems are affected by surrounding conditions. Read the Disclaimer and Safety Guidelines and watch the tutorials in the DJI GO 4 app or on the official DJI website to learn more.
<http://www.dji.com/phantom-4-pro>

Remote Controller

The powerful remote controller of the Phantom 4 Pro V2.0 has a transmission range extending up to 4.3 mi (7 km)*. It features physical buttons and dials to control exposure, camera tilt, photo capture and video recording.

Built into the Remote Controller is DJI's latest long-range transmission technology OCUSYNC™, which when paired with a compatible mobile device gives you a live HD view from the Phantom's camera. Dual frequency support makes the HD video downlink more stable. An internal battery ensures a long battery life and ease of use.

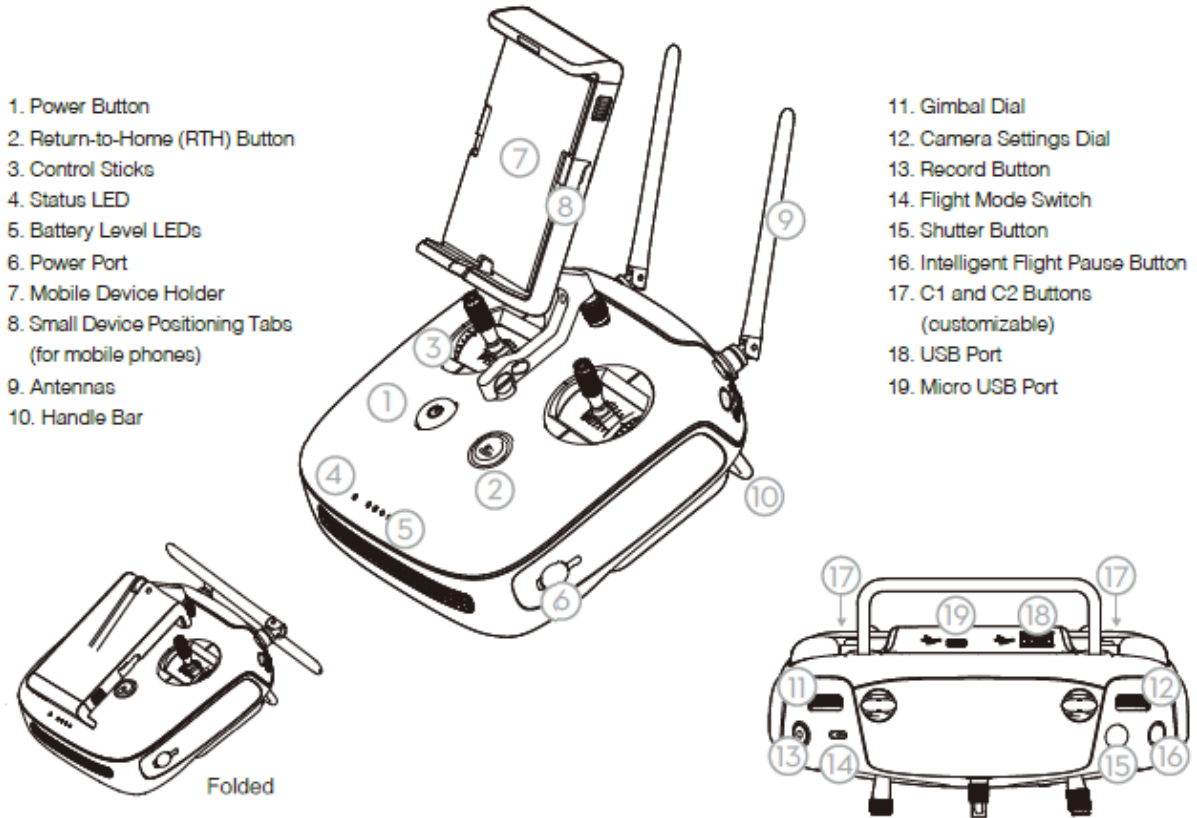

The default flight control is known as Mode 2. The left stick controls the aircraft's altitude and heading, while the right stick controls its forward, backward, left and right movements. The gimbal dial controls the camera's tilt.

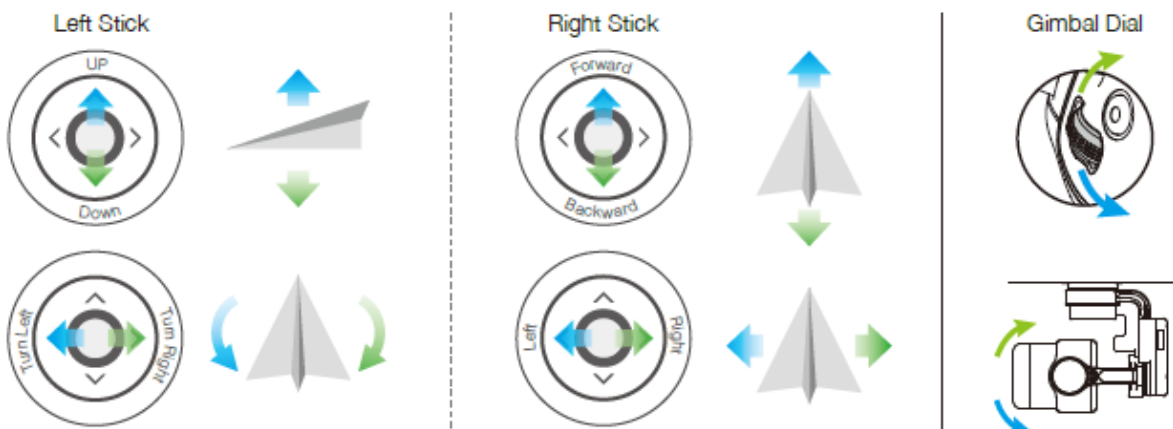

* The remote controller is able to reach its maximum transmission distance (FOC) in a wide open area with no Electro-Magnetic Interference, and at an altitude of about 400 feet (120 meters).

Using Phantom 4 Pro V2.0

1. Download the DJI GO 4 App

Search for 'DJI GO 4' on the App Store or Google Play, and install the app on your mobile device.



DJI GO 4 App

2. Watch the Tutorial Videos

Watch the tutorial videos at www.dji.com or in the DJI GO 4 app.



Tutorial Videos

 • DJI GO 4 supports iOS 9.0 (or later) or Android 4.4 (or later).

3. Check the Battery Levels

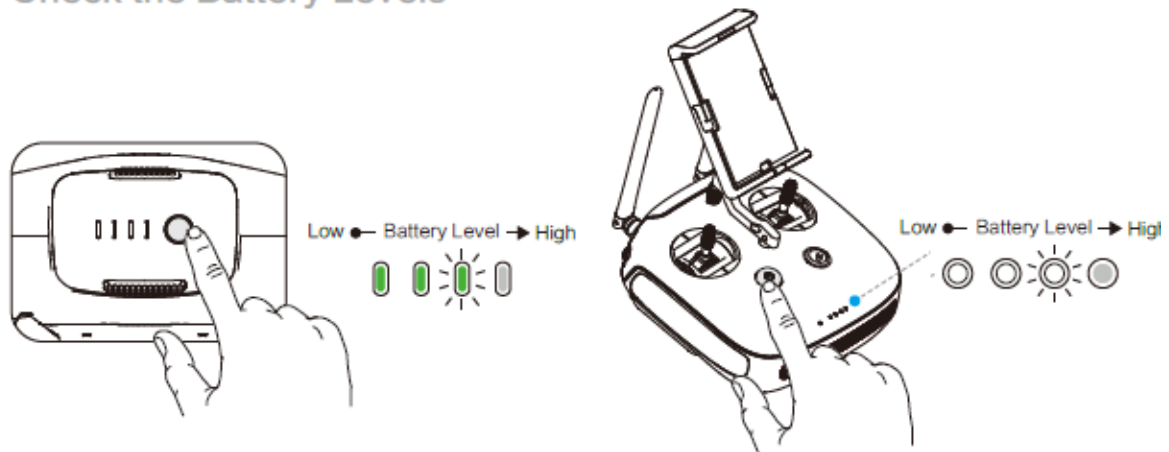

Press once to check the battery level. Press once, then again and hold to turn on/off.

4. Charge the Batteries

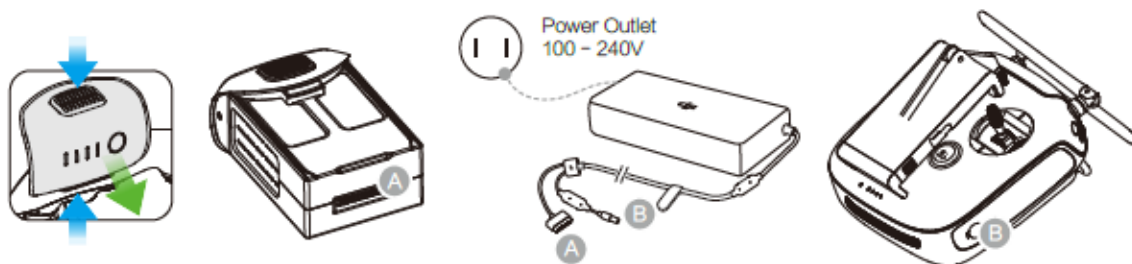

Remove the battery.

Charge Time:
~1 hr 20 min

Charge Time:
~3 hr 40 min

 • When charging is complete, the battery level indicators will automatically turn off.

5. Prepare the Remote Controller

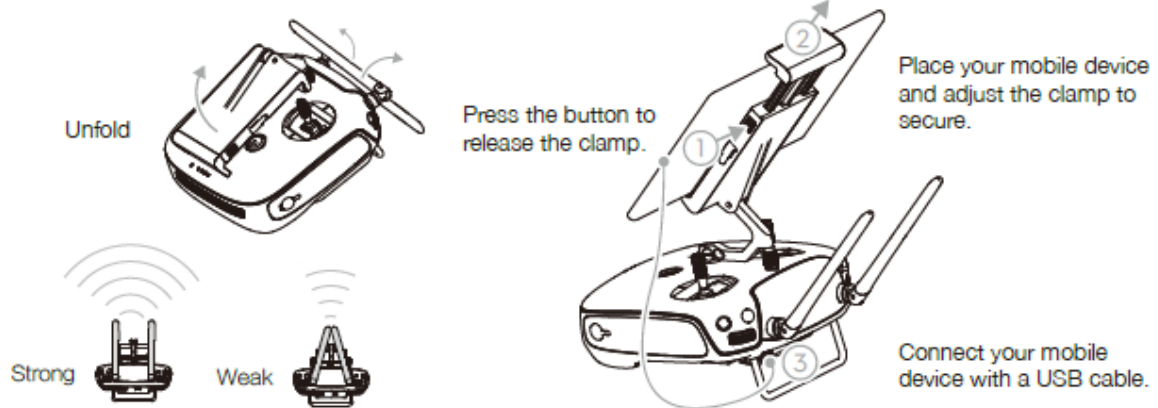

6. Prepare for Takeoff

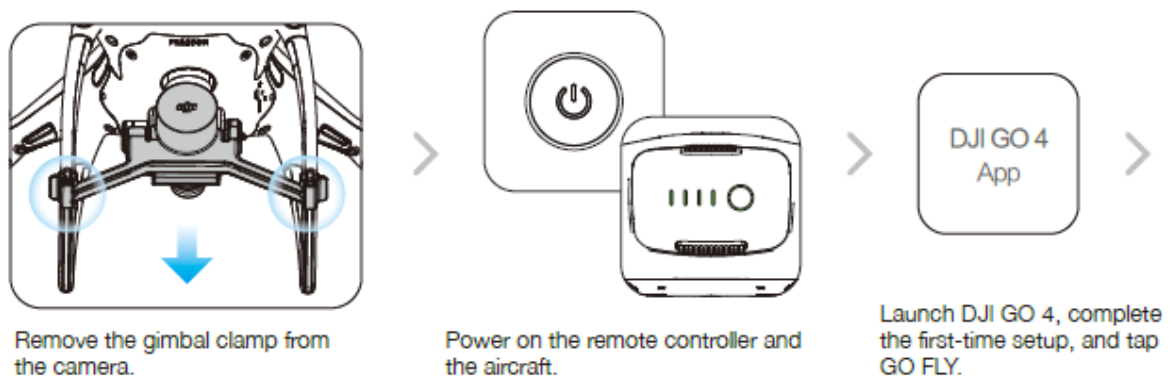

First-time activation requires your DJI account and internet connection.



Black propeller rings go on motors with black dots.



Silver propeller rings go on motors without black dots.



Press the propeller down onto the mounting plate and rotate in the lock direction until secure.



• Check that the propellers are secure before each flight.

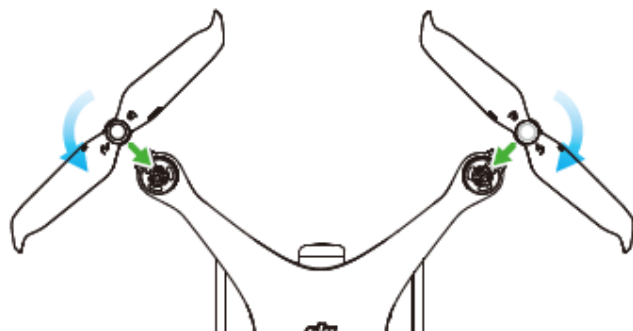

7. Flight

Ready to Go (GPS)

Before taking off, make sure the Aircraft Status Bar in the DJI GO 4 app indicates 'Ready to Go (GPS)' or 'Ready to Go (Vision)' if flying indoors.

In the DJI GO 4 App:



Auto Takeoff

The aircraft will take off and hover at an altitude of 4 feet (1.2 meters).



Auto Landing

The aircraft will land vertically and stop its motors.



Return-to-Home (RTH)

Bring the aircraft back to the Home Point. Tap again to stop the procedure.



Normal

You are in control of the Phantom, with satellite and Return-to-Home support.



TapFly

Tap on your screen to fly your Phantom in that direction, avoiding obstacles as it flies.



ActiveTrack

Mark an object on your screen to track it as it moves.



- Watch the tutorial in the DJI GO 4 app or on the official DJI website to learn more.
- Always set an appropriate RTH altitude before takeoff. When the aircraft is returning to the Home Point, you should guide it with the control sticks. Refer to the Disclaimer and Safety Guidelines for more details.

Manual Takeoff



Combination Stick Command to start/stop the motors

Left stick up (slowly) to take off

Manual Landing



Left stick down (slowly) until you touch the ground
Hold a few seconds to stop the motors



- Rotating propellers can be dangerous. Do not start the motors when there are people nearby.
- Always keep your hands on the remote controller so long as the motor is still spinning.
- **Stop motor mid-flight:** Pull the left stick to the bottom inside corner while simultaneously pressing the RTH button. Only stop motors mid-flight in emergency situations when doing so can reduce the risk of damage or injury. Refer to the user manual for details.



Stop motor mid-flight



It's important to understand basic flight guidelines, for the safety of both you and those around you. Don't forget to read the Disclaimer and Safety Guidelines.

Specifications

Aircraft	
Weight (Battery & Propellers Included)	1375 g
Max Ascent Speed	S-mode: 6 m/s; P-mode: 5 m/s
Max Descent Speed	S-mode: 4 m/s; P-mode: 3 m/s
Max Speed	45 mph (72 kph) (S-mode); 36mph (58 kph) (A-mode); 31 mph (50 kph) (P-mode)
Max Service Ceiling Above Sea Level	19685 ft (6000 m)
Max Flight Time	Approx. 30 minutes
Operating Temperature	32° to 104° F (0° to 40° C)
Satellite Positioning Systems	GPS/GLONASS
Hover Accuracy Range	Vertical: ±0.1 m (With Vision Positioning); ±0.5 m (With GPS Positioning) Horizontal: ±0.3 m (With Vision Positioning); ±1.5 m (With GPS Positioning)
Gimbal	
Controllable Range	Pitch: -90° to +30°
Vision System	
Velocity Range	≤31 mph (50 kph) at 6.6 ft (2 m) above ground
Altitude Range	0 - 33 ft (0 - 10 m)
Operating Range	0 - 33 ft (0 - 10 m)
Obstacle Sensory Range	2 - 98 ft (0.7 - 30 m)
Operating Environment	Surfaces with clear patterns and adequate lighting (> 15 lux)
Infrared Sensing System	
Obstacle Sensory Range	0.6 - 23 ft (0.2 - 7 m)
Operating Environment	Surface with diffuse reflection material, and reflectivity > 8% (such as wall, trees, humans, etc.)
Camera	
Sensor	1" CMOS; Effective pixels: 20M
Lens	FOV (Field of View) 84°, 8.8 mm (35 mm format equivalent: 24 mm), f/2.8 - f/11, auto focus at 1 m - ∞
ISO Range	Video: 100 - 3200 (Auto); 100 - 6400 (Manual); Photo: 100 - 3200 (Auto); 100 - 12800 (Manual)
Mechanical Shutter	8 - 1/2000 s
Electronic Shutter	8 - 1/8000 s
Max Image Size	3:2 Aspect Ratio: 5472x3648; 4:3 Aspect Ratio: 4864x3648; 16:9 Aspect Ratio: 5472x3078
Still Photography Modes	Single Shot Burst Shooting: 3/5/7/10/14 frames Auto Exposure Bracketing (AEB): 3/5 bracketed frames at 0.7EV Bias Interval: 2/3/5/7/10/15/30/60 s
Video Recording Modes	H.265 •C4K: 4096x2160 24/25/30p •4K: 3840x2160 24/25/30p •2.7K: 2720x1530 24/25/30/48/50/60p •FHD: 1920x1080 24/25/30/48/50/60/120p •HD: 1280x720 24/25/30/48/50/60/120p H.264 •C4K: 4096x2160 24/25/30/48/50/60p •4K: 3840x2160 24/25/30/48/50/60p •2.7K: 2720x1530 24/25/30/48/50/60p •FHD: 1920x1080 24/25/30/48/50/60/120p •HD: 1280x720 24/25/30/48/50/60/120p
Video Storage Bitrate	100 Mbps
Supported File Systems	FAT32 (≤ 32 GB); exFAT (> 32 GB)
Photo	JPEG, RAW (DNG), JPEG + RAW
Video	MP4/MOV (AVC/H.264; HEVC/H.265)
Supported SD Cards	Micro SD, Max Capacity: 128 GB. Class 10 or UHS-1 rating required
Operating Temperature	32° to 104° F (0° to 40° C)
Remote Controller	
Operating Frequency	2.400 - 2.483 GHz and 5.725 - 5.850 GHz
Max Transmission Distance (Unobstructed, free of interference)	2.4 GHz: 26 dBm (FCC); 20 dBm (CE); 20 dBm (SRRC) 5.8 GHz: 26 dBm (FCC); 14 dBm (CE); 20 dBm (SRRC)
Operating Temperature	32° - 104° F (0° - 40° C)
Battery	6000 mAh LiPo 2S
Transmitter Power (EIRP)	2.4 GHz: 26 dBm (FCC); 20 dBm (CE); 20 dBm (SRRC) 5.8 GHz: 26 dBm (FCC); 14 dBm (CE); 20 dBm (SRRC)
Operating Voltage	1.2 A @ 7.4 V
Charger	
Voltage	17.4 V
Rated Power	100 W
Intelligent Flight Battery (PH4-5870mAh-15.2V)	
Capacity	5870 mAh
Voltage	15.2 V
Battery Type	LiPo 4S
Energy	89.2 Wh
Net Weight	468 g
Charging Temperature Range	41° to 104° F (5° to 40° C)
Max Charging Power	100 W

Compliance Information

FCC Compliance Notice

This device complies with Part 15 of the FCC Rules. Operation is subject to the following two conditions: (1) This device may not cause harmful interference, and (2) This device must accept any interference received, including interference that may cause undesired operation.

Any changes or modifications not expressly approved by the party responsible for compliance could void the user's authority to operate the equipment.

This equipment has been tested and found to comply with the limits for a Class B digital device, pursuant to part 15 of the FCC Rules. These limits are designed to provide reasonable protection against harmful interference in a residential installation. This equipment generates, uses and can radiate radio frequency energy and, if not installed and used in accordance with the instructions, may cause harmful interference to radio communications. However, there is no guarantee that interference will not occur in a particular installation. If this equipment does cause harmful interference to radio or television reception, which can be determined by turning the equipment off and on, the user is encouraged to try to correct the interference by one or more of the following measures:

- Reorient or relocate the receiving antenna.
- Increase the separation between the equipment and receiver.
- Connect the equipment into an outlet on a circuit different from that to which the receiver is connected.
- Consult the dealer or an experienced radio/TV technician for help.

ISED RSS Warning

This device complies with licence-exempt RSS standard (s). Operation is subject to the following two conditions: (1) this device may not cause interference, and (2) this device must accept any interference, including interference that may cause undesired operation of the device.

Le présent appareil est conforme aux CNR d'Industrie Canada applicables aux appareils radio exempts de licence.

L'exploitation est autorisée aux deux conditions suivantes:

- (1) l'appareil ne doit pas produire de brouillage, et
- (2) l'utilisateur de l'appareil doit accepter tout brouillage radioélectrique subi, même si le brouillage est susceptible d'en compromettre le fonctionnement.

RF Exposure Information

Aircraft complies with FCC/ISED radiation exposure limits set forth for an uncontrolled environment. In order to avoid the possibility of exceeding the FCC/ISED radio frequency exposure limits, human proximity to the antenna shall not be less than 20cm during normal operation.

For Remote Controller (model GL300L), SAR tests are conducted using standard operating positions accepted by the FCC/ISED with the remote controller transmitting at its highest certified power level in all tested frequency bands, although the SAR is determined at the highest certified power level, the actual SAR level of the remote controller while operating can be well below the maximum value.

Before a new model is available for sale to the public, it must be tested and certified to the FCC/ISED that it does not exceed the exposure limit established by the FCC/ISED. Tests for each model are performed in positions and locations as required by the FCC/ISED.

For body worn operation, this mobile phone has been tested and meets the FCC/ISED RF exposure guidelines when used with an accessory designated for this product or when used with an accessory that contains no metal and that positions the handset a minimum of 10 mm from the body.

KCC Warning Message

“해당무선설비는 운용 중 전파혼신 가능성이 있으므로 인명안전과 관련된 서비스는 할 수 없습니다.”

“해당 무선설비는 운용 중 전파혼신 가능성이 있음”

NCC Warning Message

低功率電波輻射性電機管理辦法

第十二條 經型式認證合格之低功率射頻電機，非經許可，公司、商號或使用者均不得擅自變更頻率、加大功率或變更原設計之特性及功能。

第十四條 低功率射頻電機之使用不得影響飛航安全及干擾合法通信；經發現有干擾現象時，應改善至無干擾時方得繼續使用。前項合法通信，指依電信法規定作業之無線電通信。低功率射頻電機須忍受合法通信或工業、科學及醫療用電波輻射性電機設備之干擾。

EU Compliance Statement: SZ DJI TECHNOLOGY CO., LTD hereby declares that this device is in compliance with the essential requirements and other relevant provisions of the Directive 2014/53/EU.

A copy of the EU Declaration of Conformity is available online at www.dji.com/euro-compliance

EU contact address: DJI GmbH, Industriestrasse. 12, 97618, Niederlauer, Germany

Declaración de cumplimiento UE: SZ DJI TECHNOLOGY CO., LTD por la presente declara que este dispositivo cumple los requisitos básicos y el resto de provisiones relevantes de la Directiva 2014/53/EU.

Hay disponible online una copia de la Declaración de conformidad UE en www.dji.com/euro-compliance

Dirección de contacto de la UE: DJI GmbH, Industriestrasse. 12, 97618, Niederlauer, Germany

EU-verklaring van overeenstemming: SZ DJI TECHNOLOGY CO., LTD verklaart hierbij dat dit apparaat voldoet aan de essentiële vereisten en andere relevante bepalingen van Richtlijn 2014/53/EU.

De EU-verklaring van overeenstemming is online beschikbaar op www.dji.com/euro-compliance

Contactadres EU: DJI GmbH, Industriestrasse. 12, 97618, Niederlauer, Germany

Declaração de conformidade da UE: A SZ DJI TECHNOLOGY CO., LTD declara, através deste documento, que este dispositivo está em conformidade com os requisitos essenciais e outras disposições relevantes da Diretiva 2014/53/EU.

Existe uma cópia da Declaração de conformidade da UE disponível online em www.dji.com/euro-compliance

Endereço de contacto na UE: DJI GmbH, Industriestrasse. 12, 97618, Niederlauer, Germany

Dichiarazione di conformità UE: SZ DJI TECHNOLOGY CO., LTD dichiara che il presente dispositivo è conforme ai requisiti essenziali e alle altre disposizioni rilevanti della direttiva 2014/53/EU

Una copia della dichiarazione di conformità UE è disponibile online all'indirizzo Web www.dji.com/euro-compliance

Indirizzo di contatto UE: DJI GmbH, Industriestrasse. 12, 97618, Niederlauer, Germany

Déclaration de conformité UE : Par la présente, SZ DJI TECHNOLOGY CO., LTD déclare que cet appareil est conforme aux principales exigences et autres clauses pertinentes de la directive européenne 2014/53/EU. Une copie de la déclaration de conformité UE est disponible sur le site www.dji.com/euro-compliance

Adresse de contact pour l'UE : DJI GmbH, Industriestrasse. 12, 97618, Niederlauer, Germany

EU-Compliance: Hiermit erklärt SZ DJI TECHNOLOGY CO., LTD, dass dieses Gerät den wesentlichen Anforderungen und anderen einschlägigen Bestimmungen der EU-Richtlinie 2014/53/EU entspricht. Eine Kopie der EU-Konformitätserklärung finden Sie online auf www.dji.com/euro-compliance.

Kontaktadresse innerhalb der EU: DJI GmbH, Industriestrasse. 12, 97618, Niederlauer, Germany



CAUTION: RISK OF EXPLOSION IF BATTERY IS REPLACED BY AN INCORRECT TYPE. DISPOSE OF USED BATTERIES ACCORDING TO THE INSTRUCTIONS

Environmentally friendly disposal



Old electrical appliances must not be disposed of together with the residual waste, but have to be disposed of separately. The disposal at the communal collecting point via private persons is for free. The owner of old appliances is responsible to bring the appliances to these collecting points or to similar collection points. With this little personal effort, you contribute to recycle valuable raw materials and the treatment of toxic substances.

Thailand Warning message

เครื่องโทรคมนาคมและอุปกรณ์นี้ มีความสอดคล้องตามข้อกำหนดของ กทท.

Mexico Warning message

“La operación de este equipo está sujeta a las siguientes dos condiciones: (1) es posible que este equipo o dispositivo no cause interferencia perjudicial y (2) este equipo o dispositivo debe aceptar cualquier interferencia, incluyendo la que pueda causar su operación no deseada.”

Brazil Warning message

Este equipamento opera em caráter secundário, isto é, não tem direito a proteção contra interferência prejudicial, mesmo de estações do mesmo tipo, e não pode causar interferência a sistemas operando em caráter primário