

# AGRAS T30

## Quick Start Guide

v1.0



# Aircraft

The AGRAS[™] T30 is DJI's next-generation aircraft, boasting a revolutionary transforming structure and a max payload of up to 30 kg. Using DJI's digital agriculture solutions, the performance and efficiency of crop protection operations can be greatly enhanced and improved. With the updated Route Operation mode users can mark obstacles outside of the operation area for Smart Continuous Flight. The new Smart Supply Reminder calculates both the remaining liquid amount and battery life to help users manage spraying operations.

The aircraft comes equipped with the Spherical Perception Radar System, a pioneering new system for the agriculture industry. Consisting of the Omnidirectional Digital Radar and Upward Radar, the system provides functions such as terrain following, obstacle sensing, and obstacle circumventing. With the forward and backward FPV cameras and bright spotlights, the system comprehensively ensures operational safety day and night in different weather.

Thanks to the innovative new plunger pumps and the 16 sprinklers, the spraying system offers improved spray width, rate, distribution, and efficiency. The 2-channel electromagnetic flow meter and continuous liquid level gauge make measurements more accurate than ever. To spray orchards, users can purchase the optional orchard spraying kit to transform the aircraft into ORCHARD FORM. When spraying orchards, branch-targeting technology can be used for precise spraying with the help of the all-new Spherical Perception Radar System and DJI Agras Cloud.

Core components have two layers of protection and the aircraft has a protection rating of IP67 (IEC standard 60529) so that it can be washed directly with water.

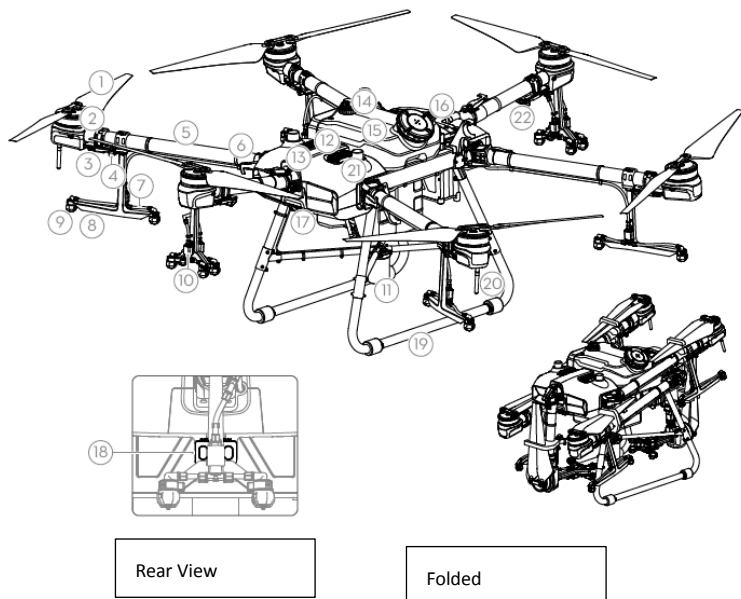

1. Propellers
2. Motors
3. ESCs
4. Aircraft Front Indicators (on three front arms)
5. Frame Arms
6. Folding Detection Sensors (built-in)
7. Hoses
8. Sprinklers
9. Nozzles
10. Electromagnetic Exhaust Valves
11. Omnidirectional Digital Radar
12. Upward Radar
13. Heat Sinks
14. Liquid Level Gauge
15. Spread Tank
16. Battery Compartment
17. Forward FPV Camera
18. Backward FPV Camera
19. Landing Gear
20. OCUSYNC™ Antennas
21. Onboard D-RTK™ Antennas
22. Aircraft Status Indicators (on three rear arms)

## Remote Controller

The Smart Controller 3.0 uses DJI OcuSync 2.0 transmission technology, has a max transmission distance of up to 7 km\*, and supports Wi-Fi and Bluetooth. The remote controller has a 5.5-inch bright, dedicated screen and comes with the updated DJI Agras app built-in, delivering a smooth and easy-to-use experience. When the RTK dongle is connected to the remote controller, users can plan operations to centimeter-level precision. The Multi-Aircraft Control mode\* of the remote controller can be used to coordinate the operation of up to five aircraft at the same time, enabling pilots to work efficiently. Both the built-in battery and external battery can be used to supply power to the remote controller. The remote controller has a working time of up to 4 hours, making it ideal for long and high-intensity operations.

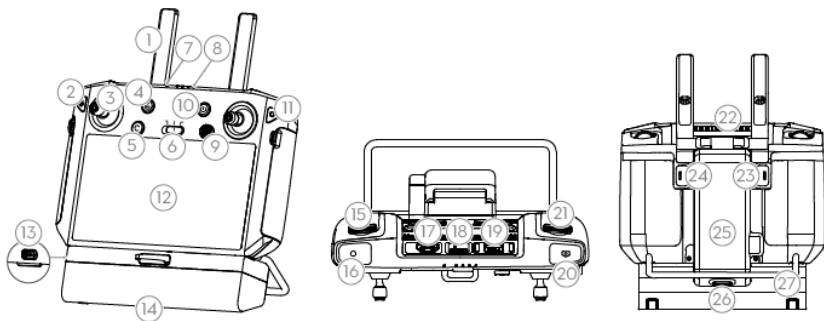

<ol style="list-style-type: none"> <li>1. Antennas</li> <li>2. Back/Function Button</li> <li>3. Control Stick</li> <li>4. RTH Button</li> <li>5. Button C3 (customizable)</li> <li>6. Flight Mode Switch</li> <li>7. Status LED Descriptions</li> <li>8. Battery Level Indicators</li> <li>9. 5D Button (customizable)</li> </ol>	<ol style="list-style-type: none"> <li>10. Power Button</li> <li>11. Confirm Button</li> <li>12. Touch Screen</li> <li>13. USB-C Charging Port</li> <li>14. Dongle Compartment Cover</li> <li>15. Spray Rate Dial</li> <li>16. Spray Button</li> <li>17. HDMI Port</li> <li>18. microSD Card Slot</li> </ol>	<ol style="list-style-type: none"> <li>19. USB-A Port</li> <li>20. FPV/Map Switch Button</li> <li>21. Work Efficiency Dial</li> <li>22. Air Outlet</li> <li>23. Button C1 (customizable)</li> <li>24. Button C2 (customizable)</li> <li>25. Battery Cover</li> <li>26. Battery Cover Release Button</li> <li>27. Handle</li> </ol>
---	--	--

The figure below shows the function that each control stick movement performs and uses Mode 2 as an example. In

Mode 2, the left stick is used to control the altitude and heading of the aircraft while the right stick is used to control the forward, backward, left, and right movements.

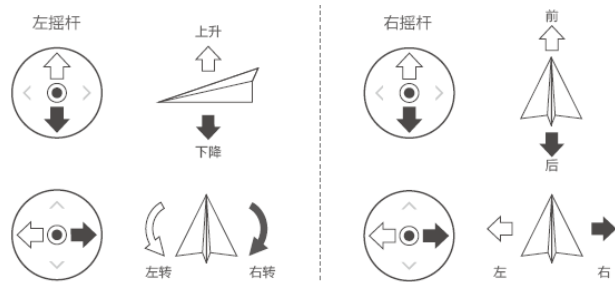

\* The remote controller is able to reach its maximum transmission distance (FCC/NCC: 7 km (4.35 mi); SRRC: 5 km (3.11 mi); CE/KCC/MIC: 4 km (2.49 mi)) in an open area with no electromagnetic interference, and at an altitude of approximately 2.5 m (8.2 ft).

Make sure to comply with local laws and regulations when using Multi-Aircraft Control mode.

## Fly Safe

It is important to understand some basic flight guidelines, both for your protection and for the safety of those around you.

1. Flying in Open Areas: pay attention to utility poles, power lines, and other obstacles. DO NOT fly near or above water, people, or animals.
2. Maintain Control at All Times: keep your hands on the remote controller and maintain control of the aircraft when it is in flight, even when using intelligent functions such as the Route and A-B Route operation modes and Smart Return to Home.
3. Maintain Line of Sight: maintain visual line of sight (VLOS) with your aircraft at all times and avoid flying behind buildings or other obstacles that may block your view.
4. Monitor Your Altitude: for the safety of manned aircraft and other air traffic, fly at altitudes lower than 30 m (98 ft) and in accordance with all local laws and regulations.



Visit <https://www.dji.com/flysafe> for more information on critical safety features such as GEO zones.

## Flight Environment Requirements

1. DO NOT use the aircraft to spray in winds exceeding 18 kph (11 mph).
2. DO NOT use the aircraft in adverse weather conditions such as winds exceeding 28 kph (17 mph), heavy rain exceeding 25 mm (0.98 in) in 12 hours, snow, or fog.
3. DO NOT fly more than 4.5 km (14,763 ft) above sea level.

4. Once the operating altitude reaches 1 km (3,280 ft), the payload capacity of the spray tank is reduced by 3.6 kg. For every additional km, the payload capacity will be reduced a further 3.6 kg.

5. Make sure that there is a strong GNSS signal and the D-RTK antennas are unobstructed during operation.

## Return to Home (RTH)

The aircraft will automatically return to the Home Point in the following situations:

Smart RTH: user presses and holds the RTH button.

Failsafe RTH: the remote controller signal is lost.\*

If there is an obstacle within 20 m of the aircraft, the aircraft decelerates and brakes and hovers. If the aircraft comes within 6 m of the obstacle while decelerating, the aircraft brakes, flies backward to approx. 6 m from the obstacle, and hovers. The aircraft exits RTH and waits for further commands.

If RTH is triggered during Route operations, the aircraft can plan a flight path for RTH to circumvent the obstacles added when planning a field.

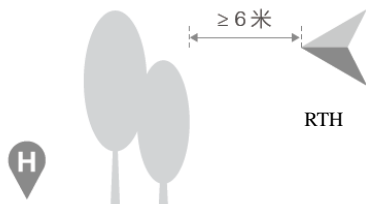

\* If Failsafe RTH is disabled (the default setting in the DJI Agras app), the aircraft hovers in place when the remote controller signal is lost.

	<ul style="list-style-type: none"><li>• Obstacle avoidance is disabled when the aircraft is in Attitude mode, which it enters in situations such as when the GNSS signal is weak. Note that obstacle avoidance is unreliable when using the aircraft in environments where the radar module cannot operate normally. Extra caution is required in such situations.</li></ul>
--	--

## Pesticide Usage

1. Avoid the use of powder pesticides as much as possible as they may reduce the service life of the spraying system.
2. Pesticides are poisonous and pose serious risks to safety. Only use them in strict accordance with their specifications.
3. Use clean water to mix the pesticide and filter the mixed liquid before pouring into the spray tank to avoid blocking the strainer.
4. Effective use of pesticides depends on pesticide density, spray rate, spray distance, aircraft speed, wind speed, wind direction, temperature, and humidity. Consider all factors when using pesticides.
5. DO NOT compromise the safety of people, animals, or the environment during operation.



It is important to understand the basic flight guidelines, both for your protection and for the safety of those around you.

Make sure to read the disclaimer and safety guidelines.

## Using the T30

### 1. Preparing the Intelligent Flight Battery

Only use official DJI flight batteries (model: BAX501-29000mAh-51.8V). Check the battery level before flying and charge according to the corresponding manual document.

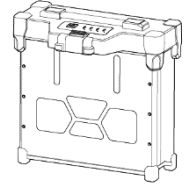

### 2. Preparing the Aircraft

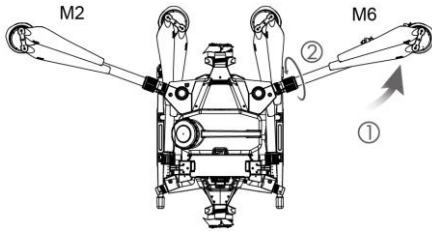

Unfold the M2 and M6 arms, and fasten the two arm locks. Avoid pinching fingers.

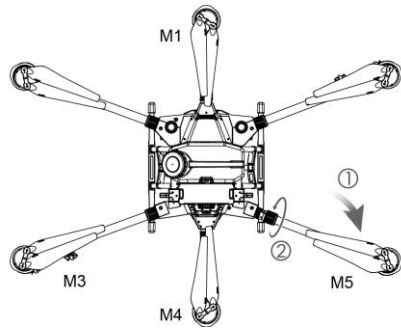

Unfold the M3 and M5 arms followed

by M1 and M4 and fasten the four arm locks. Avoid pinching fingers.

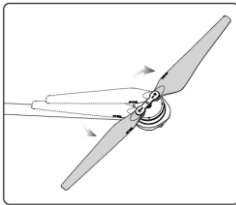

Unfold the propeller blades.

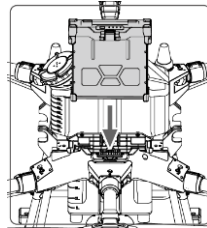

Insert the Intelligent Flight Battery into the aircraft until you hear a click.



- Make sure that the battery is firmly inserted into the aircraft. Only insert or remove the battery when the aircraft is powered off.
- To remove the battery, press and hold the clamp and lift the battery up.
- When folding the arms, make sure to fold the M3 and M5 arms first, and then the M2 and M6 arms. Otherwise, the arms may be damaged. Lift and lower the M1 and M4 arms gently to reduce wear and tear.

### 3. Preparing the Remote Controller

#### Charging the Batteries

Charge the external Intelligent Battery using the charging hub and AC power adapter. Charge the internal battery of the

remote controller using the USB charger and USB-C cable. Fully charge the batteries before using for the first time.

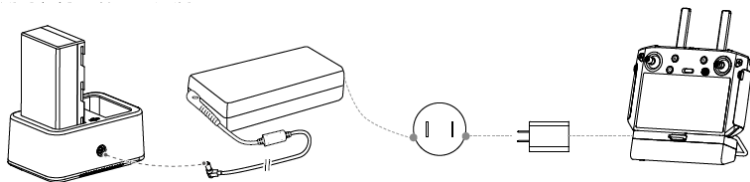

Charging Hub AC Power Adapter Power Outlet (100 - 240 V) USB Charger USB-C Cable

## Mounting the External Battery

- ① Press the battery cover release button on the back of the remote controller.
- ② Insert the Intelligent Battery into the compartment and push it down.
- ③ Close the cover.

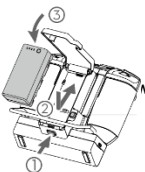

Battery Release Button



- To remove the Intelligent Battery, press and hold the battery release button and push the battery downward.

## Mounting the Dongle and SIM Card



- Only use a DJI-approved dongle. The dongle supports various network standards. Use a SIM card that is compatible with the chosen mobile network provider and select a mobile data plan according to the planned level of usage.
- The dongle and SIM card enable the remote controller to access specific networks and platforms such as the DJI Agras Management Platform. Make sure to insert them correctly. Otherwise, network access will not be available.

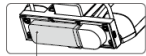
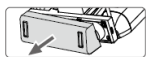

无线上网卡



- ① Remove the dongle compartment cover.
- ② Make sure the SIM card is inserted into the dongle. Insert the dongle into the USB port and test the dongle.\*
- ③ Reattach the cover firmly.

\* Test procedure: Press the remote controller power button and press again and hold to power on the remote controller.

In DJI Agras, tap , and select Network Diagnostics. The dongle and SIM card are functioning properly if the status of all the devices in the network chain are shown in green.

## Mounting the RTK Dongle

When using the RTK planning method to plan the operation area, attach the RTK dongle to the USB-A port on the remote controller.

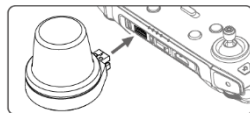

## Checking the Battery Levels

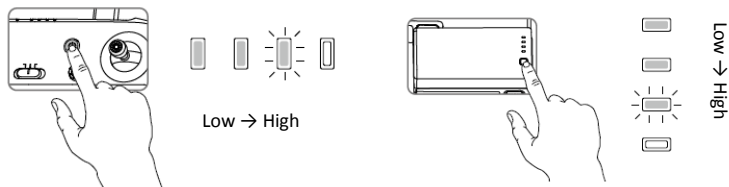

Press the power button on the remote controller once to check the internal battery level. Press once and press again and hold for two seconds to power on or off.

Press the battery level button on the external Intelligent Battery once to check the battery level.



- When using an external Intelligent Battery, it is still necessary to make sure that the internal battery has some power. Otherwise, the remote controller cannot be powered on.

## Adjusting the Antennas

Lift the antennas and adjust them. The strength of the remote controller signal is affected by the position of the antennas. For an optimal connection between the remote controller and aircraft, make sure the angle between the antennas and the back of the remote controller is 80° or 180°.

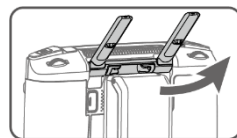

Try to keep the aircraft inside the optimal transmission zone. If the signal is weak, adjust the antennas or fly the aircraft closer.

Optimal Transmission Zone

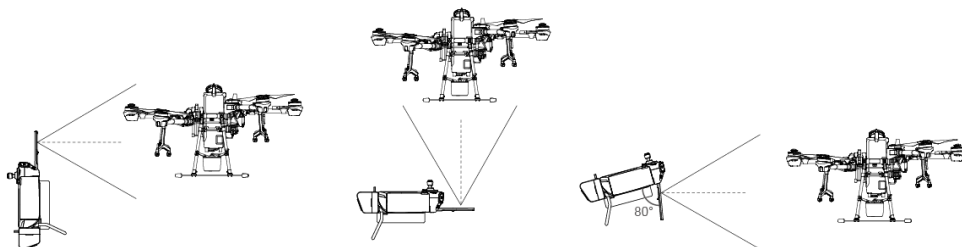





- Avoid using wireless devices that use the same frequency bands as the remote controller.
- If the RTK dongle is used for RTK planning, the module should be disconnected from the remote controller after planning is completed. Otherwise, it will affect the communication performance of the remote controller.

## 4. Getting Ready for Takeoff



- Place the aircraft on open, flat ground with the rear of the aircraft facing toward you.
- Make sure that the propellers are securely mounted, there are no foreign objects in or on the motors and propellers, the propeller blades and arms are unfolded, and the arm locks are firmly fastened.
- Make sure that the spray tank and flight battery are firmly in place.
- Pour liquid into the spray tank and tighten the cover. Make sure that the four lines on the cover are aligned to the horizontal or vertical direction.
- Power on the remote controller, make sure that the DJI Agras app is open, and power on the aircraft.

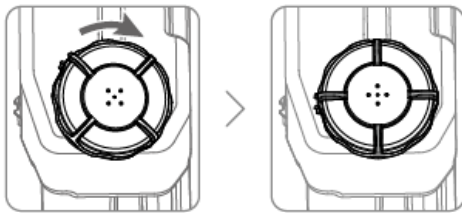

- When using for the first time, activate the aircraft using the DJI Agras app. A DJI account and internet connection are required.



### Calibrating the Compass

When the app prompts that compass calibration is required, tap , then , and swipe to the bottom. Select Advanced Settings, then IMU, and Compass Calibration. Tap Calibration in Compass Calibration and follow the on-screen instructions.



### Calibrating the Flow Meter

**Make sure to calibrate the flow meter before using for the first time. Otherwise, the spraying performance may be adversely affected.**

A. Preparation: Discharging the Bubbles in the Hoses

- ① Fill the spray tank with approximately 10 L of water.
- ② Use the automatic bubbles discharge function to discharge the bubbles according to the descriptions in the Discharging the Bubbles in the Hoses section below. Users can also manually discharge the bubbles. Press the spray button to spray the bubbles and press the button again once all bubbles are discharged.

B. Calibration

① In the app, tap Execute Task to enter Operation View. Tap  , then  , swipe down, and tap Calibration on the right of the flow meter calibration section.

② Tap Start Calibration to begin. Calibration will be complete after 25 seconds and the results are displayed in the app.

- Users can proceed once calibration is completed successfully.
- If calibration fails, tap “?” to view and resolve the problem. Recalibrate once the problem is resolved.

### Discharging the Bubbles in the Hoses

The T30 features an automatic bubbles discharge function. When it is necessary to discharge bubbles, press and hold the spray button for two seconds. The aircraft will discharge automatically until the bubbles are fully discharged.

## 5. Flight

In the app, go to Operation View. Make sure that there is a strong GNSS signal and the system status bar indicates Manual Route (GNSS) or Manual Route (RTK). \* Otherwise, the aircraft cannot take off.

In order for the aircraft to automatically take off and perform an operation, it is recommended to create a plan for a field and select an operation before takeoff. Refer to the Starting Operations section for more information. For other scenarios, take off and land manually.

\* RTK positioning is recommended. In the app, go to Operation View, tap  , then RTK to enable Aircraft RTK Positioning, and select a method for receiving RTK signals.

### Takeoff

Perform a Combination Stick Command (CSC) and push the throttle stick up to take off.

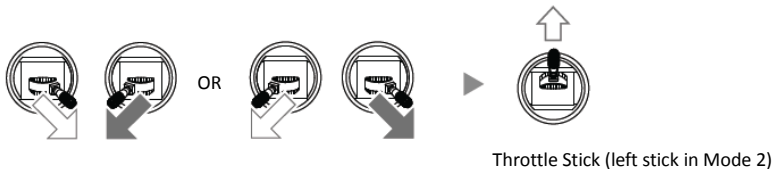

### Landing

To land, pull down on the throttle stick to descend until the aircraft touches the ground. There are two methods to stop the motors.

Method 1: when the aircraft has landed, push and hold the throttle stick down. The motors will stop after three seconds.

Throttle Stick

Method 2: When the aircraft has landed, push the throttle stick down, and perform the same CSC that was used to start the motors. Release both sticks once the motors have stopped.



Method 1



OR



Method 2



- Spinning propellers can be dangerous. Stay away from spinning propellers and motors. DO NOT start the motors in confined spaces or where there are people nearby.
- Maintain control of the remote controller as long as the motors are running.
- DO NOT stop the motors mid-flight unless in an emergency situation where doing so will reduce the risk of damage or injury.
- It is recommended to use Method 1 to stop the motors. When using Method 2 to stop the motors, the aircraft may roll over if it is not completely grounded. Use Method 2 with caution.
- After landing, power off the aircraft before turning off the remote controller.

## Starting Operations

After the operation area and obstacles have been measured and settings have been configured, the DJI Agras app uses a built-in intelligent operation planning system to produce a flight route based on the user's input. Users can invoke an operation after planning a field. The aircraft will begin the operation automatically and follow the planned flight route. In scenarios with complicated terrain, Phantom 4 RTK and DJI TERRA™ can be used to plan flight routes and import routes to the DJI Agras app for operation. Refer to the Agras T30 User Manual for more information.

## Field Planning

The DJI Agras app supports flight route planning by flying the aircraft to waypoints, obstacles, and calibration points or by walking to these points carrying a remote controller, a remote controller with an RTK dongle, or an RTK device. The following route has been planned by walking to the points with a remote controller that has a RTK dongle connected. Before planning, make sure that the RTK high precision positioning module is mounted to the remote controller.



Power on the remote controller.

Tap Plan Field, select Walk with RTK, and Walk with RTK Dongle.

In RTK settings, select a method for receiving RTK signals and configure the corresponding settings. Make sure the aircraft status bar at the top of the screen is green.



Walk with the remote controller alongside the boundary of the operation area and tap Add Waypoint C2 at turning points.

Walk to each obstacle in turn and tap Obstacle Mode C1.\*

Walk around the obstacle and tap Add Obstacle C2 at several points around the obstacle.\*



Tap Waypoint C1 to return to add edge points to the operation area.

Walk to the location of each calibration point and tap Calibration Point.

The waypoints and flight route can be edited. Fine-tune waypoint positions, configure distance and line spacing, and adjust the route direction by tapping or dragging the icon .

Save the field plan.

\* Any obstacles in or out of the operation area can be marked.

Once you have finished planning, press the back button on the remote controller to return to the home screen.



●The calibration points are used to offset the bias of the flight route caused by the positioning difference. Choose at least one existing landmark as the fixed reference point for calibration when executing the same operation. If none are available, use an easily identifiable object such as a metal stake.

## Performing an Operation



Take the aircraft to one of the calibration points.

Tap Execute Task in the home screen of the app.

Tap  and select the field from the field list.

Tap Edit to edit the waypoints and flight route again.



Tap Use and tap Rectify Offset.

Tap Start.

Set operation parameters and confirm.

Set the auto-takeoff height and move the slider to take off. The aircraft will perform the operation automatically.



- Only take off in open areas and set an appropriate auto-takeoff height according to the operating environment.
- An operation can be paused by moving the control stick slightly. The aircraft will hover and record the breakpoint. After which, the aircraft can be controlled manually. To continue the operation, select it again from the Executing tag in  list. The aircraft will return to the breakpoint automatically and resume the operation. Pay attention to aircraft safety when returning to a breakpoint.
- In Route Operation mode, the aircraft is able to circumvent obstacles, which is disabled by default and can be enabled in the app. If the function is enabled and the aircraft detects obstacles, the aircraft will slow down and circumvent the obstacles and return to the original flight path.
- Users can set the action the aircraft will perform after the operation is completed in the app.

## More Operation Modes and Functions

Refer to the Agras T30 User Manual for more information about the A-B Route, Manual, and Manual Plus Operation modes and on how to use functions such as Smart Supply Reminder, Operation Resumption, System Data Protection, and Empty Tank.

## 6. Maintenance

Clean all parts of the aircraft and remote controller at the end of each day of spraying:

1. Fill the spray tank with clean water or soapy water and spray the water through the nozzles until the tank is empty. Repeat the step twice more.
2. Remove the spray tank strainer, nozzle strainers, and nozzles to clean them and clear any blockage. Afterwards, immerse them in clean water for 12 hours.
3. Use a water-filled washer with a max water pressure of XX MPa to clean the aircraft body and wipe it with a soft brush or wet cloth before cleaning water residue with a dry cloth.
4. If there is dust or pesticide liquid on the motors and propellers, wipe them with a wet cloth before cleaning water residue with a dry cloth.
5. Wipe the surface and screen of the remote controller with a clean wet cloth that has been wrung out with water.

Refer to the disclaimer and safety guidelines for more information on product maintenance.

## Specifications

Product Model	3WWDZ-30A
Airframe	
Max Diagonal Wheelbase	2145 mm
Dimensions	2858×2685×790 mm (arms and propellers unfolded) 2030×1866×790 mm (arms unfolded and propellers folded)

	1170×670×857 mm (arms and propellers folded)
<b>Propulsion System</b>	
<b>Motors</b>	
Stator Size	100×18 mm
KV	77 rpm/V
Max Thrust	18.7 kg/rotor
Max Power	3600 W/rotor
Weight	756 g
<b>ESCs</b>	
Max Working Current (Continuous)	60 A
Max Working Voltage	60.9 V (14S LiPo)
<b>Foldable Propellers (R3820)</b>	
Diameter Pitch	38×20 in
Weight (Single propeller)	106 g
<b>Spraying System</b>	
<b>Spray Tank</b>	
Volume	Fully loaded: 30 L
Operating Payload	Fully loaded: 30 kg
<b>Nozzles</b>	
Model	XR11001VS (standard), XR110015VS (optional, purchase separately), TX-VK4 (optional for Orchard Form, purchase separately)
Quantity	16
Max Spray Rate	XR11001VS: 7.2 L/min, XR110015VS: 8 L/min, TX-VK4: 3.6 L/min
Spray Width	4-9 m (12 nozzles, at a height of 1.5-3 m above crops)
Droplet Size	XR11001VS: 130-250 µm, XR110015VS: 170-265 µm, TX-VK4: 110-135 µm (subject to operating environment and spray rate)
<b>Flow Meter</b>	
Measurement Range	0.25-20 L/min
Error	< ±2%
Measurable Liquid	Conductivity > 50 µS/cm (liquids such as tap water or pesticides that contain water)
<b>Omnidirectional Digital Radar</b>	
Model	RD2424R
Operating Frequency	SRRC/NCC/FCC: 24.05-24.25 GHz

	MIC/KCC/CE: 24.05-24.25 GHz
Power Consumption	12 W
Transmission Power (EIRP)	SRRC: 13 dBm; NCC/MIC/KCC/CE/FCC: < 20 dBm
Altitude Detection & Terrain Follow <sup>[1]</sup>	Altitude detection range: 1-30 m Stabilization working range: 1.5-15 m Max slope in Mountain mode: 35°
Obstacle Avoidance <sup>[1]</sup>	Obstacle sensing range: 1.5-30 m FOV: Horizontal: 360°, Vertical: ±15° Working conditions: Flying higher than 1.5 m over the obstacle at a speed lower than 7 m/s Safety limit distance: 2.5 m (distance between the front of propellers and the obstacle after braking) Obstacle avoidance direction: Omnidirectional obstacle avoidance in the horizontal direction.
IP Rating	IP67
<b>Upward Radar</b>	
Model	RD2414U
Operating Frequency	SRRC/NCC/FCC: 24.05-24.25 GHz MIC/KCC/CE: 24.05-24.25 GHz
Power Consumption	4 W
Transmission Power (EIRP)	SRRC: 13 dBm; NCC/MIC/KCC/CE/FCC: < 20 dBm
Obstacle Avoidance <sup>[1]</sup>	Obstacle sensing range: 1.5-15 m FOV: 80° Working conditions: Available during takeoff, landing, and ascending when an obstacle is more than 1.5 m above the aircraft. Safety limit distance: 2 m (distance between the highest point of the aircraft and the lowest point of the obstacle after braking) Obstacle avoidance direction: Upward
IP Rating	IP67
<b>FPV Cameras</b>	
FOV	Horizontal: 129°, Vertical: 82°
Resolution	1280×720 15-30fps
FPV Spotlights	FOV: 120°, Max brightness: 13.2 lux at 5 m of direct light

Flight Parameters	
Operating Frequency	SRRC/NCC/FCC/CE/MIC/KCC: 2.4000-2.4835 GHz SRRC/NCC/FCC/CE: 5.725-5.850 GHz <sup>[2]</sup>
Transmission Power (EIRP)	2.4 GHz SRRC/CE/MIC/KCC: 18.5 dBm, FCC/NCC: 29.5 dBm 5.8 GHz SRRC: 28.5 dBm, FCC: 20.5 dBm, CE: 12.5 dBm
Total Weight (exc. battery)	26.7 kg
Max Takeoff Weight	66.5 kg (at sea level)
Max Thrust-Weight Ratio	1.70 (takeoff weight of 66.5 kg)
Hovering Accuracy Range (with strong GNSS signal)	D-RTK enabled: Horizontal: ±10 cm, Vertical: ±10 cm D-RTK disabled: Horizontal: ±0.6 m, Vertical: ±0.3 m (Radar module enabled: ±0.1 m)
RTK/GNSS Operating Frequency	RTK: GPS L1/L2, GLONASS F1/F2, BeiDou B1/B2, Galileo E1/E5 <sup>[3]</sup> GNSS: GPS L1, GLONASS F1, Galileo E1 <sup>[3]</sup>
Battery	DJI-approved flight battery (BAX501-29000mAh-51.8V)
Max Power Consumption	11000 W
Hovering Power Consumption	1000 W (takeoff weight of 66.5 kg)
Hovering Time <sup>[4]</sup>	20.5 min (takeoff weight of 36.5 kg with an 29000 mAh battery) 7.8 min (takeoff weight of 66.5 kg with an 29000 mAh battery)
Max Tilt Angle	15°
Max Operating Speed	7 m/s
Max Flying Speed	10 m/s (with strong GNSS signal)
Max Wind Resistance	8 m/s
Max Service Ceiling Above Sea Level	4500 m
Recommended Operating Temperature	< 93%
Recommended Operating Temperature	0° to 40° C (32° to 104° F)
Remote Controller	
Model	RM500-ENT
Screen	5.5-in screen, 1920×1080, 1000 cd/m <sup>2</sup> , Android system



RAM	4GB LPDDR4
ROM	32 GB + scalable storage; microSD cards supported; Max Capacity: 128 GB. UHS-I Speed Grade 3 rating required
Built-in Battery	18650 Li-ion (5000 mAh @ 7.2 V)
GNSS	GPS+GLONASS
Power Consumption	18 W
Operating Temperature	-10° to 40° C (14° to 104° F)
Charging Environment Temperature	5° to 40° C (41° to 104° F)
Storage Temperature	-30° to 25° C (-22° to 77° F)
<b>OcuSync 2.0</b>	
Operating Frequency	SRRC/NCC/FCC/CE/MIC/KCC: 2.4000-2.4835 GHz SRRC/NCC/FCC/CE: 5.725-5.850 GHz <sup>[2]</sup>
Effective Transmission Distance (Unobstructed, free of interference)	SRRC: 5 km, FCC: 7 km, MIC/KCC/CE: 4 km
Transmission Power (EIRP)	2.4 GHz SRRC/CE/MIC/KCC: 18.5 dBm, FCC/NCC: 29.5 dBm 5.8 GHz SRRC: 28.5 dBm, FCC: 20.5 dBm, CE: 12.5 dBm
<b>Wi-Fi</b>	
Protocol	Wi-Fi Direct, Wi-Fi Display, 802.11a/g/n/ac Wi-Fi with 2×2 MIMO
Operating Frequency	2.4000-2.4835 GHz 5.150-5.250 GHz 5.725-5.850 GHz <sup>[2]</sup>
Transmission Power (EIRP)	2.4 GHz SRRC/CE: 18.5 dBm, NCC/FCC /MIC/KCC: 20.5 dBm 5.2 GHz SRRC/NCC/FCC/CE/MIC/KCC: 14 dBm, KCC: 10 dBm 5.8 GHz SRRC/NCC/FCC: 18 dBm, CE/KCC: 12 dBm
<b>Bluetooth</b>	
Protocol	Bluetooth 4.2
Operating Frequency	2.4000-2.4835 GHz

Transmission Power (EIRP)	SRRC/NCC/FCC/CE/MIC/KCC: 6.5 dBm
<b>Remote Controller Intelligent Battery</b>	
Model	WB37-4920mAh-7.6V
Battery Type	2S LiPo
Capacity	4920 mAh
Voltage	7.6 V
Energy	37.39 Wh
Charging Environment Temperature	5° to 40° C (41° to 104° F)
<b>Intelligent Battery Charging Hub</b>	
Model	WCH2
Input Voltage	17.3-26.2 V
Output Voltage and Current	8.7 V, 6 A
Operating Temperature	5° to 40° C (41° to 104° F)
<b>AC Power Adapter</b>	
Model	A14-057N1A
Input Voltage	100-240 V, 50/60 Hz
Output Voltage	17.4 V
Rated Power	57 W

- [1] The effective radar range varies depending on the material, position, shape, and other properties of the obstacle.
- [2] Local regulations in some countries prohibit the use of the 5.8 and 5.2 GHz frequencies. In some countries, the 5.2 GHz frequency band is only allowed for indoor use.
- [3] Support for Galileo will be available at a later date.
- [4] Hovering time acquired at sea level with wind speeds lower than 3 m/s.

**FCC Compliance Notice**

This device complies with Part 15 of the FCC Rules. Operation is subject to the following two conditions: (1) This device may not cause harmful interference, and (2) This device must accept any interference received, including interference that may cause undesired operation.

Any changes or modifications not expressly approved by the party responsible for compliance could void the user's authority to operate the equipment.

This equipment has been tested and found to comply with the limits for a Class B digital device, pursuant to part 15 of the FCC Rules. These limits are designed to provide reasonable protection against harmful interference in a residential installation. This equipment generates, uses and can radiate radio frequency energy and, if not installed and used in accordance with the instructions, may cause harmful interference to radio communications. However, there is no guarantee that interference will not occur in a particular installation. If this equipment does cause harmful interference to radio or television reception, which can be determined by turning the equipment off and on, the user is encouraged to try to correct the interference by one or more of the following measures:

- Reorient or relocate the receiving antenna.
- Increase the separation between the equipment and receiver.
- Connect the equipment into an outlet on a circuit different from that to which the receiver is connected.
- Consult the dealer or an experienced radio/TV technician for help.

**RF Exposure Information****Aircraft**

The aircraft complies with FCC radiation exposure limits set forth for an uncontrolled environment. In order to avoid the possibility of exceeding the FCC radio frequency exposure limits, human proximity to the antenna shall not be less than 20cm during normal operation. This transmitter must not be co-located or operating in conjunction with any other antenna or transmitter.

**Remote Controller**

This equipment complies with FCC radiation exposure limits set forth for an uncontrolled environment. End user must follow the specific operating instructions for satisfying RF exposure compliance. This transmitter must not be co-located or operating in conjunction with any other antenna or transmitter.

The portable device is designed to meet the requirements for exposure to radio waves established by the Federal Communications Commission (USA). These requirements set a SAR limit of 1.6 W/kg averaged over one gram of tissue.

The highest SAR value reported under this standard during product certification for use when properly worn on the body.

### **ISED Compliance Notice**

This device contains licence-exempt transmitter(s)/receiver(s) that comply with Innovation, Science and Economic Development Canada's licence-exempt RSS(s). Operation is subject to the following two conditions: (1) This device may not cause interference. (2) This device must accept any interference, including interference that may cause undesired operation of the device.

L'émetteur/récepteur exempt de licence contenu dans le présent appareil est conforme aux CNR d'Innovation, Sciences et Développement économique Canada applicables aux appareils radio exempts de licence. L'exploitation est autorisée aux deux conditions suivantes : (1) L'appareil ne doit pas produire de brouillage; (2) L'appareil doit accepter tout brouillage radioélectrique subi, même si le brouillage est susceptible d'en compromettre le fonctionnement.

### **Aircraft**

This equipment complies with RSS-102 radiation exposure limits set forth for an uncontrolled environment. This equipment should be installed and operated with minimum distance 20cm between the radiator and your body. This transmitter must not be co-located or operating in conjunction with any other antenna or transmitter.

Cet équipement est conforme aux limites d'exposition aux radiations CNR-102 établies pour un environnement non contrôlé. Cet équipement doit être installé et utilisé avec une distance minimale de 20 cm entre le radiateur et votre corps.

### **Remote Controller**

This equipment complies with ISED radiation exposure limits set forth for an uncontrolled environment. End user must follow the specific operating instructions for satisfying RF exposure compliance. This transmitter must not be co-located or operating in conjunction with any other antenna or transmitter. The portable device is designed to meet the requirements for exposure to radio waves established by the ISED.

These requirements set a SAR limit of 1.6 W/kg averaged over one gram of tissue. The highest SAR value reported under this standard during product certification for use when properly worn on the body.

Cet équipement est conforme aux limites d'exposition aux rayonnements ISED établies pour un environnement non contrôlé. L'utilisateur final doit suivre les instructions spécifiques pour satisfaire les normes. Cet émetteur ne doit pas être co-implanté ou fonctionner en conjonction avec toute autre antenne ou transmetteur. Le dispositif portatif est conçu pour répondre aux exigences d'exposition aux ondes radio établie par le développement énergétique DURABLE.

Ces exigences un SAR limite de 1,6 W/kg en moyenne pour un gramme de tissu. La valeur SAR la plus élevée signalée en vertu de cette norme lors de la certification de produit à utiliser lorsqu'il est correctement porté sur le corps.

## KCC Compliance Notice

“ 해당 무선설비는 운용 중 전파혼신 가능성이 있으므로 인명안전과 관련된 서비스는 할 수 없습니다. ”  
“ 해당 무선설비는 운용 중 전파혼신 가능성이 있음 ”



**EU Compliance Statement:** SZ DJI TECHNOLOGY CO., LTD. hereby declares that this device is in compliance with the essential requirements and other relevant provisions of the Directive 2014/53/EU.

A copy of the EU Declaration of Conformity is available online at [www.dji.com/euro-compliance](http://www.dji.com/euro-compliance)

EU contact address: DJI GmbH, Industriestrasse 12, 97618, Niederlauer, Germany

**Declaración de cumplimiento UE:** SZ DJI TECHNOLOGY CO., LTD. por la presente declara que este dispositivo cumple los requisitos básicos y el resto de provisiones relevantes de la Directiva 2014/53/EU.

Hay disponible online una copia de la Declaración de conformidad UE en [www.dji.com/euro-compliance](http://www.dji.com/euro-compliance)

Dirección de contacto de la UE: DJI GmbH, Industriestrasse 12, 97618, Niederlauer, Germany

**EU-verklaring van overeenstemming:** SZ DJI TECHNOLOGY CO., LTD. verklaart hierbij dat dit apparaat voldoet aan de essentiële vereisten en andere relevante bepalingen van Richtlijn 2014/53/EU.

De EU-verklaring van overeenstemming is online beschikbaar op [www.dji.com/euro-compliance](http://www.dji.com/euro-compliance)

Contactadres EU: DJI GmbH, Industriestrasse 12, 97618, Niederlauer, Germany

**Declaração de conformidade da UE:** A SZ DJI TECHNOLOGY CO., LTD. declara, através deste documento, que este dispositivo está em conformidade com os requisitos essenciais e outras disposições relevantes da Diretiva 2014/53/EU.

Existe uma cópia da Declaração de conformidade da UE disponível online em [www.dji.com/euro-compliance](http://www.dji.com/euro-compliance)

Endereço de contacto na UE: DJI GmbH, Industriestrasse 12, 97618, Niederlauer, Germany

**Dichiarazione di conformità UE:** SZ DJI TECHNOLOGY CO., LTD. dichiara che il presente dispositivo è conforme ai requisiti essenziali e alle altre disposizioni rilevanti della direttiva 2014/53/EU.

Una copia della dichiarazione di conformità UE è disponibile online all'indirizzo Web [www.dji.com/euro-compliance](http://www.dji.com/euro-compliance)

Indirizzo di contatto UE: DJI GmbH, Industriestrasse 12, 97618, Niederlauer, Germany

**Déclaration de conformité UE :** Par la présente, SZ DJI TECHNOLOGY CO., LTD déclare que cet appareil est conforme aux principales exigences et autres clauses pertinentes de la directive européenne 2014/53/EU.

Une copie de la déclaration de conformité UE est disponible sur le site [www.dji.com/euro-compliance](http://www.dji.com/euro-compliance)

Adresse de contact pour l'UE : DJI GmbH, Industriestrasse 12, 97618, Niederlauer, Germany

#### PRÉCAUTIONS D'USAGE DE L'APPAREIL

N'utilisez pas l'appareil dans un hôpital, un avion ou un équipement automobile en raison des radiofréquences qui peuvent produire des interférences

• Maintenez une distance minimale de 15 cm entre votre appareil et un stimulateur cardiaque pour éviter toute interférence

Eloigner les équipements radioélectriques du ventre des femmes enceintes.

Eloigner les équipements radioélectriques du bas-ventre des adolescents.

Le débit d'absorption spécifique (DAS) local quantifie l'exposition de l'utilisateur aux ondes électromagnétiques de l'équipement concerné. Le DAS maximal autorisé est de 2 W/ kg pour la tête et le tronc et de 4 W/ kg pour les membres.

La ou les valeurs du débit d'absorption spécifique des XXXX (型号):

DAS tronc: XXXX W/ kg

DAS membres: XXXX W/ kg

**EU-Compliance:** Hiermit erklärt SZ DJI TECHNOLOGY CO., LTD., dass dieses Gerät den wesentlichen Anforderungen und anderen einschlägigen Bestimmungen der EU-Richtlinie 2014/53/EU entspricht.

Eine Kopie der EU-Konformitätserklärung finden Sie online auf [www.dji.com/euro-compliance](http://www.dji.com/euro-compliance)

Kontaktadresse innerhalb der EU: DJI GmbH, Industriestrasse 12, 97618, Niederlauer, Germany

**Декларация за съответствие на ЕС:** SZ DJI TECHNOLOGY CO., LTD. декларира, че това устройство отговаря на основните изисквания и другите приложими разпоредби на Директива 2014/53/ЕС.

Копие от Декларацията за съответствие на ЕС ще намерите онлайн на адрес [www.dji.com/euro-compliance](http://www.dji.com/euro-compliance)

Адрес за контакт за ЕС: DJI GmbH, Industriestrasse 12, 97618, Niederlauer, Германия

**Prohlášení o shodě pro EU:** Společnost SZ DJI TECHNOLOGY CO., LTD. tímto prohlašuje, že tohle zařízení vyhovuje základním požadavkům a dalším příslušným ustanovením směrnice 2014/53/EU.

Kopie prohlášení o shodě pro EU je k dispozici on-line na webu [www.dji.com/euro-compliance](http://www.dji.com/euro-compliance)

Kontaktní adresa v EU: DJI GmbH, Industriestrasse 12, 97618, Niederlauer, Německo

**EU-overensstemmelseserklæring:** SZ DJI TECHNOLOGY CO., LTD. erklærer hermed, at denne enhed er i overensstemmelse med de væsentlige krav og andre relevante bestemmelser i direktiv 2014/53/EU.

Der er en kopi af EU-overensstemmelseserklæringen tilgængelig online på [www.dji.com/euro-compliance](http://www.dji.com/euro-compliance)

EU-kontaktadresse: DJI GmbH, Industriestrasse 12, 97618, Niederlauer, Tyskland

**Δήλωση Συμμόρφωσης EE:** Η *SZ DJI TECHNOLOGY CO., LTD.* δια του παρόντος δηλώνει ότι η συσκευή αυτή συμμορφώνεται με τις βασικές απαιτήσεις και άλλες σχετικές διατάξεις της Οδηγίας 2014/53/EE.

Αντίγραφο της Δήλωσης Συμμόρφωσης EE διατίθεται ηλεκτρονικά στη διεύθυνση [www.dji.com/euro-compliance](http://www.dji.com/euro-compliance)

Διεύθυνση επικοινωνίας στην EE: DJI GmbH, Industriestrasse 12, 97618, Niederlauer, Γερμανία

**Eli vastavuskinnitus** Käesolevaga teatab *SZ DJI TECHNOLOGY CO., LTD.*, et see seade on kooskõlas direktiivi 2014/53/EL oluliste nõuete ja muude asjakohaste sätetega.

Eli vastavusdeklaratsiooni koopia on kättesaadav veebis aadressil [www.dji.com/euro-compliance](http://www.dji.com/euro-compliance)

Kontaktadress ELis: DJI GmbH, Industriestrasse 12, 97618, Niederlauer, Saksamaa

**Pranešimas dėl atitikties ES reikalavimams** Bendrovė „*SZ DJI TECHNOLOGY CO., LTD.*“ tvirtina, kad šis prietaisas atitinka pagrindinius 2014/53/ES direktyvos reikalavimus ir kitas susijusias nuostatas.

ES atitikties deklaracijos kopiją galite rasti adresu [www.dji.com/euro-compliance](http://www.dji.com/euro-compliance)

ES kontaktinis adresas: „DJI GmbH“, Industriestrasse 12, 97618, Niederlauer, Germany (Vokietija)

**ES atbilstības paziņojums:** *SZ DJI TECHNOLOGY CO., LTD.* ar šo apliecina, ka šī ierīce atbilst direktīvas 2014/53/ES pamatprasībām un pārējiem būtiskiem nosacījumiem.

ES atbilstības deklarācijas kopija pieejama tiešsaistē vietnē [www.dji.com/euro-compliance](http://www.dji.com/euro-compliance)

ES kontaktadrese: DJI GmbH, Industriestrasse 12, 97618, Niederlauer, Vācija

**EU:n vaatimustenmukaisuusvakuutus:** *SZ DJI TECHNOLOGY CO., LTD.* ilmoittaa täten, että tämä laite on direktiivin 2014/53/EU olennaisten vaatimusten ja sen muiden asiaankuuluvien ehtojen mukainen.

Kopio EU:n vaatimustenmukaisuusvakuutuksesta on saatavana verkossa osoitteessa [www.dji.com/euro-compliance](http://www.dji.com/euro-compliance)

Yhteystiedot EU:ssa: DJI GmbH, Industriestrasse 12, 97618, Niederlauer, Germany

**RÁITEAS Comhlíonta an AE:** Dearbhaíonn *SZ DJI TECHNOLOGY CO., LTD.* leis seo go bhfuil an gléas seo de réir na gceanglas riachtanach agus na bhforálacha ábhartha eile sa Treoir 2014/53/AE.

Tá coip de Dhearbhú Comhréireachta an AE ar fáil ar líne ag [www.dji.com/euro-compliance](http://www.dji.com/euro-compliance)

Seoladh teagmhála san AE: DJI GmbH, Industriestrasse 12, 97618, Niederlauer, Germany

**Dikjarazjoni ta' Konformità tal-UE:** *SZ DJI TECHNOLOGY CO., LTD.* hawnhekk tididikjara li dan l-apparat huwa konformi mar-rewkiziti essenzjali u ma' dispozizzjonijiet relevanti oħra tad-Direttiva 2014/53/UE.

Kopja tad-Dikjarazjoni ta' Konformità tal-UE hija disponibbli onlajn fis-sit [www.dji.com/euro-compliance](http://www.dji.com/euro-compliance)

Indirizz ta' kuntatt tal-UE: DJI GmbH, Industriestrasse 12, 97618, Niederlauer, il-Ġermanja

**Declarația UE de conformitate:** Prin prezenta, *SZ DJI TECHNOLOGY CO., LTD.* declară faptul că acest dispozitiv este

conform cu cerințele esențiale și celelalte prevederi relevante ale Directivei 2014/53/UE.

Un exemplar al Declarației UE de conformitate este disponibil online, la adresa [www.dji.com/euro-compliance](http://www.dji.com/euro-compliance)

Adresa de contact pentru UE: DJI GmbH, Industriestrasse 12, 97618, Niederlauer, Germania

**Izjava EU o skladnosti:** Družba *SZ DJI TECHNOLOGY CO., LTD.* izjavlja, da ta naprava ustreza osnovnim zahtevam in drugim ustreznim določbam Direktive 2014/53/EU.

Kopija izjave EU o skladnosti je na voljo na spletu na [www.dji.com/euro-compliance](http://www.dji.com/euro-compliance)

Kontaktni naslov EU: DJI GmbH, Industriestrasse 12, 97618, Niederlauer, Nemčija

**EU Izjava o skladnosti:** Tvrška *SZ DJI TECHNOLOGY CO., LTD.* izjavlja, da je ovaj uređaj izrađen u skladu s osnovnim zahtjevima i ostalim relevantnim odredbama Direktive 2014/53/EU.

Kopija EU Izjave o skladnosti dostupna je na mrežnoj stranici [www.dji.com/euro-compliance](http://www.dji.com/euro-compliance)

Adresa EU kontakta: DJI GmbH, Industriestrasse 12 97618, Niederlauer, Njemačka

**Vyhlasenie o zhode EÚ:** *SZ DJI TECHNOLOGY CO., LTD.* týmto vyhlasuje, že toto zariadenie je v zhode so základnými požiadavkami a ďalšími relevantnými ustanoveniami smernice 2014/53/EÚ.

Kópia tohto Vyhlasenia o zhode EÚ je k dispozícii online na [www.dji.com/euro-compliance](http://www.dji.com/euro-compliance)

Kontaktná adresa v EÚ: DJI GmbH, Industriestrasse 12, 97618, Niederlauer, Nemecko

**Deklaracja zgodności UE:** Firma *SZ DJI TECHNOLOGY CO., LTD.* niniejszym oświadcza, że przedmiotowe urządzenie jest zgodne z zasadniczymi wymogami i innymi stosownymi postanowieniami dyrektywy 2014/53/UE.

Kopię deklaracji zgodności UE można znaleźć w Internecie na stronie [www.dji.com/euro-compliance](http://www.dji.com/euro-compliance)

Adres do kontaktu w UE: DJI GmbH, Industriestrasse 12, 97618, Niederlauer, Niemcy

**EU megfeleléségi nyilatkozat:** A *SZ DJI TECHNOLOGY CO., LTD.* ezúton megerősíti, hogy ez az eszköz megfelel a 2014/53/EU Irányelv alapvető követelményeinek és más vonatkozó rendelkezéseinek.

Az EU megfeleléségi nyilatkozat másolata elérhető a [www.dji.com/euro-compliance](http://www.dji.com/euro-compliance) oldalon

EU kapcsolati cím: DJI GmbH, Industriestrasse 12, 97618, Niederlauer, Németország

**EU-försäkran om efterlevnad:** *SZ DJI TECHNOLOGY CO., LTD.* härmed förklarar att denna enhet uppfyller de väsentliga kraven och andra relevanta bestämmelser i direktivet 2014/53/EU.

En kopia av EU-försäkran om efterlevnad finns att tillgå online på adressen [www.dji.com/euro-compliance](http://www.dji.com/euro-compliance)

Kontaktadress EU: DJI GmbH, Industriestrasse 12, 97618, Niederlauer, Tyskland

**Yfirlýsing um fylgni við reglur ESB:** *SZ DJI TECHNOLOGY CO., LTD.* lýsir hér með yfir að þetta tæki hlíti mikilvægum kröfum og öðrum viðeigandi ákvæðum tilskipunar 2014/53/ESB.



Nálgast má eintak af ESB-samræmisfyrirlysingunni á netinu á [www.dji.com/euro-compliance](http://www.dji.com/euro-compliance)

Heimilisfang ESB-tengiliðar: DJI GmbH, Industriestrasse 12, 97618, Niederlauer, Germany

**AB Uygunluk Beyanı:** *SZ DJI TECHNOLOGY CO., LTD.* bu belge ile bu cihazın temel gerekliliklere ve 2014/53/EU sayılı

Direktifin diğer ilgili hükümlerine uygun olduğunu beyan eder.

AB Uygunluk Beyanının bir kopyasına [www.dji.com/euro-compliance](http://www.dji.com/euro-compliance) adresinden çevrim içi olarak ulaşılabilir

AB için iletişim adresi: DJI GmbH, Industriestrasse 12, 97618, Niederlauer, Almanya

CAUTION: RISK OF EXPLOSION IF BATTERY IS REPLACED BY AN INCORRECT TYPE. DISPOSE OF USED BATTERIES ACCORDING TO THE INSTRUCTIONS

#### **Environmentally friendly disposal**



Old electrical appliances must not be disposed of together with the residual waste, but have to be disposed of separately. The disposal at the communal collecting point via private persons is for free. The owner of old appliances is responsible to bring the appliances to these collecting points or to similar collection points. With this little personal effort, you contribute to recycle valuable raw materials and the treatment of toxic substances.

#### **Umweltfreundliche Entsorgung**

Elektro-Altgeräte dürfen nicht mit gewöhnlichem Abfall entsorgt werden und müssen separat entsorgt werden. Die Entsorgung an kommunalen Sammelstellen ist für Privatpersonen kostenlos. Die Eigentümer der Altgeräte sind für den Transport zu den Sammelstellen verantwortlich. Durch diesen geringen Aufwand können Sie zur Wiederverwertung von wertvollen Rohmaterialien beitragen und dafür sorgen, dass umweltschädliche und giftige Substanzen ordnungsgemäß unschädlich gemacht werden.

#### **Tratamiento de residuos responsable con el medio ambiente**

Los aparatos eléctricos viejos no pueden desecharse junto con los residuos orgánicos, sino que deben ser desechados por separado. Existen puntos limpios donde los ciudadanos pueden dejar estos aparatos gratis. El propietario de los aparatos viejos es responsable de llevarlos a estos puntos limpios o similares puntos de recogida. Con este pequeño esfuerzo estás contribuyendo a reciclar valiosas materias primas y al tratamiento de residuos tóxicos.

#### **Mise au rebut écologique**

Les appareils électriques usagés ne doivent pas être éliminés avec les déchets résiduels. Ils doivent être éliminés séparément. La mise au rebut au point de collecte municipal par l'intermédiaire de particuliers est gratuite. Il incombe au

propriétaire des appareils usagés de les apporter à ces points de collecte ou à des points de collecte similaires. Avec ce petit effort personnel, vous contribuez au recyclage de matières premières précieuses et au traitement des substances toxiques.

### **Smaltimento ecologico**

I vecchi dispositivi elettrici non devono essere smaltiti insieme ai rifiuti residui, ma devono essere smaltiti separatamente. Lo smaltimento da parte di soggetti privati presso i punti di raccolta pubblici è gratis. È responsabilità del proprietario dei vecchi dispositivi portarli presso tali punti di raccolta o punti di raccolta analoghi. Grazie a questo piccolo impegno personale contribuirete al riciclo di materie prime preziose e al corretto trattamento di sostanze tossiche.

### **Milieuvriendelijk afvoeren**

Oude elektrische apparaten mogen niet worden weggegooid samen met het restafval, maar moeten afzonderlijk worden afgevoerd. Afvoeren via het gemeentelijke inzamelpunt is gratis voor particulieren. De eigenaar van oude toestellen is verantwoordelijk voor het inleveren van de apparaten op deze of vergelijkbare inzamelpunten. Met deze kleine persoonlijke inspanning lever je een bijdrage aan de recycling van waardevolle grondstoffen en de verwerking van giftige stoffen.

### **Eliminação ecológica**

Os aparelhos elétricos antigos não podem ser eliminados juntamente com os materiais residuais. Têm de ser eliminados separadamente. A eliminação no ponto de recolha público através de entidades particulares é gratuita. É da responsabilidade do proprietário de aparelhos antigos levá-los a estes pontos de recolha ou a pontos de recolha semelhantes. Com este pequeno esforço pessoal, contribui para a reciclagem de matérias-primas úteis e para o tratamento de substâncias tóxicas.

### **Изхвърляне с оглед опазване на околната среда**

Старите електрически уреди не трябва да се изхвърлят заедно с битовите отпадъци, а отделно. Изхвърлянето в общинския пункт за събиране на отпадъци от частни лица е безплатно. Собственикът на старите уреди е отговорен за пренасянето на уредите до тези или до подобни събирателни пунктове. С това малко собствено усилие допринасяте за рециклирането на ценни суровини и за обработката на токсични вещества.

### **Ekologicky šetrná likvidace**

Stará elektrická zařízení nesmějí být likvidována spolu se zbytkovým odpadem, ale musí být likvidována samostatně. Likvidace na komunálních sběrných místech prostřednictvím soukromých osob je bezplatná. Vlastník starých zařízení odpovídá za to, že je donese do těchto sběrných míst nebo na obdobná sběrná místa. Tímto můžete přispět k recyklaci hodnotných surovin a zpracování toxických látek.

### **Miljøvenlig bortscaffelse**

Gamle elektriske apparater må ikke bortscaffes sammen med restaffald, men skal bortscaffes separat. Bortscaffelse på et fælles indsamlingssted er gratis for privatpersoner. Ejere af gamle apparater er ansvarlige for at bringe apparater hen til disse indsamlingssteder eller til lignende indsamlingssteder. Med denne lille personlige indsats bidrager du til genanvendelse af værdifulde råvarer og behandlingen af giftige stoffer.

### **Απόρριψη φιλική προς το περιβάλλον**

Oι παλιές ηλεκτρικές συσκευές δεν πρέπει να απορρίπτονται μαζί με τα υπολειμματικά απόβλητα, αλλά ξεχωριστά. Η απόρριψη στο δημοτικό σημείο συλλογής μέσω ιδιωτών γίνεται χωρίς χρέωση. Ο κάτοχος παλιών συσκευών είναι υπεύθυνος για τη μεταφορά των συσκευών σε αυτά ή παρόμοια σημεία συλλογής. Μέσω της ατομικής σας προσπάθειας, συμβάλλετε στην ανακύκλωση πολύτιμων πρώτων υλών και την επεξεργασία των τοξικών ουσιών.

### **Keskonnasäästlik kasutuselt kõrvaldamine**

Vanu elektriseadmeid ei tohi ära visata koos olmejäätmetega, vaid tuleb koguda ja kasutuselt kõrvaldada eraldi. Kohaliku omavalitsuse elektroonikaromude kogumispunktis on äraandmine eraisikutele tasuta. Vanade seadmete sellistesse või sarnastesse kogumispunktidesse toimetamise eest vastutavad seadmete omanikud. Selle väikese isikliku panusega aitate kaasa väärtusliku toorme ringlussevõtule ja mürgiste ainete töötlemisele.

### **Utilizavimas nekenkiant aplinkai**

Senų elektrinių prietaisų negalima išmesti kartu su buitinėmis atliekomis; juos būtina utilizuoti atskirai. Tokių prietaisų utilizavimas per komunalinius atliekų surinkimo punktus yra nemokamas. Elektrinių prietaisų savininkai utilizuojamus prietaisus privalo priduoti į atitinkamus arba analogiškus atliekų surinkimo punktus. Tokiu būdu, įdėdami nedaug pastangų, prisidėsite prie vertingų medžiagų perdirbimo ir aplinkos apsaugojimo nuo toksinių medžiagų.

### **Videi draudzīga atkritumu likvidēšana**

Vecas elektriskās ierīces nedrīkst likvidēt kopā ar pārējiem atkritumiem, bet tās jālikvidē atsevišķi. Privatpersonām atkritumu likvidēšana komunālajā savākšanas punktā ir bez maksas. Veco ierīču īpašnieks ir atbildīgs par ierīču nogādāšanu šajos savākšanas punktos vai līdzīgos savākšanas punktos. Ar šīm nelielām personiskajām pūlēm jūs veicināt vērtīgu izejmateriālu pārstrādi un toksisko vielu apstrādi.

### **Hävittäminen ympäristöystävällisesti**

Vanhoja sähkölaitteita ei saa hävittää kaatopaikkajätteen mukana, vaan ne on hävitettävä erikseen. Kunnalliseen keräyspisteeseen vieminen on yksityishenkilölle ilmaista. Vanhojen laitteiden omistaja vastaa laitteiden toimittamisesta kyiseisiin keräyspisteisiin tai vastaaviin. Tällä vähäisellä henkilökohtaisella vaivalla edistät omalta osaltasi arvokkaiden raaka-

aineiden kierrätystä ja myrkyllisten aineiden käsittelyä.

### **Diúscairt neamhdhíobhálach don chomhshaoil**

Níor cheart seanghléasanna leictreacha a dhiúscairt leis an dramhaíl iarmharach, ach caithfear iad a chur de láimh astu féin. Tá an diúscairt ag an ionad bailiúcháin pobail ag daoine príobháideacha saor in aisce. Tá freagracht ar úinéir seanghléasanna na gléasanna a thabhairt chuig na hionaid bhailiúcháin sin nó chuig ionaid bhailiúcháin den chineál céanna. Le hiarracht bheag phearsanta mar sin, cuidíonn tú le hamhábhair luachmhara a athchúrsáil agus le substaintí tocsaineacha a chóireáil

### **Rimi li jirrispetta l-ambjent**

L-apparat elettriku qadim ma għandux jintrema flimkien ma' skart residwu, iżda għandu jintrema b' mod separat. Ir-rimi fil-post tal-ġbir komunali minn persuni privati huwa b'xejn. Is-sit ta' apparat qadim huwa responsabbli biex iġib l-apparat f'dawn il-postijiet tal-ġbir jew f' postijiet tal-ġbir simili. B'dan l-isforz personali žghir, inti tikkontribwixxi għar-riċiklaġġ ta' materja prima prezzjuża u għat-trattament ta' sustanzi tossiċi.

### **Eliminarea ecologică**

Aparatele electrice vechi nu trebuie aruncate odată cu deșeurile reziduale, ci trebuie eliminate separat. Eliminarea în cadrul punctului de colectare local de către persoane fizice este gratuită. Proprietarii de aparate vechi sunt responsabili pentru transportul acestora la respectivele puncte de colectare sau la alte puncte de colectare similare. Prin acest efort personal ne semnificativ, puteți contribui la reciclarea materiilor prime valoroase și la tratarea substanțelor toxice.

### **Okolju prijazno odlaganje**

Starih električnih aparatov ne smete odvreči skupaj z ostanki odpadkov, temveč ločeno. Odlaganje na komunalnem zbirnem mestu je za fizične osebe brezplačno. Lastnik starih naprav je odgovoren, da jih pripelje do teh ali podobnih zbirnih mest. S tako malo osebnega truda prispevate k recikliranju dragocenih surovin in obdelavi strupenih snovi.

### **Ekološko odlaganje**

Stari električni uređaji ne smiju se odlagati zajedno s kućnim otpadom, već ih treba odlagati odvojeno. Odlaganje na komunalnom sabirnom mjestu od strane privatnih osoba je besplatno. Vlasnik starih uređaja dužan je donijeti uređaje do tih sabirnih mjesta ili sličnih sabirnih mjesta. Ovim malim osobnim naporom doprinosite recikliranju vrijednih sirovina i pravilnoj obradi otrovnih tvari.

### **Ekologická likvidácia**

Staré elektrospotrebiče sa nesmú likvidovať spolu so zvyškovým odpadom, ale musia sa zlikvidovať samostatne. Likvidácia v komunálnom zbernom mieste prostredníctvom súkromných osôb je bezplatná. Majiteľ starých spotrebičov je

zodpovedný za prinesenie spotrebičov na tieto zberné miesta alebo na podobné zberné miesta. Týmto malým osobným úsilím prispievate k recyklovaniu cenných surovín a spracovaniu toxických látok

### **Utylizacja przyjazna dla środowiska**

Nie można usuwać starych urządzeń elektrycznych wraz z pozostałymi odpadami. Wymagają one oddzielnej utylizacji. Utylizacja przez osoby prywatne w punkcie zbiórki odpadów komunalnych jest darmowa. Właściciel starych urządzeń jest odpowiedzialny za dostarczenie ich do takich lub podobnych punktów zbiórki. Zadając sobie tak niewielki trud, przyczyniasz się do recyklingu cennych surowców i odpowiedniego postępowania z substancjami toksycznymi.

### **Környezetbarát hulladékkezelés**

A régi elektromos készülékeket nem szabad a nem szelektíven gyűjtött hulladékkal együtt kidobni, hanem a hulladékkezelésüket elkülönítve kell végezni. A közösségi gyűjtőpontokon a magánszemélyek ingyenesen leadhatják ezeket. A régi készülékek tulajdonosai felelnek azért, hogy a készülékeket ezekre a gyűjtőpontokra, vagy más gyűjtőpontokra elhozzák. Ezzel a kis személyes erőfeszítéssel Ön is hozzájárul az értékes nyersanyagok újrahasznosításához és a mérgező anyagok kezeléséhez.

### **Miljøvenlig hantering av avfall**

Gamla elektriska apparater får inte kasseras tillsammans med restavfallet utan måste kasseras separat. Kassering på den lokala insamlingsplatsen för privatpersoner är gratis. Ägaren av gamla apparater ansvarar för att ta apparaterna till dessa insamlingsplatser eller till liknande insamlingsplatser. Med denna lilla personliga insats bidrar du till återvinning av värdefulla råvaror och hantering av giftiga ämnen.

### **Umhverfisvæn förgun**

Ekki má farga gömlum raftækjum með úrgangsléifum, heldur þarf að farga þeim sérstaklega. Förgun á almennum söfnunarstöðum er ókeypis fyrir einstaklinga. Eigandi gamalla tækja ber ábyrgð á að koma með tækin á þessa söfnunarstaði eða á svipaða söfnunarstaði. Með þessu litla persónulega átaki stuðlar þú að endurvinnslu verðmætra hráefna og meðferð eitrufefna.

### **Çevre dostu bertaraf**

Eski elektrikli cihazlar, diğer atıklarla birlikte bertaraf edilmemelidir, ayrıca atılmalıdır. Özel kişiler aracılığıyla genel toplama noktasına bertaraf işlemi ücretsiz olarak yapılmaktadır. Eski cihazların sahibi, cihazları bu toplama noktalarına veya benzer toplama noktalarına getirmekten sorumludur. Bu az miktardaki kişisel çabayla, değerli ham maddelerin geri dönüştürülmesine ve toksik maddelerin işleme alınmasına katkıda bulunmuş olursunuz.

This device is restricted to indoor use when operating in the 5150-5250MHz frequency range in all EU/EFTA member states

and Turkey.

Im Frequenzbereich 5150 – 5250 MHz darf dieses Gerät in allen EU/EFTA-Mitgliedstaaten und der Türkei nur innerhalb von Gebäuden verwendet werden.

Este dispositivo está limitado a su uso en interiores cuando esté funcionando en el rango de frecuencia de 5150-5250 MHz en todos los estados miembros de la UE/AELC y Turquía.

Cet appareil est réservé à un usage en intérieur dans une plage de fréquence de 5 150 à 5 250 MHz dans tous les pays membres de l'Union Européenne et de l'Association européenne de libre-échange, ainsi qu'en Turquie.

Il presente dispositivo è limitato all'uso in ambienti interni se utilizzato nell'intervallo di frequenze di funzionamento 5150-5250 MHz in tutti gli stati dell'UE/AELS e in Turchia.

Dit apparaat mag in landen van de EU/EFTA en Turkije alleen in binnenruimtes worden gebruikt wanneer het frequentiebereik 5150-5250 MHz is ingesteld.

Este dispositivo está restrito para uso em áreas internas ao operar na faixa de frequência de 5150-5250MHz em todos os estados-membros da UE/EFTA e Turquia.

Использование данного устройства в частотном диапазоне 5150-5250 МГц разрешается только в помещениях во всех странах, входящих в ЕС/ЕАСТ, а также в Турции.

					
BE	BG	CZ	DK	DE	EE
IE	EL	ES	FR	HR	IT
CY	LV	LT	LU	HU	MT
NL	AT	PL	PT	RO	SI
SK	FI	SE	UK	TR	NO
CH	IS	LI			

#### Thailand Warning message

เครื่องโทรคมนาคมและอุปกรณ์นี้ มีความสอดคล้องตามข้อกำหนดของ กทข.

#### Mexico Warning message

“La operación de este equipo está sujeta a las siguientes dos condiciones: (1) es posible que este equipo o dispositivo no cause interferencia perjudicial y (2) este equipo o dispositivo debe aceptar cualquier interferencia, incluyendo la que pueda causar su operación no deseada.”

**EAC**

