

SAR EVALUATION REPORT

For

SZ DJI TECHNOLOGY CO., LTD

14th floor, West Wing, Skyworth Semiconductor Design Building NO.18 Gaoxin South 4th Ave,
Nanshan, Shenzhen, Guangdong, China

FCC ID: SS3-S01A1710

IC: 11805A-S01A1710

Report Type: Original Report	Product Type: C2
Report Number: RDG171013008-20	
Report Date: 2017-11-24	
Reviewed By: Rocky Xiao RF Engineer	<i>Rocky Xiao</i>
Prepared By: Bay Area Compliance Laboratories Corp. (Dongguan) No.69 Pulongcun, Puxinhu Industry Area, Tangxia, Dongguan, Guangdong, China Tel: +86-769-86858888 Fax: +86-769-86858891 www.baclcorp.com.cn	

Attestation of Test Results			
EUT Information	EUT Description	C2	
	Tested Model	S01A	
	FCC ID	SS3-S01A1710	
	IC	11805A-S01A1710	
	Serial Number	17101300820	
	Test Date	2017-11-01 ~ 2017-11-07	
MODE		Max. SAR Level(s) Reported(W/kg)	Limit
DTS 2.4G(5MHz)	10g Extremity SAR	2.25	4.0 W/kg
DTS 2.4G(10MHz)	10g Extremity SAR	2.03	
Wi-Fi 2.4G	10g Extremity SAR	0.41	
NII 5.8G(5MHz)	10g Extremity SAR	2.83	
NII 5.8G(10MHz)	10g Extremity SAR	2.89	
Wi-Fi 5.8G	10g Extremity SAR	2.10	
Simultaneous	10g Extremity SAR	3.85	
DTS 2.4G(5MHz)	1g Body SAR	1.21	SAR Limit = 1.6 W/kg SPLSR Limit= 0.04
DTS 2.4G(10MHz)	1g Body SAR	1.33	
Wi-Fi 2.4G	1g Body SAR	0.31	
NII 5.8G(5MHz)	1g Body SAR	1.31	
NII 5.8G(10MHz)	1g Body SAR	1.08	
Wi-Fi 5.8G	1g Body SAR	1.32	
Simultaneous	1g Body SAR	2.46(SPLSR=0.04)	
Applicable Standards	ANSI / IEEE C95.1 : 2005 IEEE Standard for Safety Levels with Respect to Human Exposure to Radio Frequency Electromagnetic Fields,3 kHz to 300 GHz.		
	ANSI / IEEE C95.3 : 2002 IEEE Recommended Practice for Measurements and Computations of Radio Frequency Electromagnetic Fields With Respect to Human Exposure to Such Fields,100 kHz—300 GHz.		
	FCC 47 CFR part 2.1093 Radiofrequency radiation exposure evaluation: portable devices		
	RSS-102 Issue 5 March 2015 Radio Frequency (RF) Exposure Compliance of Radio communication Apparatus (All Frequency Bands).		
	IEEE1528:2013 IEEE Recommended Practice for Determining the Peak Spatial-Average Specific Absorption Rate (SAR) in the Human Head from Wireless Communications Devices: Measurement Techniques		
	IEC 62209-2:2010 Human exposure to radio frequency fields from hand-held and body-mounted wireless communication devices-Human models, instrumentation, and procedures-Part 2: Procedure to determine the specific absorption rate (SAR) for wireless communication devices used in close proximity to the human body (frequency range of 30 MHz to 6 GHz)		

Applicable Standards	KDB procedures KDB 447498 D01 General RF Exposure Guidance v06. KDB 865664 D01 SAR Measurement 100 MHz to 6 GHz v01r04 KDB 865664 D02 RF Exposure Reporting v01r02 KDB 248227 D01 802.11 Wi-Fi SAR v02r02 KDB 941225 D07 UMPC Mini Tablet v01r02
Note: This wireless device has been shown to be capable of compliance for localized specific absorption rate (SAR) for General Population/Uncontrolled Exposure limits specified in FCC 47 CFR part 2.1093/RSS-102 Issue 5 March 2015 and has been tested in accordance with the measurement procedures specified in IEEE 1528-2013 and RF exposure KDB procedures. The results and statements contained in this report pertain only to the device(s) evaluated.	

TABLE OF CONTENTS

DOCUMENT REVISION HISTORY	5
EUT DESCRIPTION	6
TECHNICAL SPECIFICATION	6
REFERENCE, STANDARDS, AND GUIDELINES.....	7
SAR LIMITS	8
FACILITIES.....	9
DESCRIPTION OF TEST SYSTEM	10
EQUIPMENT LIST AND CALIBRATION	15
EQUIPMENTS LIST & CALIBRATION INFORMATION	15
SAR MEASUREMENT SYSTEM VERIFICATION	16
LIQUID VERIFICATION	16
SYSTEM ACCURACY VERIFICATION	18
EUT TEST STRATEGY AND METHODOLOGY	27
TEST POSITIONS FOR DEVICE OPERATING NEXT TO A PERSON’S EAR.....	27
CHEEK/TOUCH POSITION	28
EAR/TILT POSITION	28
TEST POSITIONS FOR BODY-WORN AND OTHER CONFIGURATIONS	29
TEST DISTANCE FOR SAR EVALUATION	29
SAR EVALUATION PROCEDURE.....	30
CONDUCTED OUTPUT POWER MEASUREMENT	31
TEST PROCEDURE	31
MAXIMUM TARGET OUTPUT POWER	31
TEST RESULTS:	31
SAR EXCLUSION CONSIDERATIONS	33
ANTENNAS LOCATION:	33
ANTENNA DISTANCE TO EDGE	33
SAR TEST EXCLUSION FOR THE EUT EDGE CONSIDERATIONS(KDB).....	33
SAR MEASUREMENT RESULTS	37
SAR TEST DATA.....	37
SAR MEASUREMENT VARIABILITY	63
SAR SIMULTANEOUS TRANSMISSION DESCRIPTION	64
SAR PLOTS.....	70
APPENDIX A MEASUREMENT UNCERTAINTY	71
APPENDIX B CALIBRATION CERTIFICATES	73
APPENDIX C EUT TEST POSITION PHOTOS	74

DOCUMENT REVISION HISTORY

Revision Number	Report Number	Description of Revision	Date of Revision
1.0	RDG171013008-20	Original Report	2017-11-24

EUT DESCRIPTION

This report has been prepared on behalf of **SZ DJI TECHNOLOGY CO., LTD** and their product **C2**, Model: **S01A**, FCC ID: **SS3-S01A1710**, IC: **11805A-S01A1710** or the EUT (Equipment under Test) as referred to in the rest of this report.

All measurement and test data in this report was gathered from production sample serial number: 17101300820 (Assigned by BACL). The EUT was received on 2017-10-13.

Technical Specification

Device Type:	Portable
Exposure Category:	Population / Uncontrolled
Antenna Type(s):	External Antenna
Operation Mode :	DTS 2.4G/NII 5.8G, Wi-Fi 2.4/5.8G
Accessories:	None
Frequency Band:	DTS 2.4G: 2412~2462 MHz
	NII 5.8G: 5745~5825 MHz
	Wi-Fi 2.4G: 2412~2462 MHz
	Wi-Fi 5.8G: 5745~5825 MHz
Conducted RF Power:	DTS 2.4G (5 MHz): 23.26 dBm
	DTS 2.4G (10 MHz): 23.49 dBm
	NII 5.8G (5 MHz): 22.67 dBm
	NII 5.8G (10 MHz): 22.62 dBm
	Wi-Fi 2.4G: 14.19 dBm
	Wi-Fi 5.8G: 22.68 dBm
Dimensions (L*W*H):	14.4 cm (L) × 7.8 cm (W) × 6.2 cm (H)
Power Source:	3.7 VDC Rechargeable Battery
Normal Operation:	Handheld and Close to Body

REFERENCE, STANDARDS, AND GUIDELINES

FCC:

The Report and Order requires routine SAR evaluation prior to equipment authorization of portable transmitter devices, including portable telephones. For consumer products, the applicable limit is 1.6 mW/g as recommended by the ANSI/IEEE standard C95.1-1992 [6] for an uncontrolled environment (Paragraph 65). According to the Supplement C of OET Bulletin 65 "Evaluating Compliance with FCC Guide-lines for Human Exposure to Radio frequency Electromagnetic Fields", released on Jun 29, 2001 by the FCC, the device should be evaluated at maximum output power (radiated from the antenna) under "worst-case" conditions for normal or intended use, incorporating normal antenna operating positions, device peak performance frequencies and positions for maximum RF energy coupling.

This report describes the methodology and results of experiments performed on wireless data terminal. The objective was to determine if there is RF radiation and if radiation is found, what is the extent of radiation with respect to safety limits. SAR (Specific Absorption Rate) is the measure of RF exposure determined by the amount of RF energy absorbed by human body (or its parts) – to determine how the RF energy couples to the body or head which is a primary health concern for body worn devices. The limit below which the exposure to RF is considered safe by regulatory bodies in North America is 1.6 mW/g average over 1 gram of tissue mass.

CE:

The order requires routine SAR evaluation prior to equipment authorization of portable transmitter devices, including portable telephones. For consumer products, the applicable limit is 2 mW/g as recommended by EN62209-1 for an uncontrolled environment. According to the Standard, the device should be evaluated at maximum output power (radiated from the antenna) under "worst-case" conditions for normal or intended use, incorporating normal antenna operating positions, device peak performance frequencies and positions for maximum RF energy coupling.

This report describes the methodology and results of experiments performed on wireless data terminal. The objective was to determine if there is RF radiation and if radiation is found, what is the extent of radiation with respect to safety limits. SAR (Specific Absorption Rate) is the measure of RF exposure determined by the amount of RF energy absorbed by human body (or its parts) – to determine how the RF energy couples to the body or head which is a primary health concern for body worn devices. The limit below which the exposure to RF is considered safe by regulatory bodies in Europe is 2 mW/g average over 10 gram of tissue mass.

The test configurations were laid out on a specially designed test fixture to ensure the reproducibility of measurements. Each configuration was scanned for SAR. Analysis of each scan was carried out to characterize the above effects in the device.

SAR Limits

FCC Limit

EXPOSURE LIMITS	SAR (W/kg)	
	(General Population / Uncontrolled Exposure Environment)	(Occupational / Controlled Exposure Environment)
Spatial Average (averaged over the whole body)	0.08	0.4
Spatial Peak (averaged over any 1 g of tissue)	1.60	8.0
Spatial Peak (hands/wrists/feet/ankles averaged over 10 g)	4.0	20.0

CE Limit

EXPOSURE LIMITS	SAR (W/kg)	
	(General Population / Uncontrolled Exposure Environment)	(Occupational / Controlled Exposure Environment)
Spatial Average (averaged over the whole body)	0.08	0.4
Spatial Peak (averaged over any 10 g of tissue)	2.0	10
Spatial Peak (hands/wrists/feet/ankles averaged over 10 g)	4.0	20.0

Population/Uncontrolled Environments are defined as locations where there is the exposure of individual who have no knowledge or control of their exposure.

Occupational/Controlled Environments are defined as locations where there is exposure that may be incurred by people who are aware of the potential for exposure (i.e. as a result of employment or occupation).

General Population/Uncontrolled environments Spatial Peak limit 4.0W/kg for 10g Extremity SAR and 1.6W/kg for 1g Body SAR applied to the EUT.

FACILITIES

The Test site used by Bay Area Compliance Laboratories Corp. (Dongguan) to collect test data is located on the No.69 Pulongcun, Puxinhu Industry Area, Tangxia, Dongguan, Guangdong, China

Bay Area Compliance Laboratories Corp. (Dongguan) has been accredited to ISO/IEC 17025 by CNAS(Lab code: L5662). And accredited to ISO/IEC 17025 by NVLAP(Test Laboratory Accreditation Certificate Number 500069-0), the FCC Designation No. CN5002 under the KDB 974614 D01.

The Federal Communications Commission has the reports on file and is listed under FCC Registration No.: 273710. The test site has been approved by the FCC for public use and is listed in the FCC Public Access Link (PAL) database.

Bay Area Compliance Laboratories Corp. (Dongguan) was registered with ISED Canada under ISED Canada Registration Number 3062D.

The test sites and measurement facilities used to collect data are located at:

<input checked="" type="checkbox"/> SAR Lab 1	<input type="checkbox"/> SAR Lab 2
---	------------------------------------

DESCRIPTION OF TEST SYSTEM

These measurements were performed with the automated near-field scanning system DASY5 from Schmid & Partner Engineering AG (SPEAG) which is the Fifth generation of the system shown in the figure hereinafter:



DASY5 System Description

The DASY5 system for performing compliance tests consists of the following items:

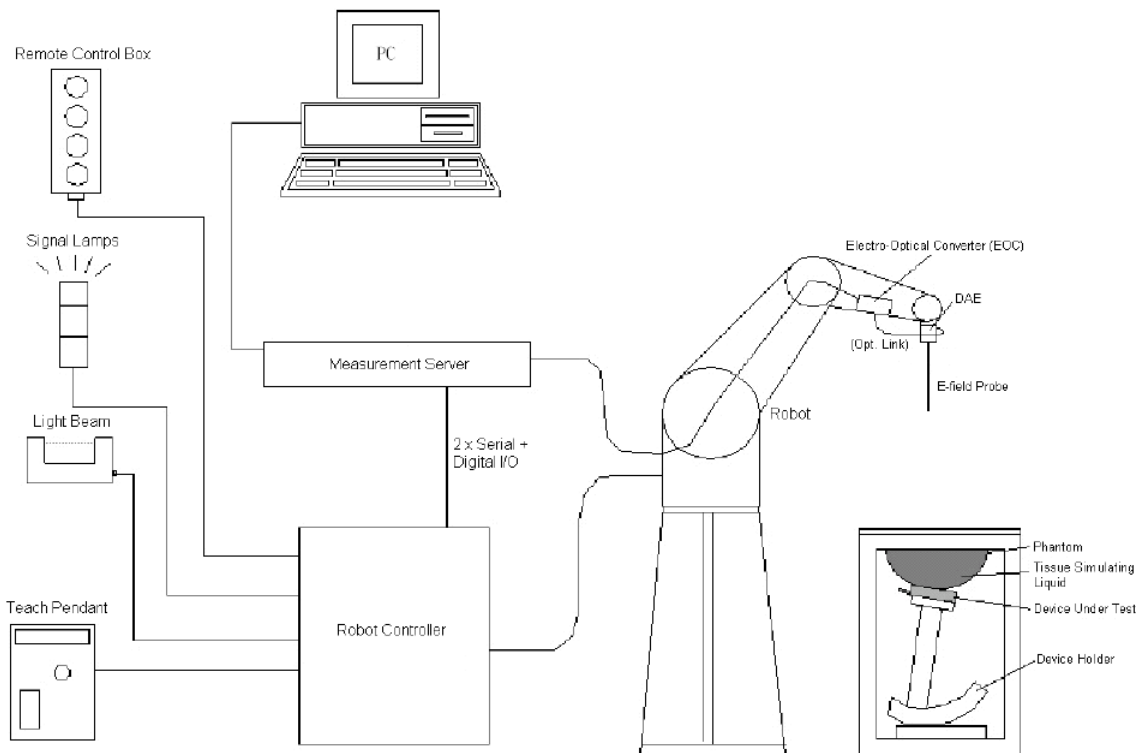

- A standard high precision 6-axis robot with controller, teach pendant and software. An arm extension for accommodating the data acquisition electronics (DAE).
- An isotropic field probe optimized and calibrated for the targeted measurement.
- A data acquisition electronics (DAE) which performs the signal application, signal multiplexing, AD-conversion, offset measurements, mechanical surface detection, collision detection, etc. The unit is battery powered with standard or rechargeable batteries. The signal is optically transmitted to the EOC.
- The Electro-optical converter (EOC) performs the conversion from optical to electrical signals for the digital communication to the DAE. To use optical surface detection, a special version of the EOC is required. The EOC signal is transmitted to the measurement server.
- The function of the measurement server is to perform the time critical tasks such as signal filtering, control of the robot operation and fast movement interrupts.
- The Light Beam used is for probe alignment. This improves the (absolute) accuracy of the probe positioning.
- A computer running Win7 professional operating system and the DASY52 software.
- Remote control and teach pendant as well as additional circuitry for robot safety such as warning lamps, etc.
- The phantom, the device holder and other accessories according to the targeted measurement.

DASY5 Measurement Server

The DASY5 measurement server is based on a PC/104 CPU board with a 400MHz Intel ULV Celeron, 128MB chip-disk and 128MB RAM. The necessary circuits for communication with the DAE4 (or DAE3) electronics box, as well as the 16 bit AD-converter system for optical detection and digital I/O interface are contained on the DASY5 I/O board, which is directly connected to the PC/104 bus of the CPU board.



The measurement server performs all real-time data evaluation of field measurements and surface detection, controls robot movements and handles safety operation. The PC operating system cannot interfere with these time critical processes. All connections are supervised by a watchdog, and disconnection of any of the cables to the measurement server will automatically disarm the robot and disable all program-controlled robot movements. Furthermore, the measurement server is equipped with an expansion port which is reserved for future applications. Please note that this expansion port does not have a standardized point out, and therefore only devices provided by SPEAG can be connected. Devices from any other supplier could seriously damage the measurement server.

Data Acquisition Electronics

The data acquisition electronics (DAE4) consist of a highly sensitive electrometer-grade preamplifier with auto-zeroing, a channel and gain-switching multiplexer, a fast 16 bit AD-converter and a command decoder with a control logic unit. Transmission to the measurement server is accomplished through an optical downlink for data and status information, as well as an optical uplink for commands and the clock.

The mechanical probe mounting device includes two different sensor systems for frontal and sideways probe contacts. They are used for mechanical surface detection and probe collision detection.

The input impedance of both the DAE4 as well as of the DAE3 box is 200M Ω ; the inputs are symmetrical and floating. Common mode rejection is above 80 dB.

EX3DV4 E-Field Probes

Frequency	10 MHz to > 6 GHz Linearity: ± 0.2 dB (30 MHz to 6 GHz)
Directivity	± 0.3 dB in TSL (rotation around probe axis) ± 0.5 dB in TSL (rotation normal to probe axis)
Dynamic Range	10 µW/g to > 100 mW/g Linearity: ± 0.2 dB (noise: typically < 1 µW/g)
Dimensions	Overall length: 337 mm (Tip: 20 mm) Tip diameter: 2.5 mm (Body: 12 mm) Typical distance from probe tip to dipole centers: 1 mm
Application	High precision dosimetric measurements in any exposure scenario (e.g., very strong gradient fields); the only probe that enables compliance testing for frequencies up to 6 GHz with precision of better 30%.
Compatibility	DASY3, DASY4, DASY52 SAR and higher, EASY4/MRI

SAM Twin Phantom

The SAM twin phantom is a fiberglass shell phantom with 2mm shell thickness (except the ear region, where shell thickness

increases to 6 mm). The phantom has three measurement areas:

- _ Left Head
- _ Right Head
- _ Flat phantom

The phantom table for the DASY systems based on the robots have the size of 100 x 50 x 85 cm (L x W x H). For easy dislocation these tables have fork lift cut outs at the bottom.

The bottom plate contains three pairs of bolts for locking the device holder. The device holder positions are adjusted to the standard measurement positions in the three sections. Only one device holder is necessary if two phantoms are used (e.g., for different liquids)



A white cover is provided to cover the phantom during off-periods to prevent water evaporation and changes in the liquid parameters. Free space scans of devices on top of this phantom cover are possible. Three reference marks are provided on the phantom counter. These reference marks are used to teach the absolute phantom position relative to the robot.

Robots

The DASY5 system uses the high precision industrial robot. The robot offers the same features important for our application:

- High precision (repeatability 0.02mm)
- High reliability (industrial design)
- Low maintenance costs (virtually maintenance free due to direct drive gears; no belt drives)
- Jerk-free straight movements (brushless synchrony motors; no stepper motors)
- Low ELF interference (motor control fields shielded via the closed metallic construction shields)

The above mentioned robots are controlled by the Staubli CS8c robot controllers. All information regarding the use and maintenance of the robot arm and the robot controller is contained on the CDs delivered along with the robot. Paper manuals are available upon request direct from Staubli.

Area Scans

Area scans are defined prior to the measurement process being executed with a user defined variable spacing between each measurement point (integral) allowing low uncertainty measurements to be conducted. Scans defined for FCC applications utilize a 15mm 2 step integral, with 1.5mm interpolation used to locate the peak SAR area used for zoom scan assessments.

Where the system identifies multiple SAR peaks (which are within 25% of peak value) the system will provide the user with the option of assessing each peak location individually for zoom scan averaging.

Zoom Scan (Cube Scan Averaging)

The averaging zoom scan volume utilized in the DASY5 software is in the shape of a cube and the side dimension of a 1 g or 10 g mass is dependent on the density of the liquid representing the simulated tissue. A density of 1000 kg/m³ is used to represent the head and body tissue density and not the phantom liquid density, in order to be consistent with the definition of the liquid dielectric properties, i.e. the side length of the 1g cube is 10mm, with the side length of the 10g cube is 21.5mm.

When the cube intersects with the surface of the phantom, it is oriented so that 3 vertices touch the surface of the shell or the center of a face is tangent to the surface. The face of the cube closest to the surface is modified in order to conform to the tangent surface.

The zoom scan integer steps can be user defined so as to reduce uncertainty, but normal practice for typical test applications (including FCC) utilize a physical step of 7 x 7 x 7 (5mmx5mmx5mm) providing a volume of 30 mm in the X & Y & Z axis.

Tissue Dielectric Parameters for Head and Body Phantoms

The head tissue dielectric parameters recommended by the IEEE SCC-34/SC-2 in P1528 have been incorporated in the following table. These head parameters are derived from planar layer models simulating the highest expected SAR for the dielectric properties and tissue thickness variations in a human head. Other head and body tissue parameters that have not been specified in P1528 are derived from the tissue dielectric parameters computed from the 4-Cole-Cole equations described in Reference [12] and extrapolated according to the head parameters specified in P1528.

Recommended Tissue Dielectric Parameters for Head and Body

Frequency (MHz)	Head Tissue		Body Tissue	
	ϵ_r	σ (S/m)	ϵ_r	σ (S/m)
150	52.3	0.76	61.9	0.80
300	45.3	0.87	58.2	0.92
450	43.5	0.87	56.7	0.94
835	41.5	0.90	55.2	0.97
900	41.5	0.97	55.0	1.05
915	41.5	0.98	55.0	1.06
1450	40.5	1.20	54.0	1.30
1610	40.3	1.29	53.8	1.40
1800-2000	40.0	1.40	53.3	1.52
2450	39.2	1.80	52.7	1.95
3000	38.5	2.40	52.0	2.73
5800	35.3	5.27	48.2	6.00

EQUIPMENT LIST AND CALIBRATION

Equipments List & Calibration Information

Equipment	Model	S/N	Calibration Date	Calibration Due Date
DASY5 Test Software	DASY52.8	N/A	NCR	NCR
DASY5 Measurement Server	DASY5 4.5.12	1470	NCR	NCR
Data Acquisition Electronics	DAE4	1459	2017/9/15	2018/9/15
E-Field Probe	EX3DV4	3619	2017/9/25	2018/9/24
Dipole,2450 MHz	D2450V2	971	2015/7/8	2018/7/8
Dipole,5GHz	D5GHzV2	1246	2016/11/7	2019/11/6
Mounting Device	MD4HHTV5	SD 000 H01 KA	NCR	NCR
Twin SAM	Twin SAM V5.0	1874	NCR	NCR
Simulated Tissue 2450 MHz Body	TS-2450-B	1709245002	Each Time	/
Simulated Tissue 5800 MHz Body	TS-5800-B	1701580002	Each Time	/
Network Analyzer	8753C	3033A02857	2017/8/31	2018/8/31
Dielectric assessment kit	1253	SM DAK 040 CA	NCR	NCR
Signal Generator	N5182B	MY51350142	2017/5/4	2018/5/4
Power Meter	EPM-441A	GB37481494	2016/12/8	2017/12/8
Power Amplifier	ZVA-183-S+	5969001149	NCR	NCR
Directional Coupler	488Z	N/A	NCR	NCR
Attenuator	20dB, 100W	N/A	NCR	NCR
Attenuator	6dB, 150W	N/A	NCR	NCR

SAR MEASUREMENT SYSTEM VERIFICATION

Liquid Verification

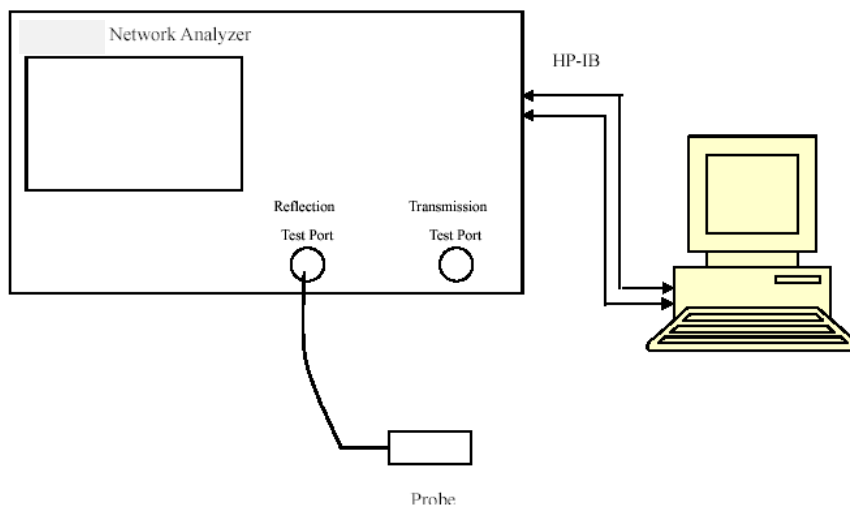

Liquid Verification Setup Block Diagram

Liquid Verification Results

Frequency (MHz)	Liquid Type	Liquid Parameter		Target Value		Delta (%)		Tolerance (%)
		ϵ_r	σ (S/m)	ϵ_r	σ (S/m)	$\Delta\epsilon_r$	$\Delta\sigma$ (S/m)	
2412	Simulated Tissue 2450 MHz Body	52.318	1.888	52.8	1.91	-0.91	-1.15	± 5
2437	Simulated Tissue 2450 MHz Body	52.261	1.922	52.7	1.94	-0.83	-0.93	± 5
2450	Simulated Tissue 2450 MHz Body	52.21	1.929	52.7	1.94	-0.93	-0.57	± 5
2462	Simulated Tissue 2450 MHz Body	52.178	1.939	52.7	1.95	-0.99	-0.56	± 5

*Liquid Verification above was performed on 2017-11-01.

Frequency (MHz)	Liquid Type	Liquid Parameter		Target Value		Delta (%)		Tolerance (%)
		ϵ_r	σ (S/m)	ϵ_r	σ (S/m)	$\Delta\epsilon_r$	$\Delta\sigma$ (S/m)	
2412	Simulated Tissue 2450 MHz Body	53.234	1.944	52.8	1.91	0.82	1.78	± 5
2437	Simulated Tissue 2450 MHz Body	51.661	1.977	52.7	1.94	-1.97	1.91	± 5
2450	Simulated Tissue 2450 MHz Body	52.246	2.028	52.7	1.94	-0.86	4.54	± 5
2462	Simulated Tissue 2450 MHz Body	52.179	1.982	52.7	1.95	-0.99	1.64	± 5

*Liquid Verification above was performed on 2017-11-02.

Frequency (MHz)	Liquid Type	Liquid Parameter		Target Value		Delta (%)		Tolerance (%)
		ϵ_r	σ (S/m)	ϵ_r	σ (S/m)	$\Delta\epsilon_r$	$\Delta\sigma$ (S/m)	
2412	Simulated Tissue 2450 MHz Body	52.702	1.977	52.8	1.91	-0.19	3.51	±5
2437	Simulated Tissue 2450 MHz Body	54.425	1.958	52.7	1.94	3.27	0.93	±5
2450	Simulated Tissue 2450 MHz Body	54.207	1.938	52.7	1.94	2.86	-0.1	±5
2462	Simulated Tissue 2450 MHz Body	53.368	1.91	52.7	1.95	1.27	-2.05	±5

*Liquid Verification above was performed on 2017-11-03.

Frequency (MHz)	Liquid Type	Liquid Parameter		Target Value		Delta (%)		Tolerance (%)
		ϵ_r	σ (S/m)	ϵ_r	σ (S/m)	$\Delta\epsilon_r$	$\Delta\sigma$ (S/m)	
5745	Simulated Tissue 5800 MHz Body	48.806	6.014	48.27	5.94	1.11	1.25	±5
5785	Simulated Tissue 5800 MHz Body	48.753	6.133	48.22	5.98	1.11	2.56	±5
5800	Simulated Tissue 5800 MHz Body	48.709	6.151	48.2	6	1.06	2.52	±5
5825	Simulated Tissue 5800 MHz Body	48.663	6.196	48.2	6	0.96	3.27	±5

*Liquid Verification above was performed on 2017-11-04.

Frequency (MHz)	Liquid Type	Liquid Parameter		Target Value		Delta (%)		Tolerance (%)
		ϵ_r	σ (S/m)	ϵ_r	σ (S/m)	$\Delta\epsilon_r$	$\Delta\sigma$ (S/m)	
5745	Simulated Tissue 5800 MHz Body	48.753	6.105	48.27	5.94	1	2.78	±5
5785	Simulated Tissue 5800 MHz Body	48.709	6.152	48.22	5.98	1.01	2.88	±5
5800	Simulated Tissue 5800 MHz Body	48.672	6.189	48.2	6	0.98	3.15	±5
5825	Simulated Tissue 5800 MHz Body	48.614	6.242	48.2	6	0.86	4.03	±5

*Liquid Verification above was performed on 2017-11-05.

Frequency (MHz)	Liquid Type	Liquid Parameter		Target Value		Delta (%)		Tolerance (%)
		ϵ_r	σ (S/m)	ϵ_r	σ (S/m)	$\Delta\epsilon_r$	$\Delta\sigma$ (S/m)	
5745	Simulated Tissue 5800 MHz Body	48.811	6.125	48.27	5.94	1.12	3.11	±5
5785	Simulated Tissue 5800 MHz Body	48.735	6.161	48.22	5.98	1.07	3.03	±5
5800	Simulated Tissue 5800 MHz Body	48.702	6.191	48.2	6	1.04	3.18	±5
5825	Simulated Tissue 5800 MHz Body	48.649	6.201	48.2	6	0.93	3.35	±5

*Liquid Verification above was performed on 2017-11-06.

Frequency (MHz)	Liquid Type	Liquid Parameter		Target Value		Delta (%)		Tolerance (%)
		ϵ_r	σ (S/m)	ϵ_r	σ (S/m)	$\Delta\epsilon_r$	$\Delta\sigma$ (S/m)	
5745	Simulated Tissue 5800 MHz Body	49.374	5.965	48.27	5.94	2.29	0.42	±5
5785	Simulated Tissue 5800 MHz Body	49.241	6.059	48.22	5.98	2.12	1.32	±5
5800	Simulated Tissue 5800 MHz Body	49.106	6.121	48.2	6	1.88	2.02	±5
5825	Simulated Tissue 5800 MHz Body	49.002	6.197	48.2	6	1.66	3.28	±5

*Liquid Verification above was performed on 2017-11-07.

System Accuracy Verification

Prior to the assessment, the system validation kit was used to test whether the system was operating within its specifications of $\pm 10\%$. The validation results are tabulated below. And also the corresponding SAR plot is attached as well in the SAR plots files.

System Verification Setup Block Diagram

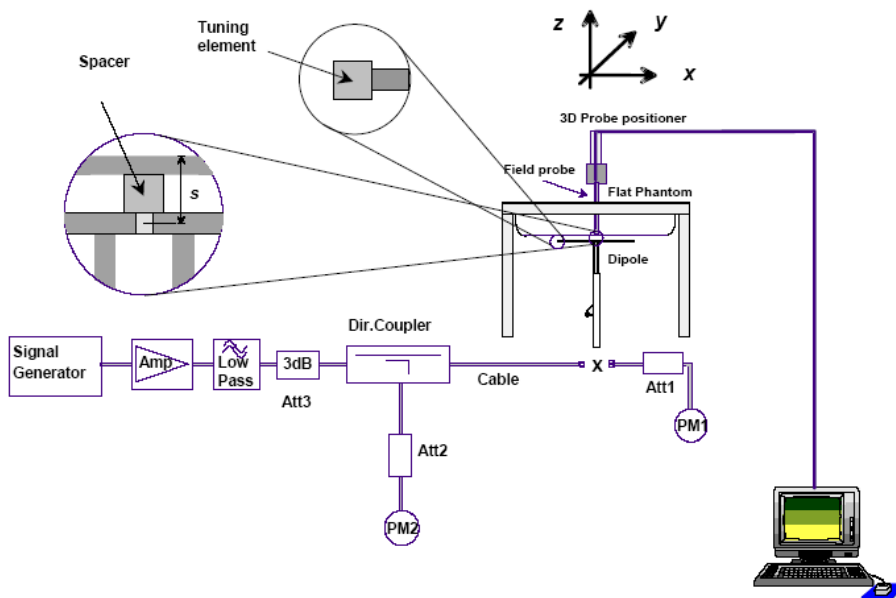

System Accuracy Check Results

Date	Frequency Band	Liquid Type	Input Power (mW)	Measured SAR (W/kg)		Normalized to 1W (W/kg)	Target Value (W/kg)	Delta (%)	Tolerance (%)
2017/11/01	2450 MHz	Body	100	1g	5.31	53.1	50.6	4.94	± 10
				10g	2.46	24.6	23.9	2.93	± 10
2017/11/02	2450 MHz	Body	100	1g	5.35	53.5	50.6	5.73	± 10
				10g	2.48	24.8	23.9	3.77	± 10
2017/11/03	2450 MHz	Body	100	1g	5.28	52.8	50.6	4.35	± 10
				10g	2.37	23.7	23.9	-0.84	± 10

Date	Frequency Band	Liquid Type	Input Power (mW)	Measured SAR (W/kg)		Normalized to 1W (W/kg)	Target Value (W/kg)	Delta (%)	Tolerance (%)
				1g	10g				
2017/11/04	5800 MHz	Body	100	1g	7.75	77.5	75.4	2.79	±10
				10g	2.16	21.6	20.9	3.35	±10
2017/11/05	5800 MHz	Body	100	1g	7.96	79.6	75.4	5.57	±10
				10g	2.23	22.3	20.9	6.7	±10
2017/11/06	5800 MHz	Body	100	1g	7.66	76.6	75.4	1.59	±10
				10g	2.07	20.7	20.9	-0.96	±10
2017/11/07	5800 MHz	Body	100	1g	7.43	74.3	75.4	-1.46	±10
				10g	2.01	20.1	20.9	-3.83	±10

*The SAR values above are normalized to 1 Watt forward power.

System Performance 2450MHz Body 2017/11/01

DUT: D2450V2; Type: 2450 MHz; Serial: 971

Communication System: CW; Frequency: 2450 MHz; Duty Cycle: 1:1

Medium parameters used: $f = 2450 \text{ MHz}$; $\sigma = 1.929 \text{ S/m}$; $\epsilon_r = 52.21$; $\rho = 1000 \text{ kg/m}^3$

Phantom section: Flat Section

DASY5 Configuration:

- Probe: EX3DV4 - SN3619; ConvF(6.73, 6.73, 6.73); Calibrated: 2017/9/25;
- Sensor-Surface: 1.4mm (Mechanical Surface Detection)
- Electronics: DAE4 Sn1459; Calibrated: 2017/9/15
- Phantom: SAM (30deg probe tilt) with CRP v5.0_20150321; Type: QD000P40CD; Serial: TP:1874
- Measurement SW: DASY52, Version 52.8 (8);

Area Scan (51x61x1): Interpolated grid: $dx=1.200 \text{ mm}$, $dy=1.200 \text{ mm}$

Maximum value of SAR (interpolated) = 9.67 W/kg

Zoom Scan (5x5x7)/Cube 0: Measurement grid: $dx=8\text{mm}$, $dy=8\text{mm}$, $dz=5\text{mm}$

Reference Value = 55.62 V/m; Power Drift = 0.05 dB

Peak SAR (extrapolated) = 11.2 W/kg

SAR(1 g) = 5.31 W/kg; SAR(10 g) = 2.46 W/kg

Maximum value of SAR (measured) = 9.18 W/kg

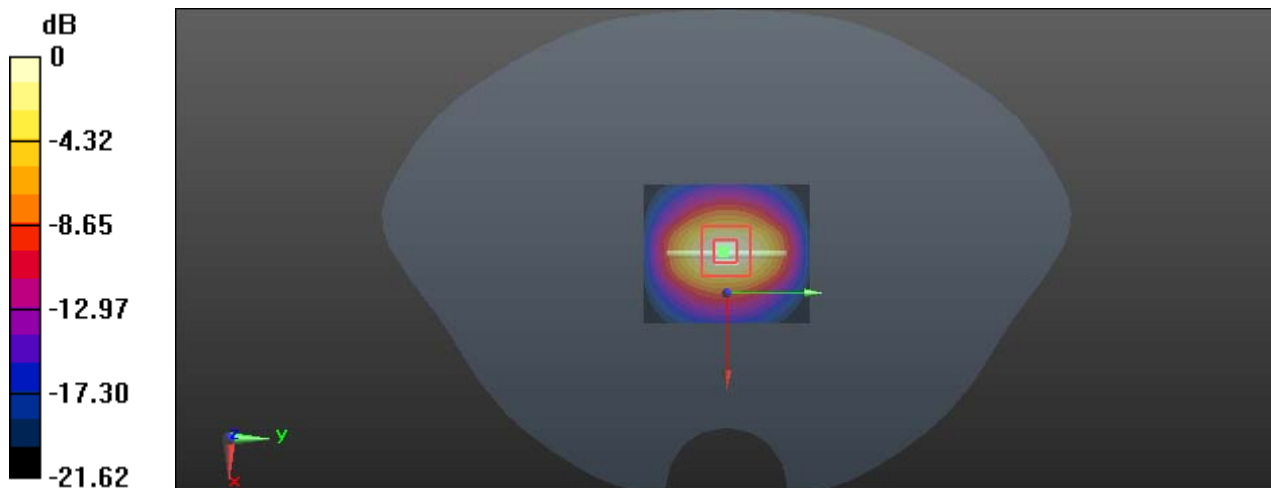

0 dB = 9.18 W/kg = 9.63 dBW/kg

System Performance 2450MHz Body 2017/11/02

DUT: D2450V2; Type: 2450 MHz; Serial: 971

Communication System: CW; Frequency: 2450 MHz; Duty Cycle: 1:1

Medium parameters used: $f = 2450$ MHz; $\sigma = 2.028$ S/m; $\epsilon_r = 52.246$; $\rho = 1000$ kg/m³

Phantom section: Flat Section

DASY5 Configuration:

- Probe: EX3DV4 - SN3619; ConvF(6.73, 6.73, 6.73); Calibrated: 2017/9/25;
- Sensor-Surface: 1.4mm (Mechanical Surface Detection)
- Electronics: DAE4 Sn1459; Calibrated: 2017/9/15
- Phantom: SAM (30deg probe tilt) with CRP v5.0_20150321; Type: QD000P40CD; Serial: TP:1874
- Measurement SW: DASY52, Version 52.8 (8);

Area Scan (51x61x1): Interpolated grid: dx=1.200 mm, dy=1.200 mm

Maximum value of SAR (interpolated) = 9.72 W/kg

Zoom Scan (5x5x7)/Cube 0: Measurement grid: dx=8mm, dy=8mm, dz=5mm

Reference Value = 55.96 V/m; Power Drift = -0.01 dB

Peak SAR (extrapolated) = 11.8 W/kg

SAR(1 g) = 5.35 W/kg; SAR(10 g) = 2.48 W/kg

Maximum value of SAR (measured) = 9.24 W/kg

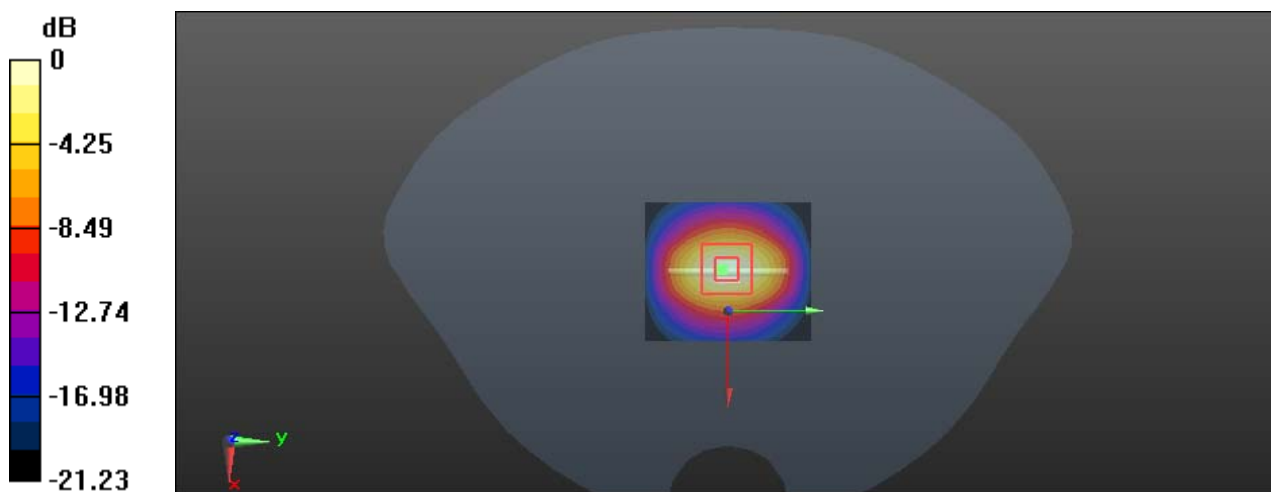

0 dB = 9.24 W/kg = 9.66 dBW/kg

System Performance 2450MHz Body 2017/11/03

DUT: D2450V2; Type: 2450 MHz; Serial: 971

Communication System: CW; Frequency: 2450 MHz; Duty Cycle: 1:1

Medium parameters used: $f = 2450$ MHz; $\sigma = 1.938$ S/m; $\epsilon_r = 54.207$; $\rho = 1000$ kg/m³

Phantom section: Flat Section

DASY5 Configuration:

- Probe: EX3DV4 - SN3619; ConvF(6.73, 6.73, 6.73); Calibrated: 2017/9/25;
- Sensor-Surface: 1.4mm (Mechanical Surface Detection)
- Electronics: DAE4 Sn1459; Calibrated: 2017/9/15
- Phantom: SAM (30deg probe tilt) with CRP v5.0_20150321; Type: QD000P40CD; Serial: TP:1874
- Measurement SW: DASY52, Version 52.8 (8);

Area Scan (51x61x1): Interpolated grid: dx=1.200 mm, dy=1.200 mm

Maximum value of SAR (interpolated) = 9.47 W/kg

Zoom Scan (5x5x7)/Cube 0: Measurement grid: dx=8mm, dy=8mm, dz=5mm

Reference Value = 54.91 V/m; Power Drift = 0.12 dB

Peak SAR (extrapolated) = 10.8 W/kg

SAR(1 g) = 5.28 W/kg; SAR(10 g) = 2.37 W/kg

Maximum value of SAR (measured) = 8.94 W/kg

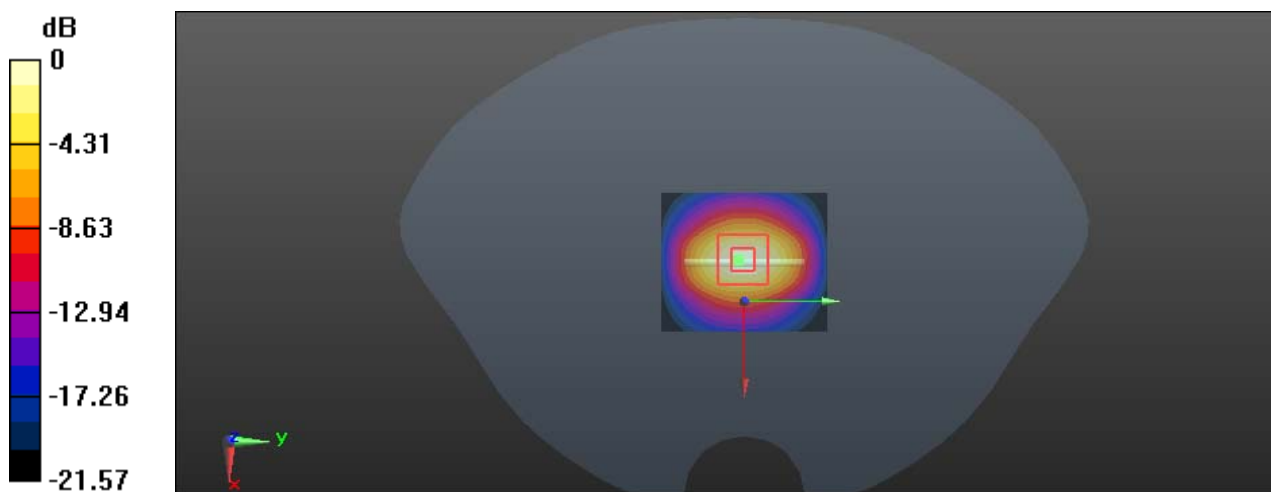

0 dB = 8.94 W/kg = 9.51 dBW/kg

System Performance 5800 MHz Body 2017/11/04

DUT: D5GHzV2; Type: 5800 MHz; Serial: SN:1246

Communication System: CW; Frequency: 5800 MHz; Duty Cycle: 1:1

Medium parameters used: $f = 5800 \text{ MHz}$; $\sigma = 6.151 \text{ S/m}$; $\epsilon_r = 48.709$; $\rho = 1000 \text{ kg/m}^3$

Phantom section: Flat Section

DASY5 Configuration:

- Probe: EX3DV4 - SN3619; ConvF(4, 4, 4); Calibrated: 2017/9/25;
- Sensor-Surface: 1.4mm (Mechanical Surface Detection)
- Electronics: DAE4 Sn1459; Calibrated: 2017/9/15
- Phantom: SAM (30deg probe tilt) with CRP v5.0_20150321; Type: QD000P40CD; Serial: TP:1874
- Measurement SW: DASY52, Version 52.8 (8);

Area Scan (31x51x1): Interpolated grid: $dx=1.000 \text{ mm}$, $dy=1.000 \text{ mm}$

Maximum value of SAR (interpolated) = 19.8 W/kg

Zoom Scan (7x7x6)/Cube 0: Measurement grid: $dx=5\text{mm}$, $dy=5\text{mm}$, $dz=2\text{mm}$

Reference Value = 39.42 V/m; Power Drift = 0.08 dB

Peak SAR (extrapolated) = 29.6 W/kg

SAR(1 g) = 7.75 W/kg; SAR(10 g) = 2.16 W/kg

Maximum value of SAR (measured) = 19.3 W/kg

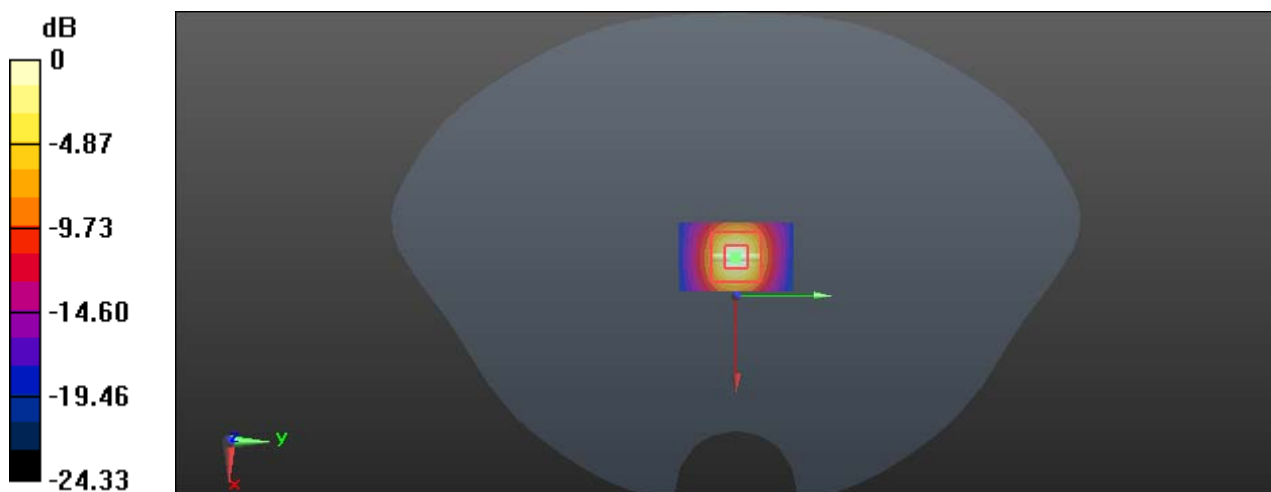

0 dB = 19.3 W/kg = 12.86 dBW/kg

System Performance 5800 MHz Body 2017/11/05

DUT: D5GHzV2; Type: 5800 MHz; Serial: SN:1246

Communication System: CW; Frequency: 5800 MHz; Duty Cycle: 1:1

Medium parameters used: $f = 5800 \text{ MHz}$; $\sigma = 6.189 \text{ S/m}$; $\epsilon_r = 48.672$; $\rho = 1000 \text{ kg/m}^3$

Phantom section: Flat Section

DASY5 Configuration:

- Probe: EX3DV4 - SN3619; ConvF(4, 4, 4); Calibrated: 2017/9/25;
- Sensor-Surface: 1.4mm (Mechanical Surface Detection)
- Electronics: DAE4 Sn1459; Calibrated: 2017/9/15
- Phantom: SAM (30deg probe tilt) with CRP v5.0_20150321; Type: QD000P40CD; Serial: TP:1874
- Measurement SW: DASY52, Version 52.8 (8);

Area Scan (31x51x1): Interpolated grid: $dx=1.000 \text{ mm}$, $dy=1.000 \text{ mm}$

Maximum value of SAR (interpolated) = 20.7 W/kg

Zoom Scan (7x7x6)/Cube 0: Measurement grid: $dx=5\text{mm}$, $dy=5\text{mm}$, $dz=2\text{mm}$

Reference Value = 41.86 V/m; Power Drift = 0.05 dB

Peak SAR (extrapolated) = 32.8 W/kg

SAR(1 g) = 7.96 W/kg; SAR(10 g) = 2.23 W/kg

Maximum value of SAR (measured) = 20.4 W/kg

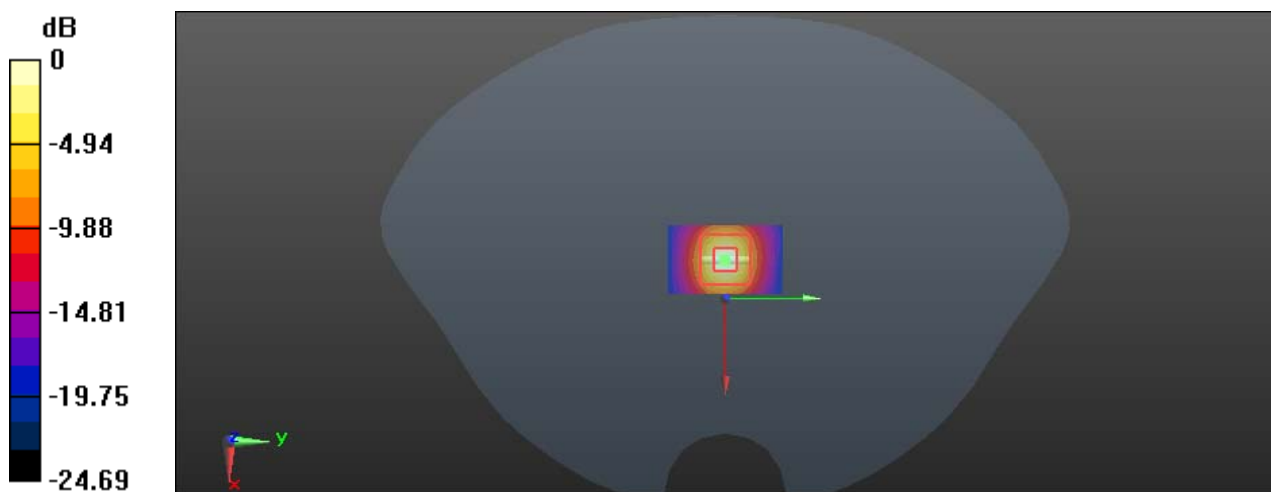

0 dB = 20.4 W/kg = 13.10 dBW/kg

System Performance 5800 MHz Body 2017/11/06

DUT: D5GHzV2; Type: 5800 MHz; Serial: SN:1246

Communication System: CW; Frequency: 5800 MHz; Duty Cycle: 1:1

Medium parameters used: $f = 5800 \text{ MHz}$; $\sigma = 6.191 \text{ S/m}$; $\epsilon_r = 48.702$; $\rho = 1000 \text{ kg/m}^3$

Phantom section: Flat Section

DASY5 Configuration:

- Probe: EX3DV4 - SN3619; ConvF(4, 4, 4); Calibrated: 2017/9/25;
- Sensor-Surface: 1.4mm (Mechanical Surface Detection)
- Electronics: DAE4 Sn1459; Calibrated: 2017/9/15
- Phantom: SAM (30deg probe tilt) with CRP v5.0_20150321; Type: QD000P40CD; Serial: TP:1874
- Measurement SW: DASY52, Version 52.8 (8);

Area Scan (31x51x1): Interpolated grid: $dx=1.000 \text{ mm}$, $dy=1.000 \text{ mm}$

Maximum value of SAR (interpolated) = 19.8 W/kg

Zoom Scan (7x7x6)/Cube 0: Measurement grid: $dx=5\text{mm}$, $dy=5\text{mm}$, $dz=2\text{mm}$

Reference Value = 38.16 V/m; Power Drift = -0.13 dB

Peak SAR (extrapolated) = 29.5 W/kg

SAR(1 g) = 7.66 W/kg; SAR(10 g) = 2.07 W/kg

Maximum value of SAR (measured) = 18.9 W/kg

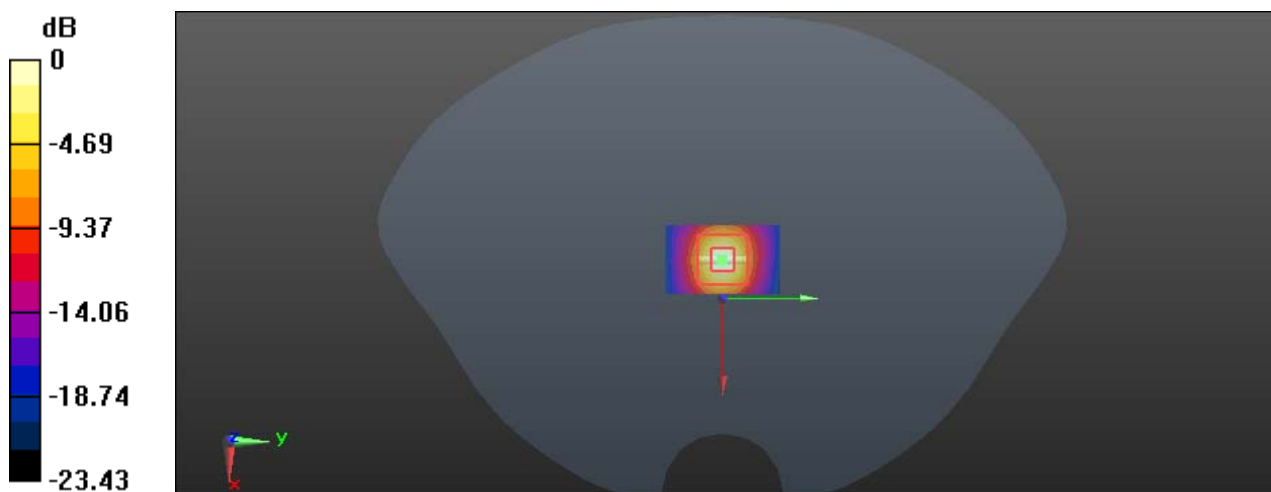

0 dB = 18.9 W/kg = 12.76 dBW/kg

System Performance 5800 MHz Body 2017/11/07

DUT: D5GHzV2; Type: 5800 MHz; Serial: SN:1246

Communication System: CW; Frequency: 5800 MHz;Duty Cycle: 1:1
 Medium parameters used: $f = 5800 \text{ MHz}$; $\sigma = 6.121 \text{ S/m}$; $\epsilon_r = 49.106$; $\rho = 1000 \text{ kg/m}^3$
 Phantom section: Flat Section

DASY5 Configuration:

- Probe: EX3DV4 - SN3619; ConvF(4, 4, 4); Calibrated: 2017/9/25;
- Sensor-Surface: 1.4mm (Mechanical Surface Detection)
- Electronics: DAE4 Sn1459;Calibrated: 2017/9/15
- Phantom: SAM (30deg probe tilt) with CRP v5.0_20150321; Type: QD000P40CD; Serial: TP:1874
- Measurement SW: DASY52, Version 52.8 (8);

Area Scan (31x51x1): Interpolated grid: $dx=1.000 \text{ mm}$, $dy=1.000 \text{ mm}$
 Maximum value of SAR (interpolated) = 19.2 W/kg

Zoom Scan (7x7x6)/Cube 0: Measurement grid: $dx=5\text{mm}$, $dy=5\text{mm}$, $dz=2\text{mm}$
 Reference Value = 36.52 V/m; Power Drift = -0.05 dB
 Peak SAR (extrapolated) = 28.8 W/kg
SAR(1 g) = 7.43 W/kg; SAR(10 g) = 2.01 W/kg
 Maximum value of SAR (measured) = 19.1 W/kg

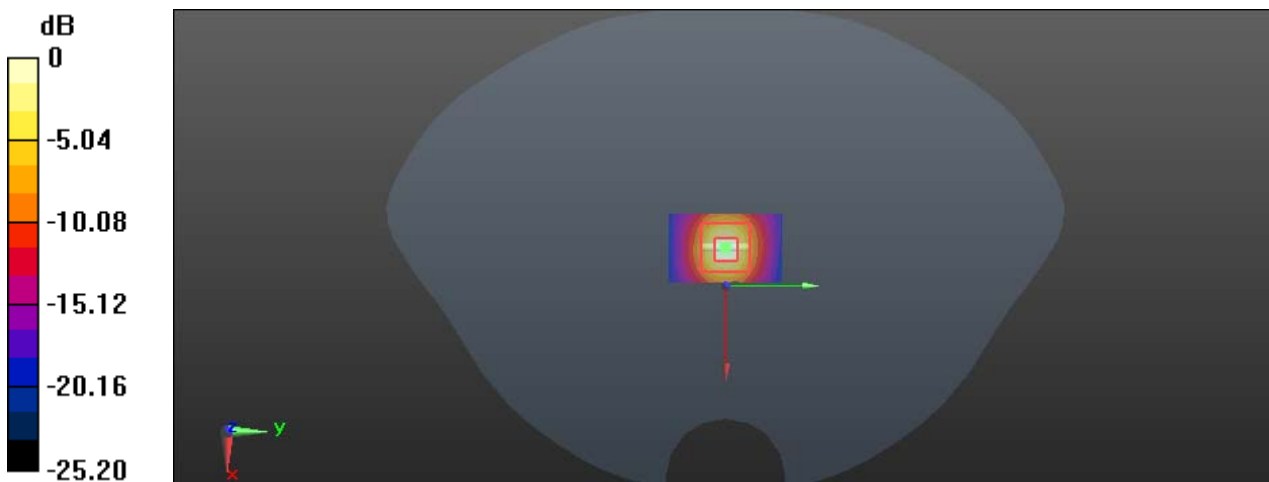

0 dB = 19.1 W/kg = 12.81 dBW/kg

EUT TEST STRATEGY AND METHODOLOGY

Test Positions for Device Operating Next to a Person’s Ear

This category includes most wireless handsets with fixed, retractable or internal antennas located toward the top half of the device, with or without a foldout, sliding or similar keypad cover. The handset should have its earpiece located within the upper ¼ of the device, either along the centerline or off-centered, as perceived by its users. This type of handset should be positioned in a normal operating position with the “test device reference point” located along the “vertical centerline” on the front of the device aligned to the “ear reference point”. The “test device reference point” should be located at the same level as the center of the earpiece region. The “vertical centerline” should bisect the front surface of the handset at its top and bottom edges. A “ear reference point” is located on the outer surface of the head phantom on each ear spacer. It is located 1.5 cm above the center of the ear canal entrance in the “phantom reference plane” defined by the three lines joining the center of each “ear reference point” (left and right) and the tip of the mouth.

A handset should be initially positioned with the earpiece region pressed against the ear spacer of a head phantom. For the SCC-34/SC-2 head phantom, the device should be positioned parallel to the “N-F” line defined along the base of the ear spacer that contains the “ear reference point”. For interim head phantoms, the device should be positioned parallel to the cheek for maximum RF energy coupling. The “test device reference point” is aligned to the “ear reference point” on the head phantom and the “vertical centerline” is aligned to the “phantom reference plane”. This is called the “initial ear position”. While maintaining these three alignments, the body of the handset is gradually adjusted to each of the following positions for evaluating SAR:

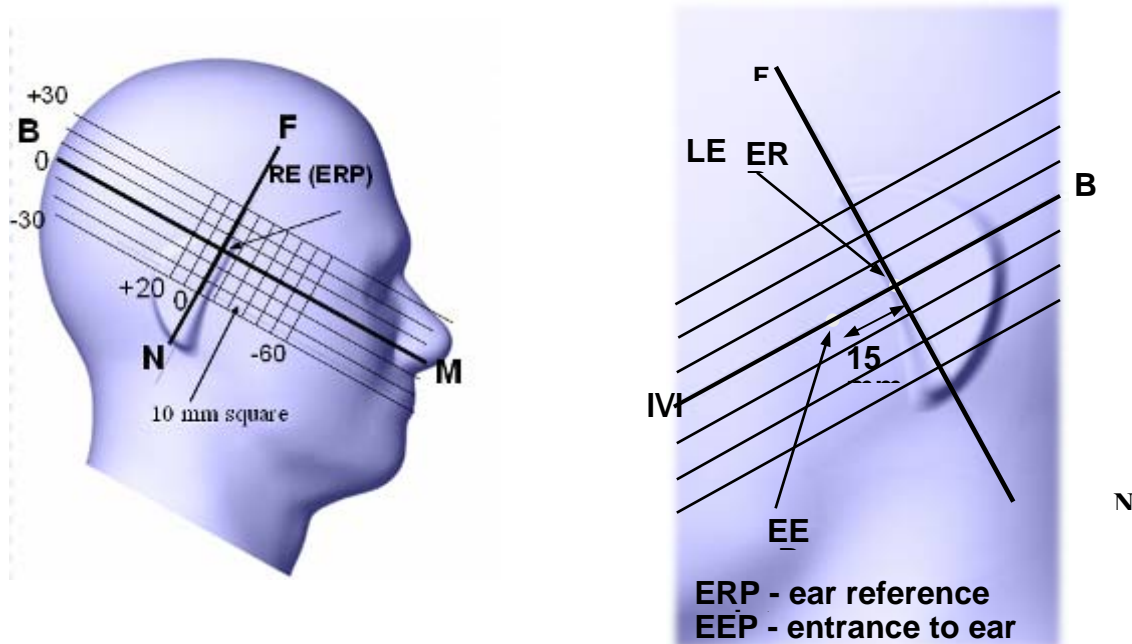

Cheek/Touch Position

The device is brought toward the mouth of the head phantom by pivoting against the “ear reference point” or along the “N-F” line for the SCC-34/SC-2 head phantom.

This test position is established:

When any point on the display, keypad or mouthpiece portions of the handset is in contact with the phantom.

(or) When any portion of a foldout, sliding or similar keypad cover opened to its intended self-adjusting normal use position is in contact with the cheek or mouth of the phantom.

For existing head phantoms – when the handset loses contact with the phantom at the pivoting point, rotation should continue until the device touches the cheek of the phantom or breaks its last contact from the ear spacer.

Cheek /Touch Position

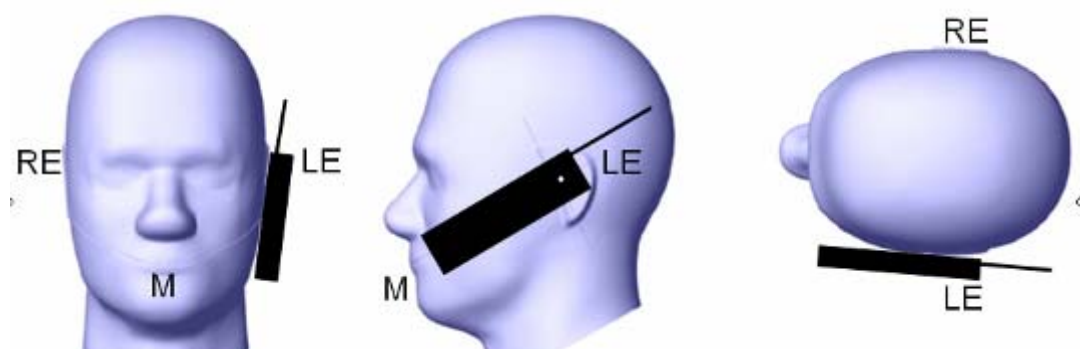

Ear/Tilt Position

With the handset aligned in the “Cheek/Touch Position”:

1) If the earpiece of the handset is not in full contact with the phantom’s ear spacer (in the “Cheek/Touch position”) and the peak SAR location for the “Cheek/Touch” position is located at the ear spacer region or corresponds to the earpiece region of the handset, the device should be returned to the “initial ear position” by rotating it away from the mouth until the earpiece is in full contact with the ear spacer.

2) (otherwise) The handset should be moved (translated) away from the cheek perpendicular to the line passes through both “ear reference points” (note: one of these ear reference points may not physically exist on a split head model) for approximate 2-3 cm. While it is in this position, the device handset is tilted away from the mouth with respect to the “test device reference point” until the inside angle between the vertical centerline on the front surface of the phone and the horizontal line passing through the ear reference point is by 15 80°. After the tilt, it is then moved (translated) back toward the head perpendicular to the line passes through both “ear reference points” until the device touches the phantom or the ear spacer. If the antenna touches the head first, the positioning process should be repeated with a tilt angle less than 15° so that the device and its antenna would touch the phantom simultaneously. This test position may require a device holder or positioner to achieve the translation and tilting with acceptable positioning repeatability.

If a device is also designed to transmit with its keypad cover closed for operating in the head position, such positions should also be considered in the SAR evaluation. The device should be tested on the left and right side of the head phantom in the “Cheek/Touch” and “Ear/Tilt” positions. When applicable, each configuration should be tested with the antenna in its fully extended and fully retracted positions. These test configurations should be tested at the high, middle and low frequency channels of each operating mode; for example, AMPS, CDMA, and TDMA. If the SAR measured at the middle channel for each test configuration (left, right, Cheek/Touch, Tilt/Ear, extended and retracted) is at least 2.0 dB lower than the SAR limit, testing at the high and low channels is optional for such test configuration(s). If the transmission band of the test device is less than 10 MHz, testing at the high and low frequency channels is optional.

Ear /Tilt 15° Position

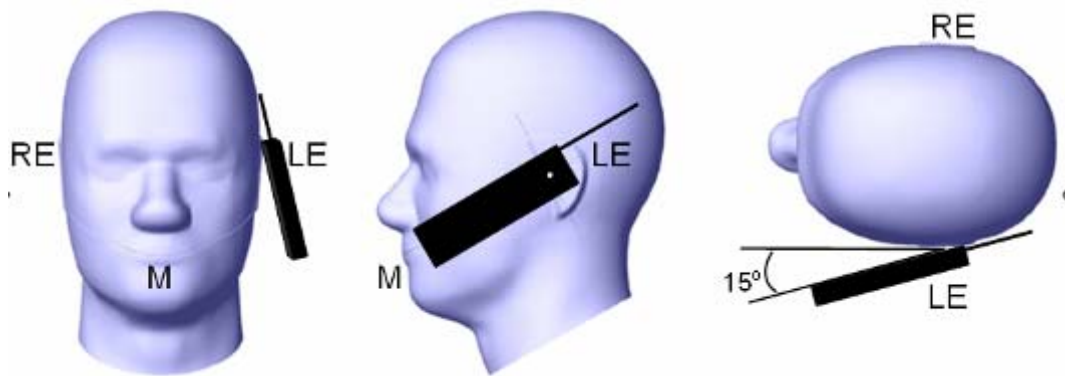

Test positions for body-worn and other configurations

Body-worn operating configurations should be tested with the belt-clips and holsters attached to the device and positioned against a flat phantom in normal use configurations. Devices with a headset output should be tested with a headset connected to the device. When multiple accessories that do not contain metallic components are supplied with the device, the device may be tested with only the accessory that dictates the closest spacing to the body. When multiple accessories that contain metallic components are supplied with the device, the device must be tested with each accessory that contains a unique metallic component. If multiple accessories share an identical metallic component (e.g., the same metallic belt-clip used with different holsters with no other metallic components), only the accessory that dictates the closest spacing to the body must be tested.

Body-worn accessories may not always be supplied or available as options for some devices that are intended to be authorized for body-worn use. A separation distance of 1.5 cm between the back of the device and a flat phantom is recommended for testing body-worn SAR compliance under such circumstances. Other separation distances may be used, but they should not exceed 2.5 cm. In these cases, the device may use body-worn accessories that provide a separation distance greater than that tested for the device provided however that the accessory contains no metallic components.

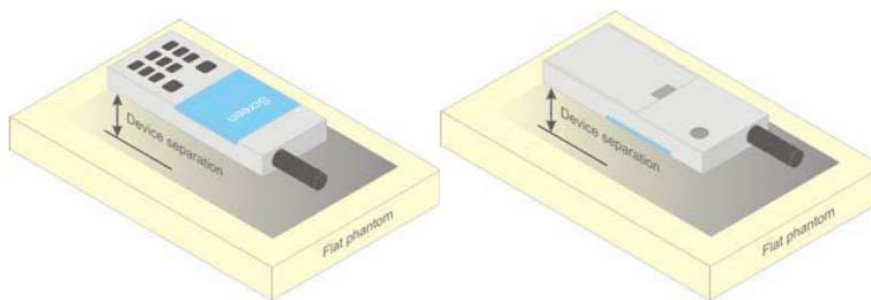

Figure 5 – Test positions for body-worn devices

Test Distance for SAR Evaluation

For Handheld mode(10g Extremity SAR) the EUT(Equipment Under Test) is set directly against the phantom, the test distance is 0mm;
 For Close to Body mode(1g Body SAR) the EUT is set 10mm away from the phantom, the test distance is 10mm.

SAR Evaluation Procedure

The evaluation was performed with the following procedure:

Step 1: Measurement of the SAR value at a fixed location above the ear point or central position was used as a reference value for assessing the power drop. The SAR at this point is measured at the start of the test and then again at the end of the testing.

Step 2: The SAR distribution at the exposed side of the head was measured at a distance of 4 mm from the inner surface of the shell. The area covered the entire dimension of the head or radiating structures of the EUT, the horizontal grid spacing was 10 mm x 10 mm, and the SAR distribution was determined by integrated grid of 1.0 mm x 1.0 mm. Based on these data, the area of the maximum absorption was determined by spline interpolation. The first Area Scan covers the entire dimension of the EUT to ensure that the hotspot was correctly identified.

Step 3: Around this point, a volume of 30 mm x 30 mm x 30 mm was assessed by measuring 7x 7 x 7 points. On the basis of this data set, the spatial peak SAR value was evaluated under the following procedure:

1) The data at the surface were extrapolated, since the center of the dipoles is 1.2 mm away from the tip of the probe and the distance between the surface and the lowest measuring point is 1.3 mm. The extrapolation was based on a least square algorithm. A polynomial of the fourth order was calculated through the points in z-axes. This polynomial was then used to evaluate the points between the surface and the probe tip.

2) The maximum interpolated value was searched with a straightforward algorithm. Around this maximum the SAR values averaged over the spatial volumes (1 g or 10 g) were computed by the 3D-Spline interpolation algorithm. The 3D-Spline is composed of three one dimensional splines with the "Not a knot"-condition (in x, y and z-directions). The volume was integrated with the trapezoidal-algorithm. One thousand points (10 x 10 x 10) were interpolated to calculate the averages.

All neighboring volumes were evaluated until no neighboring volume with a higher average value was found.

Step 4: Re-measurement of the SAR value at the same location as in Step 1. If the value changed by more than 5%, the evaluation was repeated.

CONDUCTED OUTPUT POWER MEASUREMENT

Test Procedure

The RF output of the transmitter was connected to the input port of the Power Meter through Combiner.

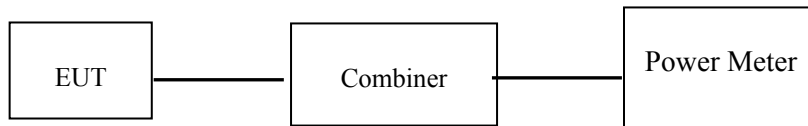

Maximum Target Output Power

Max Target Power(dBm)						
Mode/Band	Channel					
	Low		Middle		High	
	Chain 0	Chain 1	Chain 0	Chain 1	Chain 0	Chain 1
DTS 2.4G(5MHz)	20.2	20.5	20.2	20.5	20.2	20.5
DTS 2.4G(10MHz)	20.7	20.6	20.7	20.6	20.7	20.6
Wi-Fi 2.4G(802.11b)	11.7	10.9	11.7	10.9	11.7	10.9
Wi-Fi 2.4G(802.11g)	11.2	10.5	11.2	10.5	11.2	10.5
Wi-Fi 2.4G(802.11n HT20)	10.9	10.3	10.9	10.3	10.9	10.3
NII 5.8G(5MHz)	20.1	19.6	20.1	19.6	20.1	19.6
NII 5.8G(10MHz)	20	19.5	20	19.5	20	19.5
Wi-Fi 5.8G(802.11a)	20	19.6	20	19.6	20	19.6
Wi-Fi 5.8G(802.11n HT20)	20	19.5	20	19.5	20	19.5
Wi-Fi 5.8G(802.11n HT40)	20	19.6	/	/	20	19.6

Test Results:

DTS 2.4G:

Mode	Channel	Frequency (MHz)	RF Output Power (dBm)		
			Chain 0	Chain 1	Total
5 MHz	Low	2412	19.5	19.56	22.54
	Middel	2437	20.08	20.42	23.26
	High	2462	20.16	19.45	22.83
10 MHz	Low	2412	20.32	19.68	23.02
	Middel	2437	20.41	20.55	23.49
	High	2462	20.65	19.65	23.19

Wi-Fi 2.4G:

Mode	Channel	Frequency (MHz)	RF Output Power (dBm)		
			Chain 0	Chain 1	Total
802.11b	Low	2412	10.14	10.11	13.14
	Middel	2437	9.95	9.83	12.9
	High	2462	11.61	10.7	14.19
802.11g	Low	2412	9.86	9.96	12.92
	Middel	2437	9.25	9.04	12.16
	High	2462	10.98	10.37	13.7
802.11 n HT20	Low	2412	9.69	9.97	12.84
	Middel	2437	8.91	9.08	12.01
	High	2462	10.79	10.12	13.48

Note: The output power was tested under data rate 1Mbps for 802.11b, 6Mbps for 802.11g and MCS0 for 802.11n HT20.

NII 5.8G:

Mode	Channel	Frequency (MHz)	RF Output Power (dBm)		
			Chain 0	Chain 1	Total
5 MHz	Low	5745	19.9	19.4	22.67
	Middel	5785	19.51	19.31	22.42
	High	5825	19.2	19	22.11
10 MHz	Low	5745	19.82	19.39	22.62
	Middel	5785	19.36	19.37	22.38
	High	5825	19.54	19.1	22.34

Wi-Fi 5.8G:

Mode	Channel	Frequency (MHz)	RF Output Power (dBm)		
			Chain 0	Chain 1	Total
802.11a	Low	5745	19.87	19.47	22.68
	Middel	5785	19.82	19.33	22.59
	High	5825	19.47	19.24	22.37
802.11n20	Low	5745	19.77	19.34	22.57
	Middel	5785	19.35	19.19	22.28
	High	5825	19.29	19.17	22.24
802.11 n HT40	Low	5755	19.61	19.08	22.36
	High	5795	19.87	19.47	22.68

Note: The output power was tested under data rate 1Mbps for 802.11a ,6Mbps for 802.11n HT20 and MCS0 for 802.11n HT40.

SAR EXCLUSION CONSIDERATIONS

Antennas Location:

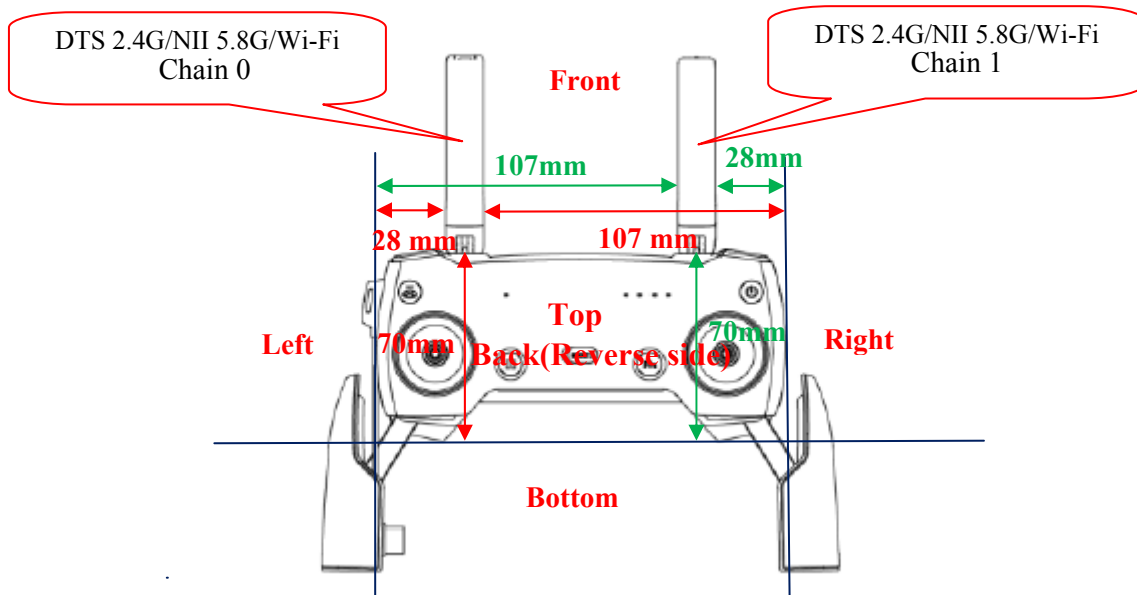

Antenna Distance To Edge

Antenna Distance To Edge(mm)						
Mode	Left	Right	Back	Front	Top	Bottom
DTS 2.4G/NII 5.8G/Wi-Fi Chain 0	28	107	27	0	10	70
DTS 2.4G/NII 5.8G/Wi-Fi Chain 1	107	28	27	0	10	70

SAR test exclusion for the EUT edge considerations(KDB)

Antenna Distance To Edge(mm)						
Mode	Left	Right	Back	Front	Top	Bottom
DTS 2.4G/NII 5.8G/Wi-Fi Chain 0	Exclusion	Exclusion	Exclusion	Required	Required	Exclusion
DTS 2.4G/NII 5.8G/Wi-Fi Chain 1	Exclusion	Exclusion	Exclusion	Required	Required	Exclusion

Note:

Required: Per KDB 941225 D07-The distance to Edge is less than 25mm, testing is required.
Exclusion: Per KDB 941225 D07-The distance to Edge is more than 25 mm, testing is not required.

SAR test exclusion for the EUT edge consideration(RSS-102)

Mode	Edge	Frequency (MHz)	Pavg (dBm)	Antenna Gain(dBi)	e.i.r.p. (mW)	Distance (mm)	Test exclusion Threshold (mW)	SAR Test required
DTS 2.4G(5MHz) Chain 0	Left	2462	20.2	5.51	372.39	28	70.63	Yes
	Right	2462	20.2	5.51	372.39	107	308.78	Yes
	Back	2462	20.2	5.51	372.39	27	64.43	Yes
	Front	2462	20.2	5.51	372.39	0	3.98	Yes
	Top	2462	20.2	5.51	372.39	10	6.99	Yes
	Bottom	2462	20.2	5.51	372.39	70	308.78	Yes
DTS 2.4G(5MHz) Chain 1	Left	2462	20.5	4.94	349.95	107	308.78	Yes
	Right	2462	20.5	4.94	349.95	28	70.63	Yes
	Back	2462	20.5	4.94	349.95	27	64.43	Yes
	Front	2462	20.5	4.94	349.95	0	3.98	Yes
	Top	2462	20.5	4.94	349.95	10	6.99	Yes
	Bottom	2462	20.5	4.94	349.95	70	308.78	Yes
DTS 2.4G(10MHz) Chain 0	Left	2462	20.7	5.51	417.83	28	70.63	Yes
	Right	2462	20.7	5.51	417.83	107	308.78	Yes
	Back	2462	20.7	5.51	417.83	27	64.43	Yes
	Front	2462	20.7	5.51	417.83	0	3.98	Yes
	Top	2462	20.7	5.51	417.83	10	6.99	Yes
	Bottom	2462	20.7	5.51	417.83	70	308.78	Yes
DTS 2.4G(10MHz) Chain 1	Left	2462	20.6	4.94	358.1	107	308.78	Yes
	Right	2462	20.6	4.94	358.1	28	70.63	Yes
	Back	2462	20.6	4.94	358.1	27	64.43	Yes
	Front	2462	20.6	4.94	358.1	0	3.98	Yes
	Top	2462	20.6	4.94	358.1	10	6.99	Yes
	Bottom	2462	20.6	4.94	358.1	70	308.78	Yes
Wi-Fi 2.4G Chain 0	Left	2462	11.7	5.51	52.6	28	70.63	No
	Right	2462	11.7	5.51	52.6	107	308.78	No
	Back	2462	11.7	5.51	52.6	27	64.43	No
	Front	2462	11.7	5.51	52.6	0	3.98	Yes
	Top	2462	11.7	5.51	52.6	10	6.99	Yes
	Bottom	2462	11.7	5.51	52.6	70	308.78	No
Wi-Fi 2.4G Chain 1	Left	2462	10.9	4.94	38.37	107	308.78	No
	Right	2462	10.9	4.94	38.37	28	70.63	No
	Back	2462	10.9	4.94	38.37	27	64.43	No
	Front	2462	10.9	4.94	38.37	0	3.98	Yes
	Top	2462	10.9	4.94	38.37	10	6.99	Yes
	Bottom	2462	10.9	4.94	38.37	70	308.78	No

Mode	Edge	Frequency (MHz)	Pavg (dBm)	Antenna Gain(dBi)	e.i.r.p. (mW)	Distance (mm)	Test exclusion Threshold (mW)	SAR Test required
NII 5.8G(5MHz) Chain 0	Left	5785	20.1	3.74	242.1	28	50.15	Yes
	Right	5785	20.1	3.74	242.1	107	107.2	Yes
	Back	5785	20.1	3.74	242.1	27	47.13	Yes
	Front	5785	20.1	3.74	242.1	0	1.01	Yes
	Top	5785	20.1	3.74	242.1	10	6	Yes
	Bottom	5785	20.1	3.74	242.1	70	107.2	Yes
NII 5.8G(5MHz) Chain 1	Left	5785	19.6	3.09	185.78	107	107.2	Yes
	Right	5785	19.6	3.09	185.78	28	50.15	Yes
	Back	5785	19.6	3.09	185.78	27	47.13	Yes
	Front	5785	19.6	3.09	185.78	0	1.01	Yes
	Top	5785	19.6	3.09	185.78	10	6	Yes
	Bottom	5785	19.6	3.09	185.78	70	107.2	Yes
NII 5.8G(10MHz) Chain 0	Left	5785	20	3.74	236.59	28	50.15	Yes
	Right	5785	20	3.74	236.59	107	107.2	Yes
	Back	5785	20	3.74	236.59	27	47.13	Yes
	Front	5785	20	3.74	236.59	0	1.01	Yes
	Top	5785	20	3.74	236.59	10	6	Yes
	Bottom	5785	20	3.74	236.59	70	107.2	Yes
NII 5.8G(10MHz) Chain 1	Left	5785	19.5	3.09	181.55	107	107.2	Yes
	Right	5785	19.5	3.09	181.55	28	50.15	Yes
	Back	5785	19.5	3.09	181.55	27	47.13	Yes
	Front	5785	19.5	3.09	181.55	0	1.01	Yes
	Top	5785	19.5	3.09	181.55	10	6	Yes
	Bottom	5785	19.5	3.09	181.55	70	107.2	Yes
Wi-Fi 5.8G Chain 0	Left	5785	20	3.74	236.59	28	50.15	Yes
	Right	5785	20	3.74	236.59	107	107.2	Yes
	Back	5785	20	3.74	236.59	27	47.13	Yes
	Front	5785	20	3.74	236.59	0	1.01	Yes
	Top	5785	20	3.74	236.59	10	6	Yes
	Bottom	5785	20	3.74	236.59	70	107.2	Yes
Wi-Fi 5.8G Chain 1	Left	5785	19.6	3.09	185.78	107	107.2	Yes
	Right	5785	19.6	3.09	185.78	28	50.15	Yes
	Back	5785	19.6	3.09	185.78	27	47.13	Yes
	Front	5785	19.6	3.09	185.78	0	1.01	Yes
	Top	5785	19.6	3.09	185.78	10	6	Yes
	Bottom	5785	19.6	3.09	185.78	70	107.2	Yes

Note:

1. According to RSS-102, the antenna gain is > 0 , e.i.r.p is used for exemption evaluation.
2. When the operating frequency of the device is between two frequencies located in Table 1 of **RSS-102 Issue 5 March 2015**, linear interpolation shall be applied for the applicable separation distance.

SAR MEASUREMENT RESULTS

This page summarizes the results of the performed dosimetric evaluation.

SAR Test Data

Environmental Conditions

Temperature:	22.3-23.5°C	22.5-23.4°C	22.2-23.6°C	22.4-23.7°C
Relative Humidity:	42%	43%	41%	46%
ATM Pressure:	1019 mbar	1019 mbar	1016 mbar	1010 mbar
Test Date:	2017/11/01	2017/11/02	2017/11/03	2017/11/04

Temperature:	22.3-23.6°C	22.1-23.4°C	22.3-23.2°C
Relative Humidity:	43%	42%	41%
ATM Pressure:	1012 mbar	1016 mbar	1016 mbar
Test Date:	2017/11/05	2017/11/06	2017/11/07

Testing was performed by Yun Yu, Brave Lu, Jayce Chen

Chain 0:

DTS 2.4G(5MHz):

EUT Position	Frequency (MHz)	Power Drift (dB)	Max. Meas. Power (dBm)	Max. Rated Power (dBm)	10 g SAR (W/kg)				
					Scaled Factor	Meas. SAR	Scaled SAR	Corrected SAR	Plot
Handheld-Left (0mm)	2412	/	/	/	/	/	/	/	/
	2437	0.16	20.08	20.2	1.028	0.152	0.156	0.16	1#
	2462	/	/	/	/	/	/	/	/
Handheld-Right (0mm)	2412	/	/	/	/	/	/	/	/
	2437	/	20.08	20.2	1.028	< 0.01	0.01	0.01	/
	2462	/	/	/	/	/	/	/	/
Handheld-Back (0mm)	2412	/	/	/	/	/	/	/	/
	2437	-0.20	20.08	20.2	1.028	0.154	0.158	0.16	2#
	2462	/	/	/	/	/	/	/	/
Handheld-Back (0mm) Antenna Fold	2412	/	/	/	/	/	/	/	/
	2437	/	20.08	20.2	1.028	< 0.01	0.01	0.01	/
	2462	/	/	/	/	/	/	/	/
Handheld-Front (0mm)	2412	-0.03	19.5	20.2	1.175	1.91	2.244	2.25	3#
	2437	-0.19	20.08	20.2	1.028	1.93	1.984	1.99	4#
	2462	0.13	20.16	20.2	1.009	1.95	1.968	1.97	5#
Handheld-Top (0mm)	2412	/	/	/	/	/	/	/	/
	2437	0.18	20.08	20.2	1.028	0.443	0.455	0.46	6#
	2462	/	/	/	/	/	/	/	/
Handheld-Bottom (0mm)	2412	/	/	/	/	/	/	/	/
	2437	/	20.08	20.2	1.028	< 0.01	0.01	0.01	/
	2462	/	/	/	/	/	/	/	/

Test Date:2017/11/01

EUT Position	Frequency (MHz)	Power Drift (dB)	Max. Meas. Power (dBm)	Max. Rated Power (dBm)	1 g SAR (W/kg)				
					Scaled Factor	Meas. SAR	Scaled SAR	Corrected SAR	Plot
Close to Body-Left (10mm)	2412	/	/	/	/	/	/	/	/
	2437	0.18	20.08	20.2	1.028	0.098	0.101	0.10	7#
	2462	/	/	/	/	/	/	/	/
Close to Body-Right (10mm)	2412	/	/	/	/	/	/	/	/
	2437	/	20.08	20.2	1.028	< 0.01	0.01	0.01	/
	2462	/	/	/	/	/	/	/	/
Close to Body-Back (10mm)	2412	/	/	/	/	/	/	/	/
	2437	0.08	20.08	20.2	1.028	0.117	0.120	0.12	8#
	2462	/	/	/	/	/	/	/	/
Close to Body-Back (10mm) Antenna Fold	2412	/	/	/	/	/	/	/	/
	2437	/	20.08	20.2	1.028	< 0.01	0.01	0.01	/
	2462	/	/	/	/	/	/	/	/
Close to Body-Front (10mm)	2412	0.17	19.5	20.2	1.175	1.03	1.210	1.21	9#
	2437	0.03	20.08	20.2	1.028	1.14	1.172	1.18	10#
	2462	0.09	20.16	20.2	1.009	1.2	1.211	1.21	11#
Close to Body-Top (10mm)	2412	/	/	/	/	/	/	/	/
	2437	-0.14	20.08	20.2	1.028	0.388	0.399	0.40	12#
	2462	/	/	/	/	/	/	/	/
Close to Body-Bottom (10mm)	2412	/	/	/	/	/	/	/	/
	2437	/	20.08	20.2	1.028	< 0.01	0.01	0.01	/
	2462	/	/	/	/	/	/	/	/

Test Date:2017/11/01

DTS 2.4G(10MHz):

EUT Position	Frequency (MHz)	Power Drift (dB)	Max. Meas. Power (dBm)	Max. Rated Power (dBm)	10 g SAR (W/kg)				
					Scaled Factor	Meas. SAR	Scaled SAR	Corrected SAR	Plot
Handheld-Left (0mm)	2412								/
	2437	0.20	20.41	20.7	1.069	0.148	0.158	0.16	13#
	2462	/	/	/	/	/	/	/	/
Handheld-Right (0mm)	2412	/	/	/	/	/	/	/	/
	2437	/	20.41	20.7	1.069	< 0.01	0.01	0.01	/
	2462	/	/	/	/	/	/	/	/
Handheld-Back (0mm)	2412	/	/	/	/	/	/	/	/
	2437	0.11	20.41	20.7	1.069	0.151	0.161	0.16	14#
	2462	/	/	/	/	/	/	/	/
Handheld-Back (0mm) Antenna Fold	2412	/	/	/	/	/	/	/	/
	2437	/	20.41	20.7	1.069	< 0.01	0.01	0.01	/
	2462	/	/	/	/	/	/	/	/
Handheld-Front (0mm)	2412	-0.16	20.32	20.7	1.091	1.71	1.866	1.87	15#
	2437	0.12	20.41	20.7	1.069	1.9	2.031	2.03	16#
	2462	-0.13	20.65	20.7	1.012	1.87	1.892	1.89	17#
Handheld-Top (0mm)	2412	/	/	/	/	/	/	/	/
	2437	-0.16	20.41	20.7	1.069	0.479	0.512	0.51	18#
	2462	/	/	/	/	/	/	/	/
Handheld-Bottom (0mm)	2412	/	/	/	/	/	/	/	/
	2437	/	20.41	20.7	1.069	< 0.01	0.01	0.01	/
	2462	/	/	/	/	/	/	/	/

Test Date:2017/11/01

EUT Position	Frequency (MHz)	Power Drift (dB)	Max. Meas. Power (dBm)	Max. Rated Power (dBm)	1 g SAR (W/kg)				
					Scaled Factor	Meas. SAR	Scaled SAR	Corrected SAR	Plot
Close to Body-Left (10mm)	2412	/	/	/	/	/	/	/	/
	2437	0.10	20.41	20.7	1.069	0.094	0.10	0.10	19#
	2462	/	/	/	/	/	/	/	/
Close to Body-Right (10mm)	2412	/	/	/	/	/	/	/	/
	2437	/	20.41	20.7	1.069	< 0.01	0.01	0.01	/
	2462	/	/	/	/	/	/	/	/
Close to Body-Back (10mm)	2412	/	/	/	/	/	/	/	/
	2437	-0.12	20.41	20.7	1.069	0.117	0.125	0.13	20#
	2462	/	/	/	/	/	/	/	/
Close to Body-Back (10mm) Antenna Fold	2412	/	/	/	/	/	/	/	/
	2437	/	20.41	20.7	1.069	< 0.01	0.01	0.01	/
	2462	/	/	/	/	/	/	/	/
Close to Body-Front (10mm)	2412	0.11	20.32	20.7	1.091	1.18	1.287	1.29	21#
	2437	0.13	20.41	20.7	1.069	1.24	1.326	1.33	22#
	2462	0.20	20.65	20.7	1.012	1.3	1.316	1.32	23#
Close to Body-Top (10mm)	2412	/	/	/	/	/	/	/	/
	2437	0.14	20.41	20.7	1.069	0.393	0.42	0.42	24#
	2462	/	/	/	/	/	/	/	/
Close to Body-Bottom (10mm)	2412	/	/	/	/	/	/	/	/
	2437	/	20.41	20.7	1.069	< 0.01	0.01	0.01	/
	2462	/	/	/	/	/	/	/	/

Test Date:2017/11/02

Note:

1. When the SAR value is less than half of the limit, testing for other channels are optional.
2. When SAR or MPE is not measured at the maximum power level allowed for production units, the results must be scaled to the maximum tune-up tolerance limit according to the power applied to the individual channels tested to determine compliance.
3. For modes that peak SAR is too low to evaluate, a SAR value 0.01W/kg is considered as their Scaled SAR.
4. According to IEC 62209-2:2010 ,If the correction ΔSAR has a positive sign, the measured SAR results shall not be corrected.

Wi-Fi 2.4G:

EUT Position	Mode	Frequency (MHz)	Power Drift (dB)	Max. Meas. Power (dBm)	Max. Rated Power (dBm)	10 g SAR (W/kg)				
						Scaled Factor	Meas. SAR	Scaled SAR	Corrected SAR	Plot
Handheld-Front (0mm)	802.11b	2412	0.11	10.14	11.7	1.432	0.285	0.408	0.41	25#
	802.11b	2437	0.14	9.95	11.7	1.496	0.192	0.287	0.29	26#
	802.11b	2462	0.12	11.61	11.7	1.021	0.304	0.310	0.31	27#
Handheld-Top (0mm)	802.11b	2412	/	/	/	/	/	/	/	/
	802.11b	2437	/	/	/	/	/	/	/	/
	802.11b	2462	0.11	11.61	11.7	1.021	0.062	0.063	0.06	28#

Test Date:2017/11/01

EUT Position	Mode	Frequency (MHz)	Power Drift (dB)	Max. Meas. Power (dBm)	Max. Rated Power (dBm)	1 g SAR (W/kg)				
						Scaled Factor	Meas. SAR	Scaled SAR	Corrected SAR	Plot
Close to Body-Front (10mm)	802.11b	2412	-0.16	10.14	11.7	1.432	0.217	0.311	0.31	29#
	802.11b	2437	-0.14	9.95	11.7	1.496	0.136	0.203	0.21	30#
	802.11b	2462	-0.18	11.61	11.7	1.021	0.199	0.203	0.20	31#
Close to Body-Top (10mm)	802.11b	2412	/	/	/	/	/	/	/	/
	802.11b	2437	/	/	/	/	/	/	/	/
	802.11b	2462	-0.17	11.61	11.7	1.021	0.067	0.068	0.07	32#

Test Date:2017/11/02

Note:

1. When the SAR value is less than half of the limit, testing for other channels are optional.
2. When SAR or MPE is not measured at the maximum power level allowed for production units, the results must be scaled to the maximum tune-up tolerance limit according to the power applied to the individual channels tested to determine compliance.
3. KDB 248227 D01-SAR is not required for 2.4 GHz OFDM when the highest reported SAR for DSSS is not higher than 1.2W/kg and the target power for OFDM is not higher than DSSS mode.
4. According to IEC 62209-2:2010 ,If the correction ΔSAR has a positive sign, the measured SAR results shall not be corrected.

NII 5.8G(5MHz):

EUT Position	Frequency (MHz)	Power Drift (dB)	Max. Meas. Power (dBm)	Max. Rated Power (dBm)	10 g SAR (W/kg)				
					Scaled Factor	Meas. SAR	Scaled SAR	Corrected SAR	Plot
Handheld-Left (0mm)	5745	/	/	/	/	/	/	/	/
	5785	0.15	19.51	20.1	1.146	0.368	0.422	0.42	33#
	5825	/	/	/	/	/	/	/	/
Handheld-Right (0mm)	5745	/	/	/	/	/	/	/	/
	5785	/	19.51	20.1	1.146	< 0.01	0.01	0.01	/
	5825	/	/	/	/	/	/	/	/
Handheld-Back (0mm)	5745	/	/	/	/	/	/	/	/
	5785	0.14	19.51	20.1	1.146	0.421	0.482	0.48	34#
	5825	/	/	/	/	/	/	/	/
Handheld-Back (0mm) Antenna Fold	5745	/	/	/	/	/	/	/	/
	5785	/	19.51	20.1	1.146	< 0.01	0.01	0.01	/
	5825	/	/	/	/	/	/	/	/
Handheld-Front (0mm)	5745	0.13	19.9	20.1	1.047	2.47	2.586	2.59	35#
	5785	0.09	19.51	20.1	1.146	2.01	2.303	2.31	36#
	5825	0.17	19.2	20.1	1.23	2.29	2.817	2.83	37#
Handheld-Top (0mm)	5745	/	/	/	/	/	/	/	/
	5785	-0.14	19.51	20.1	1.146	0.714	0.818	0.82	38#
	5825	/	/	/	/	/	/	/	/
Handheld-Bottom (0mm)	5745	/	/	/	/	/	/	/	/
	5785	/	19.51	20.1	1.146	< 0.01	0.01	0.01	/
	5825	/	/	/	/	/	/	/	/

Test Date:2017/11/04

EUT Position	Frequency (MHz)	Power Drift (dB)	Max. Meas. Power (dBm)	Max. Rated Power (dBm)	1 g SAR (W/kg)				
					Scaled Factor	Meas. SAR	Scaled SAR	Corrected SAR	Plot
Close to Body-Left (10mm)	5745	/	/	/	/	/	/	/	/
	5785	0.01	19.51	20.1	1.146	0.352	0.403	0.40	39#
	5825	/	/	/	/	/	/	/	/
Close to Body-Right (10mm)	5745	/	/	/	/	/	/	/	/
	5785	/	19.51	20.1	1.146	< 0.01	0.01	0.01	/
	5825	/	/	/	/	/	/	/	/
Close to Body-Back (10mm)	5745	/	/	/	/	/	/	/	/
	5785	0.03	19.51	20.1	1.146	0.496	0.568	0.57	40#
	5825	/	/	/	/	/	/	/	/
Close to Body-Back (10mm) Antenna Fold	5745	/	/	/	/	/	/	/	/
	5785	/	19.51	20.1	1.146	< 0.01	0.01	0.01	/
	5825	/	/	/	/	/	/	/	/
Close to Body-Front (10mm)	5745	0.14	19.9	20.1	1.047	1.25	1.309	1.31	41#
	5785	0.15	19.51	20.1	1.146	1.13	1.295	1.30	42#
	5825	0.14	19.2	20.1	1.23	0.995	1.224	1.23	43#
Close to Body-Top (10mm)	5745	/	/	/	/	/	/	/	/
	5785	-0.11	19.51	20.1	1.146	0.687	0.787	0.79	44#
	5825	/	/	/	/	/	/	/	/
Close to Body-Bottom (10mm)	5745	/	/	/	/	/	/	/	/
	5785	/	19.51	20.1	1.146	< 0.01	0.01	0.01	/
	5825	/	/	/	/	/	/	/	/

Test Date:2017/11/04

NII 5.8G(10MHz):

EUT Position	Frequency (MHz)	Power Drift (dB)	Max. Meas. Power (dBm)	Max. Rated Power (dBm)	10 g SAR (W/kg)				
					Scaled Factor	Meas. SAR	Scaled SAR	Corrected SAR	Plot
Handheld-Left (0mm)	5745	/	/	/	/	/	/	/	/
	5785	-0.17	19.36	20	1.159	0.204	0.236	0.24	45#
	5825	/	/	/	/	/	/	/	/
Handheld-Right (0mm)	5745	/	/	/	/	/	/	/	/
	5785	/	19.36	20	1.159	< 0.01	0.01	0.01	/
	5825	/	/	/	/	/	/	/	/
Handheld-Back (0mm)	5745	/	/	/	/	/	/	/	/
	5785	-0.17	19.36	20	1.159	0.430	0.498	0.50	46#
	5825	/	/	/	/	/	/	/	/
Handheld-Back (0mm) Antenna Fold	5745	/	/	/	/	/	/	/	/
	5785	/	19.36	20	1.159	< 0.01	0.01	0.01	/
	5825	/	/	/	/	/	/	/	/
Handheld-Front (0mm)	5745	0.19	19.82	20	1.042	2.75	2.866	2.87	47#
	5785	-0.02	19.36	20	1.159	2.48	2.874	2.89	48#
	5825	-0.08	19.54	20	1.112	2.56	2.847	2.85	49#
Handheld-Top (0mm)	5745	/	/	/	/	/	/	/	/
	5785	-0.13	19.36	20	1.159	0.790	0.916	0.92	50#
	5825	/	/	/	/	/	/	/	/
Handheld-Bottom (0mm)	5745	/	/	/	/	/	/	/	/
	5785	/	19.36	20	1.159	< 0.01	0.01	0.01	/
	5825	/	/	/	/	/	/	/	/

Test Date:2017/11/04

EUT Position	Frequency (MHz)	Power Drift (dB)	Max. Meas. Power (dBm)	Max. Rated Power (dBm)	1 g SAR (W/kg)				
					Scaled Factor	Meas. SAR	Scaled SAR	Corrected SAR	Plot
Close to Body-Left (10mm)	5745	/	/	/	/	/	/	/	/
	5785	-0.13	19.36	20	1.159	0.210	0.243	0.24	51#
	5825	/	/	/	/	/	/	/	/
Close to Body-Right (10mm)	5745	/	/	/	/	/	/	/	/
	5785	/	19.36	20	1.159	< 0.01	0.01	0.01	/
	5825	/	/	/	/	/	/	/	/
Close to Body-Back (10mm)	5745	/	/	/	/	/	/	/	/
	5785	-0.19	19.36	20	1.159	0.607	0.704	0.71	52#
	5825	/	/	/	/	/	/	/	/
Close to Body-Back (10mm) Antenna Fold	5745	/	/	/	/	/	/	/	/
	5785	/	19.36	20	1.159	< 0.01	0.01	0.01	/
	5825	/	/	/	/	/	/	/	/
Close to Body-Front (10mm)	5745	0.18	19.82	20	1.042	0.997	1.039	1.04	53#
	5785	0.11	19.36	20	1.159	0.932	1.080	1.08	54#
	5825	0.03	19.54	20	1.112	0.815	0.906	0.91	55#
Close to Body-Top (10mm)	5745	/	/	/	/	/	/	/	/
	5785	0.11	19.36	20	1.159	0.649	0.752	0.75	56#
	5825	/	/	/	/	/	/	/	/
Close to Body-Bottom (10mm)	5745	/	/	/	/	/	/	/	/
	5785	/	19.36	20	1.159	< 0.01	0.01	0.01	/
	5825	/	/	/	/	/	/	/	/

Test Date:2017/11/05

Note:

1. When the SAR value is less than half of the limit, testing for other channels are optional.
2. When SAR or MPE is not measured at the maximum power level allowed for production units, the results must be scaled to the maximum tune-up tolerance limit according to the power applied to the individual channels tested to determine compliance.
3. For modes that peak SAR is too low to evaluate, a SAR value 0.01W/kg is considered as their Scaled SAR.
4. According to IEC 62209-2:2010 ,If the correction ΔSAR has a positive sign, the measured SAR results shall not be corrected.

Wi-Fi 5.8G:

EUT Position	Mode	Frequency (MHz)	Power Drift (dB)	Max. Meas. Power (dBm)	Max. Rated Power (dBm)	10 g SAR (W/kg)				
						Scaled Factor	Meas. SAR	Scaled SAR	Corrected SAR	Plot
Handheld-Left (0mm)	802.11a	5745	/	/	/	/	/	/	/	/
	802.11a	5785	-0.16	19.82	20	1.042	0.265	0.276	0.28	57#
	802.11a	5825	/	/	/	/	/	/	/	/
Handheld-Right (0mm)	802.11a	5745	/	/	/	/	/	/	/	/
	802.11a	5785	/	19.82	20	1.042	< 0.01	0.01	0.01	/
	802.11a	5825	/	/	/	/	/	/	/	/
Handheld-Back (0mm)	802.11a	5745	/	/	/	/	/	/	/	/
	802.11a	5785	0.18	19.82	20	1.042	0.407	0.424	0.43	58#
	802.11a	5825	/	/	/	/	/	/	/	/
Handheld-Back (0mm) Antenna Fold	802.11a	5745	/	/	/	/	/	/	/	/
	802.11a	5785	/	19.82	20	1.042	< 0.01	0.01	0.01	/
	802.11a	5825	/	/	/	/	/	/	/	/
Handheld-Front (0mm)	802.11a	5745	-0.19	19.87	20	1.03	2.03	2.091	2.10	59#
	802.11a	5785	-0.20	19.82	20	1.042	1.95	2.032	2.04	60#
	802.11a	5825	-0.16	19.47	20	1.13	1.79	2.023	2.03	61#
Handheld-Top (0mm)	802.11a	5745	/	/	/	/	/	/	/	/
	802.11a	5785	-0.09	19.82	20	1.042	0.616	0.642	0.64	62#
	802.11a	5825	/	/	/	/	/	/	/	/
Handheld-Bottom (0mm)	802.11a	5745	/	/	/	/	/	/	/	/
	802.11a	5785	/	19.82	20	1.042	< 0.01	0.01	0.01	/
	802.11a	5825	/	/	/	/	/	/	/	/

Test Date:2017/11/05

EUT Position	Mode	Frequency (MHz)	Power Drift (dB)	Max. Meas. Power (dBm)	Max. Rated Power (dBm)	1 g SAR (W/kg)				
						Scaled Factor	Meas. SAR	Scaled SAR	Corrected SAR	Plot
Close to Body-Left (10mm)	802.11a	5745	/	/	/	/	/	/	/	/
	802.11a	5785	-0.11	19.82	20	1.042	0.305	0.318	0.32	63#
	802.11a	5825	/	/	/	/	/	/	/	/
Close to Body-Right (10mm)	802.11a	5745	/	/	/	/	/	/	/	/
	802.11a	5785	/	19.82	20	1.042	< 0.01	0.01	0.01	/
	802.11a	5825	/	/	/	/	/	/	/	/
Close to Body-Back (10mm)	802.11a	5745	/	/	/	/	/	/	/	/
	802.11a	5785	-0.15	19.82	20	1.042	0.241	0.251	0.25	64#
	802.11a	5825	/	/	/	/	/	/	/	/
Close to Body-Back (10mm) Antenna Fold	802.11a	5745	/	/	/	/	/	/	/	/
	802.11a	5785	/	19.82	20	1.042	< 0.01	0.01	0.01	/
	802.11a	5825	/	/	/	/	/	/	/	/
Close to Body-Front (10mm)	802.11a	5745	-0.18	19.87	20	1.03	1.24	1.277	1.28	65#
	802.11a	5785	-0.15	19.82	20	1.042	1.26	1.313	1.32	66#
	802.11a	5825	-0.13	19.47	20	1.13	1.15	1.3	1.30	67#
Close to Body-Top (10mm)	802.11a	5745	/	/	/	/	/	/	/	/
	802.11a	5785	-0.14	19.82	20	1.042	0.675	0.703	0.71	68#
	802.11a	5825	/	/	/	/	/	/	/	/
Close to Body-Bottom (10mm)	802.11a	5745	/	/	/	/	/	/	/	/
	802.11a	5785	/	19.82	20	1.042	< 0.01	0.01	0.01	/
	802.11a	5825	/	/	/	/	/	/	/	/

Test Date:2017/11/05

Note:

1. When the SAR value is less than half of the limit, testing for other channels are optional.
2. When SAR or MPE is not measured at the maximum power level allowed for production units, the results must be scaled to the maximum tune-up tolerance limit according to the power applied to the individual channels tested to determine compliance.
3. According to IEC 62209-2:2010 ,If the correction ΔSAR has a positive sign, the measured SAR results shall not be corrected.

Chain 1:

DTS 2.4G(5MHz):

EUT Position	Frequency (MHz)	Power Drift (dB)	Max. Meas. Power (dBm)	Max. Rated Power (dBm)	10 g SAR (W/kg)				
					Scaled Factor	Meas. SAR	Scaled SAR	Corrected SAR	Plot
Handheld-Left (0mm)	2412	/	/	/	/	/	/	/	/
	2437	/	20.42	20.5	1.019	< 0.01	0.01	0.01	/
	2462	/	/	/	/	/	/	/	/
Handheld-Right (0mm)	2412	/	/	/	/	/	/	/	/
	2437	0.15	20.42	20.5	1.019	0.104	0.106	0.11	69#
	2462	/	/	/	/	/	/	/	/
Handheld-Back (0mm)	2412	/	/	/	/	/	/	/	/
	2437	0.06	20.42	20.5	1.019	0.115	0.117	0.12	70#
	2462	/	/	/	/	/	/	/	/
Handheld-Back (0mm) Antenna Fold	2412	/	/	/	/	/	/	/	/
	2437	/	20.42	20.5	1.019	< 0.01	0.01	0.01	/
	2462	/	/	/	/	/	/	/	/
Handheld-Front (0mm)	2412	-0.11	19.56	20.5	1.242	1.11	1.379	1.38	71#
	2437	-0.17	20.42	20.5	1.019	1.37	1.396	1.40	72#
	2462	-0.01	19.45	20.5	1.274	1.23	1.567	1.57	73#
Handheld-Top (0mm)	2412	/	/	/	/	/	/	/	/
	2437	0.11	20.42	20.5	1.019	0.428	0.436	0.44	74#
	2462	/	/	/	/	/	/	/	/
Handheld-Bottom (0mm)	2412	/	/	/	/	/	/	/	/
	2437	/	20.42	20.5	1.019	< 0.01	0.01	0.01	/
	2462	/	/	/	/	/	/	/	/

Test Date:2017/11/02

EUT Position	Frequency (MHz)	Power Drift (dB)	Max. Meas. Power (dBm)	Max. Rated Power (dBm)	1 g SAR (W/kg)				
					Scaled Factor	Meas. SAR	Scaled SAR	Corrected SAR	Plot
Close to Body-Left (10mm)	2412	/	/	/	/	/	/	/	/
	2437	/	20.42	20.5	1.019	< 0.01	0.01	0.01	/
	2462	/	/	/	/	/	/	/	/
Close to Body-Right (10mm)	2412	/	/	/	/	/	/	/	/
	2437	0.16	20.42	20.5	1.019	0.086	0.088	0.09	75#
	2462	/	/	/	/	/	/	/	/
Close to Body-Back (10mm)	2412	/	/	/	/	/	/	/	/
	2437	0.12	20.42	20.5	1.019	0.100	0.102	0.10	76#
	2462	/	/	/	/	/	/	/	/
Close to Body-Back (10mm) Antenna Fold	2412	/	/	/	/	/	/	/	/
	2437	/	20.42	20.5	1.019	< 0.01	0.01	0.01	/
	2462	/	/	/	/	/	/	/	/
Close to Body-Front (10mm)	2412	-0.02	19.56	20.5	1.242	0.733	0.910	0.91	77#
	2437	0.15	20.42	20.5	1.019	0.904	0.921	0.92	78#
	2462	0.03	19.45	20.5	1.274	0.712	0.907	0.91	79#
Close to Body-Top (10mm)	2412	/	/	/	/	/	/	/	/
	2437	-0.11	20.42	20.5	1.019	0.382	0.389	0.39	80#
	2462	/	/	/	/	/	/	/	/
Close to Body-Bottom (10mm)	2412	/	/	/	/	/	/	/	/
	2437	/	20.42	20.5	1.019	< 0.01	0.01	0.01	/
	2462	/	/	/	/	/	/	/	/

Test Date:2017/11/02

DTS 2.4G(10MHz):

EUT Position	Frequency (MHz)	Power Drift (dB)	Max. Meas. Power (dBm)	Max. Rated Power (dBm)	10 g SAR (W/kg)				
					Scaled Factor	Meas. SAR	Scaled SAR	Corrected SAR	Plot
Handheld-Left (0mm)	2412	/	/	/	/	/	/	/	/
	2437	/	20.55	20.6	1.012	< 0.01	0.01	0.01	/
	2462	/	/	/	/	/	/	/	/
Handheld-Right (0mm)	2412	/	/	/	/	/	/	/	/
	2437	0.04	20.55	20.6	1.012	0.109	0.110	0.11	81#
	2462	/	/	/	/	/	/	/	/
Handheld-Back (0mm)	2412	/	/	/	/	/	/	/	/
	2437	0.02	20.55	20.6	1.012	0.115	0.116	0.12	82#
	2462	/	/	/	/	/	/	/	/
Handheld-Back (0mm) Antenna Fold	2412	/	/	/	/	/	/	/	/
	2437	/	20.55	20.6	1.012	< 0.01	0.01	0.01	/
	2462	/	/	/	/	/	/	/	/
Handheld-Front (0mm)	2412	-0.20	19.68	20.6	1.236	1.11	1.372	1.37	83#
	2437	0.18	20.55	20.6	1.012	1.29	1.305	1.31	84#
	2462	-0.15	19.65	20.6	1.245	1.26	1.569	1.58	85#
Handheld-Top (0mm)	2412	/	/	/	/	/	/	/	/
	2437	0.20	20.55	20.6	1.012	0.404	0.409	0.41	86#
	2462	/	/	/	/	/	/	/	/
Handheld-Bottom (0mm)	2412	/	/	/	/	/	/	/	/
	2437	/	20.55	20.6	1.012	< 0.01	0.01	0.01	/
	2462	/	/	/	/	/	/	/	/

Test Date:2017/11/03

EUT Position	Frequency (MHz)	Power Drift (dB)	Max. Meas. Power (dBm)	Max. Rated Power (dBm)	1 g SAR (W/kg)				
					Scaled Factor	Meas. SAR	Scaled SAR	Corrected SAR	Plot
Close to Body-Left (10mm)	2412	/	/	/	/	/	/	/	/
	2437	/	20.55	20.6	1.012	< 0.01	0.01	0.01	/
	2462	/	/	/	/	/	/	/	/
Close to Body-Right (10mm)	2412	/	/	/	/	/	/	/	/
	2437	-0.07	20.55	20.6	1.012	0.093	0.094	0.09	87#
	2462	/	/	/	/	/	/	/	/
Close to Body-Back (10mm)	2412	/	/	/	/	/	/	/	/
	2437	0.07	20.55	20.6	1.012	0.110	0.111	0.11	88#
	2462	/	/	/	/	/	/	/	/
Close to Body-Back (10mm) Antenna Fold	2412	/	/	/	/	/	/	/	/
	2437	/	20.55	20.6	1.012	< 0.01	0.01	0.01	/
	2462	/	/	/	/	/	/	/	/
Close to Body-Front (10mm)	2412	-0.16	19.68	20.6	1.236	0.883	1.091	1.09	89#
	2437	0.17	20.55	20.6	1.012	1.11	1.123	1.13	90#
	2462	-0.16	19.65	20.6	1.245	0.891	1.109	1.12	91#
Close to Body-Top (10mm)	2412	/	/	/	/	/	/	/	/
	2437	0.20	20.55	20.6	1.012	0.588	0.595	0.60	92#
	2462	/	/	/	/	/	/	/	/
Close to Body-Bottom (10mm)	2412	/	/	/	/	/	/	/	/
	2437	/	20.55	20.6	1.012	< 0.01	0.01	0.01	/
	2462	/	/	/	/	/	/	/	/

Test Date:2017/11/03

Note:

1. When the SAR value is less than half of the limit, testing for other channels are optional.
2. When SAR or MPE is not measured at the maximum power level allowed for production units, the results must be scaled to the maximum tune-up tolerance limit according to the power applied to the individual channels tested to determine compliance.
3. For modes that peak SAR is too low to evaluate, a SAR value 0.01W/kg is considered as their Scaled SAR.
4. According to IEC 62209-2:2010 ,If the correction ΔSAR has a positive sign, the measured SAR results shall not be corrected.

Wi-Fi 2.4G:

EUT Position	Mode	Frequency (MHz)	Power Drift (dB)	Max. Meas. Power (dBm)	Max. Rated Power (dBm)	10 g SAR (W/kg)				
						Scaled Factor	Meas. SAR	Scaled SAR	Corrected SAR	Plot
Handheld-Front (0mm)	802.11b	2412	-0.20	10.11	10.9	1.199	0.154	0.185	0.19	93#
	802.11b	2437	-0.15	9.83	10.9	1.279	0.137	0.175	0.18	94#
	802.11b	2462	0.13	10.7	10.9	1.047	0.201	0.210	0.21	95#
Handheld-Top (0mm)	802.11b	2412	/	/	/	/	/	/	/	/
	802.11b	2437	/	/	/	/	/	/	/	/
	802.11b	2462	0.15	10.7	10.9	1.047	0.079	0.083	0.08	96#

Test Date:2017/11/03

EUT Position	Mode	Frequency (MHz)	Power Drift (dB)	Max. Meas. Power (dBm)	Max. Rated Power (dBm)	1 g SAR (W/kg)				
						Scaled Factor	Meas. SAR	Scaled SAR	Corrected SAR	Plot
Close to Body-Front (10mm)	802.11b	2412	-0.18	10.11	10.9	1.199	0.103	0.123	0.12	97#
	802.11b	2437	0.14	9.83	10.9	1.279	0.102	0.130	0.13	98#
	802.11b	2462	0.15	10.7	10.9	1.047	0.140	0.147	0.15	99#
Close to Body-Top (10mm)	802.11b	2412	/	/	/	/	/	/	/	/
	802.11b	2437	/	/	/	/	/	/	/	/
	802.11b	2462	-0.14	10.7	10.9	1.047	0.061	0.064	0.07	100#

Test Date:2017/11/03

Note:

1. When the SAR value is less than half of the limit, testing for other channels are optional.
2. When SAR or MPE is not measured at the maximum power level allowed for production units, the results must be scaled to the maximum tune-up tolerance limit according to the power applied to the individual channels tested to determine compliance.
3. KDB 248227 D01-SAR is not required for 2.4 GHz OFDM when the highest reported SAR for DSSS is not higher than 1.2W/kg and the target power for OFDM is not higher than DSSS mode.
4. According to IEC 62209-2:2010 ,If the correction ΔSAR has a positive sign, the measured SAR results shall not be corrected.

NII 5.8G(5MHz):

EUT Position	Frequency (MHz)	Power Drift (dB)	Max. Meas. Power (dBm)	Max. Rated Power (dBm)	10 g SAR (W/kg)				
					Scaled Factor	Meas. SAR	Scaled SAR	Corrected SAR	Plot
Handheld-Left (0mm)	5745	/	/	/	/	/	/	/	/
	5785	/	19.31	19.6	1.069	< 0.01	0.01	0.01	/
	5825	/	/	/	/	/	/	/	/
Handheld-Right (0mm)	5745	/	/	/	/	/	/	/	/
	5785	0.16	19.31	19.6	1.069	0.281	0.300	0.30	101#
	5825	/	/	/	/	/	/	/	/
Handheld-Back (0mm)	5745	/	/	/	/	/	/	/	/
	5785	0.15	19.31	19.6	1.069	0.431	0.461	0.46	102#
	5825	/	/	/	/	/	/	/	/
Handheld-Back (0mm) Antenna Fold	5745	/	/	/	/	/	/	/	/
	5785		19.31	19.6	1.069	< 0.01	0.01	0.01	/
	5825	/	/	/	/	/	/	/	/
Handheld-Front (0mm)	5745	0.16	19.4	19.6	1.047	0.901	0.943	0.95	103#
	5785	0.19	19.31	19.6	1.069	0.876	0.936	0.94	104#
	5825	0.09	19	19.6	1.148	0.787	0.903	0.91	105#
Handheld-Top (0mm)	5745	/	/	/	/	/	/	/	/
	5785	0.19	19.31	19.6	1.069	0.656	0.701	0.70	106#
	5825	/	/	/	/	/	/	/	/
Handheld-Bottom (0mm)	5745	/	/	/	/	/	/	/	/
	5785	/	19.31	19.6	1.069	< 0.01	0.01	0.01	/
	5825	/	/	/	/	/	/	/	/

Test Date:2017/11/06

EUT Position	Frequency (MHz)	Power Drift (dB)	Max. Meas. Power (dBm)	Max. Rated Power (dBm)	1 g SAR (W/kg)				
					Scaled Factor	Meas. SAR	Scaled SAR	Corrected SAR	Plot
Close to Body-Left (10mm)	5745	/	/	/	/	/	/	/	/
	5785	/	19.31	19.6	1.069	< 0.01	0.01	0.01	/
	5825	/	/	/	/	/	/	/	/
Close to Body-Right (10mm)	5745	/	/	/	/	/	/	/	/
	5785	-0.16	19.31	19.6	1.069	0.233	0.249	0.25	107#
	5825	/	/	/	/	/	/	/	/
Close to Body-Back (10mm)	5745	/	/	/	/	/	/	/	/
	5785	0.12	19.31	19.6	1.069	0.331	0.354	0.36	108#
	5825	/	/	/	/	/	/	/	/
Close to Body-Back (10mm) Antenna Fold	5745	/	/	/	/	/	/	/	/
	5785	/	19.31	19.6	1.069	< 0.01	0.01	0.01	/
	5825	/	/	/	/	/	/	/	/
Close to Body-Front (10mm)	5745	0.13	19.4	19.6	1.047	1.03	1.078	1.08	109#
	5785	0.11	19.31	19.6	1.069	0.876	0.936	0.94	110#
	5825	0.15	19	19.6	1.148	0.834	0.957	0.96	111#
Close to Body-Top (10mm)	5745	/	/	/	/	/	/	/	/
	5785	-0.06	19.31	19.6	1.069	0.722	0.772	0.77	112#
	5825	/	/	/	/	/	/	/	/
Close to Body-Bottom (10mm)	5745	/	/	/	/	/	/	/	/
	5785	/	19.31	19.6	1.069	< 0.01	0.01	0.01	/
	5825	/	/	/	/	/	/	/	/

Test Date:2017/11/06

NII 5.8G(10MHz):

EUT Position	Frequency (MHz)	Power Drift (dB)	Max. Meas. Power (dBm)	Max. Rated Power (dBm)	10 g SAR (W/kg)				
					Scaled Factor	Meas. SAR	Scaled SAR	Corrected SAR	Plot
Handheld-Left (0mm)	5745	/	/	/	/	/	/	/	/
	5785	/	19.37	19.5	1.03	< 0.01	0.01	0.01	/
	5825	/	/	/	/	/	/	/	/
Handheld-Right (0mm)	5745	/	/	/	/	/	/	/	/
	5785	0.16	19.37	19.5	1.03	0.224	0.231	0.23	113#
	5825	/	/	/	/	/	/	/	/
Handheld-Back (0mm)	5745	/	/	/	/	/	/	/	/
	5785	0.11	19.37	19.5	1.03	0.477	0.491	0.50	114#
	5825	/	/	/	/	/	/	/	/
Handheld-Back (0mm) Antenna Fold	5745	/	/	/	/	/	/	/	/
	5785	/	19.37	19.5	1.03	< 0.01	0.01	0.01	/
	5825	/	/	/	/	/	/	/	/
Handheld-Front (0mm)	5745	0.17	19.39	19.5	1.026	0.933	0.957	0.96	115#
	5785	0.14	19.37	19.5	1.03	0.881	0.907	0.91	116#
	5825	-0.11	19.1	19.5	1.096	0.796	0.872	0.87	117#
Handheld-Top (0mm)	5745	/	/	/	/	/	/	/	/
	5785	0.13	19.37	19.5	1.03	0.759	0.782	0.78	118#
	5825	/	/	/	/	/	/	/	/
Handheld-Bottom (0mm)	5745	/	/	/	/	/	/	/	/
	5785	/	19.37	19.5	1.03	< 0.01	0.01	0.01	/
	5825	/	/	/	/	/	/	/	/

Test Date:2017/11/06

EUT Position	Frequency (MHz)	Power Drift (dB)	Max. Meas. Power (dBm)	Max. Rated Power (dBm)	1 g SAR (W/kg)				
					Scaled Factor	Meas. SAR	Scaled SAR	Corrected SAR	Plot
Close to Body-Left (10mm)	5745	/	/	/	/	/	/	/	/
	5785	/	19.37	19.5	1.03	< 0.01	0.01	0.01	/
	5825	/	/	/	/	/	/	/	/
Close to Body-Right (10mm)	5745	/	/	/	/	/	/	/	/
	5785	0.01	19.37	19.5	1.03	0.297	0.306	0.31	119#
	5825	/	/	/	/	/	/	/	/
Close to Body-Back (10mm)	5745	/	/	/	/	/	/	/	/
	5785	0.15	19.37	19.5	1.03	0.611	0.629	0.63	120#
	5825	/	/	/	/	/	/	/	/
Close to Body-Back (10mm) Antenna Fold	5745	/	/	/	/	/	/	/	/
	5785	/	19.37	19.5	1.03	< 0.01	0.01	0.01	/
	5825	/	/	/	/	/	/	/	/
Close to Body-Front (10mm)	5745	0.18	19.39	19.5	1.026	1	1.026	1.03	121#
	5785	0.09	19.37	19.5	1.03	0.913	0.940	0.94	122#
	5825	0.16	19.1	19.5	1.096	0.844	0.925	0.93	123#
Close to Body-Top (10mm)	5745	/	/	/	/	/	/	/	/
	5785	0.02	19.37	19.5	1.03	0.735	0.757	0.76	124#
	5825	/	/	/	/	/	/	/	/
Close to Body-Bottom (10mm)	5745	/	/	/	/	/	/	/	/
	5785	/	19.37	19.5	1.03	< 0.01	0.01	0.01	/
	5825	/	/	/	/	/	/	/	/

Test Date:2017/11/07

Note:

- 1 When the SAR value is less than half of the limit, testing for other channels are optional.
- 2 When SAR or MPE is not measured at the maximum power level allowed for production units, the results must be scaled to the maximum tune-up tolerance limit according to the power applied to the individual channels tested to determine compliance.
- 3 For modes that peak SAR is too low to evaluate, a SAR value 0.01W/kg is considered as their Scaled SAR.
- 4 According to IEC 62209-2:2010 ,If the correction ΔSAR has a positive sign, the measured SAR results shall not be corrected.

Wi-Fi 5.8G:

EUT Position	Mode	Frequency (MHz)	Power Drift (dB)	Max. Meas. Power (dBm)	Max. Rated Power (dBm)	10 g SAR (W/kg)				
						Scaled Factor	Meas. SAR	Scaled SAR	Corrected SAR	Plot
Handheld-Left (0mm)	802.11a	5745	/	/	/	/	/	/	/	/
	802.11a	5785	/	19.33	19.6	1.064	< 0.01	0.01	0.01	/
	802.11a	5825	/	/	/	/	/	/	/	/
Handheld-Right (0mm)	802.11a	5745	/	/	/	/	/	/	/	/
	802.11a	5785	0.15	19.33	19.6	1.064	0.280	0.298	0.30	125#
	802.11a	5825	/	/	/	/	/	/	/	/
Handheld-Back (0mm)	802.11a	5745	/	/	/	/	/	/	/	/
	802.11a	5785	0.05	19.33	19.6	1.064	0.469	0.499	0.50	126#
	802.11a	5825	/	/	/	/	/	/	/	/
Handheld-Back (0mm) Antenna Fold	802.11a	5745	/	/	/	/	/	/	/	/
	802.11a	5785	/	19.33	19.6	1.064	< 0.01	0.01	0.01	/
	802.11a	5825	/	/	/	/	/	/	/	/
Handheld-Front (0mm)	802.11a	5745	0.15	19.47	19.6	1.03	0.912	0.939	0.94	127#
	802.11a	5785	0.12	19.33	19.6	1.064	0.850	0.904	0.91	128#
	802.11a	5825	0.03	19.24	19.6	1.086	0.790	0.858	0.86	129#
Handheld-Top (0mm)	802.11a	5745	/	/	/	/	/	/	/	/
	802.11a	5785	0.09	19.33	19.6	1.064	0.802	0.853	0.86	130#
	802.11a	5825	/	/	/	/	/	/	/	/
Handheld-Bottom (0mm)	802.11a	5745	/	/	/	/	/	/	/	/
	802.11a	5785	/	19.33	19.6	1.064	< 0.01	0.01	0.01	/
	802.11a	5825	/	/	/	/	/	/	/	/

Test Date:2017/11/07

EUT Position	Mode	Frequency (MHz)	Power Drift (dB)	Max. Meas. Power (dBm)	Max. Rated Power (dBm)	1 g SAR (W/kg)				
						Scaled Factor	Meas. SAR	Scaled SAR	Corrected SAR	Plot
Close to Body-Left (10mm)	802.11a	5745	/	/	/	/	/	/	/	/
	802.11a	5785	/	19.33	19.6	1.064	< 0.01	0.01	0.01	/
	802.11a	5825	/	/	/	/	/	/	/	/
Close to Body-Right (10mm)	802.11a	5745	/	/	/	/	/	/	/	/
	802.11a	5785	0.11	19.33	19.6	1.064	0.385	0.410	0.41	131#
	802.11a	5825	/	/	/	/	/	/	/	/
Close to Body-Back (10mm)	802.11a	5745	/	/	/	/	/	/	/	/
	802.11a	5785	0.16	19.33	19.6	1.064	0.582	0.619	0.62	132#
	802.11a	5825	/	/	/	/	/	/	/	/
Close to Body-Back (10mm) Antenna Fold	802.11a	5745	/	/	/	/	/	/	/	/
	802.11a	5785	/	19.33	19.6	1.064	< 0.01	0.01	0.01	/
	802.11a	5825	/	/	/	/	/	/	/	/
Close to Body-Front (10mm)	802.11a	5745	0.02	19.47	19.6	1.03	1.04	1.071	1.08	133#
	802.11a	5785	0.18	19.33	19.6	1.064	0.905	0.963	0.97	134#
	802.11a	5825	0.01	19.24	19.6	1.086	0.884	0.960	0.96	135#
Close to Body-Top (10mm)	802.11a	5745	/	/	/	/	/	/	/	/
	802.11a	5785	0.20	19.33	19.6	1.064	0.718	0.764	0.77	136#
	802.11a	5825	/	/	/	/	/	/	/	/
Close to Body-Bottom (10mm)	802.11a	5745	/	/	/	/	/	/	/	/
	802.11a	5785	/	19.33	19.6	1.064	< 0.01	0.01	0.01	/
	802.11a	5825	/	/	/	/	/	/	/	/

Test Date:2017/11/07

Note:

- 1 When the SAR value is less than half of the limit, testing for other channels are optional.
- 2 When SAR or MPE is not measured at the maximum power level allowed for production units, the results must be scaled to the maximum tune-up tolerance limit according to the power applied to the individual channels tested to determine compliance.
- 3 For modes that peak SAR is too low to evaluate, a SAR value 0.01W/kg is considered as their Scaled SAR.
- 4 According to IEC 62209-2:2010 ,If the correction ΔSAR has a positive sign, the measured SAR results shall not be corrected.

Corrected SAR Evaluation

62209-2 © IEC:2010

– 89 –

Annex F
(normative)**SAR correction for deviations of complex permittivity from targets****F.2 SAR correction formula**

From [13] and [14], a linear relationship was found between the percent change in SAR (denoted ΔSAR) and the percent change in the permittivity and conductivity from the target values in Table 1 (denoted $\Delta \epsilon_r$ and $\Delta \sigma$, respectively). This linear relationship agrees with the results of Kuster and Balzano [48] and Bit-Babik et al. [2]. The relationship is given by:

$$\Delta SAR = c_\epsilon \Delta \epsilon_r + c_\sigma \Delta \sigma \quad (F.1)$$

where

$c_\epsilon = \partial(\Delta SAR)/\partial(\Delta \epsilon)$ is the coefficients representing the sensitivity of SAR to permittivity where SAR is normalized to output power;

$c_\sigma = \partial(\Delta SAR)/\partial(\Delta \sigma)$ is the coefficients representing the sensitivity of SAR to conductivity, where SAR is normalized to output power.

The values of c_ϵ and c_σ have a simple relationship with frequency that can be described using polynomial equations. For the 1 g averaged SAR c_ϵ and c_σ are given by

$$c_\epsilon = -7,854 \times 10^{-4} f^3 + 9,402 \times 10^{-3} f^2 - 2,742 \times 10^{-2} f - 0,2026 \quad (F.2)$$

$$c_\sigma = 9,804 \times 10^{-3} f^3 - 8,661 \times 10^{-2} f^2 + 2,981 \times 10^{-2} f + 0,7829 \quad (F.3)$$

where

f is the frequency in GHz.

For the 10 g averaged SAR, the variables c_ϵ and c_σ are given by:

$$c_\epsilon = 3,456 \times 10^{-3} f^3 - 3,531 \times 10^{-2} f^2 + 7,675 \times 10^{-2} f - 0,1860 \quad (F.4)$$

$$c_\sigma = 4,479 \times 10^{-3} f^3 - 1,586 \times 10^{-2} f^2 - 0,1972 f + 0,7717 \quad (F.5)$$

Corrected SAR Evaluation Table

Date: 2017/11/01

Frequency (MHz)	Liquid Type	$C \epsilon$	$\Delta \epsilon r$	$C \delta$	$\Delta \delta$	ΔSAR (%)
2412	1g Body	-0.225	-0.91	0.489	-1.15	-0.36
2437	1g Body	-0.225	-0.83	0.483	-0.93	-0.26
2450	1g Body	-0.225	-0.93	0.480	-0.57	-0.06
2462	1g Body	-0.225	-0.99	0.478	-0.56	-0.04
2412	10g Body	-0.158	-0.91	0.267	-1.15	-0.16
2437	10g Body	-0.159	-0.83	0.262	-0.93	-0.11
2450	10g Body	-0.159	-0.93	0.259	-0.57	0.00
2462	10g Body	-0.159	-0.99	0.257	-0.56	0.01

Date: 2017/11/02

Frequency (MHz)	Liquid Type	$C \epsilon$	$\Delta \epsilon r$	$C \delta$	$\Delta \delta$	ΔSAR (%)
2412	1g Body	-0.225	0.82	0.489	1.78	0.68
2437	1g Body	-0.225	-1.97	0.483	1.91	1.37
2450	1g Body	-0.225	-0.86	0.480	4.54	2.37
2462	1g Body	-0.225	-0.99	0.478	1.64	1.01
2412	10g Body	-0.158	0.82	0.267	1.78	0.35
2437	10g Body	-0.159	-1.97	0.262	1.91	0.81
2450	10g Body	-0.159	-0.86	0.259	4.54	1.31
2462	10g Body	-0.159	-0.99	0.257	1.64	0.58

Date: 2017/11/03

Frequency (MHz)	Liquid Type	$C \epsilon$	$\Delta \epsilon r$	$C \delta$	$\Delta \delta$	ΔSAR (%)
2412	1g Body	-0.225	-0.19	0.489	3.51	1.76
2437	1g Body	-0.225	3.27	0.483	0.93	-0.29
2450	1g Body	-0.225	2.86	0.480	-0.1	-0.69
2462	1g Body	-0.225	1.27	0.478	-2.05	-1.26
2412	10g Body	-0.158	-0.19	0.267	3.51	0.97
2437	10g Body	-0.159	3.27	0.262	0.93	-0.28
2450	10g Body	-0.159	2.86	0.259	-0.1	-0.48
2462	10g Body	-0.159	1.27	0.257	-2.05	-0.73

Date: 2017/11/04

Frequency (MHz)	Liquid Type	$C \epsilon$	$\Delta \epsilon r$	$C \delta$	$\Delta \delta$	ΔSAR (%)
5745	1g Body	-0.199	1.11	-0.045	1.25	-0.28
5785	1g Body	-0.199	1.11	-0.045	2.56	-0.34
5800	1g Body	-0.199	1.06	-0.045	2.52	-0.32
5825	1g Body	-0.199	0.96	-0.044	3.27	-0.34
5745	10g Body	-0.255	1.11	-0.035	1.25	-0.33
5785	10g Body	-0.255	1.11	-0.033	2.56	-0.37
5800	10g Body	-0.254	1.06	-0.032	2.52	-0.35
5825	10g Body	-0.254	0.96	-0.030	3.27	-0.34

Date: 2017/11/05

Frequency (MHz)	Liquid Type	$C \epsilon$	$\Delta \epsilon r$	$C \delta$	$\Delta \delta$	ΔSAR (%)
5745	1g Body	-0.199	1	-0.045	2.78	-0.33
5785	1g Body	-0.199	1.01	-0.045	2.88	-0.33
5800	1g Body	-0.199	0.98	-0.045	3.15	-0.34
5825	1g Body	-0.199	0.86	-0.044	4.03	-0.35
5745	10g Body	-0.255	1	-0.035	2.78	-0.35
5785	10g Body	-0.255	1.01	-0.033	2.88	-0.35
5800	10g Body	-0.254	0.98	-0.032	3.15	-0.35
5825	10g Body	-0.254	0.86	-0.030	4.03	-0.34

Date: 2017/11/06

Frequency (MHz)	Liquid Type	$C \epsilon$	$\Delta \epsilon r$	$C \delta$	$\Delta \delta$	ΔSAR (%)
5745	1g Body	-0.199	1.12	-0.045	3.11	-0.36
5785	1g Body	-0.199	1.07	-0.045	3.03	-0.35
5800	1g Body	-0.199	1.04	-0.045	3.18	-0.35
5825	1g Body	-0.199	0.93	-0.044	3.35	-0.33
5745	10g Body	-0.255	1.12	-0.035	3.11	-0.40
5785	10g Body	-0.255	1.07	-0.033	3.03	-0.37
5800	10g Body	-0.254	1.04	-0.032	3.18	-0.37
5825	10g Body	-0.254	0.93	-0.030	3.35	-0.34

Date: 2017/11/07

Frequency (MHz)	Liquid Type	C ε	Δ ε r	C δ	Δ δ	ΔSAR (%)
5745	1g Body	-0.199	2.29	-0.045	0.42	-0.47
5785	1g Body	-0.199	2.12	-0.045	1.32	-0.48
5800	1g Body	-0.199	1.88	-0.045	2.02	-0.46
5825	1g Body	-0.199	1.66	-0.044	3.28	-0.48
5745	10g Body	-0.255	2.29	-0.035	0.42	-0.60
5785	10g Body	-0.255	2.12	-0.033	1.32	-0.58
5800	10g Body	-0.254	1.88	-0.032	2.02	-0.54
5825	10g Body	-0.254	1.66	-0.030	3.28	-0.52

$$\Delta SAR = c_{\epsilon} \Delta \epsilon_r + c_{\sigma} \Delta \sigma$$

where

f is the frequency in GHz.

$$\text{Corrected SAR} = \text{Measured SAR} * ((100 + (\Delta SAR * -1)) / 100)$$

SAR Measurement Variability

In accordance with published RF Exposure KDB procedure 865664 D01 SAR measurement 100 MHz to 6 GHz v01. These additional measurements are repeated after the completion of all measurements requiring the same head or body tissue-equivalent medium in a frequency band. The test device should be returned to ambient conditions (normal room temperature) with the battery fully charged before it is re-mounted on the device holder for the repeated measurement(s) to minimize any unexpected variations in the repeated results

- 1) Repeated measurement is not required when the original highest measured SAR is < 0.80 W/kg; steps 2) through 4) do not apply.
- 2) When the original highest measured SAR is ≥ 0.80 W/kg, repeat that measurement once.
- 3) Perform a second repeated measurement only if the ratio of largest to smallest SAR for the original and first repeated measurements is > 1.20 or when the original or repeated measurement is ≥ 1.45 W/kg (~ 10% from the 1-g SAR limit).
- 4) Perform a third repeated measurement only if the original, first or second repeated measurement is ≥ 1.5 W/kg and the ratio of largest to smallest SAR for the original, first and second repeated measurements is > 1.20 .

Note: The same procedures should be adapted for measurements according to extremity and occupational exposure limits by applying a factor of 2.5 for extremity exposure and a factor of 5 for occupational exposure to the corresponding SAR thresholds.

The Highest Measured SAR Configuration in Each Frequency Band

Body SAR

Frequency Band	Freq.(MHz)	EUT Position	Meas. SAR (W/kg)		Largest to Smallest SAR Ratio
			Original	Repeated	
(2350-2500 MHz) DTS 2.4G 10MHz Chain 0	2462	Close to Body-Front	1.3	1.27	1.02
(5700-5910 MHz) NII 5.8G 5MHz Chain 0	5745	Handheld-Front	2.75	2.71	1.01
(5700-5910 MHz) NII 5.8G 5MHz Chain 0	5745	Close to Body- Front	1.25	1.22	1.02
(5700-5910 MHz) Wi-Fi 5.8G Chain 0	5745	Handheld-Front	2.03	1.95	1.04
(5700-5910 MHz) Wi-Fi 5.8G Chain 0	5785	Close to Body-Front	1.26	1.19	1.06

Note:

1. Second Repeated Measurement is not required since the ratio of the largest to smallest SAR for the original and first repeated measurement is not > 1.20 .
2. The measured SAR results **do not** have to be scaled to the maximum tune-up tolerance to determine if repeated measurements are required.
3. SAR measurement variability must be assessed for each frequency band, which is determined by the **SAR probe calibration point and tissue-equivalent medium** used for the device measurements..

SAR SIMULTANEOUS TRANSMISSION DESCRIPTION

Simultaneous Transmission:

Description of Simultaneous Transmit Capabilities	
Transmitter Combination	Simultaneous?
DTS 2.4G Chain 0 + DTS 2.4G Chain 1	√
Wi-Fi 2.4G Chain 0 + Wi-Fi 2.4G Chain 1	√
NII 5.8G Chain 0 + NII 5.8G Chain 1	√
Wi-Fi 5.8G Chain 0 + Wi-Fi 5.8G Chain 1	√
DTS 2.4G Chain 0(Chain 1) + Wi-Fi 2.4G Chain 1(Chain 0)	×
DTS 2.4G Chain 0(Chain 1) + Wi-Fi 5.8G Chain 1(Chain 0)	×
NII 5.8G Chain 0(Chain 1) + Wi-Fi 2.4G Chain 1(Chain 0)	×
NII 5.8G Chain 0 (Chain 1) + Wi-Fi 5.8G Chain 1(Chain 0)	×

Simultaneous SAR test exclusion considerations:

10g Extremity SAR:

Mode(SAR1+SAR2)	Position	Reported SAR(W/kg)		ΣSAR < 4.0 W/kg
		SAR1	SAR2	
DTS 2.4G(5MHz) Chain 0+ DTS 2.4G(5MHz) Chain 1	Handheld-Left	0.16	0.01	0.17
	Handheld-Right	0.01	0.11	0.12
	Handheld-Back	0.16	0.12	0.28
	Handheld-Back Fold	0.01	0.01	0.02
	Handheld-Front	2.25	1.57	3.82
	Handheld-Top	0.46	0.44	0.9
	Handheld-Bottom	0.01	0.01	0.02
DTS 2.4G(10MHz) Chain 0+ DTS 2.4G(10MHz) Chain 1	Handheld-Left	0.16	0.01	0.17
	Handheld-Right	0.01	0.11	0.12
	Handheld-Back	0.16	0.12	0.28
	Handheld-Back Fold	0.01	0.01	0.02
	Handheld-Front	2.03	1.58	3.61
	Handheld-Top	0.51	0.41	0.92
	Handheld-Bottom	0.01	0.01	0.02
Wi-Fi 2.4G Chain 0+ Wi-Fi 2.4G Chain 1	Handheld-Front	0.41	0.21	0.62
	Handheld-Top	0.06	0.08	0.14
NII 5.8G(5MHz) Chain 0+ NII 5.8G(5MHz) Chain 1	Handheld-Left	0.42	0.01	0.43
	Handheld-Right	0.01	0.30	0.31
	Handheld-Back	0.48	0.46	0.94
	Handheld-Back Fold	0.01	0.01	0.02
	Handheld-Front	2.83	0.95	3.78
	Handheld-Top	0.82	0.70	1.52
	Handheld-Bottom	0.01	0.01	0.02

Mode(SAR1+SAR2)	Position	Reported SAR(W/kg)		ΣSAR < 4.0 W/kg
		SAR1	SAR2	
NII 5.8G(10MHz) Chain 0+ NII 5.8G(10MHz) Chain 1	Handheld-Left	0.24	0.01	0.25
	Handheld-Right	0.01	0.23	0.24
	Handheld-Back	0.50	0.50	1
	Handheld-Back Fold	0.01	0.01	0.02
	Handheld-Front	2.89	0.96	3.85
	Handheld-Top	0.92	0.78	1.7
	Handheld-Bottom	0.01	0.01	0.02
Wi-Fi 5.8G Chain 0+ Wi-Fi 5.8G Chain 1	Handheld-Left	0.28	0.01	0.29
	Handheld-Right	0.01	0.30	0.31
	Handheld-Back	0.43	0.50	0.93
	Handheld-Back Fold	0.01	0.01	0.02
	Handheld-Front	2.10	0.94	3.04
	Handheld-Top	0.64	0.86	1.5
	Handheld-Bottom	0.01	0.01	0.02

Conclusion:

Sum of SAR: Σ SAR < 4.0 W/kg, simultaneous transmission SAR with Volume Scans is **not required**.

1g Body SAR:

Mode(SAR1+SAR2)	Position	Reported SAR(W/kg)		ΣSAR < 1.6 W/kg
		SAR1	SAR2	
DTS 2.4G(5MHz) Chain 0+ DTS 2.4G(5MHz) Chain 1	Close to Body-Left	0.10	0.01	0.11
	Close to Body-Right	0.01	0.09	0.1
	Close to Body-Back	0.12	0.10	0.22
	Close to Body-Back Fold	0.01	0.01	0.02
	Close to Body-Front	1.21	0.92	2.13 ^{SPLSR1}
	Close to Body-Top	0.40	0.39	0.79
	Close to Body-Bottom	0.01	0.01	0.02
DTS 2.4G(10MHz) Chain 0+ DTS 2.4G(10MHz) Chain 1	Close to Body-Left	0.10	0.01	0.11
	Close to Body-Right	0.01	0.09	0.1
	Close to Body-Back	0.13	0.11	0.24
	Close to Body-Back Fold	0.01	0.01	0.02
	Close to Body-Front	1.33	1.13	2.46 ^{SPLSR2}
	Close to Body-Top	0.42	0.60	1.02
Wi-Fi 2.4G Chain 0+ Wi-Fi 2.4G Chain 1	Close to Body-Top	0.07	0.07	0.14
	Close to Body-Front	0.31	0.15	0.46
NII 5.8G(5MHz) Chain 0+ NII 5.8G(5MHz) Chain 1	Close to Body-Left	0.40	0.01	0.41
	Close to Body-Right	0.01	0.25	0.26
	Close to Body-Back	0.57	0.36	0.93
	Close to Body-Back Fold	0.01	0.01	0.02
	Close to Body-Front	1.31	1.08	2.39 ^{SPLSR3}
	Close to Body-Top	0.79	0.77	1.56
	Close to Body-Bottom	0.01	0.01	0.02
NII 5.8G(10MHz) Chain 0+ NII 5.8G(10MHz) Chain 1	Close to Body-Left	0.24	0.01	0.25
	Close to Body-Right	0.01	0.31	0.32
	Close to Body-Back	0.71	0.63	1.34
	Close to Body-Back Fold	0.01	0.01	0.02
	Close to Body-Front	1.08	1.03	2.11 ^{SPLSR4}
	Close to Body-Top	0.75	0.76	1.51
	Close to Body-Bottom	0.01	0.01	0.02
Wi-Fi 5.8G Chain 0+ Wi-Fi 5.8G Chain 1	Close to Body-Left	0.32	0.01	0.33
	Close to Body-Right	0.01	0.41	0.42
	Close to Body-Back	0.25	0.62	0.87
	Close to Body-Back Fold	0.01	0.01	0.02
	Close to Body-Front	1.32	1.08	2.4 ^{SPLSR5}
	Close to Body-Top	0.71	0.77	1.48
	Close to Body-Bottom	0.01	0.01	0.02

SPLSR1:

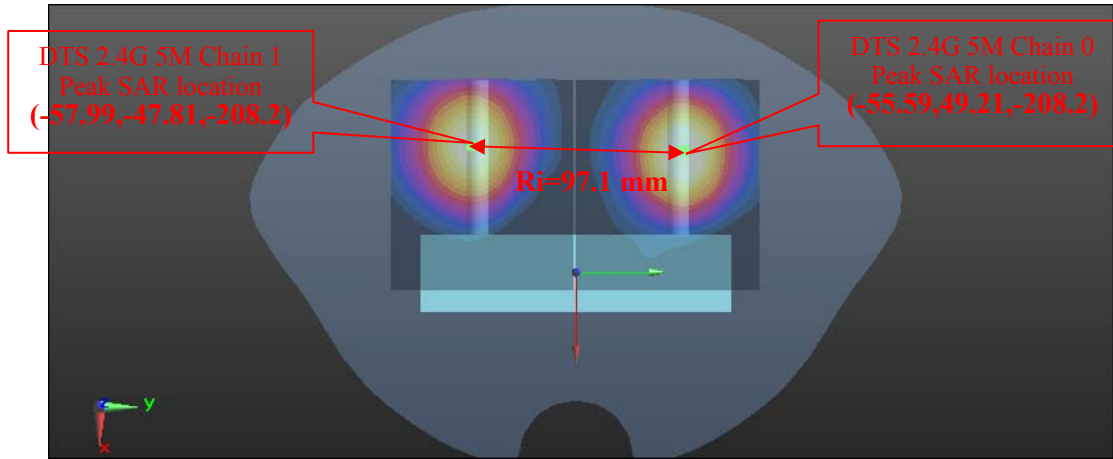

$$\text{Distance}(R_i) = [(x_1-x_2)^2 + (y_1-y_2)^2 + (z_1-z_2)^2]^{0.5} = 97.1 \text{ mm}$$

$$\text{SPLSR1} = (\text{SAR1} + \text{SAR2})^{1.5} / R_i = (1.21 + 0.92)^{1.5} / 97.1 = 0.03 \leq 0.04$$

SPLSR2:

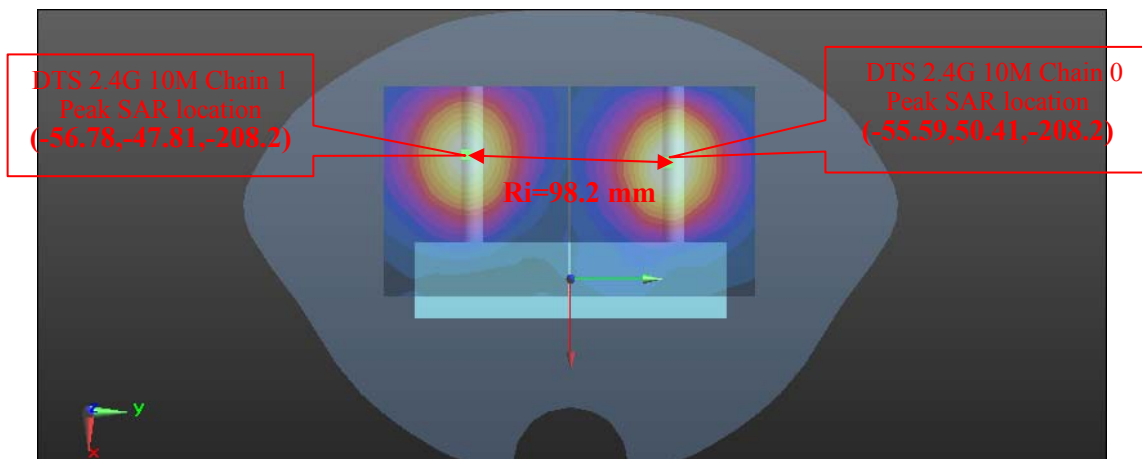

$$\text{Distance}(R_i) = [(x_1-x_2)^2 + (y_1-y_2)^2 + (z_1-z_2)^2]^{0.5} = 98.2 \text{ mm}$$

$$\text{SPLSR2} = (\text{SAR1} + \text{SAR2})^{1.5} / R_i = (1.33 + 1.13)^{1.5} / 98.2 = 0.04 \leq 0.04$$

SPLSR3:

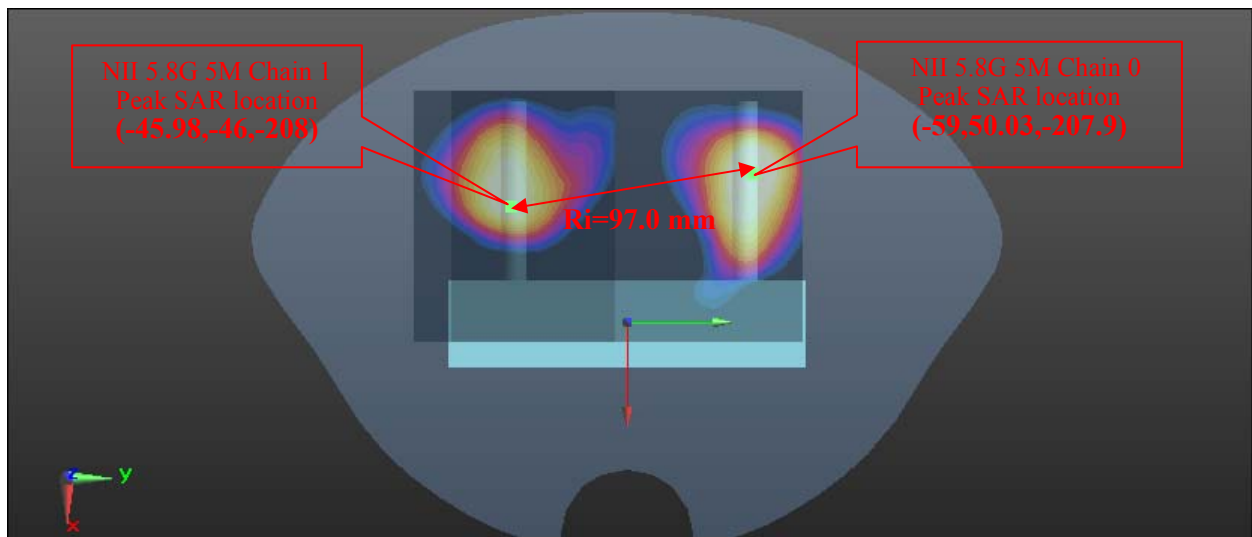

$$\text{Distance}(R_i) = [(x_1-x_2)^2 + (y_1-y_2)^2 + (z_1-z_2)^2]^{0.5} = 97.0 \text{ mm}$$

$$\text{SPLSR3} = (\text{SAR1} + \text{SAR2})^{1.5} / R_i = (1.31 + 1.08)^{1.5} / 97.0 = 0.04 \leq 0.04$$

SPLSR4:

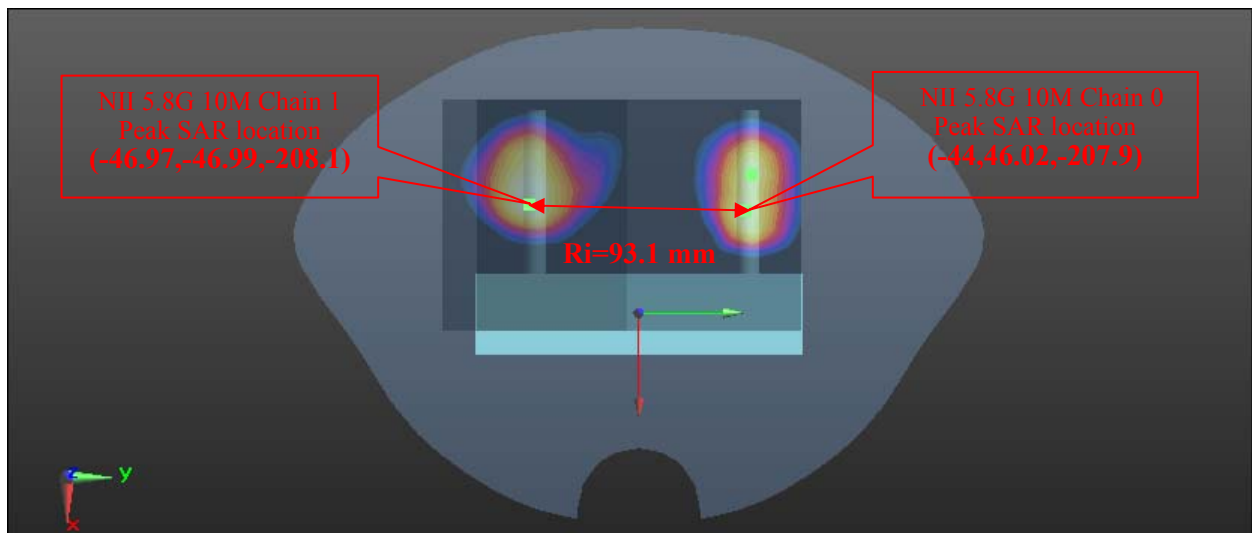

$$\text{Distance}(R_i) = [(x_1-x_2)^2 + (y_1-y_2)^2 + (z_1-z_2)^2]^{0.5} = 93.1 \text{ mm}$$

$$\text{SPLSR4} = (\text{SAR1} + \text{SAR2})^{1.5} / R_i = (1.08 + 1.03)^{1.5} / 93.1 = 0.03 \leq 0.04$$

SPLSR5:

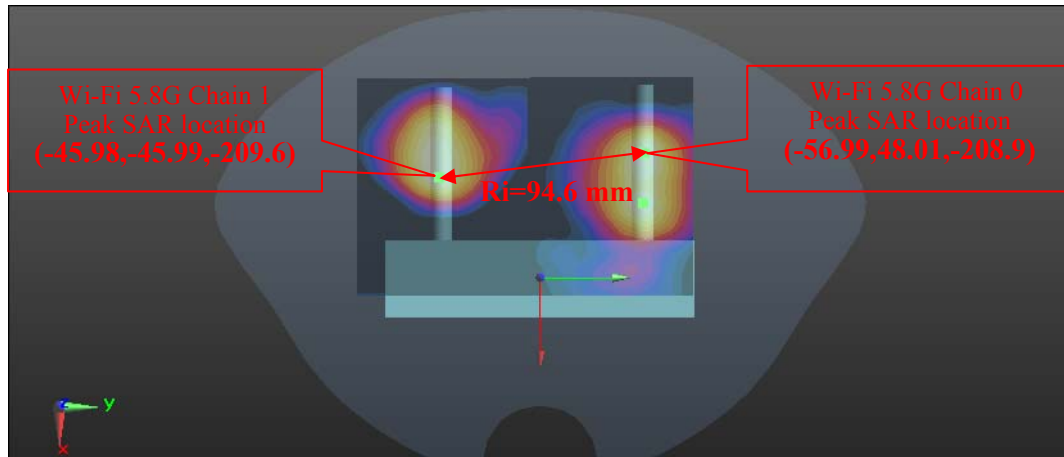

$$\text{Distance}(R_i) = [(x_1-x_2)^2 + (y_1-y_2)^2 + (z_1-z_2)^2]^{0.5} = 94.6 \text{ mm}$$

$$\text{SPLSR5} = (\text{SAR}_1 + \text{SAR}_2)^{1.5} / R_i = (1.32 + 1.08)^{1.5} / 94.6 = 0.04 \leq 0.04$$

Note:

KDB447498 D01-The ratio is determined by $(\text{SAR}_1 + \text{SAR}_2)^{1.5} / R_i$, rounded to two decimal digits, and must be ≤ 0.04 .

Conclusion:

Sum of SAR: $\Sigma \text{SAR} < 1.6 \text{ W/kg}$ and /or **SPLSR** ≤ 0.04 , simultaneous transmission SAR with Volume Scans is **not required**.

SAR Plots

Please Refer to the Attachment.

APPENDIX A MEASUREMENT UNCERTAINTY

The uncertainty budget has been determined for the measurement system and is given in the following Table.

Measurement uncertainty evaluation for IEEE1528-2013 SAR test

Source of uncertainty	Tolerance/uncertainty ± %	Probability distribution	Divisor	ci (1 g)	ci (10 g)	Standard uncertainty ± %, (1 g)	Standard uncertainty ± %, (10 g)
Measurement system							
Probe calibration	6.55	N	1	1	1	6.6	6.6
Axial Isotropy	4.7	R	√3	1	1	2.7	2.7
Hemispherical Isotropy	9.6	R	√3	0	0	0.0	0.0
Boundary effect	1.0	R	√3	1	1	0.6	0.6
Linearity	4.7	R	√3	1	1	2.7	2.7
Detection limits	1.0	R	√3	1	1	0.6	0.6
Readout electronics	0.3	N	1	1	1	0.3	0.3
Response time	0.0	R	√3	1	1	0.0	0.0
Integration time	0.0	R	√3	1	1	0.0	0.0
RF ambient conditions – noise	1.0	R	√3	1	1	0.6	0.6
RF ambient conditions–reflections	1.0	R	√3	1	1	0.6	0.6
Probe positioner mech. Restrictions	0.8	R	√3	1	1	0.5	0.5
Probe positioning with respect to phantom shell	6.7	R	√3	1	1	3.9	3.9
Post-processing	2.0	R	√3	1	1	1.2	1.2
Test sample related							
Test sample positioning	2.8	N	1	1	1	2.8	2.8
Device holder uncertainty	6.3	N	1	1	1	6.3	6.3
Drift of output power	5.0	R	√3	1	1	2.9	2.9
Phantom and set-up							
Phantom uncertainty (shape and thickness tolerances)	4.0	R	√3	1	1	2.3	2.3
Liquid conductivity target)	5.0	R	√3	0.64	0.43	1.8	1.2
Liquid conductivity meas.)	2.5	N	1	0.64	0.43	1.6	1.1
Liquid permittivity target)	5.0	R	√3	0.6	0.49	1.7	1.4
Liquid permittivity meas.)	2.5	N	1	0.6	0.49	1.5	1.2
Combined standard uncertainty		RSS				12.2	12.0
Expanded uncertainty 95 % confidence interval)						24.3	23.9

Measurement uncertainty evaluation for IEC62209-2 SAR test

Source of uncertainty	Tolerance/uncertainty ± %	Probability distribution	Divisor	ci (1 g)	ci (10 g)	Standard uncertainty ± %, (1 g)	Standard uncertainty ± %, (10 g)
Measurement system							
Probe calibration	6.55	N	1	1	1	6.6	6.6
Axial Isotropy	4.7	R	√3	1	1	2.7	2.7
Hemispherical Isotropy	9.6	R	√3	0	0	0.0	0.0
Linearity	4.7	R	√3	1	1	2.7	2.7
Modulation Response	0.0	R	√3	1	1	0.0	0.0
Detection limits	1.0	R	√3	1	1	0.6	0.6
Boundary effect	1.0	R	√3	1	1	0.6	0.6
Readout electronics	0.3	N	1	1	1	0.3	0.3
Response time	0.0	R	√3	1	1	0.0	0.0
Integration time	0.0	R	√3	1	1	0.0	0.0
RF ambient conditions – noise	1.0	R	√3	1	1	0.6	0.6
RF ambient conditions–reflections	1.0	R	√3	1	1	0.6	0.6
Probe positioner mech. Restrictions	0.8	R	√3	1	1	0.5	0.5
Probe positioning with respect to phantom shell	6.7	R	√3	1	1	3.9	3.9
Post-processing	2.0	R	√3	1	1	1.2	1.2
Test sample related							
Device holder Uncertainty	6.3	N	1	1	1	6.3	6.3
Test sample positioning	2.8	N	1	1	1	2.8	2.8
Power scaling	4.5	R	√3	1	1	2.6	2.6
Drift of output power	5.0	R	√3	1	1	2.9	2.9
Phantom and set-up							
Phantom uncertainty (shape and thickness tolerances)	4.0	R	√3	1	1	2.3	2.3
Algorithm for correcting SAR for deviations in permittivity and conductivity	1.9	N	1	1	0.84	1.1	0.9
Liquid conductivity (meas.)	2.5	N	1	0.64	0.43	1.6	1.1
Liquid permittivity (meas.)	2.5	N	1	0.6	0.49	1.5	1.2
Temp. unc. - Conductivity	1.7	R	√3	0.78	0.71	0.8	0.7
Temp. unc. - Permittivity	0.3	R	√3	0.23	0.26	0.0	0.0
Combined standard uncertainty		RSS				12.2	12.1
Expanded uncertainty 95 % confidence interval)						24.5	24.2

APPENDIX B CALIBRATION CERTIFICATES

Please Refer to the Attachment.

APPENDIX C EUT TEST POSITION PHOTOS

Please Refer to the Attachment.

******* END OF REPORT *******