

Prüfbericht-Nr.: <i>Test report no.:</i>	CN22G058 004	Auftrags-Nr.: <i>Order no.:</i>	168350235	Seite 1 von 33 <i>Page 1 of 33</i>
Kunden-Referenz-Nr.: <i>Client reference no.:</i>	N/A	Auftragsdatum: <i>Order date:</i>	2022-01-04	
Auftraggeber: <i>Client:</i>	SZ DJI TECHNOLOGY CO., LTD 14th Floor, West Wing, Skyworth Semiconductor Design Building No.18 Gaoxin South 4th Ave Nanshan District, Shenzhen, P.R. China			
Prüfgegenstand: <i>Test item:</i>	DJI RC			
Bezeichnung / Typ-Nr.: <i>Identification / Type no.:</i>	RM330 (Trademark: DJI)			
Auftrags-Inhalt: <i>Order content:</i>	FCC approval			
Prüfgrundlage: <i>Test specification:</i>	FCC 47 CFR § 2.1093 IEEE Std 1528-2013 RSS-102 Issue 5 IEC/IEEE62209-1528: 2020 Published RF exposure KDB procedures			
Wareneingangsdatum: <i>Date of sample receipt:</i>	2022-02-24	Please refer to Photo Document		
Prüfmuster-Nr.: <i>Test sample no.:</i>	A003217007-001 A003217007-002			
Prüfzeitraum: <i>Testing period:</i>	2022-03-02 –2022-03-03			
Ort der Prüfung: <i>Place of testing:</i>	TÜV Rheinland (Shenzhen) Co., Ltd.			
Prüflaboratorium: <i>Testing laboratory:</i>	TÜV Rheinland (Shenzhen) Co., Ltd.			
Prüfergebnis*: <i>Test result*:</i>	Pass			
geprüft von: <i>tested by:</i>	<u>x Bell Hu</u>	genehmigt von: <i>authorized by:</i>	<u>X Lin Lin</u>	
Datum: <i>Date:</i>	2022-05-10 <small>Signed by: Bell Hu</small>	Ausstellungsdatum: <i>Issue date:</i>	2022-05-10 <small>Signed by: Lin Lin</small>	
Stellung / Position:	Project Manager	Stellung / Position:	Reviewer	
Sonstiges / Other:	FCC ID: SS3- RM33022, IC: 11805A- RM33022, HVIN: RM330 This report is for 5.2GHz Wi-Fi, 5.8GHz SDR and 5.8GHz Wi-Fi. Applicant & Manufacturer: SZ DJI TECHNOLOGY CO., LTD, 14th Floor, West Wing, Skyworth Semiconductor Design Building No.18 Gaoxin South 4th Ave Nanshan District, Shenzhen, P.R. China. Model: RM330			
Zustand des Prüfgegenstandes bei Anlieferung: <i>Condition of the test item at delivery:</i>	Prüfmuster vollständig und unbeschädigt <i>Test item complete and undamaged</i>			
* Legende:	1 = sehr gut P(ass) = entspricht o.g. Prüfgrundlage(n)	2 = gut F(ail) = entspricht nicht o.g. Prüfgrundlage(n)	3 = befriedigend N/A = nicht anwendbar	4 = ausreichend N/T = nicht getestet
* Legend:	1 = very good P(ass) = passed a.m. test specification(s)	2 = good F(ail) = failed a.m. test specification(s)	3 = satisfactory N/A = not applicable	4 = sufficient N/T = not tested
Dieser Prüfbericht bezieht sich nur auf das o.g. Prüfmuster und darf ohne Genehmigung der Prüfstelle nicht auszugsweise vervielfältigt werden. Dieser Bericht berechtigt nicht zur Verwendung eines Prüfzeichens. <i>This test report only relates to the a. m. test sample. Without permission of the test center this test report is not permitted to be duplicated in extracts. This test report does not entitle to carry any test mark.</i>				

V05

Table of Contents

1.	GENERAL INFORMATION	4
1.1.	STATEMENT OF COMPLIANCE	4
1.2.	EQUIPMENT UNDER TEST (EUT) INFORMATION	5
1.2.1.	<i>General Information</i>	5
1.2.2.	<i>Wireless Technologies</i>	5
2.	TEST SITES	6
2.1.	TEST FACILITIES	6
2.2.	AMBIENT CONDITION	6
2.3.	LIST OF TEST AND MEASUREMENT INSTRUMENTS	6
3.	MEASUREMENT UNCERTAINTY	7
4.	TEST SPECIFICATION, METHODS AND PROCEDURES	9
5.	SAR MEASUREMENT SYSTEM	10
5.1.	DEFINITION OF SPECIFIC ABSORPTION RATE (SAR)	10
5.2.	SPEAG DASY SYSTEM	10
5.2.1.	<i>Robot</i>	11
5.2.2.	<i>Probes</i>	12
5.2.3.	<i>Data Acquisition Electronics (DAE)</i>	12
5.2.4.	<i>Phantoms</i>	13
5.2.5.	<i>Device Holder</i>	14
5.2.6.	<i>System Validation Dipoles</i>	14
5.2.7.	<i>Tissue Simulating Liquids</i>	15
5.2.8.	<i>SAR System Verification</i>	18
6.	SAR MEASUREMENT PROCEDURE	19
6.1.	AREA & ZOOM SCAN PROCEDURE	19
6.2.	VOLUME SCAN PROCEDURE	19
6.3.	POWER DRIFT MONITORING	20
6.4.	SPATIAL PEAK SAR EVALUATION	20
6.5.	SAR AVERAGED METHODS	20
7.	SAR MEASUREMENT EVALUATION	21
7.1.	EUT CONFIGURATION AND SETTING	21
7.2.	EUT TESTING POSITION	23
7.2.1.	<i>Body Exposure Conditions</i>	23
7.3.	SIMULTANEOUS TRANSMISSION POSSIBILITIES	24
7.4.	ANTENNA LOCATION DISTRIBUTION	24
7.5.	TISSUE VERIFICATION	25
7.6.	SYSTEM VALIDATION	25
7.7.	SYSTEM VERIFICATION	25
8.	MAXIMUM OUTPUT POWER	26

Prüfbericht - Nr.: CN22G058 004

Test Report No.

Seite 3 von 33

Page 3 of 33

8.1.	MAXIMUM CONDUCTED POWER	26
8.2.	MEASURED CONDUCTED POWER RESULT	27
8.3.	SAR TESTING RESULTS	29
8.3.1.	<i>SAR Test Reduction Considerations</i>	29
8.3.2.	<i>SAR Results for Body Exposure Condition (Separation Distance is 0.5 cm Gap)</i>	30
8.3.3.	<i>SAR Results for Extremity Exposure Condition (Separation Distance is 0 cm Gap)</i>	30
8.3.4.	<i>Simultaneous Multi-band Transmission Evaluation</i>	32
APPENDIXES		33

1. General Information

1.1. Statement of Compliance

The maximum results of Specific Absorption Rate (SAR) found during testing for the EUT are as follows:

Equipment Class	Mode	Highest Reported Body SAR _{1g} (0.5 cm Gap) (W/kg)	Highest Reported Extremity SAR _{10g} (0 cm Gap) (W/kg)
DTS	2.4GHz WLAN	0.45	0.41
	2.4GHz SDR	0.13	0.12
DSS	Bluetooth	0.03	0.01
NII	5.2G GHz WLAN	0.41	0.27
	5.8G GHz WLAN	0.30	0.17
	5.8GHz SDR	1.17	0.60
/	Simultaneous Mode	1.17	0.60

Note:

1. This device is in compliance with Specific Absorption Rate (SAR) for general population/uncontrolled exposure limits (1.6W/kg as averaged over any 1 gram of tissue; 10-gram SAR for Product Specific 10g SAR, limit: 4.0W/kg) specified in FCC 47 CFR part 2 (2.1093) and ANSI/IEEE C95.1-1992/ IC RSS-102 Issue 5:2015, and had been tested in accordance with the measurement methods and procedures specified in IEEE 1528-2013 and FCC KDB publications.
2. This product is DJI remoter controller, it can be used in hand-held (normal operation) and Body-worn (considered as a Mini Tablet) modes. It's needless to test extremity SAR if body SAR satisfied.

1.2. Equipment Under Test (EUT) Information

1.2.1. General Information

Equipment Name	DJI RC
FCC ID	SS3- RM33022
IC	11805A- RM33022
HVIN	RM330
Brand Name	DJI
Model Name	RM330
Antenna Type	Fixed Internal Antenna
EUT Stage	Production Unit

1.2.2. Wireless Technologies

Wireless Technology and Frequency Range	WLAN: 2412 ~ 2472, 5180 ~ 5240, 5745 ~ 5825 Bluetooth: 2402 ~ 2480 SDR: 2.4GHz Bands, 5.8GHz Bands
Uplink Modulations	802.11b: DSSS 802.11a/g/n: OFDM Bluetooth® GFSK, $\pi/4$ -DQPSK, 8-DPSK, LE SDR: OFDM

Note:

1. The above EUT information is declared by manufacturer and for more detailed features description please refers to the manufacturer's specifications or User's Manual.

2. Test Sites

2.1. Test Facilities

TÜV Rheinland (Shenzhen) Co., Ltd.

No. 362 Huanguan Road Middle Longhua District, Shenzhen 518110 People's Republic of China

A2LA Cert. No.: 5162.01

FCC Registration No.: 694916

IC Registration No.: 25069

2.2. Ambient Condition

Ambient Temperature	22.1°C – 22.8°C
Relative Humidity	56% - 62%

2.3. List of Test and Measurement Instruments

Equipment	Manufacturer	Model	SN	Cal. Date	Cal. Interval
System Validation Dipole	SPEAG	D2450V2	1014	May. 19, 2021	3 years
System Validation Dipole	SPEAG	D5GHzV2	1280	May. 17, 2021	1 year
Dosimetric E-Field Probe	SPEAG	EX3DV4	7506	May. 26, 2021	1 year
Data Acquisition Electronics	SPEAG	DAE4	1557	May. 20, 2021	1 year
Signal Analyzer	R&S	FSV 7	103665	Aug. 06, 2021	1 year
Vector Network Analyzer	R&S	ZNB 8	107040	Aug. 06, 2021	1 year
Dielectric assessment Kit	SPEAG	DAK-3.5	1269	May. 19, 2021	1 year
Signal Generator	R&S	SMB 100A	180840	Aug. 07, 2021	1 year
EPM Series Power Meter	Keysight	N1914A	MY58240005	Dec. 02, 2021	2 years
Power Sensor	Keysight	N8481H	MY58250002	Dec. 02, 2021	1 year
Power Sensor	Keysight	N8481H	MY58250006	Dec. 02, 2021	1 year
DC Power Supply	Topward	3303D	809332	Dec. 02, 2021	1 year
Coaxial Directional Couper	Keysight	773D	MY52180552	Dec. 02, 2021	1 year
Coaxial Directional Couper	shhuaxiang	DTO-0.4/3.9-10	18052101	Dec. 02, 2021	1 year
Coaxial attenuator	Keysight	8491A	MY52463219	Dec. 02, 2021	1 year
Coaxial attenuator	Keysight	8491A	MY52463210	Dec. 02, 2021	1 year
Coaxial attenuator	Keysight	8491A	MY52463222	Dec. 02, 2021	1 year
Digital Thermometer	LKM	DTM3000	3116	Dec. 02, 2021	1 year
Power Amplifier Mini circuit	mini-circuits	ZHL-42W	SN002101809	N/A	N/A
Power Amplifier Mini circuit	mini-circuits	ZVE-8G	SN070501814	N/A	N/A
PHANTOM	SPEAG	ELI V8.0	2094	N/A	N/A
PHANTOM	SPEAG	SAM-Twin V8.0	1961	N/A	N/A

3. Measurement Uncertainty

Source of Uncertainty	Tolerance (± %)	Probability Distribution	Divisor	Ci 1g	Ci 10g	Standard Uncertainty 1g (± %)	Standard Uncertainty 10g (± %)	Vi Veff
Measurement System								
Probe Calibration	6.65	Normal	1	1	1	6.65	6.65	∞
Axial Isotropy	4.7	Rectangular	√3	0.7	0.7	1.9	1.9	∞
Hemispherical Isotropy	9.6	Rectangular	√3	0.7	0.7	3.9	3.9	∞
Boundary Effects	1	Rectangular	√3	1	1	0.6	0.6	∞
Linearity	4.7	Rectangular	√3	1	1	2.7	2.7	∞
Detection Limits	0.25	Rectangular	√3	1	1	0.1	0.1	∞
Modulation Response	2.4	Rectangular	√3	1	1	1.4	1.4	∞
Readout Electronics	0.3	Normal	1	1	1	0.3	0.3	∞
Response Time	0	Rectangular	√3	1	1	0.0	0.0	∞
Integration Time	1.7	Rectangular	√3	1	1	1.0	1.0	∞
RF Ambient – Noise	3	Rectangular	√3	1	1	1.7	1.7	∞
RF Ambient – Reflections	3	Rectangular	√3	1	1	1.7	1.7	∞
Probe Positioner	0.4	Rectangular	√3	1	1	0.2	0.2	∞
Probe Positioning	2.9	Rectangular	√3	1	1	1.7	1.7	∞
Max. SAR Evaluation	2	Rectangular	√3	1	1	1.2	1.2	∞
Test Sample Related								
Device Positioning	2.2 / 2.6	Normal	1	1	1	2.2	2.6	30
Device Holder	3.3 / 3.4	Normal	1	1	1	3.3	3.4	30
Power Drift	5	Rectangular	√3	1	1	2.9	2.9	∞
Power Scaling	0	Rectangular	√3	1	1	0.0	0.0	∞
Phantom and Setup								
Phantom Uncertainty	7.5	Rectangular	√3	1	1	4.3	4.3	∞
SAR correction	1.2 / 0.97	Rectangular	√3	1	0.84	0.7	0.5	∞
Liquid Conductivity (Meas.)	2.5	Normal	1	0.78	0.71	2.0	1.8	20
Liquid Permittivity (Meas.)	2.5	Normal	1	0.23	0.26	0.6	0.7	20
Temp. unc. - Conductivity	5.2	Rectangular	√3	0.78	0.71	2.3	2.1	∞
Temp. unc. - Permittivity	0.8	Rectangular	√3	0.23	0.26	0.1	0.1	∞
Combined Standard Uncertainty (K = 1)						11.11	11.13	
Expanded Uncertainty (K = 2)						22.2	22.3	

Uncertainty budget for frequency range 300 MHz to 3 GHz

Source of Uncertainty	Tolerance (± %)	Probability Distribution	Divisor	Ci 1g	Ci 10g	Standard Uncertainty 1g (± %)	Standard Uncertainty 10g (± %)	Vi Veff
Measurement System								
Probe Calibration	6.65	Normal	1	1	1	6.65	6.65	∞
Axial Isotropy	4.7	Rectangular	√3	0.7	0.7	1.9	1.9	∞
Hemispherical Isotropy	9.6	Rectangular	√3	0.7	0.7	3.9	3.9	∞
Boundary Effects	2	Rectangular	√3	1	1	1.2	1.2	∞
Linearity	4.7	Rectangular	√3	1	1	2.7	2.7	∞
Detection Limits	0.25	Rectangular	√3	1	1	0.1	0.1	∞
Modulation Response	2.4	Rectangular	√3	1	1	1.4	1.4	∞
Readout Electronics	0.3	Normal	1	1	1	0.3	0.3	∞
Response Time	0	Rectangular	√3	1	1	0.0	0.0	∞
Integration Time	1.7	Rectangular	√3	1	1	1.0	1.0	∞
RF Ambient – Noise	3	Rectangular	√3	1	1	1.7	1.7	∞
RF Ambient – Reflections	3	Rectangular	√3	1	1	1.7	1.7	∞
Probe Positioner	0.4	Rectangular	√3	1	1	0.2	0.2	∞
Probe Positioning	6.7	Rectangular	√3	1	1	3.9	3.9	∞
Max. SAR Evaluation	4	Rectangular	√3	1	1	2.3	2.3	∞
Test Sample Related								
Device Positioning	2.2 / 2.6	Normal	1	1	1	2.2	2.6	30
Device Holder	3.3 / 3.4	Normal	1	1	1	3.3	3.4	30
Power Drift	5	Rectangular	√3	1	1	2.9	2.9	∞
Power Scaling	0	Rectangular	√3	1	1	0.0	0.0	∞
Phantom and Setup								
Phantom Uncertainty	7.9	Rectangular	√3	1	1	4.6	4.6	∞
SAR correction	1.2 / 0.97	Rectangular	√3	1	0.84	0.7	0.5	∞
Liquid Conductivity (Meas.)	2.5	Normal	1	0.78	0.71	2.0	1.8	20
Liquid Permittivity (Meas.)	2.5	Normal	1	0.23	0.26	0.6	0.7	20
Temp. unc. - Conductivity	3.4	Rectangular	√3	0.78	0.71	1.5	1.4	∞
Temp. unc. - Permittivity	0.4	Rectangular	√3	0.23	0.26	0.1	0.1	∞
Combined Standard Uncertainty (K = 1)						11.86	11.91	
Expanded Uncertainty (K = 2)						23.7	23.8	

Uncertainty budget for frequency range 3 GHz to 6 GHz

4. Test Specification, Methods and Procedures

The tests documented in this report were performed in accordance with FCC 47 CFR § 2.1093, IEEE STD 1528- 2013, the following FCC Published RF exposure KDB procedures & manufacturer KDB inquiries:

- KDB 865664 D01 SAR Measurement 100 MHz to 6 GHz v01r04
- KDB 865664 D02 RF Exposure Reporting v01r02
- KDB 248227 D01 802 11 Wi-Fi SAR v02r02
- KDB 447498 D01 General RF Exposure Guidance v06
- KDB 447498 D04 Interim General RF Exposure Guidance v01
- KDB 941225 D07 UMPC Mini Tablet v01r02
- IC RSS-102 Issue 5:March 2015
- IEC/IEEE 62209-1528:2020 Measurement procedure for the assessment of specific absorption rate of human exposure to radio frequency fields from hand-held and body-mounted wireless communication devices - Part 1528: Human models, instrumentation, and procedures (Frequency range of 4 MHz to 10 GHz)

In addition to the above, the following information was used:

- [TCB workshop](#) April, 2019; Page 19, Tissue Simulating Liquids(TSL)

5. SAR Measurement System

5.1. Definition of Specific Absorption Rate (SAR)

SAR is related to the rate at which energy is absorbed per unit mass in an object exposed to a radio field. The SAR distribution in a biological body is complicated and is usually carried out by experimental techniques or numerical modeling. The standard recommends limits for two tiers of groups, occupational/controlled and general population/uncontrolled, based on a person's awareness and ability to exercise control over his or her exposure. In general, occupational/controlled exposure limits are higher than the limits for general population/uncontrolled.

The SAR definition is the time derivative (rate) of the incremental energy (dW) absorbed by (dissipated in) an incremental mass (dm) contained in a volume element (dv) of a given density (ρ). The equation description is as below:

$$\text{SAR} = \frac{d}{dt} \left(\frac{dW}{dm} \right) = \frac{d}{dt} \left(\frac{dW}{\rho dv} \right)$$

SAR is expressed in units of Watts per kilogram (W/kg)

SAR measurement can be related to the electrical field in the tissue by

$$\text{SAR} = \frac{\sigma |E|^2}{\rho}$$

Where: σ is the conductivity of the tissue, ρ is the mass density of the tissue and E is the RMS electrical field strength.

5.2. SPEAG DASY System

DASY system consists of high precision robot, probe alignment sensor, phantom, robot controller, controlled measurement server and near-field probe. The robot includes six axes that can move to the precision position of the DASY5 software defined. The DASY software can define the area that is detected by the probe. The robot is connected to controlled box. Controlled measurement server is connected to the controlled robot box. The DAE includes amplifier, signal multiplexing, AD converter, offset measurement and surface detection. It is connected to the Electro-optical coupler (ECO). The ECO performs the conversion from the optical into digital electric signal of the DAE and transfers data to the PC.

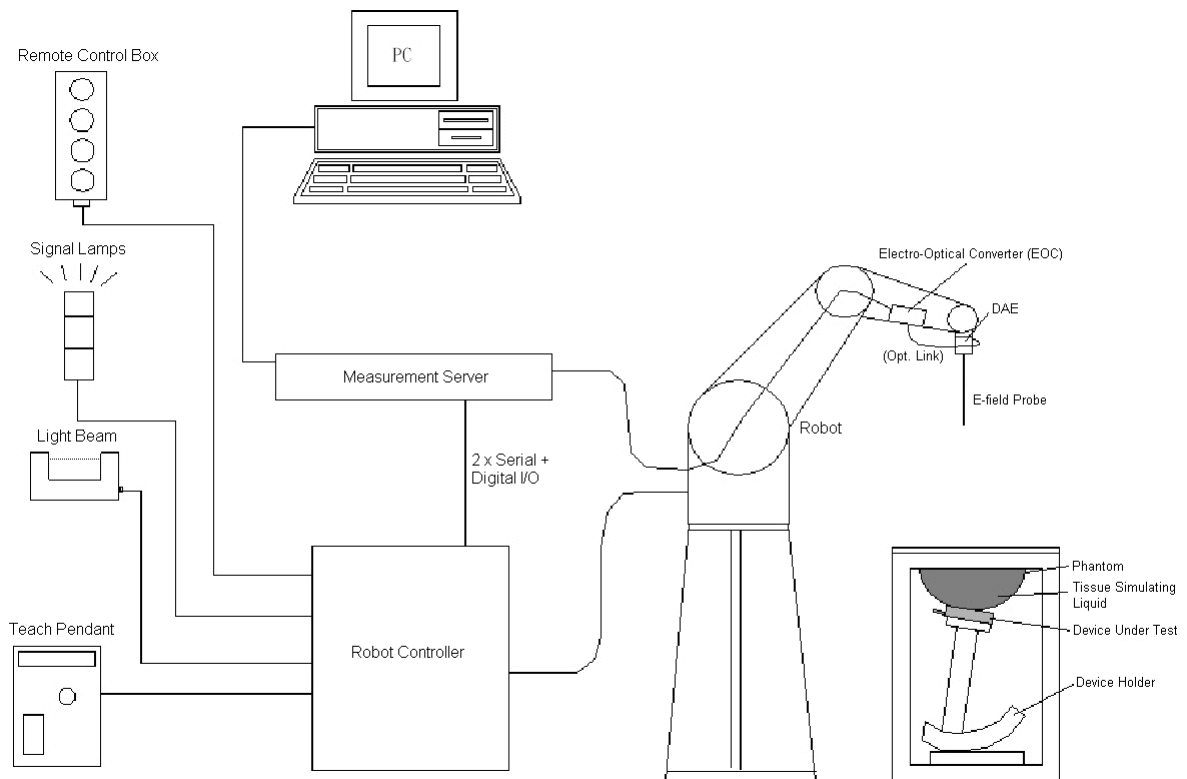

DASY System Setup

5.2.1. Robot

The DASY system uses the high precision robots from Stäubli SA (France). For the 6-axis controller system, the robot controller version (DASY5: CS8c) from Stäubli is used. The Stäubli robot series have many features that are important for our application:

- High precision (repeatability ± 0.035 mm)
- High reliability (industrial design)
- Jerk-free straight movements
- Low ELF interference (the closed metallic construction shields against motor control fields)

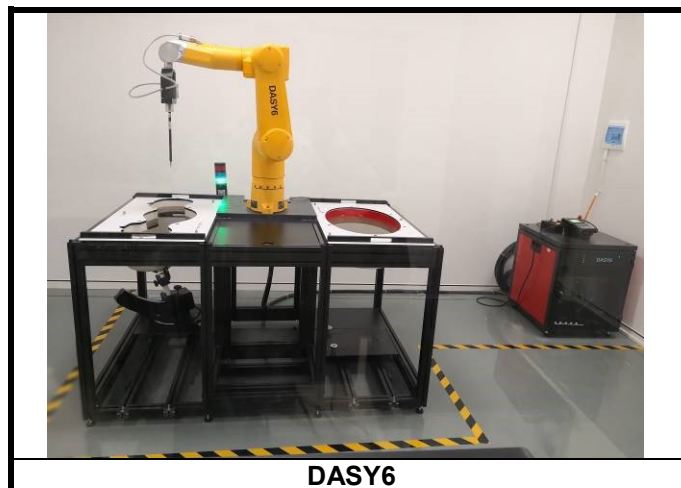

DASY6

5.2.2. Probes

The SAR measurement is conducted with the dosimetric probe. The probe is specially designed and calibrated for use in liquid with high permittivity. The dosimetric probe has special calibration in liquid at different frequency.

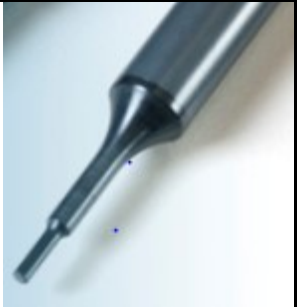
Model	EX3DV4	
Construction	Symmetrical design with triangular core. Built-in shielding against static charges. PEEK enclosure material (resistant to organic solvents, e.g., DGBE).	
Frequency	10 MHz to 6 GHz Linearity: ± 0.2 dB	
Directivity	± 0.3 dB in HSL (rotation around probe axis) ± 0.5 dB in tissue material (rotation normal to probe axis)	
Dynamic Range	10 μ W/g to 100 mW/g Linearity: ± 0.2 dB (noise: typically < 1 μ W/g)	
Dimensions	Overall length: 337 mm (Tip: 20 mm) Tip diameter: 2.5 mm (Body: 12 mm) Typical distance from probe tip to dipole centers: 1 mm	

5.2.3. Data Acquisition Electronics (DAE)

Model	DAE4	
Construction	Signal amplifier, multiplexer, A/D converter and control logic. Serial optical link for communication with DASY embedded system (fully remote controlled). Two step probe touch detector for mechanical surface detection and emergency robot stop.	
Measurement Range	-100 to +300 mV (16 bit resolution and two range settings: 4mV, 400mV)	
Input Offset Voltage	$< 5\mu$ V (with auto zero)	
Input Bias Current	< 50 fA	
Dimensions	60 x 60 x 68 mm	

5.2.4. Phantoms

Model	Twin SAM	
Construction	The shell corresponds to the specifications of the Specific Anthropomorphic Mannequin (SAM) phantom defined in IEEE 1528 and IEC 62209-1. It enables the dosimetric evaluation of left and right hand phone usage as well as body mounted usage at the flat phantom region. A cover prevents evaporation of the liquid. Reference markings on the phantom allow the complete setup of all predefined phantom positions and measurement grids by teaching three points with the robot.	
Material	Vinylester, glass fiber reinforced (VE-GF)	
Shell Thickness	2 ± 0.2 mm (6 ± 0.2 mm at ear point)	
Dimensions	Length: 1000 mm Width: 500 mm Height: adjustable feet	
Filling Volume	approx. 25 liters	

Model	ELI	
Construction	Phantom for compliance testing of handheld and body-mounted wireless devices in the frequency range of 30 MHz to 6 GHz. ELI is fully compatible with the IEC 62209-2 standard and all known tissue simulating liquids. ELI has been optimized regarding its performance and can be integrated into our standard phantom tables. A cover prevents evaporation of the liquid. Reference markings on the phantom allow installation of the complete setup, including all predefined phantom positions and measurement grids, by teaching three points. The phantom is compatible with all SPEAG dosimetric probes and dipoles.	
Material	Vinylester, glass fiber reinforced (VE-GF)	
Shell Thickness	2.0 ± 0.2 mm (bottom plate)	
Dimensions	Major axis: 600 mm Minor axis: 400 mm	
Filling Volume	approx. 30 liters	

5.2.5. Device Holder

Model	Mounting Device	
Construction	In combination with the Twin SAM Phantom or ELI4, the Mounting Device enables the rotation of the mounted transmitter device in spherical coordinates. Rotation point is the ear opening point. Transmitter devices can be easily and accurately positioned according to IEC, IEEE, FCC or other specifications. The device holder can be locked for positioning at different phantom sections (left head, right head, flat).	
Material	POM	

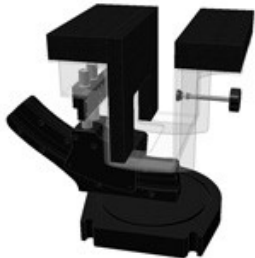
Model	Laptop Extensions Kit	
Construction	Simple but effective and easy-to-use extension for Mounting Device that facilitates the testing of larger devices according to IEC 62209-2 (e.g., laptops, cameras, etc.). It is lightweight and fits easily on the upper part of the Mounting Device in place of the phone positioner.	
Material	POM, Acrylic glass, Foam	

5.2.6. System Validation Dipoles

Model	D-Serial	
Construction	Symmetrical dipole with 1/4 balun. Enables measurement of feed point impedance with NWA. Matched for use near flat phantoms filled with tissue simulating solutions.	
Frequency	750 MHz to 5800 MHz	
Return Loss	> 20 dB	
Power Capability	> 100 W (f < 1GHz), > 40 W (f > 1GHz)	

5.2.7. Tissue Simulating Liquids

For SAR measurement of the field distribution inside the phantom, the phantom must be filled with homogeneous tissue simulating liquid to a depth of at least 15 cm. For head SAR testing, the liquid height from the ear reference point (ERP) of the phantom to the liquid top surface is larger than 15 cm. For body SAR testing, the liquid height from the center of the flat phantom to the liquid top surface is larger than 15 cm. The nominal dielectric values of the tissue simulating liquids in the phantom and the tolerance of 5% are listed.

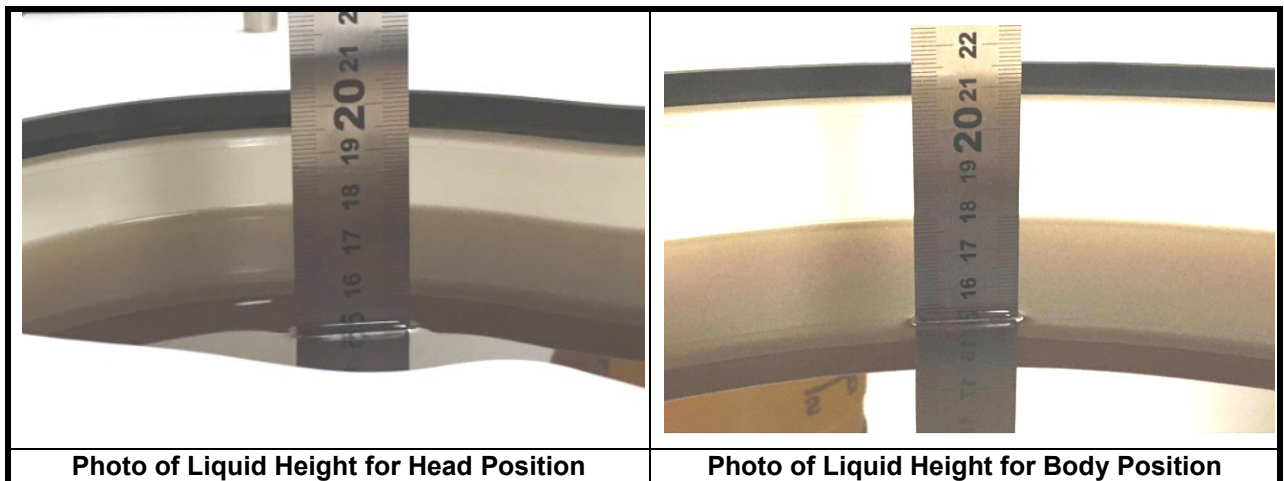

The dielectric properties of the head tissue simulating liquids are defined in IEEE 1528, and KDB 865664 D01 Appendix A. For the body tissue simulating liquids, the dielectric properties are defined in KDB 865664 D01 Appendix A. The dielectric properties of the tissue simulating liquids were verified prior to the SAR evaluation using a dielectric assessment kit and a network analyzer.

Targets of Tissue Simulating Liquid

Frequency (MHz)	Target Permittivity	Range of $\pm 5\%$	Target Conductivity	Range of $\pm 5\%$
For Head				
750	41.9	39.8 ~ 44.0	0.89	0.85 ~ 0.93
835	41.5	39.4 ~ 43.6	0.90	0.86 ~ 0.95
900	41.5	39.4 ~ 43.6	0.97	0.92 ~ 1.02
1450	40.5	38.5 ~ 42.5	1.20	1.14 ~ 1.26
1640	40.3	38.3 ~ 42.3	1.29	1.23 ~ 1.35
1750	40.1	38.1 ~ 42.1	1.37	1.30 ~ 1.44
1800	40.0	38.0 ~ 42.0	1.40	1.33 ~ 1.47
1900	40.0	38.0 ~ 42.0	1.40	1.33 ~ 1.47
2000	40.0	38.0 ~ 42.0	1.40	1.33 ~ 1.47
2300	39.5	37.5 ~ 41.5	1.67	1.59 ~ 1.75
2450	39.2	37.2 ~ 41.2	1.80	1.71 ~ 1.89
2600	39.0	37.1 ~ 41.0	1.96	1.86 ~ 2.06
3500	37.9	36.0 ~ 39.8	2.91	2.76 ~ 3.06
5200	36.0	34.2 ~ 37.8	4.66	4.43 ~ 4.89
5300	35.9	34.1 ~ 37.7	4.76	4.52 ~ 5.00
5500	35.6	33.8 ~ 37.4	4.96	4.71 ~ 5.21
5600	35.5	33.7 ~ 37.3	5.07	4.82 ~ 5.32
5800	35.3	33.5 ~ 37.1	5.27	5.01 ~ 5.53
For Body				
750	55.5	52.7 ~ 58.3	0.96	0.91 ~ 1.01
835	55.2	52.4 ~ 58.0	0.97	0.92 ~ 1.02
900	55.0	52.3 ~ 57.8	1.05	1.00 ~ 1.10
1450	54.0	51.3 ~ 56.7	1.30	1.24 ~ 1.37
1640	53.8	51.1 ~ 56.5	1.40	1.33 ~ 1.47
1750	53.4	50.7 ~ 56.1	1.49	1.42 ~ 1.56
1800	53.3	50.6 ~ 56.0	1.52	1.44 ~ 1.60
1900	53.3	50.6 ~ 56.0	1.52	1.44 ~ 1.60
2000	53.3	50.6 ~ 56.0	1.52	1.44 ~ 1.60
2300	52.9	50.3 ~ 55.5	1.81	1.72 ~ 1.90
2450	52.7	50.1 ~ 55.3	1.95	1.85 ~ 2.05
2600	52.5	49.9 ~ 55.1	2.16	2.05 ~ 2.27
3500	51.3	48.7 ~ 53.9	3.31	3.14 ~ 3.48
5200	49.0	46.6 ~ 51.5	5.30	5.04 ~ 5.57
5300	48.9	46.5 ~ 51.3	5.42	5.15 ~ 5.69
5500	48.6	46.2 ~ 51.0	5.65	5.37 ~ 5.93
5600	48.5	46.1 ~ 50.9	5.77	5.48 ~ 6.06
5800	48.2	45.8 ~ 50.6	6.00	5.70 ~ 6.30

The following table gives the recipes for tissue simulating liquids.

Recipes of Tissue Simulating Liquid

Tissue Type	Bactericide	DGBE	HEC	NaCl	Sucrose	Triton X-100	Water	Diethylene Glycol Mono-hexylether
H750	0.2	-	0.2	1.5	56.0	-	42.1	-
H835	0.2	-	0.2	1.5	57.0	-	41.1	-
H900	0.2	-	0.2	1.4	58.0	-	40.2	-
H1450	-	43.3	-	0.6	-	-	56.1	-
H1640	-	45.8	-	0.5	-	-	53.7	-
H1750	-	47.0	-	0.4	-	-	52.6	-
H1800	-	44.5	-	0.3	-	-	55.2	-
H1900	-	44.5	-	0.2	-	-	55.3	-
H2000	-	44.5	-	0.1	-	-	55.4	-
H2300	-	44.9	-	0.1	-	-	55.0	-
H2450	-	45.0	-	0.1	-	-	54.9	-
H2600	-	45.1	-	0.1	-	-	54.8	-
H3500	-	8.0	-	0.2	-	20.0	71.8	-
H5G	-	-	-	-	-	17.2	65.5	17.3
B750	0.2	-	0.2	0.8	48.8	-	50.0	-
B835	0.2	-	0.2	0.9	48.5	-	50.2	-
B900	0.2	-	0.2	0.9	48.2	-	50.5	-
B1450	-	34.0	-	0.3	-	-	65.7	-
B1640	-	32.5	-	0.3	-	-	67.2	-
B1750	-	31.0	-	0.2	-	-	68.8	-
B1800	-	29.5	-	0.4	-	-	70.1	-
B1900	-	29.5	-	0.3	-	-	70.2	-
B2000	-	30.0	-	0.2	-	-	69.8	-
B2300	-	31.0	-	0.1	-	-	68.9	-
B2450	-	31.4	-	0.1	-	-	68.5	-
B2600	-	31.8	-	0.1	-	-	68.1	-
B3500	-	28.8	-	0.1	-	-	71.1	-
B5G	-	-	-	-	-	10.7	78.6	10.7

Simulating Head Liquid (HBBL600-6000MHz), Manufactured by SPEAG:

Water (% by weight)	Esters, Emulsifiers, Inhibitors (% by weight)	Sodium salt (% by weight)
50 - 65%	10 - 30%	8 - 25%

Simulating Body Liquid (MBBL600-6000MHz), Manufactured by SPEAG:

Water (% by weight)	Esters, Emulsifiers, Inhibitors (% by weight)	Sodium salt (% by weight)
60 - 80%	20 - 40%	0 - 1.5%

5.2.8.SAR System Verification

The system check verifies that the system operates within its specifications. It is performed daily or before every SAR measurement. The system check uses normal SAR measurements in the flat section of the phantom with a matched dipole at a specified distance. The system verification setup is shown as below.

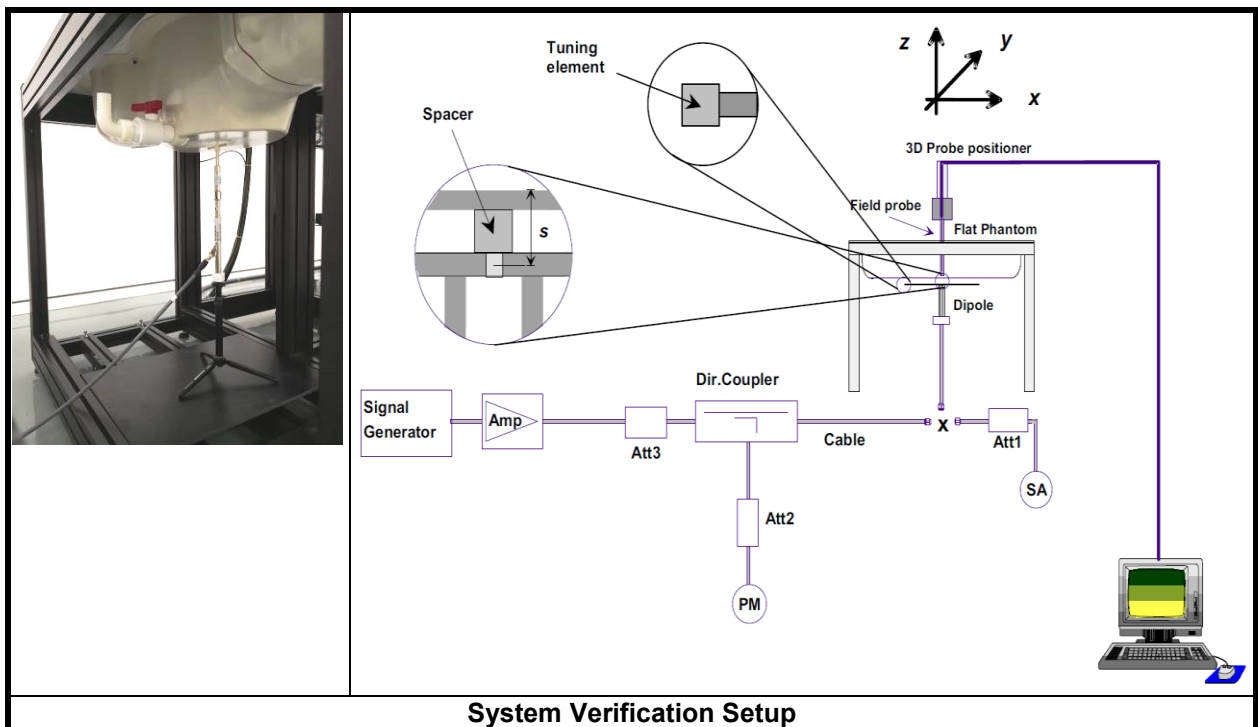

The validation dipole is placed beneath the flat phantom with the specific spacer in place. The distance spacer is touch the phantom surface with a light pressure at the reference marking and be oriented parallel to the long side of the phantom. The spectrum analyzer measures the forward power at the location of the system check dipole connector. The signal generator is adjusted for the desired forward power (250 mW is used for 700 MHz to 3 GHz, 100 mW is used for 3.5 GHz to 6 GHz) at the dipole connector and the power meter is read at that level. After connecting the cable to the dipole, the signal generator is readjusted for the same reading at power meter.

After system check testing, the SAR result will be normalized to 1W forward input power and compared with the reference SAR value derived from validation dipole certificate report. The deviation of system check should be within 10 %.

6. SAR Measurement Procedure

According to the SAR test standard, the recommended procedure for assessing the peak spatial-average SAR value consists of the following steps:

- (a) Power reference measurement
- (b) Area scan
- (c) Zoom scan
- (d) Power drift measurement

The SAR measurement procedures for each of test conditions are as follows:

- (a) Make EUT to transmit maximum output power
- (b) Measure conducted output power through RF cable
- (c) Place the EUT in the specific position of phantom
- (d) Perform SAR testing steps on the DASY system
- (e) Record the SAR value

6.1. Area & Zoom Scan Procedure

First Area Scan is used to locate the approximate location(s) of the local peak SAR value(s). The measurement grid within an Area Scan is defined by the grid extent, grid step size and grid offset. Next, in order to determine the EM field distribution in a three-dimensional spatial extension, Zoom Scan is required. The Zoom Scan is performed around the highest E-field value to determine the averaged SAR-distribution over 10 g. According to KDB 865664 D01, the resolution for Area and Zoom scan is specified in the table below.

Items	<= 2 GHz	2-3 GHz	3-4 GHz	4-5 GHz	5-6 GHz
Area Scan ($\Delta x, \Delta y$)	<= 15 mm	<= 12 mm	<= 12 mm	<= 10 mm	<= 10 mm
Zoom Scan ($\Delta x, \Delta y$)	<= 8 mm	<= 5 mm	<= 5 mm	<= 4 mm	<= 4 mm
Zoom Scan (Δz)	<= 5 mm	<= 5 mm	<= 4 mm	<= 3 mm	<= 2 mm
Zoom Scan Volume	>= 30 mm	>= 30 mm	>= 28 mm	>= 25 mm	>= 22 mm

Note:

When zoom scan is required and report SAR is <= 1.4 W/kg, the zoom scan resolution of $\Delta x / \Delta y$ (2-3GHz: <= 8 mm, 3-4GHz: <= 7 mm, 4-6GHz: <= 5 mm) may be applied.

6.2. Volume Scan Procedure

The volume scan is used for assess overlapping SAR distributions for antennas transmitting in different frequency bands. It is equivalent to an oversized zoom scan used in standalone measurements. The measurement volume will be used to enclose all the simultaneous transmitting antennas. For antennas transmitting simultaneously in different frequency bands, the volume scan is measured separately in each frequency band. In order to sum correctly to compute the 1g aggregate SAR, the EUT remain in the same test position for all measurements and all volume scan use the same spatial resolution and grid spacing. When all volume scan were completed, the software, SEMCAD postprocessor can combine and subsequently superpose these measurement data to calculating the multiband SAR.

6.3. Power Drift Monitoring

All SAR testing is under the EUT install full charged battery and transmit maximum output power. In DASY measurement software, the power reference measurement and power drift measurement procedures are used for monitoring the power drift of EUT during SAR test. Both these procedures measure the field at a specified reference position before and after the SAR testing. The software will calculate the field difference in dB. If the power drift more than 5%, the SAR will be retested.

6.4. Spatial Peak SAR Evaluation

The procedure for spatial peak SAR evaluation has been implemented according to the test standard. It can be conducted for 1g and 10g, as well as for user-specific masses. The DASY software includes all numerical procedures necessary to evaluate the spatial peak SAR value.

The base for the evaluation is a "cube" measurement. The measured volume must include the 1g and 10g cubes with the highest averaged SAR values. For that purpose, the center of the measured volume is aligned to the interpolated peak SAR value of a previously performed area scan.

The entire evaluation of the spatial peak values is performed within the post-processing engine (SEMCAD). The system always gives the maximum values for the 1g and 10g cubes. The algorithm to find the cube with highest averaged SAR is divided into the following stages:

- (a) Extraction of the measured data (grid and values) from the Zoom Scan
- (b) Calculation of the SAR value at every measurement point based on all stored data (A/D values and measurement parameters)
- (c) Generation of a high-resolution mesh within the measured volume
- (d) Interpolation of all measured values from the measurement grid to the high-resolution grid
- (e) Extrapolation of the entire 3-D field distribution to the phantom surface over the distance from sensor to surface
- (f) Calculation of the averaged SAR within masses of 1g and 10g

6.5. SAR Averaged Methods

In DASY, the interpolation and extrapolation are both based on the modified Quadratic Shepard's method. The interpolation scheme combines a least-square fitted function method and a weighted average method which are the two basic types of computational interpolation and approximation.

Extrapolation routines are used to obtain SAR values between the lowest measurement points and the inner phantom surface. The extrapolation distance is determined by the surface detection distance and the probe sensor offset. The uncertainty increases with the extrapolation distance. To keep the uncertainty within 1% for the 1 g and 10 g cubes, the extrapolation distance should not be larger than 5 mm.

7. SAR Measurement Evaluation

7.1. EUT Configuration and Setting

<Considerations Related to WLAN for Setup and Testing>

In general, various vendor specific external test software and chipset based internal test modes are typically used for SAR measurement. These chipset based test mode utilities are generally hardware and manufacturer dependent, and often include substantial flexibility to reconfigure or reprogram a device. A Wi-Fi device must be configured to transmit continuously at the required data rate, channel bandwidth and signal modulation, using the highest transmission duty factor supported by the test mode tools for SAR measurement. The test frequencies established using test mode must correspond to the actual channel frequencies. When 802.11 frame gaps are accounted for in the transmission, a maximum transmission duty factor of 92 - 96% is typically achievable in most test mode configurations. A minimum transmission duty factor of 85% is required to avoid certain hardware and device implementation issues related to wide range SAR scaling. In addition, a periodic transmission duty factor is required for current generation SAR systems to measure SAR correctly. The reported SAR must be scaled to 100% transmission duty factor to determine compliance at the maximum tune-up tolerance limit.

According to KDB 248227 D01, this device has installed WLAN engineering testing software which can provide continuous transmitting RF signal. During WLAN SAR testing, this device was operated to transmit continuously at the maximum transmission duty with specified transmission mode, operating frequency, lowest data rate, and maximum output power.

Initial Test Configuration

An initial test configuration is determined for OFDM transmission modes in 2.4 GHz and 5 GHz bands according to the channel bandwidth, modulation and data rate combination(s) with the highest maximum output power specified for production units in each standalone and aggregated frequency band. When the same maximum power is specified for multiple transmission modes in a frequency band, the largest channel bandwidth, lowest order modulation, lowest data rate and lowest order 802.11a/g/n/ac mode is used for SAR measurement, on the highest measured output power channel in the initial test configuration, for each frequency band.

Subsequent Test Configuration

SAR measurement requirements for the remaining 802.11 transmission mode configurations that have not been tested in the initial test configuration are determined separately for each standalone and aggregated frequency band, in each exposure condition, according to the maximum output power specified for production units. Additional power measurements may be required to determine if SAR measurements are required for subsequent highest output power channels in a subsequent test configuration. When the highest reported SAR for the initial test configuration according to the initial test position or fixed exposure position requirements, is adjusted by the ratio of the subsequent test configuration to initial test configuration specified maximum output power and the adjusted SAR is ≤ 1.2 W/kg, SAR is not required for that subsequent test configuration.

SAR Test Configuration and Channel Selection

When multiple channel bandwidth configurations in a frequency band have the same specified maximum output power, the initial test configuration is using largest channel bandwidth, lowest order modulation, lowest data rate, and lowest order 802.11 mode (i.e., 802.11a is chosen over 802.11n then 802.11ac or 802.11g is

chosen over 802.11n). After an initial test configuration is determined, if multiple test channels have the same measured maximum output power, the channel chosen for SAR measurement is determined according to the following.

- 1) The channel closest to mid-band frequency is selected for SAR measurement.
- 2) For channels with equal separation from mid-band frequency; for example, high and low channels or two mid-band channels, the higher frequency (number) channel is selected for SAR measurement.

<Considerations Related to Bluetooth for Setup and Testing>

This device has installed Bluetooth engineering testing software which can provide continuous transmitting RF signal. During Bluetooth SAR testing, this device was operated to transmit continuously at the maximum transmission duty with specified transmission mode, operating frequency, lowest data rate, and maximum output power.

This equipment SDR technology SAR test reference 248227 D01 802 11 Wi-Fi SAR

<Considerations Related to SDR for Setup and Testing>

This device has installed SDR engineering testing software which can provide continuous transmitting RF signal. During SDR SAR testing, this device was operated to transmit continuously at the maximum transmission duty with specified transmission mode, operating frequency, lowest data rate, and maximum output power.

Initial Test Configuration

An initial test configuration is determined for SDR transmission modes in 2.4 GHz and 5 GHz bands according to the channel bandwidth, modulation and data rate combination(s) with the highest maximum output power specified for production units in each standalone and aggregated frequency band. When the same maximum power is specified for multiple transmission modes in a frequency band, the largest channel bandwidth, lowest order modulation, is used for SAR measurement, on the highest measured output power channel in the initial test configuration, for each frequency band.

Subsequent Test Configuration

SAR measurement requirements for the remaining SDR transmission mode configurations that have not been tested in the initial test configuration are determined separately for each standalone and aggregated frequency band, in each exposure condition, according to the maximum output power specified for production units. Additional power measurements may be required to determine if SAR measurements are required for subsequent highest output power channels in a subsequent test configuration. When the highest reported SAR for the initial test configuration according to the initial test position or fixed exposure position requirements, is adjusted by the ratio of the subsequent test configuration to initial test configuration specified maximum output power and the adjusted SAR is ≤ 1.2 W/kg, SAR is not required for that subsequent test configuration.

7.2.EUT Testing Position

7.2.1.Body Exposure Conditions

For this device, SAR evaluation is required on all sides and edges with a transmitting antenna within 25 mm from that surface or edge, at 5 mm separation from a flat phantom, for the data modes, wireless technologies and frequency bands supported by the device to determine SAR compliance. Added Extremity SAR for worst location and The 10-g extremity SAR test exclusions may be applied.

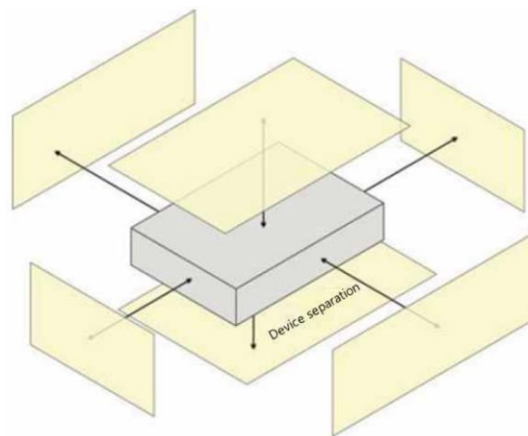

7.3. Simultaneous Transmission Possibilities

The simultaneous transmission possibilities for this device are listed as below.

Simultaneous TX Combination	Capable Transmit Configurations	Supported?
1	SDR 2.4GHz + WLAN 5GHz	Yes
2	SDR 5.8GHz + WLAN 2.4GHz	Yes
3	SDR + BT	Yes
4	SDR 2.4GHz + SDR 5.8GHz	No
5	WLAN 2.4GHz + WLAN 5GHz	No

7.4. Antenna location distribution

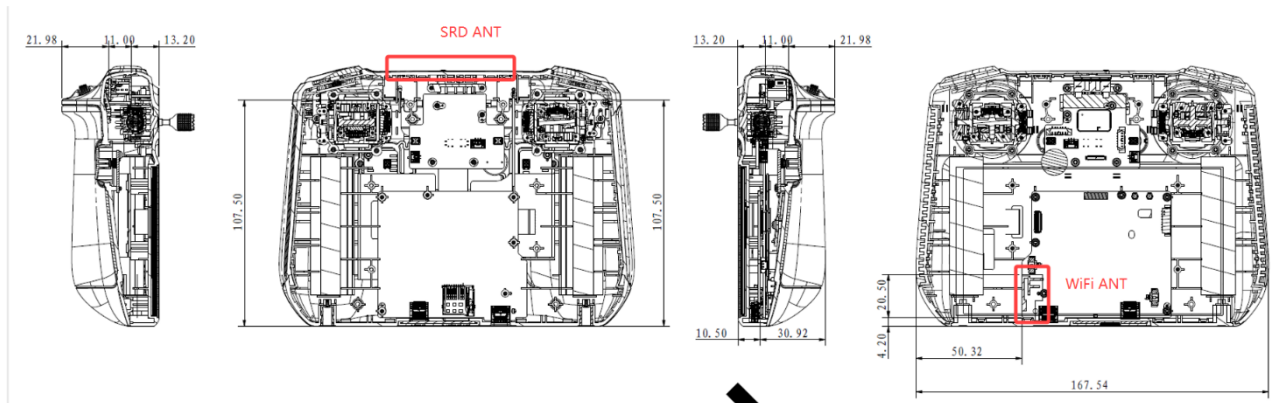

The SAR test sides:

Antenna	Front side	Rear side	Left Side	Right Side	Top Side	Bottom Side
SDR Antenna	Y	Y	N	N	Y	N
WLAN / BT Antenna	Y	Y	N	N	N	Y

Note: SAR test for the sides far from the antennas are not required, antenna locations as above.

7.5. Tissue Verification

The measuring results for tissue simulating liquid are shown as below.

Test Date	Tissue Type	Frequency (MHz)	Measured Conductivity (σ)	Measured Permittivity (ϵ_r)	Target Conductivity (σ)	Target Permittivity (ϵ_r)	Conductivity Deviation (%)	Permittivity Deviation (%)
Mar. 01, 2022	Head	2450	1.872	38.153	1.80	39.20	4.00	-2.67
		2402	1.836	38.241	1.76	39.29	4.44	-2.67
		2435.5	1.861	38.184	1.79	39.23	4.14	-2.67
		2437	1.862	38.182	1.79	39.22	4.14	-2.65
Mar. 02, 2022	Head	5250	4.691	35.324	4.71	35.90	-0.40	-1.60
		5200	4.642	35.411	4.66	36.00	-0.39	-1.64
Mar. 02, 2022	Head	5800	5.249	34.536	5.27	35.30	-0.40	-2.16
		5730.5	5.178	34.636	5.20	35.37	-0.42	-2.08
		5784.5	5.229	34.560	5.26	35.31	-0.49	-2.12
		5825	5.273	34.506	5.30	35.27	-0.43	-2.17
		5844.5	5.297	34.475	5.32	35.25	-0.38	-2.20

Note:

The dielectric properties of the tissue simulating liquid must be measured within 24 hours before the SAR testing and within $\pm 5\%$ of the target values. Liquid temperature during the SAR testing must be within $\pm 2^\circ\text{C}$.

7.6. System Validation

The SAR measurement system was validated according to procedures in KDB 865664 D01. The validation status in tabulated summary is as below.

Test Date	Probe S/N	Calibration Point	Measured Conductivity (σ)	Measured Permittivity (ϵ_r)	Validation for CW			Validation for Modulation		
					Sensitivity Range	Probe Linearity	Probe Isotropy	Modulation Type	Duty Factor	PAR
Mar. 01, 2022	7506	Head 2450	1.872	38.153	Pass	Pass	Pass	OFDM	N/A	Pass
Mar. 02, 2022	7506	Head 5200	4.691	35.324	Pass	Pass	Pass	OFDM	N/A	Pass
Mar. 02, 2022	7506	Head 5800	5.249	34.536	Pass	Pass	Pass	OFDM	N/A	Pass

7.7. System Verification

The measuring result for system verification is tabulated as below.

Test Date	Mode	Frequency (MHz)	1W Target SAR-1g (W/kg)	Measured SAR-1g (W/kg)	Normalized to 1W SAR-1g (W/kg)	Deviation (%)	Dipole S/N	Probe S/N	DAE S/N
Mar. 01, 2022	Head	2450	51.80	12.60	50.40	-2.70	1014	7506	1557
Mar. 02, 2022	Head	5250	79.20	8.51	85.10	7.45	1280	7506	1557
Mar. 02, 2022	Head	5800	80.60	8.29	82.90	2.85	1280	7506	1557

Note:

Comparing to the reference SAR value provided by SPEAG, the validation data should be within its specification of 10 %. The result indicates the system check can meet the variation criterion and the plots can be referred to Appendix A of this report.

8. Maximum Output Power

8.1. Maximum Conducted Power

The maximum Conducted Power (Unit: dBm) including tune-up tolerance is shown as below.

Mode	2.4G WLAN	5.2G WLAN	5.8G WLAN
802.11b	Ch1: 13.5 Ch2~Ch10: 16.5 Ch11: 13.5	N/A	N/A
802.11g	Ch1: 13.5 Ch2~Ch10: 16.0 Ch11: 13.5	N/A	N/A
802.11a	N/A	17.0	17.5
802.11n HT20	Ch1: 13.5 Ch2~Ch10: 16.0 Ch11: 13.5	16.0	17.0
802.11n HT40	Ch3: 12.0 Ch4~Ch8: 14.5 Ch9: 12.0	15.0	16.5

Mode	2.4G Bluetooth
DH5	4.5
3DH5	4.5
BLE	4.0

Mode	2.4G SDR	5.8G SDR
1.4M	24.5	24.5
1.4M CA Mode	24.5	24.5
3M	24.5	24.5
10M	14.5	14.5
20M	14.5	14.5

8.2. Measured Conducted Power Result

All Rate have been tested, the Worst average power (Unit: dBm) is shown as below.

<WLAN 2.4G>

Mode	802.11b (1Mbps)		
Channel / Frequency (MHz)	1 (2412)	6 (2437)	11 (2462)
Average power	12.01	15.89	12.67
Mode	802.11g (6Mbps)		
Channel / Frequency (MHz)	1 (2412)	6 (2437)	11 (2462)
Average power	12.25	15.84	12.68
Mode	802.11n (HT20) (MCS0)		
Channel / Frequency (MHz)	1 (2412)	6 (2437)	11 (2462)
Average power	12.80	15.90	12.99
Mode	802.11n (HT40) (MCS0)		
Channel / Frequency (MHz)	3 (2422)	6 (2437)	9 (2452)
Average power	11.34	14.18	11.80

<WLAN 5.2G>

Mode	802.11a (6Mbps)		
Channel / Frequency (MHz)	36 (5180)	40 (5200)	48 (5240)
Average power	16.50	16.58	16.19
Mode	802.11n (HT20) (MCS0)		
Channel / Frequency (MHz)	36 (5180)	40 (5200)	48 (5240)
Average power	15.34	15.42	15.48
Mode	802.11n (HT40) (MCS0)		
Channel / Frequency (MHz)	38 (5190)		46 (5230)
Average power	14.52		14.78

<WLAN 5.8G>

Mode	802.11a (6Mbps)		
Channel / Frequency (MHz)	149 (5745)	157 (5785)	165 (5825)
Average power	16.60	16.51	16.93
Mode	802.11n (HT20) (MCS0)		
Channel / Frequency (MHz)	149 (5745)	157 (5785)	165 (5825)
Average power	16.75	16.35	16.45
Mode	802.11n (HT40) (MCS0)		
Channel / Frequency (MHz)	151 (5755)		159 (5795)
Average power	16.09		16.10

<Bluetooth>

Mode	Bluetooth GFSK (DH5)		
Channel / Frequency (MHz)	0 (2402)	39 (2440)	78 (2480)
Average Power	4.05	3.78	3.96
Mode	Bluetooth 8-DPSK (3DH5)		
Channel / Frequency (MHz)	0 (2402)	39 (2440)	78 (2480)
Average Power	4.29	3.99	4.16
Mode	Bluetooth LE (1Mbps)		
Channel / Frequency (MHz)	0 (2402)	19 (2440)	39 (2480)
Average Power	3.53	3.26	3.57

All combinations have been tested, the Worst Average Power (Unit: dBm) is shown as below.

<SDR-2.4G>

Mode	1.4MHz Bandwidth		
Channel / Frequency (MHz)	Low (2407.5)	Mid (2435.5)	High (2465.5)
Average Power	24.16	24.34	24.03
Mode	1.4MHz Bandwidth (CA Mode)		
Channel / Frequency (MHz)	Low (2409.5)	Mid (2437.5)	High (2467.5)
Average Power	24.12	24.27	24.06
Mode	3MHz Bandwidth		
Channel / Frequency (MHz)	Low (2417.5)	Mid (2435.5)	High (2456.5)
Average Power	24.15	24.24	24.20
Mode	10MHz Bandwidth		
Channel / Frequency (MHz)	Low (2405.5)	Mid (2440.5)	High (2476.5)
Average Power	14.22	14.04	14.34
Mode	20MHz Bandwidth		
Channel / Frequency (MHz)	Low (2410.5)	Mid (2441.5)	High (2472.5)
Average Power	14.12	14.44	14.18

<SDR-5.8G>

Mode	1.4MHz Bandwidth		
Channel / Frequency (MHz)	Low (5728.5)	Mid (5784.5)	High (5844.5)
Average Power	24.04	23.74	24.29
Mode	1.4MHz Bandwidth (CA Mode)		
Channel / Frequency (MHz)	Low (5730.12)	Mid (5786.12)	High (5846.12)
Average Power	24.19	24.01	24.25
Mode	3MHz Bandwidth		
Channel / Frequency (MHz)	Low (5730.5)	Mid (5784.5)	High (5844.5)
Average Power	24.33	24.23	24.40
Mode	10MHz Bandwidth		
Channel / Frequency (MHz)	Low (5732.5)	Mid (5788.5)	High (5844.5)
Average Power	14.08	13.95	14.20
Mode	20MHz Bandwidth		
Channel / Frequency (MHz)	Low (5735.5)	Mid (5787.5)	High (5839.5)
Average Power	13.99	13.85	14.14

8.3. SAR Testing Results

8.3.1. SAR Test Reduction Considerations

<KDB 447498 D01, General RF Exposure Guidance>

Testing of other required channels within the operating mode of a frequency band is not required when the reported SAR for the mid-band or highest output power channel is:

- (1) ≤ 0.8 W/kg or 2.0 W/kg, for 1-g or 10-g respectively, when the transmission band is ≤ 100 MHz
- (2) ≤ 0.6 W/kg or 1.5 W/kg, for 1-g or 10-g respectively, when the transmission band is between 100 MHz and 200 MHz
- (3) ≤ 0.4 W/kg or 1.0 W/kg, for 1-g or 10-g respectively, when the transmission band is ≥ 200 MHz

<KDB 248227 D01, SAR Guidance for Wi-Fi Transmitters>

- (1) For handsets operating next to ear, hotspot mode or mini-tablet configurations, the initial test position procedures were applied. The test position with the highest extrapolated peak SAR will be used as the initial test position. When the reported SAR of initial test position is ≤ 0.4 W/kg, SAR testing for remaining test positions is not required. Otherwise, SAR is evaluated at the subsequent highest peak SAR positions until the reported SAR result is ≤ 0.8 W/kg or all test positions are measured.
- (2) For WLAN 2.4 GHz, the highest measured maximum output power channel for DSSS was selected for SAR measurement. When the reported SAR is ≤ 0.8 W/kg, no further SAR testing is required. Otherwise, SAR is evaluated at the next highest measured output power channel. When any reported SAR is > 1.2 W/kg, SAR is required for the third channel. For OFDM modes (802.11g/n), SAR is not required when the highest reported SAR for DSSS is adjusted by the ratio of OFDM to DSSS specified maximum output power and it is ≤ 1.2 W/kg.
- (3) For WLAN 5 GHz, the initial test configuration was selected according to the transmission mode with the highest maximum output power. When the reported SAR of initial test configuration is > 0.8 W/kg, SAR is required for the subsequent highest measured output power channel until the reported SAR result is ≤ 1.2 W/kg or all required channels are measured. For other transmission modes, SAR is not required when the highest reported SAR for initial test configuration is adjusted by the ratio of subsequent test configuration to initial test configuration specified maximum output power and it is ≤ 1.2 W/kg.

8.3.2.SAR Results for Body Exposure Condition (Separation Distance is 0.5 cm Gap)

Plot No.	Band	Mode	Test Position	Ch.	Fre.	Max. Tune-up Power (dBm)	Measured Conducted Power (dBm)	Scaling Factor	Normal Duty Cycle (%)	Power Drift (dB)	Measured SAR-1g (W/kg)	Scaled SAR-1g (W/kg)
	802.11b	-	Front Face	6	2437	16	15.89	1.03	-	0.06	0.158	0.16
	802.11b	-	Rear Face	6	2437	16	15.89	1.03	-	0.02	0.034	0.03
1	802.11b	-	Bottom Side	6	2437	16	15.89	1.03	-	-0.06	0.435	0.45
	802.11a	-	Front Face	40	5200	17	16.58	1.10	-	0.08	0.125	0.14
	802.11a	-	Rear Face	40	5200	17	16.58	1.10	-	0.02	0.326	0.36
2	802.11a	-	Bottom Side	40	5200	17	16.58	1.10	-	-0.07	0.375	0.41
	802.11a	-	Front Face	165	5825	17.5	16.93	1.14	-	0.08	0.146	0.17
	802.11a	-	Rear Face	165	5825	17.5	16.93	1.14	-	-0.06	0.169	0.19
3	802.11a	-	Bottom Side	165	5825	17.5	16.93	1.14	-	-0.05	0.262	0.30
	SDR 2.4G	3M	Front Face	Mid	2435.5	24.5	24.24	1.06	10.80%	0.05	0.499	0.06
	SDR 2.4G	3M	Rear Face	Mid	2435.5	24.5	24.25	1.06	10.80%	0.06	0.151	0.02
4	SDR 2.4G	3M	Top Side	Mid	2435.5	24.5	24.25	1.06	10.80%	-0.02	1.15	0.13
	SDR 5.8G	3M	Front Face	High	5844.5	24.5	24.4	1.02	10.80%	0.03	0.283	0.03
	SDR 5.8G	3M	Rear Face	High	5844.5	24.5	24.4	1.02	10.80%	0.02	0.152	0.02
	SDR 5.8G	3M	Top Side	High	5844.5	24.5	24.4	1.02	10.80%	-0.09	10.3	1.14
5	SDR 5.8G	3M	Top Side	Low	5730.5	24.5	24.33	1.04	10.80%	-0.07	10.4	1.17
	SDR 5.8G	3M	Top Side	Mid	5784.5	24.5	24.23	1.06	10.80%	-0.01	9.61	1.10
	SDR 5.8G	3M	Top Side	Low	5730.5	24.5	24.33	1.04	10.80%	-0.01	10.1	1.13
	BT	3DH5	Front Face	0	2402	4.5	4.29	1.05	-	0.08	0.00944	0.01
	BT	3DH5	Rear Face	0	2402	4.5	4.29	1.05	-	0.02	0.00203	0.00
6	BT	3DH5	Bottom Side	0	2402	4.5	4.29	1.05	-	-0.01	0.026	0.03

8.3.3.SAR Results for Extremity Exposure Condition (Separation Distance is 0 cm Gap)

Plot No.	Band	Mode	Test Position	Ch.	Fre.	Max. Tune-up Power (dBm)	Measured Conducted Power (dBm)	Scaling Factor	Normal Duty Cycle (%)	Power Drift (dB)	Measured SAR-10g (W/kg)	Scaled SAR-10g (W/kg)
7	802.11b	-	Bottom Side	6	2437	16.0	15.89	1.03	-	-0.03	0.398	0.41
8	802.11a	-	Bottom Side	40	5200	17.0	16.58	1.10	-	-0.01	0.242	0.27
9	802.11a	-	Bottom Side	165	5825	17.5	16.93	1.14	-	-0.04	0.146	0.17
10	SDR 2.4G	3M	Top Side	Mid	2435.5	24.5	24.25	1.06	10.80%	-0.07	1.02	0.12
11	SDR 5.8G	3M	Top Side	Low	5730.5	24.5	24.33	1.04	10.80%	-0.03	5.35	0.60
12	BT	DH5	Bottom Side	0	2402	4.5	4.29	1.05	-	0.15	0.016	0.02

Note 1: As declared by the manufacturer, the permitted maximum duty cycle for SDR mode will not be higher than 10.8% when in end use, and reported SAR values listed above corrected the duty cycle factor accordingly.

Note 2: An initial test configuration is selected for each antenna port based on the highest maximum output power specified for production units and according to channel bandwidth, modulation and data rate combinations in each standalone and aggregated frequency band.

SAR Measurement Variability

According to KDB 865664 D01, SAR measurement variability was assessed for each frequency band, which is determined by the SAR probe calibration point and tissue-equivalent medium used for the device measurements. When both head and body tissue-equivalent media are required for SAR measurements in a frequency band, the variability measurement procedures should be applied to the tissue medium with the highest measured SAR, using the highest measured SAR configuration for that tissue-equivalent medium. Alternatively, if the highest measured SAR for both head and body tissue-equivalent media are ≤ 1.45 W/kg and the ratio of these highest SAR values, i.e., largest divided by smallest value, is ≤ 1.10 , the highest SAR configuration for either head or body tissue-equivalent medium may be used to perform the repeated measurement. These additional measurements are repeated after the completion of all measurements requiring the same head or body tissue-equivalent medium in a frequency band. The test device should be returned to ambient conditions (normal room temperature) with the battery fully charged before it is re-mounted on the device holder for the repeated measurement(s) to minimize any unexpected variations in the repeated results.

SAR repeated measurement procedure:

1. When the highest measured SAR is < 0.80 W/kg, repeated measurement is not required.
2. When the highest measured SAR is ≥ 0.80 W/kg, repeat that measurement once.
3. If the ratio of largest to smallest SAR for the original and first repeated measurements is > 1.20 , or when the original or repeated measurement is ≥ 1.45 W/kg, perform a second repeated measurement.
4. If the ratio of largest to smallest SAR for the original, first and second repeated measurements is > 1.20 , and the original, first or second repeated measurement is ≥ 1.5 W/kg, perform a third repeated measurement.

Band	Test Position	Ch.	Original Measured SAR-1g (W/kg)	1st Repeated SAR-1g (W/kg)	L/S Ratio	2nd Repeated SAR-1g (W/kg)	L/S Ratio	3rd Repeated SAR-1g (W/kg)	L/S Ratio
SDR 5.8GHz	Top Side	Low	10.4	10.1	1.03	N/A	N/A	N/A	N/A

8.3.4. Simultaneous Multi-band Transmission Evaluation
<SAR Summation Analysis>

Simultaneous transmission SAR test exclusion is determined for each operating configuration and exposure condition according to the reported standalone SAR of each applicable simultaneous transmitting antenna. When the sum of SAR_{1g} of all simultaneously transmitting antennas in an operating mode and exposure condition combination is within the SAR limit (SAR_{1g} 1.6 W/kg), the simultaneous transmission SAR is not required. When the sum of SAR_{1g} is greater than the SAR limit (SAR_{1g} 1.6 W/kg), SAR test exclusion is determined by the SPLSR.

Worst-Case as below:

No.	Conditions (SAR1 + SAR2)	Exposure Condition	Test Position	Max. SAR1	Max. SAR2	Max. SAR3	SAR Summation	SPLSR Analysis
1	SDR 2.4GHz + WLAN (NII) + Bluetooth	Body (1-g SAR, W/kg)	Front Face	0.06	0.17	0.01	0.24	∑ SAR < 1.6, Not required
			Rear Face	0.02	0.36	0.002	0.382	∑ SAR < 1.6, Not required
			Top Side	0.13	/	/	0.13	∑ SAR < 1.6, Not required
			Bottom Side	/	0.41	0.03	0.44	∑ SAR < 1.6, Not required
		Extremity(10-g SAR, W/kg)	Top Side	0.12	/	/	0.12	∑ SAR < 4.0, Not required
			Bottom Side	/	0.27	0.02	0.29	∑ SAR < 4.0, Not required
2	SDR 5.8GHz + WLAN (DTS) + Bluetooth	Body (1-g SAR, W/kg)	Front Face	0.03	0.16	0.01	0.20	∑ SAR < 1.6, Not required
			Rear Face	0.02	0.03	0.002	0.052	∑ SAR < 1.6, Not required
			Top Side	1.17	/	/	1.17	∑ SAR < 1.6, Not required
			Bottom Side	/	0.45	0.03	0.48	∑ SAR < 1.6, Not required
		Extremity(10-g SAR, W/kg)	Top Side	0.60	/	/	0.60	∑ SAR < 4.0, Not required
			Bottom Side	/	0.41	0.02	0.43	∑ SAR < 4.0, Not required

Test Engineer: Warren Xiong

Appendixes

All attachments are integral parts of this test report. This applies especially to the following appendix:

Appendix A: SAR Plots of System Verification

The plots for system verification with largest deviation for each SAR system combination are shown as follows.

Appendix B: SAR Plots of SAR Measurement

The SAR plots for highest measured SAR in each exposure configuration, wireless mode and frequency band combination, and measured SAR > 1.5 W/kg are shown as follows.

Appendix C: Calibration Certificate for probe and Dipole

Appendix D: Photographs of EUT and setup