

# AGRAS T20

## Quick Start Guide

v1.0

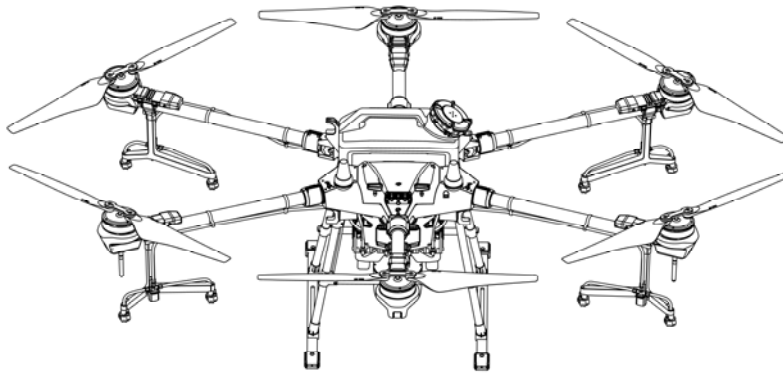

## Aircraft

The AGRAS™ T20 features a brand-new design including a foldable frame and a quick-release spray tank and flight battery, making replacement, installation, and storage easy. The stable and reliable modular aerial-electronics system is integrated with a dedicated industrial flight controller, OCUSYNC™ 2.0 HD transmission system, and RTK module. It has dual IMUs and barometers and adopts a propulsion control system redundancy design including both digital and analog signals to ensure flight safety.

The GNSS+RTK dual-redundancy system is compatible with GPS, GLONASS, BeiDou, and Galileo. The T20 also supports centimeter-level positioning\* when used with the onboard D-RTK™. Dual-antenna technology provides strong resistance against magnetic interference.

The upgraded spraying system features an improvement in payload. It also has a 4-channel electromagnetic flow meter to ensure consistent spraying for all sprinklers.

The new-generation omnidirectional digital radar provides functions such as terrain following and obstacle sensing and circumventing in all horizontal directions. The aircraft is equipped with a wide-angle FPV camera that enables users to observe the landscape from the front of the aircraft.

The aircraft has a backup power system, which supplies power to the aircraft for approximately 20 seconds when the Intelligent Flight Battery is powered off due to malfunction during flight. This allows the aircraft to avoid accident and land safely.

Due to its industrial design and material, the T20 is dustproof, waterproof, and corrosion-resistant. The aircraft has a protection rating of IPX6 (IEC standard 60529), while the protection rating of the aerial-electronics system, spray control system, propulsion ESC system, and radar module is up to IP67.

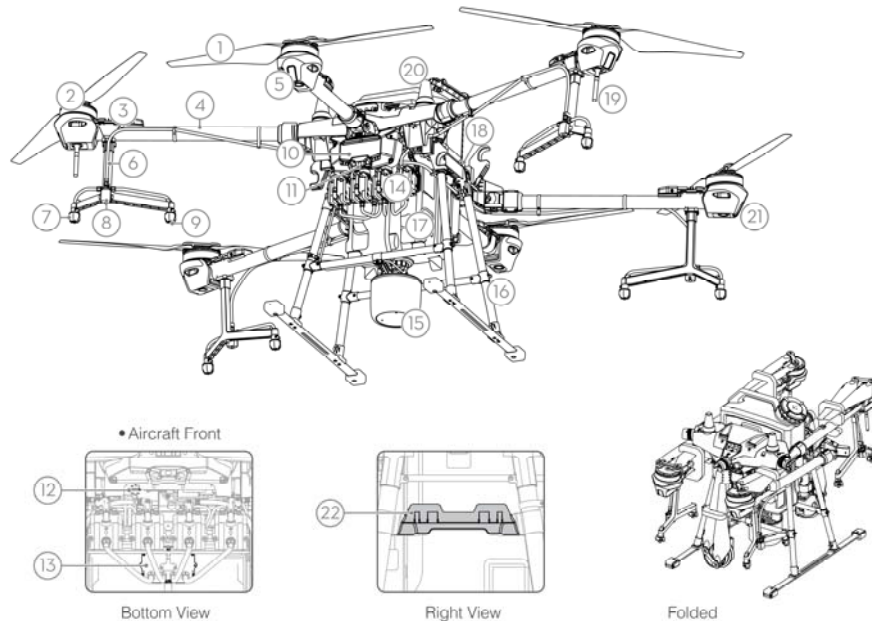

- |  |   |  |
|--|---|--|
| <ul style="list-style-type: none"> <li>1. Propellers</li> <li>2. Motors</li> <li>3. ESCs</li> <li>4. Frame Arms</li> <li>5. Aircraft Front Indicators (on the three front arms)</li> <li>6. Hoses</li> <li>7. Sprinklers</li> <li>8. Electromagnetic Exhaust Valves</li> </ul> | <ul style="list-style-type: none"> <li>9. Nozzles</li> <li>10. Aerial-Electronics System</li> <li>11. FPV Camera</li> <li>12. USB-C Port (on the bottom of the aerial-electronics system, under the waterproof cover)</li> <li>13. 4-Channel Electromagnetic Flow Meter</li> <li>14. Delivery Pumps</li> <li>15. Omnidirectional Digital Radar</li> </ul> | <ul style="list-style-type: none"> <li>16. Landing Gear</li> <li>17. Spray Tank</li> <li>18. Battery Compartment</li> <li>19. OcuSync Antennas</li> <li>20. Onboard D-RTK Antennas</li> <li>21. Aircraft Status Indicators (on the three rear arms)</li> <li>22. Remote Controller Holder</li> </ul> |
|--|---|--|

\* Must be used with a DJI D-RTK 2 High Precision GNSS Mobile Station (sold separately) or a DJI-approved Network RTK service.

## Remote Controller

The Smart Controller 2.0 uses the DJI™ OcuSync 2.0 transmission system, has a maximum control distance of up to 3 km\*, and supports Wi-Fi and Bluetooth functions. The remote controller is equipped with a 5.5-inch bright, dedicated screen that has the DJI Agras app built in, significantly improving smoothness and stability. When the RTK dongle is connected to the remote controller, users can plan operations to centimeter-level precision. The Multi-Aircraft Control mode of the remote controller can be used to coordinate the operation of up to five aircraft at the same time, enabling pilots to work efficiently. Both the built-in battery and external battery can be used to supply power to the remote controller. The total working time is up to 4 hours, which fully meets the requirements for long and high-intensity operations.

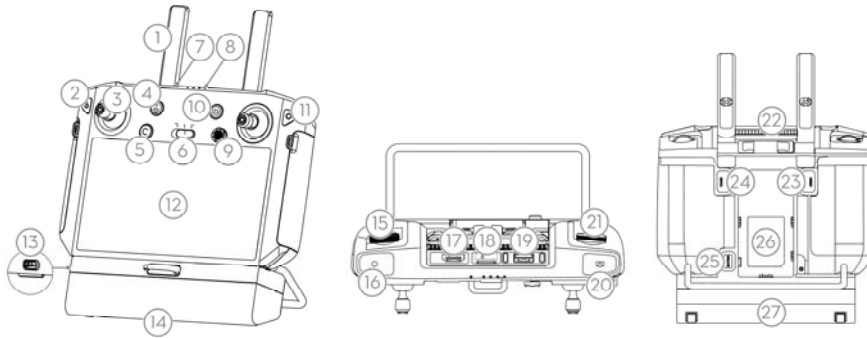

- |                                  |                              |                              |
|----------------------------------|------------------------------|------------------------------|
| 1. Antennas                      | 10. Power Button             | 19. USB-A Port               |
| 2. Back Button / Function Button | 11. Confirm Button           | 20. FPV / Map Switch Button  |
| 3. Control Sticks                | 12. Touch Screen             | 21. Work Efficiency Dial     |
| 4. RTH Button                    | 13. USB-C Charging Port      | 22. Air Outlet               |
| 5. Button C3 (customizable)      | 14. Dongle Compartment Cover | 23. Button C1 (customizable) |
| 6. Flight Mode Switch            | 15. Spray Rate Dial          | 24. Button C2 (customizable) |
| 7. Status LED                    | 16. Spray Button             | 25. Battery Release Button   |
| 8. Battery Level LEDs            | 17. HDMI Port                | 26. Battery Compartment      |
| 9. 5D Button (customizable)      | 18. microSD Card Slot        | 27. Handle                   |

The figure below shows the function that each control stick movement performs, using Mode 1 as an example. In Mode 1, the left stick controls the aircraft's forward and backward movements and heading while the right stick controls its altitude and left and right movements.

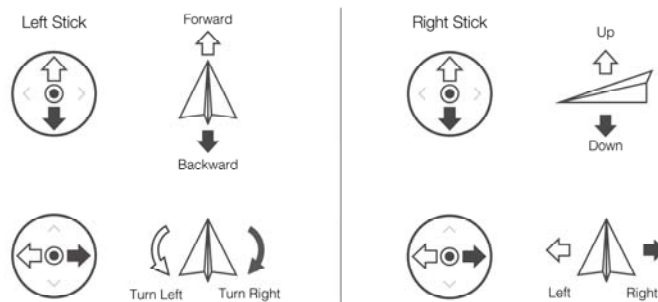

\* The remote controller is able to reach its maximum transmission distance (FCC / NCC: 5 km (3.11 mi); CE / KCC / MIC / SRRC: 3 km (1.86 mi)) in an open area with no electromagnetic interference, and at an altitude of approximately 2.5 m (8.2 ft).

## Fly Safe

It is important to understand some basic flight guidelines, both for your protection and for the safety of those around you.

1. Flying in Open Areas: Pay attention to utility poles, power lines, and other obstacles. DO NOT fly near or above water, people, or animals.
2. Maintain Control at All Times: Keep your hands on the remote controller and maintain control of your aircraft when it is in flight, even when using intelligent functions such as the Route and A-B Route operation modes and Smart Return to Home.
3. Maintain Line of Sight: Maintain visual line of sight (VLOS) with your aircraft at all times and avoid flying behind buildings or other obstacles that may block your view.
4. Monitor Your Altitude: For the safety of manned aircraft and other air traffic, fly at altitudes lower than 30 m (98 ft) and in accordance with all local laws and regulations.



Visit <https://www.dji.com/flysafe> for more information on critical safety features such as GEO zones.

## Flying Considerations

1. DO NOT use the aircraft to spray in winds exceeding 18 kph (11 mph).
2. DO NOT use the aircraft in adverse weather conditions such as winds exceeding 28 kph (17 mph), heavy rain (precipitation rate exceeding 25 mm (0.98 in) in 12 hours), snow, or fog.
3. The recommended maximum operating altitude is 2 km (6,560 ft) above sea level. DO NOT fly over 3 km (9,842 ft) above sea level.
4. Once the operating altitude reaches 1 km (3,280 ft), the payload capacity of the spray tank is reduced by 2 kg. For every additional km, the payload capacity will reduce by a further 2 kg.
5. Make sure that there is a strong GNSS signal and the D-RTK antennas are unobstructed during operation.

## Return to Home (RTH)

The aircraft will automatically return to the Home Point in the following situations:

Smart RTH: You press the RTH button.

Failsafe RTH: The remote controller signal is lost.\*

If there is an obstacle within 20 m of the aircraft, the aircraft decelerates and then stops and hovers. If the aircraft comes within 6 m of the obstacle while decelerating, the aircraft stops, flies backward to a distance of approximately 6 m from the obstacle, and hovers. The aircraft exits the RTH procedure and waits for further commands.



\* If Failsafe RTH is disabled (the default setting in the DJI Agras app), the aircraft hovers in place when the remote controller signal is lost.



• Obstacle avoidance is disabled in Attitude mode (which the aircraft enters in situations such as when the GNSS signal is weak) and is not available if the operating environment is not suitable for the radar module. Extra caution is required in such situations.

## Pesticide Usage

1. Avoid the use of powder pesticides as much as possible as they may reduce the service life of the spraying system.
2. Pesticides are poisonous and pose serious risks to safety. Only use them in strict accordance with their specifications.
3. Use clean water to mix the pesticide and filter the mixed liquid before pouring into the spray tank to avoid blocking the strainer.
4. Effective use of pesticides depends on pesticide density, spray rate, spray distance, aircraft speed, wind speed, and wind direction. Consider all factors when using pesticides.
5. DO NOT compromise the safety of people, animals, or the environment during operation.



It is important to understand some basic flight guidelines, both for your protection and for the safety of those around you.

Make sure to read the disclaimer and safety guidelines.

## Specifications

• <b>Product Model</b>	3WWDZ-15.1B
• <b>Airframe</b>	
Max Diagonal Wheelbase	1883 mm
Dimensions	2509×2213×732 mm (Arms and propellers unfolded) 1795×1510×732 mm (Arms unfolded and propellers folded) 1100×570×732 mm (Arms and propellers folded)
• <b>Propulsion System</b>	
<b>Motors</b>	
Stator Size	100×15 mm
KV	75 rpm/V
Max Thrust	13.5 kg/rotor
Max Power	2400 W/rotor
Weight	666 g
<b>ESCs</b>	
Max Working Current (Continuous)	40 A
Max Working Voltage	58.8 V (14S LiPo)
<b>Foldable Propellers (R3390)</b>	
Diameter × Pitch	33×9 in
Weight (Single propeller)	90 g
• <b>Spraying System</b>	
<b>Spray Tank</b>	
Volume	Rated: 15.1 L, Full: 16 L
Operating Payload	Rated: 15.1 kg, Full: 16 kg
<b>Nozzles</b>	
Model	XR11001VS (Standard); XR110015VS, XR11002VS (Optional, purchase separately)
Quantity	8
Max Spray Rate	XR11001VS: 3.6 L/min, XR110015VS: 4.8 L/min, XR11002VS: 6 L/min
Spray Width	4 - 7 m (8 nozzles, at a height of 1.5 - 3 m above crops)
Droplet Size	XR11001VS: 130 - 250 μm, XR110015VS: 170 - 265 μm, XR11002VS: 190 - 300 μm (Subject to operating environment and spray rate)
<b>Flow Meter</b>	
Measurement Range	0.25 - 20 L/min
Error	< ±2%
Measurable Liquid	Conductivity > 50 μS/cm (Liquids such as tap water or pesticides that contain water)
• <b>Omnidirectional Digital Radar</b>	
Model	RD2428R
Operating Frequency	24150MHz
Transmitter Power (EIRP)	/
Power Consumption	18 W
Altitude Detection & Terrain Follow <sup>[1]</sup>	Altitude detection range: 1 - 30 m Stabilization working range: 1.5 - 15 m Max slope in Mountain mode: 35°
Obstacle Avoidance System <sup>[1]</sup>	Obstacle sensing range: 1.5 - 30 m FOV: Horizontal: 360°, Vertical: ±15° Working conditions: Flying higher than 1.5 m over the surface below at a speed lower than 7 m/s Safety distance: 2.5 m (Distance between the front of propellers and the obstacle after braking) Obstacle avoidance direction: Omnidirectional obstacle avoidance in the horizontal direction
IP Rating	IP67
• <b>FPV Camera</b>	
FOV	Horizontal: 98°, Vertical: 78°
Resolution	1280×960 30fps

FPV Spotlight	FOV: 110°, Max brightness: 12 lux at 5 m of direct light
<b>• Flight Parameters</b>	
OcuSync 2.0 Operating Frequency <sup>[2]</sup>	2.4000 - 2.4835 GHz 5.725 - 5.850 GHz
OcuSync 2.0 Transmitter	2.4 GHz 5.8 GHz SRRC / FCC: 25.5 dBm
Total Weight (Excluding battery)	21.1 kg
Standard Takeoff Weight	44.6 kg
Max Takeoff Weight	45.5 kg (At sea level)
Max Thrust-Weight Ratio	1.78 (Takeoff weight of 45.5 kg)
Hovering Accuracy Range (With strong GNSS signal)	D-RTK enabled: Horizontal: ±10 cm, Vertical: ±10 cm D-RTK disabled: Horizontal: ±0.6 m, Vertical: ±0.3 m (Radar module enabled: ±0.1 m)
RTK / GNSS Operating Frequency	RTK: GPS L1/L2, GLONASS F1/F2, BeiDou B1/B2, Galileo E1/E5 <sup>[3]</sup> GNSS: GPS L1, GLONASS F1, Galileo E1 <sup>[3]</sup>
Battery	DJI-approved flight battery (AB3-18000mAh-51.8V)
Max Power Consumption	8000 W
Hovering Power Consumption	6000 W (Takeoff weight of 45.5 kg)
Hovering Time <sup>[4]</sup>	16 min (Takeoff weight of 29.5 kg with an 18000 mAh battery) 8.5 min (Takeoff weight of 45.5 kg with an 18000 mAh battery)
Max Tilt Angle	15°
Max Operating Speed	7 m/s
Max Flying Speed	10 m/s (With a strong GNSS signal)
Max Wind Resistance	8 m/s
Max Service Ceiling Above Sea Level	2000 m
Recommended Operating Temperature	0° to 40° C (32° to 104° F)
<b>• Remote Controller</b>	
Model	RM500-AG
Screen	5.5-inch screen, 1920×1080, 1000 cd/m <sup>2</sup> , Android system
RAM	4 GB LPDDR4
ROM	32 GB + scalable storage; microSD cards supported; Max Capacity: 128 GB. UHS-I Speed Grade 3 rating required
Built-in Battery	18650 Li-ion (5000 mAh @ 7.2 V)
GNSS	GPS+GLONASS
Power Consumption	18 W
Operating Temperature	-10° to 40° C (14° to 104° F)
Charging Temperature	5° to 40° C (40° to 104° F)
Storage Temperature	-30° to 25° C (-22° to 77° F)
OcuSync 2.0 Operating Frequency <sup>[2]</sup>	2.4000 - 2.4835 GHz 5.725 - 5.850 GHz
Max Transmission Distance	SRRC / MIC / KCC / CE: 3 km, FCC: 5 km (Unobstructed, free of interference)
Transmitter Power (EIRP)	2.4 GHz SRRC / CE / MIC / KCC: 18.5 dBm, FCC: 25.5 dBm 5.8 GHz SRRC / FCC: 25.5 dBm

<b>Wi-Fi</b>	
Protocol	Wi-Fi Direct, Wi-Fi Display, 802.11a/g/n/ac Wi-Fi with 2x2 MIMO is supported
Operating Frequency <sup>[2]</sup>	2.4000 - 2.4835 GHz 5.150 - 5.250 GHz 5.725 - 5.850 GHz
Transmitter Power (EIRP)	2.4 GHz SRRC / CE: 18.5 dBm, FCC / MIC / KCC: 20.5 dBm 5.2 GHz SRRC / FCC / CE / MIC: 14 dBm, KCC: 10 dBm 5.8 GHz SRRC / FCC: 18 dBm, CE / KCC: 12 dBm

<b>Bluetooth</b>	
Protocol	Bluetooth 4.2
Operating Frequency	2.4000 - 2.4835 GHz
Transmitter Power (EIRP)	SRRC / FCC / CE / MIC / KCC: 6.5 dBm

• **Remote Controller Intelligent Battery**

Model	WB37-4920mAh-7.6V
Battery Type	2S LiPo
Capacity	4920 mAh
Voltage	7.6 V
Energy	37.39 Wh
Charging Temperature	5° to 40° C (40° to 104° F)

• **Intelligent Battery Charging Hub**

Model	WCH2
Input Voltage	17.3 - 26.2 V
Output Voltage and Current	8.7 V, 6 A
Operating Temperature	5° to 40° C (40° to 104° F)

• **AC Power Adapter**

Model	A14-057N1A
Input Voltage	100 - 240 V, 50/60 Hz
Output Voltage	17.4 V
Rated Power	57 W

[1] The effective radar range varies depending on the material, position, shape, and other properties of the obstacle.

[2] Local regulations in some countries prohibit the use of the 5.8 GHz and 5.2 GHz frequencies. In some countries, the 5.2 GHz frequency band is only allowed for indoor use.

[3] Support for Galileo will be available at a later date.

[4] Hovering time acquired at sea level with wind speeds lower than 3 m/s.

Download the Agras T20 User Manual for more information:

<http://www.dji.com/t20>

※ The content is subject to change without prior notice.

AGRAS and © are trademarks of DJI.

Copyright © 2019 DJI All Rights Reserved.

Printed in China.

## Using the T20

### 1. Preparing the Intelligent Flight Battery

Only use official DJI flight batteries (model: AB3-18000mAh-51.8V). Check the battery level before flying, and charge it according to the corresponding document.

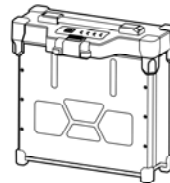

### 2. Preparing the Aircraft

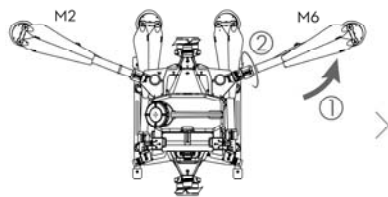

Unfold the M2 and M6 arms, and tighten the two arm sleeves.

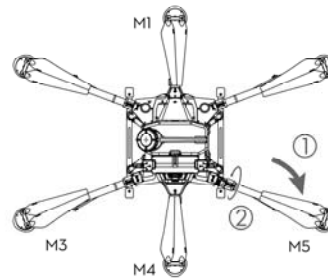

Unfold the M3 and M5 arms followed by M1 and M4, and then tighten the four arm sleeves.

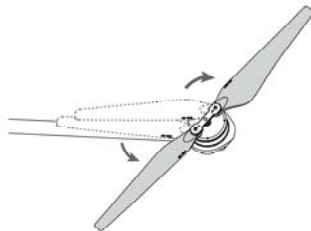

Unfold the propeller blades.

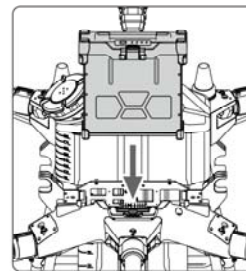

Insert the Intelligent Flight Battery into the aircraft until you hear a click.



- Before using the aircraft, make sure to mount the backup battery. Otherwise, the aircraft cannot take off. Mount and use the backup battery in strict accordance with the Agravs T20 Backup Battery User Guide.
- Make sure that the battery is firmly inserted into the aircraft. Only insert or remove the battery when the aircraft is powered off.
- To remove the battery, press and hold the clamp, and then lift the battery up.
- When folding the arms, make sure to fold the M3 and M5 arms first, and then the M2 and M6 arms. Otherwise, the arms may be damaged. Lift and lower the M1 and M4 arms gently to reduce wear and tear.



### 3. Preparing the Remote Controller

#### Charging the Batteries

Charge the external Intelligent Battery using the charging hub and AC power adapter. Charge the internal battery of the remote controller using the USB charger and USB-C cable. Fully charge the batteries before using for the first time.

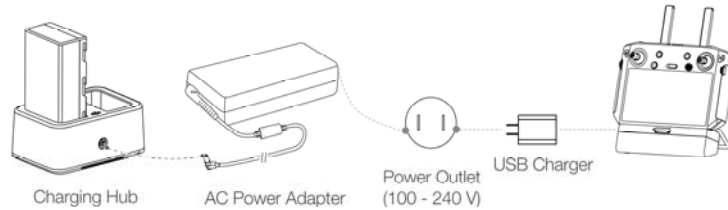

#### Mounting the External Battery

- ① Press and hold the battery release button.
- ② Insert the Intelligent Battery into the battery compartment. Make sure the bottom of the battery is aligned to the marking line in the compartment.
- ③ Push the battery to the bottom.

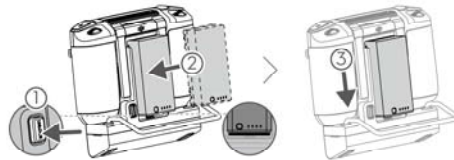

• To remove the Intelligent Battery, press and hold the battery release button, then push the battery upward.

#### Mounting the 4G Dongle and SIM Card

- ⚠ • Only use a DJI-approved dongle. The dongle supports various network standards. Use a SIM card that is compatible with the chosen mobile network provider, and select a mobile data plan according to the planned level of usage.
- The dongle and SIM card enable the remote controller to access specific networks and platforms, such as the DJI AG platform. Make sure to employ them correctly. Otherwise, network access will not be available.

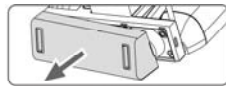

Remove the dongle compartment cover.

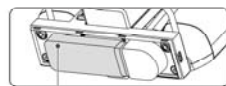

Insert the dongle into the USB port with the SIM card inserted into the dongle, and test the dongle.\*

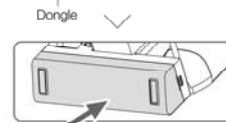

Reattach the cover firmly.

\* Test procedure: Press the remote controller power button once, then press again and hold to power the remote controller on. In DJI Agras, tap , and select Network Diagnostics. The dongle and SIM card are functioning properly if the status of all the devices in the network chain are shown in green.

#### Mounting the RTK Dongle

When using the RTK planning method to plan the operation area, attach the RTK dongle to the USB-A port on the remote controller.

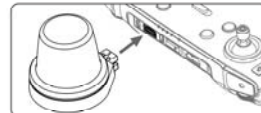

## Checking the Battery Levels

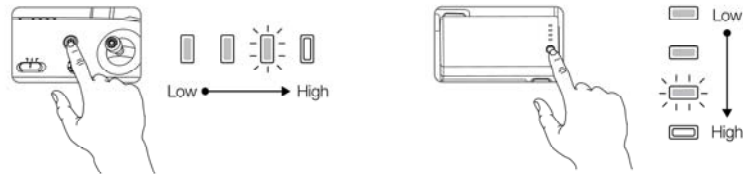

Press the power button on the remote controller once to check the internal battery level. Press once, then press again and hold for two seconds to power on or off.

Press the battery level button on the external Intelligent Battery once to check the battery level.

- ⚠ • When using an external Intelligent Battery, it is still necessary to make sure that the internal battery has some power. Otherwise, the remote controller cannot be powered on.

## Adjusting the Antennas

Lift the antennas and adjust them. The strength of the remote controller signal is affected by the position of the antennas. When the angle between the antennas and the back of the remote controller is  $80^\circ$  or  $180^\circ$ , the connection between the remote controller and aircraft can reach its optimal performance.

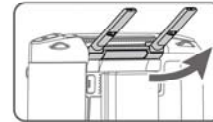

Try to keep the aircraft inside the optimal transmission zone. If the signal is weak, adjust the antennas or fly the aircraft closer.

Optimal Transmission Zone

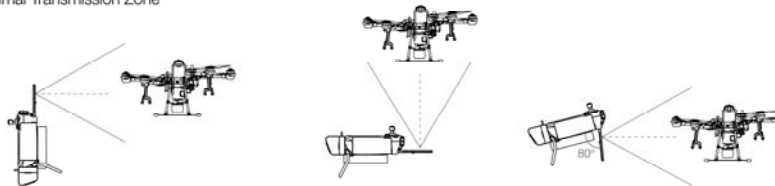

- ⚠ • Avoid using wireless devices that use the same frequency bands as the remote controller.
- If the RTK dongle is used for field planning, the module should be disconnected from the remote controller after planning is completed. Otherwise, it will affect the communication performance of the remote controller.

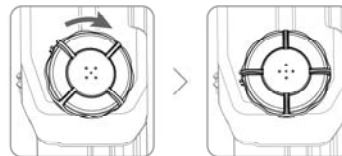

## 4. Getting Ready for Takeoff

- Place the aircraft on open, flat ground with the aircraft rear facing toward you.
- Make sure that the propellers are securely mounted, there are no foreign objects in or on the motors and propellers, the propeller blades and arms are unfolded, and the arm sleeves are firmly tightened.
- Make sure that the spray tank and flight battery are firmly in place.
- Pour liquid into the spray tank, and tighten the cover. Make sure that the four lines on the cover are aligned to the horizontal or vertical direction.
- Power on the remote controller, make sure that the DJI Agras app is open, and then power on the aircraft.



- 🌐 • When using for the first time, activate the aircraft using the DJI Agras app. Your DJI account and an internet connection are required.

### Calibrating the Compass

When the app prompts that compass calibration is required, tap , then , slide to the bottom, and select Advanced Settings, then Sensors. Tap Calibration in the compass calibration section, then follow the on-screen instructions.



- DO NOT calibrate your compass where there is a chance of strong magnetic interference. This includes areas where there are utility poles or walls with steel reinforcements.
- DO NOT carry ferromagnetic materials with you during calibration such as keys or mobile phones.



### Calibrating the Flow Meter

Make sure to calibrate the flow meter before your first operation. Otherwise, the spraying performance may be adversely affected.

A. Preparation before calibration: Discharging the bubbles in the hoses

- ① Fill the spray tank with approximately 2 L of water.
- ② Use the automatic bubbles discharge function to discharge the bubbles according to the descriptions in the Discharging the Bubbles in the Hoses section below. Users can also manually discharge the bubbles. Press the spray button to spray the bubbles and press the button again once all bubbles are discharged.

B. Flow Meter Calibration

- ① In the app, tap Execute Operation to enter Operation View. Tap , then , and tap Calibration on the right of the flow meter section.
- ② Calibration starts automatically. After 25 seconds, the result of the calibration is displayed in the app.
  - After calibrating successfully, users can proceed with the operation.
  - If calibration fails, tap "?" to view and resolve the problem. Afterward, recalibrate.

### Discharging the Bubbles in the Hoses

The T20 features an automatic bubbles discharge function. When it is necessary to discharge bubbles, press and hold the spray button for two seconds. The aircraft will discharge automatically until the bubbles are fully discharged.

---

## 5. Flight

In the app, go to Operation View. Make sure that there is a strong GNSS signal, and the system status bar indicates Manual Route (GNSS) or Manual Route (RTK).<sup>\*</sup> Otherwise, the aircraft cannot take off.

It is recommended to create a plan for a field and select an operation to enable the aircraft to take off and perform the operation automatically. Refer to the Starting Operations section for more information. In other cases, take off and land manually.

### Takeoff

Perform a Combination Stick Command (CSC) and push the throttle stick up to take off.



### Landing

To land, pull down on the throttle stick to descend until the aircraft touches the ground. There are two methods to stop the motors.

Method 1: When the aircraft has landed, push and hold the throttle stick down. The motors will stop after three seconds.

Method 2: When the aircraft has landed, push the throttle stick down, and perform the same CSC that was used to start the motors. Release both sticks once the motors have stopped.

<sup>\*</sup> RTK positioning is recommended. In the app, go to Operation View, tap , then RTK to enable Aircraft RTK, and select a method for receiving RTK signals.



- !**
- Spinning propellers can be dangerous. Stay away from spinning propellers and motors. DO NOT start the motors in confined spaces or when there are people nearby.
  - Keep your hands on the remote controller when the motors are spinning.
  - DO NOT stop the motors mid-flight unless in an emergency situation where doing so will reduce the risk of damage or injury.
  - Method 1 is the recommended method for stopping the motors. When using Method 2 to stop the motors, the aircraft may roll over if it is not completely grounded. Use Method 2 with caution.
  - After landing, power off the aircraft before turning off the remote controller.

## Starting Operations

After the operation area and obstacles have been measured and settings have been configured, DJI Agras uses a built-in intelligent operation planning system to produce a flight route based on the user's input. Users can invoke an operation after planning a field. The aircraft will begin the operation automatically and follow the planned flight route.

In scenarios with complicated terrain, users can use the PHANTOM™ 4 RTK and DJI TERRA™ to plan 3D flight routes, and then import the routes to the DJI Agras app for operation. Refer to the Agras T20 User Manual for more information.

## Field Planning

The DJI Agras app supports flight route planning by flying the aircraft to waypoints, obstacles, and calibration points or by walking to these points carrying a remote controller, a remote controller with an RTK dongle, or an RTK device. The following route has been planned by walking to the points with a remote controller that has a RTK dongle connected. Before planning, make sure that the RTK dongle is mounted to the remote controller.

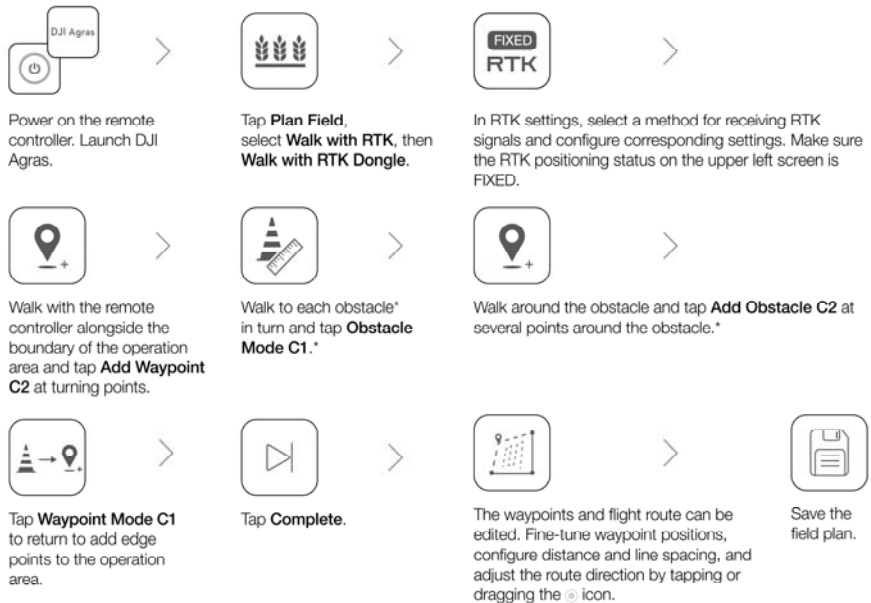

Once you have finished planning, tap in the upper left corner of the screen to return to the home screen.

\* If any obstacles are in the operation area.

- !**
- If planning without an RTK device or remote controller with an RTK dongle, calibration points should be added before planning is complete so that the offset can be rectified when invoking the operation.

## Performing an Operation



Tap **Execute Operation** in the home screen of the app.



Tap , select the field from the field list.



Tap **Edit** to edit the waypoints and flight route again.



Tap **Invoke**, and then tap **Start**.



Set the operation parameters, then confirm.



Set the auto-takeoff height and move the slider to take off. The aircraft will perform the operation automatically.



- If planning without an RTK device or remote controller with an RTK dongle, it is necessary to rectify the offset after invoking the operation. Take the aircraft to one of the calibration points, and then tap Rectify Offset.
- Only take off in open areas and set an appropriate auto-takeoff height according to the operating environment.
- An operation can be paused by moving the control stick slightly. The aircraft will hover and record the breakpoint, and then the aircraft can be controlled manually. To continue the operation, select it again from the Executing tag in  list, and the aircraft will return to the breakpoint automatically and resume the operation. Pay attention to aircraft safety when returning to a breakpoint.
- In Route Operation mode, the aircraft is able to circumvent obstacles, which is disabled by default and can be enabled in the app. If the function is enabled and the aircraft detects obstacles, the aircraft will slow down and circumvent the obstacles, and then return to the original flight path.
- Users can set the action the aircraft will perform after the operation is completed in the app.

---

## More Operation Modes

Refer to the Agras T20 User Manual for more information about the A-B Route, Manual, and Manual Plus Operation modes.

## More Functions



Operation Resumption



System Data Protection



Empty Tank

Refer to the Agras T20 User Manual for more information.

---

## 6. Maintenance

Clean all parts of the aircraft and remote controller daily and immediately after spraying:

1. Fill the spray tank with clean water or soapy water and spray the water through the nozzles until the tank is empty. Repeat the step two more times.
2. Detach the spray tank and spray tank connector to clean them. Remove the spray tank strainer, nozzle strainers, and nozzles to clean them and clear any blockage. Afterwards, immerse them in clean water for 12 hours.
3. Use a water-filled spray washer to clean the aircraft body and wipe it with a soft brush or wet cloth before cleaning water stains with a dry cloth.
4. If there is dust or pesticide liquid on the motors and propellers, wipe them with a wet cloth before cleaning water stains with a dry cloth.
5. Wipe the surface and screen of the remote controller with a clean wet cloth that has been wrung out with water daily after operations.

The backup battery is valid for one year after shipping and can only be used once. Once the backup battery is used or has expired, make sure to contact a DJI authorized dealer to purchase a new battery. Pay attention to the backup battery status notifications in the DJI Agras app.

Refer to the disclaimer and safety guidelines for more information on product maintenance.

# AGRAS T20



Facebook



YouTube

For the latest information on Agrab products,  
scan the Facebook or YouTube QR code.



3943124M001

#### FCC Compliance Notice(For plane)

This device complies with part 15 of the FCC Rules. Operation is subject to the following two conditions: (1) This device may not cause harmful interference, and (2) this device must accept any interference received, including interference that may cause undesired operation.

Any changes or modifications not expressly approved by the party responsible for compliance could void the user's authority to operate the equipment.

This equipment has been tested and found to comply with the limits for a Class digital device, pursuant to part of the FCC Rules. These limits are designed to provide reasonable protection against harmful interference in a residential installation. This equipment generates uses and can radiate radio frequency energy and, if not installed and used in accordance with the instructions, may cause harmful interference to radio communications. However, there is no guarantee that interference will not occur in a particular installation. If this equipment does cause harmful interference to radio or television reception, which can be determined by turning the equipment off and on, the user is encouraged to try to correct the interference by one or more of the following measures:

- Reorient or relocate the receiving antenna.
- Increase the separation between the equipment and receiver.
- Connect the equipment into an outlet on a circuit different from that to which the receiver is connected.
- Consult the dealer or an experienced radio/TV technician for help.d.

#### FCC Radiation Exposure Statement

This equipment complies with FCC radiation exposure limits set forth for an uncontrolled environment .

This transmitter must not be co-located or operating in conjunction with any other antenna or transmitter. This equipment should be installed and operated with minimum distance 20cm between the radiator& your body.

#### IC RSS warning

This device complies with ISEDC Rules. Operation is subject to the following two conditions: (1) This device may not cause harmful interference, and (2) this device must accept any interference received, including interference that may cause undesired operation.

Ce dispositif est conforme aux règles de l'ISEDC. L'opération est soumise aux deux conditions suivantes : (1) Cet appareil ne peut pas causer d'interférences nocives, et (2) cet appareil doit accepter toute interférence reçue, y compris toute interférence qui peut causer un fonctionnement indésirable.

#### IC Radiation Exposure Statement:

This equipment complies with IC RF radiation exposure limits set forth for an uncontrolled environment. This transmitter must not be co-located or operating in conjunction with any other antenna or transmitter.

Cet équipement est conforme aux limites d'exposition aux rayonnements RF IC définies pour un environnement non contrôlé. Cet émetteur ne doit pas être colocalisé ou fonctionner en conjonction avec une autre antenne ou un autre émetteur.Cet équipement doit être installé et a fonctionné avec une distance minimale de 20cm entre le radiateur et votre corps.

Any changes or modifications not expressly approved by the party responsible for compliance could void the user's authority to operate the equipment.

Tout changement ou modification non expressément approuvé par la partie responsable de conformité pourrait annuler l'autorisation de l'utilisateur d'exploiter l'équipement.

## **FCC/ISEDCC Compliance Notice**

This device complies with Part 15 of the FCC Rules and ISEDCC RSS standard. Operation is subject to the following two conditions:

- (1) This device may not cause harmful interference, and
- (2) This device must accept any interference received, including interference that may cause undesired operation.

Any changes or modifications not expressly approved by the party responsible for compliance could void the user's authority to operate the equipment.

Ce dispositif est conforme à la partie 15 des règles de la FCC et à la norme ISENC RSS. L'opération est soumise aux deux conditions suivantes :

- (1) Cet appareil ne doit pas causer d'interférences nuisibles, et
- (2) Cet appareil doit accepter toutes les interférences reçues, y compris celles susceptibles de provoquer un fonctionnement indésirable.

Tout changement ou modification non expressément approuvé par la partie responsable de la conformité peut annuler le droit de l'utilisateur à utiliser l'équipement.

This equipment has been tested and found to comply with the limits for a Class A digital device, pursuant to part 15 of the FCC Rules. These limits are designed to provide reasonable protection against harmful interference when the equipment is operated in a commercial environment. This equipment generates, uses and can radiate radio frequency energy and, if not installed and used in accordance with the instruction manual, may cause harmful interference to radio communications. Operation of this equipment in a residential area is likely to cause harmful interference in which case the user will be required to correct the interference at his own expense.

## **RF Exposure Information**

Aircraft and HIGH-PRECISION DBF IMAGING RADAR complies with FCC/ISEDCC radiation exposure limits set forth for an uncontrolled environment. In order to avoid the possibility of exceeding the FCC/ISEDCC radio frequency exposure limits, human proximity to the antenna shall not be less than 20cm during normal operation.

For Remote Controller (model:RM500-AG), SAR tests are conducted using standard operating positions accepted by the FCC/ISEDCC with the device transmitting at its highest certified power level in all tested frequency bands, although the SAR is determined at the highest certified power level, the actual SAR level of the device while operating can be well below the maximum value.

Before a new model is available for sale to the public, it must be tested and certified to the FCC/ISEDCC that it does not exceed the exposure limit established by the FCC/ISEDCC. Tests for each product are performed in positions and locations as required by the FCC/ISEDCC. For Handheld operation, this device has been tested and meets the FCC/ISEDCC RF exposure guidelines when used with an accessory designated for this product or when used with an accessory that contains no metal. For body worn operation, Remote Controller (model:RM500-AG) has been tested and meets the FCC/ISEDCC RF exposure guidelines when used with an accessory designated for this product or when used with an accessory that contains no metal and that positions the handset a minimum of 0 cm from the body.



Non-compliance with the above restrictions may result in violation of RF exposure guidelines.

### **Informations sur l'exposition RF**

Les aéronefs et HIGH-PRECISION DBF IMAGING RADAR sont conformes aux limites d'exposition aux rayonnements DE FAC/ISEDG fixées pour un environnement incontrôlé. Afin d'éviter la possibilité de dépasser les limites d'exposition à la radiofréquence FCC/ISEDG, la proximité humaine de l'antenne ne doit pas être inférieure à 20 cm pendant le fonctionnement normal.

Pour le contrôleur à distance (modèle RM500-AG), les tests SAR sont effectués sur des positions de fonctionnement standard acceptées par la FCC/ISEDG, le dispositif émettant à son niveau de puissance certifié le plus élevé dans toutes les bandes de fréquences testées, bien que le SAR soit déterminé au niveau de puissance certifié le plus élevé, le niveau de SAR réel de l'appareil en cours d'utilisation peut être bien inférieur à la valeur maximale. Avant qu'un nouveau modèle ne soit disponible à la vente au public, il doit être testé et certifié conforme par la FCC/ISEDG qu'il n'excède pas la limite d'exposition établie par la FCC/ISEDG. Les tests de chaque produit sont effectués à requis par la FCC/ISEDG. En mode portatif, cet appareil a été testé et respecte les directives d'exposition RF de la FCC/ISEDG lorsqu'il est utilisé avec un accessoire conçu pour ce produit ou avec un accessoire ne contenant pas de métal.

Pour le fonctionnement sur le corps, la télécommande (modèle RM500-AG) a été testée et répond aux directives d'exposition RF de FCC/ISEDG lorsqu'elle est utilisée avec un accessoire conçu pour ce produit ou avec un accessoire ne contenant pas de métal et positionnant le combiné au minimum de 0 cm du corps.

Le non-respect des restrictions ci-dessus peut entraîner une violation des consignes d'exposition aux RF.

**EU Compliance Statement:** SZ DJI TECHNOLOGY CO., LTD. hereby declares that this device is in compliance with the essential requirements and other relevant provisions of the RED Directive.

This equipment must be installed and operated in accordance with provide instructions and the antenna used for this transmitter must be installed to provide a separation distance of at least 20cm from all persons and must not be co-located or operation in conjunction with any other antenna or transmitter. End-users and installers must be provide with antenna installation instructions and transmitter operating conditions for satisfying RF exposure compliance.

A copy of the EU Declaration of Conformity is available online at [www.dji.com/euro-compliance](http://www.dji.com/euro-compliance)



Warning: Operation of this equipment in a residential environment could cause radio interference.