

# DJI Mini SE Quick Start Guide

V1.0 2020.12

## Aircraft

DJI Mini SE features Obstacle Sensing and Infrared Sensing System\*, and a fully stabilized 3-axis gimbal with a 1/2.3" CMOS sensor camera that shoots 2.7K video and 12-megapixel photos.

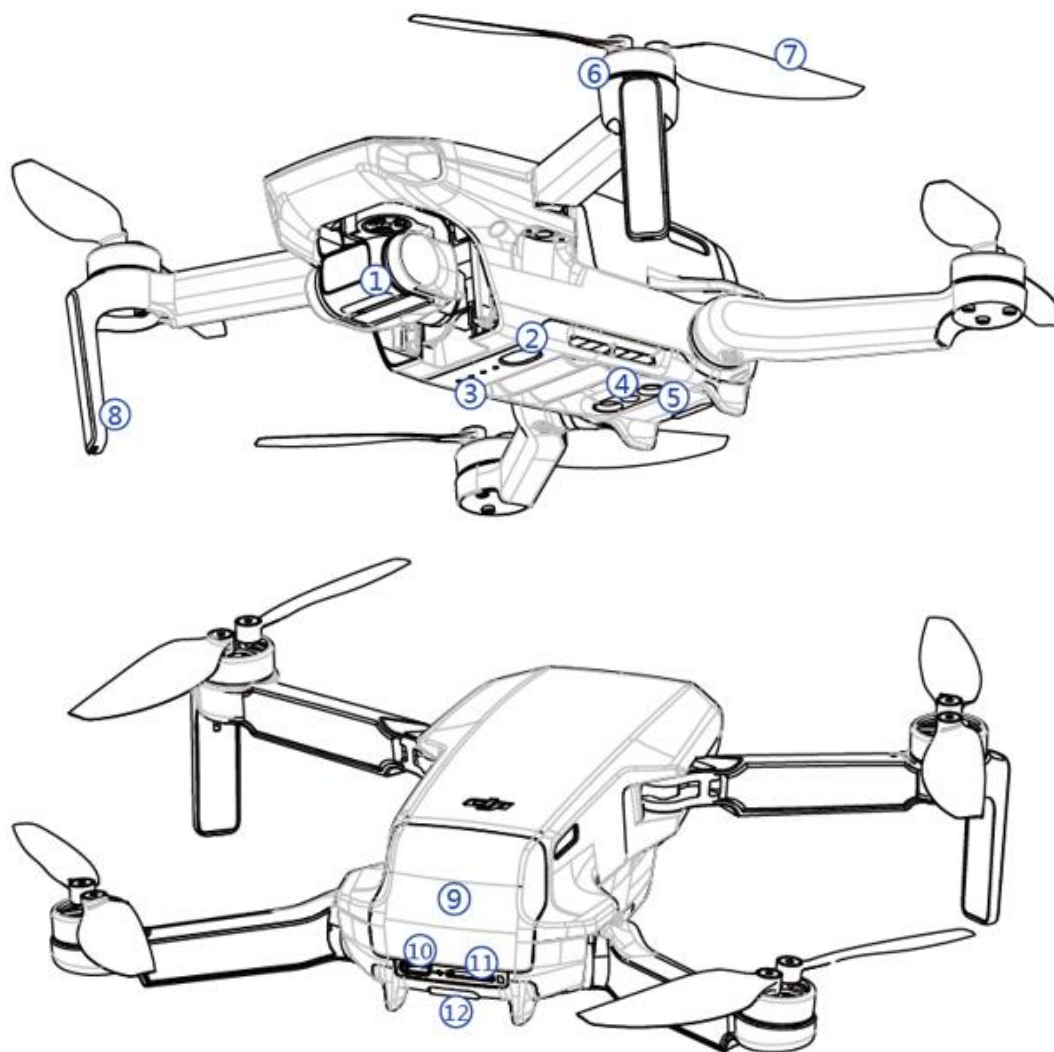

1. Gimbal and Camera
2. Power Button
3. Battery Level LEDs
4. Downward Vision System
5. Infrared Sensing System
6. Motors
7. Propellers

8. Antennas
9. Battery Cover
10. Charging/Upgrading Port (USB-C)
11. microSD Card Slot
12. Aircraft Status Indicator

\* The Vision Systems and Infrared Sensing Systems are affected by surrounding conditions. Read the Disclaimer and Safety Guidelines and watch the tutorial in the DJI Fly app or on the official DJI website to learn more. <http://www.dji.com/mini-se>

## Remote Controller

Built into the remote controller is the DJI enhanced Wi-Fi technology, offering a maximum transmission range of 2.49 mi (4 km) and video from the aircraft to the DJI Fly app on your mobile device. The detachable control sticks make the remote controller easier to store.

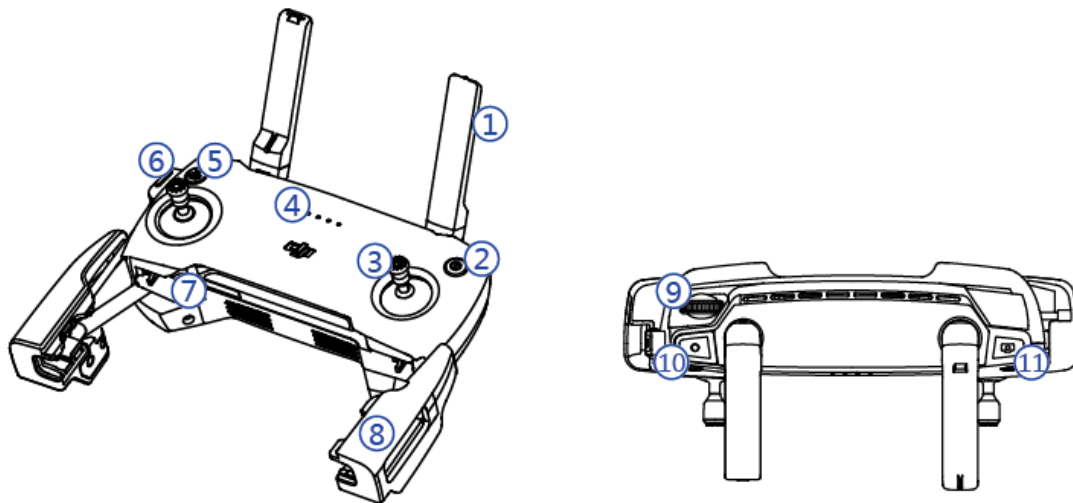

1. Antennas
2. Power Button
3. Removable Control Sticks
4. Battery Level LEDs
5. RTH Button
6. Video-Downlink/Charging Port (Micro USB)
7. Control Sticks Storage Slot
8. Mobile Device Clamp
9. Gimbal Dial
10. Record Button
11. Shutter Button

\* The remote controller is able to reach its maximum transmission distance (FCC) in a wide-open area with no electromagnetic Interference at an altitude of about 400 ft (120 m).

## Download the DJI Fly App and Watching Tutorial Videos

Search “DJI Fly” in the App Store or Google Play or scan the QR code below to download the app on your mobile device.

Watch the tutorial videos at [www.dji.com/mini-se](http://www.dji.com/mini-se) or in DJI Fly by tapping the icon in the top right corner of your screen.



 DJI Fly is compatible with iOS 10.0 (or later) or Android 5.0 (or later).

## Charging the Batteries

Use the provided charger to fully charge the Intelligent Flight Battery before first use.

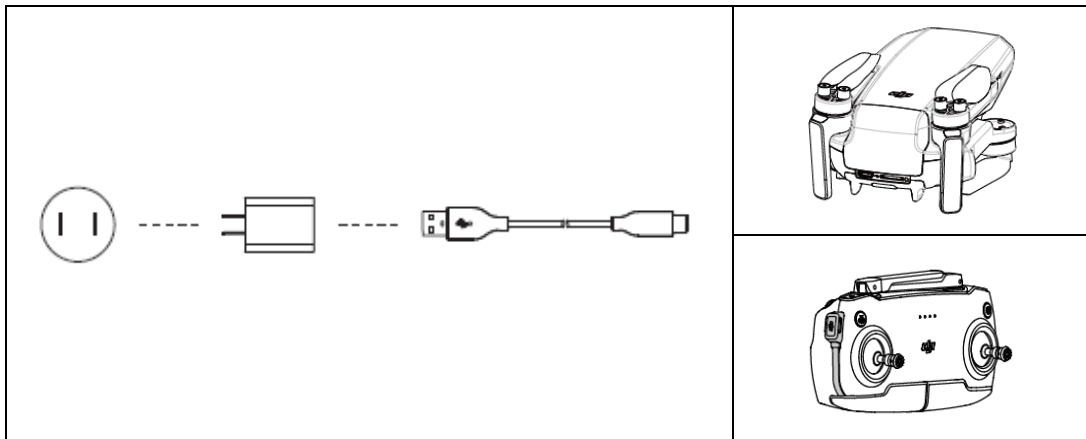

 Remove the remote controller cable before charging.

## Checking the Battery Levels and Powering On/Off

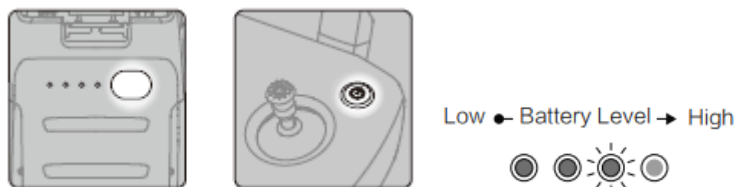

Press once to check the battery level.

Press, then press and hold to turn on/off.

## Preparing the Aircraft

1. Remove the gimbal cover from the camera.

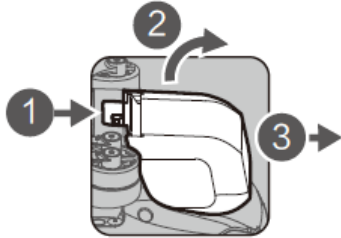

2. Unfold the front arms and the propellers.

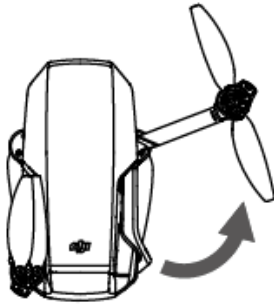

3. Unfold the rear arms and the propellers.

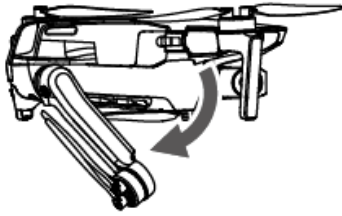

4. Unfolded

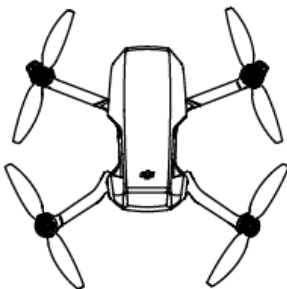

Unfold the front arms and the propellers before the rear ones. All arms and propellers must be unfolded before takeoff.

## Preparing the Remote Controller

1. Unfold the antennas and mobile device clamps, then attach the control sticks.

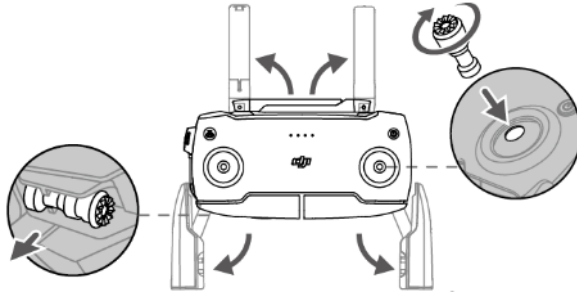

2. Place one end of the RC cable to the end of the slot.



3. Attach your mobile device within the clamps.

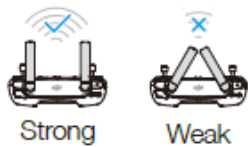
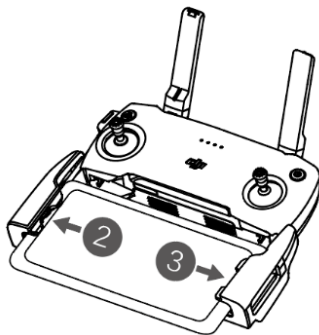

Set the antennas parallel to each other

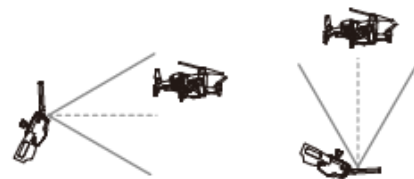

Optimal Transmission Range



- Ensure the control sticks are firmly mounted.
- The remote controller cable with the Lightning connector is mounted by default. Use the appropriate cable for your mobile device to connect to the remote controller.

## Preparing for Takeoff

1. Power on the remote controller



2. Power on the aircraft



3. Launch DJI Fly App



## Flight

- Auto Takeoff / Landing



Auto Takeoff



Auto Landing

- Manual Takeoff / Landing

Combination stick command to start/stop the motors



OR



Left stick up (slowly) to take off



Left stick down (slowly) until you touch the ground  
Hold a few seconds to stop the motors



The motors can only be stopped mid-flight when the flight controller detects critical error.

- **Remote Controller Operation**

The default flight control is known as Mode 2. The left stick controls the aircraft's altitude and heading, while the right stick controls its forward, backward, left and right movements. The gimbal dial controls the camera's tilt.

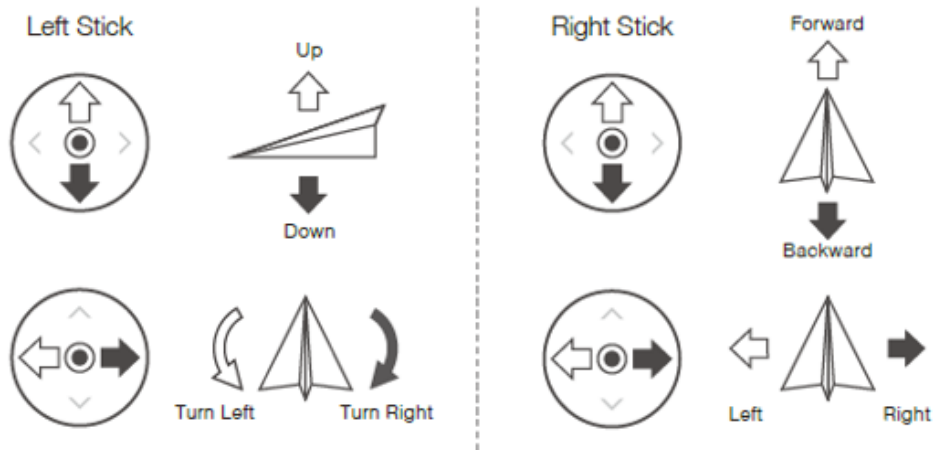

## Specifications

- **Aircraft (Model: MT2SS5 / MT2SD25)**

Weight	<249 g
Max Flight Time	30 minutes (0 wind while flying at a consistent 10.5 mph (17 kph))
Operating Temperature	32° to 104°F (0° to 40°C)
Operating Frequency	OcuSync 2.0 Model MT2SS5: 5.725 - 5.850 GHz Model MT2SD25: 2.400 - 2.4835 GHz; 5.725 - 5.850 GHz  GPS 1.57302 - 1.57782 GHz  GLONASS 1.597 - 1.607 GHz
Transmitter Power (EIRP)	Model MT2SS5 5.8 GHz: <30 dBm (FCC); <28 dBm (SRRC)  Model MT2SD25 2.4 GHz: <19 dBm (MIC/CE) 5.8 GHz: <14 dBm (CE)

- **Camera**

Sensor	1/2.3" CMOS; Effective pixels: 12M
Lens	FOV: 83°

	35mm format equivalent: 24 mm Aperture: f/2.8 Focus: 1 m to $\infty$
ISO Range	Video: 100-3200 (auto/manual) Photo: 100-1600 (auto); 100-3200 (manual)
Electronic Shutter Speed	4-1/8000 s

- **Remote Controller (Model: MR1SS5 / MR1SD25)**

Operating Frequency	Model MR1SS5: 5.725 - 5.850 GHz Model MR1SD25: 2.400 - 2.4835 GHz; 5.725 - 5.850 GHz
Battery	2550 mAh
Transmitter Power (EIRP)	Model MR1SS5 5.8 GHz: <30 dBm (FCC); <28 dBm (SRRC)  Model MR1SD25 2.4 GHz: <19 dBm (MIC/CE) 5.8 GHz: <14 dBm (CE)
Operating Voltage	1200mA @ 3.6V (Android) 700mA @ 3.6V (iOS)

- **Intelligent Flight Battery**

Capacity	2250 mAh
Battery Type	LiPo 2S
Charging Temperature	41° to 113°F (5° to 45°C)
Max Charging Power	29 W

**For more information, read the User Manual:**

<http://www.dji.com/mini-se>

※ This content is subject to change without prior notice.



### **FCC Compliance Notice**

This device complies with Part 15 of the FCC Rules. Operation is subject to the following two conditions: (1) This device may not cause harmful interference, and (2) This device must accept any interference received, including interference that may cause undesired operation.

Any changes or modifications not expressly approved by the party responsible for compliance could void the user's authority to operate the equipment.

This equipment has been tested and found to comply with the limits for a Class B digital device, pursuant to part 15 of the FCC Rules. These limits are designed to provide reasonable protection against harmful interference in a residential installation. This equipment generates, uses and can radiate radio frequency energy and, if not installed and used in accordance with the instructions, may cause harmful interference to radio communications. However, there is no guarantee that interference will not occur in a particular installation. If this equipment does cause harmful interference to radio or television reception, which can be determined by turning the equipment off and on, the user is encouraged to try to correct the interference by one or more of the following measures:

- Reorient or relocate the receiving antenna.
- Increase the separation between the equipment and receiver.
- Connect the equipment into an outlet on a circuit different from that to which the receiver is connected.
- Consult the dealer or an experienced radio/TV technician for help.

### **RF Exposure Information**

The aircraft complies with FCC radiation exposure limits set forth for an uncontrolled environment. In order to avoid the possibility of exceeding the FCC radio frequency exposure limits, human proximity to the antenna shall not be less than 20cm during normal operation. This transmitter must not be co-located or operating in conjunction with any other antenna or transmitter.

This equipment (MR1SS5) complies with FCC radiation exposure limits set forth for an uncontrolled environment. End user must follow the specific operating instructions for satisfying RF exposure compliance. This transmitter must not be co-located or operating in conjunction with any other antenna or transmitter.

### **ISED Compliance Notice**

This device contains licence-exempt transmitter(s)/receiver(s) that comply with Innovation, Science and Economic Development Canada's licence-exempt RSS(s). Operation is subject to the following two conditions: (1) This device may not cause interference. (2) This device must accept any interference, including interference that may cause undesired operation of the device.

L'émetteur/récepteur exempt de licence contenu dans le présent appareil est conforme aux CNR d'Innovation, Sciences et Développement économique Canada applicables aux appareils radio exempts de licence. L'exploitation est autorisée aux deux conditions suivantes : (1) L'appareil ne doit pas produire de brouillage; (2) L'appareil doit accepter tout brouillage radioélectrique subi, même si le brouillage est susceptible d'en compromettre le fonctionnement.

This equipment (MR1SS5) complies with ISED radiation exposure limits set forth for an uncontrolled environment. End user must follow the specific operating instructions for satisfying RF exposure compliance. This transmitter must not be co-located or operating in conjunction with any other antenna or transmitter. The portable device is designed to meet the requirements for exposure to radio waves established by the ISED.

Cet équipement est conforme aux limites d'exposition aux rayonnements ISED établies pour un environnement non contrôlé. L'utilisateur final doit suivre les instructions spécifiques pour satisfaire les normes. Cet émetteur ne doit pas être co-implanté ou fonctionner en conjonction avec toute autre antenne ou transmetteur. Le dispositif portatif est conçu pour répondre aux exigences d'exposition aux ondes radio établie par le développement énergétique DURABLE.

This equipment complies with RSS - 102 radiation exposure limits set forth for an uncontrolled environment. This equipment should be installed and operated with minimum distance 20cm between the radiator and your body. This transmitter must not be co-located or operating in conjunction with any other antenna or transmitter.

Cet équipement est conforme aux limites d'exposition aux radiations CNR - 102 établies pour un environnement non contrôlé. Cet équipement doit être installé et utilisé avec une distance minimale de 20 cm entre le radiateur et votre corps.

#### **Mexico Warning message**

“La operación de este equipo está sujeta a las siguientes dos condiciones: (1) es posible que este equipo o dispositivo no cause interferencia perjudicial y (2) este equipo o dispositivo debe aceptar cualquier interferencia, incluyendo la que pueda causar su operación no deseada.”

#### **Brazil Warning message**

Informações sobre Regulamentação

Estes equipamentos estão certificados e homologados pela ANATEL.

Para maiores informações, consulte o site da ANATEL: [www.anatel.gov.br](http://www.anatel.gov.br).

Este equipamento não tem direito à proteção contra interferência prejudicial e não pode causar interferência em sistemas devidamente autorizados.

Este produto está homologado pela Anatel de acordo com os procedimentos regulamentados para avaliação da conformidade de produtos para telecomunicações e atende aos requisitos técnicos aplicados, incluindo os limites de exposição da Taxa de Absorção Específica referente a campos elétricos, magnéticos e eletromagnéticos de radiofrequência.

Valores máximos de SAR:

Corpo SAR (10g) Brasil: 0.188W/kg

#### **Thailand Warning message**

เครื่องโทรคมนาคมและอุปกรณ์นี้ มีความสอดคล้องตามข้อกำหนดของ กทช.



**EU Compliance Statement:** SZ DJI TECHNOLOGY CO., LTD. hereby declares that this device is in compliance with the essential requirements and other relevant provisions of the Directive 2014/53/EU.

A copy of the EU Declaration of Conformity is available online at [www.dji.com/euro-compliance](http://www.dji.com/euro-compliance)  
EU contact address: DJI GmbH, Industriestrasse 12, 97618, Niederlauer, Germany

**GB Compliance Statement:** SZ DJI TECHNOLOGY CO., LTD. hereby declares that this device is in compliance with the essential requirements and other relevant provisions of Radio Equipment Regulations 2017.

A copy of the GB Declaration of Conformity is available online at [www.dji.com/euro-compliance](http://www.dji.com/euro-compliance)

**Declaración de cumplimiento UE:** SZ DJI TECHNOLOGY CO., LTD. por la presente declara que este dispositivo cumple los requisitos básicos y el resto de provisiones relevantes de la Directiva 2014/53/EU.

Hay disponible online una copia de la Declaración de conformidad UE en [www.dji.com/euro-compliance](http://www.dji.com/euro-compliance)

Dirección de contacto de la UE: DJI GmbH, Industriestrasse 12, 97618, Niederlauer, Germany

**EU-verklaring van overeenstemming:** SZ DJI TECHNOLOGY CO., LTD. verklaart hierbij dat dit apparaat voldoet aan de essentiële vereisten en andere relevante bepalingen van Richtlijn 2014/53/EU.

De EU-verklaring van overeenstemming is online beschikbaar op [www.dji.com/euro-compliance](http://www.dji.com/euro-compliance)  
Contactadres EU: DJI GmbH, Industriestrasse 12, 97618, Niederlauer, Germany

**Declaração de conformidade da UE:** A SZ DJI TECHNOLOGY CO., LTD. declara, através deste documento, que este dispositivo está em conformidade com os requisitos essenciais e outras disposições relevantes da Diretiva 2014/53/EU.

Existe uma cópia da Declaração de conformidade da UE disponível online em [www.dji.com/euro-compliance](http://www.dji.com/euro-compliance)

Endereço de contacto na UE: DJI GmbH, Industriestrasse 12, 97618, Niederlauer, Germany

**Dichiarazione di conformità UE:** SZ DJI TECHNOLOGY CO., LTD. dichiara che il presente dispositivo è conforme ai requisiti essenziali e alle altre disposizioni rilevanti della direttiva 2014/53/EU.

Una copia della dichiarazione di conformità UE è disponibile online all'indirizzo Web [www.dji.com/euro-compliance](http://www.dji.com/euro-compliance)

Indirizzo di contatto UE: DJI GmbH, Industriestrasse 12, 97618, Niederlauer, Germany

**Déclaration de conformité UE :** Par la présente, SZ DJI TECHNOLOGY CO., LTD déclare que cet appareil est conforme aux principales exigences et autres clauses pertinentes de la directive

européenne 2014/53/EU.

Une copie de la déclaration de conformité UE est disponible sur le site [www.dji.com/euro-compliance](http://www.dji.com/euro-compliance)

Adresse de contact pour l'UE : DJI GmbH, Industriestrasse 12, 97618, Niederlauer, Germany

**EU-Compliance:** Hiermit erklärt SZ DJI TECHNOLOGY CO., LTD., dass dieses Gerät den wesentlichen Anforderungen und anderen einschlägigen Bestimmungen der EU-Richtlinie 2014/53/EU entspricht.

Eine Kopie der EU-Konformitätserklärung finden Sie online auf [www.dji.com/euro-compliance](http://www.dji.com/euro-compliance)

Kontaktadresse innerhalb der EU: DJI GmbH, Industriestrasse 12, 97618, Niederlauer, Germany

**Декларация за съответствие на ЕС:** SZ DJI TECHNOLOGY CO., LTD. декларира, че това устройство отговаря на основните изисквания и другите приложими разпоредби на Директива 2014/53/ЕС.

Копие от Декларацията за съответствие на ЕС ще намерите онлайн на адрес [www.dji.com/euro-compliance](http://www.dji.com/euro-compliance)

Адрес за контакт за ЕС: DJI GmbH, Industriestrasse 12, 97618, Niederlauer, Германия

**Prohlášení o shodě pro EU:** Společnost SZ DJI TECHNOLOGY CO., LTD. tímto prohlašuje, že tohle zařízení vyhovuje základním požadavkům a dalším příslušným ustanovením směrnice 2014/53/EU.

Kopie prohlášení o shodě pro EU je k dispozici on-line na webu [www.dji.com/euro-compliance](http://www.dji.com/euro-compliance)

Kontaktní adresa v EU: DJI GmbH, Industriestrasse 12, 97618, Niederlauer, Německo

**EU-overensstemmelseserklæring:** SZ DJI TECHNOLOGY CO., LTD. erklærer hermed, at denne enhed er i overensstemmelse med de væsentlige krav og andre relevante bestemmelser i direktiv 2014/53/EU.

Der er en kopi af EU-overensstemmelseserklæringen tilgængelig online på [www.dji.com/euro-compliance](http://www.dji.com/euro-compliance)

EU-kontaktadresse: DJI GmbH, Industriestrasse 12, 97618, Niederlauer, Tyskland

**Δήλωση Συμμόρφωσης ΕΕ:** Η SZ DJI TECHNOLOGY CO., LTD. δια του παρόντος δηλώνει ότι η συσκευή αυτή συμμορφώνεται με τις βασικές απαιτήσεις και άλλες σχετικές διατάξεις της Οδηγίας 2014/53/ΕΕ.

Αντίγραφο της Δήλωσης Συμμόρφωσης ΕΕ διατίθεται ηλεκτρονικά στη διεύθυνση [www.dji.com/euro-compliance](http://www.dji.com/euro-compliance)

Διεύθυνση επικοινωνίας στην ΕΕ: DJI GmbH, Industriestrasse 12, 97618, Niederlauer, Γερμανία

**Eli vastavuskinnitus** Käesolevaga teatab SZ DJI TECHNOLOGY CO., LTD., et see seade on kooskõlas direktiivi 2014/53/EL oluliste nõuete ja muude asjakohaste sätetega.

Eli vastavusdeklaratsiooni koopia on kättesaadav veebis aadressil [www.dji.com/euro-compliance](http://www.dji.com/euro-compliance)

Kontaktaadress ELis: DJI GmbH, Industriestrasse 12, 97618, Niederlauer, Saksamaa

**Pranešimas dėl atitikties ES reikalavimams** Bendrovė „SZ DJI TECHNOLOGY CO., LTD.“ tvirtina, kad šis prietaisas atitinka pagrindinius 2014/53/ES direktyvos reikalavimus ir kitas susijusias

nuostatas.

ES atitikties deklaracijos kopiją galite rasti adresu [www.dji.com/euro-compliance](http://www.dji.com/euro-compliance)

ES kontaktinis adresas: „DJI GmbH“, Industriestrasse 12, 97618, Niederlauer, Germany (Vokietija)

**ES atbilstības paziņojums:** *SZ DJI TECHNOLOGY CO., LTD.* ar šo apliecina, ka šī ierīce atbilst direktīvas 2014/53/ES pamatprasībām un pārējiem būtiskiem nosacījumiem.

ES atbilstības deklarācijas kopija pieejama tiešsaistē vietnē [www.dji.com/euro-compliance](http://www.dji.com/euro-compliance)

ES kontaktadrese: DJI GmbH, Industriestrasse 12, 97618, Niederlauer, Vācija

**EU:n vaatimustenmukaisuusvakuutus:** *SZ DJI TECHNOLOGY CO., LTD.* ilmoittaa täten, että tämä laite on direktiivin 2014/53/EU olennaisten vaatimusten ja sen muiden asiaankuuluvien ehtojen mukainen.

Kopio EU:n vaatimustenmukaisuusvakuutuksesta on saatavana verkossa osoitteessa [www.dji.com/euro-compliance](http://www.dji.com/euro-compliance)

Yhteystiedot EU:ssa: DJI GmbH, Industriestrasse 12, 97618, Niederlauer, Germany

**RÁITEAS Comhlíonta an AE:** Dearbhaíonn *SZ DJI TECHNOLOGY CO., LTD.* leis seo go bhfuil an gléas seo de réir na gceanglas riachtanach agus na bhforálacha ábhartha eile sa Treoir 2014/53/AE.

Tá coip de Dhearbhú Comhréireachta an AE ar fáil ar líne ag [www.dji.com/euro-compliance](http://www.dji.com/euro-compliance)

Seoladh teagmhála san AE: DJI GmbH, Industriestrasse 12, 97618, Niederlauer, Germany

**Dikjarazzjoni ta' Konformità tal-UE:** *SZ DJI TECHNOLOGY CO., LTD.* hawnhekk tiddikjara li dan l-apparat huwa konformi mar-rekwiziti essenzjali u ma' dispozizzjonijiet relevanti oħra tad-Direttiva 2014/53/UE.

Kopja tad-Dikjarazzjoni ta' Konformità tal-UE hija disponibbli onlajn fis-sit [www.dji.com/euro-compliance](http://www.dji.com/euro-compliance)

Indirizz ta' kuntatt tal-UE: DJI GmbH, Industriestrasse 12, 97618, Niederlauer, il-Ġermanja

**Declarația UE de conformitate:** Prin prezenta, *SZ DJI TECHNOLOGY CO., LTD.* declară faptul că acest dispozitiv este conform cu cerințele esențiale și celelalte prevederi relevante ale Directivei 2014/53/UE.

Un exemplar al Declarației UE de conformitate este disponibil online, la adresa [www.dji.com/euro-compliance](http://www.dji.com/euro-compliance)

Adresa de contact pentru UE: DJI GmbH, Industriestrasse 12, 97618, Niederlauer, Germania

**Izjava EU o skladnosti:** Družba *SZ DJI TECHNOLOGY CO., LTD.* izjavlja, da ta naprava ustreza osnovnim zahtevam in drugim ustreznim določbam Direktive 2014/53/EU.

Kopija izjave EU o skladnosti je na voljo na spletu na [www.dji.com/euro-compliance](http://www.dji.com/euro-compliance)

Kontaktni naslov EU: DJI GmbH, Industriestrasse 12, 97618, Niederlauer, Nemčija

**EU Izjava o skladnosti:** Tvrtka *SZ DJI TECHNOLOGY CO., LTD.* izjavljuje da je ovaj uređaj izrađen u skladu s osnovnim zahtjevima i ostalim relevantnim odredbama Direktive 2014/53/EU.

Kopija EU Izjave o skladnosti dostupna je na mrežnoj stranici [www.dji.com/euro-compliance](http://www.dji.com/euro-compliance)

Adresa EU kontakta: DJI GmbH, Industriestrasse 12 97618, Niederlauer, Njemačka

**Vyhlasenie o zhode EÚ:** *SZ DJI TECHNOLOGY CO., LTD.* týmto vyhlasuje, že toto zariadenie je v zhode so základnými požiadavkami a ďalšími relevantnými ustanoveniami smernice 2014/53/EÚ. Kópia tohto Vyhlasenia o zhode EÚ je k dispozícii online na [www.dji.com/euro-compliance](http://www.dji.com/euro-compliance)  
Kontaktná adresa v EÚ: DJI GmbH, Industriestrasse 12, 97618, Niederlauer, Nemecko

**Deklaracja zgodności UE:** Firma *SZ DJI TECHNOLOGY CO., LTD.* niniejszym oświadcza, że przedmiotowe urządzenie jest zgodne z zasadniczymi wymogami i innymi stosownymi postanowieniami dyrektywy 2014/53/UE.

Kopię deklaracji zgodności UE można znaleźć w Internecie na stronie [www.dji.com/euro-compliance](http://www.dji.com/euro-compliance)

Adres do kontaktu w UE: DJI GmbH, Industriestrasse 12, 97618, Niederlauer, Niemcy

**EU megfeleléségi nyilatkozat:** A *SZ DJI TECHNOLOGY CO., LTD.* ezúton megerősíti, hogy ez az eszköz megfelel a 2014/53/EU Irányelv alapvető követelményeinek és más vonatkozó rendelkezéseinek.

Az EU megfeleléségi nyilatkozat másolata elérhető a [www.dji.com/euro-compliance](http://www.dji.com/euro-compliance) oldalon

EU kapcsolati cím: DJI GmbH, Industriestrasse 12, 97618, Niederlauer, Németország

**EU-försäkran om efterlevnad:** *SZ DJI TECHNOLOGY CO., LTD.* härmed förklarar att denna enhet uppfyller de väsentliga kraven och andra relevanta bestämmelser i direktivet 2014/53/EU.

En kopia av EU-försäkran om efterlevnad finns att tillgå online på adressen [www.dji.com/euro-compliance](http://www.dji.com/euro-compliance)

Kontaktadress EU: DJI GmbH, Industriestrasse 12, 97618, Niederlauer, Tyskland

**Yfirlýsing um fylgni við reglur ESB:** *SZ DJI TECHNOLOGY CO., LTD.* lýsir hér með yfir að þetta tæki hlíti mikilvægum kröfum og öðrum viðeigandi ákvæðum tilskipunar 2014/53/ESB.

Nálgast má eintak af ESB-samræmisyfirlýsingunni á netinu á [www.dji.com/euro-compliance](http://www.dji.com/euro-compliance)

Heimilisfang ESB-tengiliðar: DJI GmbH, Industriestrasse 12, 97618, Niederlauer, Germany

**AB Uygunluk Beyanı:** *SZ DJI TECHNOLOGY CO., LTD.* bu belge ile bu cihazın temel gerekliliklere ve 2014/53/EU sayılı Direktifin diğer ilgili hükümlerine uygun olduğunu beyan eder.

AB Uygunluk Beyanının bir kopyasına [www.dji.com/euro-compliance](http://www.dji.com/euro-compliance) adresinden çevrim içi olarak ulaşılabilir

AB için iletişim adresi: DJI GmbH, Industriestrasse 12, 97618, Niederlauer, Almanya

CAUTION: RISK OF EXPLOSION IF BATTERY IS REPLACED BY AN INCORRECT TYPE. DISPOSE OF USED BATTERIES ACCORDING TO THE INSTRUCTIONS

#### Environmentally friendly disposal



Old electrical appliances must not be disposed of together with the residual waste, but have to be disposed of separately. The disposal at the communal collecting point via private persons is for free. The owner of old appliances is responsible to bring the appliances to these collecting points or to similar collection

points. With this little personal effort, you contribute to recycle valuable raw materials and the treatment of toxic substances.

### **Umweltfreundliche Entsorgung**

Elektro-Altgeräte dürfen nicht mit gewöhnlichem Abfall entsorgt werden und müssen separat entsorgt werden. Die Entsorgung an kommunalen Sammelstellen ist für Privatpersonen kostenlos. Die Eigentümer der Altgeräte sind für den Transport zu den Sammelstellen verantwortlich. Durch diesen geringen Aufwand können Sie zur Wiederverwertung von wertvollen Rohmaterialien beitragen und dafür sorgen, dass umweltschädliche und giftige Substanzen ordnungsgemäß unschädlich gemacht werden.

### **Tratamiento de residuos responsable con el medio ambiente**

Los aparatos eléctricos viejos no pueden desecharse junto con los residuos orgánicos, sino que deben ser desechados por separado. Existen puntos limpios donde los ciudadanos pueden dejar estos aparatos gratis. El propietario de los aparatos viejos es responsable de llevarlos a estos puntos limpios o similares puntos de recogida. Con este pequeño esfuerzo estás contribuyendo a reciclar valiosas materias primas y al tratamiento de residuos tóxicos.

### **Mise au rebut écologique**

Les appareils électriques usagés ne doivent pas être éliminés avec les déchets résiduels. Ils doivent être éliminés séparément. La mise au rebut au point de collecte municipale par l'intermédiaire de particuliers est gratuite. Il incombe au propriétaire des appareils usagés de les apporter à ces points de collecte ou à des points de collecte similaires. Avec ce petit effort personnel, vous contribuez au recyclage de matières premières précieuses et au traitement des substances toxiques.

### **Smaltimento ecologico**

I vecchi dispositivi elettrici non devono essere smaltiti insieme ai rifiuti residui, ma devono essere smaltiti separatamente. Lo smaltimento da parte di soggetti privati presso i punti di raccolta pubblici è gratis. È responsabilità del proprietario dei vecchi dispositivi portarli presso tali punti di raccolta o punti di raccolta analoghi. Grazie a questo piccolo impegno personale contribuirete al riciclo di materie prime preziose e al corretto trattamento di sostanze tossiche.

### **Milieuvriendelijk afvoeren**

Oude elektrische apparaten mogen niet worden weggegooid samen met het restafval, maar moeten afzonderlijk worden afgevoerd. Afvoeren via het gemeentelijke inzamelpunt is gratis voor particulieren. De eigenaar van oude toestellen is verantwoordelijk voor het inleveren van de apparaten op deze of vergelijkbare inzamelpunten. Met deze kleine persoonlijke inspanning lever je een bijdrage aan de recycling van waardevolle grondstoffen en de verwerking van giftige stoffen.

### **Eliminação ecológica**

Os aparelhos elétricos antigos não podem ser eliminados juntamente com os materiais residuais. Têm de ser eliminados separadamente. A eliminação no ponto de recolha público através de entidades particulares é gratuita. É da responsabilidade do proprietário de aparelhos antigos levá-los a estes pontos de recolha ou a pontos de recolha semelhantes. Com este pequeno esforço

peessoal, contribui para a reciclagem de matérias-primas úteis e para o tratamento de substâncias tóxicas.

#### **Изхвърляне с оглед опазване на околната среда**

Старите електрически уреди не трябва да се изхвърлят заедно с битовите отпадъци, а отделно. Изхвърлянето в общинския пункт за събиране на отпадъци от частни лица е безплатно. Собственикът на старите уреди е отговорен за пренасянето на уредите до тези или до подобни събирателни пунктове. С това малко собствено усилие допринасяте за рециклирането на ценни суровини и за обработката на токсични вещества.

#### **Ekologicky šetrná likvidace**

Stará elektrická zařízení nesmějí být likvidována spolu se zbytkovým odpadem, ale musí být likvidována samostatně. Likvidace na komunálních sběrných místech prostřednictvím soukromých osob je bezplatná. Vlastník starých zařízení odpovídá za to, že je donese do těchto sběrných míst nebo na obdobná sběrná místa. Tímto můžete přispět k recyklaci hodnotných surovin a zpracování toxických látek.

#### **Miljøvenlig bortskaffelse**

Gamle elektriske apparater må ikke bortskaffes sammen med restaffald, men skal bortskaffes separat. Bortskaffelse på et fælles indsamlingssted er gratis for privatpersoner. Ejere af gamle apparater er ansvarlige for at bringe apparater hen til disse indsamlingssteder eller til lignende indsamlingssteder. Med denne lille personlige indsats bidrager du til genanvendelse af værdifulde råvarer og behandlingen af giftige stoffer.

#### **Απόρριψη φιλική προς το περιβάλλον**

Οι παλιές ηλεκτρικές συσκευές δεν πρέπει να απορρίπτονται μαζί με τα υπολειμματικά απόβλητα, αλλά ξεχωριστά. Η απόρριψη στο δημοτικό σημείο συλλογής μέσω ιδιωτών γίνεται χωρίς χρέωση. Ο κάτοχος παλιών συσκευών είναι υπεύθυνος για τη μεταφορά των συσκευών σε αυτά ή παρόμοια σημεία συλλογής. Μέσω της ατομικής σας προσπάθειας, συμβάλλετε στην ανακύκλωση πολύτιμων πρώτων υλών και την επεξεργασία των τοξικών ουσιών.

#### **Keskkonnasäästlik kasutuselt kõrvaldamine**

Vanu elektriseadmeid ei tohi ära visata koos olmejäätmetega, vaid tuleb koguda ja kasutuselt kõrvaldada eraldi. Kohaliku omavalitsuse elektroonikaromude kogumispunktis on äraandmine eraisikutele tasuta. Vanade seadmete sellistesse või sarnastesse kogumispunktidesse toimetamise eest vastutavad seadmete omanikud. Selle väikese isikliku panusega aitate kaasa väärtusliku toorme ringlussevõtule ja mürgiste ainete töötlemisele.

#### **Utilizavimas nekenkiant aplinkai**

Senų elektrinių prietaisų negalima išmesti kartu su buitinėmis atliekomis; juos būtina utilizuoti atskirai. Tokių prietaisų utilizavimas per komunalinius atliekų surinkimo punktus yra nemokamas. Elektrinių prietaisų savininkai utilizuojamus prietaisus privalo priduoti į atitinkamus arba analogiškus atliekų surinkimo punktus. Tokiu būdu, įdėdami nedaug pastangų, prisidėsite prie vertingų medžiagų perdirdimo ir aplinkos apsaugojimo nuo toksinių medžiagų.



### **Videi draudzīga atkritumu likvidēšana**

Vecas elektriskās ierīces nedrīkst likvidēt kopā ar pārējiem atkritumiem, bet tās jālikvidē atsevišķi. Privātpersonām atkritumu likvidēšana komunālajā savākšanas punktā ir bez maksas. Veco ierīču īpašnieks ir atbildīgs par ierīču nogādāšanu šajos savākšanas punktos vai līdzīgos savākšanas punktos. Ar šīm nelielām personiskajām pūlēm jūs veicināt vērtīgu izejmateriālu pārstrādi un toksisko vielu apstrādi.

### **Hävittäminen ympäristöystävällisesti**

Vanhoja sähkölaitteita ei saa hävittää kaatopaikkajätteen mukana, vaan ne on hävitettävä erikseen. Kunnalliseen keräyspisteeseen vieminen on yksityishenkilölle ilmaista. Vanhojen laitteiden omistaja vastaa laitteiden toimittamisesta kyseisiin keräyspisteisiin tai vastaaviin. Tällä vähäisellä henkilökohtaisella vaivalla edistät omalta osaltasi arvokkaiden raaka-aineiden kierrätystä ja myrkyllisten aineiden käsittelyä.

### **Diúscairt neamhdhíobhálach don chomhshaol**

Níor cheart seanghléasanna leictreacha a dhiúscairt leis an dramhaíl iarmharach, ach caithfear iad a chur de láimh astu féin. Tá an diúscairt ag an ionad bailiúcháin pobail ag daoine príobháideacha saor in aisce. Tá freagracht ar úinéir seanghléasanna na gléasanna a thabhairt chuig na hionaid bhailiúcháin sin nó chuig ionaid bhailiúcháin den chineál céanna. Le hiarracht bheag phearsanta mar sin, cuidíonn tú le hamhábhair luachmhara a athchúrsáil agus le substaintí tocsaineacha a chóireáil

### **Rimi li jirrispetta l-ambjent**

L-apparat elettriku qadim ma għandux jintrema flimkien ma' skart residwu, iżda għandu jintrema b'mod separat. Ir-rimi fil-post tal-ġbir komunali minn persuni privati huwa b'xejn. Is-sit ta' apparat qadim huwa responsabbli biex iġib l-apparat f'dawn il-postijiet tal-ġbir jew f'postijiet tal-ġbir simili. B'dan l-isforz personali żgħir, inti tikkontribwixxi għar-riċiklaġġ ta' materja prima prezzjuża u għat-trattament ta' sustanzi tossiċi.

### **Eliminarea ecologică**

Aparatele electrice vechi nu trebuie aruncate odată cu deșeurile reziduale, ci trebuie eliminate separat. Eliminarea în cadrul punctului de colectare local de către persoane fizice este gratuită. Proprietarii de aparate vechi sunt responsabili pentru transportul acestora la respectivele puncte de colectare sau la alte puncte de colectare similare. Prin acest efort personal nesemnificativ, puteți contribui la reciclarea materiilor prime valoroase și la tratarea substanțelor toxice.

### **Okolju prijazno odlaganje**

Starih električnih aparatov ne smete odvreči skupaj z ostanki odpadkov, temveč ločeno. Odlaganje na komunalnem zbirnem mestu je za fizične osebe brezplačno. Lastnik starih naprav je odgovoren, da jih pripelje do teh ali podobnih zbirnih mest. S tako malo osebnega truda prispevate k recikliranju dragocenih surovin in obdelavi strupenih snovi.

### **Ekološko odlaganje**

Stari električni uređaji ne smiju se odlagati zajedno s kućnim otpadom, već ih treba odlagati odvojeno. Odlaganje na komunalnom sabirnom mjestu od strane privatnih osoba je besplatno. Vlasnik starih uređaja dužan je donijeti uređaje do tih sabirnih mjesta ili sličnih sabirnih mjesta. Ovim malim osobnim naporom doprinosite recikliranju vrijednih sirovina i pravilnoj obradi otrovnih tvari.

### **Ekologická likvidácia**

Staré elektrospotrebiče sa nesmú likvidovať spolu so zvyškovým odpadom, ale musia sa zlikvidovať samostatne. Likvidácia v komunálnom zbernom mieste prostredníctvom súkromných osôb je bezplatná. Majiteľ starých spotrebičov je zodpovedný za prinesenie spotrebičov na tieto zberné miesta alebo na podobné zberné miesta. Týmto malým osobným úsilím prispievate k recyklovaniu cenných surovín a spracovaniu toxických látok

### **Utylizacja przyjazna dla środowiska**

Nie można usuwać starych urządzeń elektrycznych wraz z pozostałymi odpadami. Wymagają one oddzielnej utylizacji. Utylizacja przez osoby prywatne w punkcie zbiórki odpadów komunalnych jest darmowa. Właściciel starych urządzeń jest odpowiedzialny za dostarczenie ich do takich lub podobnych punktów zbiórki. Zadając sobie tak niewielki trud, przyczyniasz się do recyklingu cennych surowców i odpowiedniego postępowania z substancjami toksycznymi.

### **Környezetbarát hulladékkezelés**

A régi elektromos készülékeket nem szabad a nem szelektíven gyűjtött hulladékkal együtt kidobni, hanem a hulladékkezelésüket elkülönítve kell végezni. A közösségi gyűjtőpontokon a magánszemélyek ingyenesen leadhatják ezeket. A régi készülékek tulajdonosai felelnek azért, hogy a készülékeket ezekre a gyűjtőpontokra, vagy más gyűjtőpontokra elhozzák. Ezzel a kis személyes erőfeszítéssel Ön is hozzájárul az értékes nyersanyagok újrahasznosításához és a mérgező anyagok kezeléséhez.

### **Miljövämlig hantering av avfall**

Gamla elektriska apparater får inte kasseras tillsammans med restavfallet utan måste kasseras separat. Kassering på den lokala insamlingsplatsen för privatpersoner är gratis. Ägaren av gamla apparater ansvarar för att ta apparaterna till dessa insamlingsplatser eller till liknande insamlingsplatser. Med denna lilla personliga insats bidrar du till återvinning av värdefulla råvaror och hantering av giftiga ämnen.

### **Umhverfisvæn förgun**

Ekki má farga gömlum raftækjum með úrgangsléifum, heldur þarf að farga þeim sérstaklega. Förgun á almennum söfnunarstöðum er ókeypis fyrir einstaklinga. Eigandi gamalla tækja ber ábyrgð á að koma með tækin á þessa söfnunarstaði eða á svipaða söfnunarstaði. Með þessu litla persónulega átaki stuðlar þú að endurvinnslu verðmætra hráefna og meðferð eitrufna.

### **Çevre dostu bertaraf**

Eski elektrikli cihazlar, diğer atıklarla birlikte bertaraf edilmemelidir, ayrıca atılmalıdır. Özel kişiler aracılığıyla genel toplama noktasına bertaraf işlemi ücretsiz olarak yapılmaktadır. Eski cihazların

sahibi, cihazları bu toplama noktalarına veya benzer toplama noktalarına getirmekten sorumludur. Bu az miktardaki kişisel çabayla, değerli ham maddelerin geri dönüştürülmesine ve toksik maddelerin işleme alınmasına katkıda bulunmuş olursunuz.

**KCC Compliance Notice**

“해당무선설비는 운용 중 전파혼신 가능성이 있으므로 인명안전과 관련된 서비스는 할 수 없습니다.”

“해당 무선설비는 운용 중 전파혼신 가능성이 있음”

