

# DJI Matrice 30 Series Dock Version User Guide

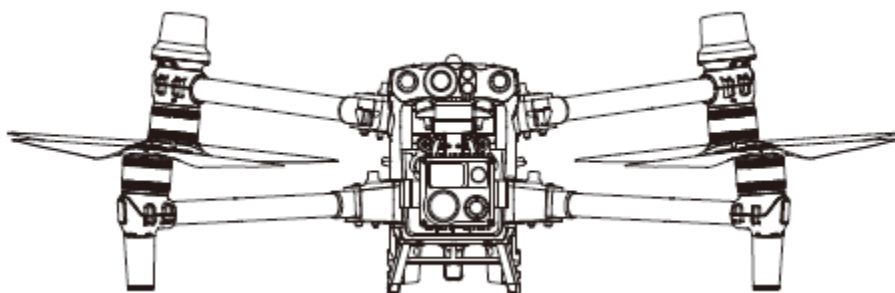



v1.0



# Introduction

DJI™ MATRICE™ 30 Series Dock Version aircraft can be linked to DJI Dock Version. With DJI FlightHub 2, it can be used to perform automated operations remotely.

## In the Box

Aircraft* ×1 with microSD card inserted	Screws and Tools ×1	1671 Propeller ×2	1671 Propeller ×2
		 CW	 CCW

\* The M30 Dock Version and M30T Dock Version are equipped with different cameras. Refer to the actual product purchased. This guide uses the M30T aircraft as an example.

## Preparing the Aircraft

	<ul style="list-style-type: none"><li>• Make sure the propellers are securely mounted and not damaged or deformed and that there are no foreign objects in or on the motors or propellers.</li><li>• Make sure the lenses of the vision systems, gimbal cameras, FPV camera, the glass of the infrared sensors, and the auxiliary lights are clean and not blocked in any way, and the protective stickers are removed.</li><li>• Make sure the waterproof rubber port covers are correctly in place and securely sealed.</li></ul>
---	---

1. Unfold the frame arms on both sides in the same way. Make sure the frame arm folded buttons pop out so that the frame arms are locked firmly.
2. Make sure the gimbal camera is facing forward laterally.

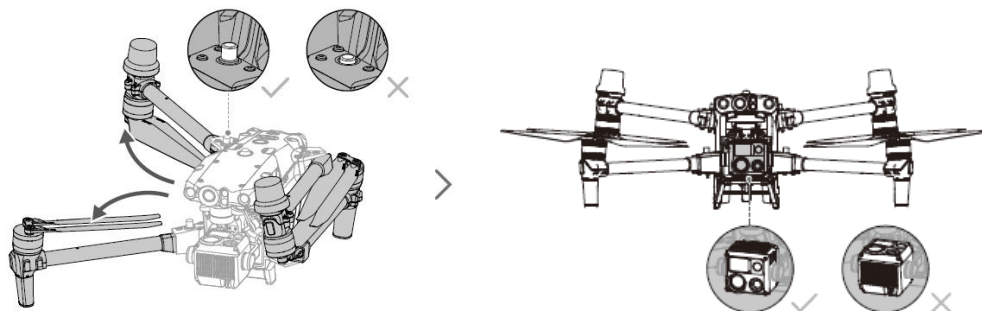

3. Insert two TB30 batteries (purchased separately). Make sure the battery release toggles are in the same position as shown in the diagram.

4. Press and then press and hold the power button to power on/off the aircraft. The power indicator glows solid after the aircraft is powered on.

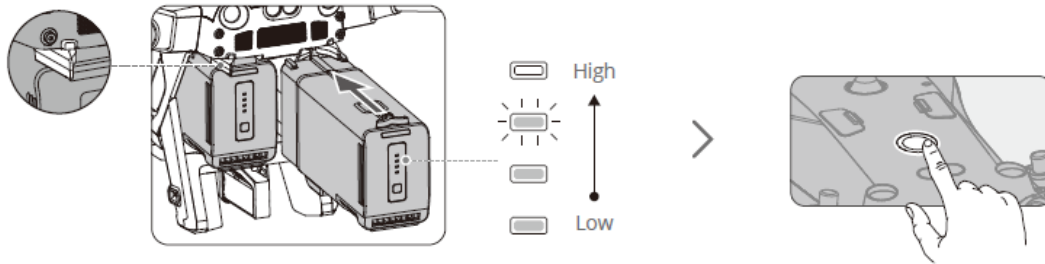

	<ul style="list-style-type: none"> <li>• Push the battery release toggles outward to remove TB30 batteries.</li> <li>• Make sure to push and hold the frame arm folding button and fold the arms in before transporting the aircraft separately.</li> <li>• When transporting the unpacked dock, make sure to remove the aircraft from the dock for separate transportation.</li> </ul>
---	---

## Linking to the Dock

	<ul style="list-style-type: none"> <li>• The aircraft and the dock require activation before use for the first time. An internet connection is required for the remote controller during activation.</li> <li>• When the dock is connecting to the remote controller and the dock cover is opening using DJI Pilot 2, make sure to keep a safe distance from the dock cover movement mechanism to avoid injury. Press any of the emergency stop buttons on the dock to stop the dock covers from opening, if necessary.</li> <li>• When the dock cover needs to be closed after the aircraft is placed in the dock, it is recommended to close the cover in the app or on FlightHub 2. Before closing the dock covers (including manual closing), make sure to move the two blades for each motor to be at 90° with each other in order to avoid breaking the propellers when closing the dock cover.</li> </ul>
---	--

1. Open the dock electrical cabinet door. Use the USB-C cable included in the Dock Bundle to connect the USB-C port of the remote controller to the USB-A port of the dock electrical cabinet.
2. Power on the remote controller, run DJI Pilot 2, and follow the prompts to complete the activation for the aircraft.
3. Make sure the driving rods on the landing pad are pulled back, the aircraft heading is consistent with the arrow mark  on the landing pad, and the aircraft is placed on the landing pad. Move the two blades for each motor to be at 90° with each other to complete the configuration, as shown in the diagram. Make sure to close the dock cover in the app.
4. Dock Onsite Debugging in DJI Pilot 2 provides the aircraft status and operations such as charging aircraft.

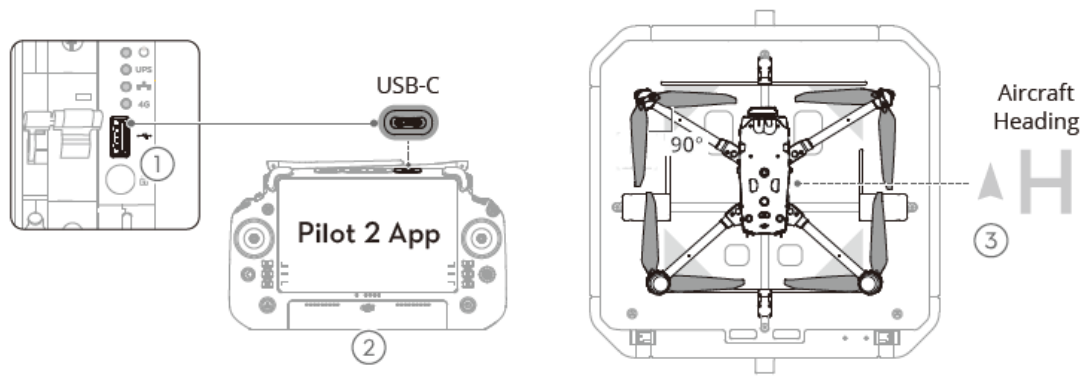

## Usage

Scan the QR code or go to the address to watch the tutorial videos and read the related manuals such as the Safety Guidelines, User Manual and Installation and Setup Manual. Make sure to understand the safety precautions and learn more aircraft information.



<https://www.dji.com/dock/video>



<https://www.dji.com/dock/downloads>

## Disclaimer and Warning

By using this product, you signify that you have read, understand, and accept the terms and conditions of this guideline and all instructions at [www.dji.com/dock](http://www.dji.com/dock).

EXCEPT AS EXPRESSLY PROVIDED IN AFTER-SALES SERVICE POLICIES AVAILABLE AT [HTTPS://WWW.DJI.COM/SERVICE/POLICY](https://www.dji.com/service/policy), THE PRODUCT AND ALL MATERIALS AND CONTENT AVAILABLE THROUGH THE PRODUCT ARE PROVIDED "AS IS" AND ON "AS AVAILABLE BASIS" WITHOUT WARRANTY OR CONDITION OF ANY KIND. This product is not intended for children.

## Specifications

Operating Temperature	-20° to 50° C (-4° to 122° F)
Video Transmission System	O3 Enterprise
Operating Frequency	2.4000-2.4835 GHz, 5.170-5.250 GHz; 5.725-5.850 GHz

Transmitter Power (EIRP)	2.4 GHz: < 23 dBm (FCC), < 20 dBm (CE/SRRC/MIC) 5.1 GHz: < 23 dBm (FCC/CE/SRRC/MIC) 5.8 GHz: < 23 dBm (FCC/SRRC), < 14 dBm (CE)
Max Transmission Distance	15 km (FCC), 8 km (CE/SRRC/MIC)
Power Supply	Using external battery
Compatible Battery Model	TB30 Intelligent Flight Battery

### **FCC Compliance Notice**

Supplier's Declaration of Conformity

Product name: Matrice 30/Matrice 30T

Model Number: M30 RTK/M30T RTK

Responsible Party: DJI Research LLC

Responsible Party Address: 435 Portage Ave, Palo Alto, CA 94306

Website: [www.dji.com](http://www.dji.com)

We, DJI Technology, Inc., being the responsible party, declares that the above mentioned model was tested to demonstrate complying with all applicable FCC rules and regulations.

This device complies with Part 15 of the FCC Rules. Operation is subject to the following two conditions: (1) This device may not cause harmful interference, and (2) This device must accept any interference received, including interference that may cause undesired operation.

Any changes or modifications not expressly approved by the party responsible for compliance could void the user's authority to operate the equipment.

This equipment has been tested and found to comply with the limits for a Class B digital device, pursuant to part 15 of the FCC Rules. These limits are designed to provide reasonable protection against harmful interference in a residential installation. This equipment generates, uses and can radiate radio frequency energy and, if not installed and used in accordance with the instructions, may cause harmful interference to radio communications. However, there is no guarantee that interference will not occur in a particular installation. If this equipment does cause harmful interference to radio or television reception, which can be determined by turning the equipment off and on, the user is encouraged to try to correct the interference by one or more of the following measures:

- Reorient or relocate the receiving antenna.
- Increase the separation between the equipment and receiver.
- Connect the equipment into an outlet on a circuit different from that to which the receiver is connected.
- Consult the dealer or an experienced radio/TV technician for help.

### **RF Exposure Information**

The aircraft complies with FCC radiation exposure limits set forth for an uncontrolled environment. In order to avoid the possibility of exceeding the FCC radio frequency exposure limits, human proximity to the antenna shall not be less than 20cm during normal operation. This transmitter must not be co-located or operating in conjunction with any other antenna or transmitter.

**ISED Compliance Notice**

This device contains licence-exempt transmitter(s)/receiver(s) that comply with Innovation, Science and Economic Development Canada’s licence-exempt RSS(s). Operation is subject to the following two conditions: (1)This device may not cause interference.(2)This device must accept any interference, including interference that may cause undesired operation of the device.

L’émetteur/récepteur exempt de licence contenu dans le présent appareil est conforme aux CNR d’Innovation, Sciences et Développement économique Canada applicables aux appareils radio exempts de licence. L’exploitation est autorisée aux deux conditions suivantes :(1)L’appareil ne doit pas produire de brouillage; (2)L’appareil doit accepter tout brouillage radioélectrique subi, même si le brouillage est susceptible d’en compromettre le fonctionnement.

This equipment complies with RSS-102 radiation exposure limits set forth for an uncontrolled environment. This equipment should be installed and operated with minimum distance 20cm between the radiator and your body. This transmitter must not be co-located or operating in conjunction with any other antenna or transmitter.

Cet équipement est conforme aux limites d'exposition aux radiations CNR-102 établies pour un environnement non contrôlé. Cet équipement doit être installé et utilisé avec une distance minimale de 20 cm entre le radiateur et votre corps.

部件名称	有害物质					
	铅 (Pb)	汞 (Hg)	镉 (Cd)	六价铬 (Cr <sup>+6</sup> )	多溴联苯 (PBB)	多溴二苯醚 (PBDE)
线路板	×	○	○	○	○	○
外壳	×	○	○	○	○	○
金属部件 (铜合金)	×	○	○	○	○	○
内部线材	×	○	○	○	○	○
其他配件	×	○	○	○	○	○

本表格依据SJ/T 11364 的规定编制。  
 ○：表示该有害物质在该部件所有均质材料中的含量均在GB/T 26572 规定的限量要求以下。  
 ×：表示该有害物质至少在该部件的某一均质材料中的含量超出GB/T 26572 规定的限量要求。  
 (产品符合欧盟ROHS指令环保要求)



**KCC Compliance Notice**

“해당무선설비는 운용 중 전파혼신 가능성이 있으므로 인명안전과 관련된 서비스는 할 수 없습니다.”

“해당 무선설비는 운용 중 전파혼신 가능성이 있음”



**EU Compliance Statement:** SZ DJI TECHNOLOGY CO., LTD. hereby declares that this device (Matrice 30/Matrice 30T) is in compliance with the essential requirements and other relevant provisions of the Directive 2014/53/EU.

A copy of the EU Declaration of Conformity is available online at [www.dji.com/euro-compliance](http://www.dji.com/euro-compliance)

EU contact address: DJI GmbH, Industriestrasse 12, 97618, Niederlauer, Germany

**GB Compliance Statement:** SZ DJI TECHNOLOGY CO., LTD. hereby declares that this device (Matrice 30/Matrice 30T) is in compliance with the essential requirements and other relevant provisions of Radio Equipment Regulations 2017.

A copy of the GB Declaration of Conformity is available online at [www.dji.com/euro-compliance](http://www.dji.com/euro-compliance)

**Declaración de cumplimiento UE:** SZ DJI TECHNOLOGY CO., LTD. por la presente declara que este dispositivo (Matrice 30/Matrice 30T) cumple los requisitos básicos y el resto de provisiones relevantes de la Directiva 2014/53/EU.

Hay disponible online una copia de la Declaración de conformidad UE en [www.dji.com/euro-compliance](http://www.dji.com/euro-compliance)

Dirección de contacto de la UE: DJI GmbH, Industriestrasse 12, 97618, Niederlauer, Germany

**EU-verklaring van overeenstemming:** SZ DJI TECHNOLOGY CO., LTD. verklaart hierbij dat dit apparaat (Matrice 30/Matrice 30T) voldoet aan de essentiële vereisten en andere relevante bepalingen van Richtlijn 2014/53/EU.

De EU-verklaring van overeenstemming is online beschikbaar op [www.dji.com/euro-compliance](http://www.dji.com/euro-compliance)

Contactadres EU: DJI GmbH, Industriestrasse 12, 97618, Niederlauer, Germany

**Declaração de conformidade da UE:** A SZ DJI TECHNOLOGY CO., LTD. declara, através deste documento, que este dispositivo (Matrice 30/Matrice 30T) está em conformidade com os requisitos essenciais e outras disposições relevantes da Diretiva 2014/53/EU.

Existe uma cópia da Declaração de conformidade da UE disponível online em [www.dji.com/euro-compliance](http://www.dji.com/euro-compliance)

Endereço de contacto na UE: DJI GmbH, Industriestrasse 12, 97618, Niederlauer, Germany

**Dichiarazione di conformità UE:** SZ DJI TECHNOLOGY CO., LTD. dichiara che il presente dispositivo (Matrice 30/Matrice 30T) è conforme ai requisiti essenziali e alle altre disposizioni rilevanti della direttiva 2014/53/EU.

Una copia della dichiarazione di conformità UE è disponibile online all'indirizzo Web

[www.dji.com/euro-compliance](http://www.dji.com/euro-compliance)

Indirizzo di contatto UE: DJI GmbH, Industriestrasse 12, 97618, Niederlauer, Germany

**Déclaration de conformité UE** : Par la présente, SZ DJI TECHNOLOGY CO., LTD déclare que cet appareil (Matrice 30/Matrice 30T) est conforme aux principales exigences et autres clauses pertinentes de la directive européenne 2014/53/EU.

Une copie de la déclaration de conformité UE est disponible sur le site [www.dji.com/euro-compliance](http://www.dji.com/euro-compliance)

Adresse de contact pour l'UE : DJI GmbH, Industriestrasse 12, 97618, Niederlauer, Germany

**EU-Compliance:** Hiermit erklärt SZ DJI TECHNOLOGY CO., LTD., dass dieses Gerät (Matrice 30/Matrice 30T) den wesentlichen Anforderungen und anderen einschlägigen Bestimmungen der EU-Richtlinie 2014/53/EU entspricht.

Eine Kopie der EU-Konformitätserklärung finden Sie online auf [www.dji.com/euro-compliance](http://www.dji.com/euro-compliance)

Kontaktadresse innerhalb der EU: DJI GmbH, Industriestrasse 12, 97618, Niederlauer, Germany

**Декларация за съответствие на ЕС:** SZ DJI TECHNOLOGY CO., LTD. декларира, че това устройство (Matrice 30/Matrice 30T) отговаря на основните изисквания и другите приложими разпоредби на Директива 2014/53/ЕС.

Копие от Декларацията за съответствие на ЕС ще намерите онлайн на адрес [www.dji.com/euro-compliance](http://www.dji.com/euro-compliance)

Адрес за контакт за ЕС: DJI GmbH, Industriestrasse 12, 97618, Niederlauer, Германия

**Prohlášení o shodě pro EU:** Společnost SZ DJI TECHNOLOGY CO., LTD. tímto prohlašuje, že tohle zařízení (Matrice 30/Matrice 30T) vyhovuje základním požadavkům a dalším příslušným ustanovením směrnice 2014/53/EU.

Kopie prohlášení o shodě pro EU je k dispozici on-line na webu [www.dji.com/euro-compliance](http://www.dji.com/euro-compliance)

Kontaktní adresa v EU: DJI GmbH, Industriestrasse 12, 97618, Niederlauer, Německo

**EU-overensstemmelseserklæring:** SZ DJI TECHNOLOGY CO., LTD. erklærer hermed, at denne enhed (Matrice 30/Matrice 30T) er i overensstemmelse med de væsentlige krav og andre relevante bestemmelser i direktiv 2014/53/EU.

Der er en kopi af EU-overensstemmelseserklæringen tilgængelig online på [www.dji.com/euro-compliance](http://www.dji.com/euro-compliance)

EU-kontaktadresse: DJI GmbH, Industriestrasse 12, 97618, Niederlauer, Tyskland

**Δήλωση Συμμόρφωσης ΕΕ:** Η SZ DJI TECHNOLOGY CO., LTD. δια του παρόντος δηλώνει ότι η συσκευή (Matrice 30/Matrice 30T) αυτή συμμορφώνεται με τις βασικές απαιτήσεις και άλλες σχετικές διατάξεις της Οδηγίας 2014/53/ΕΕ.

Αντίγραφο της Δήλωσης Συμμόρφωσης ΕΕ διατίθεται ηλεκτρονικά στη διεύθυνση [www.dji.com/euro-compliance](http://www.dji.com/euro-compliance)



Διεύθυνση επικοινωνίας στην ΕΕ: DJI GmbH, Industriestrasse  
12, 97618, Niederlauer, Γερμανία

**ELi vastavuskinnitus** Käesolevaga teatab *SZ DJI TECHNOLOGY CO., LTD.*, et see seade (Matrice 30/Matrice 30T) on kooskõlas direktiivi 2014/53/EL oluliste nõuete ja muude asjakohaste sätetega.

ELi vastavusdeklaratsiooni koopia on kättesaadav veebis aadressil [www.dji.com/euro-compliance](http://www.dji.com/euro-compliance)

Kontaktaadress ELis: DJI GmbH, Industriestrasse 12, 97618, Niederlauer, Saksamaa

**Pranešimas dėl atitikties ES reikalavimams** Bendrovė „*SZ DJI TECHNOLOGY CO., LTD.*“ tvirtina, kad šis prietaisas (Matrice 30/Matrice 30T) atitinka pagrindinius 2014/53/ES direktyvos reikalavimus ir kitas susijusias nuostatas.

ES atitikties deklaracijos kopiją galite rasti adresu [www.dji.com/euro-compliance](http://www.dji.com/euro-compliance)

ES kontaktinis adresas: „DJI GmbH“, Industriestrasse 12, 97618, Niederlauer, Germany (Vokietija)

**ES atbilstības paziņojums:** *SZ DJI TECHNOLOGY CO., LTD.* ar šo apliecina, ka šī ierīce (Matrice 30/Matrice 30T) atbilst direktīvas 2014/53/ES pamatprasībām un pārējiem būtiskiem nosacījumiem.

ES atbilstības deklarācijas kopija pieejama tiešsaistē vietnē [www.dji.com/euro-compliance](http://www.dji.com/euro-compliance)

ES kontaktadrese: DJI GmbH, Industriestrasse 12, 97618, Niederlauer, Vācija

**EU:n vaatimustenmukaisuusvakuutus:** *SZ DJI TECHNOLOGY CO., LTD.* ilmoittaa täten, että tämä laite (Matrice 30/Matrice 30T) on direktiivin 2014/53/EU olennaisten vaatimusten ja sen muiden asiaankuuluvien ehtojen mukainen.

Kopio EU:n vaatimustenmukaisuusvakuutuksesta on saatavana verkossa osoitteessa [www.dji.com/euro-compliance](http://www.dji.com/euro-compliance)

Yhteystiedot EU:ssa: DJI GmbH, Industriestrasse 12, 97618, Niederlauer, Germany

**RÁITEAS Comhlíonta an AE:** Dearbhaíonn *SZ DJI TECHNOLOGY CO., LTD.* leis seo go bhfuil an gléas seo (Matrice 30/Matrice 30T) de réir na gceanglas riachtanach agus na bhforálacha ábhartha eile sa Treoir 2014/53/AE.

Tá coip de Dhearbhú Comhréireachta an AE ar fáil ar líne ag [www.dji.com/euro-compliance](http://www.dji.com/euro-compliance)

Seoladh teagmhála san AE: DJI GmbH, Industriestrasse 12, 97618, Niederlauer, Germany

**Dikjarazzjoni ta' Konformità tal-UE:** *SZ DJI TECHNOLOGY CO., LTD.* hawnhekk tiddikjara li dan l-apparat (Matrice 30/Matrice 30T) huwa konformi mar-rekwiziti essenzjali u ma' dispozizzjonijiet relevanti oħra tad-Direttiva 2014/53/UE.

Kopja tad-Dikjarazzjoni ta' Konformità tal-UE hija disponibbli onlajn fis-sit [www.dji.com/euro-compliance](http://www.dji.com/euro-compliance)

Indirizz ta' kuntatt tal-UE: DJI GmbH, Industriestrasse 12, 97618, Niederlauer, il-Ġermanja

**Declarația UE de conformitate:** Prin prezenta, *SZ DJI TECHNOLOGY CO., LTD.* declară

faptul că acest dispozitiv (Matrice 30/Matrice 30T) este conform cu cerințele esențiale și celelalte prevederi relevante ale Directivei 2014/53/UE.

Un exemplar al Declarației UE de conformitate este disponibil online, la adresa [www.dji.com/euro-compliance](http://www.dji.com/euro-compliance)

Adresa de contact pentru UE: DJI GmbH, Industriestrasse 12, 97618, Niederlauer, Germania

**Izjava EU o skladnosti:** Družba *SZ DJI TECHNOLOGY CO., LTD.* izjavlja, da ta naprava (Matrice 30/Matrice 30T) ustreza osnovnim zahtevam in drugim ustreznim določbam Direktive 2014/53/EU.

Kopija izjave EU o skladnosti je na voljo na spletu na [www.dji.com/euro-compliance](http://www.dji.com/euro-compliance)

Kontaktni naslov EU: DJI GmbH, Industriestrasse 12, 97618, Niederlauer, Nemčija

**EU Izjava o sukladnosti:** Tvrtka *SZ DJI TECHNOLOGY CO., LTD.* izjavljuje da je ovaj uređaj (Matrice 30/Matrice 30T) izrađen u skladu s osnovnim zahtjevima i ostalim relevantnim odredbama Direktive 2014/53/EU.

Kopija EU Izjave o sukladnosti dostupna je na mrežnoj stranici [www.dji.com/euro-compliance](http://www.dji.com/euro-compliance)

Adresa EU kontakta: DJI GmbH, Industriestrasse 12 97618, Niederlauer, Njemačka

**Vyhlasenie o zhode EÚ:** *SZ DJI TECHNOLOGY CO., LTD.* týmto vyhlasuje, že toto zariadenie (Matrice 30/Matrice 30T) je v zhode so základnými požiadavkami a ďalšími relevantnými ustanoveniami smernice 2014/53/EÚ.

Kópia tohto Vyhlásenia o zhode EÚ je k dispozícii online na [www.dji.com/euro-compliance](http://www.dji.com/euro-compliance)

Kontaktná adresa v EÚ: DJI GmbH, Industriestrasse 12, 97618, Niederlauer, Nemecko

**Deklaracja zgodności UE:** Firma *SZ DJI TECHNOLOGY CO., LTD.* niniejszym oświadcza, że przedmiotowe urządzenie (Matrice 30/Matrice 30T) jest zgodne z zasadniczymi wymogami i innymi stosownymi postanowieniami dyrektywy 2014/53/UE.

Kopię deklaracji zgodności UE można znaleźć w Internecie na stronie [www.dji.com/euro-compliance](http://www.dji.com/euro-compliance)

Adres do kontaktu w UE: DJI GmbH, Industriestrasse 12, 97618, Niederlauer, Niemcy

**EU megfeleléségi nyilatkozat:** A *SZ DJI TECHNOLOGY CO., LTD.* ezúton megerősíti, hogy ez az eszköz (Matrice 30/Matrice 30T) megfelel a 2014/53/EU Irányelv alapvető követelményeinek és más vonatkozó rendelkezéseinek.

Az EU megfeleléségi nyilatkozat másolata elérhető a [www.dji.com/euro-compliance](http://www.dji.com/euro-compliance) oldalon

EU kapcsolati cím: DJI GmbH, Industriestrasse 12, 97618, Niederlauer, Németország

**EU-försäkran om efterlevnad:** *SZ DJI TECHNOLOGY CO., LTD.* härmed förklarar att denna enhet (Matrice 30/Matrice 30T) uppfyller de väsentliga kraven och andra relevanta bestämmelser i direktivet 2014/53/EU.

En kopia av EU-försäkran om efterlevnad finns att tillgå online på adressen [www.dji.com/euro-compliance](http://www.dji.com/euro-compliance)

Kontaktadress EU: DJI GmbH, Industriestrasse 12, 97618, Niederlauer, Tyskland

**Yfirlýsing um fylgni við reglur ESB:** *SZ DJI TECHNOLOGY CO., LTD.* lýsir hér með yfir að þetta tæki (Matrice 30/Matrice 30T) hlíti mikilvægum kröfum og öðrum viðeigandi ákvæðum tilskipunar 2014/53/ESB.

Nálgast má eintak af ESB-samræmisyfirlýsingunni á netinu á [www.dji.com/euro-compliance](http://www.dji.com/euro-compliance)  
Heimilisfang ESB-tengiliðar: DJI GmbH, Industriestrasse 12, 97618, Niederlauer, Germany

**AB Uygunluk Beyanı:** *SZ DJI TECHNOLOGY CO., LTD.* bu belge ile bu cihazın (Matrice 30/Matrice 30T) temel gerekliliklere ve 2014/53/EU sayılı Direktifin diğer ilgili hükümlerine uygun olduğunu beyan eder.

AB Uygunluk Beyanının bir kopyasına [www.dji.com/euro-compliance](http://www.dji.com/euro-compliance) adresinden çevrim içi olarak ulaşılabilir

AB için iletişim adresi: DJI GmbH, Industriestrasse 12, 97618, Niederlauer, Almanya

**CAUTION: RISK OF EXPLOSION IF BATTERY IS REPLACED BY AN INCORRECT TYPE. DISPOSE OF USED BATTERIES ACCORDING TO THE INSTRUCTIONS**

#### **Environmentally friendly disposal**



Old electrical appliances must not be disposed of together with the residual waste, but have to be disposed of separately. The disposal at the communal collecting point via private persons is for free. The owner of old appliances is responsible to bring the appliances to these collecting points or to similar collection points. With this little personal effort, you contribute to recycle valuable raw materials and the treatment of toxic substances.

#### **Umweltfreundliche Entsorgung**

Dies ist das Symbol für die getrennte Sammlung von Elektro- und Elektronikgeräten. Elektroaltgeräte dürfen nicht zusammen mit dem Restmüll entsorgt werden (einschließlich Batterien, Akkus und Lampen), sondern müssen separat entsorgt werden. Die Entsorgung an der kommunalen Sammelstelle durch Privatpersonen oder an den von Händlern oder Herstellern eingerichteten Sammelstellen ist kostenlos. Der Besitzer von Altgeräten ist dafür verantwortlich, die persönlichen oder vertraulichen Daten auf den zu entsorgenden Altgeräten zu löschen und die Geräte zu diesen oder ähnlichen Sammelstellen zu bringen. Die Händler sind verpflichtet, Elektroaltgeräte für dich kostenlos zurückzunehmen. Durch diesen geringen Aufwand kannst du zur Wiederverwertung von wertvollen Rohmaterialien beitragen und dafür sorgen, dass umweltschädliche und giftige Substanzen ordnungsgemäß unschädlich gemacht werden.

#### **Tratamiento de residuos responsable con el medio ambiente**

Los aparatos eléctricos viejos no pueden desecharse junto con los residuos orgánicos, sino que deben ser desechados por separado. Existen puntos limpios donde los ciudadanos pueden dejar estos aparatos gratis. El propietario de los aparatos viejos es responsable de llevarlos a estos puntos limpios o similares puntos de recogida. Con este pequeño esfuerzo estás contribuyendo a reciclar valiosas materias primas y al tratamiento de residuos tóxicos.

### **Mise au rebut écologique**

Les appareils électriques usagés ne doivent pas être éliminés avec les déchets résiduels. Ils doivent être éliminés séparément. La mise au rebut au point de collecte municipal par l'intermédiaire de particuliers est gratuite. Il incombe au propriétaire des appareils usagés de les apporter à ces points de collecte ou à des points de collecte similaires. Avec ce petit effort personnel, vous contribuez au recyclage de matières premières précieuses et au traitement des substances toxiques.

### **Smaltimento ecologico**

I vecchi dispositivi elettrici non devono essere smaltiti insieme ai rifiuti residui, ma devono essere smaltiti separatamente. Lo smaltimento da parte di soggetti privati presso i punti di raccolta pubblici è gratis. È responsabilità del proprietario dei vecchi dispositivi portarli presso tali punti di raccolta o punti di raccolta analoghi. Grazie a questo piccolo impegno personale contribuirete al riciclo di materie prime preziose e al corretto trattamento di sostanze tossiche.

### **Milieuvriendelijk afvoeren**

Oude elektrische apparaten mogen niet worden weggegooid samen met het restafval, maar moeten afzonderlijk worden afgevoerd. Afvoeren via het gemeentelijke inzamelpunt is gratis voor particulieren. De eigenaar van oude toestellen is verantwoordelijk voor het inleveren van de apparaten op deze of vergelijkbare inzamelpunten. Met deze kleine persoonlijke inspanning lever je een bijdrage aan de recycling van waardevolle grondstoffen en de verwerking van giftige stoffen.

### **Eliminação ecológica**

Os aparelhos elétricos antigos não podem ser eliminados juntamente com os materiais residuais. Têm de ser eliminados separadamente. A eliminação no ponto de recolha público através de entidades particulares é gratuita. É da responsabilidade do proprietário de aparelhos antigos levá-los a estes pontos de recolha ou a pontos de recolha semelhantes. Com este pequeno esforço pessoal, contribui para a reciclagem de matérias-primas úteis e para o tratamento de substâncias tóxicas.

### **Изхвърляне с оглед опазване на околната среда**

Старите електрически уреди не трябва да се изхвърлят заедно с битовите отпадъци, а отделно. Изхвърлянето в общинския пункт за събиране на отпадъци от частни лица е безплатно. Собственикът на старите уреди е отговорен за пренасянето на уредите до тези или до подобни събирателни пунктове. С това малко собствено усилие допринасяте за рециклирането на ценни суровини и за обработката на токсични вещества.

### **Ekologicky šetrná likvidace**

Stará elektrická zařízení nesmějí být likvidována spolu se zbytkovým odpadem, ale musí být likvidována samostatně. Likvidace na komunálních sběrných místech prostřednictvím soukromých osob je bezplatná. Vlastník starých zařízení odpovídá za to, že je donese do těchto sběrných míst nebo na obdobná sběrná místa. Tímto můžete přispět k recyklaci hodnotných surovin a zpracování toxických látek.

### **Miljøvenlig bortskaffelse**

Gamle elektriske apparater må ikke bortskaffes sammen med restaffald, men skal bortskaffes separat. Bortskaffelse på et fælles indsamlingssted er gratis for privatpersoner. Ejere af gamle apparater er ansvarlige for at bringe apparater hen til disse indsamlingssteder eller til lignende indsamlingssteder. Med denne lille personlige indsats bidrager du til genanvendelse af værdifulde råvarer og behandlingen af giftige stoffer.

### **Απόρριψη φιλική προς το περιβάλλον**

Οι παλιές ηλεκτρικές συσκευές δεν πρέπει να απορρίπτονται μαζί με τα υπολειμματικά απόβλητα, αλλά ξεχωριστά. Η απόρριψη στο δημοτικό σημείο συλλογής μέσω ιδιωτών γίνεται χωρίς χρέωση. Ο κάτοχος παλιών συσκευών είναι υπεύθυνος για τη μεταφορά των συσκευών σε αυτά ή παρόμοια σημεία συλλογής. Μέσω της ατομικής σας προσπάθειας, συμβάλλετε στην ανακύκλωση πολύτιμων πρώτων υλών και την επεξεργασία των τοξικών ουσιών.

### **Keskkonnasäästlik kasutuselt kõrvaldamine**

Vanu elektriseadmeid ei tohi ära visata koos olmejäätmetega, vaid tuleb koguda ja kasutuselt kõrvaldada eraldi. Kohaliku omavalitsuse elektroonikaromude kogumispunktis on äraandmine eraisikutele tasuta. Vanade seadmete sellistesse või sarnastesse kogumispunktidesse toimetamise eest vastutavad seadmete omanikud. Selle väikese isikliku panusega aitate kaasa väärtusliku toorme ringlussevõtule ja mürgiste ainete töötlemisele.

### **Utilizavimas nekenkiant aplinkai**

Senų elektrinių prietaisų negalima išmesti kartu su buitinėmis atliekomis; juos būtina utilizuoti atskirai. Tokių prietaisų utilizavimas per komunalinius atliekų surinkimo punktus yra nemokamas. Elektrinių prietaisų savininkai utilizuojamus prietaisus privalo priduoti į atitinkamus arba analogiškus atliekų surinkimo punktus. Tokiu būdu, įdėdami nedaug pastangų, prisidėsite prie vertingų medžiagų perdirbimo ir aplinkos apsaugojimo nuo toksinių medžiagų.

### **Videi draudzīga atkritumu likvidēšana**

Vecas elektriskās ierīces nedrīkst likvidēt kopā ar pārējiem atkritumiem, bet tās jālikvidē atsevišķi. Privātpersonām atkritumu likvidēšana komunālajā savākšanas punktā ir bez maksas. Veco ierīču īpašnieks ir atbildīgs par ierīču nogādāšanu šajos savākšanas punktos vai līdzīgos savākšanas punktos. Ar šīm nelielām personiskajām pūlēm jūs veicināt vērtīgu izejmateriālu pārstrādi un toksisko vielu apstrādi.

### **Hävittäminen ympäristöystävällisesti**

Vanhoja sähkölaitteita ei saa hävittää kaatopaikkajätteen mukana, vaan ne on hävitettävä erikseen. Kunnalliseen keräyspisteeseen vieminen on yksityishenkilölle ilmaista. Vanhojen laitteiden omistaja vastaa laitteiden toimittamisesta kyseisiin keräyspisteisiin tai vastaaviin. Tällä vähäisellä henkilökohtaisella vaivalla edistät omalta osaltasi arvokkaiden raaka-aineiden kierrätystä ja myrkyllisten aineiden käsittelyä.

### **Díúscairt neamhdhíobhálach don chomhshaol**

Níor cheart seanghléasanna leictreacha a dhíúscairt leis an dramhaíl iarmharach, ach caithfear iad a chur de láimh astu féin. Tá an díúscairt ag an ionad bailiúcháin pobail ag daoine príobháideacha

saor in aisce. Tá freagracht ar úinéir seanghléasanna na gléasanna a thabhairt chuig na hionaid bhailiúcháin sin nó chuig ionaid bhailiúcháin den chineál céanna. Le hiarracht bheag phearsanta mar sin, cuidíonn tú le hamhábhair luachmhara a athchúrsáil agus le substaintí tocsaineacha a chóireáil

### **Rimi li jirrispetta l-ambjent**

L-apparat elettriku qadim ma għandux jintrema flimkien ma' skart residwu, izda għandu jintrema b'mod separat. Ir-rimi fil-post tal-ġbir komunali minn persuni privati huwa b'xejn. Is-sit ta' apparat qadim huwa responsabbli biex iġib l-apparat f'dawn il-postijiet tal-ġbir jew f'postijiet tal-ġbir simili. B'dan l-isforz personali žgħir, inti tikkontribwixxi għar-riċiklaġġ ta' materja prima prezzjuża u għat-trattament ta' sustanzi tossiċi.

### **Eliminarea ecologică**

Aparatele electrice vechi nu trebuie aruncate odată cu deșeurile reziduale, ci trebuie eliminate separat. Eliminarea în cadrul punctului de colectare local de către persoane fizice este gratuită. Proprietarii de aparate vechi sunt responsabili pentru transportul acestora la respectivele puncte de colectare sau la alte puncte de colectare similare. Prin acest efort personal nesemnificativ, puteți contribui la reciclarea materiilor prime valoroase și la tratarea substanțelor toxice.

### **Okolju prijazno odlaganje**

Starih električnih aparatov ne smete odvreči skupaj z ostanki odpadkov, temveč ločeno. Odlaganje na komunalnem zbirnem mestu je za fizične osebe brezplačno. Lastnik starih naprav je odgovoren, da jih pripelje do teh ali podobnih zbirnih mest. S tako malo osebne truda prispevate k recikliranju dragocenih surovin in obdelavi strupenih snovi.

### **Ekološko odlaganje**

Stari električni uređaji ne smiju se odlagati zajedno s kućnim otpadom, već ih treba odlagati odvojeno. Odlaganje na komunalnom sabirnom mjestu od strane privatnih osoba je besplatno. Vlasnik starih uređaja dužan je donijeti uređaje do tih sabirnih mjesta ili sličnih sabirnih mjesta. Ovim malim osobnim naporom doprinosite recikliranju vrijednih sirovina i pravilnoj obradi otrovnih tvari.

### **Ekologická likvidácia**

Staré elektrospotrebiče sa nesmú likvidovať spolu so zvyškovým odpadom, ale musia sa zlikvidovať samostatne. Likvidácia v komunálnom zbernom mieste prostredníctvom súkromných osôb je bezplatná. Majiteľ starých spotrebičov je zodpovedný za prinesenie spotrebičov na tieto zberné miesta alebo na podobné zberné miesta. Týmto malým osobným úsilím prispievate k recyklovaniu cenných surovín a spracovaniu toxických látok

### **Utylizacja przyjazna dla środowiska**

Nie można usuwać starych urządzeń elektrycznych wraz z pozostałymi odpadami. Wymagają one oddzielnej utylizacji. Utylizacja przez osoby prywatne w punkcie zbiórki odpadów komunalnych jest darmowa. Właściciel starych urządzeń jest odpowiedzialny za dostarczenie ich do takich lub podobnych punktów zbiórki. Zadając sobie tak niewielki trud, przyczyniasz się do recyklingu

cennych surowców i odpowiedniego postępowania z substancjami toksycznymi.

### **Környezetbarát hulladékkezelés**

A régi elektromos készülékeket nem szabad a nem szelektíven gyűjtött hulladékkal együtt kidobni, hanem a hulladékkezelésüket elkülönítve kell végezni. A közösségi gyűjtőpontokon a magánszemélyek ingyenesen leadhatják ezeket. A régi készülékek tulajdonosai felelnek azért, hogy a készülékeket ezekre a gyűjtőpontokra, vagy más gyűjtőpontokra elhozzák. Ezzel a kis személyes erőfeszítéssel Ön is hozzájárul az értékes nyersanyagok újrahasznosításához és a mérgező anyagok kezeléséhez.

### **Miljövämlig hantering av avfall**

Gamla elektriska apparater får inte kasseras tillsammans med restavfallet utan måste kasseras separat. Kassering på den lokala insamlingsplatsen för privatpersoner är gratis. Ägaren av gamla apparater ansvarar för att ta apparaterna till dessa insamlingsplatser eller till liknande insamlingsplatser. Med denna lilla personliga insats bidrar du till återvinning av värdefulla råvaror och hantering av giftiga ämnen.

### **Umhverfisvæn förgun**

Ekki má farga gömlum raftækjum með úrgangsléifum, heldur þarf að farga þeim sérstaklega. Förgun á almennum söfnunarstöðum er ókeypis fyrir einstaklinga. Eigandi gamalla tækja ber ábyrgð á að koma með tækin á þessa söfnunarstaði eða á svipaða söfnunarstaði. Með þessu litla persónulega átaki stuðlar þú að endurvinnslu verðmætra hráefna og meðferð eitrufna.

### **Çevre dostu bertaraf**

Eski elektrikli cihazlar, diğer atıklarla birlikte bertaraf edilmemeli, ayrıca atılmalıdır. Özel kişiler aracılığıyla genel toplama noktasına bertaraf işlemi ücretsiz olarak yapılmaktadır. Eski cihazların sahibi, cihazları bu toplama noktalarına veya benzer toplama noktalarına getirmekten sorumludur. Bu az miktardaki kişisel çabayla, değerli ham maddelerin geri dönüştürülmesine ve toksik maddelerin işleme alınmasına katkıda bulunmuş olursunuz.

### **Thailand Warning message**

เครื่องโทรคมนาคมและอุปกรณ์นี้ มีความสอดคล้องตามข้อกำหนดของ กทท.

### **Mexico Warning message**

“La operación de este equipo está sujeta a las siguientes dos condiciones: (1) es posible que este equipo o dispositivo no cause interferencia perjudicial y (2) este equipo o dispositivo debe aceptar cualquier interferencia, incluyendo la que pueda causar su operación no deseada.”

### **Brazil Warning message**

Informações sobre Reglamentação.

Este equipamento está certificado e homologado pela ANATEL.

Para maiores informações, consulte o site da ANATEL: [www.anatel.gov.br](http://www.anatel.gov.br).

Este equipamento não tem direito à proteção contra interferência prejudicial e não pode causar interferência em sistemas devidamente autorizados.

**EAC**



**INVISIBLE LASER RADIATION  
DO NOT EXPOSE USERS OF TELESCOPIC OPTICS  
CLASS 1M LASER PRODUCT**

IEC/EN 60825-1:2014. Complies with 21 CFR 1040.10 and 1040.11 except for conformance with IEC 60825-1 Ed. 3., as described in Laser Notice No. 56, dated May 8, 2019

This label is affixed to one side of the Matrice 30/Matrice 30T