

Mavic 2 Zoom Quick Start Guide

V1.0 2018.07

Aircraft (L1Z)

The DJI™ MAVIC™ 2 Pro features Omnidirectional Obstacle Sensing, an Infrared Sensing System*, and a fully stabilized 3-axis gimbal with a 1" CMOS sensor camera that shoots 4K video and 20-megapixel photos. DJI signature technologies such as Obstacle Avoidance and Intelligent Flight Modes like HyperLapse, ActiveTrack™ 2.0, QuickShot, Panorama, and Advanced Pilot Assistance Systems, help you capture complex shots effortlessly. The Mavic 2 Zoom boasts a maximum flight speed of 44.7 mph (72 kph) and a maximum flight time** of 31 minutes.

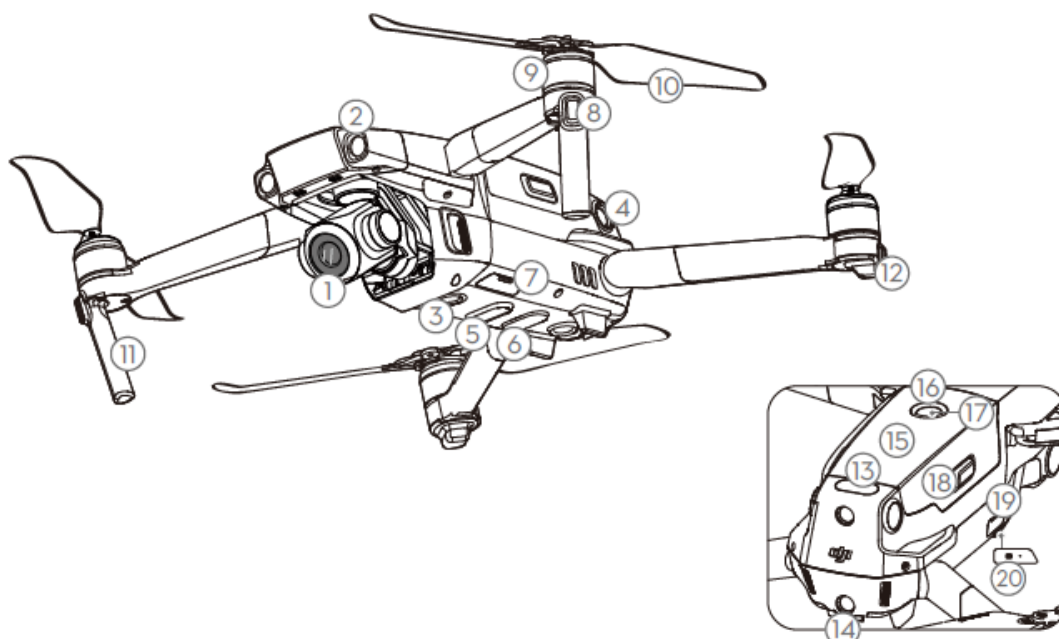

1. Gimbal and Camera
2. Forward Vision System
3. Downward Vision System
4. Lateral Vision System
5. Downward Infrared Sensing System
6. Fill Light
7. microSD Card Slot
8. Front LEDs
9. Motors
10. Propellers
11. Antennas
12. Aircraft Status Indicator

13. Upward Infrared Sensing System
14. Backward Vision System
15. Intelligent Flight Battery
16. Battery Level LEDs
17. Power Button
18. Battery Buckles
19. USB-C Port
20. Link Button/Linking Status Indicator

* The Vision Systems and Infrared Sensing Systems are affected by surrounding conditions. Read the Disclaimer and Safety Guidelines and watch the tutorial in the DJI GO™ 4 app or on the official DJI website to learn more. <http://www.dji.com/mavic-2>

** Maximum flight time was tested in an environment with no wind while flying at a consistent 15.5 mph (25 kph). This value is for reference only.

Remote Controller (RC1A)

Built into the remote controller is the DJI's long-range transmission technology OCUSSYNC™ 2.0, offering a maximum transmission range of 5 mi (8 km) and displaying video from the aircraft to the DJI GO 4 app on your mobile device at up to 1080p. An on-board LCD screen gives real-time aircraft data information and the detachable control sticks make the remote controller easier to store. Maximum run time: 2 hours and 15 minutes*

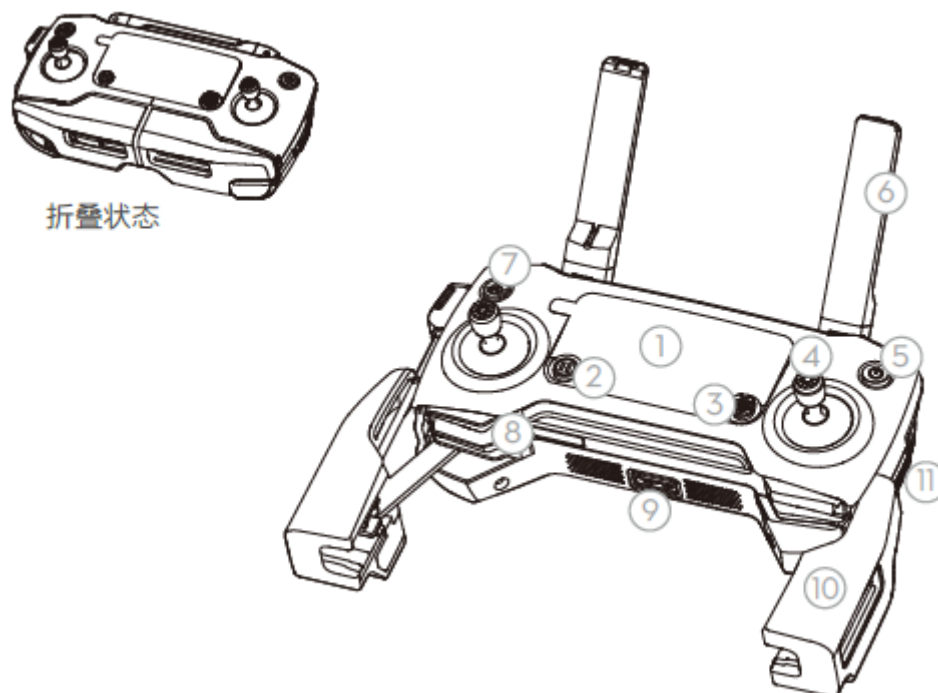

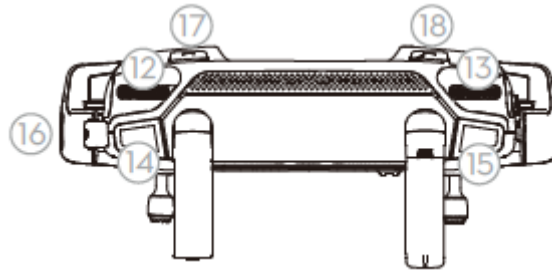

1. LCD Screen
2. Flight Pause Button
3. 5D Button
4. Control Sticks
5. Removable Power Button
6. Antennas
7. RTH Button
8. Control Sticks Storage Slot
9. Reserve Video-Downlink Port (USB)
10. Mobile Device Clamp
11. Flight Mode Switch
12. Gimbal Dial
13. Aperture/Shutter Adjustment Dial
14. Record Button
15. Focus/Shutter Button
16. Video-Downlink/Power Port (microUSB)
17. C1 Button (Customizable)
18. C2 Button (Customizable)

* The remote controller is able to reach its maximum transmission distance (FCC) in a wide-open area with no electromagnetic Interference at an altitude of about 400 ft (120 m).
The maximum runtime is tested in a laboratory environment. This value is for reference only.

Specifications

Aircraft

Weight	905 g
Max Speed	44.7 mph (72 kph) in Sport mode without wind
Max Service Ceiling Above Sea Level	19685 ft (6000 m)
Max Flight Time	31 minutes (0 wind while flying at a consistent 15.5 mph (25 kph))
Operating Temperature	14° to 104°F (-10° to 40°C)
GNSS	GPS + GLONASS

Operating Frequency	2.4-2.4835 GHz; 5.725-5.850 GHz
---------------------	---------------------------------

Gimbal

Controllable Range	Pitch: -90° to +30° Yaw: -90° to +90°
--------------------	--

Camera

Sensor	1/2.3" CMOS; Effective pixels: 12M
Lens	FOV: approx. 83° (24mm), approx. 48° (48mm) 35mm format equivalent: 24-48 mm Aperture: f/2.8 (24mm)-f/3.8 (48mm) Focus: 0.5 m to ∞
ISO Range	Video: 100-3200 Photo: 100-1600 (auto); 100-3200 (manual)
Electronic Shutter Speed	8-1/8000 s
Max Image Size	4000×3000
Still Photography Modes	Single shot Burst shooting: 3/5/7 frames Auto Exposure Bracketing (AEB): 3/5 bracketed frames at 0.7 EV Bias Interval
Video Recording Modes	4K: 3840×2160 24/25/30p 2.7K: 2688×1512 24/25/30/48/50/60p FHD: 1920×1080 24/25/30/48/50/60/120p
Video Storage Bitrate	100 Mbps
Photo	JPEG, DNG (RAW)
Video	MP4, MOV (MPEG-4 AVC/H.264, HEVC)
Supported SD Cards	microSD™ Max Capacity: 128 GB (UHS-I Speed Grade 3 rating required)

Remote Controller

Operating Frequency	2.4-2.4835 GHz; 5.725-5.850 GHz
Max Transmission Distance (Unobstructed and free of interference)	FCC: 8 km; CE: 5 km; SRRC: 5 km
Operating Temperature	32° to 104° F (0° to 40° C)
Battery	3950 mAh@ 3.83V

Operating Voltage	1800mA @ 3.83 V (when charging the mobile device)
Supported Mobile Device Size	Thickness supported: 6.5 - 8.5 mm, Max length: 160 mm Supported USB port types: Lightning, Micro USB (Type-B) USB-C

Charger

Voltage	17.6±0.1 V
Rated Power	60 W

Intelligent Flight Battery

Capacity	3850 mAh
Voltage	17.6 V (max) 15.4 V (typical)
Battery Type	LiPo
Energy	59.29 Wh
Net Weight	Approx. 297 g
Charging Temperature Range	41° to 104°F (5° to 40°C)
Max Charging Power	80 W

For more information, read the User Manual:

<http://www.dji.com/mavic-2>

※ This content is subject to change without prior notice.

Download the DJI GO 4 App and Watching Tutorial Videos

Search “DJI GO 4” in the App Store or Google Play or scan the QR code below to download the app on your mobile device.

Watch the tutorial videos at www.dji.com/mavic-2 or in DJI GO 4 by tapping the icon in the top right corner of your screen.



	DJI GO 4 is compatible with iOS 9.0 (or later) or Android 4.4 (or later).
---	---

Preparing the Aircraft

1. Remove the gimbal cover from the camera.



2. Match the propellers to motors.



白色标记

Marked



无标记

Unmarked

3. Press the propellers down firmly and rotate in the lock direction.



4. Unfold the front arms and the propellers.

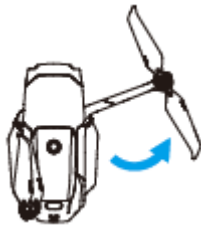

5. Unfold the rear arms and the propellers.

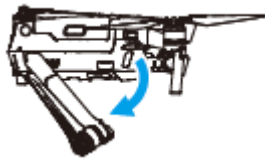

6. Unfolded



Unfold the front arms and the propellers before the rear ones. All arms and propellers must be unfolded before takeoff.

Charging the Batteries

Use the provided charger to fully charge the Intelligent Flight Battery before first use.

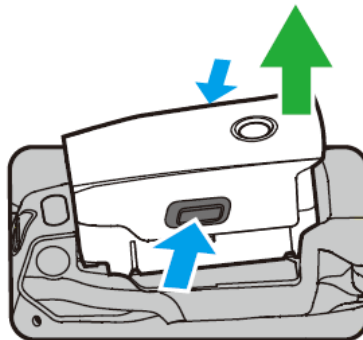

Remove the Intelligent Flight Battery

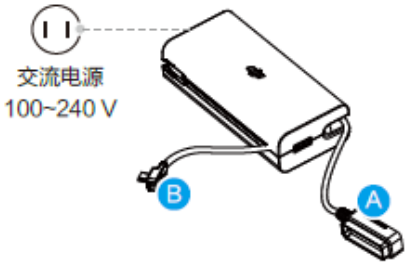
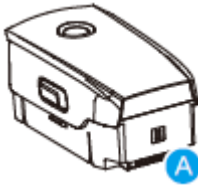
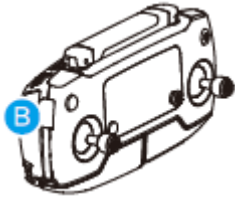
 <p>交流电源 100-240 V</p>		
	Charging Time: ~1 hour 30 minutes	Charging Time: ~2 hour 15 minutes

 Remove the remote controller cable before charging.

Checking the Battery Levels and Powering On/Off

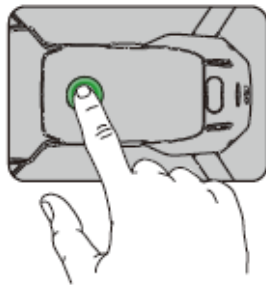

Press once to check the battery level.
Press, then press and hold to turn on/off.

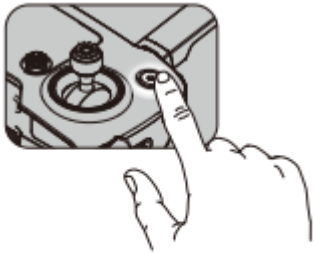

BAT 100 PCT

Press once to check the battery level on the LCD screen.
Press once, then press and hold to turn on/off the remote controller.

Preparing the Remote Controller

1. Unfold the antennas and mobile device clamps, then attach the control sticks.

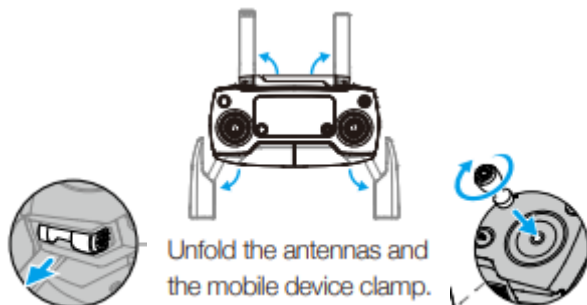

2. Place one end of the RC cable to the end of the slot.



3. Attach your mobile device within the clamps.

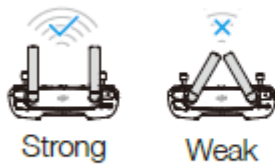
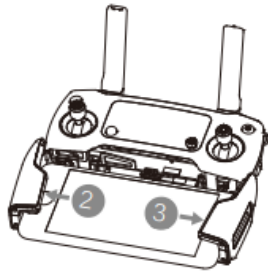

Set the antennas parallel to each other

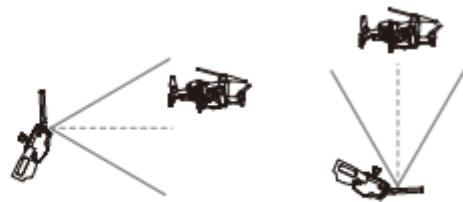

Optimal Transmission Range



- Ensure the control sticks are firmly mounted.
- The remote controller cable with the Lightning connector is mounted by default. Use the appropriate cable for your mobile device to connect to the remote controller. When using an iPad or tablet, use the USB port on the remote controller.
- Do not use the Micro USB and the USB ports simultaneously for linking video.

Preparing for Takeoff

1. Power on the remote controller



2. Power on the aircraft



3. Launch DJI GO 4



Use your DJI account to activate the aircraft. Activation requires an internet connection.

Flight

Before taking off, make sure the Aircraft Status Bar in DJI GO 4 displays “Ready to Go.”

Ready to Go (GPS)

- Auto Takeoff / Landing



Auto Takeoff



Auto Landing

- Manual Takeoff / Landing

Combination stick command to start/stop the motors



OR



Left stick up (slowly) to take off



Left stick down (slowly) until you touch the ground
Hold a few seconds to stop the motors



The motors can only be stopped mid-flight when the flight controller detects critical error.





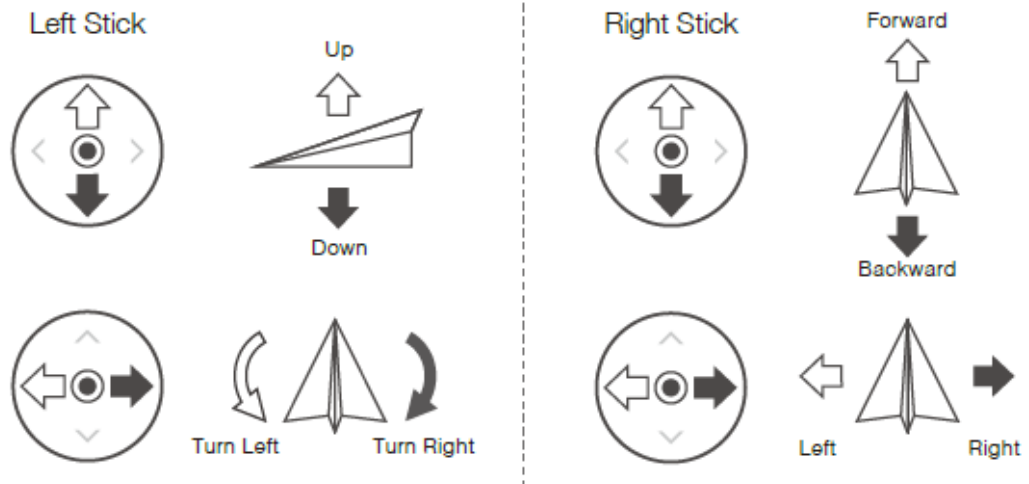



- **Remote Controller Operation**

The default flight control is known as Mode 2. The left stick controls the aircraft's altitude and heading, while the right stick controls its forward, backward, left and right movements. The gimbal dial controls the camera's tilt.



 Press the Flight Pause button for emergency braking during flight.

- **In DJI GO 4**

			
Normal	HyperLapse	QuickShot	ActiveTrack
			
Point of Interest	Waypoints	TapFly	Cinematic Mode



- Watch the tutorials in DJI GO 4 or at the official DJI website to learn more.
- Always set an appropriate RTH altitude before takeoff. When the aircraft is returning to the Home Point, you should guide it with the control sticks.

Fly Safe



Fly in Open Areas



Strong GPS Signal



Maintain Line of Sight

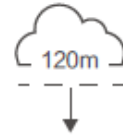

Fly Below 400 Feet (120 m)

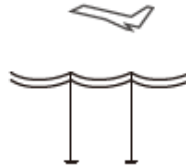

Avoid flying over or near obstacles, crowds, high voltage power lines, trees or bodies of water.

DO NOT fly near strong electromagnetic sources such as power lines and base stations as it may affect the onboard compass.

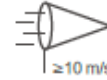

DO NOT use the aircraft in adverse weather conditions such as rain, snow, fog and wind speeds exceeding 10 m/s or 22 mph.



No Fly Zone

Stay away from the rotating propellers and motors.

Learn more at:
<http://flysafe.dji.com/no-fly>



It's important to understand basic flight guidelines, for the safety of both you and those around you. Don't forget to read the *Disclaimer and Safety Guidelines*.

Compliance Information

KCC Warning Message

“해당무선설비는 운용 중 전파혼신 가능성이 있으므로 인명안전과 관련된 서비스는 할 수 없습니다.”

“해당 무선설비는 운용 중 전파혼신 가능성이 있음”

NCC Warning Message

低功率電波輻射性電機管理辦法

第十二條 經型式認證合格之低功率射頻電機，非經許可，公司、商號或使用者均不得擅自變更頻率、加大功率或變更原設計之特性及功能。

第十四條 低功率射頻電機之使用不得影響飛航安全及干擾合法通信；經發現有干擾現象時，應改善至無干擾時方得繼續使用。前項合法通信，指依電信法規定作業之無線電通信。低功率射頻電機須忍受合法通信或工業、科學及醫療用電波輻射性電機設備之干擾。

EU Compliance Statement: SZ DJI TECHNOLOGY CO., LTD. hereby declares that this device is in compliance with the essential requirements and other relevant provisions of the Directive 2014/53/EU.

A copy of the EU Declaration of Conformity is available online at www.dji.com/euro-compliance

EU contact address: DJI GmbH, Industriestrasse. 12, 97618, Niederlauer, Germany

Declaración de cumplimiento UE: SZ DJI TECHNOLOGY CO., LTD. por la presente declara que este dispositivo cumple los requisitos básicos y el resto de provisiones relevantes de la Directiva 2014/53/EU.

Hay disponible online una copia de la Declaración de conformidad UE en www.dji.com/euro-compliance

Dirección de contacto de la UE: DJI GmbH, Industriestrasse. 12, 97618, Niederlauer, Germany

EU-verklaring van overeenstemming: SZ DJI TECHNOLOGY CO., LTD. verklaart hierbij dat dit apparaat voldoet aan de essentiële vereisten en andere relevante bepalingen van Richtlijn 2014/53/EU.

De EU-verklaring van overeenstemming is online beschikbaar op www.dji.com/euro-compliance

Contactadres EU: DJI GmbH, Industriestrasse. 12, 97618, Niederlauer, Germany

Declaração de conformidade da UE: A SZ DJI TECHNOLOGY CO., LTD. declara, através deste documento, que este dispositivo está em conformidade com os requisitos essenciais e outras disposições relevantes da Diretiva 2014/53/EU.

Existe uma cópia da Declaração de conformidade da UE disponível online em www.dji.com/euro-compliance

Endereço de contacto na UE: DJI GmbH, Industriestrasse. 12, 97618, Niederlauer, Germany

Dichiarazione di conformità UE: SZ DJI TECHNOLOGY CO., LTD. dichiara che il presente dispositivo

è conforme ai requisiti essenziali e alle altre disposizioni rilevanti della direttiva 2014/53/EU.
Una copia della dichiarazione di conformità UE è disponibile online all'indirizzo Web www.dji.com/euro-compliance

Indirizzo di contatto UE: DJI GmbH, Industriestrasse. 12, 97618, Niederlauer, Germany

Déclaration de conformité UE : Par la présente, SZ DJI TECHNOLOGY CO., LTD déclare que cet appareil est conforme aux principales exigences et autres clauses pertinentes de la directive européenne 2014/53/EU.

Une copie de la déclaration de conformité UE est disponible sur le site www.dji.com/euro-compliance

Adresse de contact pour l'UE : DJI GmbH, Industriestrasse. 12, 97618, Niederlauer, Germany

EU-Compliance: Hiermit erklärt SZ DJI TECHNOLOGY CO., LTD., dass dieses Gerät den wesentlichen Anforderungen und anderen einschlägigen Bestimmungen der EU-Richtlinie 2014/53/EU entspricht.

Eine Kopie der EU-Konformitätserklärung finden Sie online auf www.dji.com/euro-compliance.

Kontaktadresse innerhalb der EU: DJI GmbH, Industriestrasse. 12, 97618, Niederlauer, Germany



CAUTION: RISK OF EXPLOSION IF BATTERY IS REPLACED BY AN INCORRECT TYPE. DISPOSE OF USED BATTERIES ACCORDING TO THE INSTRUCTIONS

Environmentally friendly disposal



Old electrical appliances must not be disposed of together with the residual waste, but have to be disposed of separately. The disposal at the communal collecting point via private persons is for free. The owner of old appliances is responsible to bring the appliances to these collecting points or to similar collection points. With this little personal effort, you contribute to recycle valuable raw materials and the treatment of toxic substances.

Thailand Warning message

เครื่องโทรคมนาคมและอุปกรณ์นี้ มีความสอดคล้องตามข้อกำหนดของ กทช.

Mexico Warning message

“La operación de este equipo está sujeta a las siguientes dos condiciones: (1) es posible que este equipo o dispositivo no cause interferencia perjudicial y (2) este equipo o dispositivo debe aceptar cualquier interferencia, incluyendo la que pueda causar su operación no deseada.”

Brazil Warning message

Este equipamento opera em caráter secundário, isto é, não tem direito a proteção contra interferência prejudicial, mesmo de estações do mesmo tipo, e não pode causar interferência a sistemas operando em caráter primário.

ISED

This device contains licence-exempt transmitter(s)/receiver(s) that comply with Innovation, Science and Economic Development Canada's licence-exempt RSS(s). Operation is subject to the following two conditions: (1) This device may not cause interference. (2) This device must accept any interference, including interference that may cause undesired operation of the device.

L'émetteur/récepteur exempt de licence contenu dans le présent appareil est conforme aux CNR d'Innovation, Sciences et Développement économique Canada applicables aux appareils radio exempts de licence. L'exploitation est autorisée aux deux conditions suivantes : (1) L'appareil ne doit pas produire de brouillage; (2) L'appareil doit accepter tout brouillage radioélectrique subi, même si le brouillage est susceptible d'en compromettre le fonctionnement.

This equipment complies with ISED radiation exposure limits set forth for an uncontrolled environment. End user must follow the specific operating instructions for satisfying RF exposure compliance. This transmitter must not be co-located or operating in conjunction with any other antenna or transmitter. The portable device is designed to meet the requirements for exposure to radio waves established by the ISED. These requirements set a SAR limit of 4 W/kg averaged over 10 gram of tissue.

Cet équipement est conforme aux limites d'exposition aux rayonnements ISED établies pour un environnement non contrôlé. L'utilisateur final doit suivre les instructions spécifiques pour satisfaire les normes. Cet émetteur ne doit pas être co-implanté ou fonctionner en conjonction avec toute autre antenne ou transmetteur. Le dispositif portatif est conçu pour répondre aux exigences d'exposition aux ondes radio établie par le développement énergétique DURABLE. Ces exigences un SAR limite de 4 W/kg en moyenne pour 10 gramme de tissu.

FCC

changes or modifications not expressly approved by the party responsible for compliance could void the user's authority to operate the equipment.

This device complies with Part 15 of the FCC Rules. Operation is subject to the following two conditions: (1) this device may not cause harmful interference, and (2) this device must accept any interference received, including interference that may cause undesired operation.

This equipment has been tested and found to comply with the limits for a Class B digital device, pursuant to Part 15 of the FCC Rules. These limits are designed to provide reasonable protection against harmful interference in a residential installation. This equipment generates, uses and can radiate radio frequency energy and, if not installed and used in accordance with the instructions, may cause harmful interference to radio communications. However, there is no guarantee that interference will not occur in a particular installation.

If this equipment does cause harmful interference to radio or television reception, which can be determined by turning the equipment off and on, the user is encouraged to try to correct the

interference by one or more of the following measures:

- Reorient or relocate the receiving antenna.
- Increase the separation between the equipment and receiver.
- Connect the equipment into an outlet on a circuit different from that to which the receiver is connected.
- Consult the dealer or an experienced radio/TV technician for help.

This equipment complies with FCC radiation exposure limits set forth for an uncontrolled environment. End user must follow the specific operating instructions for satisfying RF exposure compliance. This transmitter must not be co-located or operating in conjunction with any other antenna or transmitter.

The portable device is designed to meet the requirements for exposure to radio waves established by the Federal Communications Commission (USA). These requirements set a SAR limit of 4 W/kg averaged over 10 gram of tissue.

For L1Z:

This equipment complies with FCC/ IC RSS - 102 radiation exposure limits set forth for an uncontrolled environment. This equipment should be installed and operated with minimum distance 20cm between the radiator and your body. This transmitter must not be co-located or operating in conjunction with any other antenna or transmitter.

Cet équipement est conforme aux limites d'exposition aux radiations FCC/ IC CNR - 102 établies pour un environnement non contrôlé. Cet équipement doit être installé et utilisé avec une distance minimale de 20 cm entre le radiateur et votre corps.