

MATRICE 200 V2

Quick Start Guide

v1.0



Matrice 200 V2

The DJI™ MATRICE™ 200 V2 (M200 V2) is a powerful industrial-grade flight platform with world-class agility and speed, redundant barometers and IMUs for maximum reliability, and smart flight features that make capturing complex shots easy. The aircraft's visual sensors* enable enhanced hovering precision even when flying indoors or in environments where GNSS is unavailable. The built-in AirSense makes you aware of your surrounding airspace to ensure flight safety. Its airframe design gives it an IP43 Ingress Protection Rating, in accordance with the global IEC 60529 standard. The mechanical design, along with quick-release landing gears and mounted folding arms, makes it easy to transport, store, and prepare for flight. The safety beacons on both the top and the bottom of the aircraft allow the aircraft to be identified at night or in low light conditions. An advanced power management system along with dual batteries ensures power supply and enhances flight safety. Without a payload, the M200 has a flight time of up to 38 minutes with standard batteries (TB55).

The Matrice 200 is compatible with many of DJI's DGC2.0 connector gimbals.* This manual uses the DJI ZENMUSE™ XT 2 as an example to demonstrate the Matrice 200's remarkable functions.

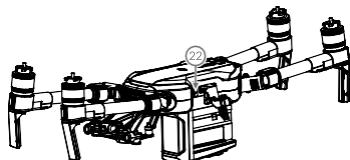
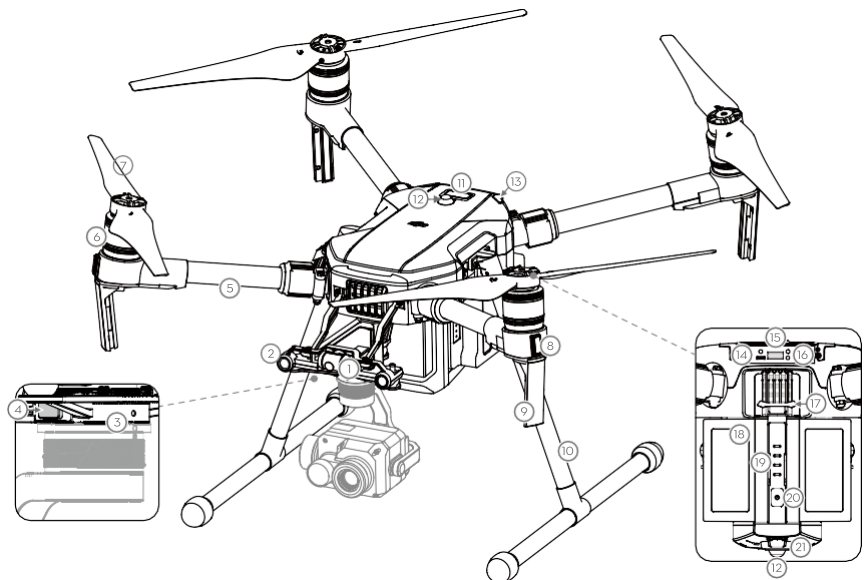

Folded

- | | |
|---------------------------------------|----------------------------------|
| 1. FPV Camera | 12. Beacons |
| 2. Forward Vision System | 13. Aircraft Status Indicators |
| 3. DJI Gimbal Connector V2.0 (DGC2.0) | 14. USB Mode Switch |
| 4. Gimbal and Camera Detach Button | 15. USB Port |
| 5. Frame Arms | 16. Linking Button and Indicator |
| 6. Motors | 17. Battery Remove Button |
| 7. Propellers | 18. Intelligent Flight Batteries |
| 8. ESC LEDs | 19. Battery Level Indicators |
| 9. Transmission Antennas | 20. Power Button |
| 10. Landing Gear | 21. Downward Vision System |
| 11. Upward Infrared Sensor | 22. microSD Card Slot |

* The Vision and Infrared Sensing Systems are affected by surrounding conditions. Read the Disclaimer and Safety Guidelines to learn more. Maximum run-time is tested in a lab environment. Performance may vary depending on local conditions. Gimbals can be purchased separately from the official DJI website. DO NOT disassemble the aircraft case, otherwise, it will not be covered by the warranty.

Cendence S Remote Controller

The Cendence™ S remote controller features DJI's OCUSYNC™ 2.0 technology for a maximum transmission distance of up to 4.3 mi (7 km).* While flying the aircraft, you have a live HD view directly within the DJI Pilot app on your paired device for a precise and responsive flying experience. Dual frequency* support makes the HD video downlink more stable. In Dual Remote Controller Mode, two remote controllers control the aircraft and camera separately, even when they are up to 656 feet (200 m) apart.

The remote controller works with a WB37 Intelligent Battery, which can be fully charged via the charging port in about 2 hours and 24 minutes with the standard charger, or with the Intelligent Battery Charging Hub* in about 1 hour and 11 minutes. The maximum run time of the remote controller is approximately 4 hours.*

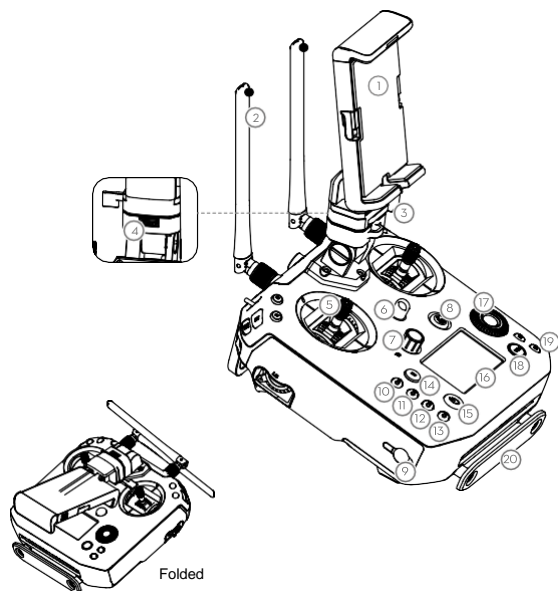

1. Mobile Device Holder
2. Antennas
3. Monitor Mounting Bracket
4. USB Port (Reserved Port)
5. Control Sticks
6. Strap Hook
7. Focal Adjustment Knob
8. Return-to-Home (RTH) Button
9. Power Port
10. EV Setting Button
11. Shutter Setting Button
12. Aperture Setting Button
13. ISO Setting Button
14. Pause Button
15. Power Button
16. Remote Control Display
17. Camera Settings Dial
18. Customizable Button Setting Menu
19. Customizable Buttons (BA-BH)
20. Support Rig
21. Left Lever
22. Left Dial (Gimbal Pitch)
23. Flight Mode Switch
24. Handle Bar
25. USB Port
- (for Mobile Device Connection)
26. HDMI A Port (for Video Output)

27. CAN Bus Port (Extension Port)
28. Micro USB Port
29. SDI Port (for Video Output)
30. Right Lever
31. Right Dial (Gimbal Pan)
32. AF Button (Autofocus)
33. Record Button
34. Shutter Button
35. Customizable Buttons (C1-C4)

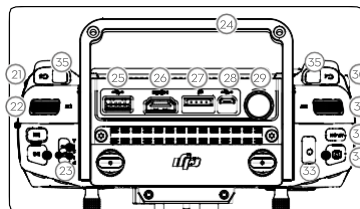

* The remote controller can reach its maximum transmission distance (FCC) in an unobstructed area with no electro-magnetic interference at an altitude of about 400 feet (120 meters). The actual maximum transmission distance may be less than the distance mentioned above due to interference in the operating environment, and the actual value will fluctuate according to the strength of interference.

To comply with local regulations, the 5.8 GHz frequency is not available in some countries and regions.

For more information about Dual Remote Controller mode, please refer to the user manual.

The Charging Hub can be purchased separately from the official DJI website.

Maximum run time is estimated in a lab environment without supplying power to a smart device or monitor, for reference only.

Using Matrice 200

1. Downloading the DJI Pilot App

Search for DJI Pilot in Google Play Store or scan the QR code below to download the app onto your mobile device.



DJI Pilot App



First-time activation requires your DJI account and an internet connection.



- DJI Pilot supports Android 4.4 or later.
- If using a DJI CrystalSky™ Monitor, it is recommended to use the built-in DJI Pilot app.

2. Charging the Batteries

- Press the release button and open the corresponding charging port cover.
- Insert the Intelligent Flight Battery into the charging port to begin charging. Be sure to press the release button when removing fully charged batteries.

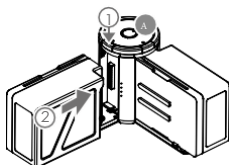

Using the IN2CH Charging Hub, charging time is approximately:
TB55: 2 hours and 33 min (two batteries)*

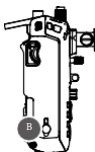

Charging Time:
2 hours and 24 min*

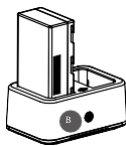

Using the WCH2 Charging Hub, charging time is approximately 1 hour and 11 min (one battery)*

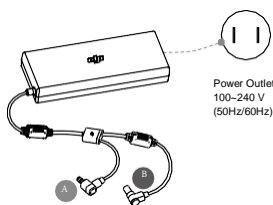

Power Outlet
100–240 V
(50Hz/60Hz)

*Provided charger



- When charging is complete, the LED lights on the Intelligent Flight Battery will turn off, and the LED on the Charging Hub will turn solid green.
- When charging is complete, the display on the remote controller will show 100%.
- The Charging Hub will sound an alert when the battery has been fully charged. The alert can be turned on or off by toggling the switch under the hub.
- Connect the Intelligent Flight Batteries to the aircraft and power them on. If battery temperature is lower than 15° C, the system will auto heat the batteries to maintain a temperature between 15° and 20° C.
- Ensure two Intelligent Flight Batteries are charged and discharged simultaneously to prolong their service life and for a better flight experience.

3. Preparing the Remote Controller

Mounting the Remote Controller Battery

Put the battery into the Battery Slot, then slide it to the end until you hear a click.

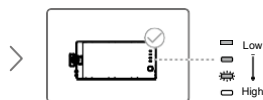
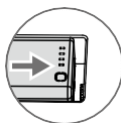

- Press the Battery Release Button before removing the battery.
- Press the Battery Level Button once to check the battery level.

Mounting the Monitor to the Remote Controller

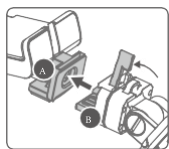

Ensure that Part B is unlocked. Connect Part B to Part A.

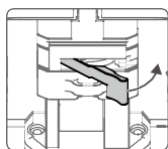

Lock the Mounting Bracket.

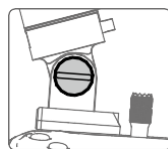

Use a coin or the screwdriver included to adjust the tightness of the tilt axis.

Connecting the Mobile Device

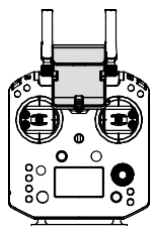

Press the button to release the clamp.

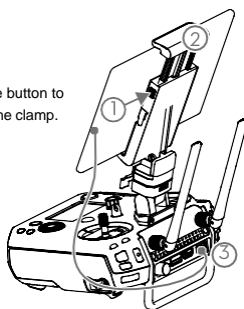

Place your mobile device and adjust the clamp to secure.

Connect your mobile device with a USB cable.

Using the Remote Controller

The Stick Mode is set to Mode 2 by default. In Mode 2, the left stick controls the aircraft's elevation and heading, and the right stick controls the aircraft's forward, backward, and lateral movements. To adjust the FPV camera, press and hold the C2 Button and rotate the left dial.

Left Stick

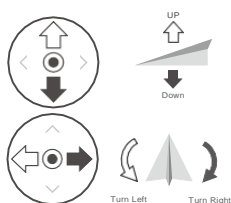

Right Stick

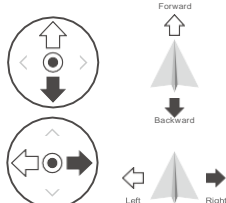

FPV Camera



- For more information about how to connect and use the remote controller, please refer to the user manual.
- You can change the stick mode and customize the C1-C4 and BA-BH buttons' functions in the DJI Pilot app.

4. Preparing the Aircraft

Mounting the Landing Gear

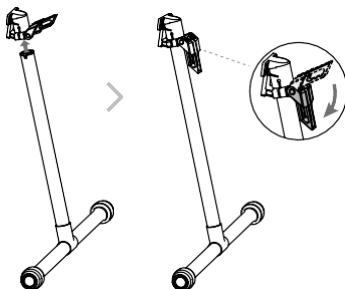

Unfolding the Aircraft

Unfold the frame arm, slide the arm lock to the end of the frame arm, and rotate it about 90° until the silver line lies within the range of the icon.

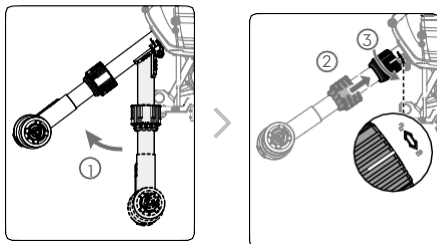

Mounting the Propellers

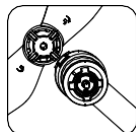

Propellers without silver rings should be installed on motors without marks.

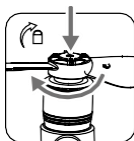

Press the propeller down onto the mounting plate and rotate in the lock direction until secure.

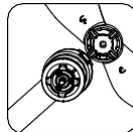

Propellers with silver rings should be installed on motors with the same color marks.

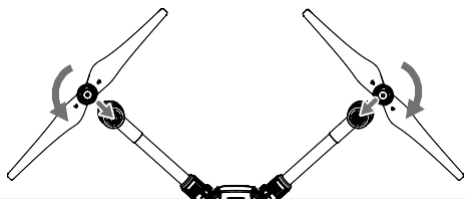

⚠ Check that the propellers are secure before each flight.

Mounting the Gimbal and Camera



Press the gimbal detach button to remove the cover.



Align the white and red dots and insert the gimbal.



Rotate the gimbal lock to the locked position.

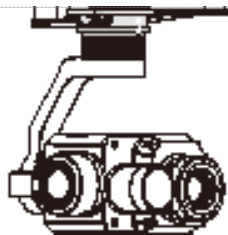

⚠ Make sure to press down the gimbal detach button when rotating the gimbal lock to remove the gimbal and camera. The gimbal lock should be fully rotated when removing the gimbal for the next installation.

Mounting the Intelligent Flight Batteries

Insert a pair of batteries.
Press once to check the battery level.
Press again and hold until the batteries turn on or off.

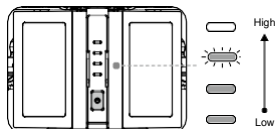
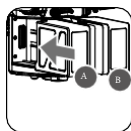

- ⚠️ Only use battery slot B when using one battery to supply power. In this case, the aircraft can only be powered on, but cannot take off. If for any reason only one battery is available during flight, land the aircraft immediately and replace the batteries as soon as possible.
- Make sure to press the Battery Removal button when removing the battery.
- Make sure to use the included TB55 batteries. TB50 batteries are not recommended as they may reduce the flight performance.

5. Flight



Toggle the Flight Mode switch to P-mode, the safest flight mode.

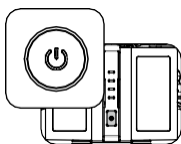

Power on the remote controller, and aircraft.



Launch the DJI Pilot app.

Ready to Go (GPS)

Before taking off, ensure that the Aircraft Status Bar in the DJI Pilot app reads 'Ready to Go (GPS)' or 'Ready to Go (Vision)' if flying indoors.

- ⚠️ If using a CrystalSky Monitor, after the monitor is powered on, wait for a pop-up window that asks for a selection of USB device use, and then select "DJI Pilot". Otherwise, the app cannot be connected to the remote controller.
- Always set an appropriate RTH altitude before takeoff. Refer to the Disclaimer and Safety Guidelines for more details.

Manual Takeoff



Combination Stick Command to start/stop the motors

Left stick up (slowly) to take off

Return-to-Home



Press and hold to initiate the RTH procedure. Press again to cancel.

- Rotating propellers can be dangerous. DO NOT start the motors in narrow spaces or when there are people nearby.
- Always keep your hands on the remote controller so long as the motor is still spinning.
- After landing, power off the aircraft before turning off the remote controller.

Manual Landing

Pull left stick down (slowly) until you touch the ground. Hold for a few seconds to stop the motors.



- ⚠️ To stop the motors mid-flight, press the RTH button while simultaneously pulling the left stick to the bottom inner corner. Stop motors mid-flight will cause the aircraft to crash. The motor can only be stopped mid-flight when the flight controller detects critical error.



It is important to understand basic flight guidelines for the safety of both you and those around you. Refer to the Disclaimer and Safety Guidelines for more information.



GEO Zones

Learn more:

<http://flysafe.dji.com/no-fly>

Specifications

■ Aircraft (M200 V2)	
Dimensions	Unfolded, propellers and landing gears included, 883x886x398 mm Folded, propellers and landing gears excluded, 722x282x242 mm
Diagonal Wheelbase	643 mm
Max Takeoff Weight	6.14 kg
Hovering Accuracy (P-mode with GPS)	Vertical: ± 1.64 feet (0.5 m) or ± 0.33 feet (0.1 m, Downward Vision System enabled) Horizontal: ± 4.92 feet (1.5 m) or ± 0.98 feet (0.3 m, Downward Vision System enabled)
Max Angular Velocity	Pitch: 300°/s, Yaw: 150°/s
Max Pitch Angle	S-mode: 35°; P-mode: 30° (Forward Vision System enabled: 25°); A-mode: 30°
Max Ascent Speed	16.4 ft/s (5 m/s)
Max Descent Speed (vertical)	9.8 ft/s (3 m/s)
Max Speed	S-mode/A-mode: 82.8 kph (51.4 mph); P-mode: 61.2 kph (38 mph)
Max Service Ceiling Above Sea Level	9842 feet (3000 m, with 1760S propellers)
Max Wind Resistance	39.4 ft/s (12 m/s)
Max Flight Time (with two TB55 batteries)	38 min (no payload), 24 min (takeoff weight: 6.14 kg)
Max Flight DJI Gimbals	Zenmuse X4S/X5S/X7/X7/X7/X7/Z30
Supported Gimbal Mounting	Single Gimbal, Downward
Ingress Protection Rating	IP43
GNSS	GPS+GLONASS
Operating Temperature	-4° to 122° F (-20° to 50° C)
■ Remote Controller (GL900A)	
Max Transmitting Distance (unobstructed, free of interference)	FCC: 5 mi (8 km); CE/MIC: 3.1 mi (5 km); SRRC: 3.1 mi (5 km)
Power Supply	Extended Intelligent Battery (Model: WB37-4920mAh-7.6V)
Output Power	13 W (Without supplying power to monitor)
USB Power Supply	iOS: 1 A 5.2 V (max); Android: 1.5 A 5.2 V (max)
Operating Temperature	-4° to 122° F (-20° to 50° C)
■ Downward Vision System	
Velocity Range	<32.8 ft/s (10 m/s) at the height of 6.56 feet (2 m)
Altitude Range	<32.8 feet (10 m)
Operating Range	<32.8 feet (10 m)
Operating Environment	Surfaces with clear patterns and adequate lighting (> 15 lux)
Ultrasonic Sensor Operating Range	0.33-16.4 feet (0.1-5 m)
Ultrasonic Sensor Operating Environment	Non-absorbing material, rigid surface (thick indoor carpeting will reduce performance)
■ Forward Vision System	
Obstacle Sensing Range	2.3-98.4 feet (0.7-30 m)
FOV	Horizontal: 60°; Vertical: 54°
Operating Environment	Surfaces with clear patterns and adequate lighting (> 15 lux)
■ Upward Infrared Sensing System	
Obstacle Sensing Range	0-16.4 feet (0-5 m)
FOV	$\pm 5^\circ$
Operating Environment	Large, diffuse and reflective obstacles (reflectivity >10%)
■ Intelligent Flight Battery (TB55-7660mAh-22.8V)	
Capacity	7660 mAh
Voltage	22.8 V
Battery Type	LiPo 6S
Energy	174.6 Wh
Net Weight (Single One)	Approx. 885 g
Operating Temperature	-4° to 122° F (-20° to 50° C)
Charging Temperature	41° to 104° F (5° to 40° C)
Max Charging Power	180 W
■ Charger (Model: IN2C180)	
Voltage	26.1 V
Rated Power	180 W
■ Charging Hub (Model: IN2CH)	
Input Voltage	26.1 V
Input Current	6.9 A



DJI incorporates HDMI™ technology.
The terms HDMI and HDMI High-Definition Multimedia Interface, and the HDMI Logo are trademarks or registered trademarks of HDMI Licensing LLC in the United States and other countries.

Download the latest version from

<http://www.dji.com/matrice-200-series-v2>

MATRICE and DJI are trademarks of DJI.

Copyright © 2017 DJI All Rights Reserved.

※ This content is subject to change without prior notice.

Printed in China.

FCC/ISED Compliance Notice

This device complies with Part 15 of the FCC Rules and ISED licence-exempt RSS standard. Operation is subject to the following two conditions: (1) This device may not cause harmful interference, and (2) This device must accept any interference received, including interference that may cause undesired operation.

Any changes or modifications not expressly approved by the party responsible for compliance could void the user's authority to operate the equipment.

Cet appareil est conforme à la section 15 du règlement de la FCC et à la norme RSS sans licence ISED. Son utilisation est soumise aux deux conditions suivantes: (1) Cet appareil ne doit pas causer d'interférences nuisibles et (2) Cet appareil doit accepter toutes les interférences reçues, y compris celles pouvant entraîner un fonctionnement indésirable.

Tout changement ou modification non expressément approuvé par la partie responsable de la conformité peut annuler l'autorité de l'utilisateur à utiliser l'équipement.

This device has been tested and found to comply with the limits for a Class B digital device, pursuant to Part 15 of the FCC Rules. These limits are designed to provide reasonable protection against harmful interference in a residential installation. This equipment generates, uses and can radiated radio frequency energy and, if not installed and used in accordance with the instructions, may cause harmful interference to radio communications.

However, there is no guarantee that interference will not occur in a particular installation. If this equipment does cause harmful interference to radio or television reception, which can be determined by turning the equipment off and on, the user is encouraged to try to correct the interference by one or more of the following measures:

- Reorient or relocate the receiving antenna.
- Increase the separation between the equipment and receiver.
- Connect the equipment into an outlet on a circuit different from that to which the receiver is connected.
- Consult the dealer or an experienced radio/TV technician for help.

Changes or modifications not expressly approved by the party responsible for compliance could void the user's authority to operate the equipment.

RF Exposure Information

Aircraft complies with FCC/ISED radiation exposure limits set forth for an uncontrolled environment. In order to avoid the possibility of exceeding the FCC/ISED radio frequency exposure limits, human proximity to the antenna shall not be less than 20cm during normal operation.

For Remote Controller (model GL900A), SAR tests are conducted using standard operating positions accepted by the FCC/ISED with the device transmitting at its highest certified power level in all tested frequency bands, although the SAR is determined at the highest certified power level, the actual SAR level of the device while operating can be well below the maximum value. Before a new model is available for sale to the public, it must be tested and certified to the FCC/ISED that it does not exceed the exposure limit established by the FCC/ISED. Tests for each product are performed in positions and locations as required by the FCC/ISED. For Handheld operation,

this device has been tested and meets the FCC/ISED RF exposure guidelines when used with an accessory designated for this product or when used with an accessory that contains no metal. For body worn operation, Remote Controller (model GL900A) has been tested and meets the FCC/ISED RF exposure guidelines when used with an accessory designated for this product or when used with an accessory that Contains no metal and that positions the handset a minimum of 10mm from the body.

Non-compliance with the above restrictions may result in violation of RF exposure guidelines.

Informations sur l'exposition RF

L'aéronef est conforme aux limites d'exposition aux rayonnements FCC / ISED établies pour un environnement non contrôlé. Afin d'éviter tout risque de dépassement des limites d'exposition aux radiofréquences FCC / ISED, la proximité humaine de l'antenne ne doit pas être inférieure à 20 cm en fonctionnement normal.

Pour le contrôleur à distance (modèle RC1B), les tests SAR sont effectués à l'aide de positions de fonctionnement standard acceptées par la FCC / ISED, le dispositif émettant à son niveau de puissance certifié le plus élevé dans toutes les bandes de fréquences testées, bien que le SAR soit déterminé au niveau de puissance certifié le plus élevé. Le niveau SAR réel de l'appareil en cours d'utilisation peut être bien inférieur à la valeur maximale. Avant qu'un nouveau modèle ne soit disponible à la vente au public, il doit être testé et certifié conforme par la FCC / ISED qu'il ne dépasse pas la limite d'exposition fixée par la FCC / ISED. Les tests de chaque produit sont effectués à requis par la FCC / ISED. Pour le fonctionnement en mode portatif, cet appareil a été testé et respecte les directives d'exposition RF de la FCC / ISED lorsqu'il est utilisé avec un accessoire conçu pour ce produit ou avec un accessoire ne contenant pas de métal.

Pour le fonctionnement porté sur le corps, la télécommande (modèle RC1B) a été testée et répond aux directives d'exposition RF de la FCC / ISED lorsqu'elle est utilisée avec un accessoire conçu pour ce produit.

Le non-respect des restrictions ci-dessus peut entraîner une violation des consignes d'exposition aux RF.

KCC Warning Message

“해당 무선설비는 운용 중 전파혼신 가능성이 있으므로 인명안전과 관련된 서비스는 할 수 없습니다.”

“해당 무선설비는 운용 중 전파혼신 가능성이 있음”

NCC Warning Message

低功率電波輻射性電機管理辦法

第十二條 經型式認證合格之低功率射頻電機，非經許可，公司、商號或使用者均不得擅自變更頻率、加大功率或變更原設計之特性及功能。

第十四條 低功率射頻電機之使用不得影響飛航安全及干擾合法通信；經發現有干擾現象時，應改善至無干擾時方得繼續使用。前項合法通信，指依電信法規定作業之無線電通信。低功率射頻電機須忍受合法通信或工業、科學及醫療用電波輻射性電機設備之干擾。

EU Compliance Statement: SZ DJI TECHNOLOGY CO., LTD. hereby declares that this device is in compliance with the essential requirements and other relevant provisions of the Directive 2014/53/EU.

A copy of the EU Declaration of Conformity is available online at www.dji.com/euro-compliance

EU contact address: DJI GmbH, Industriestrasse 12, 97618, Niederlauer, Germany

Declaración de cumplimiento UE: SZ DJI TECHNOLOGY CO., LTD. por la presente declara que este dispositivo cumple los requisitos básicos y el resto de provisiones relevantes de la Directiva 2014/53/EU.

Hay disponible online una copia de la Declaración de conformidad UE en www.dji.com/euro-compliance

Dirección de contacto de la UE: DJI GmbH, Industriestrasse 12, 97618, Niederlauer, Germany

EU-verklaring van overeenstemming: SZ DJI TECHNOLOGY CO., LTD. verklaart hierbij dat dit apparaat voldoet aan de essentiële vereisten en andere relevante bepalingen van Richtlijn 2014/53/EU.

De EU-verklaring van overeenstemming is online beschikbaar op www.dji.com/euro-compliance

Contactadres EU: DJI GmbH, Industriestrasse 12, 97618, Niederlauer, Germany

Declaração de conformidade da UE: A SZ DJI TECHNOLOGY CO., LTD. declara, através deste documento, que este dispositivo está em conformidade com os requisitos essenciais e outras disposições relevantes da Diretiva 2014/53/EU.

Existe uma cópia da Declaração de conformidade da UE disponível online em www.dji.com/euro-compliance

Endereço de contacto na UE: DJI GmbH, Industriestrasse 12, 97618, Niederlauer, Germany

Dichiarazione di conformità UE: SZ DJI TECHNOLOGY CO., LTD. dichiara che il presente dispositivo è conforme ai requisiti essenziali e alle altre disposizioni rilevanti della direttiva 2014/53/EU.

Una copia della dichiarazione di conformità UE è disponibile online all'indirizzo Web www.dji.com/euro-compliance

Indirizzo di contatto UE: DJI GmbH, Industriestrasse 12, 97618, Niederlauer, Germany

Déclaration de conformité UE : Par la présente, SZ DJI TECHNOLOGY CO., LTD déclare que cet appareil est conforme aux principales exigences et autres clauses pertinentes de la directive européenne 2014/53/EU.

Une copie de la déclaration de conformité UE est disponible sur le site www.dji.com/euro-compliance

Adresse de contact pour l'UE : DJI GmbH, Industriestrasse 12, 97618, Niederlauer, Germany

EU-Compliance: Hiermit erklärt SZ DJI TECHNOLOGY CO., LTD., dass dieses Gerät den wesentlichen Anforderungen und anderen einschlägigen Bestimmungen der EU-Richtlinie 2014/53/EU entspricht. Eine Kopie der EU-Konformitätserklärung finden Sie online auf www.dji.com/euro-compliance.

Kontaktadresse innerhalb der EU: DJI GmbH, Industriestrasse 12, 97618, Niederlauer, Germany



CAUTION: RISK OF EXPLOSION IF BATTERY IS REPLACED BY AN INCORRECT TYPE. DISPOSE OF USED BATTERIES ACCORDING TO THE INSTRUCTIONS

Environmentally friendly disposal



Old electrical appliances must not be disposed of together with the residual waste, but have to be disposed of separately. The disposal at the communal collecting point via private persons is for free. The owner of old appliances is responsible to bring the appliances to these collecting points or to similar collection points. With this little personal effort, you contribute to recycle valuable raw materials and the treatment of toxic substances.

Umweltfreundliche Entsorgung



Elektro-Altgeräte dürfen nicht mit gewöhnlichem Abfall entsorgt werden und müssen separat entsorgt werden. Die Entsorgung an kommunalen Sammelstellen ist für Privatpersonen kostenlos. Die Eigentümer der Altgeräte sind für den Transport zu den Sammelstellen verantwortlich. Durch diesen geringen Aufwand können Sie zur Wiederverwertung von wertvollen Rohmaterialien beitragen und dafür sorgen, dass umweltschädliche und giftige Substanzen ordnungsgemäß unschädlich gemacht werden.

Tratamiento de residuos responsable con el medio ambiente



Los aparatos eléctricos viejos no pueden desecharse junto con los residuos orgánicos, sino que deben ser desechados por separado. Existen puntos limpios donde los ciudadanos pueden dejar estos aparatos gratis. El propietario de los aparatos viejos es responsable de llevarlos a estos puntos limpios o similares puntos de recogida. Con este pequeño esfuerzo estás contribuyendo a reciclar valiosas materias primas y al tratamiento de residuos tóxicos.

Mise au rebut écologique



Les appareils électriques usagés ne doivent pas être éliminés avec les déchets résiduels. Ils doivent être éliminés séparément. La mise au rebut au point de collecte municipal par l'intermédiaire de particuliers est gratuite. Il incombe au propriétaire des appareils usagés de les apporter à ces points de collecte ou à des points de collecte similaires. Avec ce petit effort personnel, vous contribuez au recyclage de matières premières précieuses et au traitement des substances toxiques.

Smaltimento ecologico



I vecchi dispositivi elettrici non devono essere smaltiti insieme ai rifiuti residui, ma devono essere smaltiti separatamente. Lo smaltimento da parte di soggetti privati presso i punti di raccolta pubblici è gratis. È responsabilità del proprietario dei vecchi dispositivi portarli presso tali punti di raccolta o punti di raccolta analoghi. Grazie a questo piccolo impegno personale contribuirete al riciclo di materie prime preziose e al corretto trattamento di sostanze tossiche.

Milieuvriendelijk afvoeren



Oude elektrische apparaten mogen niet worden weggegooid samen met het restafval, maar moeten afzonderlijk worden afgevoerd. Afvoeren via het gemeentelijke inzamelpunt is gratis voor particulieren. De eigenaar van oude toestellen is verantwoordelijk voor het inleveren van de apparaten op deze of vergelijkbare inzamelpunten. Met deze kleine persoonlijke inspanning lever je een bijdrage aan de recycling van waardevolle grondstoffen en de verwerking van giftige stoffen.

Eliminação ecológica



Os aparelhos elétricos antigos não podem ser eliminados juntamente com os materiais residuais. Têm de ser eliminados separadamente. A eliminação no ponto de recolha público através de entidades particulares é gratuita. É da responsabilidade do proprietário de aparelhos antigos levá-los a estes pontos de recolha ou a pontos de recolha semelhantes. Com este pequeno esforço pessoal, contribui para a reciclagem de matérias-primas úteis e para o tratamento de substâncias tóxicas.