

# SAR EVALUATION REPORT

For

## SZ DJI TECHNOLOGY CO., LTD

14th floor, West Wing, Skyworth Semiconductor Design Building NO.18 Gaoxin South 4th Ave,  
Nanshan, Shenzhen, Guangdong, China

**FCC ID: SS3-GL300N1801**

<b>Report Type:</b> Original Report	<b>Product Name:</b> C1
<b>Report Number:</b> RDG180101012-20	
<b>Report Date:</b> 2018-03-02	
<b>Reviewed By:</b>	Rocky Xiao RF Engineer
<b>Prepared By:</b> Bay Area Compliance Laboratories Corp. (Dongguan) No.69 Pulongcun, Puxinhu Industry Area, Tangxia, Dongguan, Guangdong, China Tel: +86-769-86858888 Fax: +86-769-86858891 <a href="http://www.baclcorp.com.cn">www.baclcorp.com.cn</a>	

Attestation of Test Results			
<b>EUT Information</b>	<b>EUT Description</b>	C1	
	<b>Tested Model</b>	GL300N	
	<b>FCC ID</b>	SS3-GL300N1801	
	<b>Serial Number</b>	18010101220	
	<b>Test Date</b>	2018-02-26 ~ 2018-02-27	
<b>MODE</b>		<b>Max. SAR Level(s) Reported(W/kg)</b>	<b>Limit</b>
<b>SDR 2.4GHz</b>	10g Extremity SAR	<b>0.94</b>	<b>4.0 W/kg</b>
<b>Wi-Fi 2.4GHz</b>	10g Extremity SAR	0.06	
<b>SDR 5.8GHz</b>	10g Extremity SAR	0.85	
<b>Wi-Fi 5.8GHz</b>	10g Extremity SAR	0.18	
<b>Simultaneous</b>	10g Extremity SAR	<b>0.64</b>	
<b>SDR 2.4GHz</b>	1g Body SAR	0.33	<b>1.6 W/kg</b>
<b>Wi-Fi 2.4GHz</b>	1g Body SAR	0.10	
<b>SDR 5.8GHz</b>	1g Body SAR	0.81	
<b>Wi-Fi 5.8GHz</b>	1g Body SAR	0.21	
<b>Simultaneous</b>	1g Body SAR	<b>0.66</b>	
<b>Applicable Standards</b>	<b>FCC 47 CFR part 2.1093</b> Radiofrequency radiation exposure evaluation: portable devices		
	<b>IEEE1528:2013</b> IEEE Recommended Practice for Determining the Peak Spatial-Average Specific Absorption Rate (SAR) in the Human Head from Wireless Communications Devices: Measurement Techniques		
	<b>IEC 62209-2:2010</b> Human exposure to radio frequency fields from hand-held and body-mounted wireless communication devices-Human models, instrumentation, and procedures-Part 2: Procedure to determine the specific absorption rate (SAR) for wireless communication devices used in close proximity to the human body (frequency range of 30 MHz to 6 GHz)		
	<b>KDB procedures</b> KDB 447498 D01 General RF Exposure Guidance v06. KDB 865664 D01 SAR Measurement 100 MHz to 6 GHz v01r04 KDB 248227 D01 802 11 Wi-Fi SAR v02r02 KDB 865664 D02 RF Exposure Reporting v01r02 KDB 941225 D07 UMPC Mini Tablet v01r02		
<p><b>Note:</b> This wireless device has been shown to be capable of compliance for localized specific absorption rate (SAR) for General Population/Uncontrolled Exposure limits specified in <b>FCC 47 CFR part 2.1093</b> and has been tested in accordance with the measurement procedures specified in IEEE 1528-2013 and RF exposure KDB procedures.</p> <p><b>The results and statements contained in this report pertain only to the device(s) evaluated.</b></p>			

## TABLE OF CONTENTS

<b>DOCUMENT REVISION HISTORY .....</b>	<b>4</b>
<b>EUT DESCRIPTION .....</b>	<b>5</b>
TECHNICAL SPECIFICATION .....	5
<b>REFERENCE, STANDARDS, AND GUIDELINES.....</b>	<b>6</b>
SAR LIMITS .....	7
<b>FACILITIES.....</b>	<b>8</b>
<b>DESCRIPTION OF TEST SYSTEM .....</b>	<b>9</b>
<b>EQUIPMENT LIST AND CALIBRATION .....</b>	<b>14</b>
EQUIPMENTS LIST & CALIBRATION INFORMATION .....	14
<b>SAR MEASUREMENT SYSTEM VERIFICATION .....</b>	<b>15</b>
LIQUID VERIFICATION .....	15
SYSTEM ACCURACY VERIFICATION .....	16
<b>EUT TEST STRATEGY AND METHODOLOGY .....</b>	<b>19</b>
TEST POSITIONS FOR DEVICE OPERATING NEXT TO A PERSON’S EAR.....	19
CHEEK/TOUCH POSITION .....	20
EAR/TILT POSITION .....	20
TEST POSITIONS FOR BODY-WORN AND OTHER CONFIGURATIONS .....	21
TEST DISTANCE FOR SAR EVALUATION .....	21
SAR EVALUATION PROCEDURE.....	22
<b>CONDUCTED OUTPUT POWER MEASUREMENT .....</b>	<b>23</b>
TEST PROCEDURE .....	23
MAXIMUM TARGET OUTPUT POWER .....	23
TEST RESULTS: .....	25
<b>SAR EXCLUSION CONSIDERATIONS .....</b>	<b>27</b>
ANTENNAS LOCATION: .....	27
ANTENNA DISTANCE TO EDGE .....	27
SAR TEST EXCLUSION FOR THE EUT EDGE CONSIDERATIONS.....	28
<b>SAR MEASUREMENT RESULTS .....</b>	<b>29</b>
SAR TEST DATA.....	29
<b>SAR MEASUREMENT VARIABILITY .....</b>	<b>38</b>
<b>SAR SIMULTANEOUS TRANSMISSION DESCRIPTION .....</b>	<b>39</b>
<b>SAR PLOTS.....</b>	<b>41</b>
<b>APPENDIX A MEASUREMENT UNCERTAINTY .....</b>	<b>42</b>
<b>APPENDIX B CALIBRATION CERTIFICATES .....</b>	<b>44</b>
<b>APPENDIX C EUT TEST POSITION PHOTOS .....</b>	<b>45</b>

**DOCUMENT REVISION HISTORY**

---

<b>Revision Number</b>	<b>Report Number</b>	<b>Description of Revision</b>	<b>Date of Revision</b>
1.0	RDG180101012-20	Original Report	2018-03-02

## EUT DESCRIPTION

This report has been prepared on behalf of **SZ DJI TECHNOLOGY CO., LTD** and their product **CI**, Model: **GL300N**, FCC ID: **SS3-GL300N1801** or the EUT (Equipment under Test) as referred to in the rest of this report.

*All measurement and test data in this report was gathered from production sample serial number: 18010101220 (Assigned by BACL). The EUT was received on 2018-01-22.*

## Technical Specification

<b>Device Type:</b>	Portable
<b>Exposure Category:</b>	Population / Uncontrolled
<b>Antenna Type(s):</b>	External Antenna for SDR 2.4G/5.8G
	Internal Antenna for Wi-Fi 2.4G/5.8G
<b>Operation Mode :</b>	SDR 2.4G/SDR 5.8G, Wi-Fi 2.4/5.8G
<b>Accessories:</b>	None
<b>Frequency Band:</b>	SDR 2.4G: 2403.5~2477.5 MHz
	SDR 5.8G: 5728.5~5846.5 MHz
	Wi-Fi 2.4G: 2412~2462 MHz
	Wi-Fi 5.8G: 5745~5825 MHz
<b>Conducted RF Power:</b>	SDR 2.4G: 18.29 dBm
	SDR 5.8G: 19.46 dBm
	Wi-Fi 2.4G: 14.39 dBm
	Wi-Fi 5.8G: 13.12 dBm
<b>Dimensions (L*W*H):</b>	16.7 cm (L) × 20.0 cm (W) × 20.0 cm (H)
<b>Power Source:</b>	7.6 VDC Rechargeable Battery
<b>Normal Operation:</b>	Handheld and Close to Body

---

## REFERENCE, STANDARDS, AND GUIDELINES

---

### **FCC:**

The Report and Order requires routine SAR evaluation prior to equipment authorization of portable transmitter devices, including portable telephones. For consumer products, the applicable limit is 1.6 mW/g as recommended by the ANSI/IEEE standard C95.1-1992 [6] for an uncontrolled environment (Paragraph 65). According to the Supplement C of OET Bulletin 65 "Evaluating Compliance with FCC Guide-lines for Human Exposure to Radio frequency Electromagnetic Fields", released on Jun 29, 2001 by the FCC, the device should be evaluated at maximum output power (radiated from the antenna) under "worst-case" conditions for normal or intended use, incorporating normal antenna operating positions, device peak performance frequencies and positions for maximum RF energy coupling.

This report describes the methodology and results of experiments performed on wireless data terminal. The objective was to determine if there is RF radiation and if radiation is found, what is the extent of radiation with respect to safety limits. SAR (Specific Absorption Rate) is the measure of RF exposure determined by the amount of RF energy absorbed by human body (or its parts) – to determine how the RF energy couples to the body or head which is a primary health concern for body worn devices. The limit below which the exposure to RF is considered safe by regulatory bodies in North America is 1.6 mW/g average over 1 gram of tissue mass.

### **CE:**

The order requires routine SAR evaluation prior to equipment authorization of portable transmitter devices, including portable telephones. For consumer products, the applicable limit is 2 mW/g as recommended by EN62209-1 for an uncontrolled environment. According to the Standard, the device should be evaluated at maximum output power (radiated from the antenna) under "worst-case" conditions for normal or intended use, incorporating normal antenna operating positions, device peak performance frequencies and positions for maximum RF energy coupling.

This report describes the methodology and results of experiments performed on wireless data terminal. The objective was to determine if there is RF radiation and if radiation is found, what is the extent of radiation with respect to safety limits. SAR (Specific Absorption Rate) is the measure of RF exposure determined by the amount of RF energy absorbed by human body (or its parts) – to determine how the RF energy couples to the body or head which is a primary health concern for body worn devices. The limit below which the exposure to RF is considered safe by regulatory bodies in Europe is 2 mW/g average over 10 gram of tissue mass.

The test configurations were laid out on a specially designed test fixture to ensure the reproducibility of measurements. Each configuration was scanned for SAR. Analysis of each scan was carried out to characterize the above effects in the device.

**SAR Limits**

**FCC Limit**

EXPOSURE LIMITS	SAR (W/kg)	
	(General Population / Uncontrolled Exposure Environment)	(Occupational / Controlled Exposure Environment)
Spatial Average (averaged over the whole body)	0.08	0.4
Spatial Peak (averaged over any 1 g of tissue)	<b>1.60</b>	8.0
Spatial Peak (hands/wrists/feet/ankles averaged over 10 g)	<b>4.0</b>	20.0

**CE Limit**

EXPOSURE LIMITS	SAR (W/kg)	
	(General Population / Uncontrolled Exposure Environment)	(Occupational / Controlled Exposure Environment)
Spatial Average (averaged over the whole body)	0.08	0.4
Spatial Peak (averaged over any 10 g of tissue)	2.0	10
Spatial Peak (hands/wrists/feet/ankles averaged over 10 g)	4.0	20.0

Population/Uncontrolled Environments are defined as locations where there is the exposure of individual who have no knowledge or control of their exposure.

Occupational/Controlled Environments are defined as locations where there is exposure that may be incurred by people who are aware of the potential for exposure (i.e. as a result of employment or occupation).

General Population/Uncontrolled environments Spatial Peak limit 4.0W/kg for 10g Extremity SAR and 1.6W/kg for 1g Body SAR applied to the EUT.

## FACILITIES

---

The Test site used by Bay Area Compliance Laboratories Corp. (Dongguan) to collect test data is located on the No.69 Pulongcun, Puxinhu Industry Area, Tangxia, Dongguan, Guangdong, China

The test site has been approved by the FCC under the KDB 974614 D01 and is listed in the FCC Public Access Link (PAL) database, FCC Registration No. : 897218, the FCC Designation No. : CN1220.

The test site has been registered with ISED Canada under ISED Canada Registration Number 3062D.

The test sites and measurement facilities used to collect data are located at:

<input checked="" type="checkbox"/> SAR Lab 1	<input type="checkbox"/> SAR Lab 2
---	------------------------------------



## DESCRIPTION OF TEST SYSTEM

These measurements were performed with the automated near-field scanning system DASY5 from Schmid & Partner Engineering AG (SPEAG) which is the Fifth generation of the system shown in the figure hereinafter:



### DASY5 System Description

The DASY5 system for performing compliance tests consists of the following items:



- A standard high precision 6-axis robot with controller, teach pendant and software. An arm extension for accommodating the data acquisition electronics (DAE).
- An isotropic field probe optimized and calibrated for the targeted measurement.
- A data acquisition electronics (DAE) which performs the signal application, signal multiplexing, AD-conversion, offset measurements, mechanical surface detection, collision detection, etc. The unit is battery powered with standard or rechargeable batteries. The signal is optically transmitted to the EOC.
- The Electro-optical converter (EOC) performs the conversion from optical to electrical signals for the digital communication to the DAE. To use optical surface detection, a special version of the EOC is required. The EOC signal is transmitted to the measurement server.
- The function of the measurement server is to perform the time critical tasks such as signal filtering, control of the robot operation and fast movement interrupts.
- The Light Beam used is for probe alignment. This improves the (absolute) accuracy of the probe positioning.
- A computer running Win7 professional operating system and the DASY52 software.
- Remote control and teach pendant as well as additional circuitry for robot safety such as warning lamps, etc.
- The phantom, the device holder and other accessories according to the targeted measurement.

### **DASY5 Measurement Server**

The DASY5 measurement server is based on a PC/104 CPU board with a 400MHz Intel ULV Celeron, 128MB chip-disk and 128MB RAM. The necessary circuits for communication with the DAE4 (or DAE3) electronics box, as well as the 16 bit AD-converter system for optical detection and digital I/O interface are contained on the DASY5 I/O board, which is directly connected to the PC/104 bus of the CPU board.



The measurement server performs all real-time data evaluation of field measurements and surface detection, controls robot movements and handles safety operation. The PC operating system cannot interfere with these time critical processes. All connections are supervised by a watchdog, and disconnection of any of the cables to the measurement server will automatically disarm the robot and disable all program-controlled robot movements. Furthermore, the measurement server is equipped with an expansion port which is reserved for future applications. Please note that this expansion port does not have a standardized point out, and therefore only devices provided by SPEAG can be connected. Devices from any other supplier could seriously damage the measurement server.

### **Data Acquisition Electronics**

The data acquisition electronics (DAE4) consist of a highly sensitive electrometer-grade preamplifier with auto-zeroing, a channel and gain-switching multiplexer, a fast 16 bit AD-converter and a command decoder with a control logic unit. Transmission to the measurement server is accomplished through an optical downlink for data and status information, as well as an optical uplink for commands and the clock.

The mechanical probe mounting device includes two different sensor systems for frontal and sideways probe contacts. They are used for mechanical surface detection and probe collision detection.

The input impedance of both the DAE4 as well as of the DAE3 box is 200M $\Omega$ ; the inputs are symmetrical and floating. Common mode rejection is above 80 dB.

**EX3DV4 E-Field Probes**

<b>Frequency</b>	10 MHz to > 6 GHz Linearity: ± 0.2 dB (30 MHz to 6 GHz)
<b>Directivity</b>	± 0.3 dB in TSL (rotation around probe axis) ± 0.5 dB in TSL (rotation normal to probe axis)
<b>Dynamic Range</b>	10 µW/g to > 100 mW/g Linearity: ± 0.2 dB (noise: typically < 1 µW/g)
<b>Dimensions</b>	Overall length: 337 mm (Tip: 20 mm) Tip diameter: 2.5 mm (Body: 12 mm) Typical distance from probe tip to dipole centers: 1 mm
<b>Application</b>	High precision dosimetric measurements in any exposure scenario (e.g., very strong gradient fields); the only probe that enables compliance testing for frequencies up to 6 GHz with precision of better 30%.
<b>Compatibility</b>	DASY3, DASY4, DASY52 SAR and higher, EASY4/MRI

**SAM Twin Phantom**

The SAM twin phantom is a fiberglass shell phantom with 2mm shell thickness (except the ear region, where shell thickness

increases to 6 mm). The phantom has three measurement areas:

- \_ Left Head
- \_ Right Head
- \_ Flat phantom

The phantom table for the DASY systems based on the robots have the size of 100 x 50 x 85 cm (L x W x H). For easy dislocation these tables have fork lift cut outs at the bottom.

The bottom plate contains three pairs of bolts for locking the device holder. The device holder positions are adjusted to the standard measurement positions in the three sections. Only one device holder is necessary if two phantoms are used (e.g., for different liquids)



A white cover is provided to cover the phantom during off-periods to prevent water evaporation and changes in the liquid parameters. Free space scans of devices on top of this phantom cover are possible. Three reference marks are provided on the phantom counter. These reference marks are used to teach the absolute phantom position relative to the robot.

## Robots

The DASY5 system uses the high precision industrial robot. The robot offers the same features important for our application:

- High precision (repeatability 0.02mm)
- High reliability (industrial design)
- Low maintenance costs (virtually maintenance free due to direct drive gears; no belt drives)
- Jerk-free straight movements (brushless synchrony motors; no stepper motors)
- Low ELF interference (motor control fields shielded via the closed metallic construction shields)

The above mentioned robots are controlled by the Staubli CS8c robot controllers. All information regarding the use and maintenance of the robot arm and the robot controller is contained on the CDs delivered along with the robot. Paper manuals are available upon request direct from Staubli.

## Area Scans

Area scans are defined prior to the measurement process being executed with a user defined variable spacing between each measurement point (integral) allowing low uncertainty measurements to be conducted. Scans defined for FCC applications utilize a 15mm 2 step integral, with 1.5mm interpolation used to locate the peak SAR area used for zoom scan assessments.

Where the system identifies multiple SAR peaks (which are within 25% of peak value) the system will provide the user with the option of assessing each peak location individually for zoom scan averaging.

### Zoom Scan (Cube Scan Averaging)

The averaging zoom scan volume utilized in the DASY5 software is in the shape of a cube and the side dimension of a 1 g or 10 g mass is dependent on the density of the liquid representing the simulated tissue. A density of 1000 kg/m<sup>3</sup> is used to represent the head and body tissue density and not the phantom liquid density, in order to be consistent with the definition of the liquid dielectric properties, i.e. the side length of the 1g cube is 10mm, with the side length of the 10g cube is 21.5mm.

When the cube intersects with the surface of the phantom, it is oriented so that 3 vertices touch the surface of the shell or the center of a face is tangent to the surface. The face of the cube closest to the surface is modified in order to conform to the tangent surface.

The zoom scan integer steps can be user defined so as to reduce uncertainty, but normal practice for typical test applications (including FCC) utilize a physical step of 7 x 7 x 7 (5mmx5mmx5mm) providing a volume of 30 mm in the X & Y & Z axis.

## Tissue Dielectric Parameters for Head and Body Phantoms

The head tissue dielectric parameters recommended by the IEEE SCC-34/SC-2 in P1528 have been incorporated in the following table. These head parameters are derived from planar layer models simulating the highest expected SAR for the dielectric properties and tissue thickness variations in a human head. Other head and body tissue parameters that have not been specified in P1528 are derived from the tissue dielectric parameters computed from the 4-Cole-Cole equations described in Reference [12] and extrapolated according to the head parameters specified in P1528.

**Recommended Tissue Dielectric Parameters for Head and Body**

Frequency (MHz)	Head Tissue		Body Tissue	
	$\epsilon_r$	$\sigma$ (S/m)	$\epsilon_r$	$\sigma$ (S/m)
150	52.3	0.76	61.9	0.80
300	45.3	0.87	58.2	0.92
450	43.5	0.87	56.7	0.94
835	41.5	0.90	55.2	0.97
900	41.5	0.97	55.0	1.05
915	41.5	0.98	55.0	1.06
1450	40.5	1.20	54.0	1.30
1610	40.3	1.29	53.8	1.40
1800-2000	40.0	1.40	53.3	1.52
2450	39.2	1.80	52.7	1.95
3000	38.5	2.40	52.0	2.73
5800	35.3	5.27	48.2	6.00

## EQUIPMENT LIST AND CALIBRATION

### Equipments List & Calibration Information

Equipment	Model	S/N	Calibration Date	Calibration Due Date
DASY5 Test Software	DASY52.8	N/A	NCR	NCR
DASY5 Measurement Server	DASY5 4.5.12	1470	NCR	NCR
Data Acquisition Electronics	DAE4	1459	2017/9/15	2018/9/15
E-Field Probe	EX3DV4	7441	2017/11/2	2018/11/1
Mounting Device	MD4HHTV5	BJPCTC0152	NCR	NCR
Twin SAM	Twin SAM V5.0	1874	NCR	NCR
Dipole,2450 MHz	D2450V2	971	2015/7/8	2018/7/8
Dipole,5GHz	D5GHzV2	1246	2016/11/7	2019/11/6
Simulated Tissue 2450 MHz Body	TS-2450-B	1703245002	Each Time	/
Simulated Tissue 5800 MHz Body	TS-5800-B	1701580002	Each Time	/
Network Analyzer	8753C	3033A02857	2017/8/31	2018/8/31
Dielectric assessment kit	1253	SM DAK 040 CA	NCR	NCR
Signal Generator	N5182B	MY51350142	2017/5/4	2018/5/4
Power Meter	EPM-441A	GB37481494	2017/12/11	2018/12/11
Power Amplifier	ZVA-183-S+	5969001149	NCR	NCR
Directional Coupler	488Z	N/A	NCR	NCR
Attenuator	20dB, 100W	N/A	NCR	NCR
Attenuator	3dB, 150W	N/A	NCR	NCR

# SAR MEASUREMENT SYSTEM VERIFICATION

## Liquid Verification

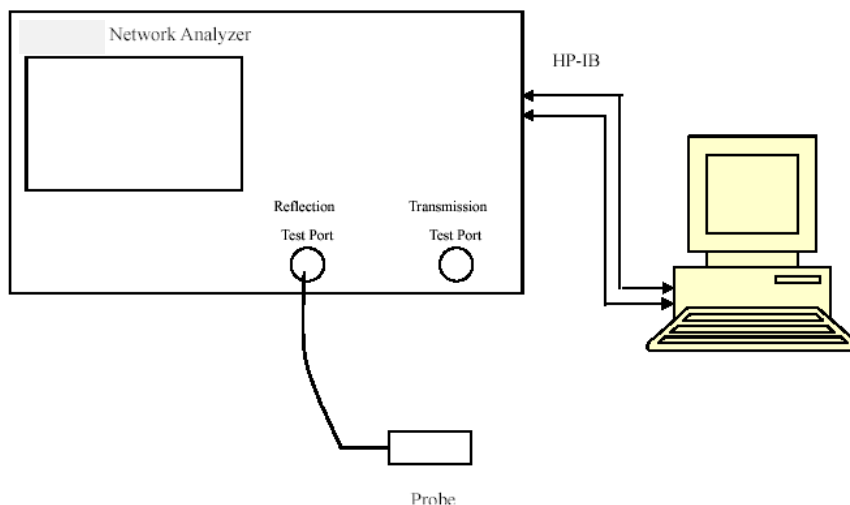

Liquid Verification Setup Block Diagram

## Liquid Verification Results

Frequency (MHz)	Liquid Type	Liquid Parameter		Target Value		Delta (%)		Tolerance (%)
		$\epsilon_r$	$\sigma$ (S/m)	$\epsilon_r$	$\sigma$ (S/m)	$\Delta\epsilon_r$	$\Delta\sigma$ (S/m)	
2403.5	Simulated Tissue 2450 MHz Body	54.425	1.906	52.76	1.91	3.16	-0.21	$\pm 5$
2405.5	Simulated Tissue 2450 MHz Body	54.349	1.918	52.76	1.91	3.01	0.42	$\pm 5$
2412	Simulated Tissue 2450 MHz Body	54.22	1.936	52.75	1.91	2.79	1.36	$\pm 5$
2437	Simulated Tissue 2450 MHz Body	53.39	1.938	52.72	1.94	1.27	-0.1	$\pm 5$
2441.5	Simulated Tissue 2450 MHz Body	52.689	1.951	52.71	1.94	-0.04	0.57	$\pm 5$
2450	Simulated Tissue 2450 MHz Body	52.138	1.977	52.7	1.95	-1.07	1.38	$\pm 5$
2462	Simulated Tissue 2450 MHz Body	51.99	1.984	52.68	1.97	-1.31	0.71	$\pm 5$
2477.5	Simulated Tissue 2450 MHz Body	51.845	1.992	52.67	1.99	-1.57	0.1	$\pm 5$

\*Liquid Verification above was performed on 2018-02-26.

Frequency (MHz)	Liquid Type	Liquid Parameter		Target Value		Delta (%)		Tolerance (%)
		$\epsilon_r$	$\sigma$ (S/m)	$\epsilon_r$	$\sigma$ (S/m)	$\Delta\epsilon_r$	$\Delta\sigma$ (S/m)	
5728.5	Simulated Tissue 5800 MHz Body	48.836	6.007	48.3	5.92	1.11	1.47	$\pm 5$
5745	Simulated Tissue 5800 MHz Body	48.723	6.035	48.27	5.94	0.94	1.6	$\pm 5$
5785	Simulated Tissue 5800 MHz Body	48.645	6.068	48.22	5.98	0.88	1.47	$\pm 5$
5786.5	Simulated Tissue 5800 MHz Body	48.633	6.121	48.22	5.98	0.86	2.36	$\pm 5$
5787.5	Simulated Tissue 5800 MHz Body	48.629	6.129	48.22	5.99	0.85	2.32	$\pm 5$
5800	Simulated Tissue 5800 MHz Body	48.509	6.136	48.2	6	0.64	2.27	$\pm 5$
5825	Simulated Tissue 5800 MHz Body	48.491	6.152	48.17	6.03	0.67	2.02	$\pm 5$
5846.5	Simulated Tissue 5800 MHz Body	48.363	6.176	48.14	6.05	0.46	2.08	$\pm 5$

\*Liquid Verification above was performed on 2018-02-27.

### System Accuracy Verification

Prior to the assessment, the system validation kit was used to test whether the system was operating within its specifications of  $\pm 10\%$ . The validation results are tabulated below. And also the corresponding SAR plot is attached as well in the SAR plots files.

The spacing distances in the **System Verification Setup Block Diagram** is given by the following:

- a)  $s = 15 \text{ mm} \pm 0,2 \text{ mm}$  for  $300 \text{ MHz} \leq f \leq 1\ 000 \text{ MHz}$ ;
- b)  $s = 10 \text{ mm} \pm 0,2 \text{ mm}$  for  $1\ 000 \text{ MHz} < f \leq 3\ 000 \text{ MHz}$ ;
- c)  $s = 10 \text{ mm} \pm 0,2 \text{ mm}$  for  $3\ 000 \text{ MHz} < f \leq 6\ 000 \text{ MHz}$ .

### System Verification Setup Block Diagram

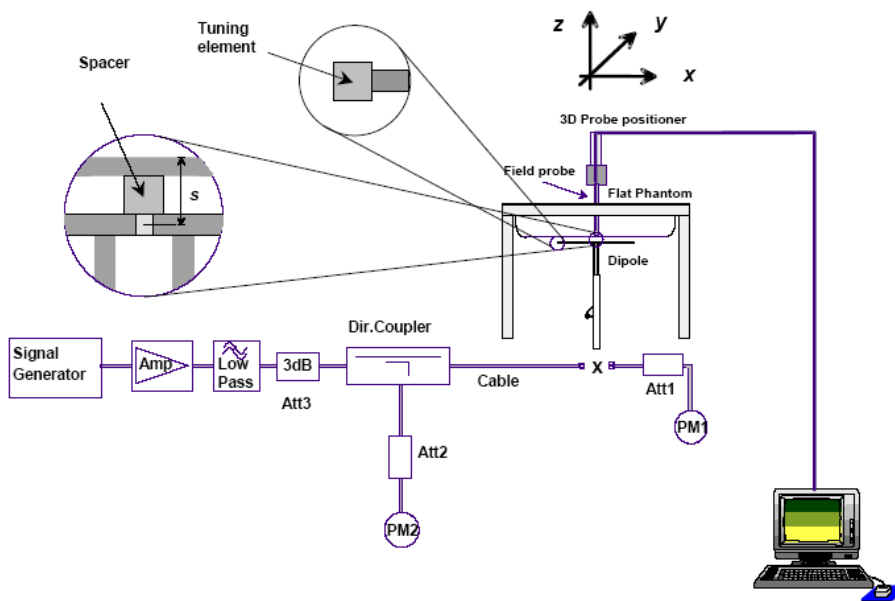

### System Accuracy Check Results

Date	Frequency Band	Liquid Type	Input Power (mW)	Measured SAR (W/kg)		Normalized to 1W (W/kg)	Target Value (W/kg)	Delta (%)	Tolerance (%)
2018/02/26	2450 MHz	Body	100	1g	5.37	53.7	50.6	6.13	$\pm 10$
				10g	2.49	24.9	23.9	4.18	$\pm 10$
2018/02/27	5800 MHz	Body	100	1g	7.81	78.1	75.4	3.58	$\pm 10$
				10g	2.22	22.2	20.9	6.22	$\pm 10$

\*The SAR values above are normalized to 1 Watt forward power.



**System Performance 2450MHz Body**

**DUT: D2450V2; Type: 2450 MHz; Serial: 971**

Communication System: CW; Frequency: 2450 MHz; Duty Cycle: 1:1

Medium parameters used:  $f = 2450 \text{ MHz}$ ;  $\sigma = 1.977 \text{ S/m}$ ;  $\epsilon_r = 52.138$ ;  $\rho = 1000 \text{ kg/m}^3$

Phantom section: Flat Section

DASY5 Configuration:

- Probe: EX3DV4 - SN7441; ConvF(7.4, 7.4, 7.4); Calibrated: 2017/11/2;
- Sensor-Surface: 1.4mm (Mechanical Surface Detection)
- Electronics: DAE4 Sn1459; Calibrated: 2017/9/15
- Phantom: SAM (30deg probe tilt) with CRP v5.0\_20150321; Type: QD000P40CD; Serial: TP:1874
- Measurement SW: DASY52, Version 52.8 (8);

**Area Scan (51x61x1):** Interpolated grid:  $dx=1.200 \text{ mm}$ ,  $dy=1.200 \text{ mm}$

Maximum value of SAR (interpolated) = 9.73 W/kg

**Zoom Scan (5x5x7)/Cube 0:** Measurement grid:  $dx=8\text{mm}$ ,  $dy=8\text{mm}$ ,  $dz=5\text{mm}$

Reference Value = 55.89 V/m; Power Drift = -0.02 dB

Peak SAR (extrapolated) = 11.6 W/kg

**SAR(1 g) = 5.37 W/kg; SAR(10 g) = 2.49 W/kg**

Maximum value of SAR (measured) = 9.23 W/kg

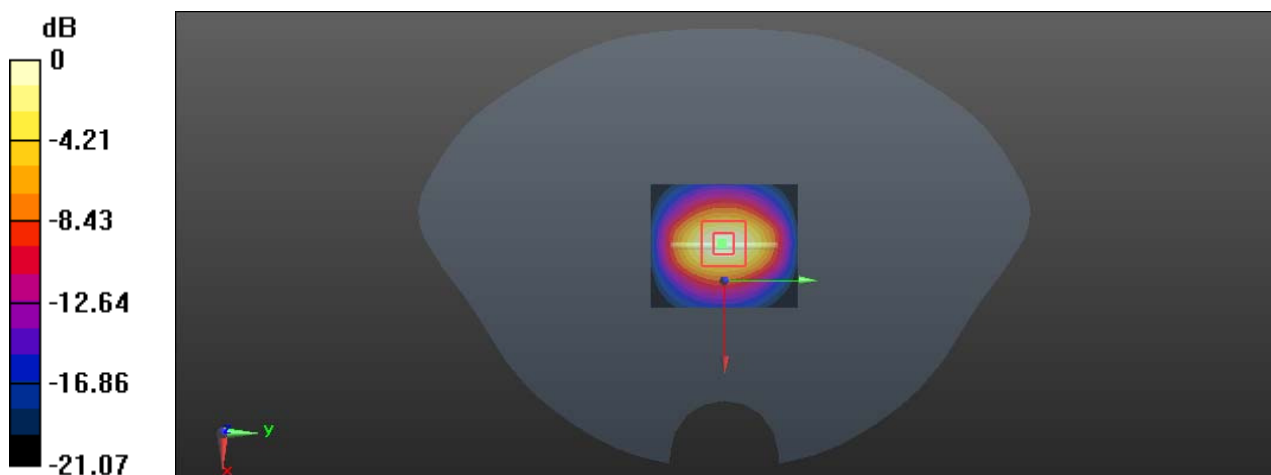

0 dB = 9.23 W/kg = 9.65 dBW/kg

**System Performance 5800 MHz Body**

**DUT: D5GHzV2; Type: 5800 MHz; Serial: SN:1246**

Communication System: CW; Frequency: 5800 MHz; Duty Cycle: 1:1  
 Medium parameters used:  $f = 5800 \text{ MHz}$ ;  $\sigma = 6.136 \text{ S/m}$ ;  $\epsilon_r = 48.509$ ;  $\rho = 1000 \text{ kg/m}^3$   
 Phantom section: Flat Section

DASY5 Configuration:

- Probe: EX3DV4 - SN7441; ConvF(4.35, 4.35, 4.35); Calibrated: 2017/11/2;
- Sensor-Surface: 1.4mm (Mechanical Surface Detection)
- Electronics: DAE4 Sn1459; Calibrated: 2017/9/15
- Phantom: SAM (30deg probe tilt) with CRP v5.0\_20150321; Type: QD000P40CD; Serial: TP:1874
- Measurement SW: DASY52, Version 52.8 (8);

**Area Scan (31x51x1):** Interpolated grid:  $dx=1.000 \text{ mm}$ ,  $dy=1.000 \text{ mm}$   
 Maximum value of SAR (interpolated) = 20.2 W/kg

**Zoom Scan (7x7x6)/Cube 0:** Measurement grid:  $dx=5\text{mm}$ ,  $dy=5\text{mm}$ ,  $dz=2\text{mm}$   
 Reference Value = 39.65 V/m; Power Drift = 0.13 dB  
 Peak SAR (extrapolated) = 29.9 W/kg  
**SAR(1 g) = 7.81 W/kg; SAR(10 g) = 2.22 W/kg**  
 Maximum value of SAR (measured) = 19.7 W/kg

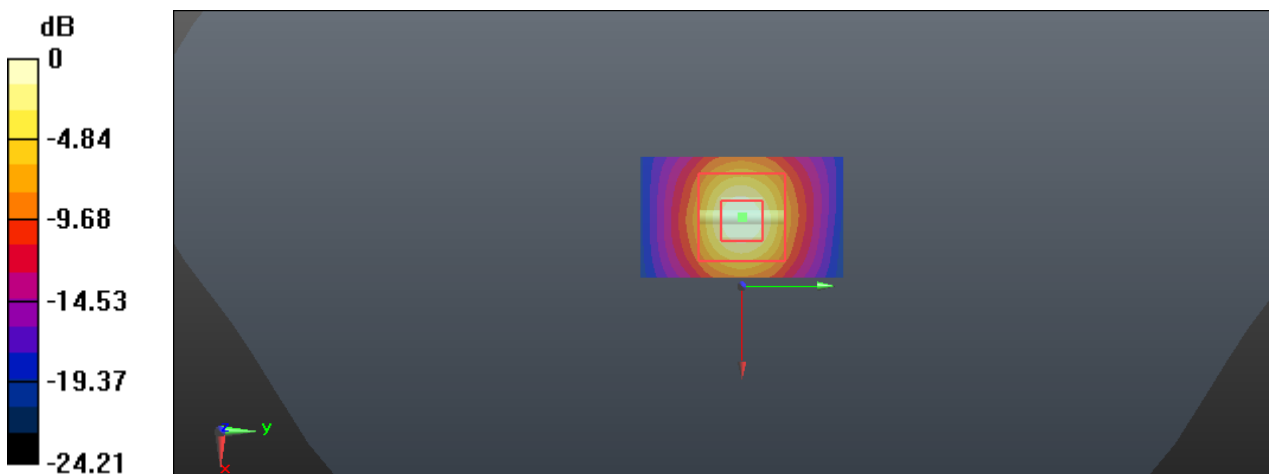

0 dB = 19.7 W/kg = 12.94 dBW/kg

## EUT TEST STRATEGY AND METHODOLOGY

### Test Positions for Device Operating Next to a Person’s Ear

This category includes most wireless handsets with fixed, retractable or internal antennas located toward the top half of the device, with or without a foldout, sliding or similar keypad cover. The handset should have its earpiece located within the upper ¼ of the device, either along the centerline or off-centered, as perceived by its users. This type of handset should be positioned in a normal operating position with the “test device reference point” located along the “vertical centerline” on the front of the device aligned to the “ear reference point”. The “test device reference point” should be located at the same level as the center of the earpiece region. The “vertical centerline” should bisect the front surface of the handset at its top and bottom edges. A “ear reference point” is located on the outer surface of the head phantom on each ear spacer. It is located 1.5 cm above the center of the ear canal entrance in the “phantom reference plane” defined by the three lines joining the center of each “ear reference point” (left and right) and the tip of the mouth.

A handset should be initially positioned with the earpiece region pressed against the ear spacer of a head phantom. For the SCC-34/SC-2 head phantom, the device should be positioned parallel to the “N-F” line defined along the base of the ear spacer that contains the “ear reference point”. For interim head phantoms, the device should be positioned parallel to the cheek for maximum RF energy coupling. The “test device reference point” is aligned to the “ear reference point” on the head phantom and the “vertical centerline” is aligned to the “phantom reference plane”. This is called the “initial ear position”. While maintaining these three alignments, the body of the handset is gradually adjusted to each of the following positions for evaluating SAR:

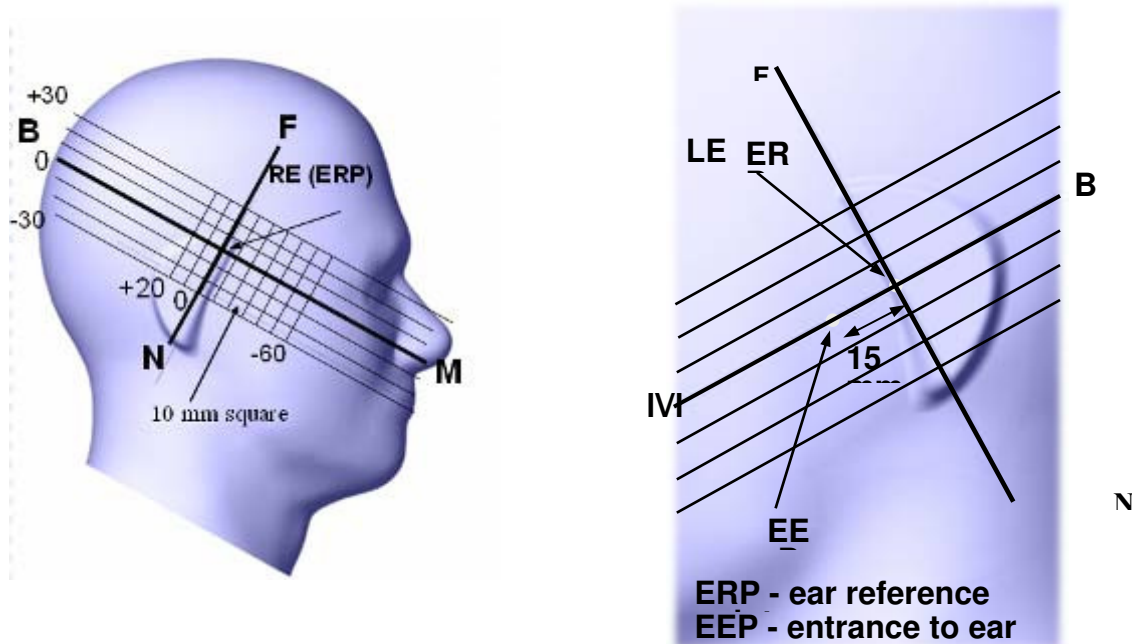

## Cheek/Touch Position

The device is brought toward the mouth of the head phantom by pivoting against the “ear reference point” or along the “N-F” line for the SCC-34/SC-2 head phantom.

This test position is established:

When any point on the display, keypad or mouthpiece portions of the handset is in contact with the phantom.

(or) When any portion of a foldout, sliding or similar keypad cover opened to its intended self-adjusting normal use position is in contact with the cheek or mouth of the phantom.

For existing head phantoms – when the handset loses contact with the phantom at the pivoting point, rotation should continue until the device touches the cheek of the phantom or breaks its last contact from the ear spacer.

### Cheek /Touch Position

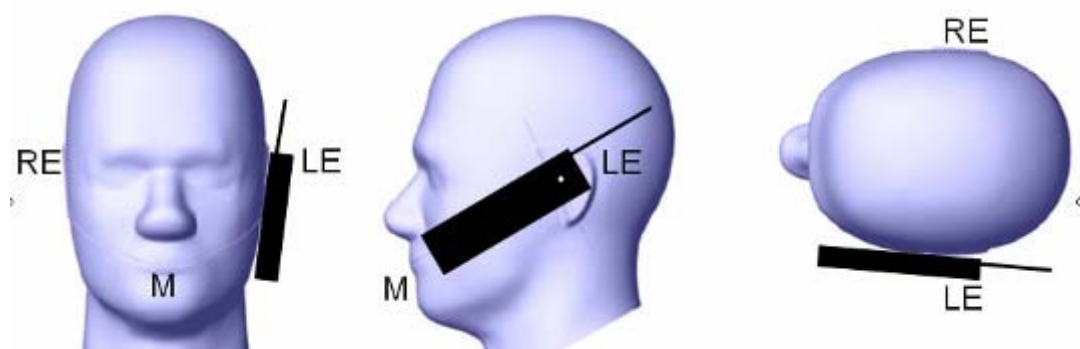

## Ear/Tilt Position

With the handset aligned in the “Cheek/Touch Position”:

1) If the earpiece of the handset is not in full contact with the phantom’s ear spacer (in the “Cheek/Touch position”) and the peak SAR location for the “Cheek/Touch” position is located at the ear spacer region or corresponds to the earpiece region of the handset, the device should be returned to the “initial ear position” by rotating it away from the mouth until the earpiece is in full contact with the ear spacer.

2) (otherwise) The handset should be moved (translated) away from the cheek perpendicular to the line passes through both “ear reference points” (note: one of these ear reference points may not physically exist on a split head model) for approximate 2-3 cm. While it is in this position, the device handset is tilted away from the mouth with respect to the “test device reference point” until the inside angle between the vertical centerline on the front surface of the phone and the horizontal line passing through the ear reference point is by 15 80°. After the tilt, it is then moved (translated) back toward the head perpendicular to the line passes through both “ear reference points” until the device touches the phantom or the ear spacer. If the antenna touches the head first, the positioning process should be repeated with a tilt angle less than 15° so that the device and its antenna would touch the phantom simultaneously. This test position may require a device holder or positioner to achieve the translation and tilting with acceptable positioning repeatability.

If a device is also designed to transmit with its keypad cover closed for operating in the head position, such positions should also be considered in the SAR evaluation. The device should be tested on the left and right side of the head phantom in the “Cheek/Touch” and “Ear/Tilt” positions. When applicable, each configuration should be tested with the antenna in its fully extended and fully retracted positions. These test configurations should be tested at the high, middle and low frequency channels of each operating mode; for example, AMPS, CDMA, and TDMA. If the SAR measured at the middle channel for each test configuration (left, right, Cheek/Touch, Tilt/Ear, extended and retracted) is at least 2.0 dB lower than the SAR limit, testing at the high and low channels is optional for such test configuration(s). If the transmission band of the test device is less than 10 MHz, testing at the high and low frequency channels is optional.

**Ear /Tilt 15° Position**

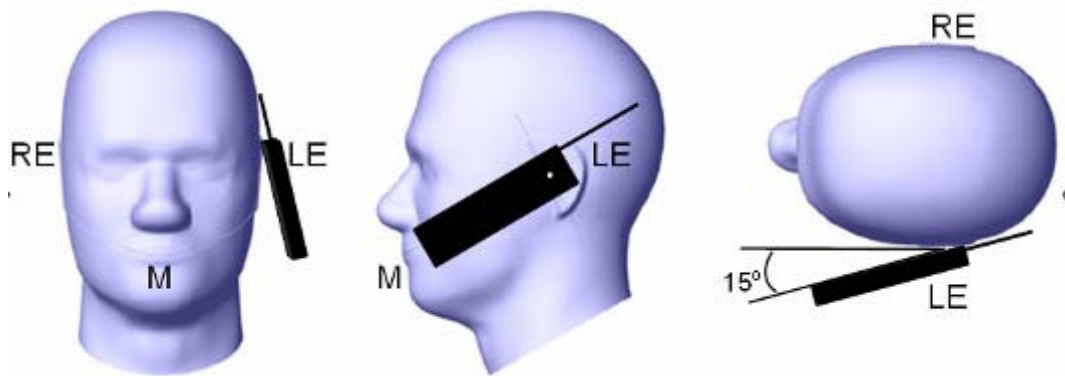

**Test positions for body-worn and other configurations**

Body-worn operating configurations should be tested with the belt-clips and holsters attached to the device and positioned against a flat phantom in normal use configurations. Devices with a headset output should be tested with a headset connected to the device. When multiple accessories that do not contain metallic components are supplied with the device, the device may be tested with only the accessory that dictates the closest spacing to the body. When multiple accessories that contain metallic components are supplied with the device, the device must be tested with each accessory that contains a unique metallic component. If multiple accessories share an identical metallic component (e.g., the same metallic belt-clip used with different holsters with no other metallic components), only the accessory that dictates the closest spacing to the body must be tested.

Body-worn accessories may not always be supplied or available as options for some devices that are intended to be authorized for body-worn use. A separation distance of 1.5 cm between the back of the device and a flat phantom is recommended for testing body-worn SAR compliance under such circumstances. Other separation distances may be used, but they should not exceed 2.5 cm. In these cases, the device may use body-worn accessories that provide a separation distance greater than that tested for the device provided however that the accessory contains no metallic components.

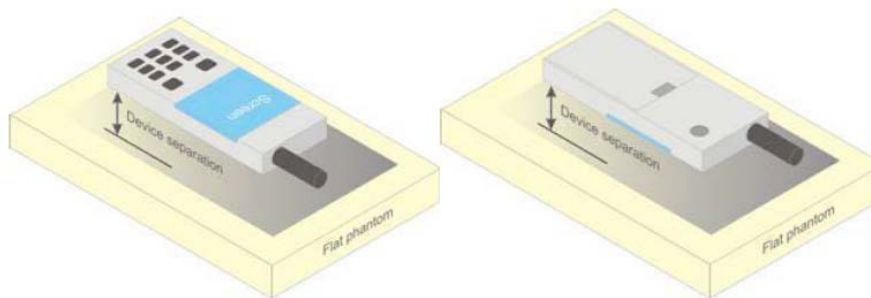

**Figure 5 – Test positions for body-worn devices**

**Test Distance for SAR Evaluation**

For Handheld mode(10g Extremity SAR) the EUT(Equipment Under Test) is set directly against the phantom, the test distance is 0mm;  
 For Close to Body mode(1g Body SAR) the EUT is set 10mm away from the phantom, the test distance is 10mm.

## SAR Evaluation Procedure

The evaluation was performed with the following procedure:

Step 1: Measurement of the SAR value at a fixed location above the ear point or central position was used as a reference value for assessing the power drop. The SAR at this point is measured at the start of the test and then again at the end of the testing.

Step 2: The SAR distribution at the exposed side of the head was measured at a distance of 4 mm from the inner surface of the shell. The area covered the entire dimension of the head or radiating structures of the EUT, the horizontal grid spacing was 10 mm x 10 mm, and the SAR distribution was determined by integrated grid of 1.0 mm x 1.0 mm. Based on these data, the area of the maximum absorption was determined by spline interpolation. The first Area Scan covers the entire dimension of the EUT to ensure that the hotspot was correctly identified.

Step 3: Around this point, a volume of 30 mm x 30 mm x 30 mm was assessed by measuring 7x 7 x 7 points. On the basis of this data set, the spatial peak SAR value was evaluated under the following procedure:

- 1) The data at the surface were extrapolated, since the center of the dipoles is 1.2 mm away from the tip of the probe and the distance between the surface and the lowest measuring point is 1.3 mm. The extrapolation was based on a least square algorithm. A polynomial of the fourth order was calculated through the points in z-axes. This polynomial was then used to evaluate the points between the surface and the probe tip.

- 2) The maximum interpolated value was searched with a straightforward algorithm. Around this maximum the SAR values averaged over the spatial volumes (1 g or 10 g) were computed by the 3D-Spline interpolation algorithm. The 3D-Spline is composed of three one dimensional splines with the "Not a knot"-condition (in x, y and z-directions). The volume was integrated with the trapezoidal-algorithm. One thousand points (10 x 10 x 10) were interpolated to calculate the averages.

All neighboring volumes were evaluated until no neighboring volume with a higher average value was found.

Step 4: Re-measurement of the SAR value at the same location as in Step 1. If the value changed by more than 5%, the evaluation was repeated.

## CONDUCTED OUTPUT POWER MEASUREMENT

### Test Procedure

The RF output of the transmitter was connected to the input port of the Power Meter through Connector.

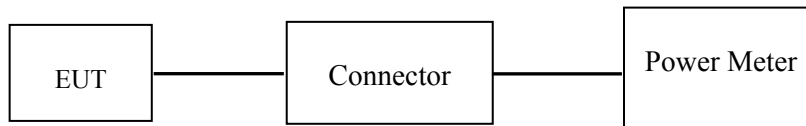

### Maximum Target Output Power

Mode	Frequency (MHz)	Max Target Power(dBm) (dBm)	
		Chain 0	Chain 1
SDR 2.4G (1.4MHz)	2403.5	18.5	18.5
	2441.5	18.5	18.5
	2477.5	18.5	18.5
SDR 2.4G (10MHz)	2405.5	9.5	9.5
	2406.5	10.5	10.5
	2407.5	11.5	11.8
	2408.5	13	13.1
	2409.5	14	14.5
	2410.5	14.3	14
	2411.5	15.2	15.2
	2412.5	15.5	15.5
	2413.5	16.5	16.5
	2414.5	16.8	17.5
	2415.5	18.5	18.5
	...		
	2441.5		
	...		
	2457.5	15.5	15.5
	2458.5	15.5	15.5
	2459.5	14.5	15
	2460.5	14.5	14.5
	2461.5	13.5	13.5
	2462.5	13.5	13.5
	2463.5	12.5	12.5
	2464.5	12.5	12.4
	2465.5	11.4	11.5
	2466.5	11	11.4
	2467.5	10.5	10.5
	2468.5	8.5	9
2469.5	6.5	6.5	
2470.5	4.5	4.6	
2471.5	2.6	3.2	
2472.5			

Mode	Frequency (MHz)	Max Target Power(dBm) (dBm)	
		Chain 0	Chain 1
SDR 2.4G (10MHz)	2473.5	1.5	2
	2474.5	0	0
	2475.5	0	0
	2476.5	0	0
	2477.5	-16	-16
Wi-Fi 2.4G (802.11b)	2412	13.2	12.5
	2437	13.2	12.5
	2462	13.2	12.5
Wi-Fi 2.4G (802.11g)	2412	9.5	9
	2417	13.5	12.8
	2437	14.5	12.9
	2457	14	12.2
	2462	9.5	8.5
Wi-Fi 2.4G (802.11n HT20)	2412	9.5	9.0
	2417	13.5	12.7
	2437	14.5	12.8
	2457	13.8	12.3
	2462	9.5	8.5
SDR 5.8G (1.4MHz)	5728.5	19.5	19
	5786.5	19.5	19
	5846.5	19.5	19
SDR 5.8G (10MHz)	5730.5	19.5	19.3
	5787.5	19.5	19.3
	5844.5	19.5	19.3
Wi-Fi 5.8G (802.11a)	5745	13.2	12.8
	5785	13.2	12.8
	5825	13.2	12.8
Wi-Fi 5.8G (802.11n HT20)	5745	13.2	12.8
	5785	13.2	12.8
	5825	13.2	12.8



**Test Results:**

**SDR 2.4G:**

Mode	Frequency (MHz)	Maximum Conducted Average Output Power (dBm)	
		Chain 0	Chain 1
1.4 MHz	2403.5	17.33	17.21
	2441.5	17.46	17.39
	2477.5	17.79	17.68
10 MHz	2405.5	9.25	9.33
	2406.5	10.29	10.28
	2407.5	11.35	11.63
	2408.5	12.82	12.95
	2409.5	13.96	14.15
	2410.5	14.11	13.85
	2411.5	15.03	14.96
	2412.5	15.32	15.37
	2413.5	16.28	16.37
	2414.5	16.64	16.34
	2415.5	17.39	17.29
	2416.5	17.64	17.32
	2417.5	<b>18.29</b>	<b>18.16</b>
	2441.5	17.91	17.82
	2457.5	17.56	17.35
	2458.5	15.37	15.27
	2459.5	15.29	15.26
	2460.5	14.35	14.59
	2461.5	14.31	14.36
	2462.5	13.16	13.21
	2463.5	13.02	13.05
	2464.5	12.26	12.28
	2465.5	12.04	12.01
	2466.5	11.08	11.13
	2467.5	10.86	11.06
	2468.5	10.06	10.37
	2469.5	8.14	8.54
	2470.5	6.11	6.39
	2471.5	4.22	4.42
	2472.5	2.41	2.94
2473.5	1.37	1.75	
2474.5	0.62	0.99	
2475.5	0.52	0.95	
2476.5	-0.29	-0.02	
2477.5	-16.43	-16.58	

*Note: The Duty Cycle for SDR 2.4G is 100%.*

**Wi-Fi 2.4G:**

Mode	Frequency (MHz)	Data Rate	Maximum Conducted Average Output Power (dBm)		
			Chain 0	Chain 1	Total
802.11b	2412	1Mbps	13.19	12.42	15.83
	2437		13.12	12.07	15.64
	2462		13.05	11.86	15.51
802.11g	2412	6Mbps	9.34	8.67	12.03
	2417		13.37	12.56	15.99
	2437		<b>14.39</b>	12.85	16.7
	2457		13.75	12.02	15.98
	2462		9.42	8.13	11.83
802.11 n HT20	2412	MCS0	9.19	8.86	12.04
	2417		13.39	12.57	16.01
	2437		14.22	12.69	16.53
	2457		13.64	12.12	15.96
	2462		9.16	7.97	11.62

**SDR 5.8G:**

Mode	Channel	Frequency (MHz)	Maximum Conducted Average Output Power (dBm)	
			Chain 0	Chain 1
1.4 MHz	Low	5728.5	19.08	18.72
	Middle	5786.5	<b>19.46</b>	18.86
	High	5846.5	18.82	17.34
10 MHz	Low	5730.5	19.32	19.22
	Middle	5787.5	19.39	<b>19.29</b>
	High	5844.5	18.71	17.97

*Note: The Duty Cycle for SDR 5.8G is 100%.*

**Wi-Fi 5.8G:**

Mode	Channel	Frequency (MHz)	Data Rate	Maximum Conducted Average Output Power (dBm)		
				Chain 0	Chain 1	Total
802.11a	Low	5745	6Mbps	12.98	12.61	15.81
	Middle	5785		<b>13.12</b>	12.79	15.97
	High	5825		12.76	12.45	15.62
802.11n20	Low	5745	MCS0	13.08	12.77	15.94
	Middle	5785		12.72	12.53	15.64
	High	5825		12.81	12.36	15.6

### SAR EXCLUSION CONSIDERATIONS

**Antennas Location:**

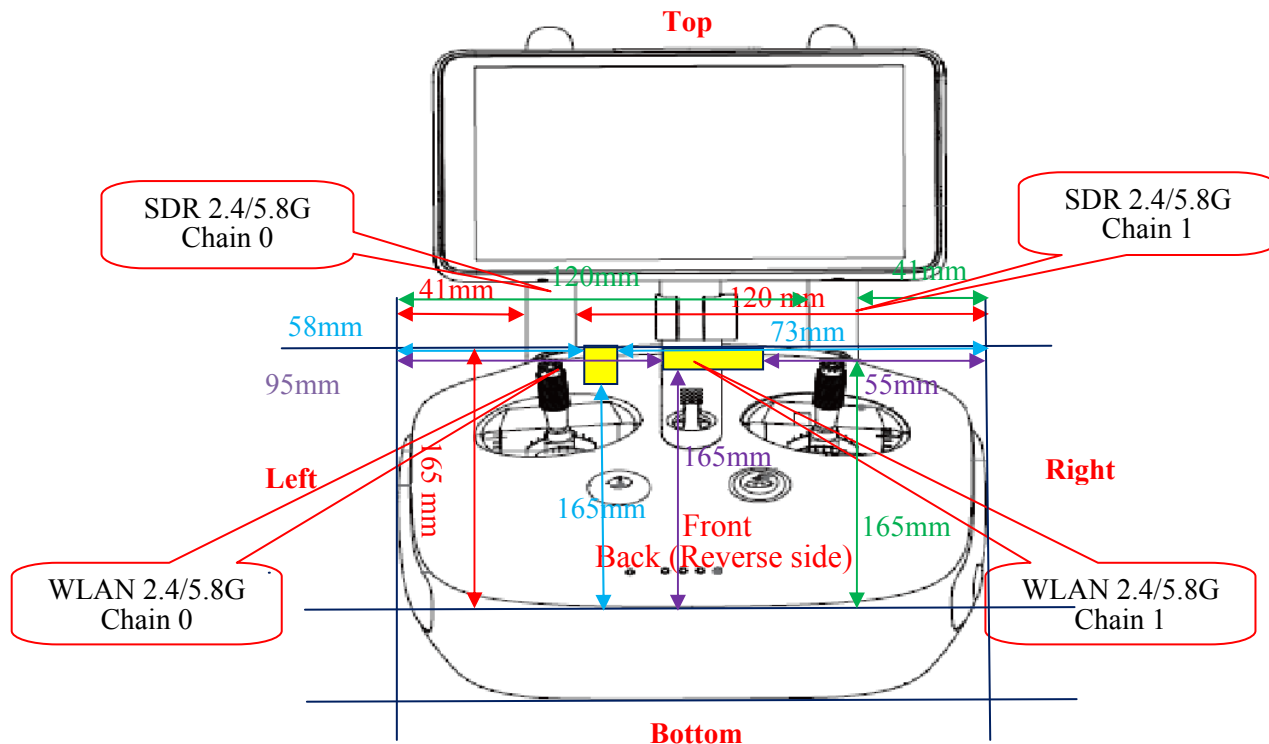

**Antenna Distance To Edge**

Antenna Distance To Edge(mm)						
Mode	Left	Right	Back	Top	Front	Bottom
SDR 2.4G/5.8G(Chain 0)	41	120	24	0	24	165
SDR 2.4G/5.8G(Chain 1)	120	41	24	0	24	165
WLAN 2.4G/5.8G(Chain 0)	58	73	20	30	<5	165
WLAN 2.4G/5.8G(Chain 1)	95	55	22	30	24	165

**Note:** The display screen may prevent the EUT touch the phantom for front setup position, for sufficiently conservative consideration, the display screen was removed during SAR testing.

**SAR test exclusion for the EUT edge considerations**

<b>SAR Test Exclusion for the EUT Edges Considerations</b>						
<b>Mode</b>	<b>Left</b>	<b>Right</b>	<b>Back</b>	<b>Top</b>	<b>Front</b>	<b>Bottom</b>
SDR 2.4G(Chain 0)	Exclusion	Exclusion	<b>Required</b>	<b>Required</b>	<b>Required</b>	Exclusion
SDR 2.4G(Chain 1)	Exclusion	Exclusion	<b>Required</b>	<b>Required</b>	<b>Required</b>	Exclusion
SDR 5.8G(Chain 0)	Exclusion	Exclusion	<b>Required</b>	<b>Required</b>	<b>Required</b>	Exclusion
SDR 5.8G(Chain 1)	Exclusion	Exclusion	<b>Required</b>	<b>Required</b>	<b>Required</b>	Exclusion
WLAN 2.4G(Chain 0)	Exclusion	Exclusion	<b>Required</b>	Exclusion	<b>Required</b>	Exclusion
WLAN 2.4G(Chain 1)	Exclusion	Exclusion	<b>Required</b>	Exclusion	<b>Required</b>	Exclusion
WLAN 5.8G(Chain 0)	Exclusion	Exclusion	<b>Required</b>	Exclusion	<b>Required</b>	Exclusion
WLAN 5.8G(Chain 1)	Exclusion	Exclusion	<b>Required</b>	Exclusion	<b>Required</b>	Exclusion

**Note:**

**Required:** Per KDB 941225 D07-The distance to Edge is less than 25mm, testing is required.

**Exclusion:** Per KDB 941225 D07-The distance to Edge is more than 25 mm, testing is not required.

## SAR MEASUREMENT RESULTS

This page summarizes the results of the performed dosimetric evaluation.

### SAR Test Data

#### Environmental Conditions

<b>Temperature:</b>	22.4-23.8°C	22.2-23.5°C
<b>Relative Humidity:</b>	42%	43%
<b>ATM Pressure:</b>	102 kPa	102.1 kPa
<b>Test Date:</b>	2018/02/26	2018/02/27

Testing was performed by Yun Yu, Brave Lu, Jayce Chen

### SDR 2.4G Chain 0:

EUT Position	Bandwidth (MHz)	Frequency (MHz)	Max. Meas. Power (dBm)	Max. Rated Power (dBm)	10 g SAR (W/kg), Limit=4.0W/kg			
					Scaled Factor	Meas. SAR	Scaled SAR	Plot
Handheld-Top (0mm)	1.4	2403.5	/	/	/	/	/	/
		2441.5	17.46	18.5	1.271	0.74	<b>0.94</b>	<b>1#</b>
		2477.5	/	/	/	/	/	/
	10	2405.5	/	/	/	/	/	/
		2441.5	17.91	18.5	1.146	0.564	0.65	<b>2#</b>
		2477.5	/	/	/	/	/	/
Handheld-Back (0mm)	1.4	2403.5	/	/	/	/	/	/
		2441.5	17.46	18.5	1.271	0.042	0.05	<b>3#</b>
		2477.5	/	/	/	/	/	/
Handheld-Back (0mm) Antenna Fold	1.4	2403.5	/	/	/	/	/	/
		2441.5	17.46	18.5	1.271	<0.01	0.01	/
		2477.5	/	/	/	/	/	/
Handheld-Front (Remove display screen) (0mm)	1.4	2403.5	/	/	/	/	/	/
		2441.5	17.46	18.5	1.271	0.247	0.31	<b>4#</b>
		2477.5	/	/	/	/	/	/

EUT Position	Bandwidth (MHz)	Frequency (MHz)	Max. Meas. Power (dBm)	Max. Rated Power (dBm)	1 g SAR (W/kg), Limit=1.6W/kg			
					Scaled Factor	Meas. SAR	Scaled SAR	Plot
Close to Body-Top (10mm)	1.4	2403.5	/	/	/	/	/	/
		2441.5	17.46	18.5	1.271	0.261	<b>0.33</b>	<b>5#</b>
		2477.5	/	/	/	/	/	/
	10	2405.5	/	/	/	/	/	/
		2441.5	17.91	18.5	1.146	0.213	0.24	<b>6#</b>
		2477.5	/	/	/	/	/	/
Close to Body-Back (10mm)	1.4	2403.5	/	/	/	/	/	/
		2441.5	17.46	18.5	1.271	0.061	0.08	<b>7#</b>
		2477.5	/	/	/	/	/	/
Close to Body-Back (10mm) Antenna Fold	1.4	2403.5	/	/	/	/	/	/
		2441.5	17.46	18.5	1.271	<0.01	0.01	/
		2477.5	/	/	/	/	/	/
Close to Body-Front (Remove display screen) (10mm)	1.4	2403.5	/	/	/	/	/	/
		2441.5	17.46	18.5	1.271	0.229	0.29	<b>8#</b>
		2477.5	/	/	/	/	/	/

**Note:**

1. Pre- Scan all configuration and test position, the highest SAR located on 1.4MHz Bandwidth/Top position, 1.4MHz bandwidth was selected as primary mode, testing for other bandwidth were performed for worst case test positon.
2. When the SAR value is less than half of the limit, testing for other channels are optional.
3. When SAR or MPE is not measured at the maximum power level allowed for production units, the results must be scaled to the maximum tune-up tolerance limit according to the power applied to the individual channels tested to determine compliance.
4. For modes that peak SAR is too low to evaluate, a SAR value 0.01W/kg is considered as their Scaled SAR.

**SDR 2.4G Chain 1:**

EUT Position	Bandwidth (MHz)	Frequency (MHz)	Max. Meas. Power (dBm)	Max. Rated Power (dBm)	10 g SAR (W/kg), Limit=4.0W/kg			
					Scaled Factor	Meas. SAR	Scaled SAR	Plot
Handheld-Top (0mm)	1.4	2403.5	/	/	/	/	/	/
		2441.5	17.29	18	1.178	0.012	0.01	<b>9#</b>
		2477.5	/	/	/	/	/	/
Handheld-Back (0mm)	1.4	2403.5	/	/	/	/	/	/
		2441.5	17.29	18	1.178	0.037	0.04	<b>10#</b>
		2477.5	/	/	/	/	/	/
Handheld-Back (0mm) Antenna Fold	1.4	2403.5	/	/	/	/	/	/
		2441.5	17.29	18	1.178	<0.01	0.01	/
		2477.5	/	/	/	/	/	/
Handheld-Front (Remove display screen) (0mm)	1.4	2403.5	/	/	/	/	/	/
		2441.5	17.29	18	1.178	0.133	<b>0.16</b>	<b>11#</b>
		2477.5	/	/	/	/	/	/
	10	2405.5	/	/	/	/	/	/
		2441.5	17.72	18.5	1.197	0.118	0.14	<b>12#</b>
2477.5	/	/	/	/	/	/		

EUT Position	Bandwidth (MHz)	Frequency (MHz)	Max. Meas. Power (dBm)	Max. Rated Power (dBm)	1 g SAR (W/kg), Limit=1.6W/kg			
					Scaled Factor	Meas. SAR	Scaled SAR	Plot
Close to Body-Top (10mm)	1.4	2403.5	/	/	/	/	/	/
		2441.5	17.29	18	1.178	0.013	0.02	<b>13#</b>
		2477.5	/	/	/	/	/	/
Close to Body-Back (10mm)	1.4	2403.5	/	/	/	/	/	/
		2441.5	17.29	18	1.178	0.051	0.06	<b>14#</b>
		2477.5	/	/	/	/	/	/
Close to Body-Back (10mm) Antenna Fold	1.4	2403.5	/	/	/	/	/	/
		2441.5	17.29	18	1.178	<0.01	0.01	/
		2477.5	/	/	/	/	/	/
Close to Body-Front (Remove display screen) (10mm)	1.4	2403.5	/	/	/	/	/	/
		2441.5	17.29	18	1.178	0.160	<b>0.19</b>	<b>15#</b>
		2477.5	/	/	/	/	/	/
	10	2405.5	/	/	/	/	/	/
		2441.5	17.72	18.5	1.197	0.144	0.17	<b>16#</b>
		2477.5	/	/	/	/	/	

**Note:**

1. Pre- Scan all configuration and test position, the highest SAR located on 1.4MHz Bandwidth/Top position, 1.4MHz bandwidth was selected as primary mode, testing for other bandwidth were performed for worst case test positon.
2. When the SAR value is less than half of the limit, testing for other channels are optional.
3. When SAR or MPE is not measured at the maximum power level allowed for production units, the results must be scaled to the maximum tune-up tolerance limit according to the power applied to the individual channels tested to determine compliance.

For modes that peak SAR is too low to evaluate, a SAR value 0.01W/kg is considered as their Scaled SAR.

**Wi-Fi 2.4G Chain 0:**

EUT Position	Mode	Frequency (MHz)	Max. Meas. Power (dBm)	Max. Rated Power (dBm)	10 g SAR (W/kg), Limit=4.0W/kg			
					Scaled Factor	Meas. SAR	Scaled SAR	Plot
Handheld-Back (0mm)	802.11b	2412	/	/	/	/	/	/
	802.11b	2437	13.12	13.2	1.019	0.018	0.02	17#
	802.11b	2462	/	/	/	/	/	/
Handheld-Front (Remove display screen) (0mm)	802.11b	2412	/	/	/	/	/	/
	802.11b	2437	13.12	13.2	1.019	0.056	<b>0.06</b>	<b>18#</b>
	802.11b	2462	/	/	/	/	/	/

EUT Position	Mode	Frequency (MHz)	Max. Meas. Power (dBm)	Max. Rated Power (dBm)	1 g SAR (W/kg), Limit=1.6W/kg			
					Scaled Factor	Meas. SAR	Scaled SAR	Plot
Close to Body-Back (10mm)	802.11b	2412	/	/	/	/	/	/
	802.11b	2437	13.12	13.2	1.019	0.032	0.03	19#
	802.11b	2462	/	/	/	/	/	/
Close to Body-Front (Remove display screen) (10mm)	802.11b	2412	/	/	/	/	/	/
	802.11b	2437	13.12	13.2	1.019	0.041	<b>0.04</b>	<b>20#</b>
	802.11b	2462	/	/	/	/	/	/

**Note:**

1. When the SAR value is less than half of the limit, testing for other channels are optional.
2. When SAR or MPE is not measured at the maximum power level allowed for production units, the results must be scaled to the maximum tune-up tolerance limit according to the power applied to the individual channels tested to determine compliance.

**2.4 GHz 802.11g/n OFDM SAR Test Exclusion Consideration:**

Modulation Mode	Pavg (dBm)	Pavg (mW)	Reported SAR(W/kg)	Adjusted SAR(W/kg)	Limit(W/kg)	SAR Test Exclusion
802.11b(DSSS)	13.2	20.89	0.06	/	/	/
802.11g(OFDM)	14.5	28.18	/	0.09	1.2	Yes
802.11n HT20(OFDM)	14.5	28.18	/	0.09	1.2	Yes

**Note:**

KDB 248227 D01-SAR is not required for 2.4 GHz OFDM when the highest reported SAR for DSSS is adjusted by the ratio of OFDM to DSSS specified maximum output power and the adjusted SAR is ≤ 1.2 W/kg.



**Wi-Fi 2.4G Chain 1:**

EUT Position	Mode	Frequency (MHz)	Max. Meas. Power (dBm)	Max. Rated Power (dBm)	10 g SAR (W/kg), Limit=4.0W/kg			
					Scaled Factor	Meas. SAR	Scaled SAR	Plot
Handheld-Back (0mm)	802.11b	2412	/	/	/	/	/	/
	802.11b	2437	12.07	12.5	1.104	0.033	0.04	21#
	802.11b	2462	/	/	/	/	/	/
Handheld-Front (Remove display screen) (0mm)	802.11b	2412	/	/	/	/	/	/
	802.11b	2437	12.07	12.5	1.104	0.040	<b>0.04</b>	22#
	802.11b	2462	/	/	/	/	/	/

EUT Position	Mode	Frequency (MHz)	Max. Meas. Power (dBm)	Max. Rated Power (dBm)	1 g SAR (W/kg), Limit=1.6W/kg			
					Scaled Factor	Meas. SAR	Scaled SAR	Plot
Close to Body-Back (10mm)	802.11b	2412	/	/	/	/	/	/
	802.11b	2437	12.07	12.5	1.104	0.093	<b>0.10</b>	23#
	802.11b	2462	/	/	/	/	/	/
Close to Body-Front (Remove display screen) (10mm)	802.11b	2412	/	/	/	/	/	/
	802.11b	2437	12.07	12.5	1.104	0.045	0.05	24#
	802.11b	2462	/	/	/	/	/	/

**Note:**

1. When the SAR value is less than half of the limit, testing for other channels are optional.
2. When SAR or MPE is not measured at the maximum power level allowed for production units, the results must be scaled to the maximum tune-up tolerance limit according to the power applied to the individual channels tested to determine compliance.

**2.4 GHz 802.11g/n OFDM SAR Test Exclusion Consideration:**

Modulation Mode	Pavg (dBm)	Pavg (mW)	Reported SAR(W/kg)	Adjusted SAR(W/kg)	Limit(W/kg)	SAR Test Exclusion
802.11b(DSSS)	12.5	17.78	0.10	/	/	/
802.11g(OFDM)	12.9	19.5	/	0.11	1.2	Yes
802.11n HT20(OFDM)	12.8	19.05	/	0.11	1.2	Yes

**Note:**

KDB 248227 D01-SAR is not required for 2.4 GHz OFDM when the highest reported SAR for DSSS is adjusted by the ratio of OFDM to DSSS specified maximum output power and the adjusted SAR is ≤ 1.2 W/kg.

**SDR 5.8G Chain 0:**

EUT Position	Bandwidth (MHz)	Frequency (MHz)	Max. Meas. Power (dBm)	Max. Rated Power (dBm)	10 g SAR (W/kg), Limit=4.0W/kg			
					Scaled Factor	Meas. SAR	Scaled SAR	Plot
Handheld-Top (0mm)	1.4	5728.5	/	/	/	/	/	/
		5786.5	19.46	19.5	1.009	0.847	<b>0.85</b>	<b>25#</b>
		5846.5	/	/	/	/	/	/
	10	5730.5	/	/	/	/	/	/
		5787.5	19.39	19.5	1.026	0.692	0.71	<b>26#</b>
		5844.5	/	/	/	/	/	/
Handheld-Back (0mm)	1.4	5728.5	/	/	/	/	/	/
		5786.5	19.46	19.5	1.009	0.142	0.14	<b>27#</b>
		5846.5	/	/	/	/	/	/
Handheld-Back (0mm) Antenna Fold	1.4	5728.5	/	/	/	/	/	/
		5786.5	19.46	19.5	1.009	<0.01	0.01	/
		5846.5	/	/	/	/	/	/
Handheld-Front (Remove display screen) (0mm)	1.4	5728.5	/	/	/	/	/	/
		5786.5	19.46	19.5	1.009	0.238	0.24	<b>28#</b>
		5846.5	/	/	/	/	/	/

EUT Position	Bandwidth (MHz)	Frequency (MHz)	Max. Meas. Power (dBm)	Max. Rated Power (dBm)	1 g SAR (W/kg), Limit=1.6W/kg			
					Scaled Factor	Meas. SAR	Scaled SAR	Plot
Close to Body-Top (10mm)	1.4	5728.5	19.08	19.5	1.102	0.601	0.66	<b>29#</b>
		5786.5	19.46	19.5	1.009	0.807	<b>0.81</b>	<b>30#</b>
		5846.5	18.82	19.5	1.169	0.628	0.73	<b>31#</b>
	10	5730.5	/	/	/	/	/	/
		5787.5	19.39	19.5	1.026	0.347	0.36	<b>32#</b>
		5844.5	/	/	/	/	/	/
Close to Body-Back (10mm)	1.4	5728.5	/	/	/	/	/	/
		5786.5	19.46	19.5	1.009	0.161	0.16	<b>33#</b>
		5846.5	/	/	/	/	/	/
Close to Body-Back (10mm) Antenna Fold	1.4	5728.5	/	/	/	/	/	/
		5786.5	19.46	19.5	1.009	<0.01	0.01	/
		5846.5	/	/	/	/	/	/
Close to Body-Front (Remove display screen) (10mm)	1.4	5728.5	/	/	/	/	/	/
		5786.5	19.46	19.5	1.009	0.260	0.26	<b>34#</b>
		5846.5	/	/	/	/	/	/

**Note:**

1. Pre- Scan all configuration and test position, the highest SAR located on 1.4MHz Bandwidth/Top position, 1.4MHz bandwidth was selected as primary mode, testing for other bandwidth were performed for worst case test position.
2. When the SAR value is less than half of the limit, testing for other channels are optional.
3. When SAR or MPE is not measured at the maximum power level allowed for production units, the results must be scaled to the maximum tune-up tolerance limit according to the power applied to the individual channels tested to determine compliance.
4. For modes that peak SAR is too low to evaluate, a SAR value 0.01W/kg is considered as their Scaled SAR.

**SDR 5.8G Chain 1:**

EUT Position	Bandwidth (MHz)	Frequency (MHz)	Max. Meas. Power (dBm)	Max. Rated Power (dBm)	10 g SAR (W/kg), Limit=4.0W/kg			
					Scaled Factor	Meas. SAR	Scaled SAR	Plot
Handheld-Top (0mm)	1.4	5728.5	/	/	/	/	/	/
		5786.5	18.86	19	1.033	0.122	0.13	<b>35#</b>
		5846.5	/	/	/	/	/	/
Handheld-Back (0mm)	1.4	5728.5	/	/	/	/	/	/
		5786.5	18.86	19	1.033	0.147	<b>0.15</b>	<b>36#</b>
		5846.5	/	/	/	/	/	/
	10	5730.5	/	/	/	/	/	/
		5787.5	19.29	19.3	1.002	0.126	0.13	<b>37#</b>
		5844.5	/	/	/	/	/	/
Handheld-Back (0mm) Antenna Fold	1.4	5728.5	/	/	/	/	/	/
		5786.5	18.86	19	1.033	<0.01	0.01	/
		5846.5	/	/	/	/	/	/
Handheld-Front (Remove display screen) (0mm)	1.4	5728.5	/	/	/	/	/	/
		5786.5	18.86	19	1.033	0.113	0.12	<b>38#</b>
		5846.5	/	/	/	/	/	/

EUT Position	Bandwidth (MHz)	Frequency (MHz)	Max. Meas. Power (dBm)	Max. Rated Power (dBm)	1 g SAR (W/kg), Limit=1.6W/kg			
					Scaled Factor	Meas. SAR	Scaled SAR	Plot
Close to Body-Top (10mm)	1.4	5728.5	/	/	/	/	/	/
		5786.5	18.86	19	1.033	0.137	0.14	<b>39#</b>
		5846.5	/	/	/	/	/	/
Close to Body-Back (10mm)	1.4	5728.5	/	/	/	/	/	/
		5786.5	18.86	19	1.033	0.148	<b>0.15</b>	<b>40#</b>
		5846.5	/	/	/	/	/	/
	10	5730.5	/	/	/	/	/	/
		5787.5	19.29	19.3	1.002	0.102	0.10	<b>41#</b>
		5844.5	/	/	/	/	/	/
Close to Body-Back (10mm) Antenna Fold	1.4	5728.5	/	/	/	/	/	/
		5786.5	18.86	19	1.033	<0.01	0.01	/
		5846.5	/	/	/	/	/	/
Close to Body-Front (Remove display screen) (10mm)	1.4	5728.5	/	/	/	/	/	/
		5786.5	18.86	19	1.033	0.135	0.14	<b>42#</b>
		5846.5	/	/	/	/	/	/

**Note:**

1. Pre- Scan all configuration and test position, the highest SAR located on 1.4MHz Bandwidth/Back position, 1.4MHz bandwidth was selected as primary mode, testing for other bandwidth were performed for worst case test position.
2. When the SAR value is less than half of the limit, testing for other channels are optional.
3. When SAR or MPE is not measured at the maximum power level allowed for production units, the results must be scaled to the maximum tune-up tolerance limit according to the power applied to the individual channels tested to determine compliance.
4. For modes that peak SAR is too low to evaluate, a SAR value 0.01W/kg is considered as their Scaled SAR.

**Wi-Fi 5.8G Chain 0:**

EUT Position	Mode	Frequency (MHz)	Max. Meas. Power (dBm)	Max. Rated Power (dBm)	10 g SAR (W/kg), Limit=4.0W/kg			
					Scaled Factor	Meas. SAR	Scaled SAR	Plot
Handheld-Back (0mm)	802.11a	5745	/	/	/	/	/	/
	802.11a	5785	13.12	13.2	1.019	0.140	0.14	43#
	802.11a	5825	/	/	/	/	/	/
Handheld-Front (Remove display screen) (0mm)	802.11a	5745	/	/	/	/	/	/
	802.11a	5785	13.12	13.2	1.019	0.150	0.15	44#
	802.11a	5825	/	/	/	/	/	/

EUT Position	Mode	Frequency (MHz)	Max. Meas. Power (dBm)	Max. Rated Power (dBm)	1 g SAR (W/kg), Limit=1.6W/kg			
					Scaled Factor	Meas. SAR	Scaled SAR	Plot
Close to Body-Back (10mm)	802.11a	5745	/	/	/	/	/	/
	802.11a	5785	13.12	13.2	1.019	0.179	0.18	45#
	802.11a	5825	/	/	/	/	/	/
Close to Body-Front (Remove display screen) (10mm)	802.11a	5745	/	/	/	/	/	/
	802.11a	5785	13.12	13.2	1.019	0.153	0.16	46#
	802.11a	5825	/	/	/	/	/	/

**Note:**

1. When the SAR value is less than half of the limit, testing for other channels are optional.
2. When SAR or MPE is not measured at the maximum power level allowed for production units, the results must be scaled to the maximum tune-up tolerance limit according to the power applied to the individual channels tested to determine compliance.

**Wi-Fi 5.8G Chain 1:**

EUT Position	Mode	Frequency (MHz)	Max. Meas. Power (dBm)	Max. Rated Power (dBm)	10 g SAR (W/kg), Limit=4.0W/kg			
					Scaled Factor	Meas. SAR	Scaled SAR	Plot
Handheld-Back (0mm)	802.11a	5745	/	/	/	/	/	/
	802.11a	5785	12.79	12.8	1.002	0.150	0.15	47#
	802.11a	5825	/	/	/	/	/	/
Handheld-Front (Remove display screen) (0mm)	802.11a	5745	/	/	/	/	/	/
	802.11a	5785	12.79	12.8	1.002	0.184	0.18	48#
	802.11a	5825	/	/	/	/	/	/

EUT Position	Mode	Frequency (MHz)	Max. Meas. Power (dBm)	Max. Rated Power (dBm)	1 g SAR (W/kg), Limit=1.6W/kg			
					Scaled Factor	Meas. SAR	Scaled SAR	Plot
Close to Body-Back (10mm)	802.11a	5745	/	/	/	/	/	/
	802.11a	5785	12.79	12.8	1.002	0.169	0.17	49#
	802.11a	5825	/	/	/	/	/	/
Close to Body-Front (Remove display screen) (10mm)	802.11a	5745	/	/	/	/	/	/
	802.11a	5785	12.79	12.8	1.002	0.208	0.21	50#
	802.11a	5825	/	/	/	/	/	/

**Note:**

3. When the SAR value is less than half of the limit, testing for other channels are optional.
4. When SAR or MPE is not measured at the maximum power level allowed for production units, the results must be scaled to the maximum tune-up tolerance limit according to the power applied to the individual channels tested to determine compliance.

## SAR Measurement Variability

In accordance with published RF Exposure KDB procedure 865664 D01 SAR measurement 100 MHz to 6 GHz v01. These additional measurements are repeated after the completion of all measurements requiring the same head or body tissue-equivalent medium in a frequency band. The test device should be returned to ambient conditions (normal room temperature) with the battery fully charged before it is re-mounted on the device holder for the repeated measurement(s) to minimize any unexpected variations in the repeated results

- 1) Repeated measurement is not required when the original highest measured SAR is < 0.80 W/kg; steps 2) through 4) do not apply.
- 2) When the original highest measured SAR is  $\geq 0.80$  W/kg, repeat that measurement once.
- 3) Perform a second repeated measurement only if the ratio of largest to smallest SAR for the original and first repeated measurements is  $> 1.20$  or when the original or repeated measurement is  $\geq 1.45$  W/kg (~ 10% from the 1-g SAR limit).
- 4) Perform a third repeated measurement only if the original, first or second repeated measurement is  $\geq 1.5$  W/kg and the ratio of largest to smallest SAR for the original, first and second repeated measurements is  $> 1.20$ .

*Note: The same procedures should be adapted for measurements according to extremity and occupational exposure limits by applying a factor of 2.5 for extremity exposure and a factor of 5 for occupational exposure to the corresponding SAR thresholds.*

### The Highest Measured SAR Configuration in Each Frequency Band

#### Body SAR

Frequency Band	Freq.(MHz)	EUT Position	Meas. SAR (W/kg)		Largest to Smallest SAR Ratio
			Original	Repeated	
(5700-5910 MHz) SDR 5.8G 1.4MHz Chain 0	5786.5	Close to Body-Top	0.807	0.779	1.04

**Note:**

1. Second Repeated Measurement is not required since the ratio of the largest to smallest SAR for the original and first repeated measurement is not  $> 1.20$ .
2. The measured SAR results **do not** have to be scaled to the maximum tune-up tolerance to determine if repeated measurements are required.
3. SAR measurement variability must be assessed for each frequency band, which is determined by the **SAR probe calibration point and tissue-equivalent medium** used for the device measurements..

## SAR SIMULTANEOUS TRANSMISSION DESCRIPTION

### Simultaneous Transmission:

Description of Simultaneous Transmit Capabilities	
Transmitter Combination	Simultaneous?
SDR 2.4G Chain 0 + SDR 2.4G Chain 1	×
SDR 5.8G Chain 0 + SDR 5.8G Chain 1	×
Wi-Fi 2.4G Chain 0 + Wi-Fi 2.4G Chain 1	√
Wi-Fi 5.8G Chain 0 + Wi-Fi 5.8G Chain 1	√
SDR 2.4G Chain 0(Chain 1) + Wi-Fi 2.4G Chain 0(Chain 1)	×
SDR 2.4G Chain 0(Chain 1) + Wi-Fi 5.8G Chain 0(Chain 1)	√
SDR 5.8G Chain 0(Chain 1) + Wi-Fi 2.4G Chain 0(Chain 1)	√
SDR 5.8G Chain 0(Chain 1) + Wi-Fi 5.8G Chain 0(Chain 1)	×
Wi-Fi 2.4G Chain 0 + Wi-Fi 2.4G Chain 1+ SDR 2.4G Chain 0(Chain 1)	×
<b>Wi-Fi 2.4G Chain 0 + Wi-Fi 2.4G Chain 1+ SDR 5.8G Chain 0(Chain 1)</b>	√
<b>Wi-Fi 5.8G Chain 0 + Wi-Fi 5.8G Chain 1+ SDR 2.4G Chain 0(Chain 1)</b>	√
Wi-Fi 5.8G Chain 0 + Wi-Fi 5.8G Chain 1+ SDR 5.8G Chain 0(Chain 1)	×

### Simultaneous SAR test exclusion considerations:

#### Simultaneous(Worst Case):

#### 10g Extremity SAR:

Mode(SAR1+SAR2+SAR3)	Position	Reported SAR(W/kg)			ΣSAR < 4.0 W/kg
		SAR1	SAR2	SAR3	
Wi-Fi 2.4G Chain 0 + Wi-Fi 2.4G Chain 1+ SDR 5.8G Chain 0	Handheld-Back	0.02	0.04	0.14	0.2
	Handheld-Front	0.06	0.04	0.24	0.34
Wi-Fi 2.4G Chain 0 + Wi-Fi 2.4G Chain 1+ SDR 5.8G Chain 1	Handheld-Back	0.02	0.04	0.15	0.21
	Handheld-Front	0.06	0.04	0.12	0.22
Wi-Fi 5.8G Chain 0 + Wi-Fi 5.8G Chain 1+ SDR 2.4G Chain 0	Handheld-Back	0.14	0.15	0.05	0.34
	Handheld-Front	0.15	0.18	0.31	<b>0.64</b>
Wi-Fi 5.8G Chain 0 + Wi-Fi 5.8G Chain 1+ SDR 2.4G Chain 1	Handheld-Back	0.14	0.15	0.04	0.33
	Handheld-Front	0.15	0.18	0.16	0.49

### Conclusion:

Sum of SAR: Σ SAR < 4.0 W/kg, simultaneous transmission SAR with Volume Scans is **not required**.

**1g Body SAR:**

Mode(SAR1+SAR2+SAR3)	Position	Reported SAR(W/kg)			ΣSAR < 1.6 W/kg
		SAR1	SAR2	SAR3	
Wi-Fi 2.4G Chain 0 + Wi-Fi 2.4G Chain 1+ SDR 5.8G Chain 0	Close to Body-Back	0.03	0.10	0.16	0.29
	Close to Body-Front	0.04	0.05	0.26	0.35
Wi-Fi 2.4G Chain 0 + Wi-Fi 2.4G Chain 1+ SDR 5.8G Chain 1	Close to Body-Back	0.03	0.10	0.15	0.28
	Close to Body-Front	0.04	0.05	0.14	0.23
Wi-Fi 5.8G Chain 0 + Wi-Fi 5.8G Chain 1+ SDR 2.4G Chain 0	Close to Body-Back	0.18	0.17	0.08	0.42
	Close to Body-Front	0.16	0.21	0.29	<b>0.66</b>
Wi-Fi 5.8G Chain 0 + Wi-Fi 5.8G Chain 1+ SDR 2.4G Chain 1	Close to Body-Back	0.18	0.17	0.06	0.41
	Close to Body-Front	0.16	0.21	0.19	0.56

**Conclusion:**

Sum of SAR: ΣSAR < 1.6 W/kg, simultaneous transmission SAR with Volume Scans is **not required**.



## **SAR Plots**

---

**Please Refer to the Attachment.**

## APPENDIX A MEASUREMENT UNCERTAINTY

The uncertainty budget has been determined for the measurement system and is given in the following Table.

**Measurement uncertainty evaluation for IEEE1528-2013 SAR test**

Source of uncertainty	Tolerance/uncertainty ± %	Probability distribution	Divisor	ci (1 g)	ci (10 g)	Standard uncertainty ± %, (1 g)	Standard uncertainty ± %, (10 g)
<b>Measurement system</b>							
Probe calibration	6.55	N	1	1	1	6.6	6.6
Axial Isotropy	4.7	R	√3	1	1	2.7	2.7
Hemispherical Isotropy	9.6	R	√3	0	0	0.0	0.0
Boundary effect	1.0	R	√3	1	1	0.6	0.6
Linearity	4.7	R	√3	1	1	2.7	2.7
Detection limits	1.0	R	√3	1	1	0.6	0.6
Readout electronics	0.3	N	1	1	1	0.3	0.3
Response time	0.0	R	√3	1	1	0.0	0.0
Integration time	0.0	R	√3	1	1	0.0	0.0
RF ambient conditions – noise	1.0	R	√3	1	1	0.6	0.6
RF ambient conditions–reflections	1.0	R	√3	1	1	0.6	0.6
Probe positioner mech. Restrictions	0.8	R	√3	1	1	0.5	0.5
Probe positioning with respect to phantom shell	6.7	R	√3	1	1	3.9	3.9
Post-processing	2.0	R	√3	1	1	1.2	1.2
<b>Test sample related</b>							
Test sample positioning	2.8	N	1	1	1	2.8	2.8
Device holder uncertainty	6.3	N	1	1	1	6.3	6.3
Drift of output power	5.0	R	√3	1	1	2.9	2.9
<b>Phantom and set-up</b>							
Phantom uncertainty (shape and thickness tolerances)	4.0	R	√3	1	1	2.3	2.3
Liquid conductivity target)	5.0	R	√3	0.64	0.43	1.8	1.2
Liquid conductivity meas.)	2.5	N	1	0.64	0.43	1.6	1.1
Liquid permittivity target)	5.0	R	√3	0.6	0.49	1.7	1.4
Liquid permittivity meas.)	2.5	N	1	0.6	0.49	1.5	1.2
Combined standard uncertainty		RSS				12.2	12.0
Expanded uncertainty 95 % confidence interval)						24.3	23.9

**Measurement uncertainty evaluation for IEC62209-2 SAR test**

Source of uncertainty	Tolerance/uncertainty ± %	Probability distribution	Divisor	ci (1 g)	ci (10 g)	Standard uncertainty ± %, (1 g)	Standard uncertainty ± %, (10 g)
<b>Measurement system</b>							
Probe calibration	6.55	N	1	1	1	6.6	6.6
Axial Isotropy	4.7	R	√3	1	1	2.7	2.7
Hemispherical Isotropy	9.6	R	√3	0	0	0.0	0.0
Linearity	4.7	R	√3	1	1	2.7	2.7
Modulation Response	0.0	R	√3	1	1	0.0	0.0
Detection limits	1.0	R	√3	1	1	0.6	0.6
Boundary effect	1.0	R	√3	1	1	0.6	0.6
Readout electronics	0.3	N	1	1	1	0.3	0.3
Response time	0.0	R	√3	1	1	0.0	0.0
Integration time	0.0	R	√3	1	1	0.0	0.0
RF ambient conditions – noise	1.0	R	√3	1	1	0.6	0.6
RF ambient conditions–reflections	1.0	R	√3	1	1	0.6	0.6
Probe positioner mech. Restrictions	0.8	R	√3	1	1	0.5	0.5
Probe positioning with respect to phantom shell	6.7	R	√3	1	1	3.9	3.9
Post-processing	2.0	R	√3	1	1	1.2	1.2
<b>Test sample related</b>							
Device holder Uncertainty	6.3	N	1	1	1	6.3	6.3
Test sample positioning	2.8	N	1	1	1	2.8	2.8
Power scaling	4.5	R	√3	1	1	2.6	2.6
Drift of output power	5.0	R	√3	1	1	2.9	2.9
<b>Phantom and set-up</b>							
Phantom uncertainty (shape and thickness tolerances)	4.0	R	√3	1	1	2.3	2.3
Algorithm for correcting SAR for deviations in permittivity and conductivity	1.9	N	1	1	0.84	1.1	0.9
Liquid conductivity (meas.)	2.5	N	1	0.64	0.43	1.6	1.1
Liquid permittivity (meas.)	2.5	N	1	0.6	0.49	1.5	1.2
Temp. unc. - Conductivity	1.7	R	√3	0.78	0.71	0.8	0.7
Temp. unc. - Permittivity	0.3	R	√3	0.23	0.26	0.0	0.0
Combined standard uncertainty		RSS				12.2	12.1
Expanded uncertainty 95 % confidence interval)						24.5	24.2

---

## APPENDIX B CALIBRATION CERTIFICATES

---

**Please Refer to the Attachment.**

---

## APPENDIX C EUT TEST POSITION PHOTOS

---

Please Refer to the Attachment.

**\*\*\*\*\* END OF REPORT \*\*\*\*\***