

There are two options for Dynamic Home Point.

1. Set the aircraft current coordinate as the new Home Point.
2. Set the mobile device's coordinate as the new Home Point.

Setting Up Dynamic Home Point

Follow the steps below to setup Dynamic Home Point:

1. Connect to the mobile device and launch the DJI Pilot app and go to the "Camera" page.
2. Tap "📍" and select "📍", to set the mobile device's coordinates as the new Home Point.
3. Tap "📍" and select "📍", to set the aircraft's coordinates as the new Home Point.
4. The aircraft status indicator blinks green to show Home Point is set successfully.

Vision Positioning System

DJI Vision Positioning is a positioning system that uses ultrasonic and image data to help the aircraft identify its current position. With the help of Vision Positioning, your Phantom 3 Professional can hover in place more precisely and fly indoors or in other environments where there is no GPS signal available. The main components of DJI Vision Positioning are located on the bottom of your Phantom 3 Professional, including [1] one monocular camera and [2] two sonar sensors.

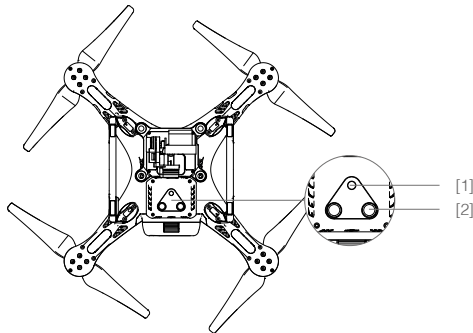

Using Vision Positioning

Vision Positioning is activated automatically when the Phantom 3 Professional is powered on. No manual action is required. Vision Positioning is typically used in the indoor environment where no GPS is available. By using the sensors on the Vision Positioning system, Phantom 3 Professional can perform precision hovering even when no GPS is available.

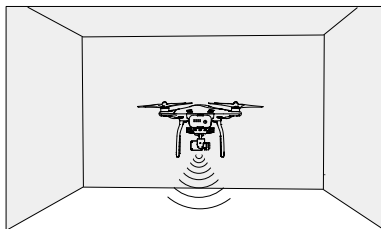



Follow the steps below to use Vision Positioning:

1. Toggle the switch to “P” mode.
2. Place the aircraft on a flat surface. Notice that the Vision Positioning system cannot work properly on surfaces without pattern variations.
3. Power on the aircraft. The aircraft status indicator will flash twice in green light, which indicates the Vision Positioning system is ready. Gently push the throttle up to lift off, and the aircraft will hover in place.

 The performance of your Vision Positioning System is subject to the surface you are flying over. The ultrasonic waves may not be able to accurately measure the distance over sound absorbing materials, and the camera may not function correctly in suboptimal environments. The aircraft will switch from “P” mode to “A” mode automatically if both GPS and Vision Positioning System are not available. So operate the aircraft cautiously when in any of the following situations:

- Flying over monochrome surfaces (e.g. pure black, pure white, pure red, pure green).
- Flying over a highly reflective surfaces.
- Flying at high speeds(over 8 m/s at 2 meters or over 4 m/s at 1 meter).
- Flying over water or transparent surfaces.
- Flying over moving surfaces or objects.
- Flying in an area where the lighting changes frequently or drastically.
- Flying over extremely dark (lux < 10) or bright (lux > 100,000) surfaces.
- Flying over surfaces that can absorb sound waves (e.g. thick carpet).
- Flying over surfaces without clear patterns or texture.
- Flying over surfaces with identical repeating patterns or textures (e.g. tiles with same design).
- Flying over inclined surfaces that will deflect sound waves away from the aircraft.

-
-  • Keep the sensors clean at all times. Dirt or other debris may adversely affect the effectiveness of the sensors.
- The effective hovering altitudes of the aircraft is from 0 to 3 meters.
 - Vision Positioning system may not function properly when the aircraft is flying over water.
 - Vision Positioning system may not be able to recognize pattern on the ground in low light conditions (less than 100 lux).
 - Do not use other ultrasonic devices with frequency of 40 KHz when Vision Positioning system is in operation.
 - Vision Positioning system may not be able to stabilize the aircraft when flying close to the ground (below 0.5 meters) in fast speed.

-
-  Keep the animals away from the aircraft when Vision Positioning system is activated. The sonar sensor emits high frequency sound that is only audible to some animals.
-





Flight Recorder

Flight data is automatically recorded to the SD card. This includes flight telemetry, aircraft status information, and other parameters. Access these data from the DJI Pilot app through the Aircraft Micro-USB Port.

Attaching and Detaching the Propellers

Use only DJI approved propellers with your Phantom 3 Professional. The grey or black nut on the propeller indicates the rotation direction of the propeller and where it should be attached. To attach

the propellers properly, match the nut with the axis on the motors of your Phantom 3 Professional.

Propellers	Grey cap	Black cap
Figure		
Attach On	Motors with a grey axis	Motors with a black axis
Legends	 Lock : Turn the propellers in the indicated direction to mount and tighten  Unlock : Turn the propellers in the indicated direction to loosen and remove	

Attaching the Propellers

1. Attach the propellers with a grey nut onto a motor with the grey axis and spin the propellers clockwise to secure them in place. Attach the propellers with a black nut onto a motor with the black axis and spin the propellers counter clockwise to secure its position. Be sure to completely tighten each propeller by hand before flight.

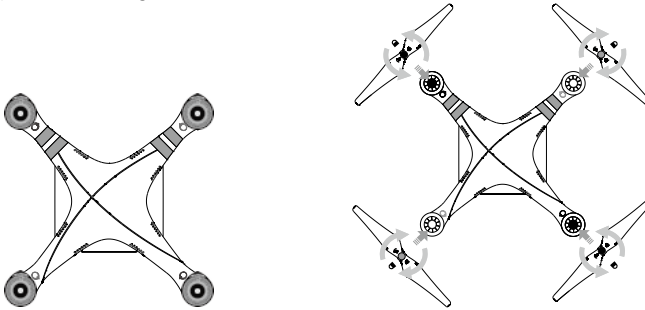

- ⚠ • Ensure propellers are attached to its corresponding motors, otherwise the aircraft cannot take off.
- Wear gloves when handling propellers.
- Manually tighten each of the propellers on the corresponding motors to ensure it is attached firmly.

Detaching the Propellers

Hold the motor still. Then spin the propeller in the unlock direction indicated on the propeller itself.

- ⚠ • Check that the propellers and motors are installed correctly and firmly before every flight.
- Ensure that all propellers are in good condition before each flight. DO NOT use aged, chipped, or broken propellers.
- To avoid injury, STAND CLEAR of and DO NOT touch propellers or motors when they are spinning.
- ONLY use original DJI propellers for a better and safer flight experience.

DJI Intelligent Flight Battery

The DJI Intelligent Flight Battery has a capacity of 4480 mAh, voltage of 15.2 V, and smart charge-discharge functionality. It can only be charged with an appropriate DJI approved charger.

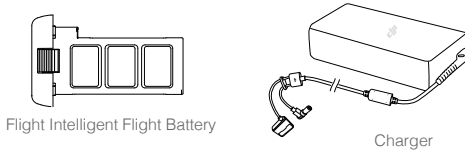

⚠ Battery must be fully charged before using it for the first time. Refer to "Charging the Intelligent Flight Battery" for more information .

💡 Be aware that the output power of the supplied Phantom 3 Professional charger is 100W.

Aircraft

DJI Intelligent Flight Battery Functions

1. Battery Level Display: LEDs display the current battery level.
2. Battery Life Display: LEDs display the current battery power cycle.
3. Auto-discharging Function: The battery automatically discharges to below 65% of total power when it is idle for more than 10 days to prevent swelling. It takes around 2 days to discharge the battery to 65%. It is normal to feel moderate heat emitting from the battery during the discharge process. Discharge thresholds can be set in the DJI Pilot app.
4. Balanced Charging: Automatically balances the voltage of each battery cell when charging.
5. Over charge Protection: Charging automatically stops when the battery is fully charged.
6. Temperature Detection: The battery will only charge when the temperature is between 0°C(32°F) and 40°C (104°F).
7. Over Current Protection: Battery stops charging when high amperage (more than 8 A) is detected.
8. Over Discharge Protection: Discharging automatically stops when the battery voltage reaches 12 V to prevent over-discharge damage
9. Short Circuit Protection: Automatically cuts the power supply when a short circuit is detected.
10. Battery Cell Damages Protection: DJI Pilot app shows warning message when damaged battery cell is detected.
11. Battery Error History Browse the battery error history from the DJI Pilot app.
12. Sleep Mode: Sleep mode is entered after 20 minutes of inactivity to save power.
13. Communication: Battery voltage, capacity, current, and other relevant information is provided to the aircraft's to the main controller.

⚠ Refer to *Disclaimer* and *Intelligent Flight Battery Safety Guidelines* before use. Users take full responsibility for all operations and usage.

Using the Battery

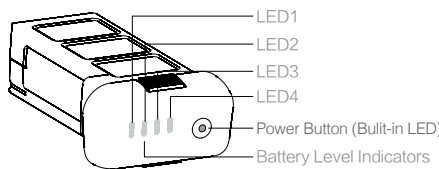

Powering ON/OFF

Powering On: Press the Power Button once, then press again and hold for 2 seconds to power on. The Power LED will turn red and the Battery Level Indicators will display the current battery level.

Powering Off: Press the Power Button once, then press again and hold for 2 seconds to power off.

Low Temperature Notice:

1. Battery capacity is significantly reduced when flying in low temperature environment ($< 0^{\circ}\text{C}$).
2. It is not recommended to use the battery in extremely low temperature ($< -10^{\circ}\text{C}$) environment. Battery voltage should reach to the appropriate level when using in the environment where temperature range between minus 10°C to 5°C .
3. Stop flying when DJI Pilot app displays "Low Battery Level Warning" in low temperature environment.
4. Place the battery indoors to warm up the battery before using it in the low temperature environment.
5. To ensure the performance of the battery, keep the battery body temperature above 20°C .





































 In cold environments, insert the battery into the battery compartment and allow the aircraft to warm up for approximately 1-2 minutes before taking off.

Checking the battery level

The Battery Level Indicators display how much remaining power the battery has. When the battery is powered off, press the Power Button once. The Battery Level Indicators will light up to display the current battery level. See below for details.

 The Battery Level Indicators will also show the current battery level during charging and discharging. The indicators are defined below.

 : LED is on.  : LED is flashing.
 : LED is off.

Battery Level				
LED1	LED2	LED3	LED4	Battery Level
				87.5%~100%
				75%~87.5%
				62.5%~75%
				50%~62.5%
				37.5%~50%
				25%~37.5%
				12.5%~25%
				0%~12.5%
				=0%

Battery life

The battery life indicates how many more times the battery can be discharged and recharged before it must be replaced. When the battery is powered off, press and hold the Power Button for 5 seconds to check the battery life. The Battery Level Indicators will light up and/or blink as described below for 2 seconds:

Battery Life				
LED1	LED2	LED3	LED4	Battery Life
□	□	□	□	90%~100%
□	□	□	▤	80%~90%
□	□	□	□	70%~80%
□	□	▤	□	60%~70%
□	□	□	□	50%~60%
□	▤	□	□	40%~50%
□	□	□	□	30%~40%
▤	□	□	□	20%~30%
□	□	□	□	below 20%

⚠ When battery life reaches 0%, it can no longer be used.

📖 For more information about the battery, launch DJI Pilot app and check the information under the battery tab.

Charging the Intelligent Flight Battery

1. Connect Battery Charger to a power source (100-240 V 50/60 Hz).
2. Open the Protection Cap and connect the Intelligent Flight Battery to the Battery Charger. If the battery level is above 95%, turn on the battery before charging.
3. The Battery Level Indicator will display the current battery level during charging.
4. The Intelligent Flight Battery is fully charged when Battery Level Indicators are all off.
5. Air cool the Intelligent Flight Battery after each flight. Allow its temperature to drop to room temperature before storing it for an extended period.

⚠ • Always turn off the battery before inserting it or removing it from the Phantom 3 Professional. Never insert or remove a battery when it is powered on.

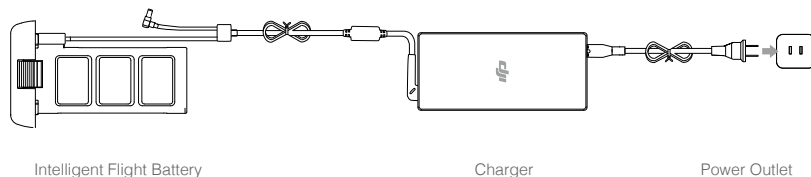

Battery Level Indicators while Charging				
LED1	LED2	LED3	LED4	Battery Level
				0%~25%
				25%~50%
				50%~75%
				75%~100%
				Fully Charged

Charging Protection LED Display

The table below shows battery protection mechanisms and corresponding LED patterns.

Battery Level Indicators while Charging					
LED1	LED2	LED3	LED4	Blinking Pattern	Battery Protection Item
				LED2 blinks twice per second	Over current detected
				LED2 blinks three times per second	Short circuit detected
				LED3 blinks twice per second	Over charge detected
				LED3 blinks three times per second	Over-voltage charger detected
				LED4 blinks twice per second	Charging temperature is too low
				LED4 blinks three times per second	Charging temperature is too high

After any of the above mentioned protection issues are resolved, press the button to turn off the Battery Level Indicator. Unplug the Intelligent Flight Battery from the charger and plug it back in to resume charging. Note that you do not need to unplug and plug the charger in the event of a room temperature error, the charger will resume charging when the temperature falls within the normal range.



- DJI does not take any responsibility for damage caused by third-party chargers.



How to discharge your Intelligent Flight Battery:

Slow : Place the Intelligent Flight Battery into the Phantom 3 Professional's Battery Compartment and power it on. Leave it on until there is less than 8% of power left, or until the battery can no longer be turned on. Launch the DJI Pilot app to check battery levels.

Rapid : Fly the Phantom 3 Professional outdoors until there is less than 8% of power left, or until the battery can no longer be turned on.

Remote Controllers

This chapter describes the features of the remote controller that includes, how to operate the aircraft and camera.

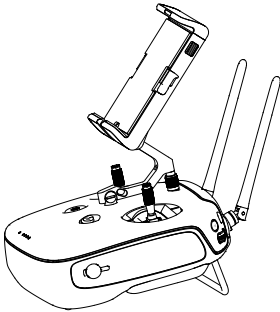

Remote Control

Remote Controller Profile

The Phantom 3 Professional remote control is a multi-function wireless communication device that integrates the video downlink ground system and aircraft remote control system. The video downlink and aircraft remote control system operate at 2.4 GHz. The remote controller features a number of camera functions, such as taking and previewing photos and video, and controlling gimbal motions. The remote controller is powered by a 2S rechargeable battery. The current battery level is displayed by LEDs on the front panel of the remote control.



- **Compliance Version:** The remote control is compliant with both CE and FCC regulations.
- **Operating Mode:** Control can be set to Mode 1 , Mode 2.
- **Mode 1:** The right stick serves as the throttle.
- **Mode 2:** The left stick serves as the throttle.



Do not operate more than 3 aircrafts within in the same area (size equivalent to a soccer field) to prevent transmission interference.

Remote Controller Operations

Powering On and Off the Remote Controller

The Phantom 3 Professional remote controller is powered by a 2S rechargeable battery with a capacity of 6000 mHA. The battery level is indicated by the Battery Level LEDs on the front panel. Follow the steps below to power on your remote controller:

1. When powered off, press the Power Button once and the Battery Level LEDs will display the current battery level.
2. Press and hold the Power Button to power on the remote controller.
3. The remote controller beeps when it is powered on. The Status LED will blink green rapidly, indicating that the remote controller is linking to the aircraft. The Status LED will show a solid green light when linking is complete.
4. Repeat step 2 to power off the remote controller.

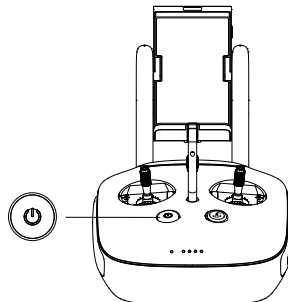

Charging Remote Controller

Charge the remote controller via supplied charger. Refer to the figure below for more details.

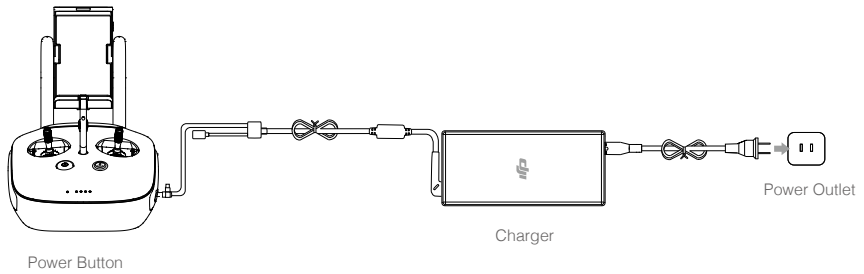

Controlling Camera

Shoot videos or images and adjust camera settings via the Shutter Button, Camera Settings Dial, Playback Button and Video Recording Button on the remote control.

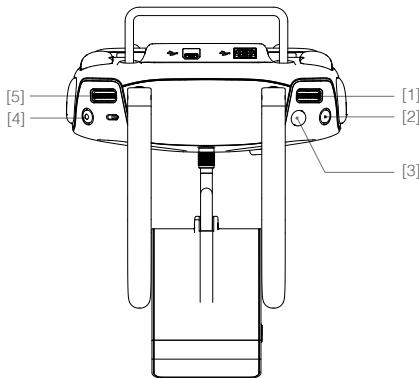

[1] Camera Settings Dial

Turn the dial to quickly adjust camera settings such as ISO, shutter speed, and aperture without letting go of the remote controller. Move the dial button to left or right to view the pictures or videos in playback mode.

[2] Playback Button

Press to view images or videos that have already been captured.

[3] Shutter Button

Press to take a photo. If burst mode is activated, multiple photos will be taken with a single press.

[4] Recording Button

Press once to start recording video, then press again to stop recording.





[5] Gimbal Dial

Use this dial to control the tilt of the gimbal.

Controlling Aircraft

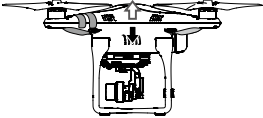
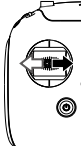
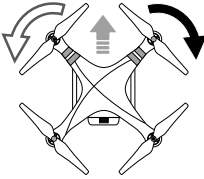
This section explains how to control the orientation of the aircraft through the remote controller. The Remote Control is set to Mode 2 by default.

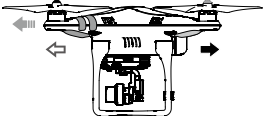
-  Stick Neutral/ mid point: Control sticks of the Remote Control are placed at the central position.
 Move the Stick: The control stick is pushed away from the central position.

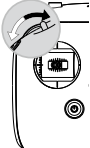
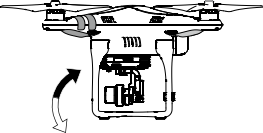
Remote Control (Mode 2)	Aircraft (● indicates nose direction)	Remarks
		<p>Moving the left stick up and down changes the aircraft's elevation.</p> <p>Push the stick up to ascend and down to descend. Push the throttle stick up to takeoff.</p> <p>When both sticks are centered, the Phantom 3 Professional will hover in place.</p> <p>The more the stick is pushed away from the center position, the faster the Phantom 3 Professional will change elevation. Always push the stick gently to prevent sudden and unexpected elevation changes.</p>
		<p>Moving the left stick to the left or right controls the rudder and rotation of the aircraft.</p> <p>Push the sick left to rotate the aircraft counter clock-wise, and push the stick right to rotate the aircraft clockwise. If the stick is centered, the Phantom 3 Professional will stay facing its current direction.</p> <p>The more the stick is pushed away from the center position, the faster the Phantom 3 Professional will rotate.</p>
		<p>Moving the right stick up and down changes the aircraft's forward and backward pitch.</p> <p>Push the stick up to fly forward and down to fly backward. Phantom 3 Professional will hover in place if the stick is centered.</p> <p>Push the stick further away from the center position for a larger pitch angle (maximum 30°) and faster flight.</p>
		<p>Moving the right stick control left and right changes the aircraft's left and right pitch.</p> <p>Push left to fly left and right to fly right. The Phantom 3 Professional will hover in place if the stick is centered.</p> <p>Push the stick further away from the center position for a larger pitch angle (maximum 30°) and faster flight.</p>
		<p>Gimbal Dial: Turn the dial to the right, and the camera will shift to point upwards. Turn the dial to the left, and the camera will shift to point downwards. The camera will remain in its current position when dial is static.</p>

Flight Mode Switch

Toggle the switch to select the desired flight mode. You may choose between; P mode, F mode and A mode.

Position	Figure	Flight Mode
Position 1		F mode
Position 2		A mode
Position 3		P mode

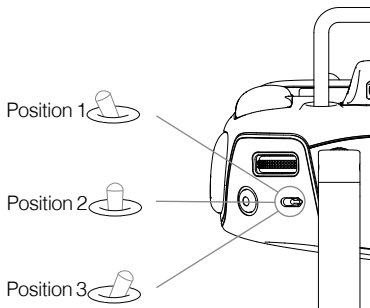

P mode (Positioning) : P mode works best when GPS signal is strong. There are three different states of P mode, which will be automatically selected by the Phantom 3 Professional depending on GPS signal strength and Vision Positioning sensors:

P-GPS: GPS and Vision Positioning both are available, and the aircraft is using GPS for positioning.

P-OPTI: Vision Positioning is available but the GPS signal is not. Aircraft is using only Vision Positioning for hovering

P-ATTI: Neither GPS or Vision Positioning available, aircraft is using only its barometer for positioning, so only altitude is controlled.

A mode (Attitude): GPS and Vision Positioning System is not used for stabilization. The aircraft only uses its barometer to stabilize. The aircraft can automatically return home if remote control signal is lost if the Home Point is recorded successfully.

F mode (Function): Intelligent Orientation Control (IOC) is activated in this mode. For more information about IOC, refer to the IOC in Appendix.

The Flight Mode Switch is locked in P mode by default. To unlock the switch, launch the DJI Pilot app, enter the “Camera” page, tap “MODE”, and then activate “Multiple Flight Mode” .

RTH button

Press and hold this button to start the Return to Home (RTH) procedure. The LED around the RTH Button will blink white to indicate the aircraft is entering RTH mode. The aircraft will then return to the last recorded Home Point. Press this button again to cancel the RTH procedure and regain the control of the aircraft.

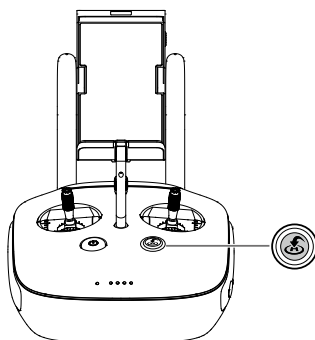

Connecting Mobile Device

Tilt the Mobile Device Holder to the desired position. Press the button on the side of the Mobile Device Holder to release the clamp, and then place your mobile device into the clamp. Adjust the clamp to secure your mobile device. Then connect your mobile device to the remote controller with a USB cable. Plug one end of the cable into your mobile device, and the other end into the USB port on the back of the remote controller.

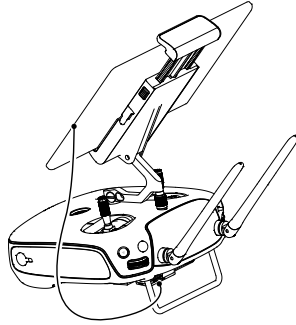

Optimal Transmission Range

The signal transmission between aircraft and remote controller perform best within the range that displayed in the picture shown below:

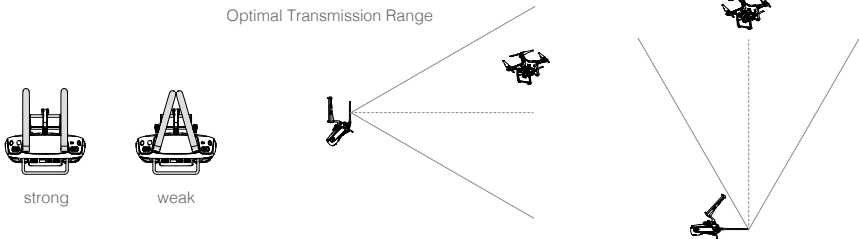

Ensure the aircraft is flying within the optimal transmission range. Adjust the distance and position between the operator and the aircraft to achieve optimal transmission performance.

Remote Controller Status LED

The Status LED reflects connection status between remote control and aircraft. The RTH LED shows the Return to Home status of the aircraft. The table below contains details on these indicators.

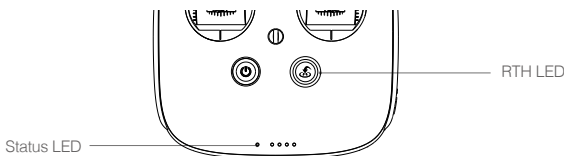

Status LED	Alarm	Remote Controller Status
— Solid Red	chime	The remote controller is disconnected from the aircraft.
— Solid Green	chime	The remote controller is connected with the aircraft.
..... Slow Blinking Red	D-D-D.....	Remote controller error.
/ Red and Green/ Red and Yellow Alternate Blinks	None	HD downlink is disrupted.
RTH LED	Sound	Remote Controller Status
— Solid White	chime	Aircraft is returning home.
..... Blinking White	D . . .	Sending Return to Home command to the aircraft.
..... Blinking White	DD	Aircraft Return to Home in progress.

The Remote Status Indicator will blink red, sound an alert, when the battery level is critically low.

Linking the Remote Controller

The remote controller is linked to your aircraft before delivery. Linking is only required when using a new remote controller for the first time. Follow these steps to link a new remote controller:

1. Power on the remote controller and connect to the mobile device. Launch DJI Pilot app.
2. Power on the Intelligent Flight Battery.
3. Enter “Camera” view and tap on and then tap “Linking RC” button as shown below.

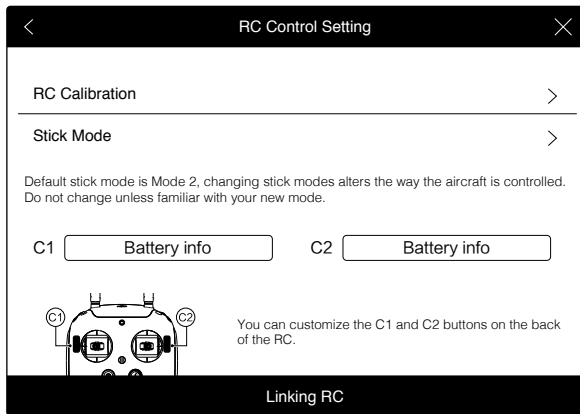

4. The remote controller is ready to link. The Remote Controller Status Indicator blinks blue and "beep" sound is emitted.

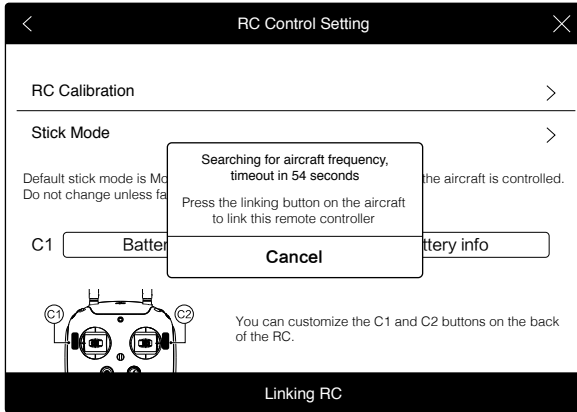

5. Locate the Linking button on the side of the aircraft, as shown in the figure shown below. Press the Linking button to start linking. The LED to the left of the linking button blinks green to indicate that the aircraft is ready to link, and it blinks solid green when linking is complete. The Remote Controller Status Indicator will display solid green if Link is succeed.

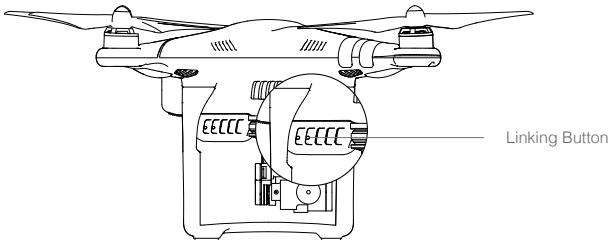

- Remote controller will disconnect from the linked aircraft if a new remote controller is linked to the same aircraft.

Remote Controller Compliance Version

The remote controller is compliant with both CE and FCC requirements.

Gimbal Camera

This chapter provides the technical specifications of the camera, explains the operating mode of the gimbal.

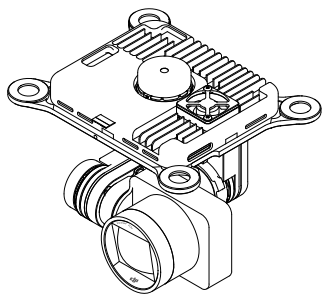

Camera and Gimbal

Camera Profile

The on-board camera supports 4K video capture up to 4096 x 2160p24 and 12M pixel photos capture by using the 1/2.3 inch CMOS sensor. You may export the video in either MOV or MP4 format for editing. Available picture shooting modes include burst, continuous, and time-lapse mode. A live preview of what the camera is seeing before you shoot videos and pictures is supported through the DJI Pilot App.

Camera Micro-SD Card Slot

To store your photos and videos, plug in the Micro-SD card into the slot shown below before powering on the Phantom 3 Professional. The Phantom 3 Professional comes with a 16 GB Micro-SD card and supports up to a 64 GB Micro-SD card. A UHS-1 type Micro-SD card is recommended, because of the fast read and write capability of these cards enables you to store high-resolution video data.

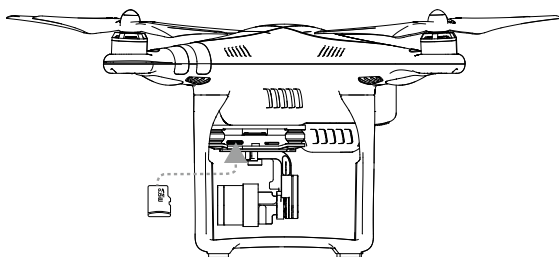

⊘ Do not remove Micro-SD card from the Phantom 3 Professional when it is powered on.

Camera Data Port

Power on the Phantom 3 Professional and then connect a USB cable to the Camera Data Port to download photos or videos from the camera to your computer.

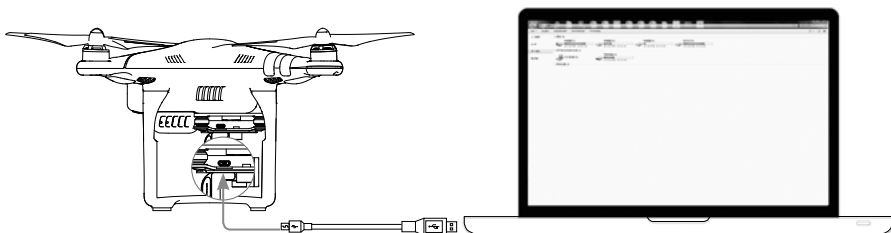

⚠ Power on the aircraft before attempting to access the files on the Micro-SD card.

Camera Operation

Use the Shutter and Record button on the remote controller to shoot the images or the videos through the DJI Pilot app. For more information about how to use these buttons, refer to "Controlling Camera".

Gimbal

Gimbal Profile

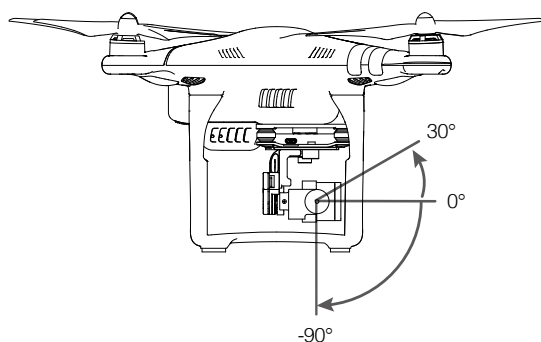

The 3-axis Gimbal provides a steady platform for the attached camera, allowing you to capture stabilized images and video. The Gimbal can tilt the camera up to 120 degrees.



Use the gimbal dial on the remote controller to control pitch movement of the camera by default. Note that you cannot control the pan movement of the camera by default.

Gimbal Operation Modes

Two Gimbal operation modes are available. Switch between the different operation modes on the Camera page of the DJI Pilot App. Note that your mobile device must be connected to the remote controller for changes to take effect. Refer to the table below for details:

	Follow Mode	The angle between Gimbal's orientation and aircraft's nose remains constant at all times. One user alone can control the pitch motion of the gimbal.
	FPV Mode	The Gimbal will lock to the movements of the aircraft to provide a First-Person-View flying experience.



- Gimbal motor error may occur in these situations: (1) Gimbal is placed on uneven ground. (2) Gimbal has received an excessive external force, e.g. a collision. Please take off from flat, open ground and protect the gimbal after powering up.
- Flying in heavy fog or cloud may make the gimbal wet, leading to a temporary failure. The gimbal will recover when it dries out.

Anti-drop Kit

The Anti-drop Kit helps keep the gimbal and camera connected to the aircraft. Two have been mounted on delivery. If new ones are required, take the gimbal and press part [1] through the center hole of the Vibration Absorber the center hole of part [2]. Lock them together as shown in [3]. Mounting the Anti-drop Kit diagonally is recommended.

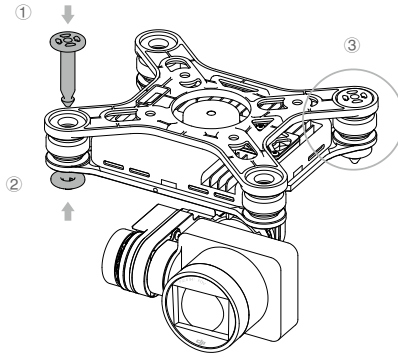

DJI Pilot App

This chapter introduce the four main sections of the DJI Pilot app.

DJI Pilot App

The DJI Pilot app is a mobile app designed specifically for the Phantom 3 Professional. Use this app to control the gimbal, camera and other features of your flight system. The app also comes with Map, Academy and User Center, for configuring your aircraft and sharing the photos and videos with your friends. It is recommended that you use a tablet for the best experience.

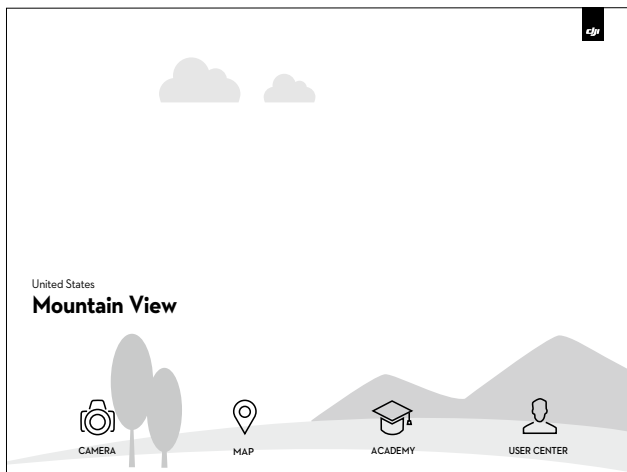

Camera

The Camera page contains a live HD video feed from the Phantom 3 Professional's camera. You can also configure various camera parameters from the Camera page.

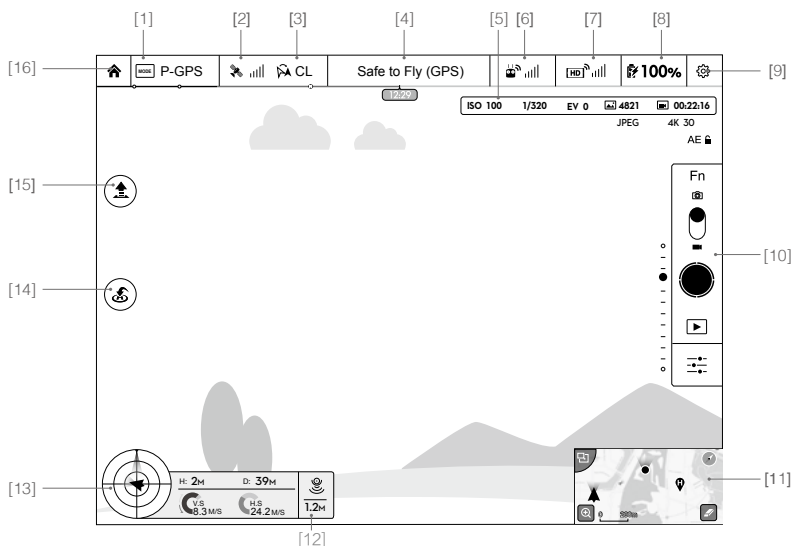

[1] Flight Mode

: The text next to this icon indicates the current flight mode. Tap to enter MC (Main Controller) Settings. Modify flight limits, perform compass calibration, and set the gain values.

[2] GPS Signal Strength

: This icon shows the current strength of GPS signals. Green bars indicates adequate GPS strength.

[3] IOC Settings

 OFF : This icon shows which IOC setting that the aircraft has entered when in F Mode. Tap to enter IOC setting menu and select the desired IOC setting.

[4] System Status

 : This icon shows current aircraft system status, such as GPS signal health.

[5] Battery Level Indicator

 : The battery level indicator dynamically displays the battery level. The color zones on the battery level indicator represent different battery levels.

[6] Remote Controller Signal

: This icon shows the strength of remote controller signal.

[7] HD Video Link Signal Strength

: This icon shows the HD video downlink signal strength between the aircraft and the remote controller.

[8] Battery Level

 100%: This icon shows the current battery level.

Tap to enter battery information menu, set the various battery warning thresholds and view the battery warning history in this page.

[9] General Settings

 : Tap this icon to enter General Settings page. Select parameter metric, reset the camera, enable the quick view feature, adjust the gimbal pitch value and toggle flight route display on this page.

[10] Camera Operation Bar

Shutter

 : Tap this button to take a single photo. Press and hold this button to select burst or time-lapsed shooting.

Record

 : Tap once to start recording video, then tap again to stop recording. You can also press the Video Recording Button on the remote controller, which has the same function.

Playback

 : Tap to enter playback page. You can preview photos and videos as soon as they are

captured.

Camera Settings

: Tap to enter the camera exposure value setting. User may switch from Auto exposure mode to Advance or Manual mode.

[11] Map

Display the flight path of the current mission. Tap to switch from the Camera GUI to the Map GUI.



[12] Vision Positioning

: This icon shows the distance between the surface and the Vision Positioning System's sensors.

[13] Flight Telemetry

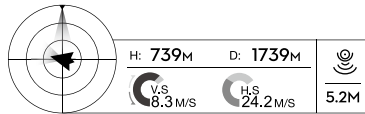

Vision Positioning Status

Icon is highlighted when Vision Positioning is in operation.

Flight attitude is indicated by the flight attitude icon.

- (1) The red arrow shows which direction the aircraft is facing.
- (2) Light blue and dark blue areas indicate pitch.
- (3) Pitching of the boundary between light blue and dark blue area shows roll angle.

[14] Return to Home (RTH)

: Initiate RTH home procedure. Tap to have the aircraft return to the last recorded home point.

[15] Auto Takeoff/Landing

  : Tap to initiate auto takeoff or landing.

[16] Back

 : Tap to return to the main GUI.

Map

User can view the current flight route in a larger map view in this page. You can also perform Auto takeoff and Landing in the page. Ensure your mobile device has access to the Internet. Due to the map data required, Wi-Fi connection is recommended. Internet access is required to cache the map, if Wi-Fi is unavailable, mobile data service is required.

Academy

Download user manual, view tutorial videos and practice your flight skills using the simulator in this page. You can also use FilmMaker to create and edit the video clips captured by the aircraft.

User Center

You can sync the picture and videos to the mobile device, view the flight records and check your DJI account status in the User Center. Use the DJI registered account to login to the User Center.

Flight

This chapter describes the flight safety and flight restrictions.

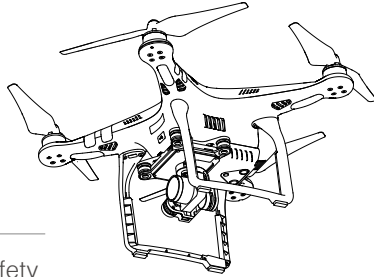

Flight

Once pre-flight preparation is complete, it is recommended to use the flight simulator in the DJI Pilot App to practice the flight skills and learn to fly safely. Ensure that all flights are carried out in a wide open area.

Flight Environment Requirements

1. Do not use the aircraft in severe weather conditions. These include wind speed exceeding 10 m/s , snow, rain and smog.
2. Only fly in open areas. Tall and steel structures may affect the accuracy of the on-board compass and GPS signal.
3. Avoid approaching the obstacles, crowds, high voltage power lines, trees or bodies of water.
4. Minimize electromagnetic interference by not flying in the area with high levels of electromagnetism, including base stations or radio transmission towers.
5. Aircraft and battery performance is subject to environment factor such as air density and temperature. Be very careful when flying 19, 685 feet (6000 m) or more above sea level as battery and aircraft performance may be affected.
6. The Phantom 3 Professional cannot operate within the polar areas.

Flight Limits and Flight Restriction Area



All unmanned aerial vehicle (UAV) operators should abide by all regulations from such organizations as the ICAO (International Civil Aviation Organization), FAA and their own national airspace regulations. For safety reasons, the flight limits function is enabled by default to help users use this product safely and legally. The flight limits function includes height limits, distance limits and No Fly Zones.

When operating in "P" Mode, height, distance limits and No Fly Zones work together to manage flight. In "A" mode only height limits work and flights cannot go higher than 1640 feet (500 m) .

Maximum flight altitude & Radius Limits

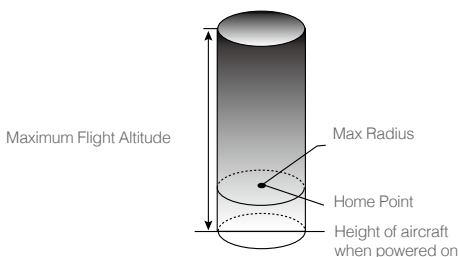
Maximum flight altitude & Radius limit flying height and distance, and the user may change these settings in the DJI Pilot App. For Be aware that, the maximum flight altitude value cannot exceed 1640 feet (500 m). Once complete, your Phantom 3 Professional will fly in a restricted cylinder that is determined by these settings. The tables below show the details of these limits.



GPS Signal Strong  Blinking Green			
	Flight Limits	DJI Pilot App	Aircraft Status Indicator
Maximum Flight Altitude	Aircraft's altitude cannot exceed the specified value.	Warning: Height limit reached.	None.
Max Radius	Flight distance must be within the max radius.	Warning: Distance limit reached.	Rapid red flashing  when close to the max radius limit.

GPS Signal Weak  Blinking Yellow			
	Flight Limits	DJI Pilot App	Aircraft Status Indicator
Maximum Flight Altitude	Flight height restricted to 1640 feet (500 m) and under.	Warning: Height limit reached.	None.
Max Radius	No limits		



- If you fly out of the limit, you can still control the Inspire, but cannot fly it further.
- If the Inspire flies out of the max radius in Ready to Fly (non-GPS) mode, it will fly back within range automatically.

Flight Restriction of Restricted Areas

Restricted areas include airports worldwide. All restricted areas are listed on the DJI official website at <http://www.dji.com/fly-safe/category-mc>. Restricted areas are divided into category A and category B. Category A areas cover major international airport such as LAX and Heathrow and no-drone zones, while category B areas includes smaller airports.

Category A Safety Zone

- (1) The category A "safety zone" is comprised of a small "no-fly zone" and a range of "restricted-altitude zones". Flight is prevented in the "no-fly zone" but can continue with height restrictions in the restricted-altitude zone.
- (2) A radius of R1 miles (km) around a designated safety zone is a no-fly zone, inside which takeoff is prevented. The value of R1 is determined by the size of the airport.
- (3) From R1 to R1 + 1 miles (R1 + 1.6 km) around restricted areas are altitude restricted, with maximum altitude going from 66 feet (20 m) at R1 miles to 1640 feet (500 m) at R1 + 1 miles (R1 + 1.6 km).
- (4) A "warning zone" has been set around the safety zone. When you fly within 320 feet (100m) of the safety zone, a warning message will appear on the DJI Pilot App.

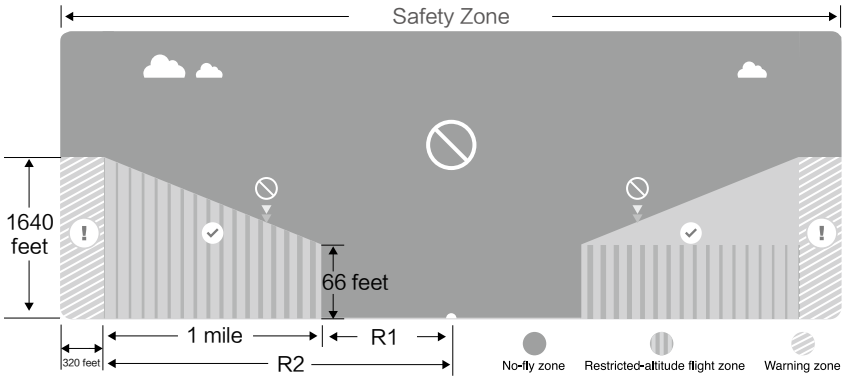





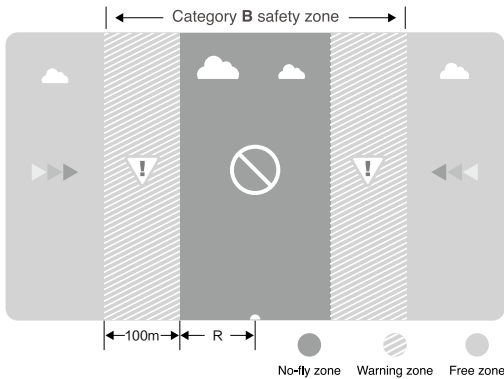

Category B Safety Zone

- (1) Category B "safety zone" is comprised of a "no-fly zone" and a "warning zone".
- (2) R mile around the safety zone is a designated "no-fly zone". The value of R is determined by the size of the airport.
- (3) A "warning zone" has been set around the safety zone. When you fly within 0.6 miles (1 km) of this zone, a warning will appear on the DJI Pilot App.



Flight

GPS Signal Strong  Blinking Green			
Zone	Restriction	DJI Pilot App Prompt	Aircraft Status Indicator
No-fly Zone 	Motors will not start.	Warning: You are in a No-fly zone. Take off prohibited.	 Red flashing
	If the aircraft enters the restricted area in A mode but P mode activates the aircraft will automatically descend to land then stop its motors after landing.	Warning: You are in a No-fly zone, automatic landing has begun. (aircraft is entering the area within R1 radius)	
Restricted-altitude flight zone 	If the aircraft enters the restricted area in A mode but P mode activates, it will descend to a safe altitude and hover 15 feet (4.5 m) below the safe altitude.	Warning: You are in a restricted zone. Descending to safe altitude. (If you are between the range of R1 and R2 radius) Warning: You are in a restricted zone. Max flight height restricted to between 20 m and 500 m. Fly Cautiously.(If you are between the range of R1 and R2 radius)	
Warning zone 	No flight restriction applies, but there will be warning message.	Warning: You are approaching a restricted zone, Fly Cautiously.	
Free zone 	No restrictions.	None.	

 Semi-automatic descent: All stick commands are available except the throttle stick command during the descent and landing process. Motors will stop automatically after landing.

-  • When flying in the safety zone, aircraft status indicator will blink red quickly and continue for 3 seconds, then switch to indicate current flying status and continue for 5 seconds at which point it will switch back to red blinking.
- For safety reasons, please do not fly close to airports, highways, railway stations, railway lines, city centers and other special areas. Maintain line of sight of the aircraft.

Preflight Checklist

1. Remote controller, Intelligent Flight Battery, and mobile device are fully charged.
2. Propellers are mounted correctly and firmly.
3. Micro-SD card has been inserted if necessary.
4. Gimbal is functioning as normal.
5. Motors can start and are functioning as normal.
6. DJI Pilot app connected to the aircraft.

Calibrating the Compass

IMPORTANT: Make sure to calibrate the compass in every new flight location. The compass is very sensitive to electromagnetic interference, which can cause abnormal compass data leading to poor flight performance or even failure. Regular calibration is required for optimum performance.

- ⊘ • DO NOT calibrate your compass where there is a chance of strong magnetic interference, such as magnetite, parking structures, and steel reinforcements underground.
- DO NOT carry ferromagnetic materials with you during calibration such as keys or cellular phones.
- DO NOT calibrate beside massive metal objects.
- DO NOT calibrate indoors.

Calibration Procedures

Choose an open area to carry out the following procedures.

1. Ensure the compass is calibrated. If you did not calibrate the compass in the Checklist, or if you have changed your position since last calibrating it, tap "MODE" in the app and select "Compass Calibration" to calibrate the compass. Then follow the on-screen instructions.
2. Hold and rotate the aircraft horizontally 360 degrees, and the Aircraft Status Indicator will display a solid green light.

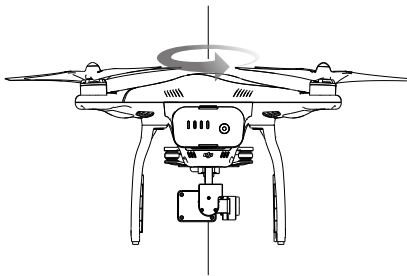

3. Hold the aircraft vertically with nose pointing downward, and rotate it 360 degrees around the center axis. Recalibrate the compass if the Aircraft Status Indicator show solid red.

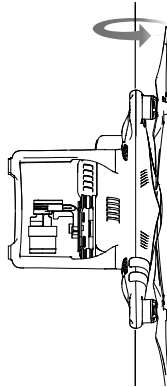

Flight

 If the Aircraft Status Indicator blinks red and yellow after the calibration, move your aircraft to a different location to calibrate the compass.

 Calibrate the compass before each flight. Launch DJI Pilot App, follow the on-screen instruction to calibrate the compass.

When to Recalibrate

1. When compass data is abnormal, and the Aircraft Status Indicator is blinking red and yellow.
2. When flying in a new location, or a location that is different from your last flight.
3. When the mechanical structure of the Phantom 3 Professional has changed.
4. When severe drifting occurs in flight, i.e. Phantom 3 Professional does not fly in straight line.

Auto Take-off and Auto Landing

Auto Take-off

Use auto take-off to take off your aircraft automatically if the Aircraft Status Indicator displays blinking green. Follow the steps below to use auto take-off:

1. Launch DJI Pilot app, enter "Camera" page.
2. Ensure the aircraft is in "P" mode.
3. Go through the pre-flight checklist.
4. Tap "" , and confirm flight conditions. Slide to confirm and take-off.
5. Aircraft takes off and hovers at 1.2 meters above ground.

Auto-Landing

Use auto-landing to land your aircraft automatically if the Aircraft Status Indicator displays blinking green. Follow the steps below to use auto-landing:

1. Ensure the aircraft is in "P" mode.
2. Check the landing area condition before tapping "↓", to perform landing.

Starting/Stopping the Motors

Starting Motors

A Combination Stick Command (CSC) is used to start the motors instead of simply pushing the stick up. Push both sticks to their bottom corners to start the motors. Once the motors have spun up, release both sticks simultaneously.

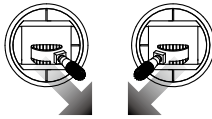

Stopping Motors

There are two methods to stop the motors.

Method 1: When Phantom 3 Professional has landed, push the throttle down, then conduct CSC. Motors will stop immediately. Release both sticks once motors stop.

Method 2: When the aircraft has landed, push the throttle down and hold. The motors will stop after 3 seconds.

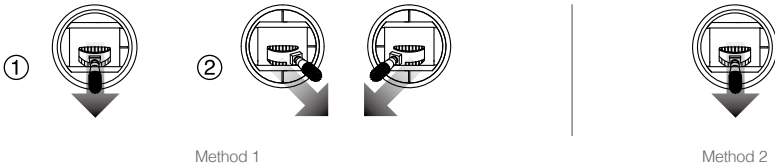

Flight Test

Take off/Landing Procedures

1. Place the aircraft on open, flat ground with battery indicators facing towards you.
2. Power on the remote controller and your mobile device, then the Intelligent Flight Battery.
3. Launch the DJI Pilot App and enter the Camera page.
4. Wait until the Aircraft Indicator blinks green. This means the Home Point is recorded and it is safe to fly now. If it flashes yellow, it means Home Point is not recorded, and you should not take off.
5. Push the throttle up slowly to take off or using Auto Take-off to take off.
6. Shoot photos and videos using the DJI Pilot app.
7. To land, hover over a level surface and gently pull down on the throttle slowly to descend.
8. After landing, execute the CSC command or hold the throttle at its lowest position for 3 seconds or more until the motors stop.
9. Turn off the Intelligent Flight Battery first, followed by the Remote Controller.



- When the Aircraft Status Indicator blinks yellow rapidly during flight, the aircraft has entered Failsafe mode.
 - A low battery level warning is indicated by the Aircraft Status Indicator blinking red slowly or rapidly during flight.
 - Watch video tutorials about flight for more flight information.
-

Video Suggestions and Tips

1. Go through the checklist before each flight.
2. Select desired gimbal operation mode in the DJI Pilot app.
3. Shoot the video when flying in P mode only.
4. Always fly in good weather, such as sunny or windless days.
5. Change camera settings that suit you. These include photo format and exposure compensation.
6. Perform flight tests to establish flight routes and scenes.
7. Push the sticks gently to make aircraft movements stable and smooth.

FAQ

Troubleshooting (FAQ)



FAQ

Appendix

Appendix

Specifications

Aircraft

Weight (Battery & Propellers Included)	1284 g
Max Ascent Speed	6 m/s
Max Descent Speed	2 m/s
Max Speed	16 m/s (ATTI mode, no wind)
Max Flight Altitude	6000 m
Max Flight Time	Approximately 24 minutes
Operating Temperature	0°C to 40°C
GPS Mode	GPS/GLOSNASS

Gimbal

Controllable Range	Pitch - 90° to + 30°
--------------------	----------------------

Vision Positioning











Velocity Range	Below 8 m/s (2 m above ground)
Altitude Range	5 cm-300 cm
Operating Environment	Brightly lit (lux > 15) patterned surfaces

Camera

Sensor	Sony EXMOR 1/2.3" Effective pixels:12.4 M (total pixels: 12.76 M)
Lens	FOV 94° 20mm(35mm format equivalent) f/2.8, focus at ∞
ISO Range	100-3200(video) 100-1600(photo)
Electronic Shutter Speed	8s -1/8000s
Image Max Size	4000 x 3000
	Single shoot
	Burst shooting: 3/5/7 frames
Still Photography Modes	Auto Exposure Bracketing (AEB): 3/5 bracketed frames at 0.7EV Bias
	Time-lapse
Supported SD Card Types	Micro SD
	Max capacity: 64 GB. Class 10 or UHS-1 rating required
	UHD : 4096x2160p24/25, 3840x2160p24/25/30
Video Recording Modes	FHD:1920x1080p24/25/30/48/50/60
	HD:1280x720p24/25/30/48/50/60
Max Bitrate Of Video Storage	60 Mbps
Supported File Formats	FAT32/exFAT
	Photo: JPEG, DNG
	Video: MP4/MOV (MPEG-4 AVC/H.264)
Operating Temperature Range	0°C to 40°C

Remote Controller	
Operating Frequency	2.400 GHz-2.483 GHz
Transmitting Distance	2000 m (Outdoor And Unobstructed)
Video Output Port	USB
Operating Temperature Range	0°C- 40°C
Battery	6000 mAh LiPo 2S
Mobile Device Holder	tablet and phone
Working Voltage	
Working Voltage	1.2 A @7.4 V
Charger	
Voltage	17.4 V
Rated Power	100 W
Intelligent Flight Battery (PH3-4480 mAh-15.2 V)	
Capacity	4480 mAh
Voltage	15.2 V
Battery Type	LiPo 4S
Energy	68 Wh
Net Weight	370 g
Operating Temperature	-10°- 40°
Max Charging Power	100 W

Aircraft Status Indicator Description

Normal	
 Red, Green and Yellow Flash Alternately	Power on and self-check
 Green and Yellow Flash Alternately	Aircraft warming up
 Green Flashes Slowly	Safe to Fly (P mode with GPS and Vision Positioning)
 X2 Green Flashes Twice	Safe to Fly (P mode with Vision Positioning but without GPS)
 Yellow Flashes Slowly	Safe to Fly (A mode but No GPS and Vision Positioning)
Warning	
 Fast Yellow Flashing	Remote Controller Signal Lost
 Slow Red Flashing	Low Battery Warning
 Fast Red Flashing	Critical Low Battery Warning
 Red Flashing Alternately	IMU Error
 — Solid Red	Critical Error
 Red and Yellow Flash Alternately	Compass Calibration Required

Intelligent Orientation Control (IOC)

IOC allows users to lock the orientation of aircraft in different fashions. There are three working modes for IOC and you may select the desired IOC modes from the DJI Pilot app. IOC only works under F mode, and user must toggle the flight mode switch to Position 1 to activate IOC. Refer to the table below:

Course Lock (CL)	Its forward direction is pointing to the nose direction when recording, which is fixed until you re-record it or exit from CL.
Home Lock (HL)*	Record a Home Point (HP), and push Pitch stick to control the aircraft far from or near to the HP.
Point of Interest (POI)*	Point of Interest. Record a point of interest (POI), the aircraft can circle around the POI, and the nose always points to the POI.



*Home Lock and Point of Interest feature are coming soon.

Prerequisites of IOC

Use the IOC feature under the following condition:

Modes IOC	GPS enabled	GPS counts	Flight Distance Limits
Course Lock	No	None	None
Home Lock	Yes	11	Aircraft $\leftarrow \geq 10m \rightarrow$ Home Point
POI	Yes	11	Aircraft $\leftarrow 5m-500m \rightarrow$ Point of Interest

Using IOC

Toggle the Flight Mode Switch "F" mode and follow the instructions prompted on the DJI Pilot app to select the desired IOC features.

FCC Compliance

FCC Warning Message

Any Changes or modifications not expressly roved by the party responsible for compliance could void the user's authority to operate the equipment.

This device complies with part 15 of the FCC Rules. Operation is subject to the following two conditions:

(1) This device may not cause harmful interference, and (2) this device must accept any interference received, including interference that may cause undesired operation.

FCC Radiation Exposure Statement:

The equipment complies with FCC radiation exposure limits set forth for an uncontrolled environment. The W323 should be installed and operated with minimum distance 20cm between the radiator& your body. This transmitter must not be co-located or operating in conjunction with any other antenna or transmitter.

Note: This equipment has been tested and found to comply with the limits for a Class B digital device, pursuant to part 15 of the FCC Rules. These limits are designed to provide reasonable protection against harmful interference in a residential installation. This equipment generates uses and can radiate radio frequency energy and, if not installed and used in accordance with the instructions, may cause harmful interference to radio communications. However, there is no guarantee that interference will not occur in a particular installation. If this equipment does cause harmful interference to radio or television reception, which can be determined by turning the equipment off and on, the user is encouraged to try to correct the interference by one or more of the following measures:

- Reorient or relocate the receiving antenna.
- Increase the separation between the equipment and receiver.
- Connect the equipment into an outlet on a circuit different from that to which the receiver is connected.
- Consult the dealer or an experienced radio/TV technician for help.

IC RSS warning

The device complies with Industry Canada licence-exempt RSS standard (s). Operation is subject to the following two conditions: (1)The device may not cause interference, and (2)The device must accept any interference,including interference that may cause undesired operation of the device.

Le présent areil est conforme aux CNR d'Industrie Canada licables aux areils radio exempts de licence.

L'exploitation est autorisée aux deux conditions suivantes:

- (1) l'areil ne doit pas produire de brouillage, et
- (2) l'utilisateur de l'areil doit accepter tout brouillage radioélectrique subi, même si le brouillage est susceptible d'en compromettre le fonctionnement.

IC Radiation Exposure Statement:

This equipment complies with IC RF radiation exposure limits set forth for an uncontrolled environment. This transmitter must not be co-located or operating in conjunction with any other antenna or transmitter.

This W323 should be installed and operated with minimum distance 20cm between the radiator& your body.

Any Changes or modifications not expressly roved by the party responsible for compliance could void the user's authority to operate the equipment.

KCC Warning Message

“해당 무선설비는 운용 중 전파혼신 가능성이 있으므로 인명안전과 관련된 서비스는 할 수 없습니다.”
“해당 무선설비는 운용 중 전파혼신 가능성이 있음”

NCC Warning Message

低功率電波輻射性電機管理辦法

第十二條經型式認證合格之低功率射頻電機，非經許可，公司、商號或使用者均不得擅自變更頻率、加大功率或變更原設計之特性及功能。

第十四條低功率射頻電機之使用不得影響飛航安全及干擾合法通信；經發現有干擾現象時，應改善至無干擾時方得繼續使用。前項合法通信，指依電信法規定作業之無線電通信。低功率射頻電機須忍受合法通信或工業、科學及醫療用電波輻射性電機設備之干擾。

The content is subject to change.

Download the latest version from
<http://www.dji.com/product/phantom3>



If you have any questions about this document, please contact DJI by sending a message to DocSupport@dji.com.