



FCC PART 15.407  
RSS-GEN, ISSUE 5, AMENDMENT 1, MARCH 2019  
RSS-247, ISSUE 2, FEBRUARY 2017  
TEST REPORT

For

SZ DJI TECHNOLOGY CO., LTD

14th floor, West Wing, Skyworth Semiconductor Design Building NO.18 Gaoxin South 4th Ave,  
Nanshan District, Shenzhen, Guangdong, China

**FCC ID:SS3-FGDB282006**  
**IC:11805A-FGDB282006**

<b>Report Type:</b> Original Report	<b>Product Name:</b> DJI FPV Goggles V2
<b>Report Number:</b>	<u>RDG200724010-00B</u>
<b>Report Date:</b>	<u>2020-10-15</u>
<b>Reviewed By:</b>	Ivan Cao Assistant Manager 
<b>Test Laboratory:</b>	Bay Area Compliance Laboratories Corp. (Dongguan) No.69 Pulongcun, Puxinhu Industry Area, Tangxia, Dongguan, Guangdong, China Tel: +86-769-86858888 Fax: +86-769-86858891 <a href="http://www.baclcorp.com.cn">www.baclcorp.com.cn</a>

## TABLE OF CONTENTS

<b>GENERAL INFORMATION.....</b>	<b>4</b>
PRODUCT DESCRIPTION FOR EQUIPMENT UNDER TEST (EUT).....	4
OBJECTIVE .....	4
RELATED SUBMITTAL(S)/GRANT(S).....	4
TEST METHODOLOGY .....	5
MEASUREMENT UNCERTAINTY.....	5
TEST FACILITY.....	5
DECLARATIONS.....	5
<b>SYSTEM TEST CONFIGURATION.....</b>	<b>6</b>
DESCRIPTION OF TEST CONFIGURATION .....	6
EUT EXERCISE SOFTWARE .....	7
EQUIPMENT MODIFICATIONS .....	10
SUPPORT EQUIPMENT LIST AND DETAILS .....	10
SUPPORT CABLE LIST AND DETAILS .....	10
BLOCK DIAGRAM OF TEST SETUP .....	11
<b>SUMMARY OF TEST RESULTS .....</b>	<b>12</b>
<b>FCC §15.407 (f) &amp; §1.1310 &amp; §2.1093, RSS-102 CLAUSE 4- RF EXPOSURE .....</b>	<b>13</b>
APPLICABLE STANDARD .....	13
TEST RESULT .....	13
<b>FCC §15.203&amp; RSS-GEN CLAUSE 6.8 - ANTENNA REQUIREMENT .....</b>	<b>14</b>
APPLICABLE STANDARD .....	14
ANTENNA CONNECTOR CONSTRUCTION .....	15
<b>FCC §15.209, §15.205 , §15.407(b) &amp;RSS-247 CLAUSE 6.2, RSS-GEN CLAUSE 8.10 –UNWANTED EMISSION .....</b>	<b>16</b>
APPLICABLE STANDARD .....	16
EUT SETUP .....	18
EMI TEST RECEIVER & SPECTRUM ANALYZER SETUP .....	20
TEST PROCEDURE .....	20
CORRECTED AMPLITUDE & MARGIN CALCULATION .....	21
TEST EQUIPMENT LIST AND DETAILS.....	22
TEST DATA .....	22
<b>FCC §15.407(a)(e) &amp; RSS-247 CLAUSE 6.2,RSS-Gen CLAUSE 6.7–EMISSION BANDWIDTH AND OCCUPIED BANDWIDTH .....</b>	<b>40</b>
APPLICABLE STANDARD .....	40
TEST EQUIPMENT LIST AND DETAILS.....	40
TEST PROCEDURE .....	40
TEST DATA .....	40
<b>FCC §15.407(a) &amp; RSS-247 CLAUSE 6.2 –MAXIMUM CONDUCTED OUTPUT POWER.....</b>	<b>54</b>
APPLICABLE STANDARD .....	54
TEST EQUIPMENT LIST AND DETAILS.....	56
TEST PROCEDURE .....	56
TEST DATA .....	57
<b>FCC §15.407(a)&amp; RSS-247 CLAUSE 6.2- POWER SPECTRAL DENSITY .....</b>	<b>58</b>
APPLICABLE STANDARD .....	58

TEST PROCEDURE .....60  
TEST EQUIPMENT LIST AND DETAILS.....60  
TEST DATA .....60  
**RSS-247 CLAUSE 6.4- ADDITIONAL REQUREMENT .....86**  
APPLICABLE STANDARD .....86  
RESULT .....87

## GENERAL INFORMATION

### Product Description for Equipment under Test (EUT)

<b>Manufacturer:</b>	SZ DJI TECHNOLOGY CO., LTD
<b>Manufacturer address:</b>	14th floor, West Wing, Skyworth Semiconductor Design Building NO.18 Gaoxin South 4th Ave, Nanshan District, Shenzhen, Guangdong, China
<b>EUT Name:</b>	DJI FPV Goggles V2
<b>EUT Model:</b>	FGDB28
<b>Operation Frequency:</b>	SDR 1.4M:5728.5-5846.5MHz SDR 1.4M-CA:5730.12-5848.12MHz SDR 10M:5730.5-5844.5MHz SDR 20M:5735.5-5839.5MHz
<b>Maximum Average Output Power (Conducted):</b>	SDR 1.4M: 28.48 dBm SDR 1.4M-CA: 28.60 dBm SDR 10M: 16.28 dBm SDR 20M: 16.85 dBm
<b>Antenna Gain</b>	3.0 dBi
<b>Modulation Type:</b>	OFDM
<b>Rated Input Voltage:</b>	Powered by BZX170-2600-7.2 or DC 11.1V-25.2V
<b>Serial Number:</b>	RDG200724010-RF-S2
<b>EUT Received Date:</b>	2020.07.22
<b>EUT Received Status:</b>	Good

### Objective

This type approval report is prepared on behalf of **SZ DJI TECHNOLOGY CO., LTD** in accordance with Part 2-Subpart J, Part 15-Subparts A, and E of the Federal Communications Commission's rules and RSS-247, Issue 2, February 2017, RSS-Gen Issue 5, Amendment 1, March 2019 of the Innovation, Science and Economic Development Canada.

The tests were performed in order to determine compliance with FCC Rules Part 15, Subpart E, section 15.203, 15.205, 15.209 and 15.407 rules and RSS-247, Issue 2, February 2017, RSS-Gen Issue 5, Amendment 1, March 2019 of the Innovation, Science and Economic Development Canada.

### Related Submittal(s)/Grant(s)

FCC Part 15C DTS submissions with FCC ID: SS3-FGDB282006  
 RSS-247 DTSs submissions with IC: 11805A-FGDB282006  
 Part of System submissions with FCC ID: SS3-FD1W4K2006, IC: 11805A-FD1W4K2006;  
 FCC ID: SS3-FC7BGC2006, IC: 11805A-FC7BGC2006

## Test Methodology

All measurements contained in this report were conducted with ANSI C63.10-2013, American National Standard of Procedures for Compliance Testing of Unlicensed Wireless Devices. And KDB 789033 D02 General U-NII Test Procedures New Rules v02r01, and RSS-247, Issue 2, February 2017, RSS-Gen Issue 5, Amendment 1, March 2019 of the Innovation, Science and Economic Development Canada.

All emissions measurement was performed and Bay Area Compliance Laboratories Corp. (Dongguan).

## Measurement Uncertainty

Parameter	Measurement Uncertainty
Occupied Channel Bandwidth	±5 %
RF output power, conducted	±0.61 dB
Power Spectral Density, conducted	±0.61 dB
Unwanted Emissions, radiated	30M~200MHz: 4.55 dB, 200M~1GHz: 5.92 dB, 1G~6GHz: 4.98 dB, 6G~18GHz: 5.89 dB, 18G~26.5G: 5.47 dB, 26.5G~40G: 5.63 dB
Unwanted Emissions, conducted	±1.5 dB
Temperature	±1 °C
Humidity	±5%
DC and low frequency voltages	±0.4%
Duty Cycle	1%
AC Power Lines Conducted Emission	3.12 dB (150 kHz to 30 MHz)

## Test Facility

The Test site used by Bay Area Compliance Laboratories Corp. (Dongguan) to collect test data is located on the No.69 Pulongcun, Puxinhu Industry Area, Tangxia, Dongguan, Guangdong, China.

The lab has been recognized as the FCC accredited lab under the KDB 974614 D01 and is listed in the FCC Public Access Link (PAL) database, FCC Registration No. : 897218, the FCC Designation No. : CN1220.

The lab has been recognized by Innovation, Science and Economic Development Canada to test to Canadian radio equipment requirements, the CAB identifier: CN0022.

## Declarations

BACL is not responsible for the authenticity of any test data provided by the applicant. Data included from the applicant that may affect test results are marked with a triangle symbol “△”. Customer model name, addresses, names, trademarks etc. are not considered data.

Unless otherwise stated the results shown in this test report refer only to the sample(s) tested.

This report cannot be reproduced except in full, without prior written approval of the Company.

This report is valid only with a valid digital signature. The digital signature may be available only under the Adobe software above version 7.0.

This report may contain data that are not covered by the accreditation scope and shall be marked with an asterisk “★”.

## SYSTEM TEST CONFIGURATION

### Description of Test Configuration

The system was configured for testing in an engineering mode (which was selected by manufacturer).

The device supports SDR 1.4MHz/1.4MHz-CA/10MHz/20MHz modes. The EUT has 4 antennas, the system supports SISO mode and MIMO maximum 2TX mode, chain 2 and chain 3 are receiver chains only.

For 1.4M mode, 60 channels are provided to testing:

Channel	Frequency (MHz)	Channel	Frequency (MHz)
1	5728.5	31	5788.5
2	5730.5	...	...
...	...	...	...
...	...	...	...
29	5784.5	59	5844.5
30	5786.5	60	5846.5

3 channels were tested:5728.5MHz, 5786.5MHz and 5846.5MHz

For 1.4M-CA mode, 60 channels are provided to testing:

Channel	Frequency (MHz)	Channel	Frequency (MHz)
1	5730.12	31	5790.12
2	5732.12	...	...
...	...	...	...
...	...	...	...
29	5786.12	59	5846.12
30	5788.12	60	5848.12

3 channels were tested:5730.12MHz, 5788.12MHz and 5848.12MHz

For 10M mode, 115 channels are provided for testing:

Channel	Frequency (MHz)	Channel	Frequency (MHz)
1	5730.5	59	5788.5
2	5731.5	...	...
...	...	...	...
...	...	114	5843.5
..	...	115	5844.5
58	5787.5	/	/

3 channels were tested:5730.5MHz, 5787.5MHz and 5844.5MHz

For 20M mode, 105 channels are provided for testing:

Channel	Frequency (MHz)	Channel	Frequency (MHz)
1	5735.5	54	5788.5
2	5736.5	...	...
...	...	...	...
...	...	104	5838.5
..	...	105	5839.5
53	5787.5	/	/

3 channels were tested:5735.5MHz, 5787.5MHz and 5839.5MHz

**EUT Exercise Software**

Software "DjiSdrConsole\_V1.3.5.68.exe " was used during test, the maximum power was configured as below, which was provided by manufacturer:

1TX:

Mode	Power level Setting	
	Chain 0	Chain 1
1.4M	4	4
1.4M-CA	4	4
10M	5	5
20M	5	6

2TX:

Mode	Power level Setting	
	Chain 0	Chain 1
1.4M	3	3
1.4M-CA	3	3
10M	2	2
20M	3	3

The maximum duty cycle as following table:

Test mode	T <sub>on</sub> (ms)	T <sub>on+off</sub> (ms)	Duty Cycle (%)
1.4M	100	100	100
1.4M-CA	100	100	100
10M	100	100	100
20M	100	100	100

### 1.4M

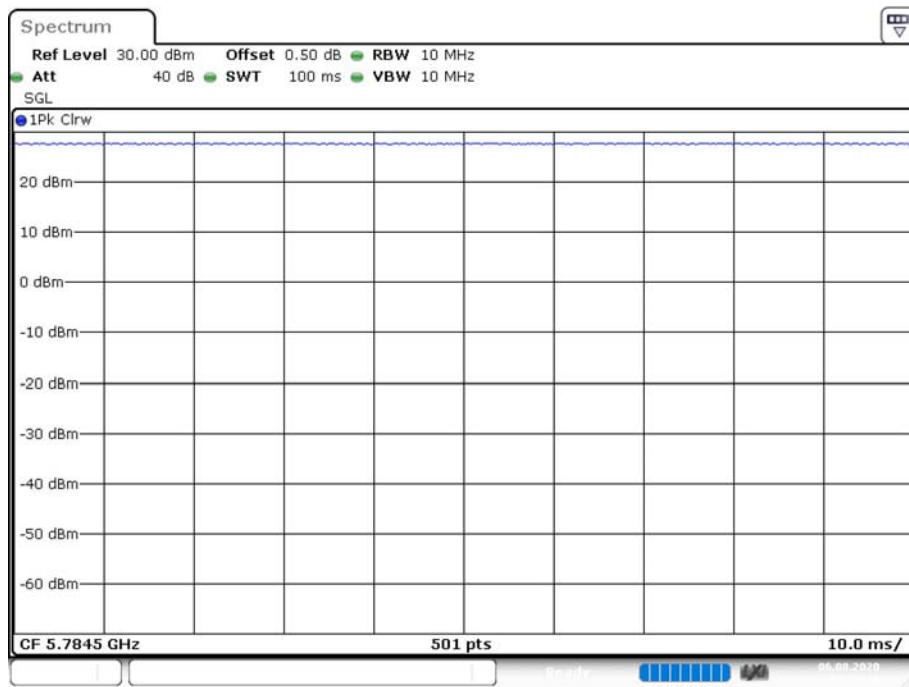

### 1.4M-CA

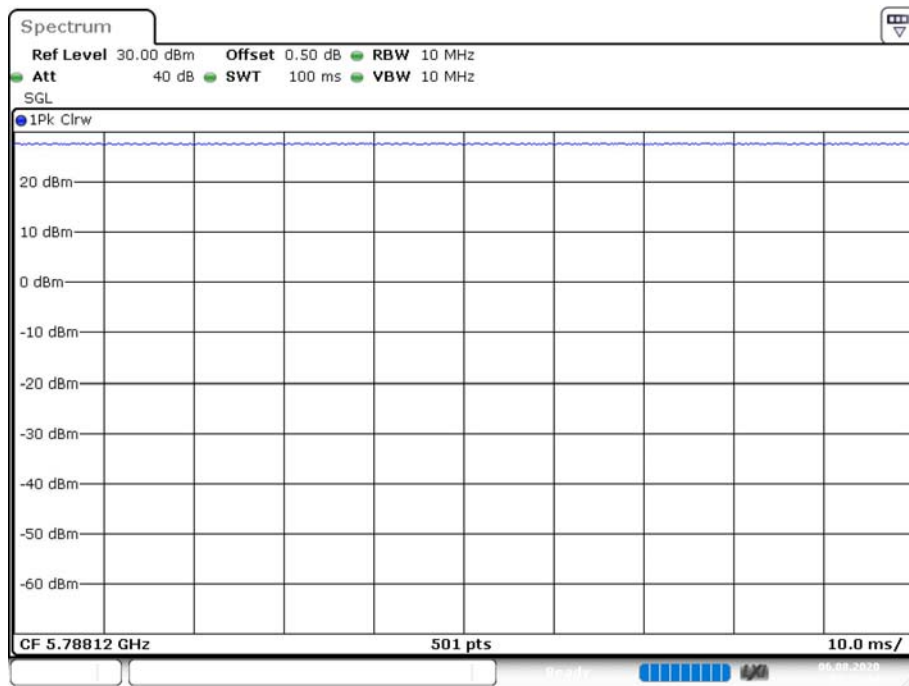



### 10M

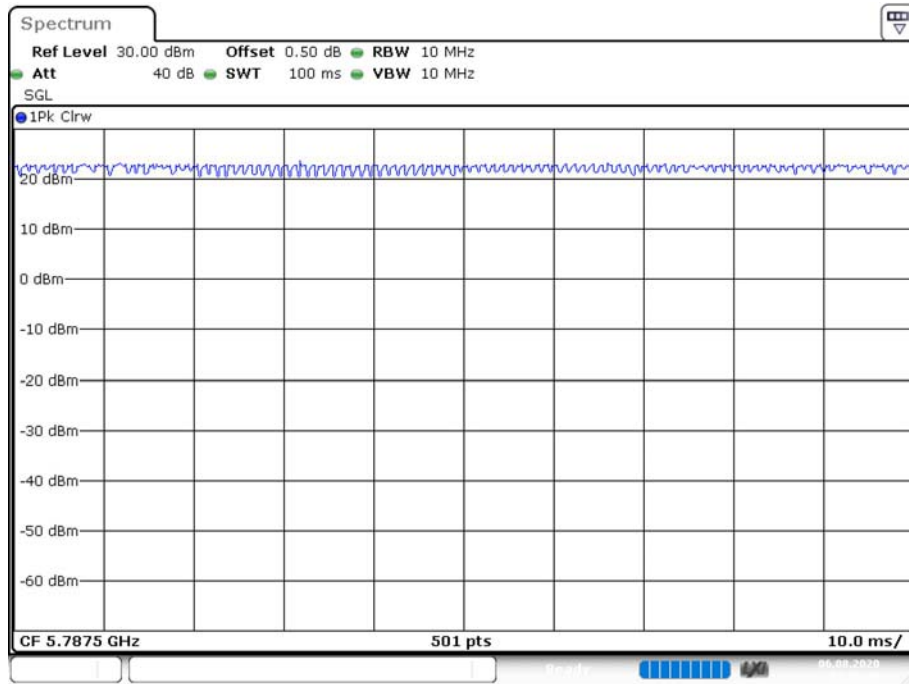

### 20M

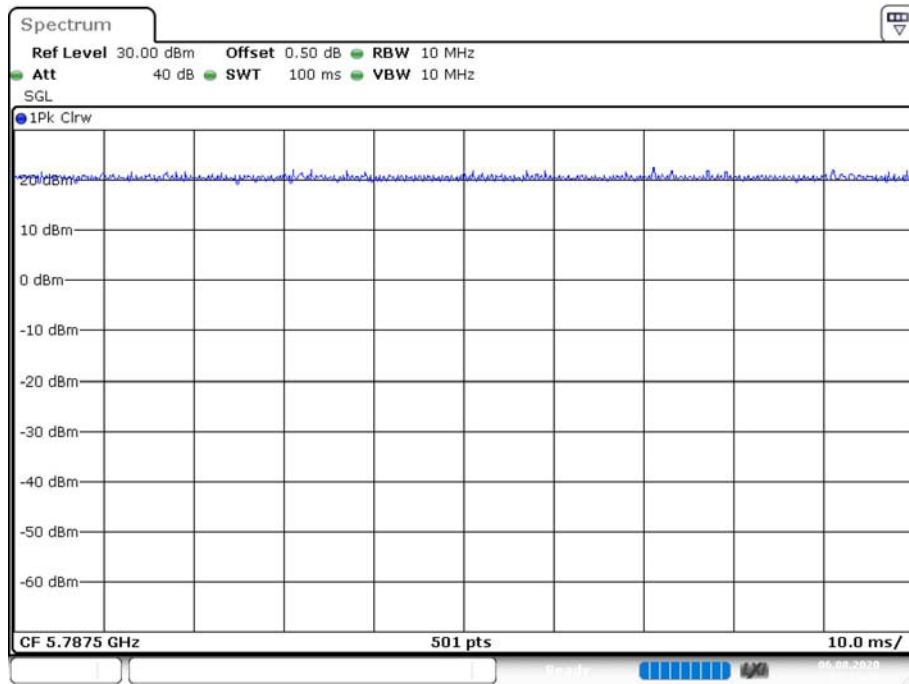

## Equipment Modifications

No modification was made to the EUT.

## Support Equipment List and Details

Manufacturer	Description	Model	Serial Number
DJI	Lithium Ion Polymer Rechargeable Battery	CB1-2000mAh-22.2V	37WP0140010146
Mi	Earphone	BRE02JY	415236
SanDisk	Micro SD Card	UHS-I-128G	9292DVDSV0XZ

## Support Cable List and Details

Cable Description	Shielding Type	Ferrite Core	Length (m)	From Port	To
Power Cable	Yes	No	1.2	DC Jack of EUT	Battery
Earphone Cable	Yes	No	1.5	3.5mm headphone jack of EUT	Earphone

### Block Diagram of Test Setup

#### Radiated Below 1GHz Test:

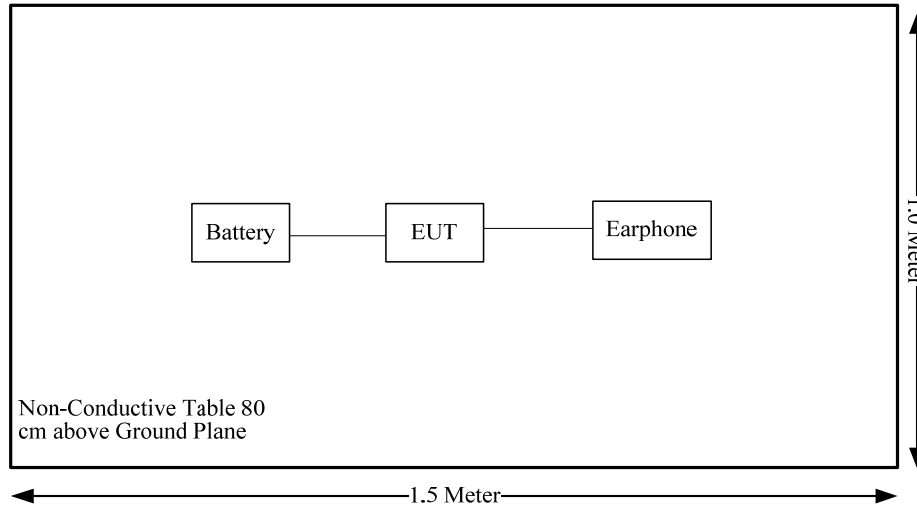

#### Radiated Above 1GHz Test:

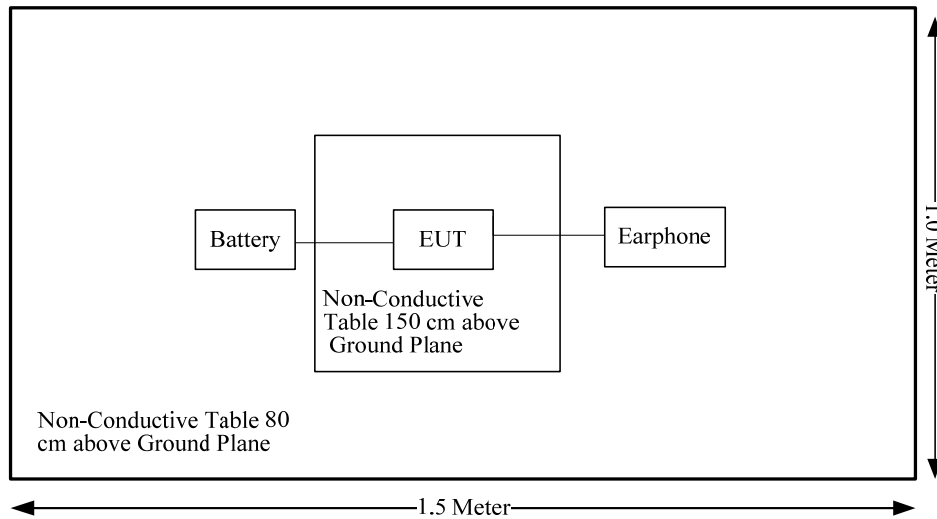

## SUMMARY OF TEST RESULTS

Rules	Description of Test	Result
FCC §15.407 (f) & §1.1310 & §2.1093 RSS-102 Clause 4	RF Exposure	Compliance
FCC§15.203, RSS-Gen Clause 6.8	Antenna Requirement	Compliance
FCC§15.407(b)(6)& §15.207(a), RSS-Gen Clause 8.8	Conducted Emissions	Not Applicable
FCC§15.205& §15.209 &§15.407(b), RSS-247 Clause 6.2	Undesirable Emission& Restricted Bands	Compliance
FCC§15.407(a) (e), RSS-247 Clause 6.2 RSS-Gen Clause 6.7	Emission Bandwidth	Compliance
FCC§15.407(a) RSS-247 Clause 6.2	Conducted Transmitter Output Power	Compliance
FCC§15.407 (a), RSS-247 Clause 6.2	Power Spectral Density	Compliance
RSS-247 Clause 6.4	Additional requirements	Compliance

Not Applicable: the device was powered by battery.

**FCC §15.407 (f) & §1.1310 & §2.1093, RSS-102 CLAUSE 4- RF EXPOSURE****Applicable Standard**

According to §15.407(f), §1.1310 and §2.1093.

According to RSS-102 Clause 4 Table 3, SAR limits for device used by the general public

Body Region	Average SAR (W/Kg)	Averaging Time (minutes)	Mass Average (g)
Whole Body	0.08	6	Whole Body
Localized Head, Neck and Trunk	1.6	6	1
Localized Limbs	4	6	10

**Test Result**

Compliant, please refer to the SAR report: RDG200724010-20.

---

**FCC §15.203& RSS-GEN CLAUSE 6.8 - ANTENNA REQUIREMENT**

---

**Applicable Standard**

According to FCC§ 15.203, an intentional radiator shall be designed to ensure that no antenna other than that furnished by the responsible party shall be used with the device. The use of a permanently attached antenna or of an antenna that uses a unique coupling to the intentional radiator shall be considered sufficient to comply with the provisions of this section. The manufacturer may design the unit so that a broken antenna can be replaced by the user, but the user of a standard antenna jack or electrical connector is prohibited. The structure and application of the EUT were analyzed to determine compliance with section §15.203 of the rules. §15.203 state that the subject device must meet the following criteria:

- a. Antenna must be permanently attached to the unit.
- b. Antenna must use a unique type of connector to attach to the EUT.
- c. Unit must be professionally installed, and installer shall be responsible for verifying that the correct antenna is employed with the unit.

According to RSS-Gen Clause 6.8, The applicant for equipment certification shall provide a list of all antenna types that may be used with the transmitter, where applicable (i.e. for transmitters with detachable antenna), indicating the maximum permissible antenna gain (in dBi) and the required impedance for each antenna. The test report shall demonstrate the compliance of the transmitter with the limit for maximum equivalent isotropically radiated power (e.i.r.p.) specified in the applicable RSS, when the transmitter is equipped with any antenna type, selected from this list.

For expediting the testing, measurements may be performed using only the antenna with highest gain of each combination of transmitter and antenna type, with the transmitter output power set at the maximum level. However, the transmitter shall comply with the applicable requirements under all operational conditions and when in combination with any type of antenna from the list provided in the test report (and in the notice to be included in the user manual, provided below).

When measurements at the antenna port are used to determine the RF output power, the effective gain of the device's antenna shall be stated, based on a measurement or on data from the antenna's manufacturer. The test report shall state the RF power, output power setting and spurious emission measurements with each antenna type that is used with the transmitter being tested.

For licence-exempt equipment with detachable antennas, the user manual shall also contain the following notice in a conspicuous location:

This radio transmitter [enter the device's ISED certification number] has been approved by Innovation, Science and Economic Development Canada to operate with the antenna types listed below, with the maximum permissible gain indicated. Antenna types not included in this list that have a gain greater than the maximum gain indicated for any type listed are strictly prohibited for use with this device.

Immediately following the above notice, the manufacturer shall provide a list of all antenna types which can be used with the transmitter, indicating the maximum permissible antenna gain (in dBi) and the required impedance for each antenna type.

**Antenna Connector Construction**

The EUT has 4 external antennas use a unique type of connector to attach to the EUT, fulfill the requirement of this section. Please refer to the EUT photos.

Antenna Chain	Antenna Type	input impedance (Ohm)	Antenna Gain /Frequency Range
0	Dipole	50	2.5 dBi/2.4~2.5GHz 3.0 dBi/5.725~5.85GHz
1	Dipole	50	2.5 dBi/2.4~2.5GHz 3.0 dBi/5.725~5.85GHz
2	Dipole	50	2.5 dBi/2.4~2.5GHz 3.0 dBi/5.725~5.85GHz
3	Dipole	50	2.5 dBi/2.4~2.5GHz 3.0 dBi/5.725~5.85GHz

**Result:** Compliance.

## **FCC §15.209, §15.205 , §15.407(b) &RSS-247 CLAUSE 6.2, RSS-GEN CLAUSE 8.10 –UNWANTED EMISSION**

### **Applicable Standard**

FCC §15.407; §15.209; §15.205;

(b) Undesirable emission limits. Except as shown in paragraph (b)(7) of this section, the maximum emissions outside of the frequency bands of operation shall be attenuated in accordance with the following limits:

(1) For transmitters operating in the 5.15-5.25 GHz band: All emissions outside of the 5.15-5.35 GHz band shall not exceed an e.i.r.p. of  $-27$  dBm/MHz.

(2) For transmitters operating in the 5.25-5.35 GHz band: All emissions outside of the 5.15-5.35 GHz band shall not exceed an e.i.r.p. of  $-27$  dBm/MHz.

(3) For transmitters operating in the 5.47-5.725 GHz band: All emissions outside of the 5.47-5.725 GHz band shall not exceed an e.i.r.p. of  $-27$  dBm/MHz.

(4) For transmitters operating in the 5.725-5.85 GHz band:

(i) All emissions shall be limited to a level of  $-27$  dBm/MHz at 75 MHz or more above or below the band edge increasing linearly to 10 dBm/MHz at 25 MHz above or below the band edge, and from 25 MHz above or below the band edge increasing linearly to a level of 15.6 dBm/MHz at 5 MHz above or below the band edge, and from 5 MHz above or below the band edge increasing linearly to a level of 27 dBm/MHz at the band edge.

(ii) Devices certified before March 2, 2017 with antenna gain greater than 10 dBi may demonstrate compliance with the emission limits in §15.247(d), but manufacturing, marketing and importing of devices certified under this alternative must cease by March 2, 2018. Devices certified before March 2, 2018 with antenna gain of 10 dBi or less may demonstrate compliance with the emission limits in §15.247(d), but manufacturing, marketing and importing of devices certified under this alternative must cease before March 2, 2020.

(5) The emission measurements shall be performed using a minimum resolution bandwidth of 1 MHz. A lower resolution bandwidth may be employed near the band edge, when necessary, provided the measured energy is integrated to show the total power over 1 MHz.

(6) Unwanted emissions below 1 GHz must comply with the general field strength limits set forth in §15.209. Further, any U-NII devices using an AC power line are required to comply also with the conducted limits set forth in §15.207.

(7) The provisions of §15.205 apply to intentional radiators operating under this section.



According to RSS-247 Clause 6.2

### **Frequency band 5150-5250 MHz**

#### **6.2.1.2 Unwanted emission limits**

For transmitters with operating frequencies in the band 5150-5250 MHz, all emissions outside the band 5150-5350 MHz shall not exceed -27 dBm/MHz e.i.r.p. Any unwanted emissions that fall into the band 5250-5350 MHz shall be attenuated below the channel power by at least 26 dB, when measured using a resolution bandwidth between 1 and 5% of the occupied bandwidth (i.e. 99% bandwidth), above 5250 MHz. The 26 dB bandwidth may fall into the 5250-5350 MHz band; however, if the occupied bandwidth also falls within the 5250-5350 MHz band, the transmission is considered as intentional and the devices shall comply with all requirements in the band 5250-5350 MHz including implementing dynamic frequency selection (DFS) and TPC, on the portion of the emission that resides in the 5250-5350 MHz band.

### **Frequency band 5250-5350 MHz**

#### **6.2.2.2 Unwanted emission limits**

Devices shall comply with the following:

- a) All emissions outside the band 5250-5350 MHz shall not exceed -27 dBm/MHz e.i.r.p.; or
- b) All emissions outside the band 5150-5350 MHz shall not exceed -27 dBm/MHz e.i.r.p. and its power shall comply with the spectral power density for operation within the band 5150-5250 MHz. The device, except devices installed in vehicles, shall be labelled or include in the user manual the following text “for indoor use only.”

### **Frequency bands 5470-5600 MHz and 5650-5725 MHz:**

#### **6.2.3.2 Unwanted emission limits**

Emissions outside the band 5470-5600 MHz and 5650-5725 MHz shall not exceed -27 dBm/MHz e.i.r.p. However, devices with bandwidth overlapping the band edge of 5725 MHz can meet the emission limit of -27 dBm/MHz e.i.r.p. at 5850 MHz instead of 5725 MHz.

## Frequency band 5725-5850 MHz

### 6.2.4.2 Unwanted emission limits

Devices operating in the band 5725-5850 MHz with antenna gain greater than 10 dBi can have unwanted emissions that comply with either the limits in this section or in section 5.5 until six (6) months after the publication date of this standard for certification. Certified devices that do not comply with emission limits in this section shall not be manufactured, imported, distributed, leased, offered for sale or sold after April 1, 2018.

Devices operating in the band 5725-5850 MHz with antenna gain of 10 dBi or less can have unwanted emissions that comply with either the limits in this section or in section 5.5 until April 1, 2018 for certification. Certified devices that do not comply with emission limits in this section shall not be manufactured, imported, distributed, leased, offered for sale or sold after April 1, 2020.

Devices operating in the band 5725-5850 MHz shall have e.i.r.p. of unwanted emissions comply with the following:

- 27 dBm/MHz at frequencies from the band edges decreasing linearly to 15.6 dBm/MHz at 5 MHz above or below the band edges;
- 15.6 dBm/MHz at 5 MHz above or below the band edges decreasing linearly to 10 dBm/MHz at 25 MHz above or below the band edges;
- 10 dBm/MHz at 25 MHz above or below the band edges decreasing linearly to -27 dBm/MHz at 75 MHz above or below the band edges; and
- 27 dBm/MHz at frequencies more than 75 MHz above or below the band edges.

## EUT Setup

### Below 1 GHz:

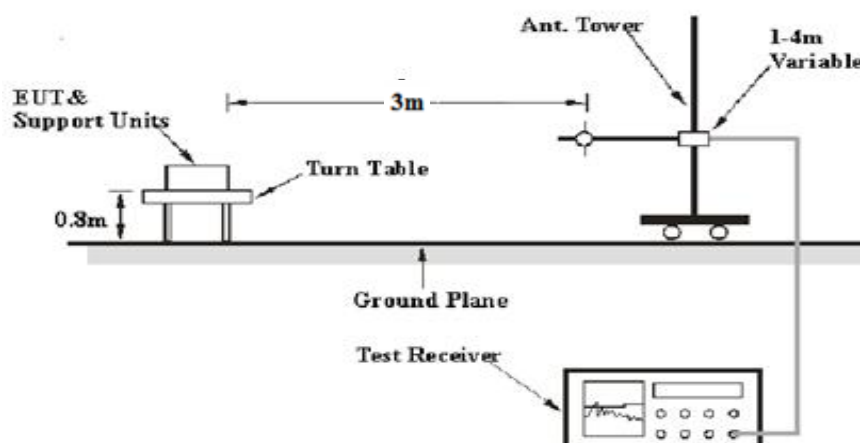

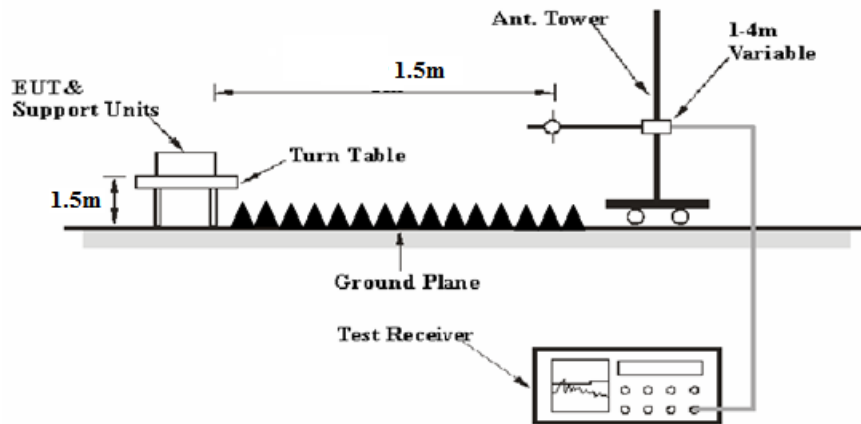
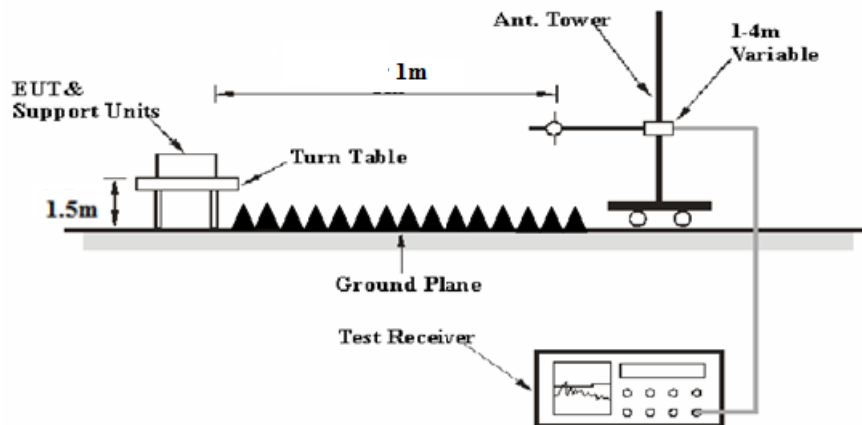
**1-26.5 GHz:****26.5-40 GHz:**

The radiated emission Below 1GHz tests were performed in the 3 meters chamber test site A , above 1GHz tests were performed in the 3 meters chamber test site B, using the setup accordance with the ANSI C63.10-2013. The specification used was the FCC 15.209, and FCC 15.407 limits and RSS-247, RSS-Gen limits.

The external I/O cables were draped along the test table and formed a bundle 30 to 40 cm long in the middle.

The spacing between the peripherals was 10 cm.

## EMI Test Receiver & Spectrum Analyzer Setup

The system was investigated from 30 MHz to 40 GHz.

During the radiated emission test, the EMI test receiver & Spectrum Analyzer Setup were set with the following configurations:

30-1000MHz:

Measurement	RBW	Video B/W	IF B/W
QP	120 kHz	300 kHz	120kHz

1GHz- 40GHz:

Measurement	Duty cycle	RBW	Video B/W
PK	Any	1MHz	3 MHz
Ave.	>98%	1MHz	10 Hz
	<98%	1MHz	1/T

If the maximized peak measured value complies with under the QP/Average limit more than 6dB, then it is unnecessary to perform an QP/Average measurement.

## Test Procedure

During the radiated emission test, the adapter was connected to the first AC floor outlet.

Data was recorded in Quasi-peak detection mode for frequency range of 30 MHz-1GHz, peak and Average detection modes for frequencies above 1GHz.

According to KDB 789033 D02 General UNII Test Procedures New Rules v02r01, emission shall be computed as:  $E [dB\mu V/m] = EIRP[dBm] + 95.2$ , for  $d = 3$  meters.

According to C63.10, the above 1G test result shall be extrapolated to the specified distance using an extrapolation factor of 20dB/decade from 3m to 1.5m or 1m

Distance extrapolation factor =  $20 \log (\text{specific distance } [3m]/\text{test distance } [1.5m])$  dB= 6.02 dB

or

Distance extrapolation factor =  $20 \log (\text{specific distance } [3m]/\text{test distance } [1m])$  dB= 9.54 dB

All emissions under the average limit and under the noise floor have not recorded in the report.

### Corrected Amplitude & Margin Calculation

For the range 30MHz-1GHz, the Corrected Amplitude is calculated by adding the Antenna Factor and Cable Loss, and subtracting the Amplifier Gain from the Meter Reading. The basic equation is as follows:

$$\text{Corrected Amplitude} = \text{Meter Reading} + \text{Antenna Factor} + \text{Cable Loss} - \text{Amplifier Gain}$$

The “**Margin**” column of the following data tables indicates the degree of compliance with the applicable limit. For example, a margin of 7dB means the emission is 7dB below the limit. The equation for margin calculation is as follows:

$$\text{Margin} = \text{Limit} - \text{Corrected Amplitude}$$

For the range 1GHz-40GHz, Test performed at 1.5m or 1m, the Corrected Amplitude is calculated by adding the Antenna Factor and Cable Loss, and subtracting the Amplifier Gain from the Meter Reading and the Distance extrapolation factor. The basic equation is as follows:

$$\begin{aligned} &\text{Corrected Amplitude} \\ &= \text{Meter Reading} + \text{Antenna Factor} + \text{Cable Loss} - \text{Amplifier Gain} - \text{Distance extrapolation factor} \end{aligned}$$

The “**Margin**” column of the following data tables indicates the degree of compliance with the applicable limit. For example, a margin of 7dB means the emission is 7dB below the limit. The equation for margin calculation is as follows:

$$\text{Margin} = \text{Limit} - \text{Corrected Amplitude}$$

**Test Equipment List and Details**

Manufacturer	Description	Model	Serial Number	Calibration Date	Calibration Due Date
Radiation Below 1GHz					
R&S	EMI Test Receiver	ESCI	100035	2019-08-03	2020-08-03
Farad	Test Software	EZ-EMC	V1.1.4.2	N/A	N/A
Sunol Sciences	Antenna	JB3	A060611-2	2017-08-25	2020-08-25
Unknown	Coaxial Cable	C-NJNJ-50	C-1000-01	2019-09-05	2020-09-05
Unknown	Coaxial Cable	C-NJNJ-50	C-0400-02	2019-09-05	2020-09-05
Unknown	Coaxial Cable	C-NJNJ-50	C-0530-01	2019-09-24	2020-09-24
Sonoma	Amplifier	310N	185914	2019-10-13	2020-10-13
Radiation Above 1GHz					
ETS-Lindgren	Horn Antenna	3115	000 527 35	2018-10-12	2021-10-12
Ducommun Technologies	Horn Antenna	ARH-4223-02	1007726-01 1304	2017-12-06	2020-12-05
Ducommun Technologies	Horn Antenna	ARH-2823-02	1007726-01 1302	2017-12-06	2020-12-05
R&S	Spectrum Analyzer	FSP 38	100478	2020-07-07	2021-07-07
Agilent	Spectrum Analyzer	E4440A	SG43360054	2020-07-07	2021-07-07
Unknown	Coaxial Cable	C-SJSJ-50	C-0800-01	2019-09-05	2020-09-05
Unknown	Coaxial Cable	C-2.4J2.4J-50	C-0700-02	2020-06-27	2021-06-27
Mini-Circuit	Amplifier	ZVA-213-S+	54201245	2019-09-05	2020-09-05
Quinstar	Amplifier	QLW-18405536-JO	15964001001	2020-06-27	2021-06-27
Sinoscite	Bandstop Filters	BSF5150-5850MN-0899-003	0899003	2020-05-06	2021-05-06
Mini Circuits	High Pass Filter	VHF-6010+	31118	2020-06-16	2021-06-16

*\* Statement of Traceability: Bay Area Compliance Laboratories Corp. (Dongguan) attests that all calibrations have been performed, traceable to National Primary Standards and International System of Units (SI).*

**Test Data**

**Environmental Conditions**

Test Items	Radiation Below 1GHz	Radiation Above 1GHz
<b>Temperature:</b>	27.8°C	29°C
<b>Relative Humidity:</b>	41%	45%
<b>ATM Pressure:</b>	100.4 kPa	101kPa
<b>Tester:</b>	Jalon Liu	Carlos Jia
<b>Test Date:</b>	2020-08-01	2020-08-20

*Test Mode: Transmitting*

1) Below 1GHz(1.4M Chain 1, Low Channel was the worst):

Horizontal

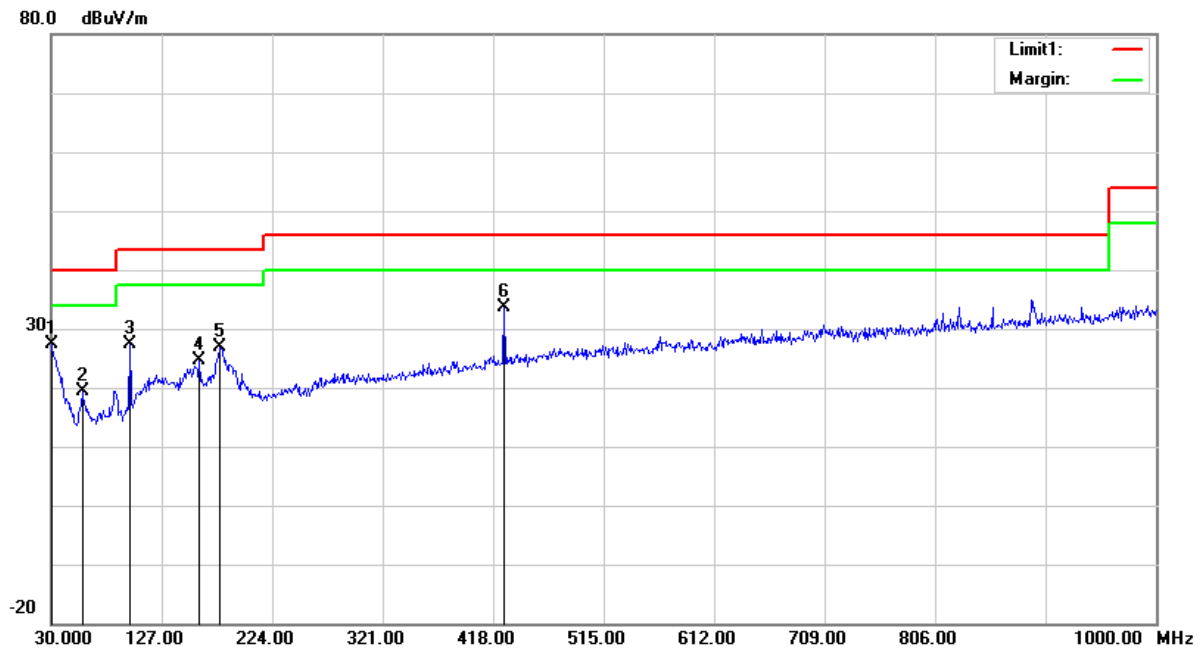

Frequency (MHz)	Receiver Reading (dBµV)	Detector	Correction Factor (dB/m)	Cord. Amp. (dBµV/m)	Limit (dBµV/m)	Margin (dB)
30.0000	25.98	peak	1.46	27.44	40.00	12.56
57.1600	31.88	peak	-12.44	19.44	40.00	20.56
98.8700	36.69	peak	-9.39	27.30	43.50	16.20
159.9800	30.74	peak	-6.03	24.71	43.50	18.79
177.4400	33.91	peak	-7.01	26.90	43.50	16.60
427.7000	35.00	peak	-1.48	33.52	46.00	12.48

**Vertical**

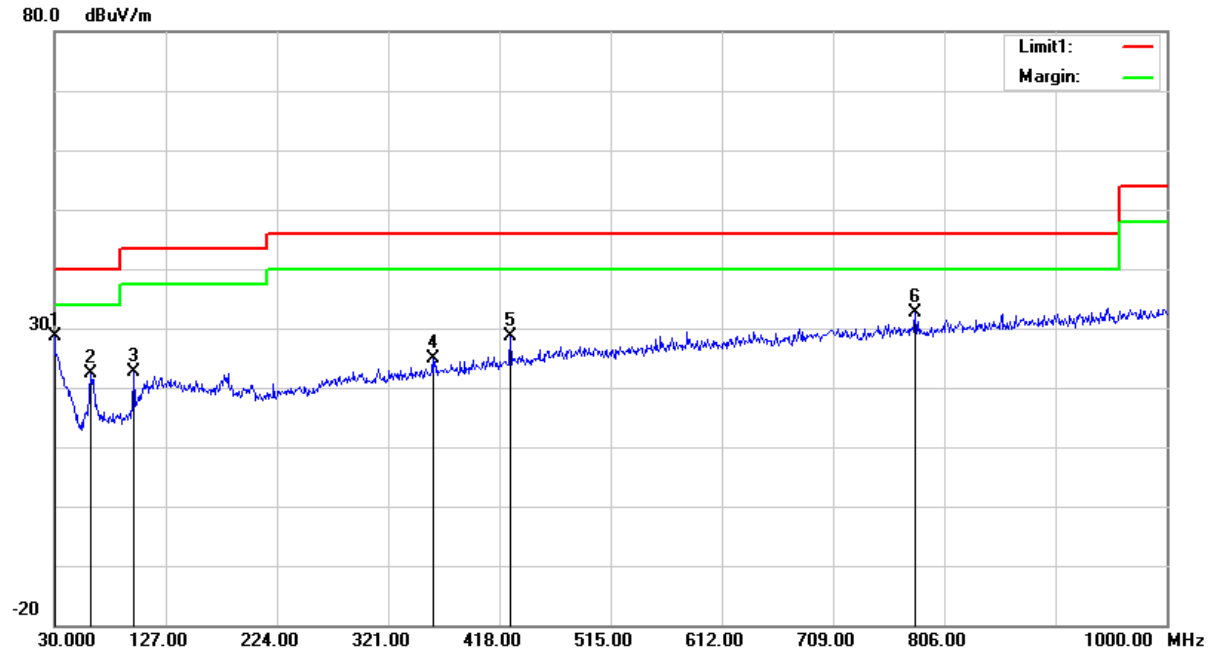

Frequency (MHz)	Receiver Reading (dBμV)	Detector	Correction Factor (dB/m)	Cord. Amp. (dBμV/m)	Limit (dBμV/m)	Margin (dB)
30.0000	27.09	peak	1.46	28.55	40.00	11.45
62.0100	34.50	peak	-12.23	22.27	40.00	17.73
98.8700	32.12	peak	-9.39	22.73	43.50	20.77
359.8000	27.70	peak	-2.78	24.92	46.00	21.08
427.7000	30.12	peak	-1.48	28.64	46.00	17.36
780.7800	28.78	peak	3.78	32.56	46.00	13.44



**2) 1GHz-40GHz:  
1.4M Mode, Chain 0:**

Frequency (MHz)	Receiver		Rx Antenna		Cable loss (dB)	Amplifier Gain (dB)	Corrected Amplitude (dBµV/m)	Extrapolation result (dBµV/m)	Limit (dBµV/m)	Margin (dB)
	Reading (dBµV)	Detector	Polar (H/V)	Factor (dB/m)						
Low Channel: 5728.5 MHz										
5728.50	92.41	PK	H	34.19	3.69	0.00	130.29	124.27	N/A	N/A
5728.50	88.06	AV	H	34.19	3.69	0.00	125.94	119.92	N/A	N/A
5728.50	86.68	PK	V	34.19	3.69	0.00	124.56	118.54	N/A	N/A
5728.50	80.95	AV	V	34.19	3.69	0.00	118.83	112.81	N/A	N/A
5725.00	54.11	PK	H	34.19	3.69	0.00	91.99	85.97	122.20	36.23
5720.00	38.42	PK	H	34.19	3.69	0.00	76.30	70.28	110.80	40.52
5700.00	40.32	PK	H	34.18	3.68	0.00	78.18	72.16	105.20	33.04
5650.00	31.90	PK	H	34.16	3.63	0.00	69.69	63.67	68.20	4.53
11457.00	36.45	PK	H	38.96	6.59	25.50	56.50	50.48	74.00	23.52
11457.00	23.15	AV	H	38.96	6.59	25.50	43.20	37.18	54.00	16.82
17185.50	34.42	PK	H	41.28	8.77	23.77	60.70	54.68	68.20	13.52
Middle Channel: 5784.5 MHz										
5784.50	91.94	PK	H	34.21	3.71	0.00	129.86	123.84	N/A	N/A
5784.50	84.09	AV	H	34.21	3.71	0.00	122.01	115.99	N/A	N/A
5784.50	87.40	PK	V	34.21	3.71	0.00	125.32	119.3	N/A	N/A
5784.50	82.57	AV	V	34.21	3.71	0.00	120.49	114.47	N/A	N/A
11569.00	36.00	PK	H	39.00	6.61	25.46	56.15	50.13	74.00	23.87
11569.00	23.34	AV	H	39.00	6.61	25.46	43.49	37.47	54.00	16.53
17353.50	35.24	PK	H	42.25	8.81	23.60	62.70	56.68	68.20	11.52
High Channel: 5846.5 MHz										
5846.50	90.03	PK	H	34.24	3.75	0.00	128.02	122	N/A	N/A
5846.50	82.97	AV	H	34.24	3.75	0.00	120.96	114.94	N/A	N/A
5846.50	87.13	PK	V	34.24	3.75	0.00	125.12	119.1	N/A	N/A
5846.50	80.78	AV	V	34.24	3.75	0.00	118.77	112.75	N/A	N/A
5850.00	48.92	PK	H	34.24	3.75	0.00	86.91	80.89	122.20	41.31
5855.00	35.27	PK	H	34.24	3.75	0.00	73.26	67.24	110.80	43.56
5875.00	28.79	PK	H	34.25	3.77	0.00	66.81	60.79	105.20	44.41
5925.00	28.56	PK	H	34.27	3.80	0.00	66.63	60.61	68.20	7.59
11693.00	36.03	PK	H	39.00	6.65	25.38	56.30	50.28	74.00	23.72
11693.00	23.28	AV	H	39.00	6.65	25.38	43.55	37.53	54.00	16.47
17539.50	35.40	PK	H	43.34	8.85	23.44	64.15	58.13	68.20	10.07

**1.4M Mode, Chain 1:**

Frequency (MHz)	Receiver		Rx Antenna		Cable loss (dB)	Amplifier Gain (dB)	Corrected Amplitude (dB $\mu$ V/m)	Extrapolation result (dB $\mu$ V/m)	Limit (dB $\mu$ V/m)	Margin (dB)
	Reading (dB $\mu$ V)	Detector	Polar (H/V)	Factor (dB/m)						
Low Channel: 5728.5 MHz										
5728.50	92.21	PK	H	34.19	3.69	0.00	130.09	124.07	N/A	N/A
5728.50	87.23	AV	H	34.19	3.69	0.00	125.11	119.09	N/A	N/A
5728.50	95.16	PK	V	34.19	3.69	0.00	133.04	127.02	N/A	N/A
5728.50	89.60	AV	V	34.19	3.69	0.00	127.48	121.46	N/A	N/A
5725.00	57.86	PK	V	34.19	3.69	0.00	95.74	89.72	122.20	32.48
5720.00	41.09	PK	V	34.19	3.69	0.00	78.97	72.95	110.80	37.85
5700.00	34.03	PK	V	34.18	3.68	0.00	71.89	65.87	105.20	39.33
5650.00	31.27	PK	V	34.16	3.63	0.00	69.06	63.04	68.20	5.16
11457.00	41.68	PK	V	38.96	6.59	25.50	61.73	55.71	74.00	18.29
11457.00	31.29	AV	V	38.96	6.59	25.50	51.34	45.32	54.00	8.68
17185.50	37.66	PK	V	41.28	8.77	23.77	63.94	57.92	68.20	10.28
Middle Channel: 5784.5 MHz										
5784.50	92.05	PK	H	34.21	3.71	0.00	129.97	123.95	N/A	N/A
5784.50	86.64	AV	H	34.21	3.71	0.00	124.56	118.54	N/A	N/A
5784.50	94.55	PK	V	34.21	3.71	0.00	132.47	126.45	N/A	N/A
5784.50	87.05	AV	V	34.21	3.71	0.00	124.97	118.95	N/A	N/A
11569.00	37.85	PK	V	39.00	6.61	25.46	58.00	51.98	74.00	22.02
11569.00	26.51	AV	V	39.00	6.61	25.46	46.66	40.64	54.00	13.36
17353.50	36.02	PK	V	42.25	8.81	23.60	63.48	57.46	68.20	10.74
High Channel: 5846.5 MHz										
5846.50	90.81	PK	H	34.24	3.75	0.00	128.80	122.78	N/A	N/A
5846.50	85.50	AV	H	34.24	3.75	0.00	123.49	117.47	N/A	N/A
5846.50	92.48	PK	V	34.24	3.75	0.00	130.47	124.45	N/A	N/A
5846.50	85.99	AV	V	34.24	3.75	0.00	123.98	117.96	N/A	N/A
5850.00	54.93	PK	V	34.24	3.75	0.00	92.92	86.9	122.20	35.30
5855.00	38.33	PK	V	34.24	3.75	0.00	76.32	70.3	110.80	40.50
5875.00	30.84	PK	V	34.25	3.77	0.00	68.86	62.84	105.20	42.36
5925.00	29.66	PK	V	34.27	3.80	0.00	67.73	61.71	68.20	6.49
11693.00	37.24	PK	V	39.00	6.65	25.38	57.51	51.49	74.00	22.51
11693.00	26.34	AV	V	39.00	6.65	25.38	46.61	40.59	54.00	13.41
17539.50	35.92	PK	V	43.34	8.85	23.44	64.67	58.65	68.20	9.55

**1.4M-CA Mode,Chain 0:**

Frequency (MHz)	Receiver		Rx Antenna		Cable loss (dB)	Amplifier Gain (dB)	Corrected Amplitude (dBµV/m)	Extrapolation result (dBµV/m)	Limit (dBµV/m)	Margin (dB)
	Reading (dBµV)	Detector	Polar (H/V)	Factor (dB/m)						
Low Channel: 5730.12 MHz										
5730.12	89.45	PK	H	34.19	3.69	0.00	127.33	121.31	N/A	N/A
5730.12	85.01	AV	H	34.19	3.69	0.00	122.89	116.87	N/A	N/A
5730.12	89.02	PK	V	34.19	3.69	0.00	126.90	120.88	N/A	N/A
5730.12	84.23	AV	V	34.19	3.69	0.00	122.11	116.09	N/A	N/A
5725.00	42.78	PK	H	34.19	3.69	0.00	80.66	74.64	122.20	47.56
5720.00	34.13	PK	H	34.19	3.69	0.00	72.01	65.99	110.80	44.81
5700.00	29.72	PK	H	34.18	3.68	0.00	67.58	61.56	105.20	43.64
5650.00	28.50	PK	H	34.16	3.63	0.00	66.29	60.27	68.20	7.93
11460.24	35.88	PK	H	38.96	6.59	25.51	55.92	49.9	74.00	24.10
11460.24	23.65	AV	H	38.96	6.59	25.51	43.69	37.67	54.00	16.33
17190.36	34.41	PK	H	41.30	8.77	23.76	60.72	54.7	68.20	13.50
Middle Channel: 5788.12 MHz										
5788.12	89.98	PK	H	34.22	3.71	0.00	127.91	121.89	N/A	N/A
5788.12	85.03	AV	H	34.22	3.71	0.00	122.96	116.94	N/A	N/A
5788.12	88.23	PK	V	34.22	3.71	0.00	126.16	120.14	N/A	N/A
5788.12	83.01	AV	V	34.22	3.71	0.00	120.94	114.92	N/A	N/A
11576.24	37.23	PK	H	39.00	6.61	25.46	57.38	51.36	74.00	22.64
11576.24	25.01	AV	H	39.00	6.61	25.46	45.16	39.14	54.00	14.86
17364.36	35.89	PK	H	42.31	8.81	23.59	63.42	57.4	68.20	10.80
High Channel: 5848.12 MHz										
5848.12	88.96	PK	H	34.24	3.75	0.00	126.95	120.93	N/A	N/A
5848.12	82.96	AV	H	34.24	3.75	0.00	120.95	114.93	N/A	N/A
5848.12	88.61	PK	V	34.24	3.75	0.00	126.60	120.58	N/A	N/A
5848.12	82.56	AV	V	34.24	3.75	0.00	120.55	114.53	N/A	N/A
5850.00	74.46	PK	H	34.24	3.75	0.00	112.45	106.43	122.20	15.77
5855.00	35.66	PK	H	34.24	3.75	0.00	73.65	67.63	110.80	43.17
5875.00	29.32	PK	H	34.25	3.77	0.00	67.34	61.32	105.20	43.88
5925.00	28.54	PK	H	34.27	3.80	0.00	66.61	60.59	68.20	7.61
11696.24	36.05	PK	H	39.00	6.65	25.38	56.32	50.3	74.00	23.70
11696.24	23.75	AV	H	39.00	6.65	25.38	44.02	38	54.00	16.00
17544.36	35.22	PK	H	43.38	8.85	23.44	64.01	57.99	68.20	10.21

**1.4M-CA Mode,Chain 1:**

Frequency (MHz)	Receiver		Rx Antenna		Cable loss (dB)	Amplifier Gain (dB)	Corrected Amplitude (dBµV/m)	Extrapolation result (dBµV/m)	Limit (dBµV/m)	Margin (dB)
	Reading (dBµV)	Detector	Polar (H/V)	Factor (dB/m)						
Low Channel: 5730.12 MHz										
5730.12	91.70	PK	H	34.19	3.69	0.00	129.58	123.56	N/A	N/A
5730.12	86.49	AV	H	34.19	3.69	0.00	124.37	118.35	N/A	N/A
5730.12	95.32	PK	V	34.19	3.69	0.00	133.20	127.18	N/A	N/A
5730.12	89.56	AV	V	34.19	3.69	0.00	127.44	121.42	N/A	N/A
5725.00	48.92	PK	V	34.19	3.69	0.00	86.80	80.78	122.20	41.42
5720.00	41.25	PK	V	34.19	3.69	0.00	79.13	73.11	110.80	37.69
5700.00	35.87	PK	V	34.18	3.68	0.00	73.73	67.71	105.20	37.49
5650.00	29.12	PK	V	34.16	3.63	0.00	66.91	60.89	68.20	7.31
11460.24	36.24	PK	V	38.96	6.59	25.51	56.28	50.26	74.00	23.74
11460.24	22.64	AV	V	38.96	6.59	25.51	42.68	36.66	54.00	17.34
17190.36	34.86	PK	V	41.30	8.77	23.76	61.17	55.15	68.20	13.05
Middle Channel: 5788.12 MHz										
5788.12	90.99	PK	H	34.22	3.71	0.00	128.92	122.9	N/A	N/A
5788.12	85.87	AV	H	34.22	3.71	0.00	123.80	117.78	N/A	N/A
5788.12	94.38	PK	V	34.22	3.71	0.00	132.31	126.29	N/A	N/A
5788.12	89.45	AV	V	34.22	3.71	0.00	127.38	121.36	N/A	N/A
11576.24	36.84	PK	V	39.00	6.61	25.46	56.99	50.97	74.00	23.03
11576.24	23.03	AV	V	39.00	6.61	25.46	43.18	37.16	54.00	16.84
17364.36	34.85	PK	V	42.31	8.81	23.59	62.38	56.36	68.20	11.84
High Channel: 5848.12 MHz										
5848.12	88.97	PK	H	34.24	3.75	0.00	126.96	120.94	N/A	N/A
5848.12	84.70	AV	H	34.24	3.75	0.00	122.69	116.67	N/A	N/A
5848.12	92.93	PK	V	34.24	3.75	0.00	130.92	124.9	N/A	N/A
5848.12	87.83	AV	V	34.24	3.75	0.00	125.82	119.8	N/A	N/A
5850.00	78.79	PK	V	34.24	3.75	0.00	116.78	110.76	122.20	11.44
5855.00	40.83	PK	V	34.24	3.75	0.00	78.82	72.8	110.80	38.00
5875.00	33.55	PK	V	34.25	3.77	0.00	71.57	65.55	105.20	39.65
5925.00	30.47	PK	V	34.27	3.80	0.00	68.54	62.52	68.20	5.68
11696.24	36.60	PK	V	39.00	6.65	25.38	56.87	50.85	74.00	23.15
11696.24	23.27	AV	V	39.00	6.65	25.38	43.54	37.52	54.00	16.48
17544.36	34.43	PK	V	43.38	8.85	23.44	63.22	57.2	68.20	11.00

**10MHz Mode, Chain 0:**

Frequency (MHz)	Receiver		Rx Antenna		Cable loss (dB)	Amplifier Gain (dB)	Corrected Amplitude (dBµV/m)	Extrapolation result (dBµV/m)	Limit (dBµV/m)	Margin (dB)
	Reading (dBµV)	Detector	Polar (H/V)	Factor (dB/m)						
Low Channel: 5730.5 MHz										
5730.50	80.11	PK	H	34.19	3.69	0.00	117.99	111.97	N/A	N/A
5730.50	69.12	AV	H	34.19	3.69	0.00	107.00	100.98	N/A	N/A
5730.50	76.41	PK	V	34.19	3.69	0.00	114.29	108.27	N/A	N/A
5730.50	63.03	AV	V	34.19	3.69	0.00	100.91	94.89	N/A	N/A
5725.00	62.38	PK	H	34.19	3.69	0.00	100.26	94.24	122.20	27.96
5720.00	37.22	PK	H	34.19	3.69	0.00	75.10	69.08	110.80	41.72
5700.00	28.12	PK	H	34.18	3.68	0.00	65.98	59.96	105.20	45.24
5650.00	27.72	PK	H	34.16	3.63	0.00	65.51	59.49	68.20	8.71
11461.00	36.41	PK	H	38.96	6.59	25.51	56.45	50.43	74.00	23.57
11461.00	23.12	AV	H	38.96	6.59	25.51	43.16	37.14	54.00	16.86
17191.50	34.66	PK	H	41.31	8.77	23.76	60.98	54.96	68.20	13.24
Middle Channel: 5787.5 MHz										
5787.50	79.54	PK	H	34.22	3.71	0.00	117.47	111.45	N/A	N/A
5787.50	67.66	AV	H	34.22	3.71	0.00	105.59	99.57	N/A	N/A
5787.50	75.61	PK	V	34.22	3.71	0.00	113.54	107.52	N/A	N/A
5787.50	63.51	AV	V	34.22	3.71	0.00	101.44	95.42	N/A	N/A
11575.00	35.90	PK	H	39.00	6.61	25.46	56.05	50.03	74.00	23.97
11575.00	22.55	AV	H	39.00	6.61	25.46	42.70	36.68	54.00	17.32
17362.50	35.45	PK	H	42.30	8.81	23.59	62.97	56.95	68.20	11.25
High Channel: 5844.5 MHz										
5844.50	77.51	PK	H	34.24	3.75	0.00	115.50	109.48	N/A	N/A
5844.50	65.94	AV	H	34.24	3.75	0.00	103.93	97.91	N/A	N/A
5844.50	74.96	PK	V	34.24	3.75	0.00	112.95	106.93	N/A	N/A
5844.50	63.54	AV	V	34.24	3.75	0.00	101.53	95.51	N/A	N/A
5850.00	58.22	PK	H	34.24	3.75	0.00	96.21	90.19	122.20	32.01
5855.00	29.54	PK	H	34.24	3.75	0.00	67.53	61.51	110.80	49.29
5875.00	27.70	PK	H	34.25	3.77	0.00	65.72	59.7	105.20	45.50
5925.00	27.37	PK	H	34.27	3.80	0.00	65.44	59.42	68.20	8.78
11689.00	35.50	PK	H	39.00	6.65	25.38	55.77	49.75	74.00	24.25
11689.00	22.58	AV	H	39.00	6.65	25.38	42.85	36.83	54.00	17.17
17533.50	35.05	PK	H	43.31	8.85	23.44	63.77	57.75	68.20	10.45

**10MHz Mode, Chain 1:**

Frequency (MHz)	Receiver		Rx Antenna		Cable loss (dB)	Amplifier Gain (dB)	Corrected Amplitude (dBµV/m)	Extrapolation result (dBµV/m)	Limit (dBµV/m)	Margin (dB)
	Reading (dBµV)	Detector	Polar (H/V)	Factor (dB/m)						
Low Channel: 5730.5 MHz										
5730.50	84.02	PK	H	34.19	3.69	0.00	121.90	115.88	N/A	N/A
5730.50	70.39	AV	H	34.19	3.69	0.00	108.27	102.25	N/A	N/A
5730.50	83.92	PK	V	34.19	3.69	0.00	121.80	115.78	N/A	N/A
5730.50	70.29	AV	V	34.19	3.69	0.00	108.17	102.15	N/A	N/A
5725.00	61.39	PK	H	34.19	3.69	0.00	99.27	93.25	122.20	28.95
5720.00	34.84	PK	H	34.19	3.69	0.00	72.72	66.7	110.80	44.10
5700.00	28.88	PK	H	34.18	3.68	0.00	66.74	60.72	105.20	44.48
5650.00	28.47	PK	H	34.16	3.63	0.00	66.26	60.24	68.20	7.96
11461.00	35.96	PK	H	38.96	6.59	25.51	56.00	49.98	74.00	24.02
11461.00	22.53	AV	H	38.96	6.59	25.51	42.57	36.55	54.00	17.45
17191.50	34.31	PK	H	41.31	8.77	23.76	60.63	54.61	68.20	13.59
Middle Channel: 5787.5 MHz										
5787.50	81.94	PK	H	34.22	3.71	0.00	119.87	113.85	N/A	N/A
5787.50	69.36	AV	H	34.22	3.71	0.00	107.29	101.27	N/A	N/A
5787.50	80.43	PK	V	34.22	3.71	0.00	118.36	112.34	N/A	N/A
5787.50	67.95	AV	V	34.22	3.71	0.00	105.88	99.86	N/A	N/A
11575.00	35.28	PK	H	39.00	6.61	25.46	55.43	49.41	74.00	24.59
11575.00	22.56	AV	H	39.00	6.61	25.46	42.71	36.69	54.00	17.31
17362.50	36.03	PK	H	42.30	8.81	23.59	63.55	57.53	68.20	10.67
High Channel: 5844.5 MHz										
5844.50	80.41	PK	H	34.24	3.75	0.00	118.40	112.38	N/A	N/A
5844.50	69.49	AV	H	34.24	3.75	0.00	107.48	101.46	N/A	N/A
5844.50	79.13	PK	V	34.24	3.75	0.00	117.12	111.1	N/A	N/A
5844.50	67.75	AV	V	34.24	3.75	0.00	105.74	99.72	N/A	N/A
5850.00	62.91	PK	H	34.24	3.75	0.00	100.90	94.88	122.20	27.32
5855.00	35.54	PK	H	34.24	3.75	0.00	73.53	67.51	110.80	43.29
5875.00	28.11	PK	H	34.25	3.77	0.00	66.13	60.11	105.20	45.09
5925.00	27.56	PK	H	34.27	3.80	0.00	65.63	59.61	68.20	8.59
11689.00	35.68	PK	H	39.00	6.65	25.38	55.95	49.93	74.00	24.07
11689.00	22.61	AV	H	39.00	6.65	25.38	42.88	36.86	54.00	17.14
17533.50	35.23	PK	H	43.31	8.85	23.44	63.95	57.93	68.20	10.27

**20MHz Mode, Chain 0:**

Frequency (MHz)	Receiver		Rx Antenna		Cable loss (dB)	Amplifier Gain (dB)	Corrected Amplitude (dBµV/m)	Extrapolation result (dBµV/m)	Limit (dBµV/m)	Margin (dB)
	Reading (dBµV)	Detector	Polar (H/V)	Factor (dB/m)						
Low Channel: 5735.5 MHz										
5735.50	74.08	PK	H	34.19	3.69	0.00	111.96	105.94	N/A	N/A
5735.50	62.10	AV	H	34.19	3.69	0.00	99.98	93.96	N/A	N/A
5735.50	73.26	PK	V	34.19	3.69	0.00	111.14	105.12	N/A	N/A
5735.50	60.42	AV	V	34.19	3.69	0.00	98.30	92.28	N/A	N/A
5725.00	46.34	PK	H	34.19	3.69	0.00	84.22	78.2	122.20	44.00
5720.00	28.47	PK	H	34.19	3.69	0.00	66.35	60.33	110.80	50.47
5700.00	27.95	PK	H	34.18	3.68	0.00	65.81	59.79	105.20	45.41
5650.00	27.70	PK	H	34.16	3.63	0.00	65.49	59.47	68.20	8.73
11471.00	36.07	PK	H	38.97	6.59	25.51	56.12	50.1	74.00	23.90
11471.00	24.54	AV	H	38.97	6.59	25.51	44.59	38.57	54.00	15.43
17206.50	36.12	PK	H	41.40	8.77	23.75	62.54	56.52	68.20	11.68
Middle Channel: 5787.5 MHz										
5787.50	77.24	PK	H	34.22	3.71	0.00	115.17	109.15	N/A	N/A
5787.50	65.28	AV	H	34.22	3.71	0.00	103.21	97.19	N/A	N/A
5787.50	73.91	PK	V	34.22	3.71	0.00	111.84	105.82	N/A	N/A
5787.50	61.43	AV	V	34.22	3.71	0.00	99.36	93.34	N/A	N/A
11575.00	36.24	PK	H	39.00	6.61	25.46	56.39	50.37	74.00	23.63
11575.00	22.56	AV	H	39.00	6.61	25.46	42.71	36.69	54.00	17.31
17362.50	36.04	PK	H	42.30	8.81	23.59	63.56	57.54	68.20	10.66
High Channel: 5839.5 MHz										
5839.50	77.91	PK	H	34.24	3.74	0.00	115.89	109.87	N/A	N/A
5839.50	66.19	AV	H	34.24	3.74	0.00	104.17	98.15	N/A	N/A
5839.50	76.18	PK	V	34.24	3.74	0.00	114.16	108.14	N/A	N/A
5839.50	64.18	AV	V	34.24	3.74	0.00	102.16	96.14	N/A	N/A
5850.00	46.56	PK	H	34.24	3.75	0.00	84.55	78.53	122.20	43.67
5855.00	28.50	PK	H	34.24	3.75	0.00	66.49	60.47	110.80	50.33
5875.00	27.56	PK	H	34.25	3.77	0.00	65.58	59.56	105.20	45.64
5925.00	27.40	PK	H	34.27	3.80	0.00	65.47	59.45	68.20	8.75
11679.00	35.61	PK	H	39.00	6.65	25.39	55.87	49.85	74.00	24.15
11679.00	22.07	AV	H	39.00	6.65	25.39	42.33	36.31	54.00	17.69
17518.50	35.88	PK	H	43.21	8.85	23.45	64.49	58.47	68.20	9.73

**20MHz Mode, Chain 1:**

Frequency (MHz)	Receiver		Rx Antenna		Cable loss (dB)	Amplifier Gain (dB)	Corrected Amplitude (dBµV/m)	Extrapolation result (dBµV/m)	Limit (dBµV/m)	Margin (dB)
	Reading (dBµV)	Detector	Polar (H/V)	Factor (dB/m)						
Low Channel: 5735.5 MHz										
5735.50	78.01	PK	H	34.19	3.69	0.00	115.89	109.87	N/A	N/A
5735.50	65.01	AV	H	34.19	3.69	0.00	102.89	96.87	N/A	N/A
5735.50	74.37	PK	V	34.19	3.69	0.00	112.25	106.23	N/A	N/A
5735.50	62.35	AV	V	34.19	3.69	0.00	100.23	94.21	N/A	N/A
5725.00	50.24	PK	H	34.19	3.69	0.00	88.12	82.1	122.20	40.10
5720.00	30.86	PK	H	34.19	3.69	0.00	68.74	62.72	110.80	48.08
5700.00	28.51	PK	H	34.18	3.68	0.00	66.37	60.35	105.20	44.85
5650.00	27.97	PK	H	34.16	3.63	0.00	65.76	59.74	68.20	8.46
11471.00	34.15	PK	H	38.97	6.59	25.51	54.20	48.18	74.00	25.82
11471.00	20.63	AV	H	38.97	6.59	25.51	40.68	34.66	54.00	19.34
17206.50	35.86	PK	H	41.40	8.77	23.75	62.28	56.26	68.20	11.94
Middle Channel: 5787.5 MHz										
5787.50	76.84	PK	H	34.22	3.71	0.00	114.77	108.75	N/A	N/A
5787.50	64.23	AV	H	34.22	3.71	0.00	102.16	96.14	N/A	N/A
5787.50	76.40	PK	V	34.22	3.71	0.00	114.33	108.31	N/A	N/A
5787.50	64.53	AV	V	34.22	3.71	0.00	102.46	96.44	N/A	N/A
11575.00	34.54	PK	H	39.00	6.61	25.46	54.69	48.67	74.00	25.33
11575.00	19.44	AV	H	39.00	6.61	25.46	39.59	33.57	54.00	20.43
17362.50	36.06	PK	H	42.30	8.81	23.59	63.58	57.56	68.20	10.64
High Channel: 5839.5 MHz										
5839.50	76.64	PK	H	34.24	3.74	0.00	114.62	108.6	N/A	N/A
5839.50	64.49	AV	H	34.24	3.74	0.00	102.47	96.45	N/A	N/A
5839.50	72.17	PK	V	34.24	3.74	0.00	110.15	104.13	N/A	N/A
5839.50	59.37	AV	V	34.24	3.74	0.00	97.35	91.33	N/A	N/A
5850.00	47.73	PK	H	34.24	3.75	0.00	85.72	79.7	122.20	42.50
5855.00	29.21	PK	H	34.24	3.75	0.00	67.20	61.18	110.80	49.62
5875.00	28.73	PK	H	34.25	3.77	0.00	66.75	60.73	105.20	44.47
5925.00	28.08	PK	H	34.27	3.80	0.00	66.15	60.13	68.20	8.07
11679.00	34.48	PK	H	39.00	6.65	25.39	54.74	48.72	74.00	25.28
11679.00	20.27	AV	H	39.00	6.65	25.39	40.53	34.51	54.00	19.49
17518.50	35.81	PK	H	43.21	8.85	23.45	64.42	58.4	68.20	9.80



**1.4MHz Mode, MIMO:**

Frequency (MHz)	Receiver		Rx Antenna		Cable loss (dB)	Amplifier Gain (dB)	Corrected Amplitude (dBµV/m)	Extrapolation result (dBµV/m)	Limit (dBµV/m)	Margin (dB)
	Reading (dBµV)	Detector	Polar (H/V)	Factor (dB/m)						
Low Channel: 5728.5 MHz										
5728.50	94.67	PK	H	34.19	3.69	0.00	132.55	126.53	N/A	N/A
5728.50	85.98	AV	H	34.19	3.69	0.00	123.86	117.84	N/A	N/A
5728.50	95.33	PK	V	34.19	3.69	0.00	133.21	127.19	N/A	N/A
5728.50	87.00	AV	V	34.19	3.69	0.00	124.88	118.86	N/A	N/A
5725.00	51.08	PK	V	34.19	3.69	0.00	88.96	82.94	122.20	39.26
5720.00	37.45	PK	V	34.19	3.69	0.00	75.33	69.31	110.80	41.49
5700.00	32.85	PK	V	34.18	3.68	0.00	70.71	64.69	105.20	40.51
5650.00	31.95	PK	V	34.16	3.63	0.00	69.74	63.72	68.20	4.48
11457.00	37.85	PK	V	38.96	6.59	25.50	57.90	51.88	74.00	22.12
11457.00	24.76	AV	V	38.96	6.59	25.50	44.81	38.79	54.00	15.21
17185.50	34.80	PK	V	41.28	8.77	23.77	61.08	55.06	68.20	13.14
Middle Channel: 5784.5 MHz										
5784.50	94.52	PK	H	34.21	3.71	0.00	132.44	126.42	N/A	N/A
5784.50	85.89	AV	H	34.21	3.71	0.00	123.81	117.79	N/A	N/A
5784.50	94.78	PK	V	34.21	3.71	0.00	132.70	126.68	N/A	N/A
5784.50	76.50	AV	V	34.21	3.71	0.00	114.42	108.4	N/A	N/A
11569.00	36.47	PK	V	39.00	6.61	25.46	56.62	50.6	74.00	23.40
11569.00	24.21	AV	V	39.00	6.61	25.46	44.36	38.34	54.00	15.66
17353.50	38.36	PK	V	42.25	8.81	23.60	65.82	59.8	68.20	8.40
High Channel: 5846.5 MHz										
5846.50	93.64	PK	H	34.24	3.75	0.00	131.63	125.61	N/A	N/A
5846.50	85.25	AV	H	34.24	3.75	0.00	123.24	117.22	N/A	N/A
5846.50	94.49	PK	V	34.24	3.75	0.00	132.48	126.46	N/A	N/A
5846.50	85.85	AV	V	34.24	3.75	0.00	123.84	117.82	N/A	N/A
5850.00	53.86	PK	V	34.24	3.75	0.00	91.85	85.83	122.20	36.37
5855.00	37.59	PK	V	34.24	3.75	0.00	75.58	69.56	110.80	41.24
5875.00	30.82	PK	V	34.25	3.77	0.00	68.84	62.82	105.20	42.38
5925.00	29.63	PK	V	34.27	3.80	0.00	67.70	61.68	68.20	6.52
11693.00	36.81	PK	V	39.00	6.65	25.38	57.08	51.06	74.00	22.94
11693.00	24.80	AV	V	39.00	6.65	25.38	45.07	39.05	54.00	14.95
17539.50	38.95	PK	V	43.34	8.85	23.44	67.70	61.68	68.20	6.52

**1.4MHz-CA Mode, MIMO:**

Frequency (MHz)	Receiver		Rx Antenna		Cable loss (dB)	Amplifier Gain (dB)	Corrected Amplitude (dB $\mu$ V/m)	Extrapolation result (dB $\mu$ V/m)	Limit (dB $\mu$ V/m)	Margin (dB)
	Reading (dB $\mu$ V)	Detector	Polar (H/V)	Factor (dB/m)						
Low Channel: 5730.12 MHz										
5730.12	95.06	PK	H	34.19	3.69	0.00	132.94	126.92	N/A	N/A
5730.12	86.52	AV	H	34.19	3.69	0.00	124.40	118.38	N/A	N/A
5730.12	95.46	PK	V	34.19	3.69	0.00	133.34	127.32	N/A	N/A
5730.12	87.21	AV	V	34.19	3.69	0.00	125.09	119.07	N/A	N/A
5850.00	41.04	PK	V	34.24	3.75	0.00	79.03	73.01	122.20	49.19
5855.00	37.10	PK	V	34.24	3.75	0.00	75.09	69.07	110.80	41.73
5875.00	31.11	PK	V	34.25	3.77	0.00	69.13	63.11	105.20	42.09
5925.00	30.49	PK	V	34.27	3.80	0.00	68.56	62.54	68.20	5.66
11460.24	39.19	PK	V	38.96	6.59	25.51	59.23	53.21	74.00	20.79
11460.24	27.15	AV	V	38.96	6.59	25.51	47.19	41.17	54.00	12.83
17190.36	37.87	PK	V	41.30	8.77	23.76	64.18	58.16	68.20	10.04
Middle Channel: 5788.12 MHz										
5788.12	94.08	PK	H	34.22	3.71	0.00	132.01	125.99	N/A	N/A
5788.12	86.25	AV	H	34.22	3.71	0.00	124.18	118.16	N/A	N/A
5788.12	95.28	PK	V	34.22	3.71	0.00	133.21	127.19	N/A	N/A
5788.12	87.06	AV	V	34.22	3.71	0.00	124.99	118.97	N/A	N/A
11576.24	36.85	PK	V	39.00	6.61	25.46	57.00	50.98	74.00	23.02
11576.24	24.21	AV	V	39.00	6.61	25.46	44.36	38.34	54.00	15.66
17364.36	39.00	PK	V	42.31	8.81	23.59	66.53	60.51	68.20	7.69
High Channel: 5848.12 MHz										
5848.12	95.06	PK	H	34.24	3.75	0.00	133.05	127.03	N/A	N/A
5848.12	86.52	AV	H	34.24	3.75	0.00	124.51	118.49	N/A	N/A
5848.12	95.46	PK	V	34.24	3.75	0.00	133.45	127.43	N/A	N/A
5848.12	87.21	AV	V	34.24	3.75	0.00	125.20	119.18	N/A	N/A
5850.00	41.04	PK	V	34.24	3.75	0.00	79.03	73.01	122.20	49.19
5855.00	37.10	PK	V	34.24	3.75	0.00	75.09	69.07	110.80	41.73
5875.00	31.11	PK	V	34.25	3.77	0.00	69.13	63.11	105.20	42.09
5925.00	30.49	PK	V	34.27	3.80	0.00	68.56	62.54	68.20	5.66
11696.24	39.19	PK	V	39.00	6.65	25.38	59.46	53.44	74.00	20.56
11696.24	27.15	AV	V	39.00	6.65	25.38	47.42	41.4	54.00	12.60
17544.36	37.87	PK	V	43.38	8.85	23.44	66.66	60.64	68.20	7.56

**10MHz Mode, MIMO:**

Frequency (MHz)	Receiver		Rx Antenna		Cable loss (dB)	Amplifier Gain (dB)	Corrected Amplitude (dBµV/m)	Extrapolation result (dBµV/m)	Limit (dBµV/m)	Margin (dB)
	Reading (dBµV)	Detector	Polar (H/V)	Factor (dB/m)						
Low Channel: 5730.5 MHz										
5730.50	76.29	PK	H	34.19	3.69	0.00	114.17	108.15	N/A	N/A
5730.50	64.58	AV	H	34.19	3.69	0.00	102.46	96.44	N/A	N/A
5730.50	77.21	PK	V	34.19	3.69	0.00	115.09	109.07	N/A	N/A
5730.50	65.56	AV	V	34.19	3.69	0.00	103.44	97.42	N/A	N/A
5850.00	60.30	PK	V	34.24	3.75	0.00	98.29	92.27	122.20	29.93
5855.00	30.71	PK	V	34.24	3.75	0.00	68.70	62.68	110.80	48.12
5875.00	27.55	PK	V	34.25	3.77	0.00	65.57	59.55	105.20	45.65
5925.00	27.21	PK	V	34.27	3.80	0.00	65.28	59.26	68.20	8.94
11461.00	41.20	PK	V	38.96	6.59	25.51	61.24	55.22	74.00	18.78
11461.00	25.56	AV	V	38.96	6.59	25.51	45.60	39.58	54.00	14.42
17191.50	34.78	PK	V	41.31	8.77	23.76	61.10	55.08	68.20	13.12
Middle Channel: 5787.5 MHz										
5787.50	74.83	PK	H	34.22	3.71	0.00	112.76	106.74	N/A	N/A
5787.50	61.44	AV	H	34.22	3.71	0.00	99.37	93.35	N/A	N/A
5787.50	77.23	PK	V	34.22	3.71	0.00	115.16	109.14	N/A	N/A
5787.50	64.71	AV	V	34.22	3.71	0.00	102.64	96.62	N/A	N/A
11575.00	41.16	PK	V	39.00	6.61	25.46	61.31	55.29	74.00	18.71
11575.00	26.79	AV	V	39.00	6.61	25.46	46.94	40.92	54.00	13.08
17362.50	35.61	PK	V	42.30	8.81	23.59	63.13	57.11	68.20	11.09
High Channel: 5844.5 MHz										
5844.50	75.58	PK	H	34.24	3.75	0.00	113.57	107.55	N/A	N/A
5844.50	64.76	AV	H	34.24	3.75	0.00	102.75	96.73	N/A	N/A
5844.50	76.24	PK	V	34.24	3.75	0.00	114.23	108.21	N/A	N/A
5844.50	65.31	AV	V	34.24	3.75	0.00	103.30	97.28	N/A	N/A
5850.00	57.03	PK	V	34.24	3.75	0.00	95.02	89	122.20	33.20
5855.00	29.00	PK	V	34.24	3.75	0.00	66.99	60.97	110.80	49.83
5875.00	28.08	PK	V	34.25	3.77	0.00	66.10	60.08	105.20	45.12
5925.00	27.54	PK	V	34.27	3.80	0.00	65.61	59.59	68.20	8.61
11689.00	48.23	PK	V	39.00	6.65	25.38	68.50	62.48	74.00	11.52
11689.00	32.57	AV	V	39.00	6.65	25.38	52.84	46.82	54.00	7.18
17533.50	35.56	PK	V	43.31	8.85	23.44	64.28	58.26	68.20	9.94

**20MHz Mode, MIMO:**

Frequency (MHz)	Receiver		Rx Antenna		Cable loss (dB)	Amplifier Gain (dB)	Corrected Amplitude (dBµV/m)	Extrapolation result (dBµV/m)	Limit (dBµV/m)	Margin (dB)
	Reading (dBµV)	Detector	Polar (H/V)	Factor (dB/m)						
Low Channel: 5735.5 MHz										
5735.50	74.49	PK	H	34.19	3.69	0.00	112.37	106.35	N/A	N/A
5735.50	60.76	AV	H	34.19	3.69	0.00	98.64	92.62	N/A	N/A
5735.50	75.95	PK	V	34.19	3.69	0.00	113.83	107.81	N/A	N/A
5735.50	62.44	AV	V	34.19	3.69	0.00	100.32	94.3	N/A	N/A
5850.00	50.54	PK	V	34.24	3.75	0.00	88.53	82.51	122.20	39.69
5855.00	29.23	PK	V	34.24	3.75	0.00	67.22	61.2	110.80	49.60
5875.00	28.09	PK	V	34.25	3.77	0.00	66.11	60.09	105.20	45.11
5925.00	27.71	PK	V	34.27	3.80	0.00	65.78	59.76	68.20	8.44
11471.00	37.50	PK	V	38.97	6.59	25.51	57.55	51.53	74.00	22.47
11471.00	23.68	AV	V	38.97	6.59	25.51	43.73	37.71	54.00	16.29
17206.50	34.33	PK	V	41.40	8.77	23.75	60.75	54.73	68.20	13.47
Middle Channel: 5787.5 MHz										
5787.50	73.56	PK	H	34.22	3.71	0.00	111.49	105.47	N/A	N/A
5787.50	62.56	AV	H	34.22	3.71	0.00	100.49	94.47	N/A	N/A
5787.50	75.11	PK	V	34.22	3.71	0.00	113.04	107.02	N/A	N/A
5787.50	63.45	AV	V	34.22	3.71	0.00	101.38	95.36	N/A	N/A
11575.00	35.80	PK	V	39.00	6.61	25.46	55.95	49.93	74.00	24.07
11575.00	21.24	AV	V	39.00	6.61	25.46	41.39	35.37	54.00	18.63
17362.50	35.47	PK	V	42.30	8.81	23.59	62.99	56.97	68.20	11.23
High Channel: 5839.5 MHz										
5839.50	73.77	PK	H	34.24	3.74	0.00	111.75	105.73	N/A	N/A
5839.50	60.23	AV	H	34.24	3.74	0.00	98.21	92.19	N/A	N/A
5839.50	74.92	PK	V	34.24	3.74	0.00	112.90	106.88	N/A	N/A
5839.50	61.07	AV	V	34.24	3.74	0.00	99.05	93.03	N/A	N/A
5850.00	48.95	PK	V	34.24	3.75	0.00	86.94	80.92	122.20	41.28
5855.00	28.39	PK	V	34.24	3.75	0.00	66.38	60.36	110.80	50.44
5875.00	27.74	PK	V	34.25	3.77	0.00	65.76	59.74	105.20	45.46
5925.00	27.02	PK	V	34.27	3.80	0.00	65.09	59.07	68.20	9.13
11679.00	41.95	PK	V	39.00	6.65	25.39	62.21	56.19	74.00	17.81
11679.00	23.15	AV	V	39.00	6.65	25.39	43.41	37.39	54.00	16.61
17518.50	35.23	PK	V	43.21	8.85	23.45	63.84	57.82	68.20	10.38

**Test Plots(1.4M MIMO mode high channel was the worst)  
Horizontal**

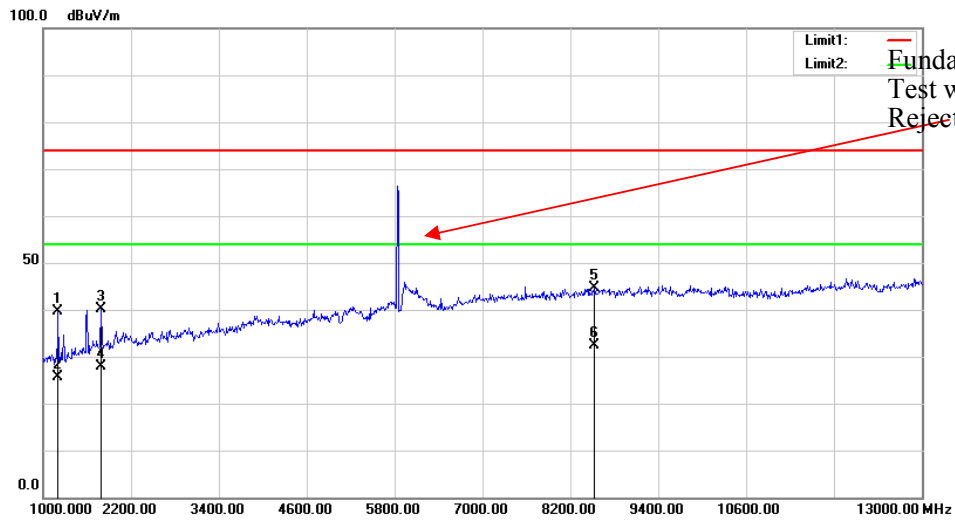

Fundamental  
Test with Band  
Rejection Filter

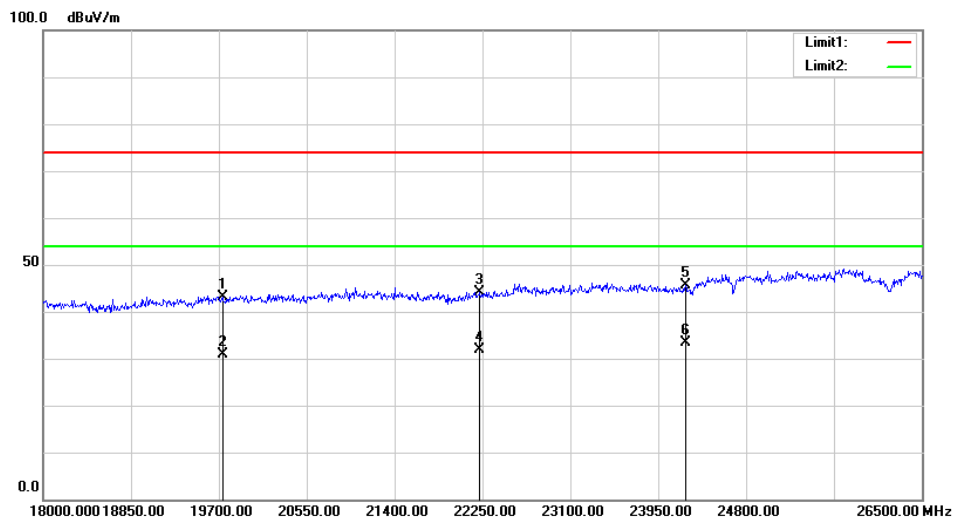
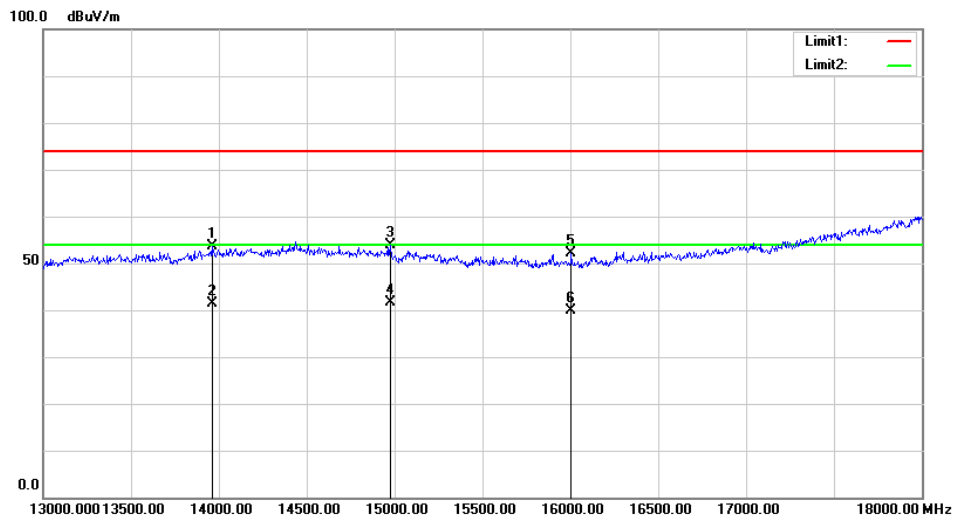

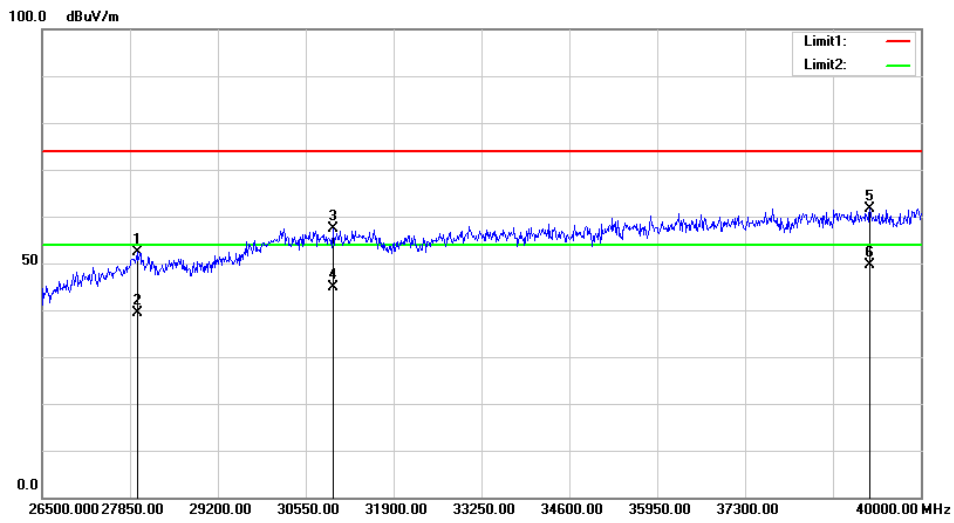

Vertical

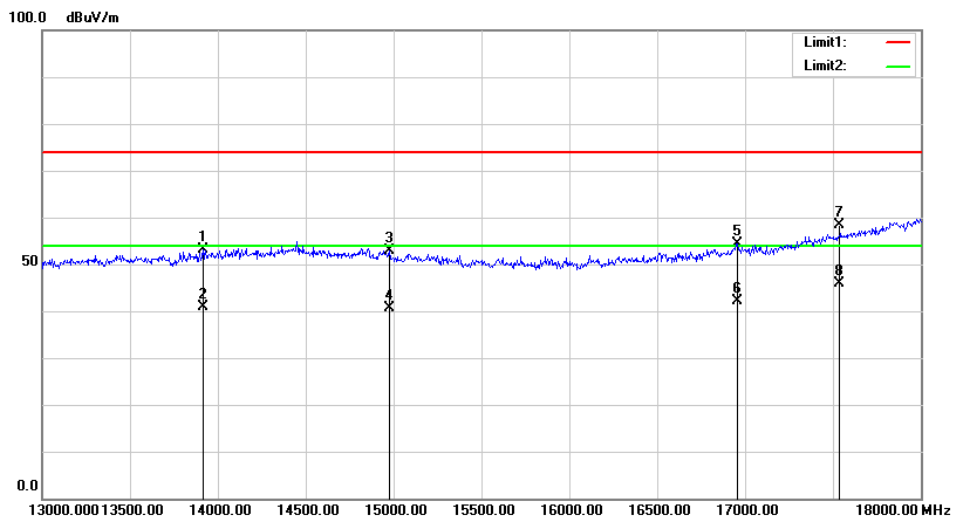
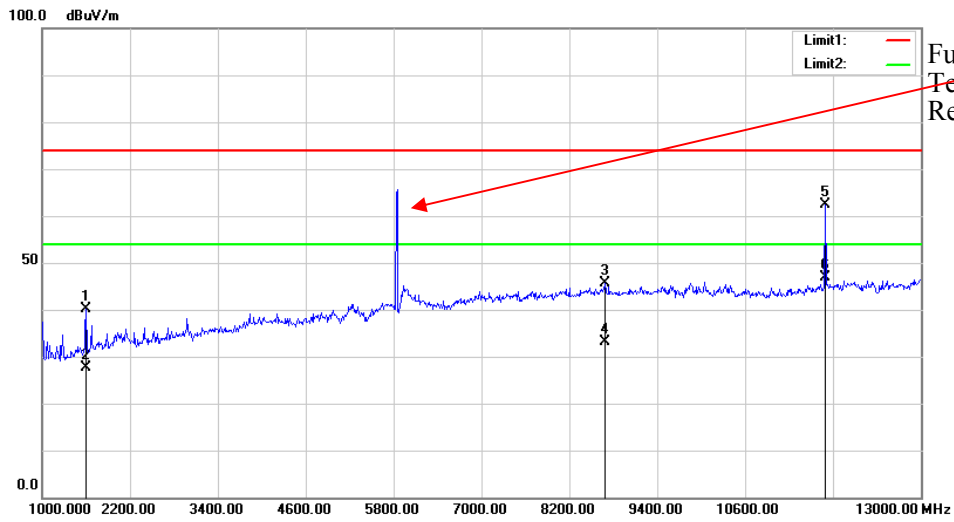

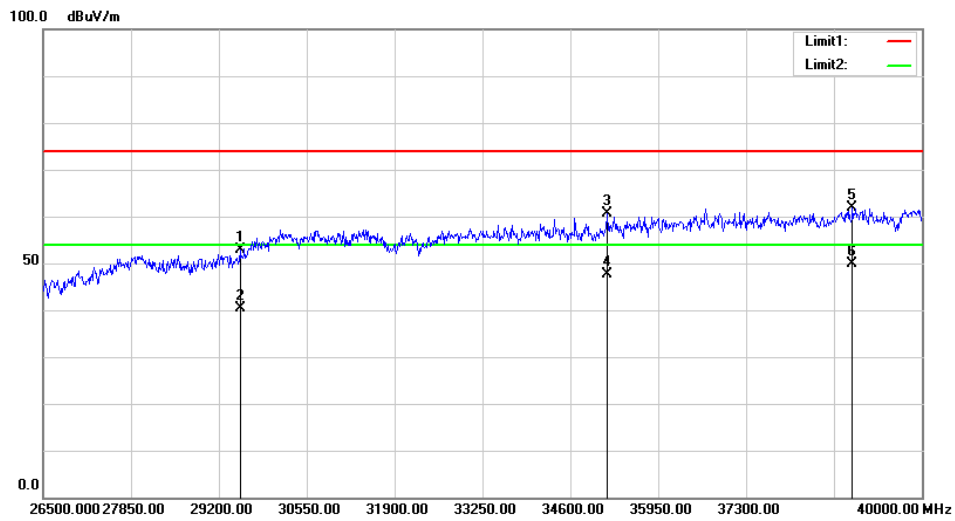
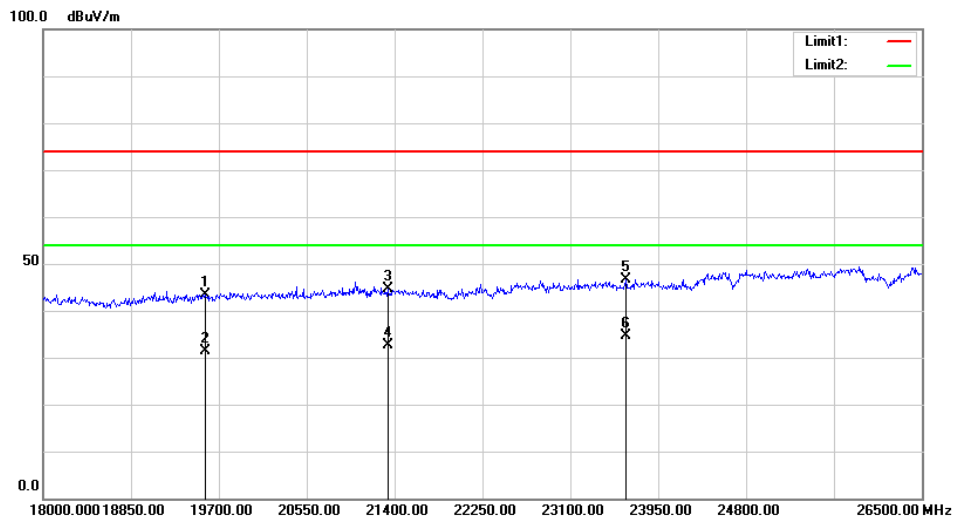

## FCC §15.407(a)(e) & RSS-247 CLAUSE 6.2, RSS-Gen CLAUSE 6.7– EMISSION BANDWIDTH AND OCCUPIED BANDWIDTH

### Applicable Standard

15.407(a) (e), RSS-247 Clause 6.2 and RSS-Gen Clause 6.7

### Test Equipment List and Details

Manufacturer	Description	Model	Serial Number	Calibration Date	Calibration Due Date
R&S	Spectrum Analyzer	FSV40	101474	2020-07-07	2021-07-07
yzjingcheng	Coaxial Cable	KTRFBU-141-50	41005012	Each time	N/A
Unknown	Coaxial Cable	C-SJ00-0010	C0010/02	Each time	N/A

\* **Statement of Traceability:** Bay Area Compliance Laboratories Corp. (Dongguan) attests that all calibrations have been performed, traceable to National Primary Standards and International System of Units (SI).

### Test Procedure

According to KDB 789033 D02 General UNII Test Procedures New Rules v02r01

### Test Data

#### Environmental Conditions

<b>Temperature:</b>	25.4 °C
<b>Relative Humidity:</b>	72 %
<b>ATM Pressure:</b>	100.7 kPa
<b>Tester:</b>	Severn Zhu
<b>Test Date:</b>	2020-08-05

*Test Mode: Transmitting*

*Test Result: Compliance. Test was only performed at Chain 0. please refer to the following table and plots.*



Mode	Frequency (MHz)	6 dB Emission Bandwidth (MHz)	99% Occupied Bandwidth (MHz)	Limis (MHz)
1.4M	5728.5	1.149	1.778	$\geq 0.5$
	5784.5	1.130	1.641	$\geq 0.5$
	5846.5	1.141	1.695	$\geq 0.5$
1.4M-CA	5730.12	1.138	1.749	$\geq 0.5$
	5788.12	1.140	1.713	$\geq 0.5$
	5848.12	1.145	1.671	$\geq 0.5$
10M	5730.5	9.125	9.142	$\geq 0.5$
	5787.5	9.087	9.142	$\geq 0.5$
	5844.5	9.102	9.102	$\geq 0.5$
20M	5735.5	18.131	17.964	$\geq 0.5$
	5787.5	18.261	17.884	$\geq 0.5$
	5839.5	18.246	17.964	$\geq 0.5$

**6dB Emission Bandwidth:**

**1.4M Low Channel**

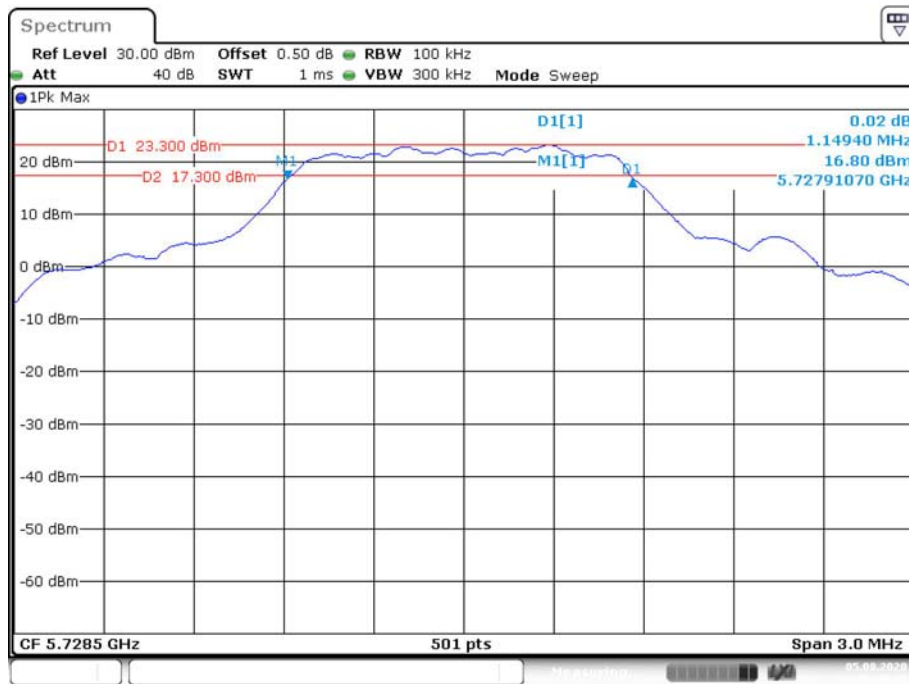

Date: 5.AUG.2020 20:48:10

**1.4M Middle Channel**

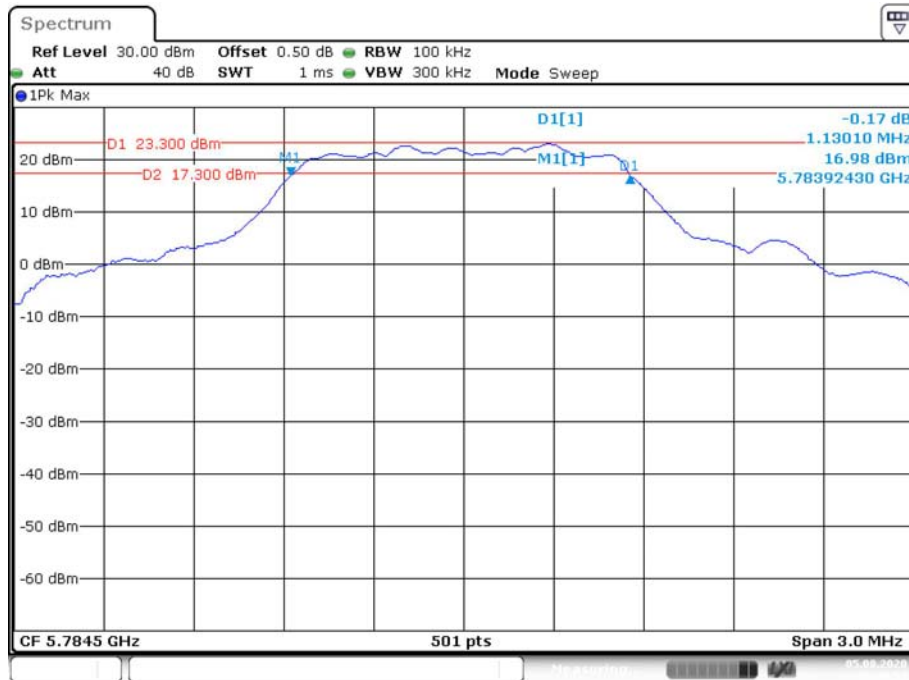

Date: 5.AUG.2020 20:49:57

### 1.4M High Channel

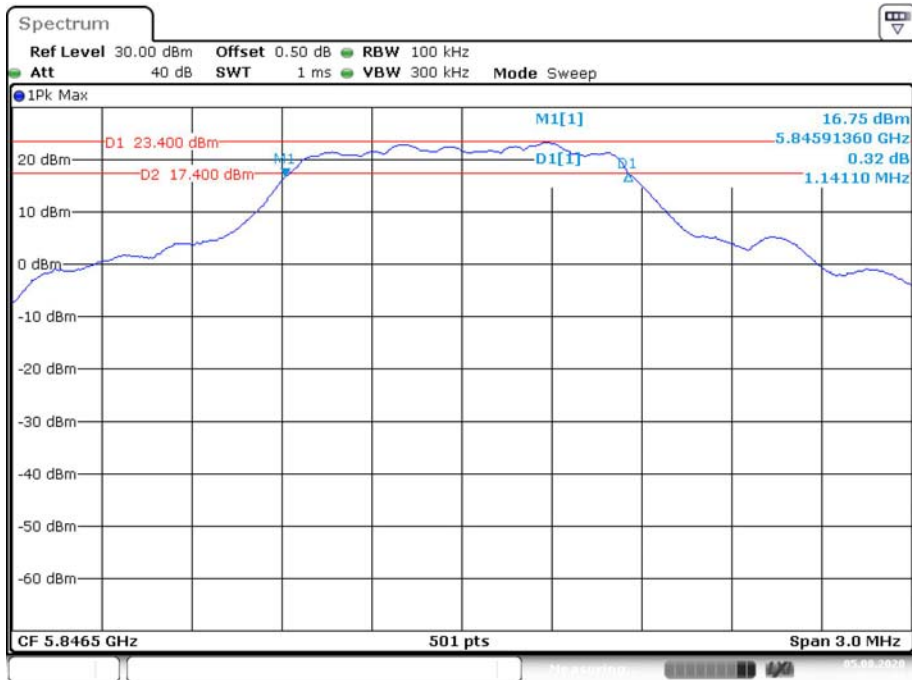

Date: 5.AUG.2020 20:52:06

### 1.4M-CA Low Channel

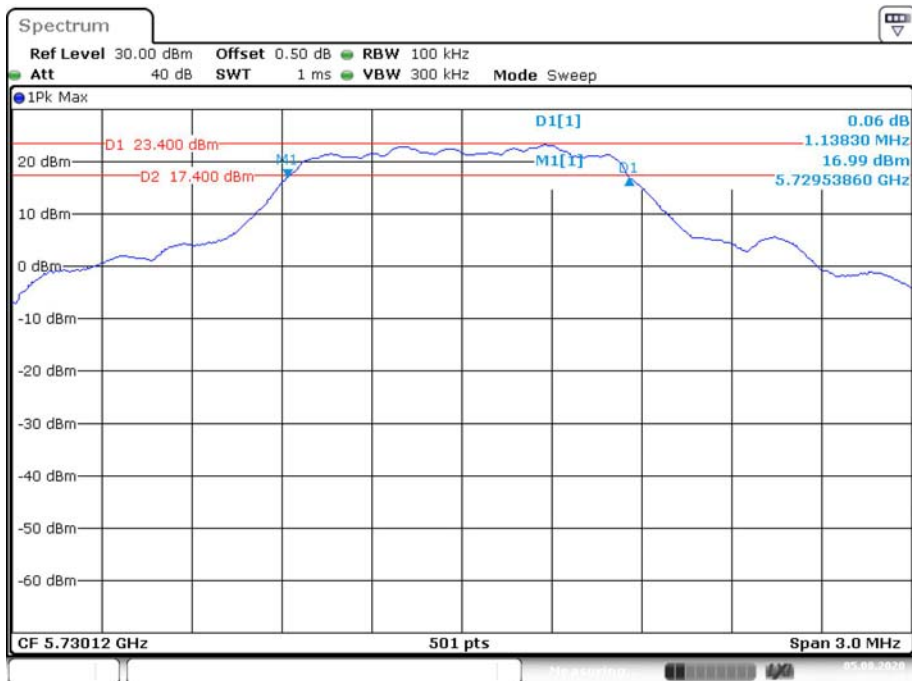

Date: 5.AUG.2020 20:53:31

### 1.4M-CA Middle Channel

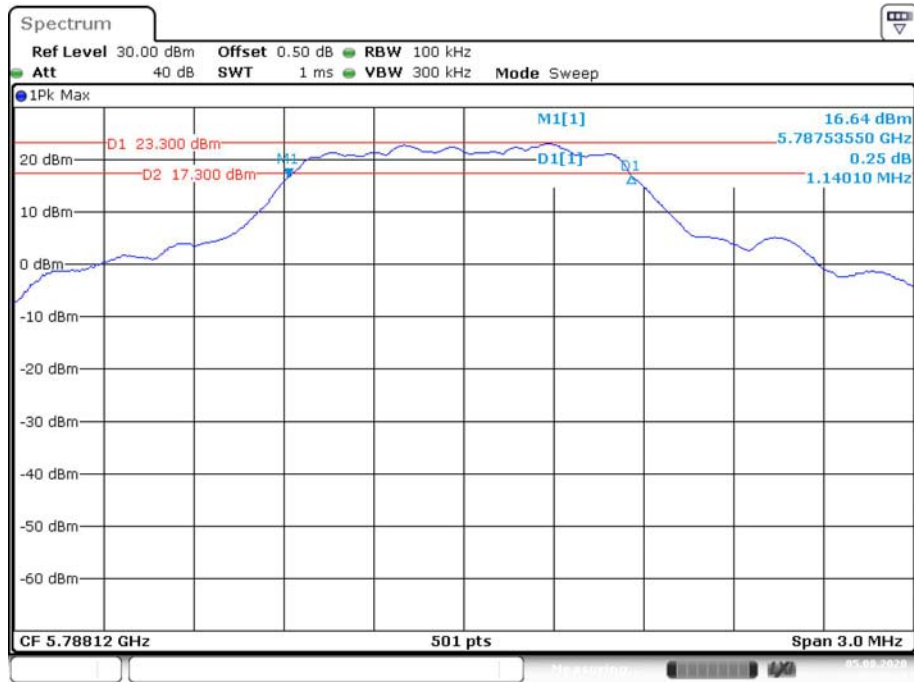

Date: 5.AUG.2020 20:55:16

### 1.4M-CA High Channel

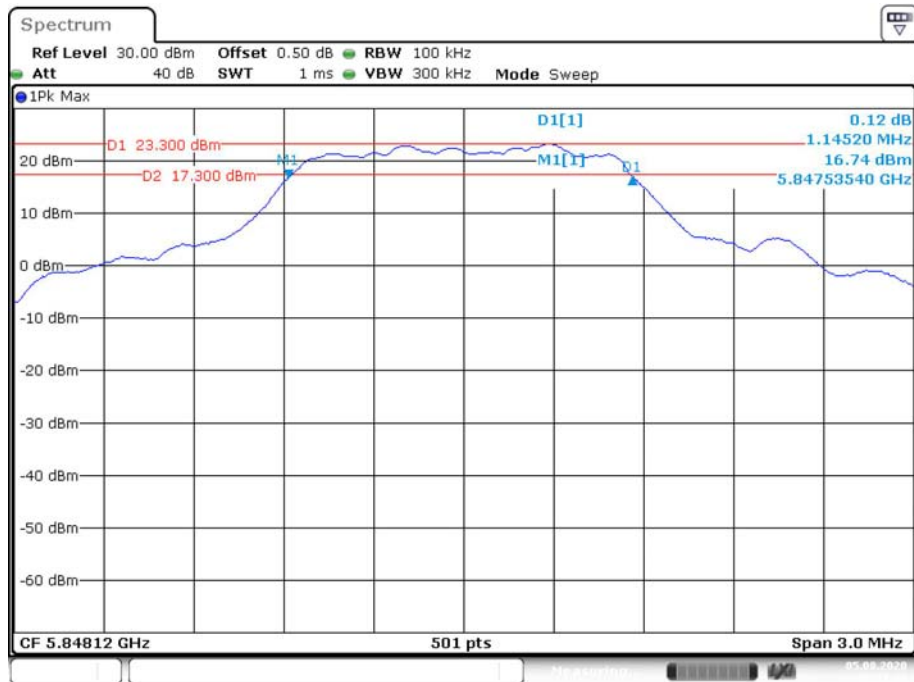

Date: 5.AUG.2020 20:57:49

### 10M Low Channel

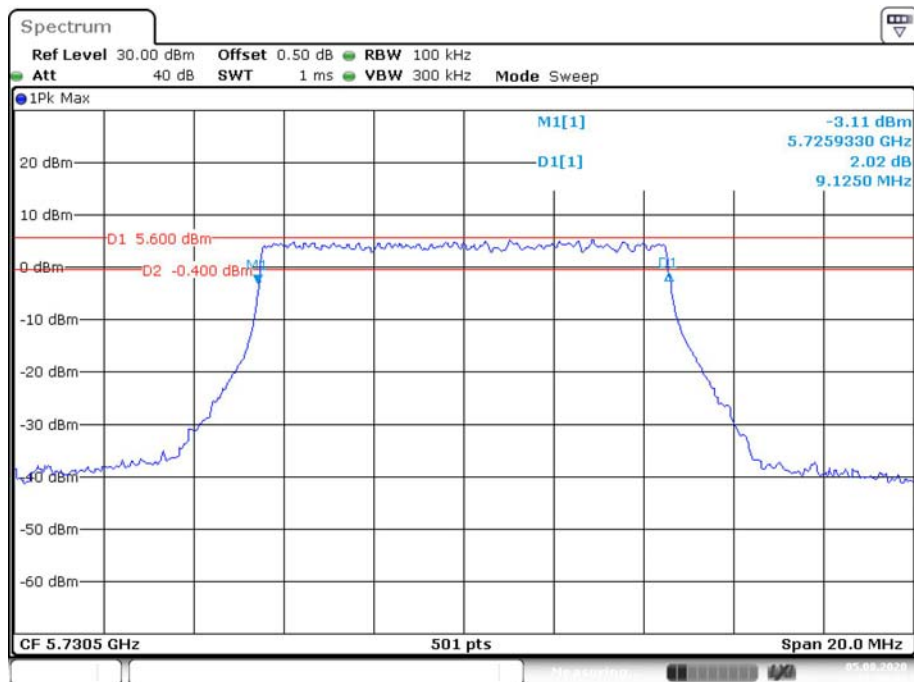

Date: 5.AUG.2020 21:08:05

### 10M Middle Channel

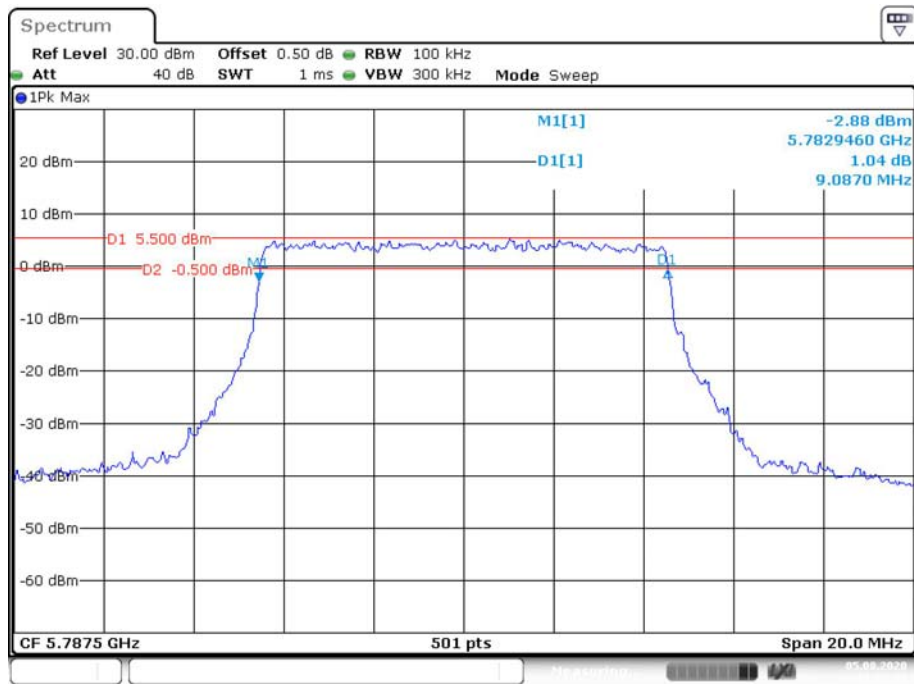

Date: 5.AUG.2020 21:02:36

### 10M High Channel

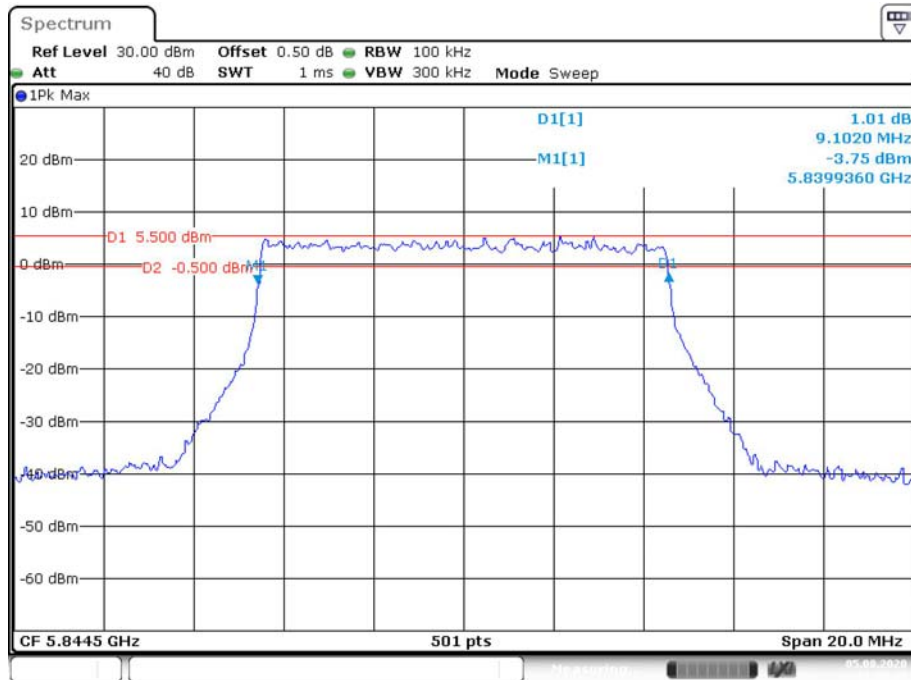

Date: 5.AUG.2020 21:03:50

### 20M Low Channel

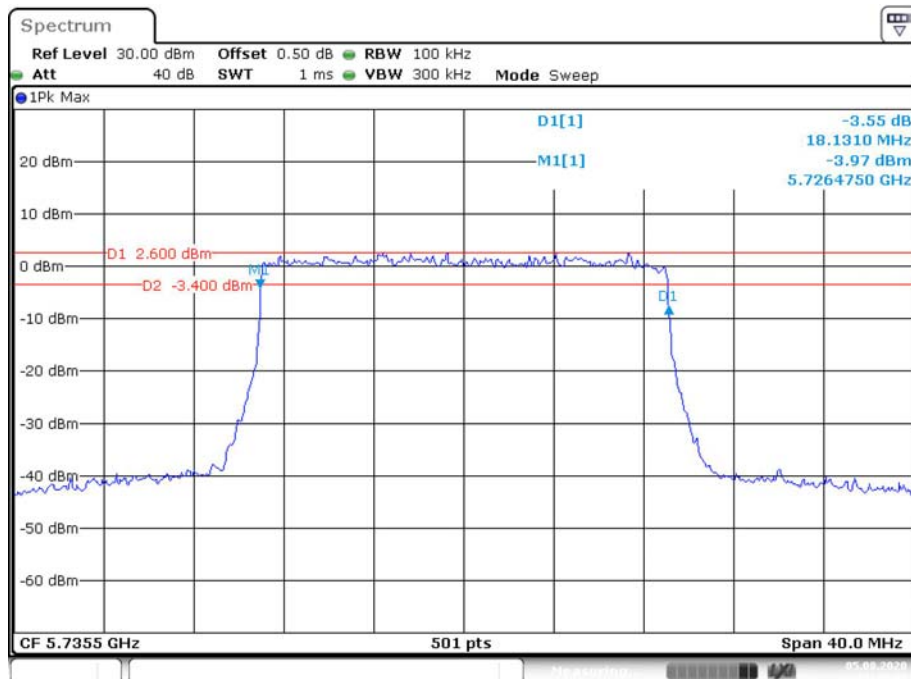

Date: 5.AUG.2020 21:10:09

### 20M Middle Channel

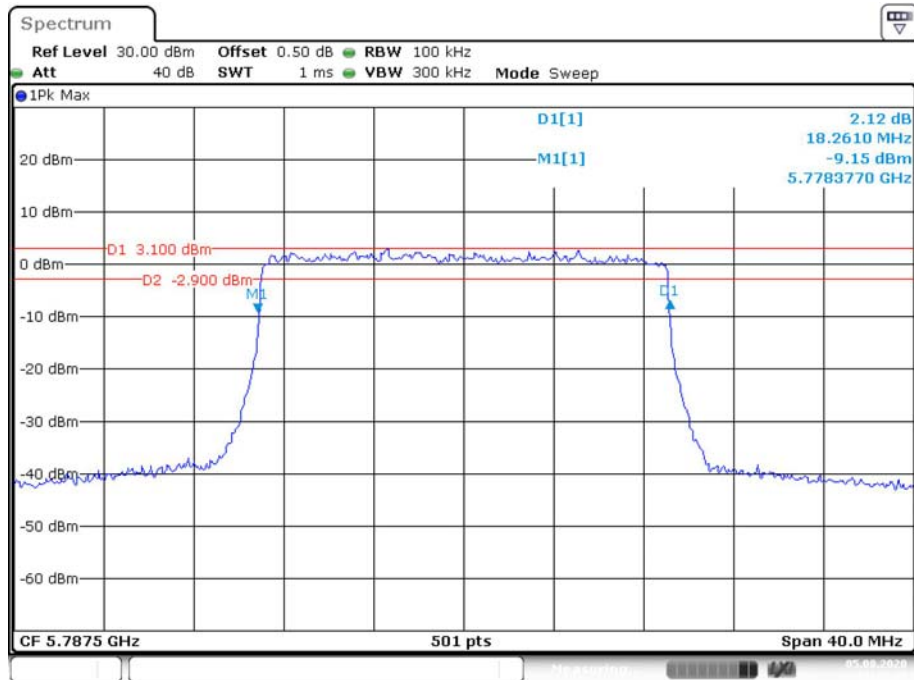

Date: 5.AUG.2020 21:13:19

### 20M High Channel

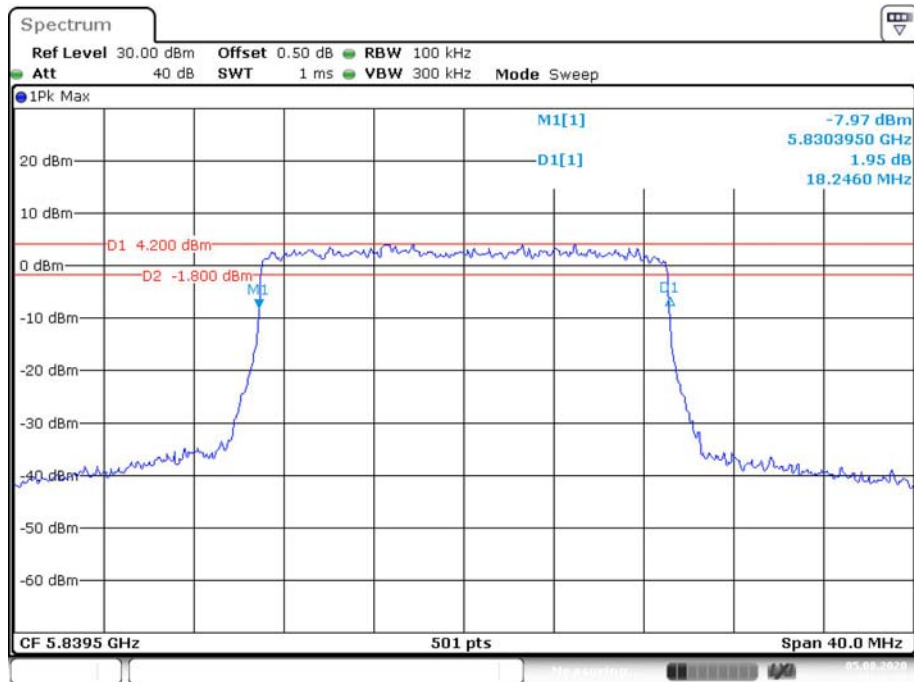

Date: 5.AUG.2020 21:16:50

Occupied Bandwidth:

1.4M Low Channel

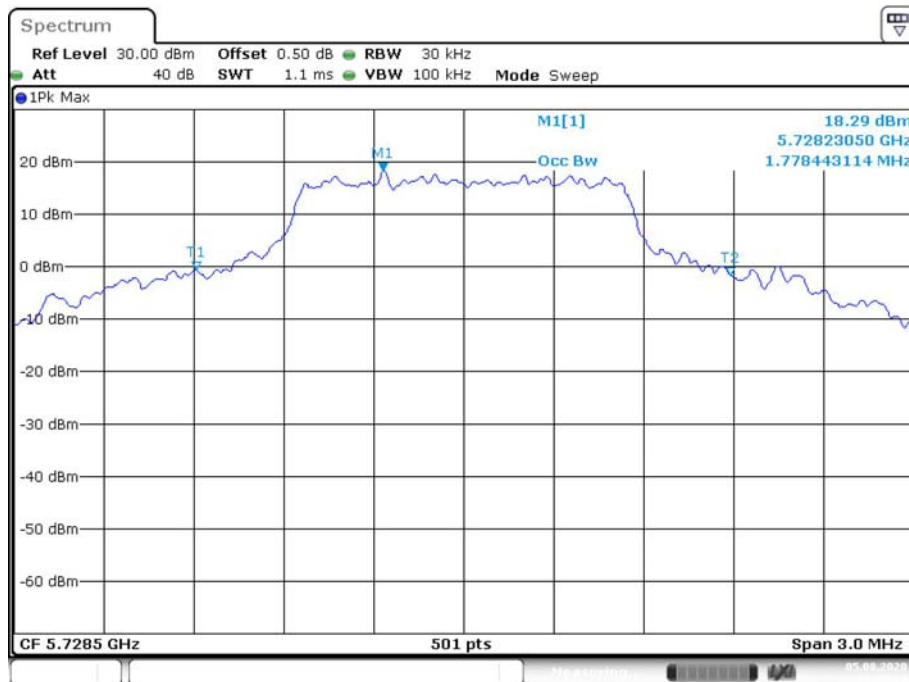

Date: 5.AUG.2020 21:25:14

1.4M Middle Channel

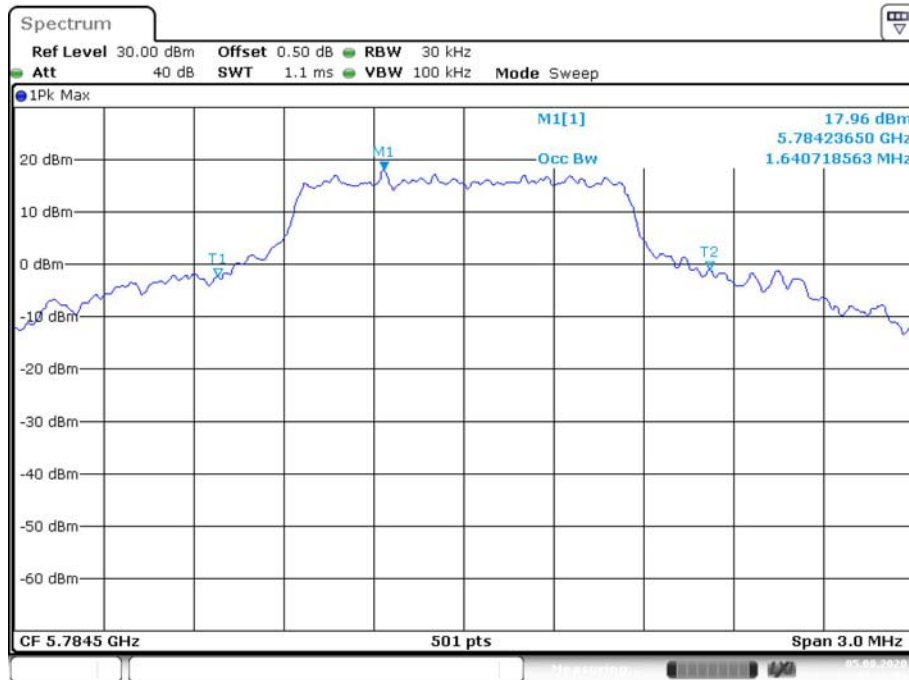

Date: 5.AUG.2020 21:26:04



### 1.4M High Channel



Date: 5.AUG.2020 21:26:55

### 1.4M-CA Low Channel

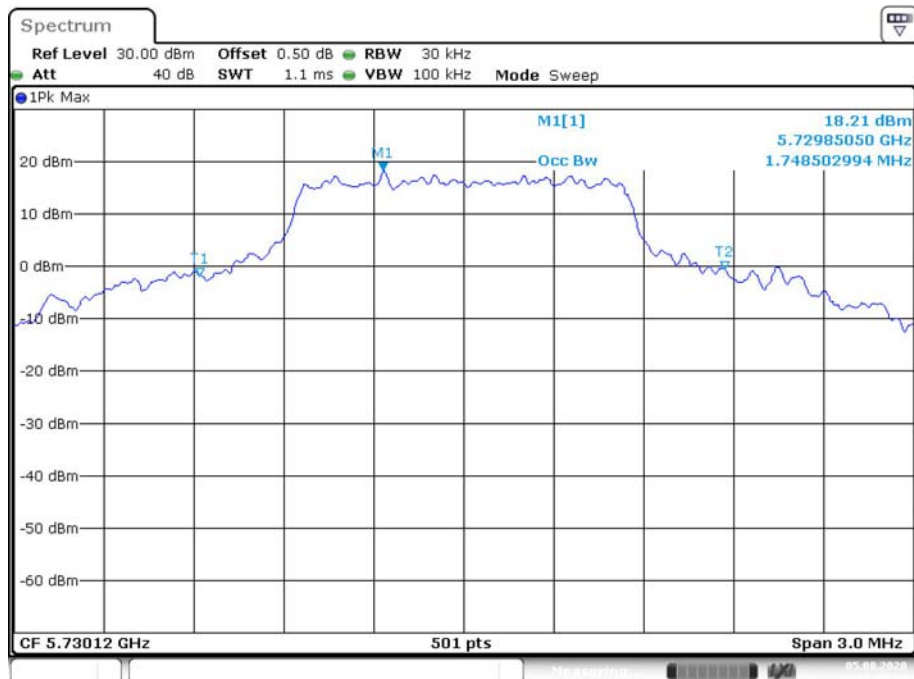

Date: 5.AUG.2020 21:27:53

### 1.4M-CA Middle Channel

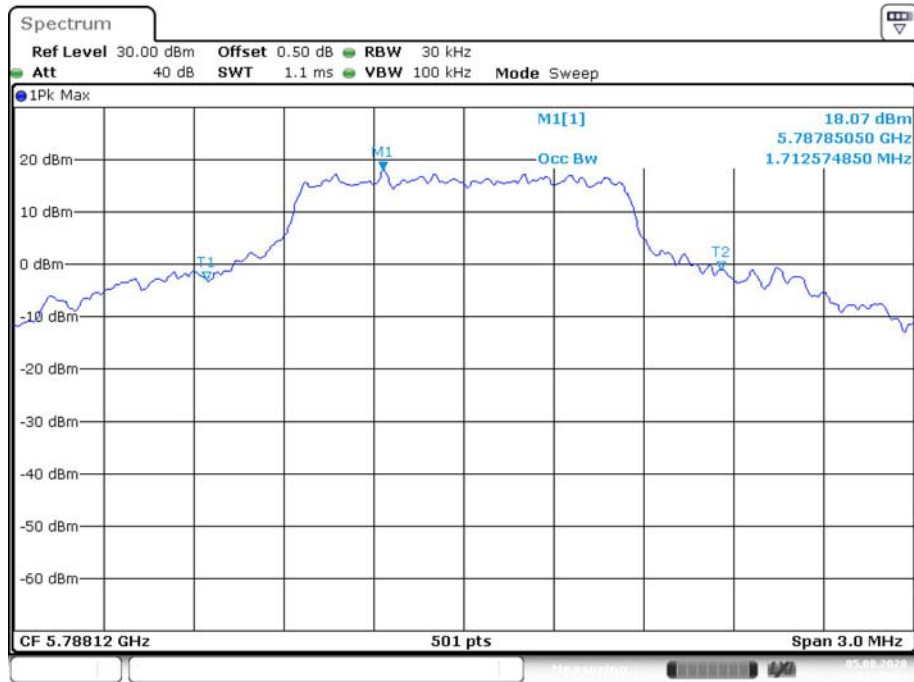

Date: 5.AUG.2020 21:29:04

### 1.4M-CA High Channel

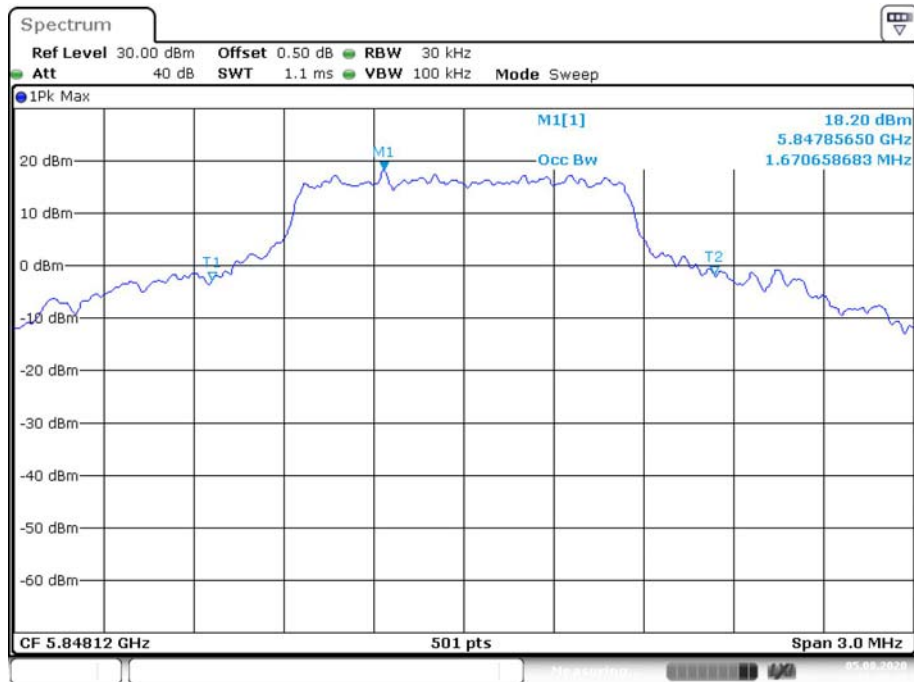

Date: 5.AUG.2020 21:29:45

### 10M Low Channel



Date: 5.AUG.2020 21:33:37

### 10M Middle Channel

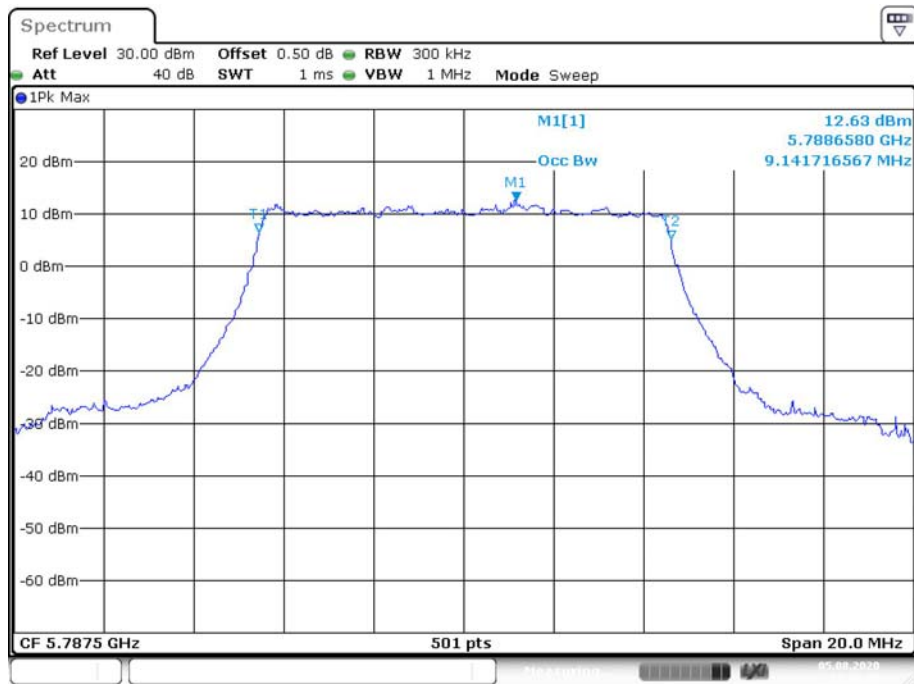

Date: 5.AUG.2020 21:34:26

### 10M High Channel

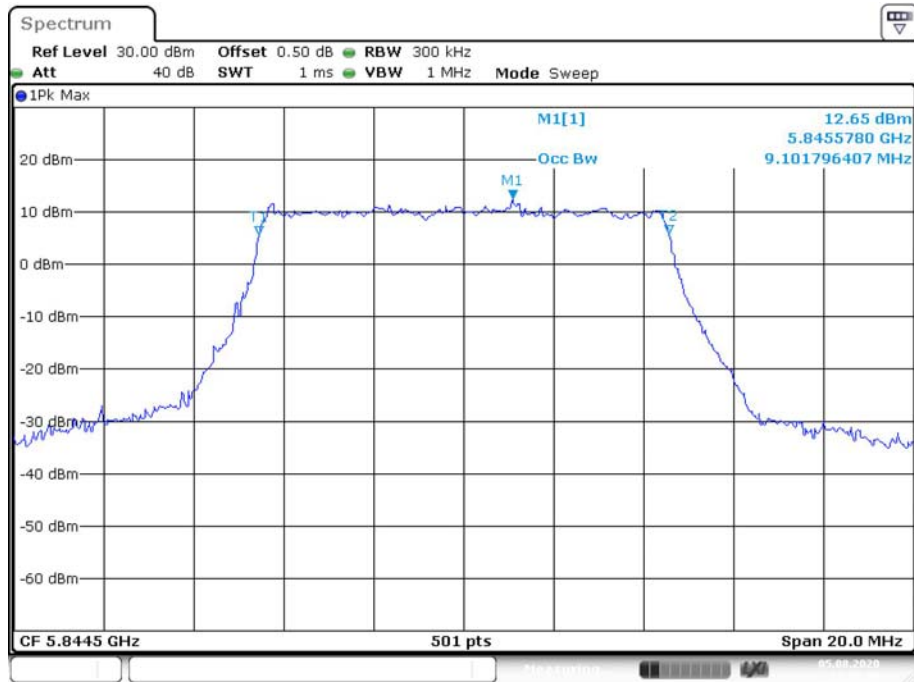

Date: 5.AUG.2020 21:35:08

### 20M Low Channel

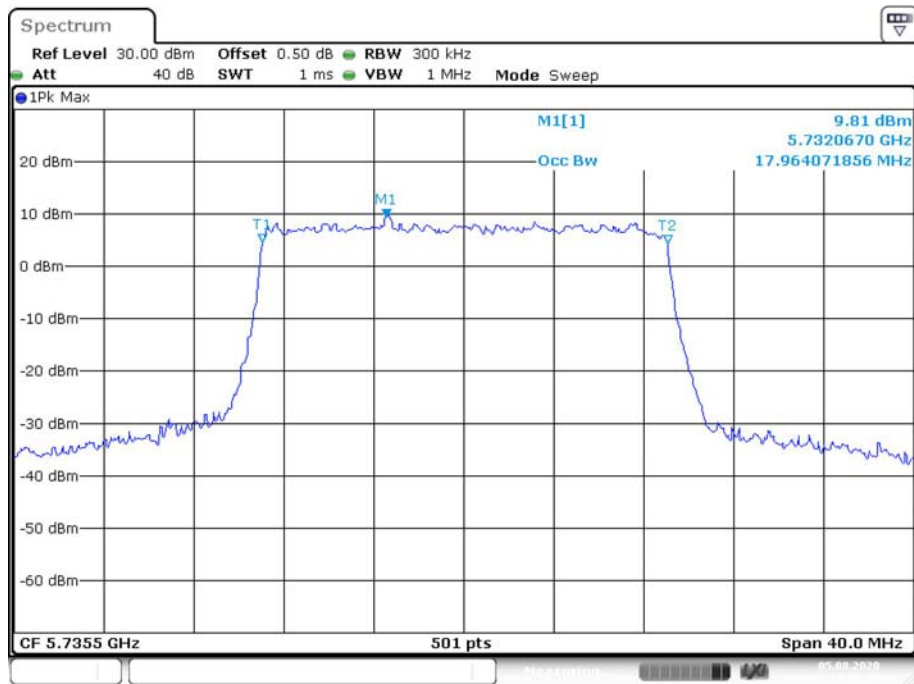

Date: 5.AUG.2020 21:36:07

### 20M Middle Channel

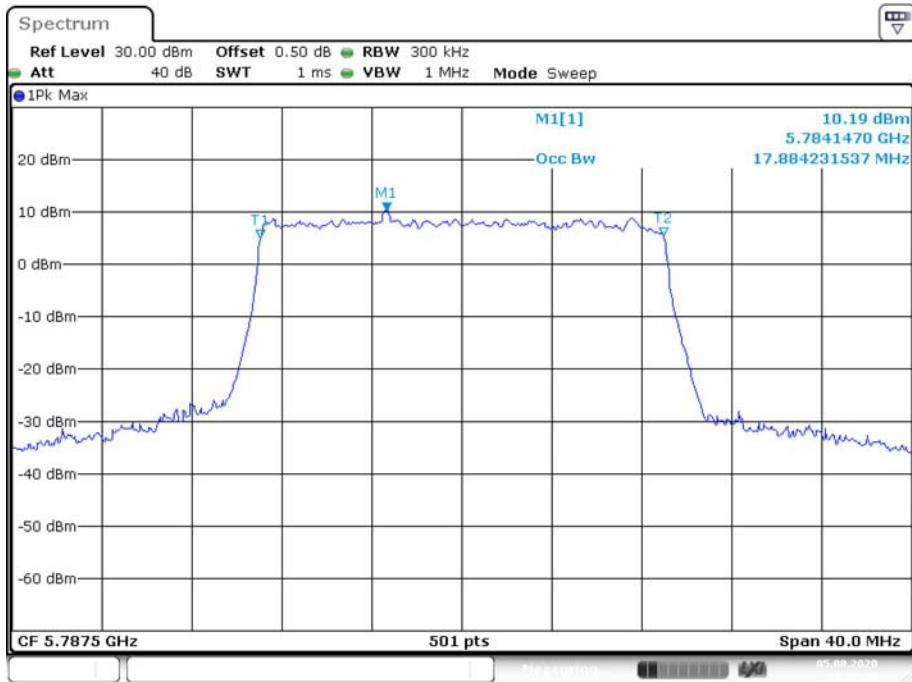

### 20M High Channel

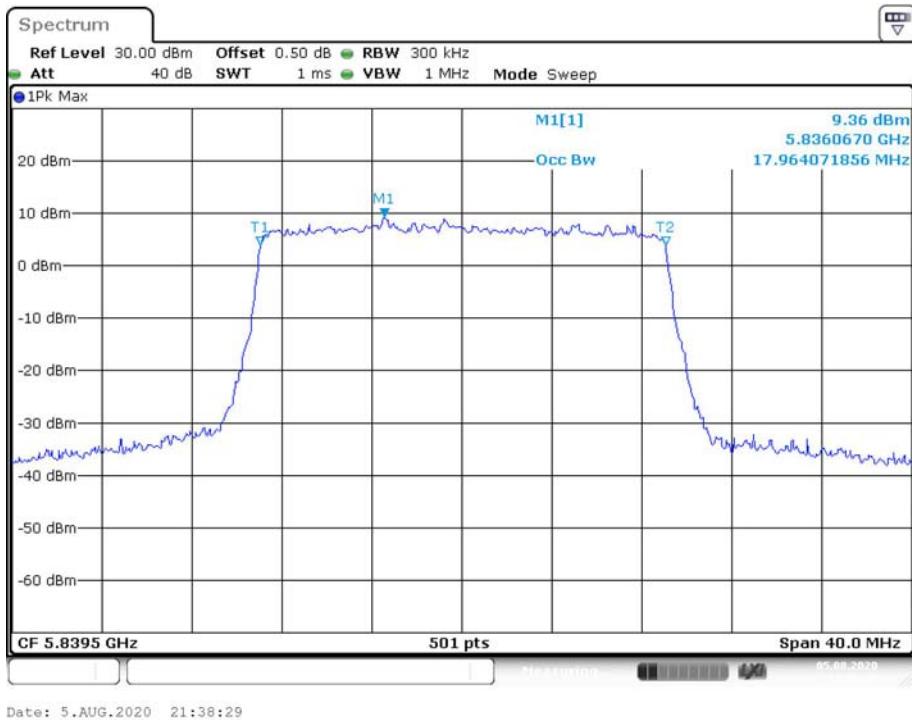

## **FCC §15.407(a) & RSS-247 CLAUSE 6.2 –MAXIMUM CONDUCTED OUTPUT POWER**

---

### **Applicable Standard**

According to FCC §15.407(a)

(a) Power limits:

(1) For the band 5.15-5.25 GHz.

(i) For an outdoor access point operating in the band 5.15-5.25 GHz, the maximum conducted output power over the frequency band of operation shall not exceed 1 W provided the maximum antenna gain does not exceed 6 dBi. In addition, the maximum power spectral density shall not exceed 17 dBm in any 1 megahertz band. If transmitting antennas of directional gain greater than 6 dBi are used, both the maximum conducted output power and the maximum power spectral density shall be reduced by the amount in dB that the directional gain of the antenna exceeds 6 dBi. The maximum e.i.r.p. at any elevation angle above 30 degrees as measured from the horizon must not exceed 125 mW (21 dBm).

(ii) For an indoor access point operating in the band 5.15-5.25 GHz, the maximum conducted output power over the frequency band of operation shall not exceed 1 W provided the maximum antenna gain does not exceed 6 dBi. In addition, the maximum power spectral density shall not exceed 17 dBm in any 1 megahertz band. If transmitting antennas of directional gain greater than 6 dBi are used, both the maximum conducted output power and the maximum power spectral density shall be reduced by the amount in dB that the directional gain of the antenna exceeds 6 dBi.

(iii) For fixed point-to-point access points operating in the band 5.15-5.25 GHz, the maximum conducted output power over the frequency band of operation shall not exceed 1 W. Fixed point-to-point U-NII devices may employ antennas with directional gain up to 23 dBi without any corresponding reduction in the maximum conducted output power or maximum power spectral density. For fixed point-to-point transmitters that employ a directional antenna gain greater than 23 dBi, a 1 dB reduction in maximum conducted output power and maximum power spectral density is required for each 1 dB of antenna gain in excess of 23 dBi. Fixed, point-to-point operations exclude the use of point-to-multipoint systems, omnidirectional applications, and multiple collocated transmitters transmitting the same information. The operator of the U-NII device, or if the equipment is professionally installed, the installer, is responsible for ensuring that systems employing high gain directional antennas are used exclusively for fixed, point-to-point operations.

(iv) For mobile and portable client devices in the 5.15-5.25 GHz band, the maximum conducted output power over the frequency band of operation shall not exceed 250 mW provided the maximum antenna gain does not exceed 6 dBi. In addition, the maximum power spectral density shall not exceed 11 dBm in any 1 megahertz band. If transmitting antennas of directional gain greater than 6 dBi are used, both the maximum conducted output power and the maximum power spectral density shall be reduced by the amount in dB that the directional gain of the antenna exceeds 6 dBi.

(2) For the 5.25-5.35 GHz and 5.47-5.725 GHz bands, the maximum conducted output power over the frequency bands of operation shall not exceed the lesser of 250 mW or 11 dBm  $10 \log B$ , where B is the 26 dB emission bandwidth in megahertz. In addition, the maximum power spectral density shall not exceed 11 dBm in any 1 megahertz band. If transmitting antennas of directional gain greater than 6 dBi are used, both the maximum conducted output power and the maximum power spectral density shall be reduced by the amount in dB that the directional gain of the antenna exceeds 6 dBi.

(3) For the band 5.725-5.85 GHz, the maximum conducted output power over the frequency band of operation shall not exceed 1 W. In addition, the maximum power spectral density shall not exceed 30 dBm in any 500-kHz band. If transmitting antennas of directional gain greater than 6 dBi are used, both the maximum conducted output power and the maximum power spectral density shall be reduced by the amount in dB that the directional gain of the antenna exceeds 6 dBi. However, fixed point-to-point U-NII devices operating in this band may employ transmitting antennas with directional gain greater than 6 dBi without any corresponding reduction in transmitter conducted power. Fixed, point-to-point operations exclude the use of point-to-multipoint systems, omnidirectional applications, and multiple collocated transmitters transmitting the same information. The operator of the U-NII device, or if the equipment is professionally installed, the installer, is responsible for ensuring that systems employing high gain directional antennas are used exclusively for fixed, point-to-point operations.

(4) The maximum conducted output power must be measured over any interval of continuous transmission using instrumentation calibrated in terms of an rms-equivalent voltage.

According to RSS-247 Clause 6.2:

### **Frequency band 5150-5250 MHz**

#### **6.2.1.1 Power limits**

For OEM devices installed in vehicles, the maximum e.i.r.p. shall not exceed 30 mW or  $1.76 + 10 \log_{10}B$ , dBm, whichever is less stringent. Devices shall implement transmitter power control (TPC) in order to have the capability to operate at least 3 dB below the maximum permitted e.i.r.p. of 30 mW.

For other devices, the maximum e.i.r.p. shall not exceed 200 mW or  $10 + 10 \log_{10}B$ , dBm, whichever power is less. B is the 99% emission bandwidth in megahertz. The e.i.r.p. spectral density shall not exceed 10 dBm in any 1.0 MHz band.

### **Frequency band 5250-5350 MHz**

#### **6.2.2.1 Power limits**

For OEM devices installed in vehicles, the maximum e.i.r.p. shall not exceed 30 mW or  $1.76 + 10 \log_{10}B$ , dBm, whichever is less. Devices shall implement TPC in order to have the capability to operate at least 3 dB below the maximum permitted e.i.r.p. of 30 mW.

Devices, other than devices installed in vehicles, shall comply with the following:

- a) The maximum conducted output power shall not exceed 250 mW or  $11 + 10 \log_{10}B$ , dBm, whichever is less. The power spectral density shall not exceed 11 dBm in any 1.0 MHz band;
- b) The maximum e.i.r.p. shall not exceed 1.0 W or  $17 + 10 \log_{10}B$ , dBm, whichever is less. B is the 99% emission bandwidth in megahertz. Note that devices with a maximum e.i.r.p. greater than 500 mW shall implement TPC in order to have the capability to operate at least 6 dB below the maximum permitted e.i.r.p. of 1 W.

## Frequency bands 5470-5600 MHz and 5650-5725 MHz

### 6.2.3.1 Power limits

The maximum conducted output power shall not exceed 250 mW or  $11 + 10 \log_{10}B$ , dBm, whichever is less. The power spectral density shall not exceed 11 dBm in any 1.0 MHz band.

The maximum e.i.r.p. shall not exceed 1.0 W or  $17 + 10 \log_{10}B$ , dBm, whichever is less. B is the 99% emission bandwidth in megahertz. Note that devices with a maximum e.i.r.p. greater than 500 mW shall implement TPC in order to have the capability to operate at least 6 dB below the maximum permitted e.i.r.p. of 1 W.

## Frequency band 5725-5850 MHz

### 6.2.4.1 Power limits

For equipment operating in the band 5725-5850 MHz, the minimum 6 dB bandwidth shall be at least 500 kHz.

The maximum conducted output power shall not exceed 1 W. The output power spectral density shall not exceed 30 dBm in any 500 kHz band. If transmitting antennas of directional gain greater than 6 dBi are used, both the maximum conducted output power and the output power spectral density shall be reduced by the amount in dB that the directional gain of the antenna exceeds 6 dBi. However, fixed point-to-point devices operating in this band may employ transmitting antennas with directional gain greater than 6 dBi without any corresponding reduction in transmitter conducted power. Fixed point-to-point operations exclude the use of point-to-multipoint<sup>3</sup> systems, omnidirectional applications and multiple collocated transmitters transmitting the same information.

## Test Equipment List and Details

Manufacturer	Description	Model	Serial Number	Calibration Date	Calibration Due Date
yzjingcheng	Coaxial Cable	KTRFBU-141-50	41005012	Each time	N/A
E-Microwave	Coaxial Attenuators	EMCA10-5RN-6	OE01203239	Each time	N/A
Agilent	USB Wideband Power Sensor	U2021XA	MY5425009	2020-05-09	2021-05-09

\* **Statement of Traceability:** Bay Area Compliance Laboratories Corp. (Dongguan) attests that all calibrations have been performed, traceable to National Primary Standards and International System of Units (SI).

## Test Procedure

According to KDB 789033 D02 General UNII Test Procedures New Rules v02r01



**Test Data**

**Environmental Conditions**

<b>Temperature:</b>	25.4 °C
<b>Relative Humidity:</b>	72 %
<b>ATM Pressure:</b>	100.7 kPa
<b>Tester:</b>	Severn Zhu
<b>Test Date:</b>	2020-08-05

Test Mode: Transmitting

**1TX Mode:**

Mode	Frequency (MHz)	Conducted Average Output Power (dBm)		Limit (dBm)
		Chain 0	Chain 1	
1.4M	5728.5	26.74	26.75	30
	5784.5	26.41	26.18	30
	5846.5	26.01	26.26	30
1.4M-CA	5730.12	26.83	26.37	30
	5788.12	26.23	26.16	30
	5848.12	26.12	26.13	30
10M	5730.5	16.96	<b>16.28</b>	30
	5787.5	16.74	16.15	30
	5844.5	16.95	16.02	30
20M	5735.5	16.87	16.81	30
	5787.5	16.51	<b>16.85</b>	30
	5839.5	16.71	16.39	30

**2TX mode:**

Mode	Frequency (MHz)	Conducted Average Output Power (dBm)			Limit
		Chain0	Chain1	Total	
1.4M	5728.5	25.75	25.12	<b>28.46</b>	30
	5784.5	25.71	24.91	28.34	30
	5846.5	25.28	25.17	28.24	30
1.4M-CA	5730.12	26.08	25.03	<b>28.60</b>	30
	5788.12	25.71	24.95	28.36	30
	5848.12	25.15	24.98	28.08	30
10M	5730.5	13.55	12.56	16.09	30
	5787.5	13.34	12.43	15.92	30
	5844.5	13.51	12.61	16.09	30
20M	5735.5	13.95	12.94	16.48	30
	5787.5	13.82	13.12	16.49	30
	5839.5	13.68	12.76	16.25	30

Note: Antenna gain is 3.0dBi. meet the EIRP requirement of RSS-247.

## **FCC §15.407(a)& RSS-247 CLAUSE 6.2- POWER SPECTRAL DENSITY**

### **Applicable Standard**

According to FCC §15.407(a)

(a) Power limits:

(1) For the band 5.15-5.25 GHz.

(i) For an outdoor access point operating in the band 5.15-5.25 GHz, the maximum conducted output power over the frequency band of operation shall not exceed 1 W provided the maximum antenna gain does not exceed 6 dBi. In addition, the maximum power spectral density shall not exceed 17 dBm in any 1 megahertz band. If transmitting antennas of directional gain greater than 6 dBi are used, both the maximum conducted output power and the maximum power spectral density shall be reduced by the amount in dB that the directional gain of the antenna exceeds 6 dBi. The maximum e.i.r.p. at any elevation angle above 30 degrees as measured from the horizon must not exceed 125 mW (21 dBm).

(ii) For an indoor access point operating in the band 5.15-5.25 GHz, the maximum conducted output power over the frequency band of operation shall not exceed 1 W provided the maximum antenna gain does not exceed 6 dBi. In addition, the maximum power spectral density shall not exceed 17 dBm in any 1 megahertz band. If transmitting antennas of directional gain greater than 6 dBi are used, both the maximum conducted output power and the maximum power spectral density shall be reduced by the amount in dB that the directional gain of the antenna exceeds 6 dBi.

(iii) For fixed point-to-point access points operating in the band 5.15-5.25 GHz, the maximum conducted output power over the frequency band of operation shall not exceed 1 W. Fixed point-to-point U-NII devices may employ antennas with directional gain up to 23 dBi without any corresponding reduction in the maximum conducted output power or maximum power spectral density. For fixed point-to-point transmitters that employ a directional antenna gain greater than 23 dBi, a 1 dB reduction in maximum conducted output power and maximum power spectral density is required for each 1 dB of antenna gain in excess of 23 dBi. Fixed, point-to-point operations exclude the use of point-to-multipoint systems, omnidirectional applications, and multiple collocated transmitters transmitting the same information. The operator of the U-NII device, or if the equipment is professionally installed, the installer, is responsible for ensuring that systems employing high gain directional antennas are used exclusively for fixed, point-to-point operations.

(iv) For mobile and portable client devices in the 5.15-5.25 GHz band, the maximum conducted output power over the frequency band of operation shall not exceed 250 mW provided the maximum antenna gain does not exceed 6 dBi. In addition, the maximum power spectral density shall not exceed 11 dBm in any 1 megahertz band. If transmitting antennas of directional gain greater than 6 dBi are used, both the maximum conducted output power and the maximum power spectral density shall be reduced by the amount in dB that the directional gain of the antenna exceeds 6 dBi.

(2) For the 5.25-5.35 GHz and 5.47-5.725 GHz bands, the maximum conducted output power over the frequency bands of operation shall not exceed the lesser of 250 mW or  $11 \text{ dBm} + 10 \log B$ , where B is the 26 dB emission bandwidth in megahertz. In addition, the maximum power spectral density shall not exceed 11 dBm in any 1 megahertz band. If transmitting antennas of directional gain greater than 6 dBi are used, both the maximum conducted output

power and the maximum power spectral density shall be reduced by the amount in dB that the directional gain of the antenna exceeds 6 dBi.

(3) For the band 5.725-5.85 GHz, the maximum conducted output power over the frequency band of operation shall not exceed 1 W. In addition, the maximum power spectral density shall not exceed 30 dBm in any 500-kHz band. If transmitting antennas of directional gain greater than 6 dBi are used, both the maximum conducted output power and the maximum power spectral density shall be reduced by the amount in dB that the directional gain of the antenna exceeds 6 dBi. However, fixed point-to-point U-NII devices operating in this band may employ transmitting antennas with directional gain greater than 6 dBi without any corresponding reduction in transmitter conducted power. Fixed, point-to-point operations exclude the use of point-to-multipoint systems, omnidirectional applications, and multiple collocated transmitters transmitting the same information. The operator of the U-NII device, or if the equipment is professionally installed, the installer, is responsible for ensuring that systems employing high gain directional antennas are used exclusively for fixed, point-to-point operations.

According to RSS-247 Clause 6.2:

### **Frequency band 5150-5250 MHz**

#### **6.2.1.1 Power limits**

For OEM devices installed in vehicles, the maximum e.i.r.p. shall not exceed 30 mW or  $1.76 + 10 \log_{10}B$ , dBm, whichever is less stringent. Devices shall implement transmitter power control (TPC) in order to have the capability to operate at least 3 dB below the maximum permitted e.i.r.p. of 30 mW.

For other devices, the maximum e.i.r.p. shall not exceed 200 mW or  $10 + 10 \log_{10}B$ , dBm, whichever power is less. B is the 99% emission bandwidth in megahertz. The e.i.r.p. spectral density shall not exceed 10 dBm in any 1.0 MHz band.

### **Frequency band 5250-5350 MHz**

#### **6.2.2.1 Power limits**

For OEM devices installed in vehicles, the maximum e.i.r.p. shall not exceed 30 mW or  $1.76 + 10 \log_{10}B$ , dBm, whichever is less. Devices shall implement TPC in order to have the capability to operate at least 3 dB below the maximum permitted e.i.r.p. of 30 mW.

Devices, other than devices installed in vehicles, shall comply with the following:

- a) The maximum conducted output power shall not exceed 250 mW or  $11 + 10 \log_{10}B$ , dBm, whichever is less. The power spectral density shall not exceed 11 dBm in any 1.0 MHz band;
- b) The maximum e.i.r.p. shall not exceed 1.0 W or  $17 + 10 \log_{10}B$ , dBm, whichever is less. B is the 99% emission bandwidth in megahertz. Note that devices with a maximum e.i.r.p. greater than 500 mW shall implement TPC in order to have the capability to operate at least 6 dB below the maximum permitted e.i.r.p. of 1 W.

## Frequency bands 5470-5600 MHz and 5650-5725 MHz

### 6.2.3.1 Power limits

The maximum conducted output power shall not exceed 250 mW or  $11 + 10 \log_{10}B$ , dBm, whichever is less. The power spectral density shall not exceed 11 dBm in any 1.0 MHz band.

The maximum e.i.r.p. shall not exceed 1.0 W or  $17 + 10 \log_{10}B$ , dBm, whichever is less. B is the 99% emission bandwidth in megahertz. Note that devices with a maximum e.i.r.p. greater than 500 mW shall implement TPC in order to have the capability to operate at least 6 dB below the maximum permitted e.i.r.p. of 1 W.

## Frequency band 5725-5850 MHz

### 6.2.4.1 Power limits

For equipment operating in the band 5725-5850 MHz, the minimum 6 dB bandwidth shall be at least 500 kHz.

The maximum conducted output power shall not exceed 1 W. The output power spectral density shall not exceed 30 dBm in any 500 kHz band. If transmitting antennas of directional gain greater than 6 dBi are used, both the maximum conducted output power and the output power spectral density shall be reduced by the amount in dB that the directional gain of the antenna exceeds 6 dBi. However, fixed point-to-point devices operating in this band may employ transmitting antennas with directional gain greater than 6 dBi without any corresponding reduction in transmitter conducted power. Fixed point-to-point operations exclude the use of point-to-multipoint<sup>3</sup> systems, omnidirectional applications and multiple collocated transmitters transmitting the same information.

## Test Procedure

According to KDB 789033 D02 General UNII Test Procedures New Rules v02r01

## Test Equipment List and Details

Manufacturer	Description	Model	Serial Number	Calibration Date	Calibration Due Date
R&S	Spectrum Analyzer	FSV40	101474	2020-07-07	2021-07-07
yzjingcheng	Coaxial Cable	KTRFBU-141-50	41005012	Each time	N/A
Unknown	Coaxial Cable	C-SJ00-0010	C0010/02	Each time	N/A

\* *Statement of Traceability:* Bay Area Compliance Laboratories Corp. (Dongguan) attests that all calibrations have been performed, traceable to National Primary Standards and International System of Units (SI).

## Test Data

### Environmental Conditions

Temperature:	25.3~27.1 °C
Relative Humidity:	48~72 %
ATM Pressure:	99.8~101.1 kPa
Tester:	Severn Zhu
Test Date:	2020-08-05~2020-10-15

Test Mode: Transmitting

Test Result: Compliance. Please refer to the following table and plot.

**1TX mode:**

Mode	Frequency (MHz)	Reading (dBm/300kHz)		Power Spectral Density (dBm/500kHz)		Limit (dBm/500kHz)
		Chain 0	Chain 1	Chain 0	Chain 1	
1.4M	5728.5	26.43	25.66	28.65	27.88	≤30
	5784.5	26.00	25.63	28.22	27.85	≤30
	5846.5	25.30	26.19	27.52	28.41	≤30
1.4M-CA	5730.12	26.49	25.72	28.71	27.94	≤30
	5788.12	25.94	25.83	28.16	28.05	≤30
	5848.12	25.29	26.16	27.51	28.38	≤30
10M	5730.5	11.38	11.31	13.6	13.53	≤30
	5787.5	10.89	11.28	13.11	13.5	≤30
	5844.5	11.39	11.06	13.61	13.28	≤30
20M	5735.5	8.82	9.46	11.04	11.68	≤30
	5787.5	8.19	9.39	10.41	11.61	≤30
	5839.5	7.99	9.25	10.21	11.47	≤30

**2TX mode:**

Mode	Frequency (MHz)	Power Spectral Density (dBm/500kHz)			Limit (dBm/500kHz)
		Chain 0	Chain 1	Total	
1.4M	5728.5	21.41	20.88	24.16	≤30
	5784.5	20.81	20.32	23.58	≤30
	5846.5	20.84	20.61	23.74	≤30
1.4M-CA	5730.12	21.29	20.66	24.00	≤30
	5788.12	20.94	20.88	23.92	≤30
	5848.12	20.83	20.65	23.75	≤30

Mode	Frequency (MHz)	Reading (dBm/300kHz)		Power Spectral Density (dBm/500kHz)			Limit (dBm/500kHz)
		Chain 0	Chain 1	Chain 0	Chain 1	Total	
10M	5730.5	8.57	7.96	10.79	10.18	13.51	≤30
	5787.5	8.58	8.05	10.8	10.27	13.55	≤30
	5844.5	9.07	7.57	11.29	9.79	13.61	≤30
20M	5735.5	7.54	5.72	9.76	7.94	11.95	≤30
	5787.5	6.86	6.33	9.08	8.55	11.83	≤30
	5839.5	7.28	6.02	9.5	8.24	11.93	≤30

Note:

The maximum antenna gain is 3.0dBi in 5GHz band. The device employed Cyclic Delay Diversity (CDD) for 802.11 MIMO transmitting, per KDB 662911 D01 Multiple Transmitter Output v02r01, for power spectral density (PSD) measurements on the devices:

$$\text{Array Gain} = 10 \log(N_{\text{ANT}}/N_{\text{SS}}) \text{ dB.}$$

So:

$$\text{Directional gain} = G_{\text{ANT}} + \text{Array Gain} = 3.0\text{dBi} + 10 * \log(2/1) = 6.0\text{dBi}$$

For 5.8GHz band, If measurement bandwidth of Maximum PSD is specified in 500 kHz, add 10log(500kHz/RBW) to the measured result, whereas RBW (< 500 KHz) is the reduced resolution bandwidth of the spectrum analyzer set during measurement.

Method SA-3 in KDB 789033 D02 General UNII Test Procedures New Rules v02r01 was used for PSD test.

1TX mode:  
Chain 0:

### 1.4M Low Channel

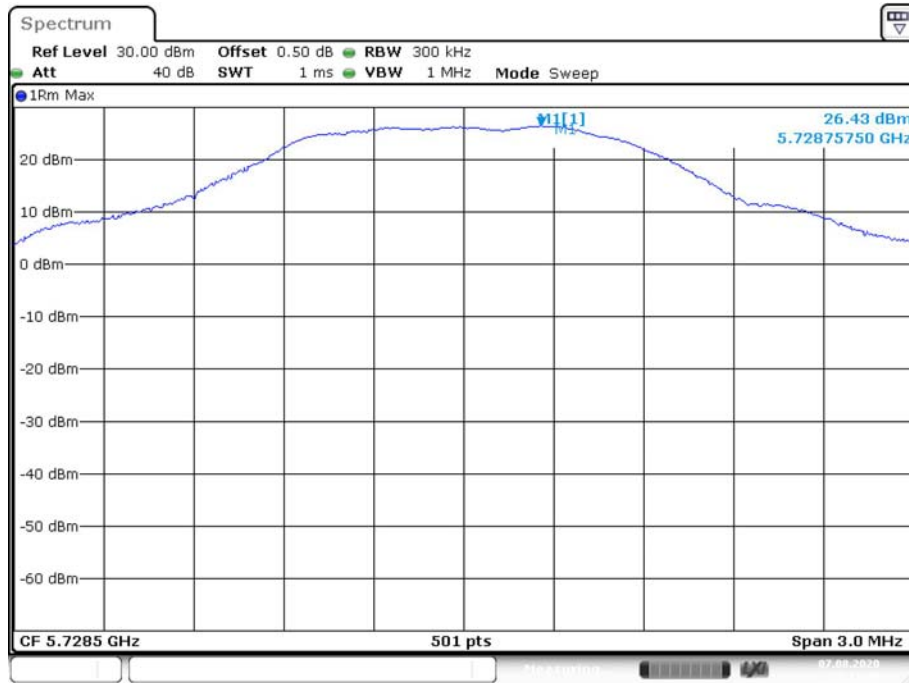

Date: 7.AUG.2020 20:11:20

### 1.4M Middle Channel



Date: 7.AUG.2020 20:12:10

### 1.4M High Channel

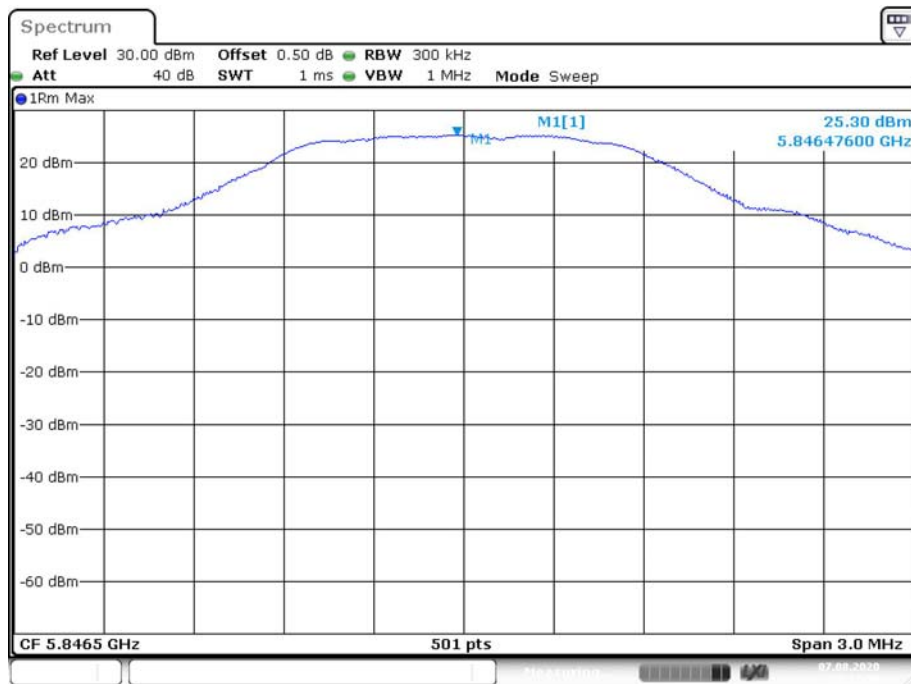

Date: 7.AUG.2020 20:12:50

### 1.4M-CA Low Channel

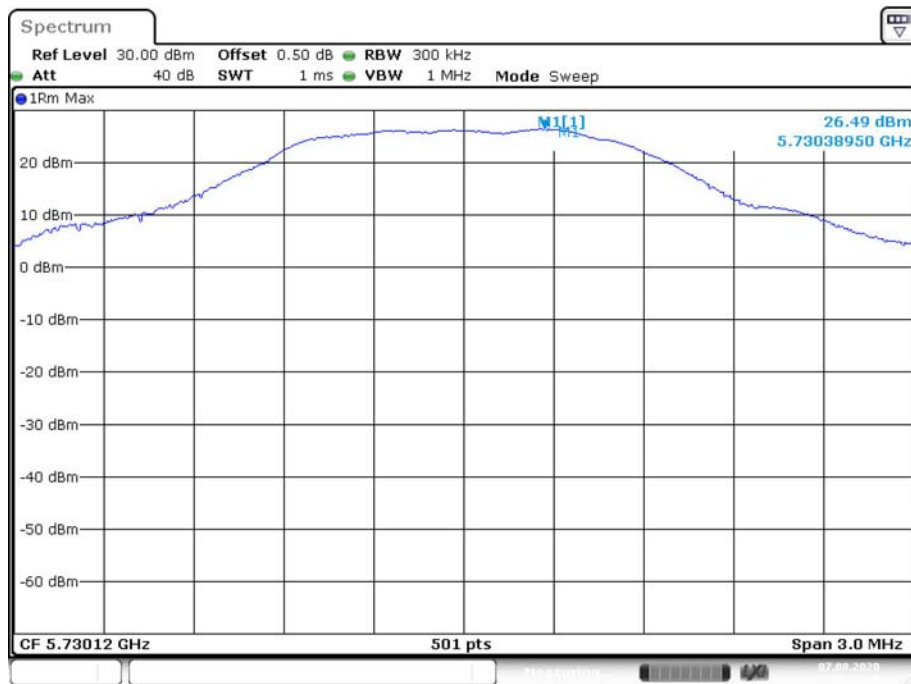

Date: 7.AUG.2020 20:15:16

### 1.4M-CA Middle Channel

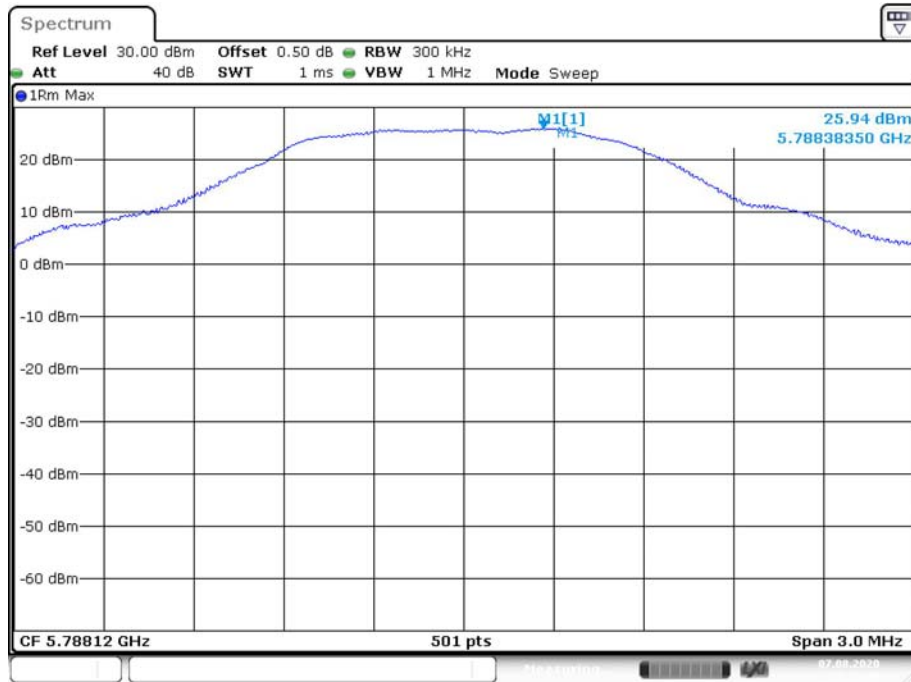

Date: 7.AUG.2020 20:16:20

### 1.4M-CA High Channel

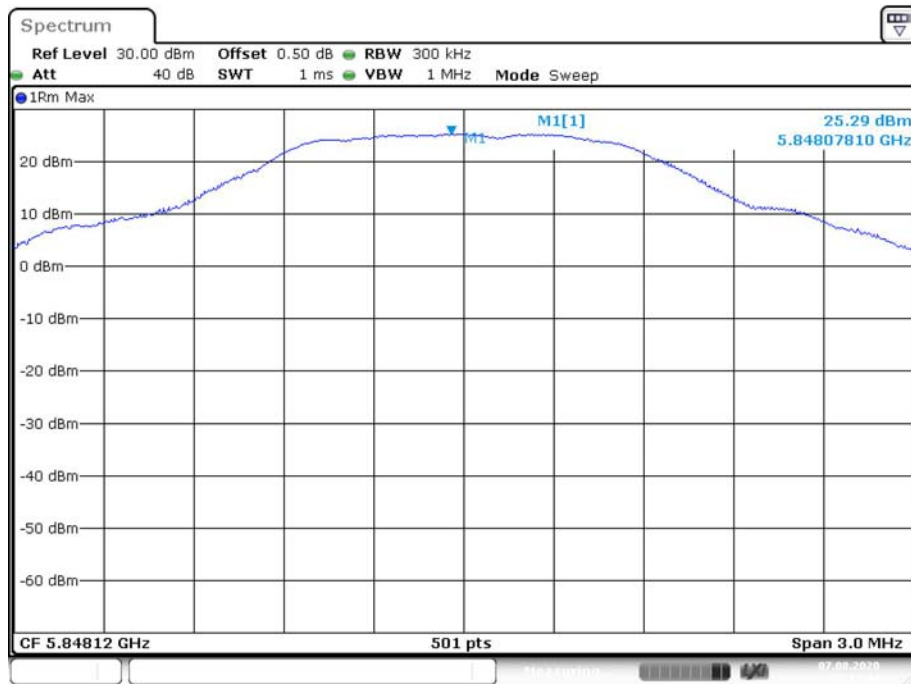

Date: 7.AUG.2020 20:17:44



### 10M Low Channel

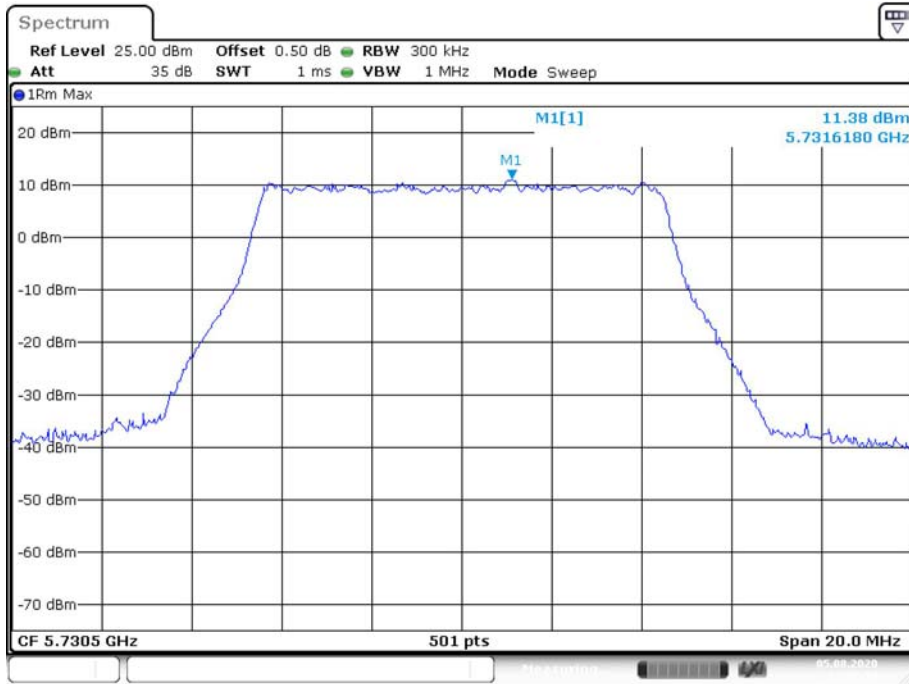

Date: 5.AUG.2020 22:27:25

### 10M Middle Channel

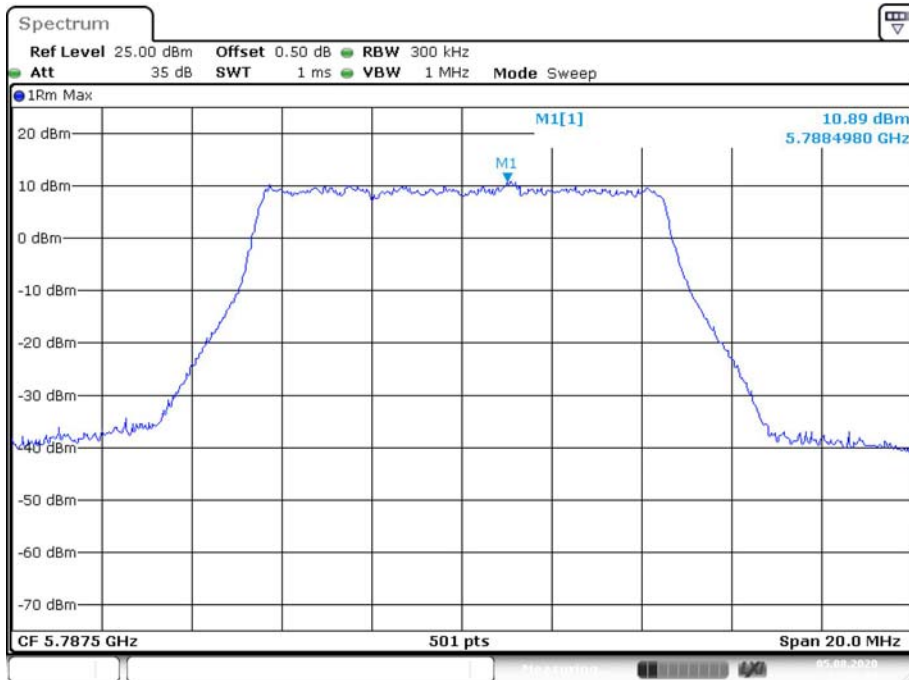

Date: 5.AUG.2020 22:34:24

### 10M High Channel

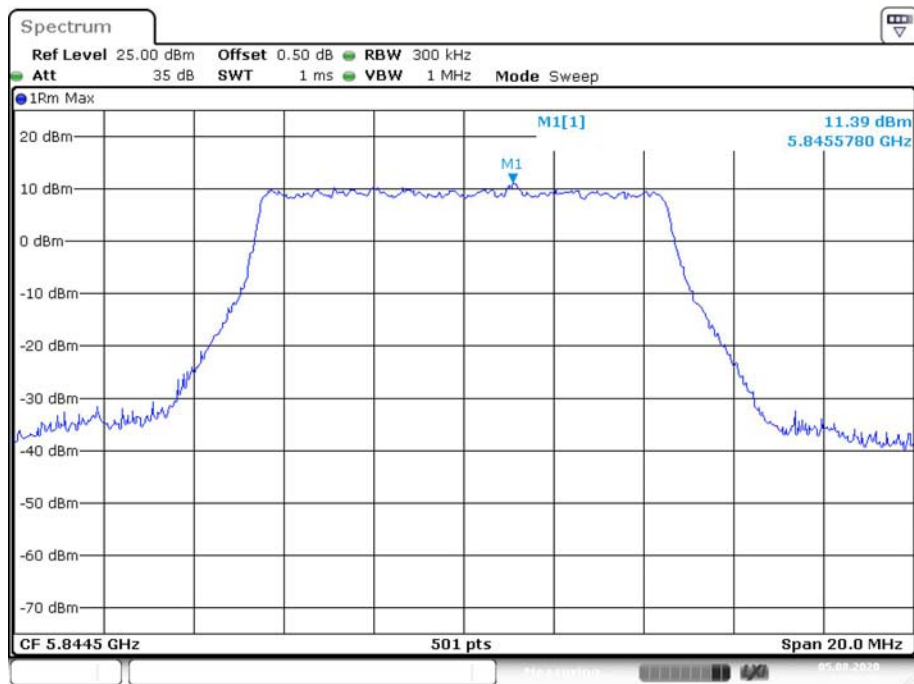

Date: 5.AUG.2020 22:57:26

### 20M Low Channel

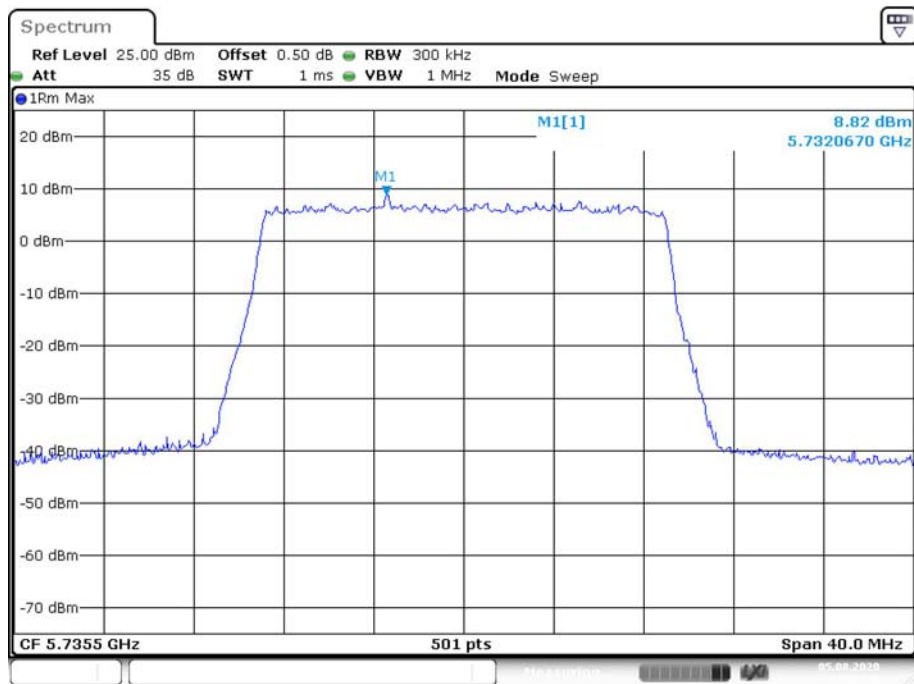

Date: 5.AUG.2020 23:01:31

### 20M Middle Channel

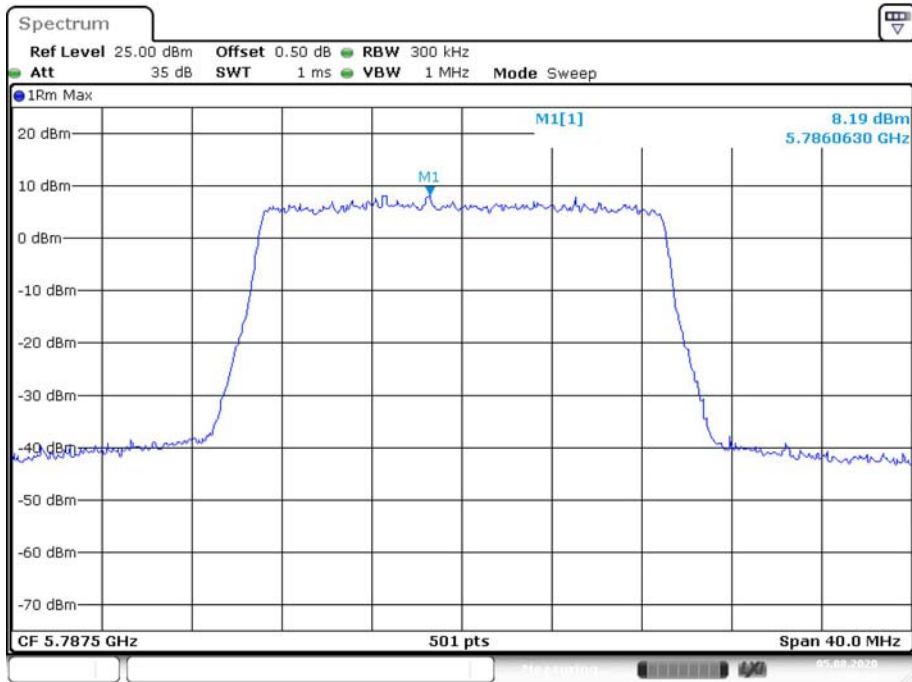

Date: 5.AUG.2020 23:04:54

### 20M High Channel

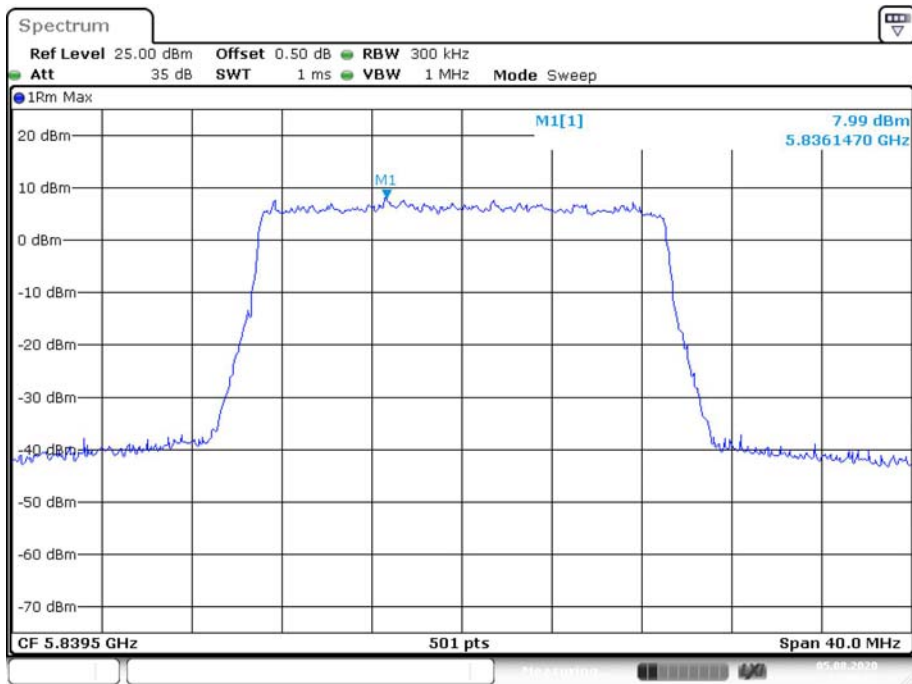

Date: 5.AUG.2020 23:08:03

Chain1:

1.4M Low Channel

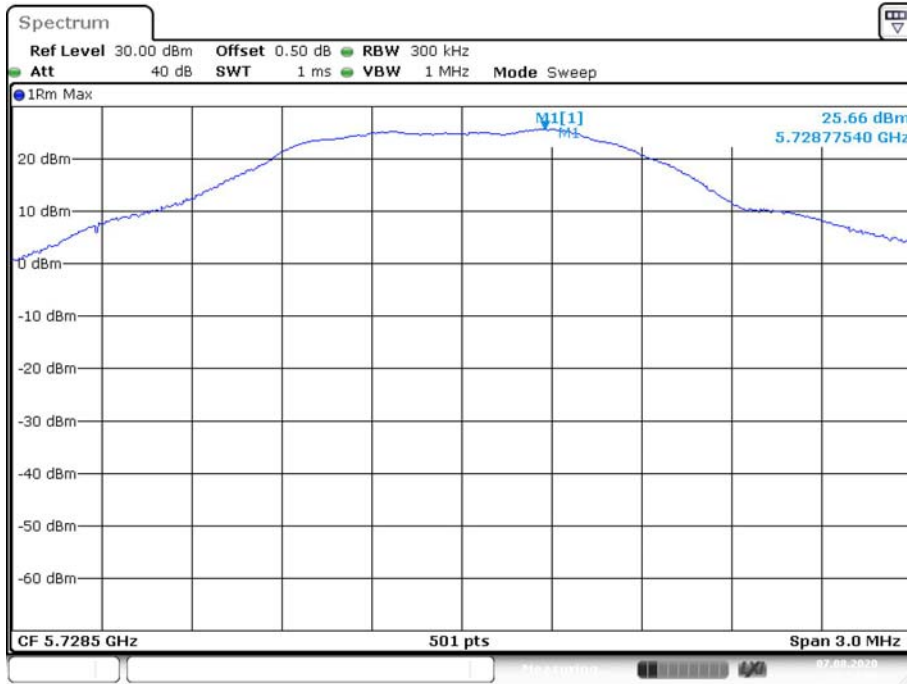

Date: 7.AUG.2020 20:24:00

1.4M Middle Channel

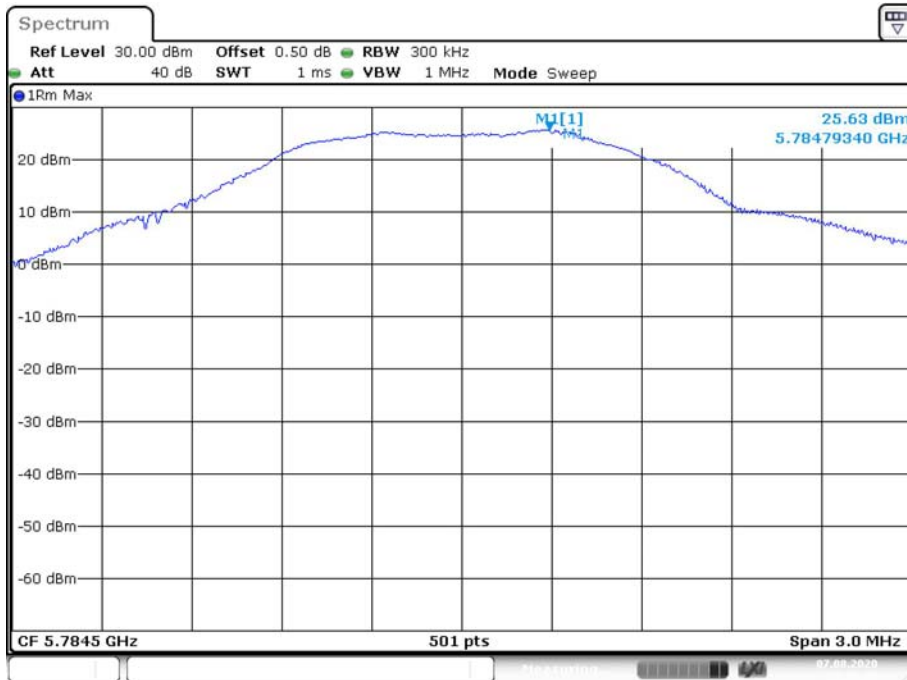

Date: 7.AUG.2020 20:26:03

### 1.4M High Channel

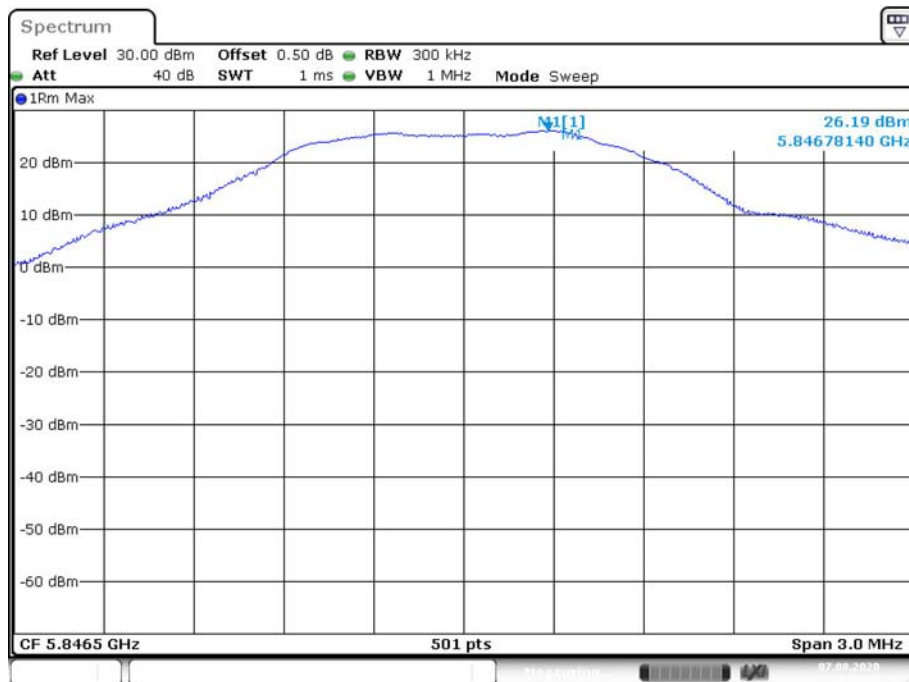

Date: 7.AUG.2020 20:28:43

### 1.4M-CA Low Channel

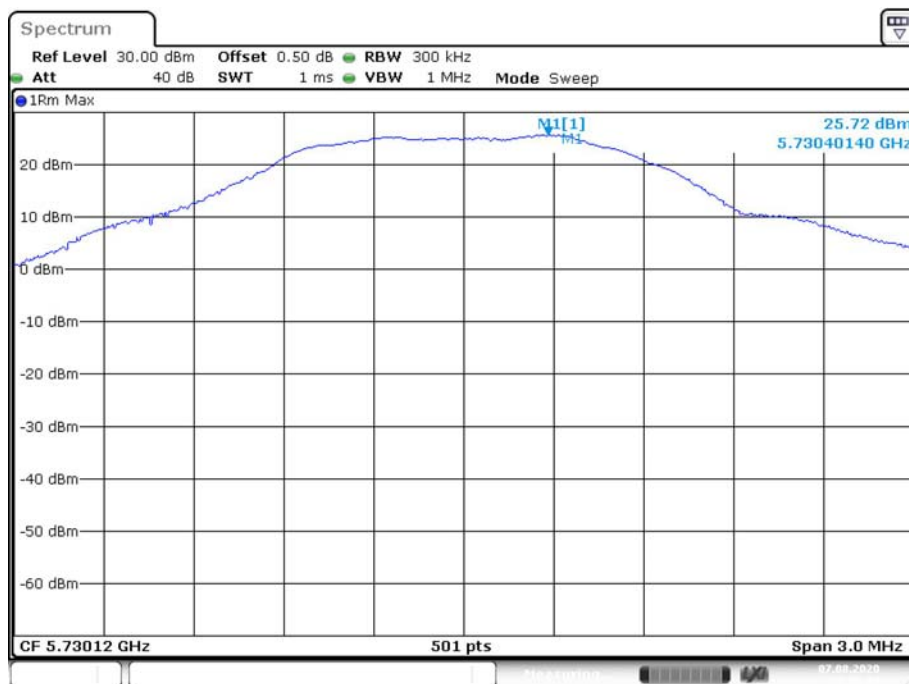

Date: 7.AUG.2020 20:30:24

### 1.4M-CA Middle Channel

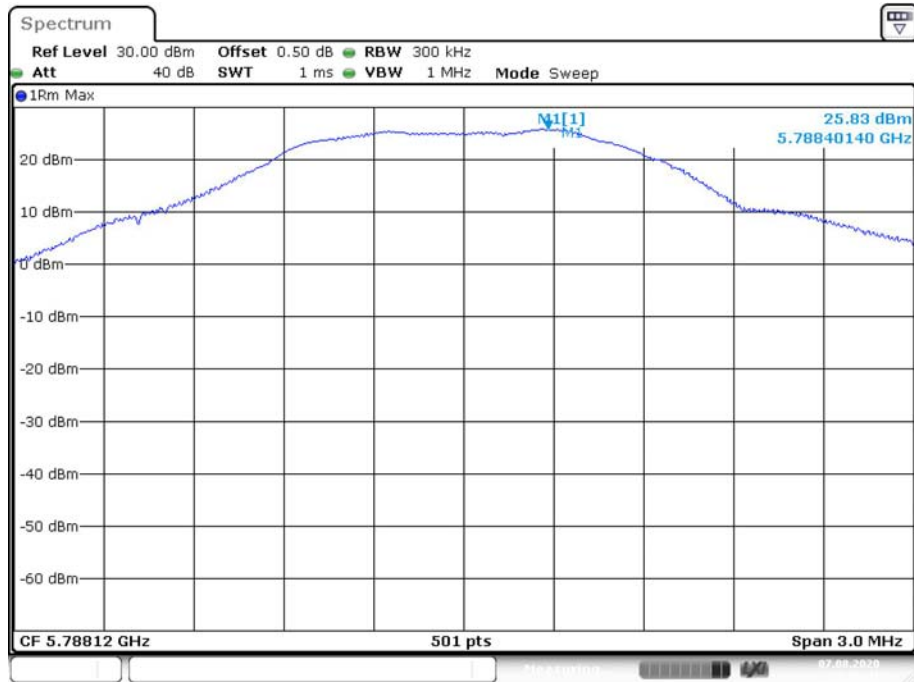

Date: 7.AUG.2020 20:35:41

### 1.4M-CA High Channel

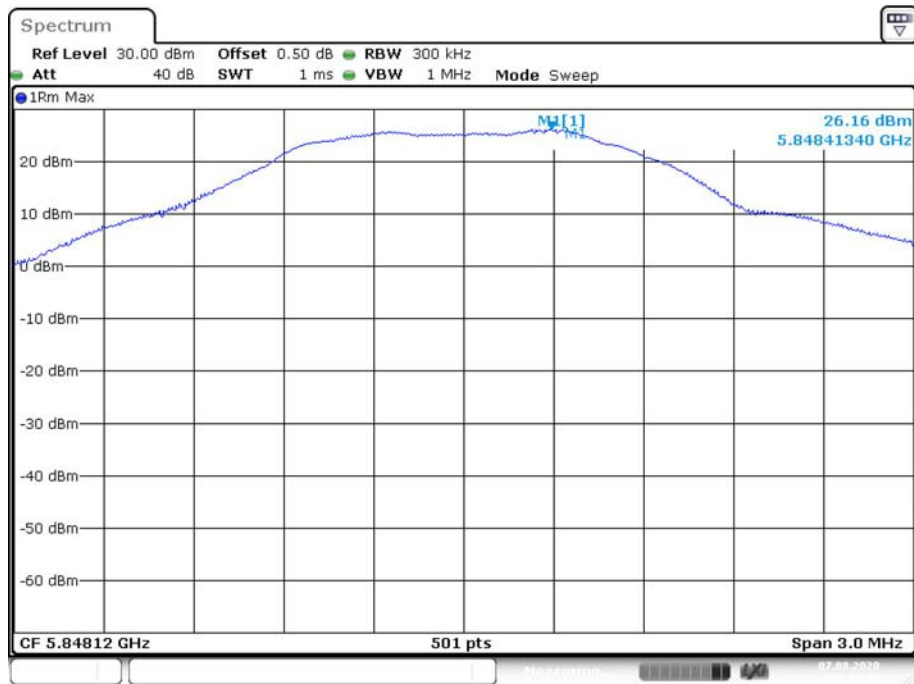

Date: 7.AUG.2020 20:31:24

### 10M Low Channel

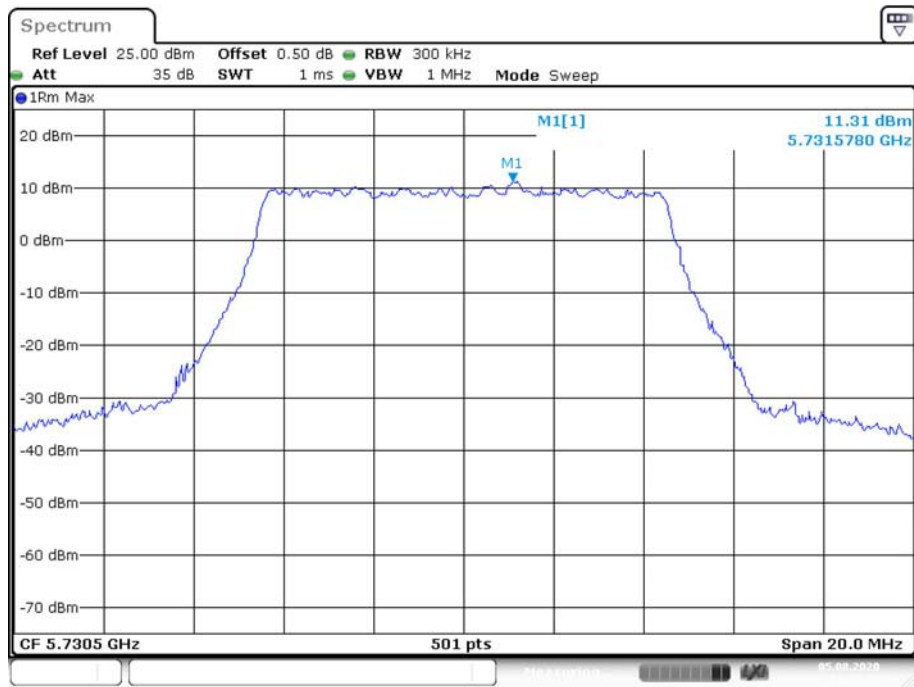

Date: 5.AUG.2020 23:10:21

### 10M Middle Channel

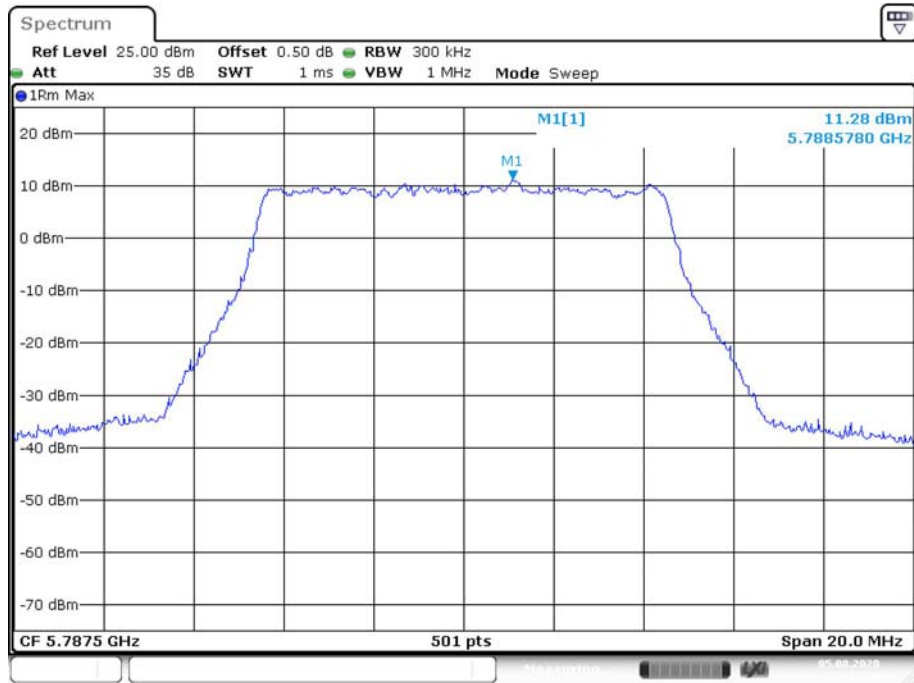

Date: 5.AUG.2020 23:12:38

### 10M High Channel

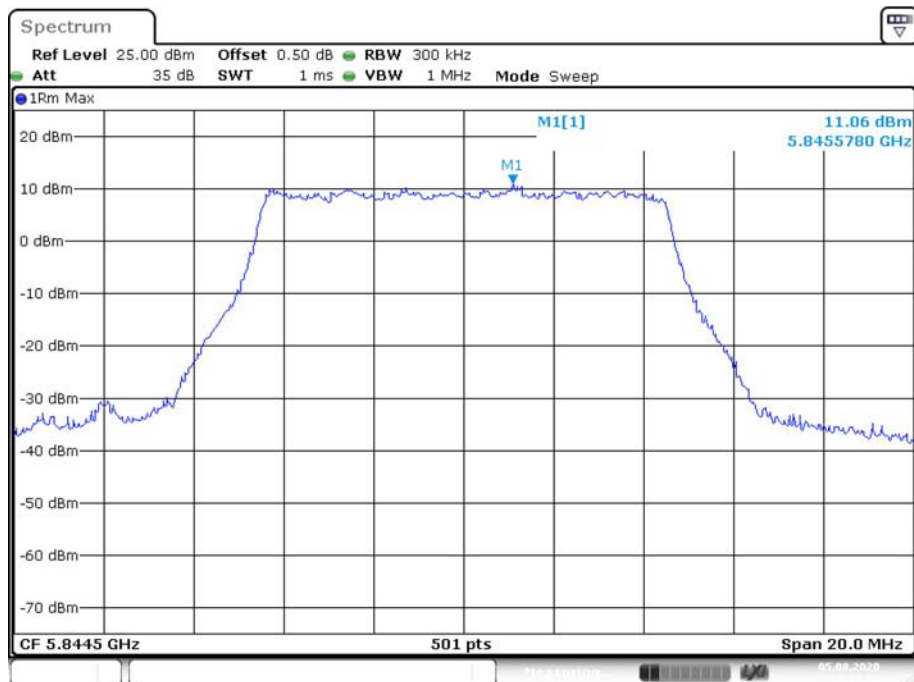

Date: 5.AUG.2020 23:14:54

### 20M Low Channel

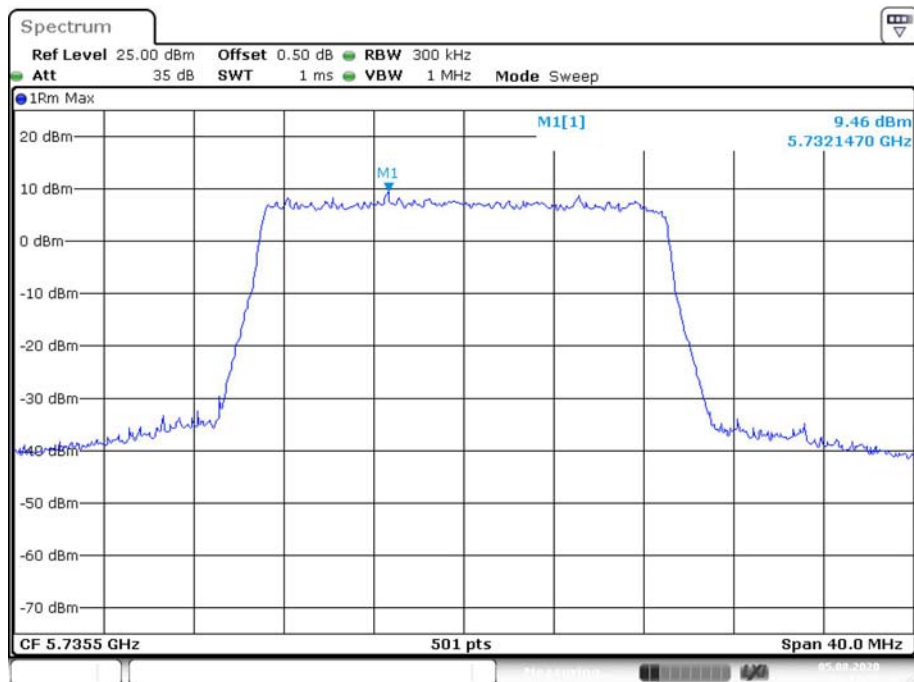

Date: 5.AUG.2020 23:17:23



### 20M Middle Channel

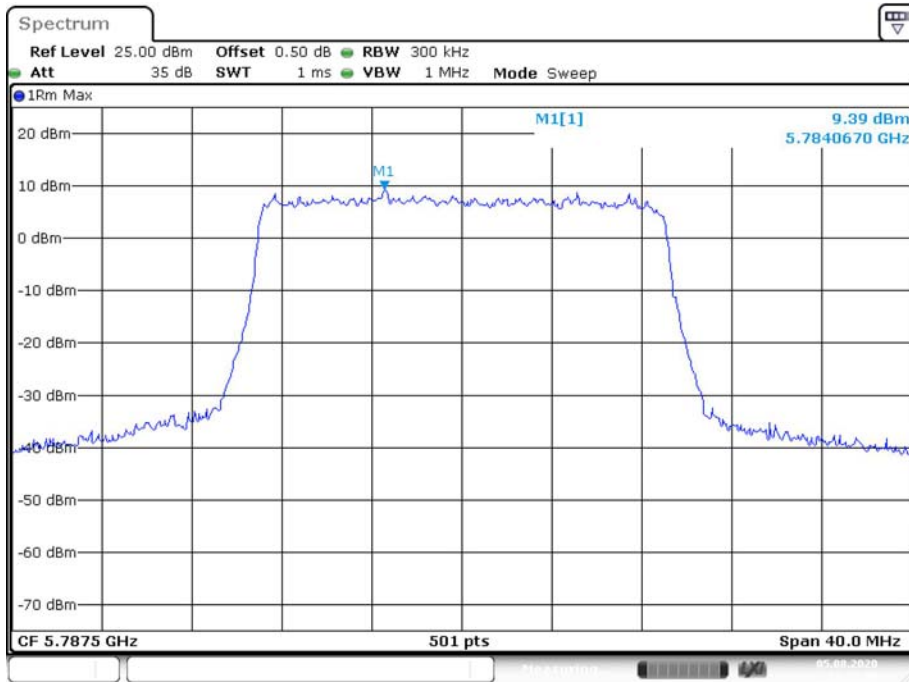

Date: 5.AUG.2020 23:19:38

### 20M High Channel

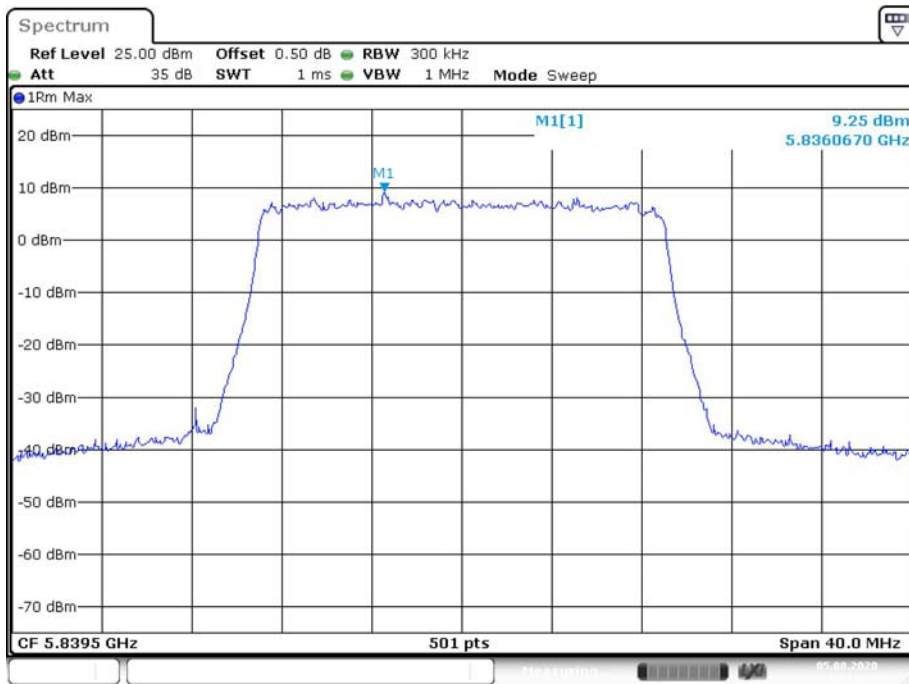

Date: 5.AUG.2020 23:21:22

2TX mode:  
Chain 0:

### 1.4M Low Channel



### 1.4M Middle Channel

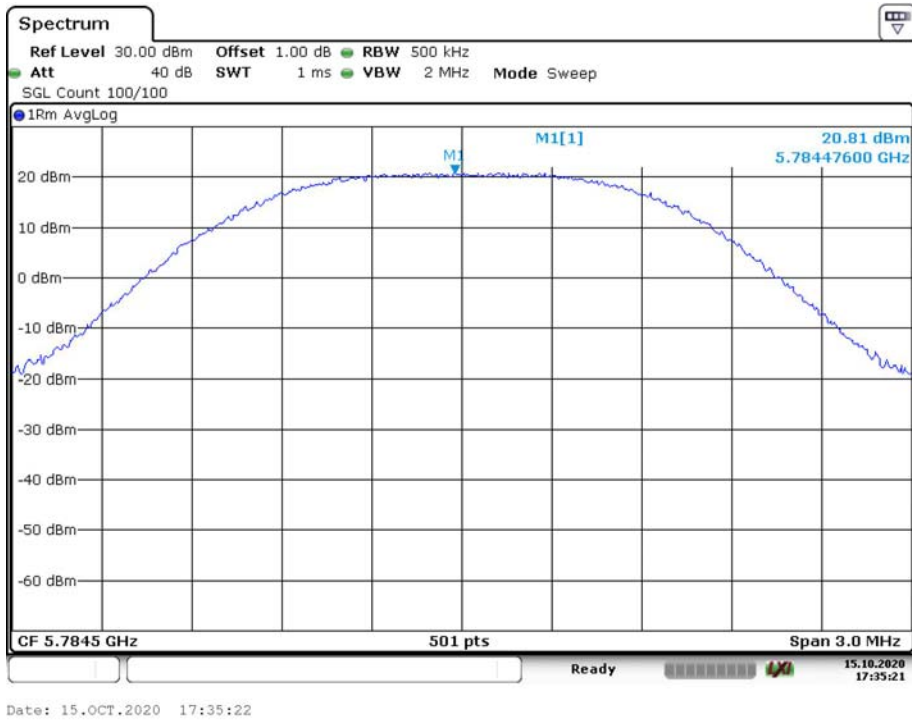

### 1.4M High Channel



### 1.4M-CA Low Channel



### 1.4M-CA Middle Channel



Date: 15.OCT.2020 17:38:59

### 1.4M-CA High Channel



Date: 15.OCT.2020 17:40:12

### 10M Low Channel

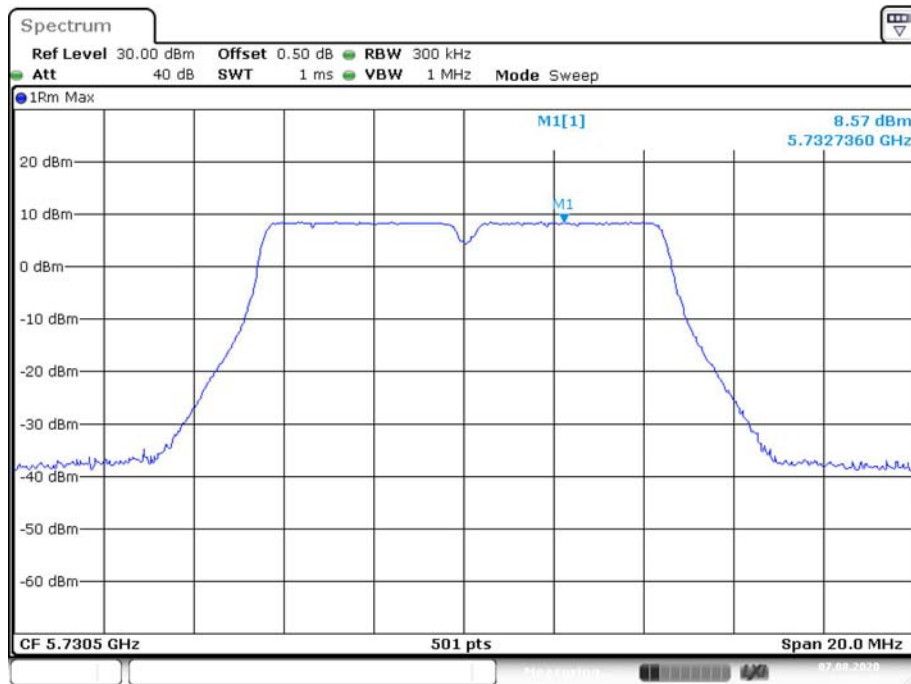

Date: 7.AUG.2020 22:25:20

### 10M Middle Channel

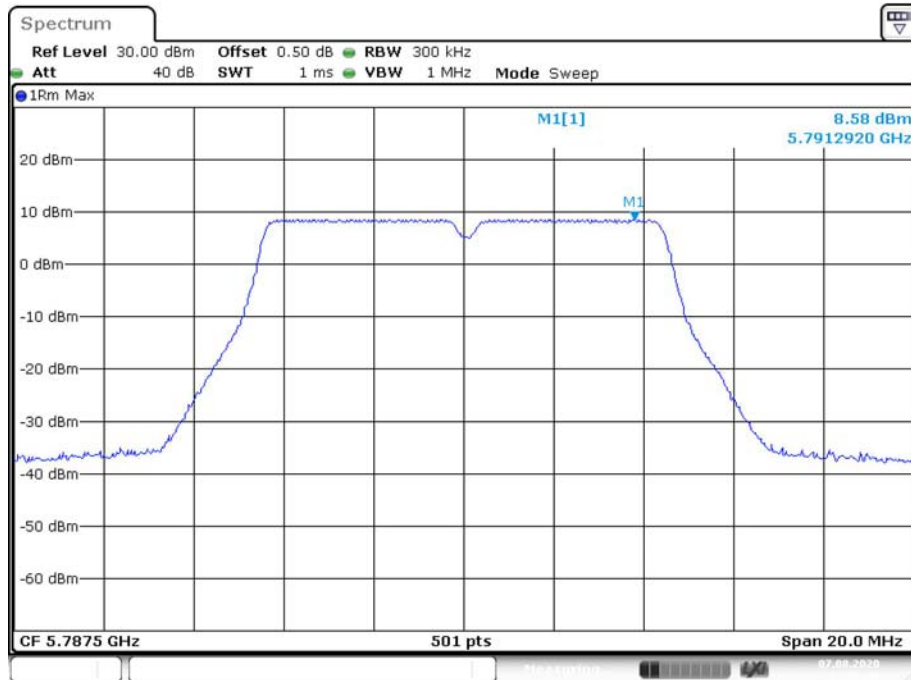

Date: 7.AUG.2020 22:35:38

### 10M High Channel

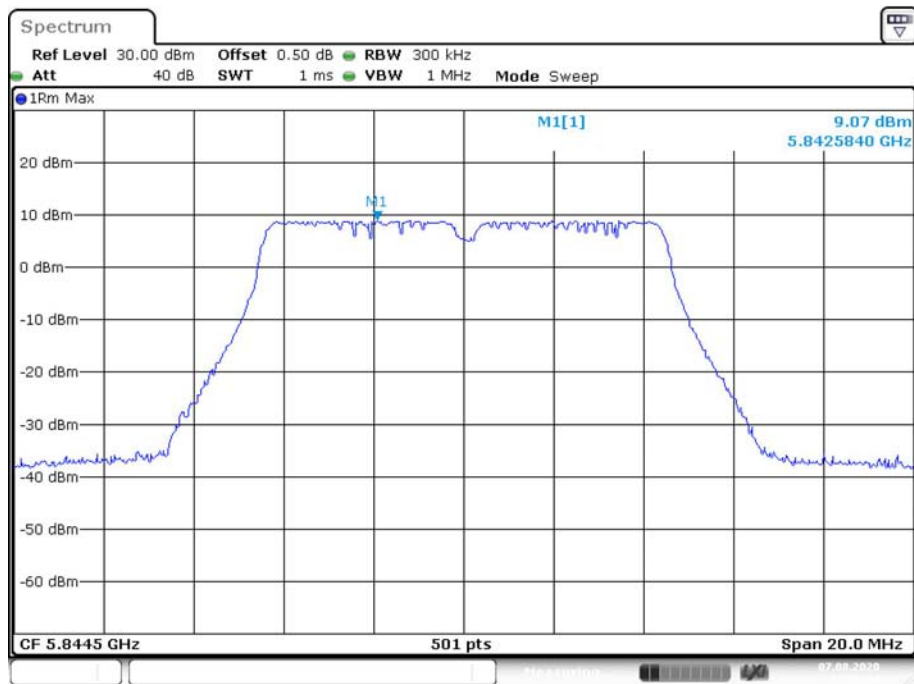

Date: 7.AUG.2020 22:38:45

### 20M Low Channel



Date: 7.AUG.2020 22:19:49

### 20M Middle Channel

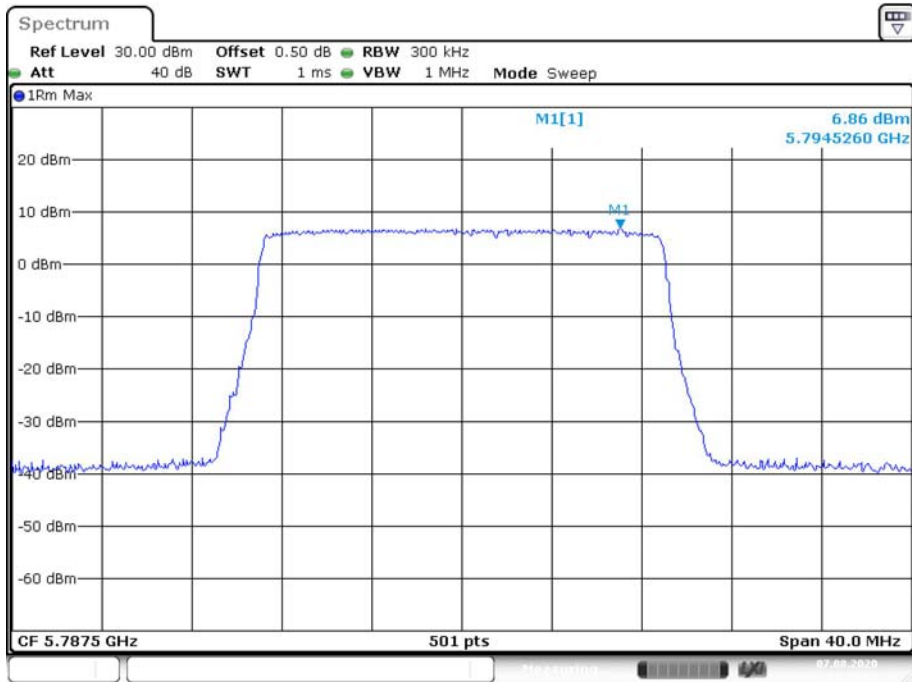

Date: 7.AUG.2020 22:18:02

### 20M High Channel

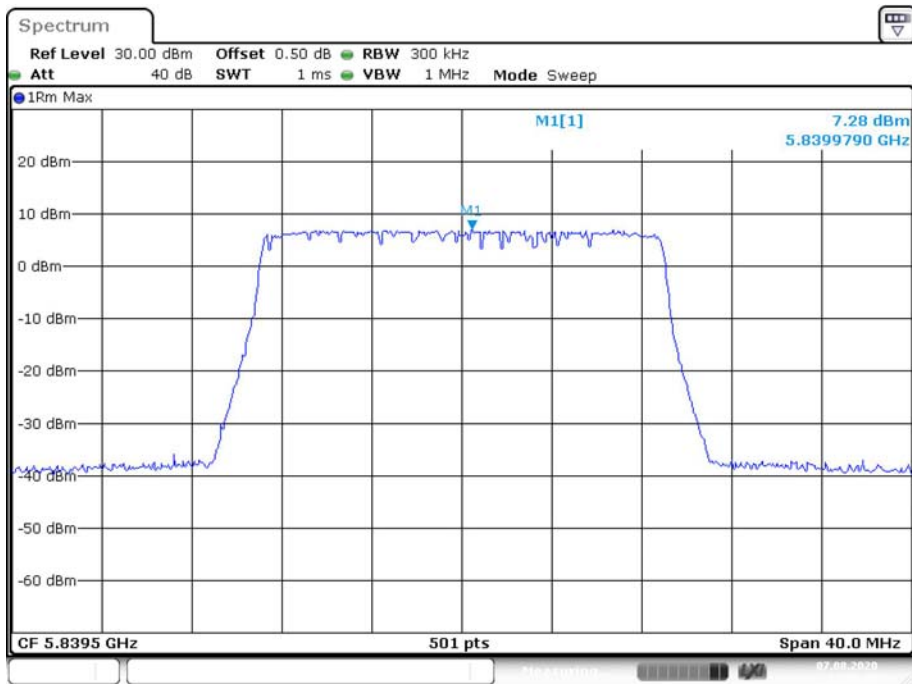

Date: 7.AUG.2020 22:03:31

Chain 1:

1.4M Low Channel

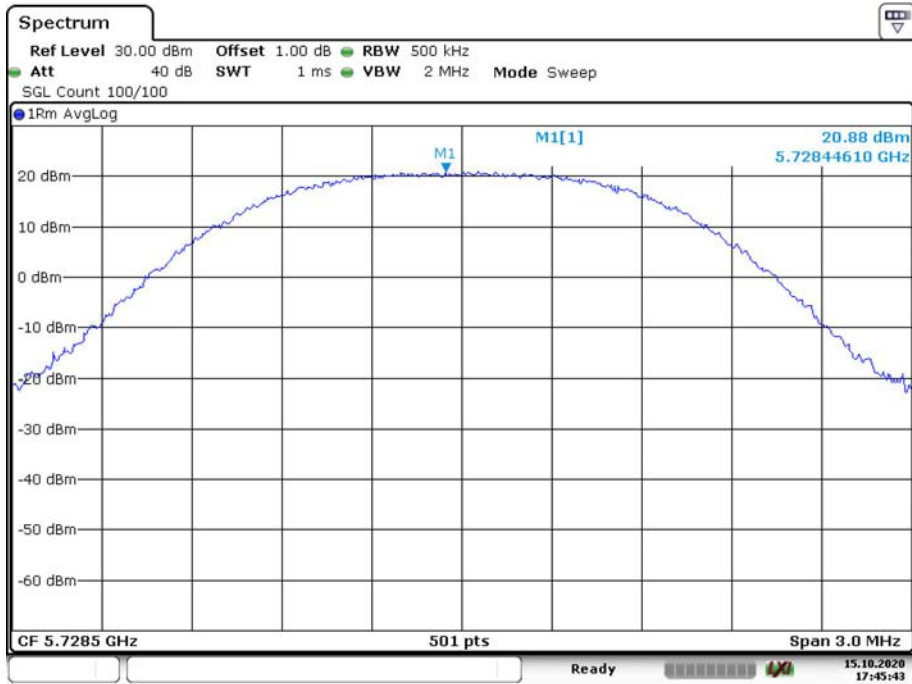

Date: 15.OCT.2020 17:45:44

1.4M Middle Channel

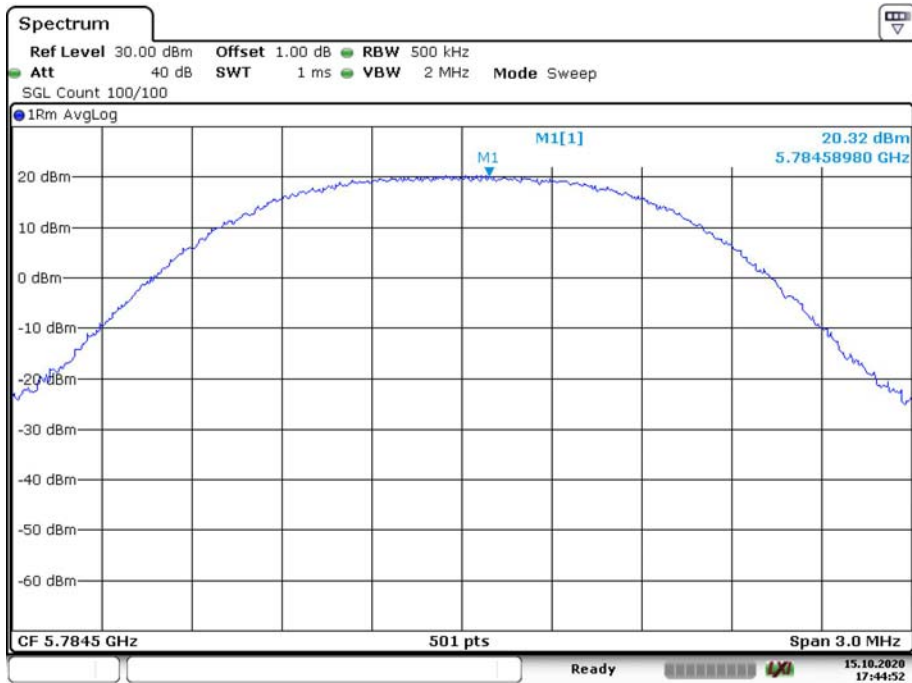

Date: 15.OCT.2020 17:44:53



### 1.4M High Channel

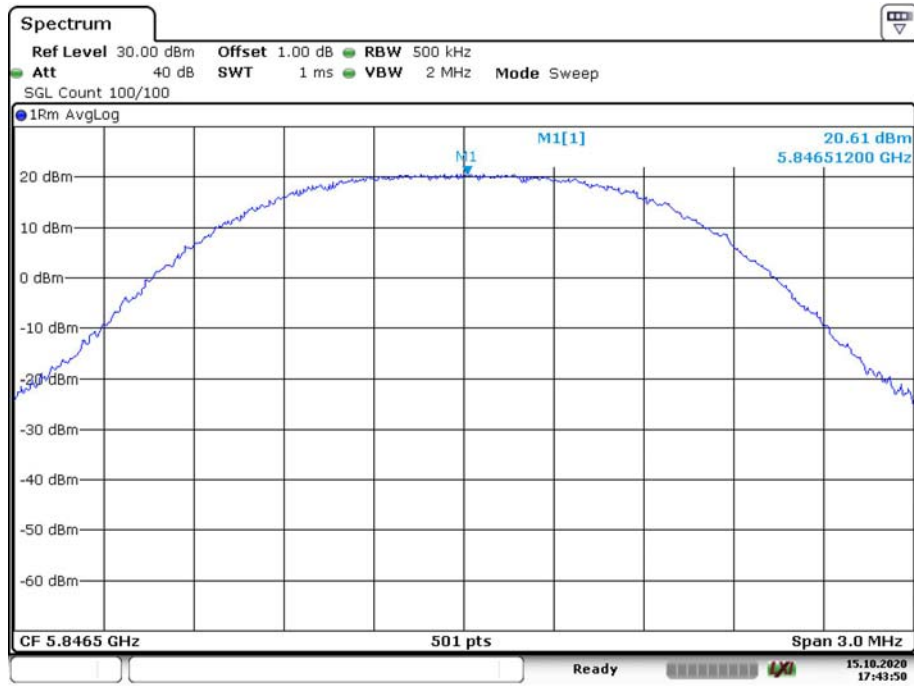

Date: 15.OCT.2020 17:43:51

### 1.4M-CA Low Channel



Date: 15.OCT.2020 17:42:55

### 1.4M-CA Middle Channel



Date: 15.OCT.2020 17:42:09

### 1.4M-CA High Channel



Date: 15.OCT.2020 17:41:20

### 10M Low Channel

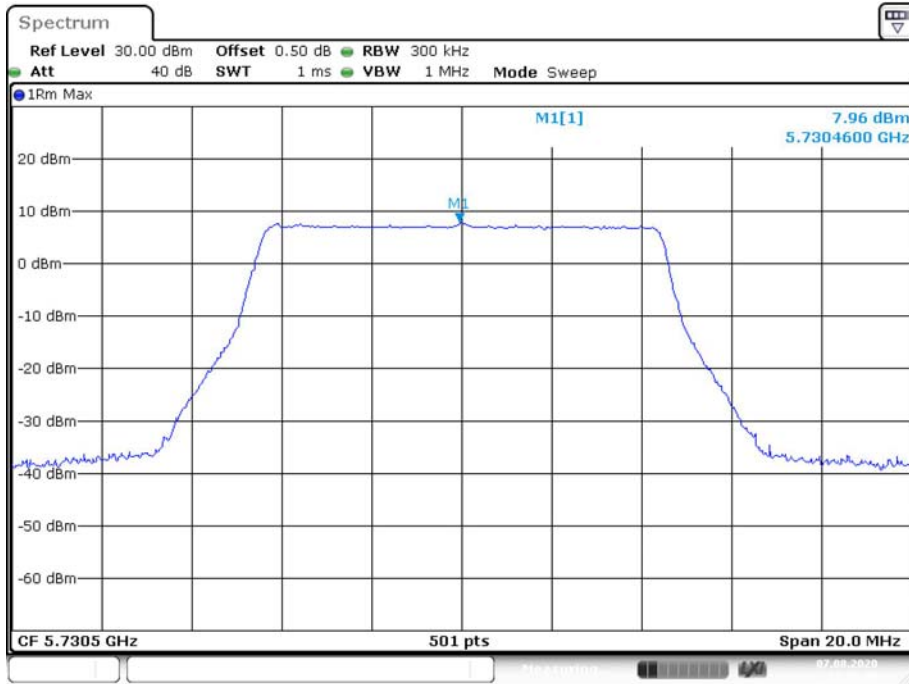

Date: 7.AUG.2020 21:33:30

### 10M Middle Channel

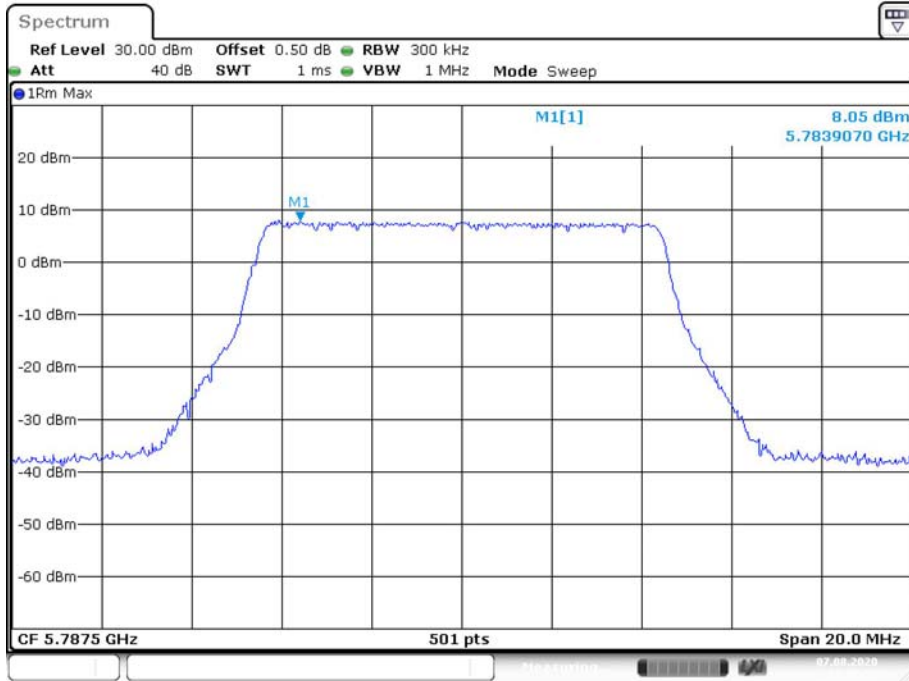

Date: 7.AUG.2020 21:37:21

### 10M High Channel

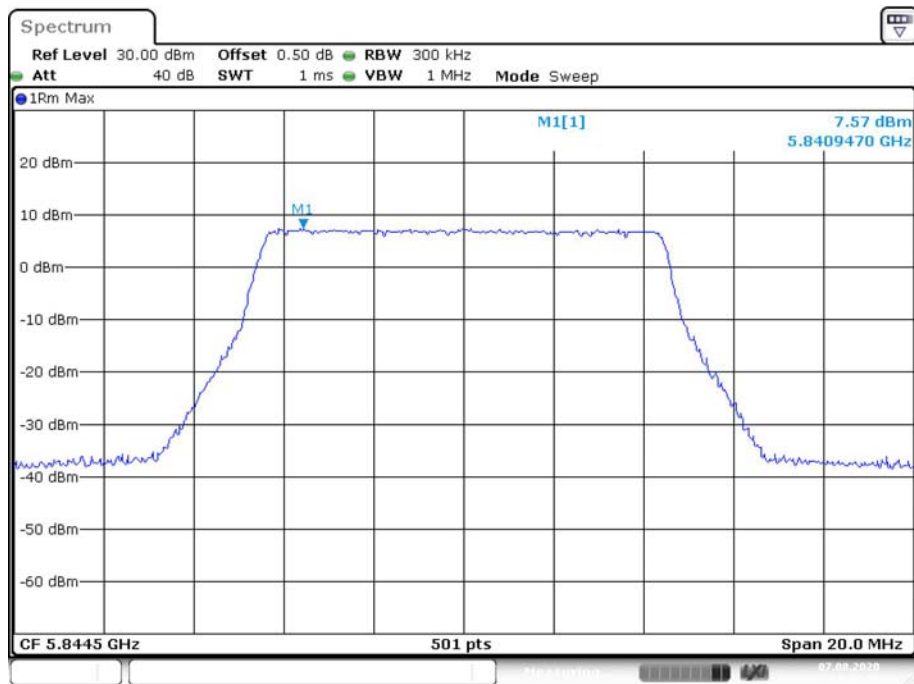

Date: 7.AUG.2020 21:47:30

### 20M Low Channel

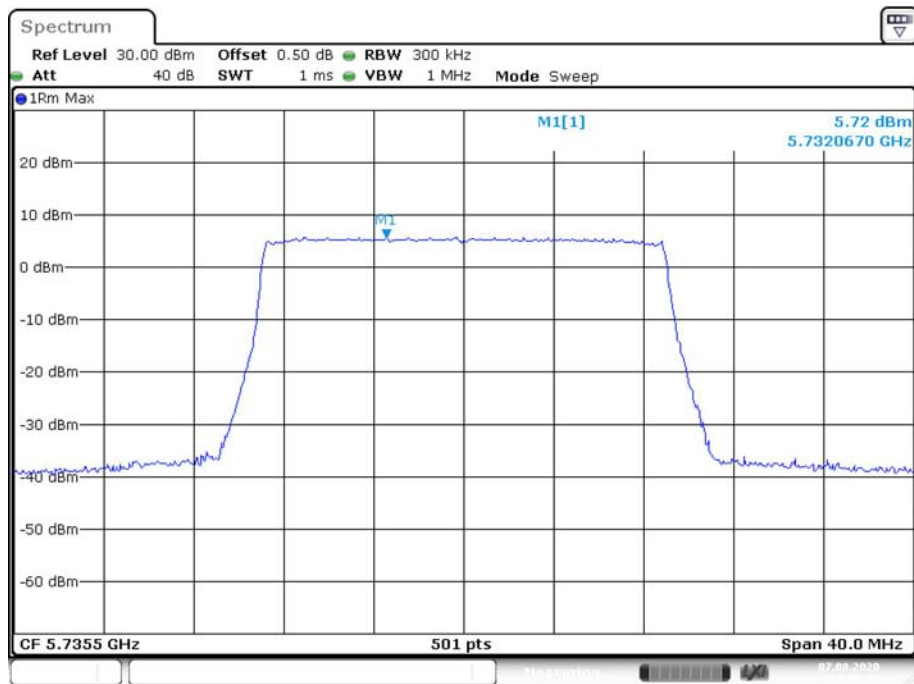

Date: 7.AUG.2020 21:50:35

### 20M Middle Channel

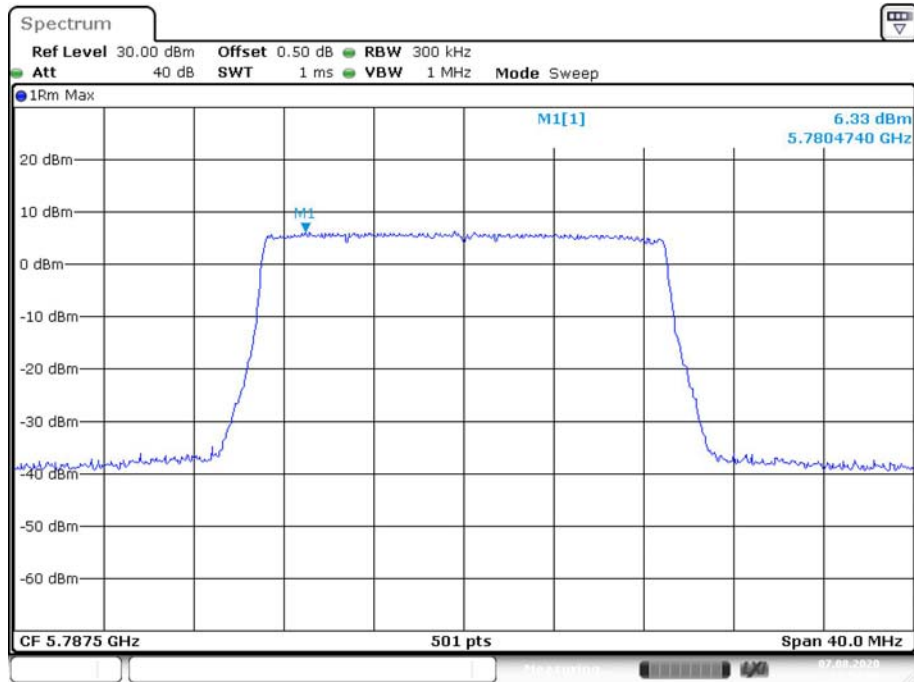

Date: 7.AUG.2020 21:54:08

### 20M High Channel

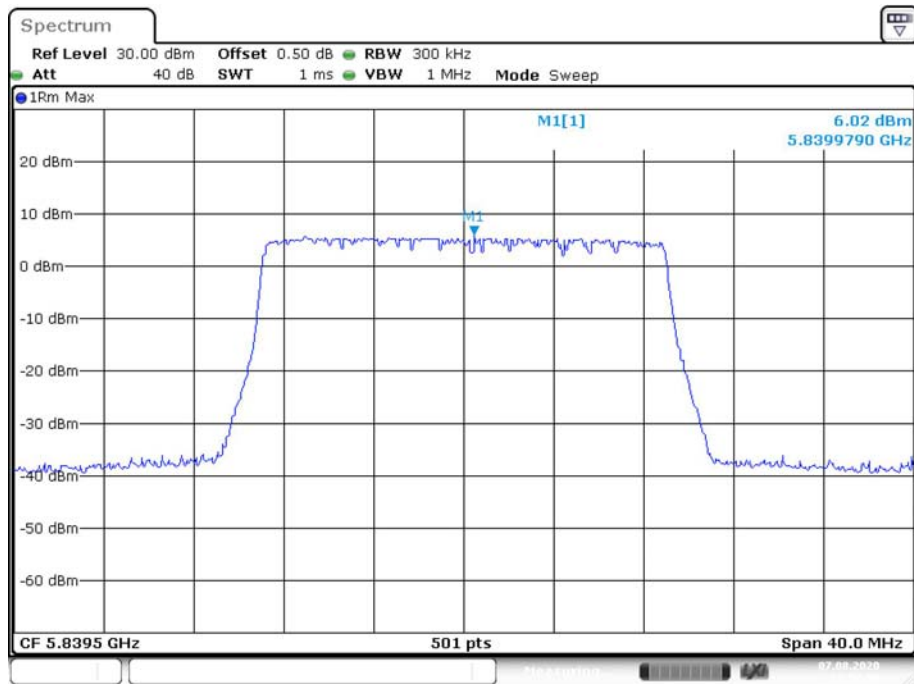

Date: 7.AUG.2020 21:57:58

## **RSS-247 CLAUSE 6.4- ADDITIONAL REQUIREMENT**

### **Applicable Standard**

According to RSS-247 Clause 6.4 Additional requirement

The following requirements shall apply:

- a) The device shall automatically discontinue transmission in cases of absence of information to transmit, or operational failure. A description on how this is done shall accompany the application for equipment certification. Note that this is not intended to prohibit transmission of control or signalling information or the use of repetitive codes where required by the technology.
- b) All LE-LAN devices must contain security features to protect against modification of software by unauthorized parties.

Manufacturers must implement security features in any digitally modulated devices capable of operating in any of the frequency ranges within the 5 GHz band, so that third parties are not able to reprogram the device to operate outside the parameters for which the device was certified. The software must prevent the user from operating the transmitter with operating frequencies, output power, modulation types or other radio frequency parameters outside those that were approved for the device. Manufacturers may use various means, including the use of a private network that allows only authenticated users to download software, electronic signatures in software or coding in hardware that is decoded by software to verify that new software can be legally loaded into a device to meet these requirements and must describe the methods in their application for equipment certification.

Manufacturers must take steps to ensure that DFS functionality cannot be disabled by the operator of the LE-LAN device.

- c) The user manual for LE-LAN devices shall contain instructions related to the restrictions mentioned in the above sections, namely that:
  - i. the device for operation in the band 5150–5250 MHz is only for indoor use to reduce the potential for harmful interference to co-channel mobile satellite systems;<sup>4</sup>
  - ii. for devices with detachable antenna(s), the maximum antenna gain permitted for devices in the bands 5250-5350 MHz and 5470-5725 MHz shall be such that the equipment still complies with the e.i.r.p. limit;
  - iii. for devices with detachable antenna(s), the maximum antenna gain permitted for devices in the band 5725-5850 MHz shall be such that the equipment still complies with the e.i.r.p. limits as appropriate; and
  - iv. where applicable, antenna type(s), antenna models(s), and worst-case tilt angle(s) necessary to remain compliant with the e.i.r.p. elevation mask requirement set forth in section 6.2.2.3 shall be clearly indicated.

## **Result**

### **Compliance.**

RSS-247 Clause 6.4 a):

The device shall automatically discontinue transmission in cases of absence of information to transmit, or operational failure. Please refer to the declaration

RSS-247 Clause 6.4 b):

The devices must contain security features to protect against modification of software by unauthorized parties. Please refer to the declaration

RSS-247 Clause 6.4 c):

The device operates on 5725-5850MHz, the antennas are un-detachable, and meets the EIPR limit.

**\*\*\*\*\* END OF REPORT \*\*\*\*\***