



FCC PART 15.255

TEST REPORT

For

SZ DJI TECHNOLOGY CO., LTD

14th floor, West Wing, Skyworth Semiconductor Design Building NO.18 Gaoxin South 4th Ave,
Nanshan, Shenzhen, Guangdong, China

FCC ID: SS3-60RX1604

Report Type: Original Report	Product Type: SRW-60G
Test Engineer: Emily Wang	<i>Emily Wang</i>
Report Number: RDG160322008-00	
Report Date: 2016-04-21	
Reviewed By: Dean Liu RF Engineer	<i>Dean Liu</i>
Test Laboratory:	Bay Area Compliance Laboratories Corp. (Dongguan) No.69 Pulongcun, Puxinhu Industrial Zone, Tangxia, Dongguan, Guangdong, China Tel: +86-769-86858888 Fax: +86-769-86858891 www.baclcorp.com.cn

Note: This test report is prepared for the customer shown above and for the device described herein. It may not be duplicated or used in part without prior written consent from Bay Area Compliance Laboratories Corp. (Dongguan).

TABLE OF CONTENTS

GENERAL INFORMATION.....4
 PRODUCT DESCRIPTION FOR EQUIPMENT UNDER TEST (EUT)4
 OBJECTIVE4
 RELATED SUBMITTAL(S)/GRANT(S).....4
 TEST METHODOLOGY4
 TEST FACILITY4
 TEST EQUIPMENT LIST AND DETAILS.....5
 TEST DATE.....5

SYSTEM TEST CONFIGURATION.....6
 DESCRIPTION OF TEST CONFIGURATION6
 EUT EXERCISE SOFTWARE6
 EQUIPMENT MODIFICATIONS6
 SUPPORT EQUIPMENT LIST AND DETAILS6
 EXTERNAL I/O CABLE.....7
 BLOCK DIAGRAM OF TEST SETUP7

SUMMARY OF TEST RESULTS9

FCC§1.1310 & §2.1091- MAXIMUM PERMISSIBLE EXPOSURE (MPE)10
 APPLICABLE STANDARD10

FCC§15.203 - ANTENNA REQUIREMENT.....11
 APPLICABLE STANDARD11
 ANTENNA CONNECTOR CONSTRUCTION11

FCC §15.207 – AC LINE CONDUCTED EMISSION12
 MEASUREMENT UNCERTAINTY12
 EUT SETUP12
 EMI TEST RECEIVER SETUP.....13
 TEST EQUIPMENT LIST AND DETAILS.....13
 TEST PROCEDURE13
 CORRECTED AMPLITUDE & MARGIN CALCULATION14
 TEST RESULTS SUMMARY14
 TEST DATA14

FCC§15.255(B) - EQUIVALENT ISOTROPICALLY RADIATED POWER (EIRP).....17
 APPLICABLE STANDARD17
 TEST PROCEDURE18
 ENVIRONMENTAL CONDITIONS.....18
 TEST DATA18

FCC§15.255(E)- OCCUPIED BANDWIDTH.....19
 APPLICABLE STANDARD19
 TEST PROCEDURE19
 ENVIRONMENTAL CONDITIONS.....19
 TEST DATA19

FCC§15.255(E) –PEAK CONDUCTED OUTPUT POWER.....23
 APPLICABLE STANDARD23
 TEST PROCEDURE23
 ENVIRONMENTAL CONDITIONS.....23
 TEST DATA23

FCC§15.205, §15.209&§15.255(C)- TRANSMITTER SPURIOUS EMISSIONS25

APPLICABLE STANDARD25
MEASUREMENT UNCERTAINTY25
EUT SETUP26
TEST EQUIPMENT SETUP27
TEST PROCEDURE27
ENVIRONMENTAL CONDITIONS27
TEST DATA27

FCC§15.255(F) - FREQUENCY STABILITY32
APPLICABLE STANDARD32
TEST PROCEDURE32
ENVIRONMENTAL CONDITIONS32
TEST DATA32

FCC§15.255(D) – PUBLICLY-ACCESSIBLE COORDINATION CHANNEL33
APPLICABLE STANDARD33
TEST PROCEDURE33
TEST RESULT33

§15.255(A) (H)– OPERATION RESTRICTION AND GROUP INSTALLTION.....34
APPLICABLE STANDARD34
RESULT OF OPERATION RESTRICTION34
RESULT OF GROUP INSTALLATION34

GENERAL INFORMATION

Product Description for Equipment under Test (EUT)

The *SZ DJI TECHNOLOGY CO., LTD* product, model number: *D-60G RX (FCC ID: SS3-60RX1604)* (the "EUT") in this report was a *SRW-60G*, which was measured approximately: 6.5 cm (L) x 4.6 cm (W) x 1.4 cm (H), Nominal input voltage: DC 12V(Voltage range: 7.4-18V) from 4 pin port or 5V form USB port(USB host operation).

All measurement and test data in this report was gathered from production sample serial number: 160322008 (Assigned by BACL, Dongguan). The EUT was received on 2016-03-24.

Objective

This type approval report is prepared on behalf of *SZ DJI TECHNOLOGY CO., LTD.* in accordance with Part 2-Subpart J, and Part 15-Subparts A, B and C of the Federal Communication Commissions rules.

The tests were performed in order to determine compliance with FCC Part 15, Subpart C, and section 15.203 15.205 15.207 15.209 and 15.255 rules.

Related Submittal(s)/Grant(s)

Submitted with the Part of a system with FCC ID: SS3-60TX1604

Test Methodology

All measurements contained in this report were conducted with ANSI C63.10-2013, American National Standard of Procedures for Compliance Testing of Unlicensed Wireless Devices.

All emissions measurement was performed and Bay Area Compliance Laboratories Corp. (Dongguan).

Test Facility

The Test site used by Bay Area Compliance Laboratories Corp. (Dongguan) to collect test data is located on the No.69 Pulongcun, Puxinhu Industrial Zone, Tangxia, Dongguan, Guangdong, China

Test site at Bay Area Compliance Laboratories Corp. (Dongguan) has been fully described in reports submitted to the Federal Communication Commission (FCC). The details of these reports have been found to be in compliance with the requirements of Section 2.948 of the FCC Rules on February 06, 2015.

The Federal Communications Commission has the reports on file and is listed under FCC Registration No.: 273710. The test site has been approved by the FCC for public use and is listed in the FCC Public Access Link (PAL) database.

Test Equipment List and Details

Manufacturer	Description	Model	Serial Number	Calibration Date	Calibration Due Date
R&S	EMI Test Receiver	ESCI	100224	2015-08-03	2016-08-02
Sunol Sciences	Antenna	JB3	A060611-3	2014-11-06	2017-11-05
HP	Amplifier	8447E	2434A02181	2015-09-01	2016-09-01
Agilent	Spectrum Analyzer	E4440A	SG43360054	2015-11-23	2016-11-22
ETS-Lindgren	Horn Antenna	3115	9808-5557	2015-09-06	2018-09-06
Mini-Circuit	Amplifier	ZVA-213-S+	054201245	2016-02-19	2017-02-19
R&S	Spectrum Analyzer	FSP 38	100478	2015-05-09	2016-05-09
Ducommun Technologies	Horn Antenna	ARH-4223-02	1007726-01 1304	2014-06-16	2017-06-15
Ducommun Technologies	Horn Antenna	ARH-2823-02	1007726-01 1302	2014-06-16	2017-06-15
Agilent	Spectrum Analyzer	8564E	3943A01781	2015-5-10	2016-5-9
Agilent	Harmonic Mixer	11970U	2332A00853	2015-8-16	2017-8-15
Flann Microwave	Horn Antenna	24245-AB	26	N/A	N/A
Agilent	Harmonic Mixer	11970V	2521A011767	2015-8-16	2017-8-15
Alpha Industries	Horn Antenna	861V/385	736	N/A	N/A
Agilent	Harmonic Mixer	11970W	2521A00597	2015-8-16	2017-8-15
Alpha Industries	Horn Antenna	861W/387	355	N/A	N/A
OML	Diplexer	DPL.26	N/A	N/A	N/A
OML	Harmonic Mixer	HWD08	F60313-1	2015-1-9	2017-1-8
OML	Horn Antenna	M08RH	N/A	N/A	N/A
OML	Harmonic Mixer	HWD05	G60106-1	2015-2-19	2017-2-18
OML	Horn Antenna	M05RH	N/A	N/A	N/A
Quinstar	Amplifier	QLW-18405536-JO	15964001001	2015-09-06	2016-09-06
N/A	Coaxial Cable	14m	N/A	2015-05-06	2016-05-06
N/A	Coaxial Cable	8m	N/A	2015-05-06	2016-05-06
Agilent	Coaxial Cable	1m	N/A	2015-05-06	2016-05-06
Agilent	Coaxial Cable	1m	N/A	2015-05-06	2016-05-06

* **Statement of Traceability:** Bay Area Compliance Laboratories Corp. (Dongguan) attests that all calibrations have been performed, traceable to National Primary Standards and International System of Units (SI).

Test Date

2016-03-24~ 2016-04-20

SYSTEM TEST CONFIGURATION

Description of Test Configuration

The system was configured for testing in Engineering Mode, which was provided by the manufacturer.

The device can powered by DC 12V from 4 pin port (CAN port), typical used with a battery; And DC 5V from USB port, typical used with a PC or laptop. Both modes were evaluated in the test. The typical use condition was provided by the manufacturer.

The device supports LRP mode, the operation channels list in the below table:

Channel Number	Frequency (MHz)	Channel Number	Frequency (MHz)
1	60163	6	62323
2	60321	7	62481
3	60480	8	62640
4	60639	9	62799
5	60797	10	62957

Channel 1, 5, 10 was chose for testing.

EUT Exercise Software

The software “SWAM3” was used for testing, which was provided by manufacturer. The worst condition (maximum power) was configured by system default setting.

Equipment Modifications

No modifications were made to the EUT.

Support Equipment List and Details

Manufacturer	Description	Model	Serial Number
DJI	LIGHTBRIDGE (Terminal)	N/A	N/A
N/A	battery	N/A	N/A
Lenovo	Laptop	G510	HY1482

External I/O Cable

Cable Description	Shielding Type	Ferrite Core	Length (m)	From Port	To
HDMI cable	yes	yes	0.43	EUT	LIGHTBRIDGE
DC Cable	Yes	yes	1.0	adapter	Laptop
USB Cable	Yes	Yes	1.0	Laptop	EUT

Block Diagram of Test Setup

Battery operating(Radiation):

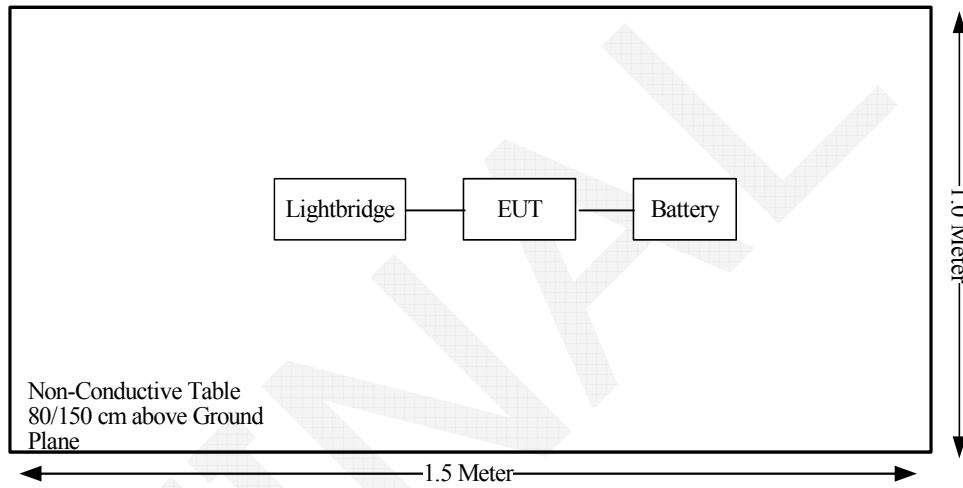

USB Operating(Conduction):

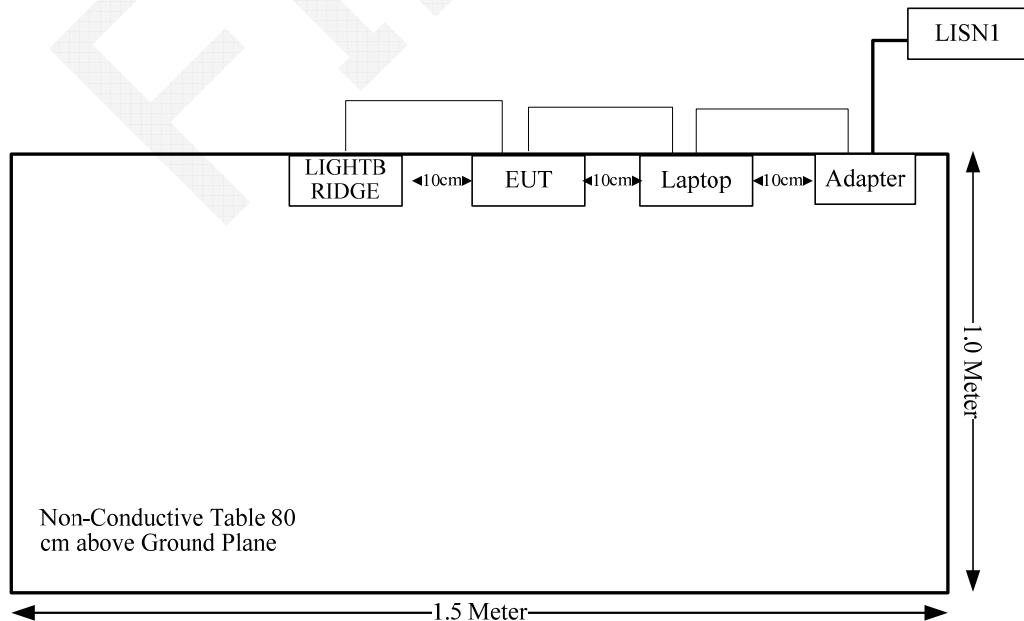

USB Operating(Radiation):

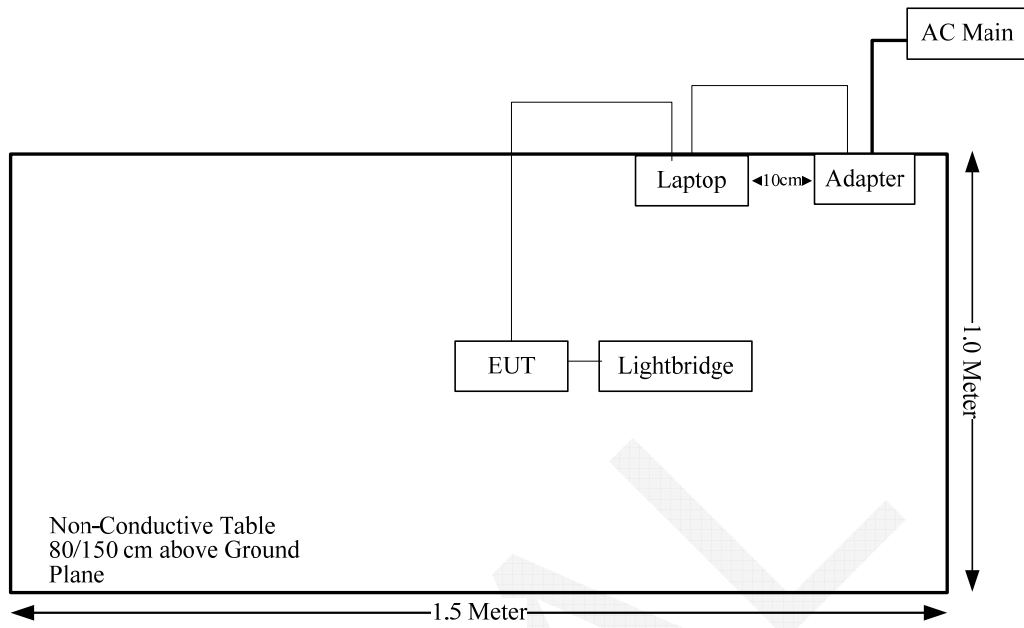

SUMMARY OF TEST RESULTS

FCC Rules	Description of Test	Result
§1.1310&§2.1091	Maximum Permissible Exposure	Compliance
§15.203	Antenna Requirement	Compliance
§15.207 (a)	AC Line Conducted Emissions	Compliance
§ 15.255 (e)	Occupied Bandwidth	Compliance
§15.255 (b)	EIRP Power	Compliance
§15.255 (e)	Peak Conducted Output Power	Compliance
§15.255 (c)	Spurious Emissions	Compliance
§15.255 (f)	Frequency Stability	Compliance
§15.255 (d)	Publicly-Accessible Coordination Channel	Compliance
§15.255 (a)(h)	Operation Restriction And Group Installation	Compliance

FCC§1.1310 & §2.1091- MAXIMUM PERMISSIBLE EXPOSURE (MPE)

Applicable Standard

According to subpart §1.1310, systems operating under the provisions of this section shall be operated in a manner that ensures that the public is not exposed to radio frequency energy level in excess of the Commission’s guidelines.

Limits for Maximum Permissible Exposure (MPE) (§1.1310, §2.1091)

(B) Limits for General Population/Uncontrolled Exposure				
Frequency Range (MHz)	Electric Field Strength (V/m)	Magnetic Field Strength (A/m)	Power Density (mW/cm ²)	Averaging Time (minutes)
0.3–1.34	614	1.63	*(100)	30
1.34–30	824/f	2.19/f	*(180/f ²)	30
30–300	27.5	0.073	0.2	30
300–1500	/	/	f/1500	30
1500–100,000	/	/	1.0	30

f = frequency in MHz; * = Plane-wave equivalent power density;

According to §1.1310 and §2.1091 RF exposure is calculated.

Calculated Formulary:

Predication of MPE limit at a given distance

$S = PG/4\pi R^2$ = power density (in appropriate units, e.g. mW/cm²);

P = power input to the antenna (in appropriate units, e.g., mW);

G = power gain of the antenna in the direction of interest relative to an isotropic radiator, the power gain factor, is normally numeric gain;

R = distance to the center of radiation of the antenna (appropriate units, e.g., cm);

Calculated Data:

Frequency (GHz)	E.I.R.P		Evaluation Distance (cm)	Power Density (mW/cm ²)	MPE Limit (mW/cm ²)
	(dBm)	(mW)			
60.163-62.957	30	1000	20.00	0.20	1.0

Note: The tune-up power is 30dBm(E.I.R.P).

Result: The device meet FCC MPE at 20 cm distance

FCC§15.203 - ANTENNA REQUIREMENT

Applicable Standard

For intentional device, according to §15.203, an intentional radiator shall be designed to ensure that no antenna other than that furnished by the responsible party shall be used.

Antenna Connector Construction

The EUT has one integral antenna on chip, which antenna gain is 16 dBi, fulfill the requirement of this section. Please refer to the EUT photos.

Result: Compliant.

FEMVA

FCC §15.207 – AC LINE CONDUCTED EMISSION

Measurement Uncertainty

Compliance or non-compliance with a disturbance limit shall be determined in the following manner:

If U_{lab} is less than or equal to U_{cispr} of Table 1, then:

- compliance is deemed to occur if no measured disturbance level exceeds the disturbance limit;
- non-compliance is deemed to occur if any measured disturbance level exceeds the disturbance limit.

If U_{lab} is greater than U_{cispr} of Table 1, then:

- compliance is deemed to occur if no measured disturbance level, increased by $(U_{lab} - U_{cispr})$, exceeds the disturbance limit;
- non-compliance is deemed to occur if any measured disturbance level, increased by $(U_{lab} - U_{cispr})$, exceeds the disturbance limit.

Based on CISPR 16-4-2-2011, measurement uncertainty of conducted disturbance at mains port using AMN at Bay Area Compliance Laboratories Corp. (Dongguan) is 3.12 dB (150 kHz to 30 MHz).

Table 1 – Values of U_{cispr}

Measurement	U_{cispr}
Conducted disturbance at mains port using AMN (9 kHz to 150 kHz)	3.8 dB
(150 kHz to 30 MHz)	3.4 dB
Conducted disturbance at mains port using voltage probe (9 kHz to 30 MHz)	2.9 dB
Conducted disturbance at telecommunication port using AAN (150 kHz to 30 MHz)	5.0 dB
Conducted disturbance at telecommunication port using CVP (150 kHz to 30 MHz)	3.9 dB
Conducted disturbance at telecommunication port using CP (150 kHz to 30 MHz)	2.9 dB

EUT Setup

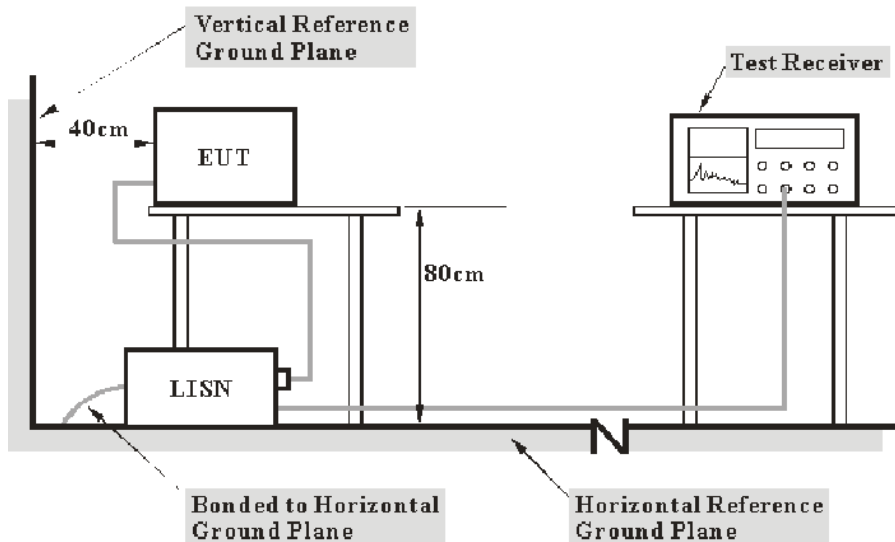

- Note: 1. Support units were connected to second LISN.
 2. Both of LISNs (AMN) 80 cm from EUT and at the least 80 cm from other units and other metal planes support units.

The setup of EUT is according with per ANSI C63.10-2013 measurement procedure. The specification used was with the FCC Part 15.207.

The external I/O cables were draped along the test table and formed a bundle 30 to 40 cm long in the middle.

The spacing between the peripherals was 10 cm.

The adapter was connected to a 120 VAC/60 Hz power source.

EMI Test Receiver Setup

The EMI test receiver was set to investigate the spectrum from 150 kHz to 30 MHz.

During the conducted emission test, the EMI test receiver was set with the following configurations:

Frequency Range	IF B/W
150 kHz – 30 MHz	9 kHz

Test Equipment List and Details

Manufacturer	Description	Model	Serial Number	Calibration Date	Calibration Due Date
R&S	EMI Test Receiver	ESCS 30	830245/006	2015-12-10	2016-12-09
R&S	L.I.S.N	ESH2-Z5	892107/021	2015-07-16	2016-07-15
R&S	Two-line V-network	ENV 216	3560.6550.12	2015-11-26	2016-11-25
TESEQ	ISN	T8	34379	2016-04-07	2017-04-06
BACL	Test Software	EMC32	Version8.53.0	N/A	N/A

* Statement of Traceability: Bay Area Compliance Laboratories Corp. (Dongguan) attests that all calibrations have been performed, traceable to National Primary Standards and International System of Units (SI).

Test Procedure

During the conducted emission test, the adapter was connected to the outlet of the LISN.

Maximizing procedure was performed on the six (6) highest emissions of the EUT.

All data was recorded in the Quasi-peak and average detection mode.

According FCC publication number 174176, for a device with a permanent antenna operating at or below 30 MHz, the measurements done with a suitable dummy load, in lieu of the permanent antenna under the following conditions: (1) perform the AC line conducted tests with the permanent antenna to determine compliance with the Section 15.207 limits outside the transmitter's fundamental emission band; (2) retest with a dummy load in lieu of the permanent antenna to determine compliance with the Section 15.207 limits within the transmitter's fundamental emission band.

Corrected Amplitude & Margin Calculation

The basic equation is as follows:

$$V_C = V_R + A_C + VDF$$

Herein,

V_C : corrected voltage amplitude

V_R : reading voltage amplitude

A_C : attenuation caused by cable loss

VDF : voltage division factor of AMN or ISN

The “**Margin**” column of the following data tables indicates the degree of compliance within the applicable limit. For example, a margin of 7dB means the emission is 7dB below the maximum limit. The equation for margin calculation is as follows:

$$\text{Margin} = \text{Limit} - \text{Corrected Amplitude}$$

Test Results Summary

According to the recorded data in following table, the EUT complied with the FCC Part 15.207, with the worst margin reading of:

13.50 dB at 0.150000 MHz in the **Line** conducted mode

Test Data

Environmental Conditions

Temperature:	25.9°C
Relative Humidity:	52 %
ATM Pressure:	100.8 kPa

The testing was performed by Emily Wang on 2016-04-20.

Test Mode: Transmitting (USB operating)

AC 120V, 60 Hz, Line:

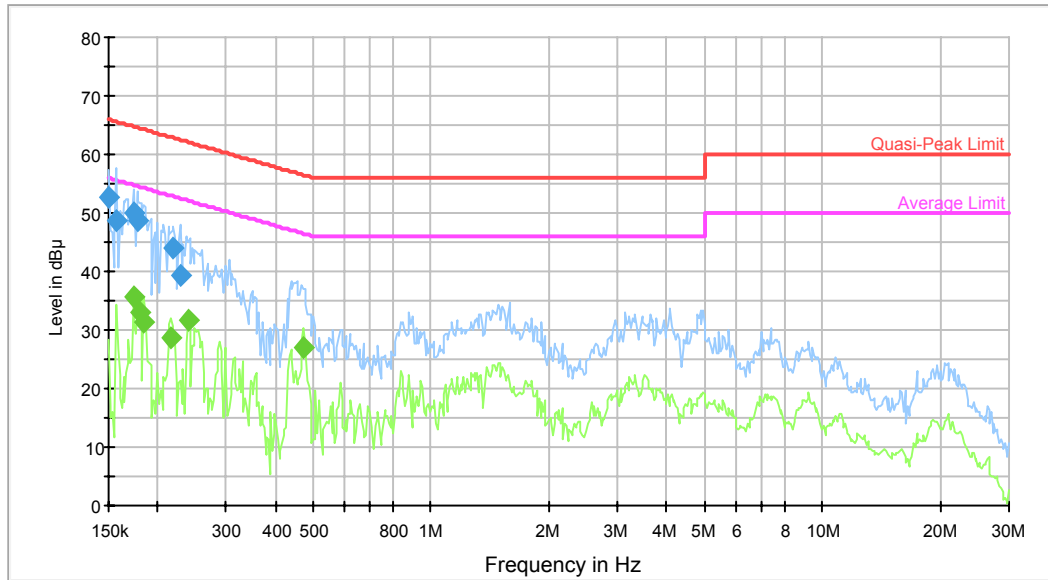

Frequency (MHz)	Quasi Peak (dBμV)	Bandwidth (kHz)	Line	Corr. (dB)	Margin (dB)	Limit (dBμV)	Comment
0.150000	52.5	9.000	L1	9.8	13.5	66.0	Compliance
0.157346	48.5	9.000	L1	9.7	17.1	65.6	Compliance
0.173134	50.1	9.000	L1	9.7	14.7	64.8	Compliance
0.177322	48.5	9.000	L1	9.7	16.1	64.6	Compliance
0.219886	44.1	9.000	L1	9.7	18.7	62.8	Compliance
0.228823	39.3	9.000	L1	9.7	23.2	62.5	Compliance

Frequency (MHz)	Average (dBμV)	Bandwidth (kHz)	Line	Corr. (dB)	Margin (dB)	Limit (dBμV)	Comment
0.173134	35.7	9.000	L1	9.7	19.1	54.8	Compliance
0.180171	32.9	9.000	L1	9.7	21.6	54.5	Compliance
0.184529	31.3	9.000	L1	9.7	23.0	54.3	Compliance
0.216409	28.6	9.000	L1	9.7	24.4	53.0	Compliance
0.240029	31.6	9.000	L1	9.7	20.5	52.1	Compliance
0.472507	27.1	9.000	L1	9.8	19.4	46.5	Compliance

AC120 V, 60 Hz, Neutral:

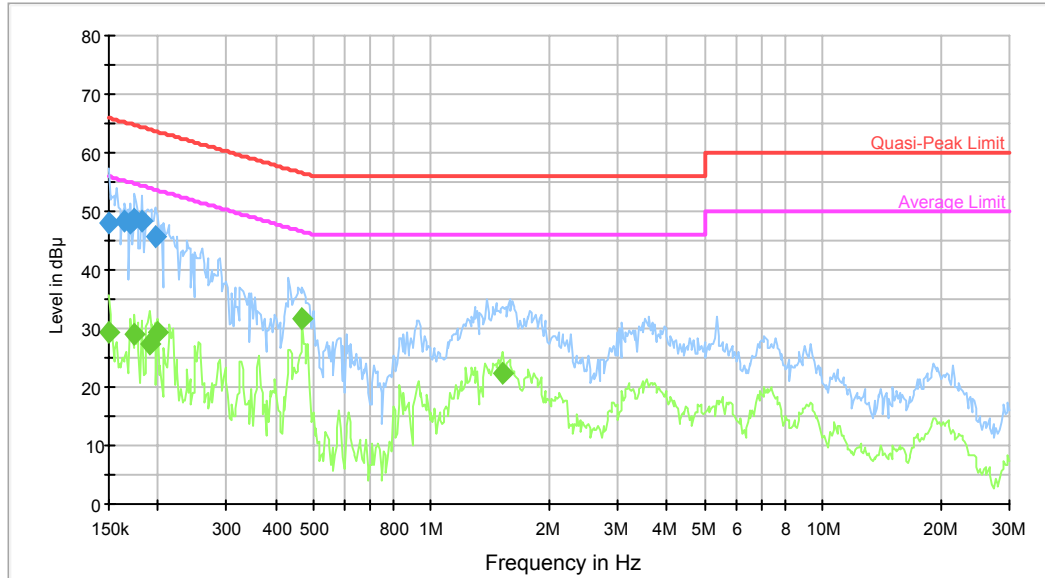

Frequency (MHz)	Quasi Peak (dBµV)	Bandwidth (kHz)	Line	Corr. (dB)	Margin (dB)	Limit (dBµV)	Comment
0.150000	48.1	9.000	N	9.7	17.9	66.0	Compliance
0.165051	48.4	9.000	N	9.7	16.8	65.2	Compliance
0.170396	48.1	9.000	N	9.7	16.8	64.9	Compliance
0.174519	48.7	9.000	N	9.7	16.0	64.7	Compliance
0.183065	48.2	9.000	N	9.7	16.1	64.3	Compliance
0.196675	45.7	9.000	N	9.7	18.0	63.7	Compliance

Frequency (MHz)	Average (dBµV)	Bandwidth (kHz)	Line	Corr. (dB)	Margin (dB)	Limit (dBµV)	Comment
0.150000	29.3	9.000	N	9.7	26.7	56.0	Compliance
0.174519	29.1	9.000	N	9.7	25.6	54.7	Compliance
0.190505	27.3	9.000	N	9.7	26.7	54.0	Compliance
0.199835	29.5	9.000	N	9.7	24.1	53.6	Compliance
0.468757	31.5	9.000	N	9.7	15.0	46.5	Compliance
1.524426	22.4	9.000	N	9.8	23.6	46.0	Compliance

FCC§15.255(b) - Equivalent Isotropically Radiated Power (EIRP)

Applicable Standard

(b) Within the 57-64 GHz band, emission levels shall not exceed the following equivalent isotropically radiated power (EIRP):

(1) Products other than fixed field disturbance sensors shall comply with one of the following emission limits, as measured during the transmit interval:

(i) Except as indicated in paragraph (b)(1)(ii) of this section, the average power of any emission shall not exceed 40 dBm and the peak power of any emission shall not exceed 43 dBm.

(ii) For transmitters located outdoors, the average power of any emission shall not exceed 82 dBm minus 2 dB for every dB that the antenna gain is less than 51 dBi. The peak power of any emission shall not exceed 85 dBm minus 2 dB for every dB that the antenna gain is less than 51 dBi. The provisions of §15.204(c)(2) and (c)(4) of this part that permit the use of different antennas of the same type and of equal or less directional gain do not apply to intentional radiator systems operating under this provision. In lieu thereof, intentional radiator systems shall be certified using the specific antenna(s) with which the system will be marketed and operated. Compliance testing shall be performed using the highest gain and the lowest gain antennas for which certification is sought and with the intentional radiator operated at its maximum available output power level. The responsible party, as defined in §2.909 of this chapter, shall supply a list of acceptable antennas with the application for certification.

(2) For fixed field disturbance sensors that occupy 500 MHz or less of bandwidth and that are contained wholly within the frequency band 61.0-61.5 GHz, the average power of any emission, measured during the transmit interval, shall not exceed 40 dBm, and the peak power of any emission shall not exceed 43 dBm. In addition, the average power of any emission outside of the 61.0-61.5 GHz band, measured during the transmit interval, but still within the 57-64 GHz band, shall not exceed 10 dBm, and the peak power of any emission shall not exceed 13 dBm.

(3) For fixed field disturbance sensors other than those operating under the provisions of paragraph (b)(2) of this section, the peak transmitter conducted output power shall not exceed -10 dBm and the peak EIRP level shall not exceed 10 dBm.

(4) The peak power shall be measured with an RF detector that has a detection bandwidth that encompasses the 57-64 GHz band and has a video bandwidth of at least 10 MHz. The average emission levels shall be calculated based on the measured peak levels, over the actual time period during which transmission occurs. Measurement procedures that have been found to be acceptable to the Commission in accordance with §2.947 of this chapter may be used to demonstrate compliance.

Test Procedure

Refer to ANSI C63.10-2013 Clause 9.10

Maximizing procedure was performed on the highest emissions to ensure that the EUT complied with all installation combinations.

Data was recorded in peak and Average detection modes for frequencies above 1 GHz.

Environmental Conditions

Temperature:	21.8 °C
Relative Humidity:	45 %
ATM Pressure:	101.4 kPa

Test Data

Please refer to the following table:

Test Mode: Transmitting

Frequency	Receiver		Rx Antenna		Corrected Amplitude	EIRP Power	Limit
	Reading	Detector	Polar	Factor			
GHz	dBμV	PK/QP/AV	H/V	dB(1/m)	dBμV/m	dBm	dBm
60.163	90.92	PK	H	42.62	133.54	28.84	43.00
60.163	77.00	AV	H	42.62	119.62	14.92	40.00
60.797	90.72	PK	H	42.74	133.46	28.76	43.00
60.797	76.54	AV	H	42.74	119.28	14.58	40.00
62.957	91.52	PK	H	43.15	134.67	29.97	43.00
62.957	77.67	AV	H	43.15	120.82	16.12	40.00

Note 1:

$$\text{EIRP} = \text{E-meas} + 20\log(\text{d-meas}) - 104.7$$

where:

EIRP : is the equivalent isotopically radiated power, in dBm

E-meas. : is the field strength of the emission at the measurement distance, in dBμV/m

d-meas. : is the measurement distance, in m

Note 2: The test distance is 1.0 m.

Note 3: Corrected Amplitude = Meter Reading + Antenna Factor

Note 4: The Mixers and it's RF cables is compose a system for calibration, the conversion factor was added into the test Spectrum Analyzer in testing.

Note 5: the test data recorded was the maximum polarization.

FCC§15.255(e)- Occupied Bandwidth

Applicable Standard

For the purposes of this paragraph (e)(1), emission bandwidth is defined as the instantaneous frequency range occupied by a steady state radiated signal with modulation, outside which the radiated power spectral density never exceeds 6 dB below the maximum radiated power spectral density in the band, as measured with a 100 kHz resolution bandwidth spectrum analyzer. The center frequency must be stationary during the measurement interval, even if not stationary during normal operation (e.g., for frequency hopping devices).

Test Procedure

Refer to ANSI C63.10-2013 Clause 6.9 & 9.3

Environmental Conditions

Temperature:	21.8 °C
Relative Humidity:	45 %
ATM Pressure:	101.4 kPa

Test Data

Please refer to the following tables and plots:

Test Mode: Transmitting

Channel	Frequency	6 dB Bandwidth	99% Bandwidth
	(MHz)	(MHz)	(MHz)
Low	60163	90.30	259.20
Middle	60797	91.00	270.00
High	62957	90.00	276.70

6dB Bandwidth

Low Channel

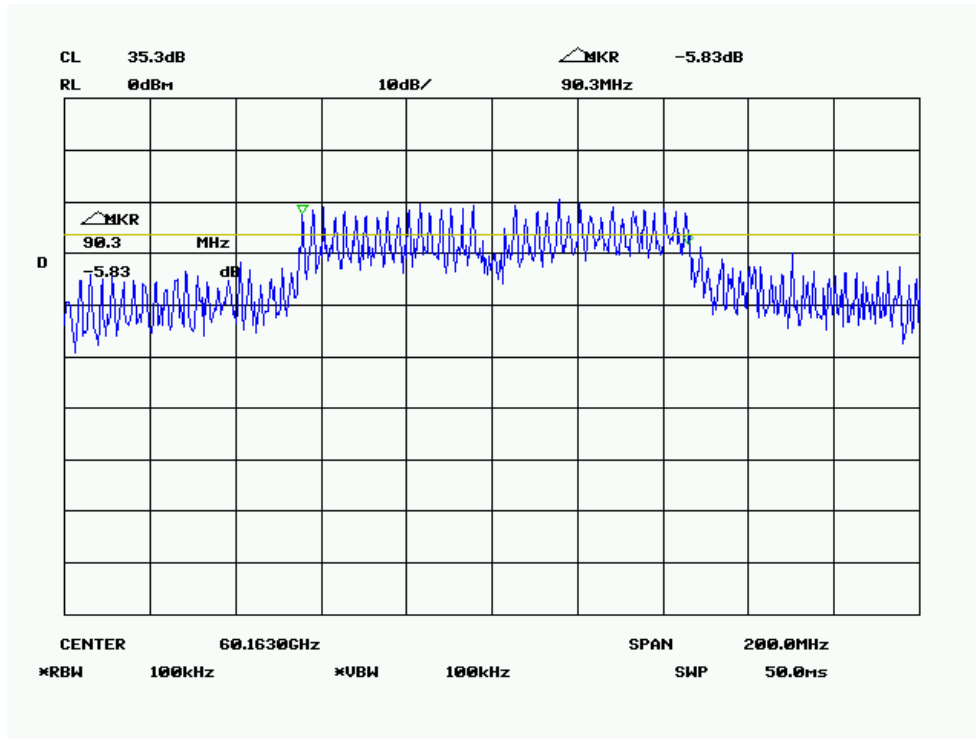

Middle Channel

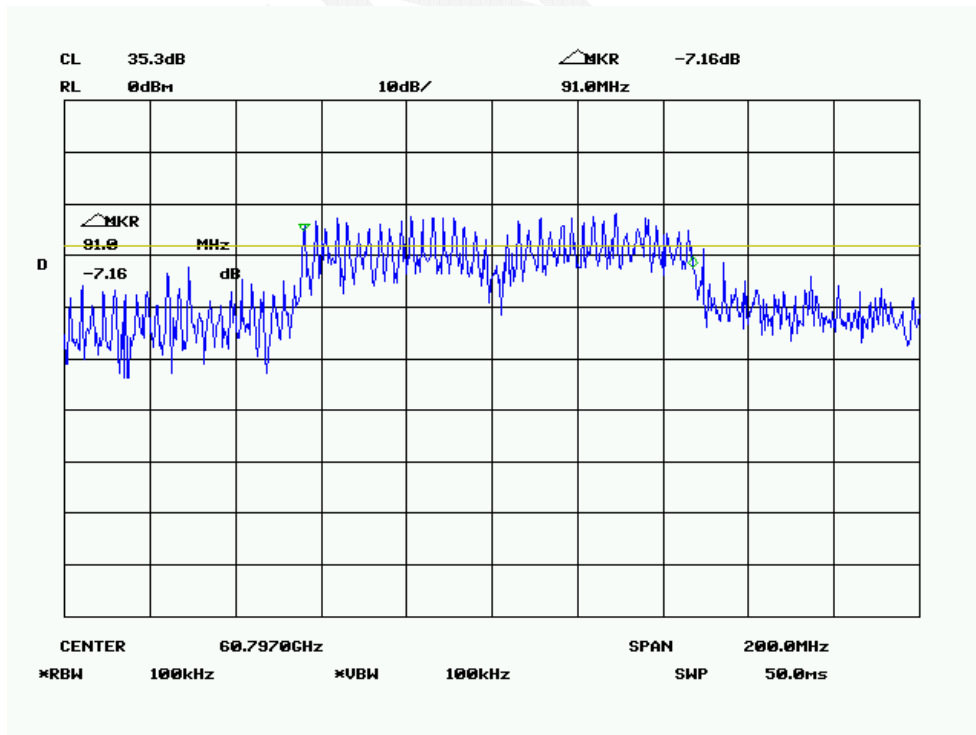

High Channel

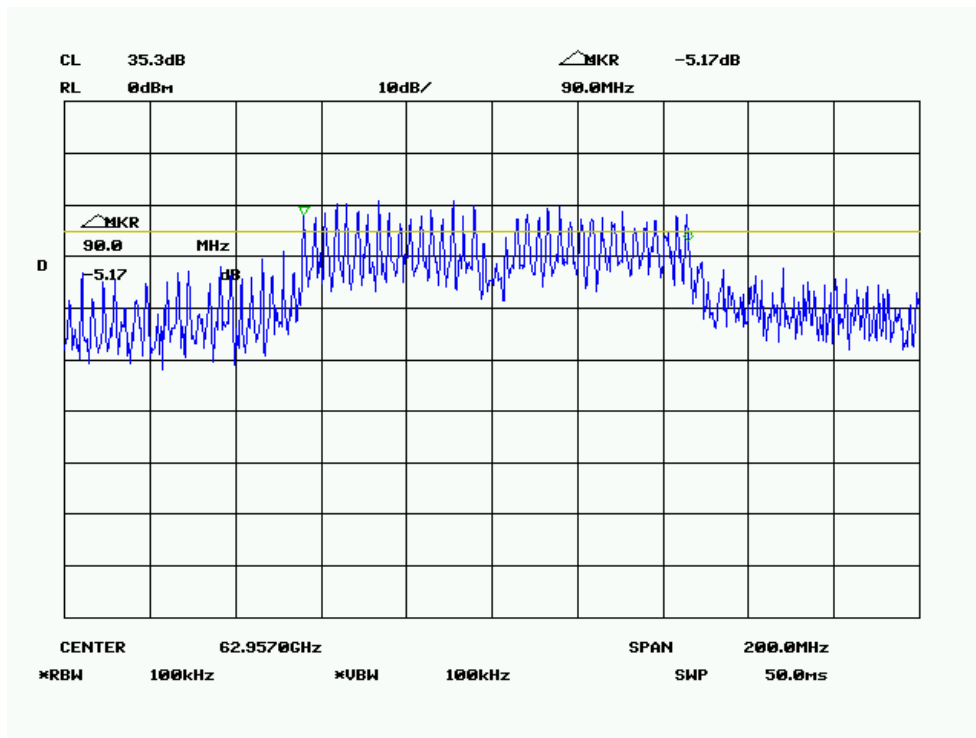

99% Bandwidth

Low Channel

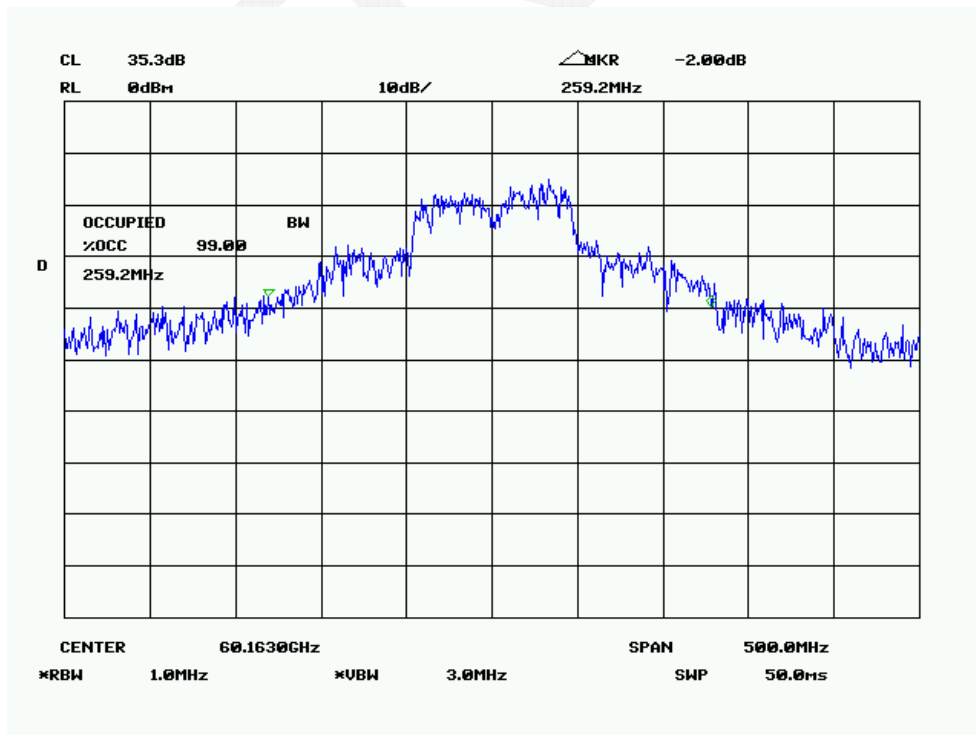

Middle Channel

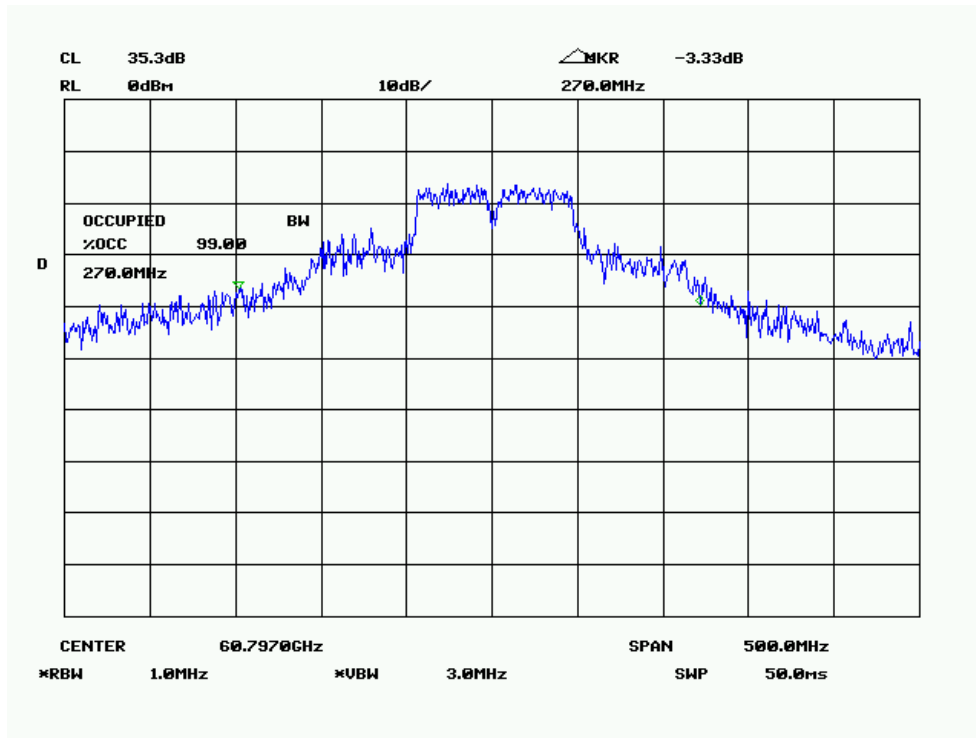

High Channel

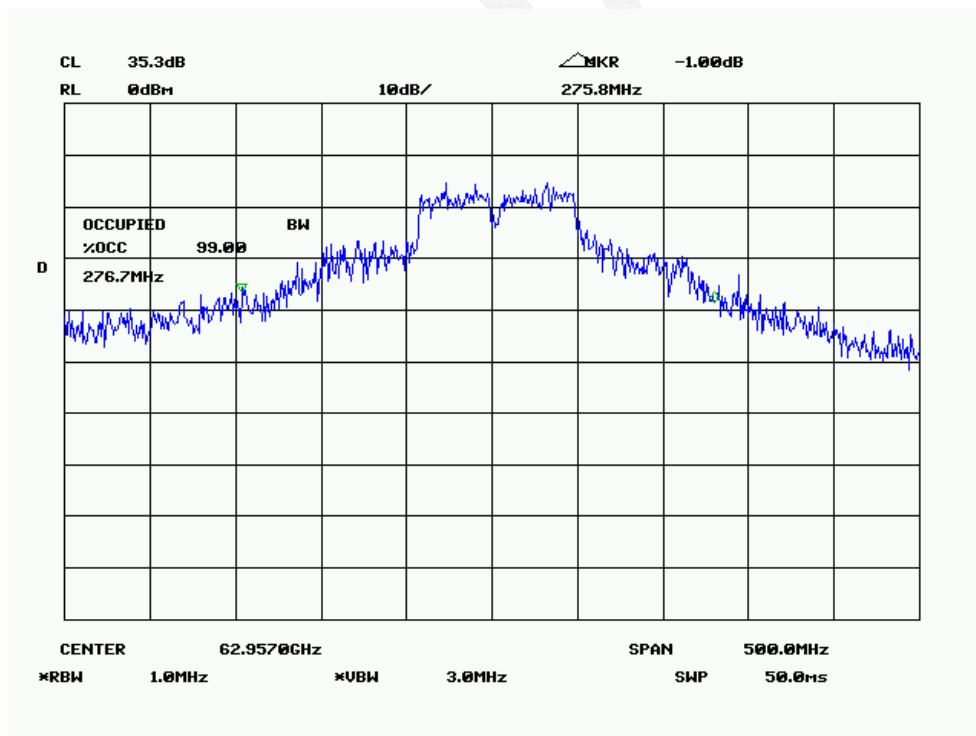

FCC§15.255(e) –PEAK CONDUCTED OUTPUT POWER

Applicable Standard

Except as specified paragraph (e)(1) of this section, the peak transmitter conducted output power shall not exceed 500 mW. Depending on the gain of the antenna, it may be necessary to operate the intentional radiator using a lower peak transmitter output power in order to comply with the EIRP limits specified in paragraph (b) of this section.

(1) Transmitters with an emission bandwidth of less than 100 MHz must limit their peak transmitter conducted output power to the product of 500 mW times their emission bandwidth divided by 100 MHz. For the purposes of this paragraph, emission bandwidth is defined as the instantaneous frequency range occupied by a steady state radiated signal with modulation, outside which the radiated power spectral density never exceeds 6 dB below the maximum radiated power spectral density in the band, as measured with a 100 kHz resolution bandwidth spectrum analyzer. The center frequency must be stationary during the measurement interval, even if not stationary during normal operation (e.g., for frequency hopping devices).

(2) Peak transmitter conducted output power shall be measured with an RF detector that has a detection bandwidth that encompasses the 57-64 GHz band and that has a video bandwidth of at least 10 MHz. Measurement procedures that have been found to be acceptable to the Commission in accordance with §2.947 of this chapter may be used to demonstrate compliance.

(3) For purposes of demonstrating compliance with this paragraph, corrections to the transmitter conducted output power may be made due to the antenna and circuit loss.

Test Procedure

Refer to ANSI C63.10-2013 Clause 9.7 : equation to calculate power output.

Environmental Conditions

Temperature:	21.8 °C
Relative Humidity:	45 %
ATM Pressure:	101.4 kPa

Test Data

Please refer to the following table:

Test Mode: Transmitting

Frequency	Peak EIRP Power	Antenna Gain	Peak conducted power	6dB OBW	Limit	Margin
GHz	dBm	dBi	dBm	MHz	dBm	dB
60.163	28.84	16	12.84	90.3	26.55	13.71
60.797	28.76	16	12.76	91	26.58	13.82
62.957	29.97	16	12.97	90	26.53	13.56

Note 1: The EUT used for integral antenna without temporary RF connector provided, so Peak conducted power is equal to Peak EIRP Power subtract the antenna gain.

Note 2: EIRP Power refer to §15.255 (b)

*Note3: For radiated emissions measurements, calculated transmitter conducted output power P(con)
 $P(con)=EIRP-Antenna\ gain(dBi)$*

Note4: EUT operating in LRP mode with an emission bandwidth of less than 100 MHz , therefore the limit of its peak transmitter conducted output power is: $10\lg(500*(BW/100))\ dBm$
 Here, BW is 6 dB OBW.*

FCC§15.205, §15.209&§15.255(c)- TRANSMITTER SPURIOUS EMISSIONS

Applicable Standard

(c) Limits on spurious emissions:

- (1) The power density of any emissions outside the 57-64 GHz band shall consist solely of spurious emissions.
- (2) Radiated emissions below 40 GHz shall not exceed the general limits in §15.209.
- (3) Between 40 GHz and 200 GHz, the level of these emissions shall not exceed 90 pW/cm^2 at a distance of 3 meters.
- (4) The levels of the spurious emissions shall not exceed the level of the fundamental emission.

Measurement Uncertainty

Compliance or non-compliance with a disturbance limit shall be determined in the following manner:

If U_{lab} is less than or equal to U_{cispr} of Table 1, then:

- compliance is deemed to occur if no measured disturbance level exceeds the disturbance limit;
- non-compliance is deemed to occur if any measured disturbance level exceeds the disturbance limit.

If U_{lab} is greater than U_{cispr} of Table 1, then:

- compliance is deemed to occur if no measured disturbance level, increased by $(U_{\text{lab}} - U_{\text{cispr}})$, exceeds the disturbance limit;
- non-compliance is deemed to occur if any measured disturbance level, increased by $(U_{\text{lab}} - U_{\text{cispr}})$, exceeds the disturbance limit.

Based on CISPR 16-4-2: 2011, measurement uncertainty of radiated emission at a distance of 3m at Bay Area Compliance Laboratories Corp. (Dongguan) is: 30M~200MHz: 4.58 dB for Horizontal, 4.59 dB for Vertical; 200M~1GHz: 4.83 dB for Horizontal, 5.85 dB for Vertical; 1G~6GHz: 4.45 dB, 6G~18GHz: 5.23 dB

Table 1 – Values of U_{cispr}

Measurement	U_{cispr}
Radiated disturbance (electric field strength at an OATS or in a SAC) (30 MHz to 1000 MHz)	6.3 dB
Radiated disturbance (electric field strength in a FAR) (1 GHz to 6 GHz)	5.2 dB
Radiated disturbance (electric field strength in a FAR) (6 GHz to 18 GHz)	5.5 dB

EUT Setup

Below 1 GHz:

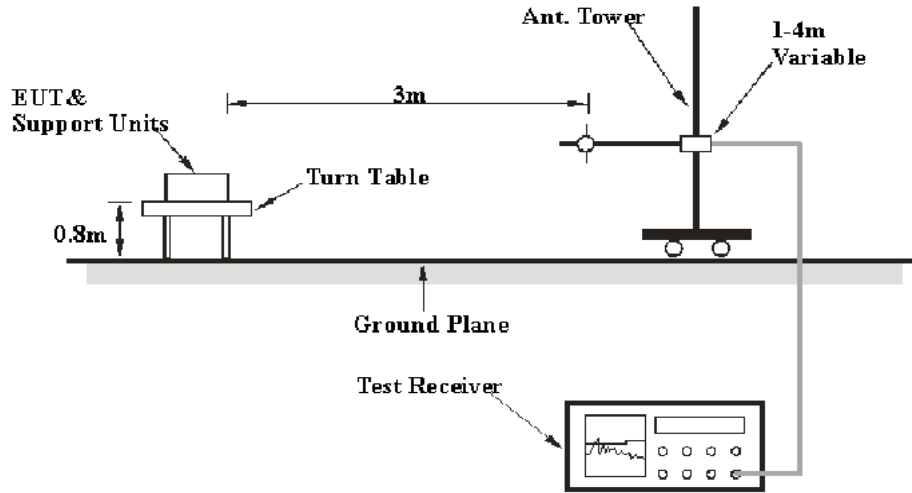

Above 1 GHz:

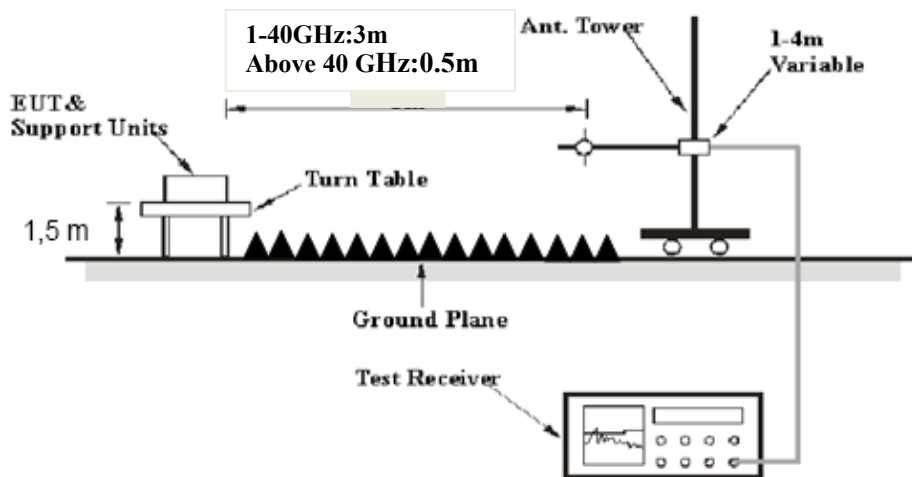

The radiated emission and out of band emission tests were performed in the 3 meters chamber test site, using the setup accordance with the ANSI C63.10-2013 The specification used was the FCC 15.209/15.205 and FCC 15.255 limits.

Test Equipment Setup

The system was investigated from 30 MHz to 200 GHz.

During the radiated emission test, the EMI test receiver & Spectrum Analyzer Setup were set with the following configurations:

Frequency Range	RBW	Video B/W	IF B/W	Detector
30 MHz – 1000 MHz	120 kHz	300 kHz	120 kHz	QP
1-40 GHz	1MHz	3 MHz	/	PK
	1MHz	10 Hz	/	Ave
40 GHz – 200 GHz	1MHz	3 MHz	/	PK

Test Procedure

Refer to ANSI C63.10-2013 Clause 9.9&9.12&9.13

Maximizing procedure was performed on the highest emissions to ensure that the EUT complied with all installation combinations.

All data was recorded in the Quasi-peak detection mode from 30 MHz to 1GHz, peak and average detection mode above 1 GHz to 40 GHz, peak detection mode from 40GHz-200GHz.

Environmental Conditions

Temperature:	21.3 °C
Relative Humidity:	52%
ATM Pressure:	101.4 kPa

Test Data

Please refer to the following table:

Test Mode: Transmitting(USB operating mode is the worst case)

30MHz-1GHz(Middle Channel)

Horizontal

No.	Frequency (MHz)	Reading (dBuV/m)	Detector	Corrected dB/m	Result (dBuV/m)	Limit (dBuV/m)	Margin (dB)
1	30.0000	19.12	QP	3.38	22.50	40.00	17.50
2	108.5700	35.19	QP	-7.59	27.60	43.50	15.90
3	176.4700	32.64	QP	-8.34	24.30	43.50	19.20
4	215.2700	33.84	QP	-9.04	24.80	43.50	18.70
5	296.7500	45.19	QP	-5.99	39.20	46.00	6.80
6	347.1900	41.46	QP	-5.06	36.40	46.00	9.60

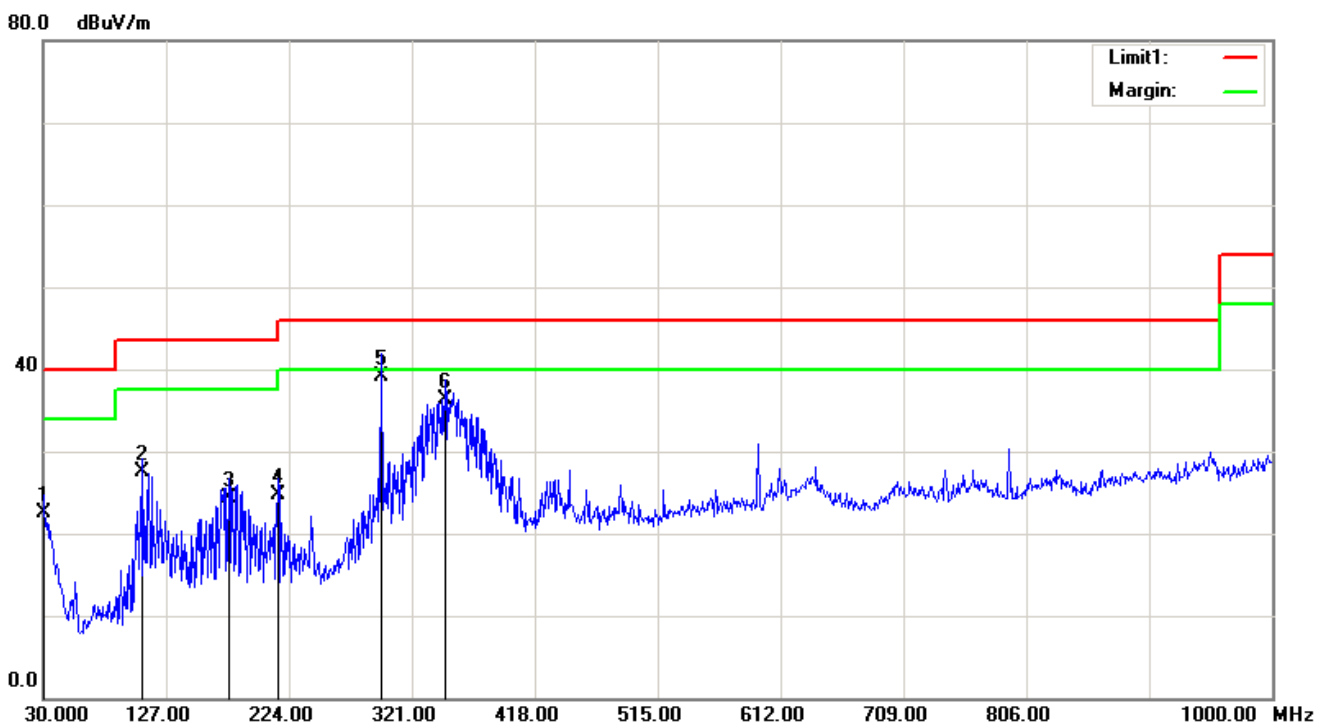

Vertical:

No.	Frequency (MHz)	Reading (dBuV/m)	Detector	Corrected dB/m	Result (dBuV/m)	Limit (dBuV/m)	Margin (dB)
1	30.0000	24.12	QP	3.38	27.50	40.00	12.50
2	215.2700	37.64	QP	-9.04	28.60	43.50	14.90
3	241.4600	40.23	QP	-7.93	32.30	46.00	13.70
4	288.0200	38.80	QP	-6.10	32.70	46.00	13.30
5	359.8000	38.12	QP	-4.52	33.60	46.00	12.40
6	792.4200	30.29	QP	2.11	32.40	46.00	13.60

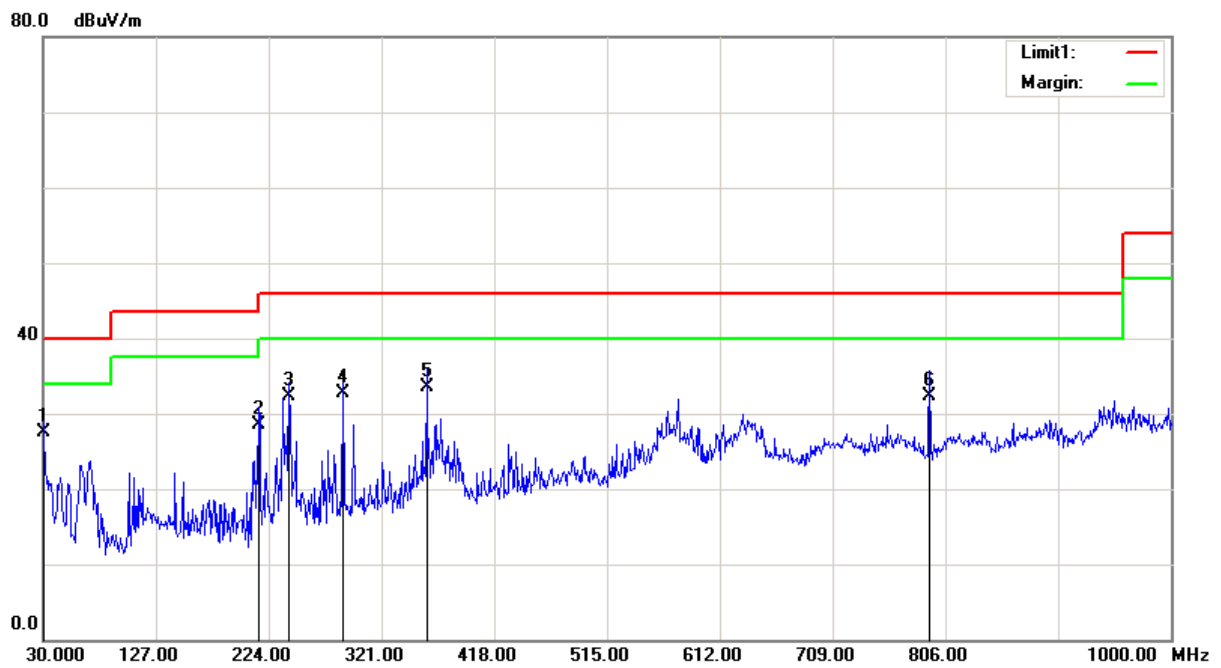

1GHz~40GHz:

Frequency (MHz)	Receiver		Rx Antenna		Cable loss (dB)	Amplifier Gain (dB)	Corrected Amplitude (dBµV/m)	Limit (dBµV/m)	Margin (dB)
	Reading (dBµV)	Detector	Polar (H/V)	Factor (dB(1/m))					
Frequency: 60163 MHz									
1782	46.7	PK	H	26.89	2.61	27.56	48.64	74.00	25.36
1782	34.55	AV	H	26.89	2.61	27.56	36.49	54.00	17.51
2079.5	42.39	PK	H	27.69	3.30	27.40	45.98	74.00	28.02
2079.5	30.12	AV	H	27.69	3.30	27.40	33.71	54.00	20.29
2963.5	38.05	PK	H	30.65	6.66	27.54	47.82	74.00	26.18
2963.5	25.87	AV	H	30.65	6.66	27.54	35.64	54.00	18.36
24920	42.33	PK	H	35.68	14.98	36.72	56.27	74.00	17.73
24920	30.18	AV	H	35.68	14.98	36.72	44.12	54.00	9.88
24130	41.83	PK	H	35.40	14.01	37.08	54.16	74.00	19.84
24130	29.62	AV	H	35.40	14.01	37.08	41.95	54.00	12.05
Frequency: 60797MHz									
1782	46.5	PK	H	26.89	2.61	27.56	48.44	74.00	25.56
1782	34.26	AV	H	26.89	2.61	27.56	36.20	54.00	17.80
2079.5	42.11	PK	H	27.69	3.30	27.40	45.70	74.00	28.30
2079.5	30.25	AV	H	27.69	3.30	27.40	33.84	54.00	20.16
2963.5	37.24	PK	H	30.65	6.66	27.54	47.01	74.00	26.99
2963.5	24.19	AV	H	30.65	6.66	27.54	33.96	54.00	20.04
24920	43.22	PK	H	35.68	14.98	36.72	57.16	74.00	16.84
24920	31.29	AV	H	35.68	14.98	36.72	45.23	54.00	8.77
24130	42.26	PK	H	35.40	14.01	37.08	54.59	74.00	19.41
24130	28.72	AV	H	35.40	14.01	37.08	41.05	54.00	12.95
Frequency: 62957MHz									
1782	45.22	PK	H	26.89	2.61	27.56	47.16	74.00	26.84
1782	36.02	AV	H	26.89	2.61	27.56	37.96	54.00	16.04
2079.5	41.97	PK	H	27.69	3.30	27.40	45.56	74.00	28.44
2079.5	30.58	AV	H	27.69	3.30	27.40	34.17	54.00	19.83
2963.5	34.26	PK	H	30.65	6.66	27.54	44.03	74.00	29.97
2963.5	26.94	AV	H	30.65	6.66	27.54	36.71	54.00	17.29
24920	42.1	PK	H	35.68	14.98	36.72	56.04	74.00	17.96
24920	29.59	AV	H	35.68	14.98	36.72	43.53	54.00	10.47
24130	41.26	PK	H	35.40	14.01	37.08	53.59	74.00	20.41
24130	29.41	AV	H	35.40	14.01	37.08	41.74	54.00	12.26

Note 1: The Corrected Amplitude is calculated by adding the Antenna Factor and Cable Loss, and subtracting the Amplifier Gain from the Meter Reading. The basic equation is as follows:

$$\text{Corrected Amplitude} = \text{Meter Reading} + \text{Antenna Factor} + \text{Cable Loss} - \text{Amplifier Gain}$$

Note 2: The "Margin" column of the following data tables indicates the degree of compliance with the applicable limit. For example, a margin of 7dB means the emission is 7dB below the limit. The equation for margin calculation is as follows:

$$\text{Margin} = \text{Limit} - \text{Corrected Amplitude}$$

40GHz~200GHz:

Frequency	Receiver		Rx Antenna		Corrected Amplitude	EIPR Power	Power Density	Limit
	Reading	Detector	Polar	Factor				
GHz	dBµV	PK/QP/AV	H/V	dB(1/m)	dBµV/m	dBm	pW/cm ²	pW/cm ²
Frequency: 60163 MHz								
50.8	40.65	PK	H	40.88	81.53	-29.19	1.0659	90.00
88.94	51.57	PK	H	48.00	99.57	-11.15	67.8747	90.00
Frequency: 60797MHz								
50.8	40.55	PK	H	40.88	81.43	-29.29	1.0416	90.00
88.94	51.29	PK	H	48.00	99.29	-11.43	63.6367	90.00
Frequency: 62957MHz								
50.8	40.21	PK	H	40.88	81.09	-29.63	0.9632	90.00
88.94	52.28	PK	H	48.00	100.28	-10.44	79.9296	90.00

Note 1:

$$EIRP = E\text{-meas} + 20\log(d\text{-meas}) - 104.7$$

where:

EIRP : is the equivalent isotropically radiated power, in dBm

E-meas. : is the field strength of the emission at the measurement distance, in dBµV/m

d-meas. : is the measurement distance, in m

Note 2: The test distance is 0.5 m.

Note 3: Corrected Amplitude = Meter Reading + Antenna Factor

Note 4: The Mixers and its RF cables is compose a system for calibration, the conversion factor was added into the test Spectrum Analyzer in testing.

Note 5:

$$PD = \frac{EIRP_{Linear}}{4\pi d^2}$$

where

PD is the power density at the distance specified by the limit, in W/m²

EIRP_{Linear} is the equivalent isotropically radiated power, in watts

d is the distance at which the power density limit is specified, in m

The Specified distance is 3m.

FCC§15.255(f) - FREQUENCY STABILITY

Applicable Standard

Fundamental emissions must be contained within the frequency bands specified in this section during all conditions of operation. Equipment is presumed to operate over the temperature range -20 to +50 degrees Celsius with an input voltage variation of 85% to 115% of rated input voltage, unless justification is presented to demonstrate otherwise.

Test Procedure

Refer to ANSI C63.10-2013 Clause 9.14

Environmental Conditions

Temperature:	21.6°C
Relative Humidity:	48 %
ATM Pressure:	101.4 kPa

Test Data

Please refer to the following table:

Temperature	Voltage	Frequency (MHz)			
		f _L at Low Channel	f _H at High Channel	f _L Limit	f _H Limit
°C	V _{DC}				
-20	12	60118	63005	57000	64000
-10	12	60117	63004	57000	64000
0	12	60120	63002	57000	64000
10	12	60116	63006	57000	64000
20	12	60118	63007	57000	64000
30	12	60119	63001	57000	64000
40	12	60121	63009	57000	64000
50	12	60118	63003	57000	64000
25	7.4	60117	63005	57000	64000
25	18	60115	63004	57000	64000

FCC§15.255(d) – PUBLICLY-ACCESSIBLE COORDINATION CHANNEL

Applicable Standard

Only spurious emissions and transmissions related to a publicly-accessible coordination channel, whose purpose is to coordinate operation between diverse transmitters with a view towards reducing the probability of interference throughout the 57-64 GHz band, are permitted in the 57-57.05 GHz band.

Note to paragraph (d): The 57-57.05 GHz is reserved exclusively for a publicly-accessible coordination channel. The development of standards for this channel shall be performed pursuant to authorizations issued under part 5 of this chapter.

Test Procedure

Refer to ANSI C63.10-2013 Clause 9.12

Test result

NO emission was detected within 57-57.05GHz band.

§15.255(a) (h)– OPERATION RESTRICTION AND GROUP INSTALLTION

Applicable Standard

§15.255 (a) Operation under the provisions of this section is not permitted for the following products:

- (1) Equipment used on aircraft or satellites.
- (2) Field disturbance sensors, including vehicle radar systems, unless the field disturbance sensors are employed for fixed operation. For the purposes of this section, the reference to fixed operation includes field disturbance sensors installed in fixed equipment, even if the sensor itself moves within the equipment.

§15.255 (h) Any transmitter that has received the necessary FCC equipment authorization under the rules of this chapter may be mounted in a group installation for simultaneous operation with one or more other transmitter(s) that have received the necessary FCC equipment authorization, without any additional equipment authorization. However, no transmitter operating under the provisions of this section may be equipped with external phase-locking inputs that permit beam-forming arrays to be realized.

Result of Operation Restriction

Manufacturer declares that EUT will not be used on aircraft or satellites. Then user manual will include a statement to caution EUT is not permitted for use on aircraft or satellites. EUT is a wireless video area network (WVAN) for the connection of consumer electronic (CE) audio and video devices.

Result of Group installation

The frequency, amplitude and phase of the transmit signal are set within the EUT. There are no external phase-locking inputs or any other means of combining two or more units together to realize a beam-forming array.

******* END OF REPORT *******