



# RF TEST REPORT

**Applicant** ZTE Corporation

**FCC ID** SRQ-ZTEBLADEA530

**Product** LTE/WCDMA/GSM(EDGE,GPRS)  
Multi-Mode Digital Mobile Phone

**Model** BLADE A530

**Marketing** BLADE A530, ZTE BLADE A530,  
A530, ZTE Blade A530, Blade A530

**Report No.** R1803A0100-R5V1

**Issue Date** April 20, 2018

TA Technology (Shanghai) Co., Ltd. tested the above equipment in accordance with the requirements in **FCC CFR47 Part 15C (2017)**. The test results show that the equipment tested is capable of demonstrating compliance with the requirements as documented in this report.

Performed by: Xianqing Li

Approved by: Kai Xu

---

**TA Technology (Shanghai) Co., Ltd.**

No.145, Jintang Rd, Tangzhen Industry Park, Pudong Shanghai, China

TEL: +86-021-50791141/2/3

FAX: +86-021-50791141/2/3-8000

## Table of Contents

1	Test Laboratory.....	4
1.1	Notes of the Test Report.....	4
1.2	Test facility.....	4
1.3	Testing Location.....	5
2	General Description of Equipment under Test.....	6
3	Applied Standards.....	8
4	Information about the FHSS characteristics.....	10
4.1	Pseudorandom Frequency Hopping Sequence.....	10
4.2	Equal Hopping Frequency Use.....	11
4.3	System Receiver Input Bandwidth.....	11
4.4	Test Configuration.....	11
5	Test Case Results.....	12
5.1	Peak Power Output –Conducted.....	12
5.2	Occupied Bandwidth (20dB).....	14
5.3	Frequency Separation.....	18
5.4	Time of Occupancy (Dwell Time).....	20
5.5	Band Edge Compliance.....	22
5.6	Spurious Radiated Emissions in the Restricted Band.....	25
5.7	Number of hopping Frequency.....	28
5.8	Spurious RF Conducted Emissions.....	30
5.9	Radiates Emission.....	32
5.10	Conducted Emission.....	42
6	Main Test Instruments.....	44

## Summary of Measurement Results

Number	Summary of measurements of results	Clause in FCC rules	Verdict
1	Peak Power Output -Conducted	15.247(b)(1)	PASS
2	Occupied Bandwidth (20dB)	15.247(a)(1)	PASS
3	Frequency Separation	15.247(a)(1)	PASS
4	Time of Occupancy (Dwell Time)	15.247(a)(1)(iii)	PASS
5	Band Edge Compliance	15.247(d)	PASS
6	Spurious Radiated Emissions in the restricted band	15.247(d),15.205,15.209	PASS
7	Number of Hopping Frequency	15.247(a)(1)(iii)	PASS
8	Spurious RF Conducted Emissions	15.247(d)	PASS
9	Radiates Emission	15.247(d),15.205,15.209	PASS
10	AC Power Line Conducted Emission	15.207	PASS
Date of Testing: January 17, 2018~ February 1, 2018			

# 1 Test Laboratory

## 1.1 Notes of the Test Report

This report shall not be reproduced in full or partial, without the written approval of **TA technology (shanghai) co., Ltd.** The results documented in this report apply only to the tested sample, under the conditions and modes of operation as described herein .Measurement Uncertainties were not taken into account and are published for informational purposes only. This report is written to support regulatory compliance of the applicable standards stated above.

## 1.2 Test facility

### **CNAS (accreditation number: L2264)**

TA Technology (Shanghai) Co., Ltd. has obtained the accreditation of China National Accreditation Service for Conformity Assessment (CNAS).

### **FCC (Designation number: CN1179, Test Firm Registration Number: 446626)**

TA Technology (Shanghai) Co., Ltd. has been listed on the US Federal Communications Commission list of test facilities recognized to perform electromagnetic emissions measurements.

### **IC (recognition number is 8510A)**

TA Technology (Shanghai) Co., Ltd. has been listed by industry Canada to perform electromagnetic emission measurement.

### **VCCI (recognition number is C-4595, T-2154, R-4113, G-10766)**

TA Technology (Shanghai) Co., Ltd. has been listed by industry Japan to perform electromagnetic emission measurement.

### **A2LA (Certificate Number: 3857.01)**

TA Technology (Shanghai) Co., Ltd. has been listed by American Association for Laboratory Accreditation to perform electromagnetic emission measurement.

### 1.3 Testing Location

Company: TA Technology (Shanghai) Co., Ltd.  
Address: No.145, Jintang Rd, Tangzhen Industry Park, Pudong Shanghai, China  
City: Shanghai  
Post code: 201201  
Country: P. R. China  
Contact: Xu Kai  
Telephone: +86-021-50791141/2/3  
Fax: +86-021-50791141/2/3-8000  
Website: <http://www.ta-shanghai.com>  
E-mail: [xukai@ta-shanghai.com](mailto:xukai@ta-shanghai.com)

## 2 General Description of Equipment under Test

### Client Information

<b>Applicant</b>	ZTE Corporation
<b>Applicant address</b>	ZTE Plaza, Keji Road South, Hi-Tech, Industrial Park, Nanshan District, Shenzhen, Guangdong, 518057, P.R.China
<b>Manufacturer</b>	ZTE Corporation
<b>Manufacturer address</b>	ZTE Plaza, Keji Road South, Hi-Tech, Industrial Park, Nanshan District, Shenzhen, Guangdong, 518057, P.R.China

### General information

EUT Description			
Model	BLADE A530		
IMEI	SIM 1: 867670030007217 SIM 2: 867670030007712		
Hardware Version	uecB		
Software Version	CLA_CL_BLADE_A530V1.0.0		
Power Supply	Battery/AC adapter		
Antenna Type	Internal Antenna		
Antenna Connector	A permanently attached antenna (meet with the standard FCC Part 15.203 requirement)		
Antenna Gain	2.81 dBi		
Test Mode(s)	Basic Rate	Enhanced Data Rate(EDR)	
Modulation Type	Frequency Hopping Spread Spectrum (FHSS)		
	GFSK	$\pi/4$ DQPSK	8DPSK
Packet Type (Maximum Payload)	DH5	2DH5	3DH5
Max. Conducted Power	5.59dBm		
Operating Frequency Range(s)	2400 ~ 2483.5 MHz		

<b>EUT Accessory</b>	
Adapter 1	Manufacturer: SHENZHEN RUIJING INDUSTRIAL CO LTD Model: STC-A51A-Z
Adapter 2	Manufacturer: DONGGUAN AOHAI POWER TECHNOLOGY CO., LTD. Model: STC-A51A-Z
Adapter 3	Manufacturer: Jiangsu Chenyang Electron Co., Ltd. Model: STC-A51A-Z
Adapter 4	Manufacturer: SHENZHEN RUIJING INDUSTRIAL CO LTD Model: STC-A51A-A
Battery 1	Manufacturer: Zhongshan Tianmao Battery Co., Ltd. Model: Li3826T43P4h705949
Battery 2	Manufacturer: Jiade Energy Technology (Zhuhai) Co., Ltd. Model: Li3826T43P4h705949
Earphone 1	Manufacturer: Shenzhen FDC Electronics Co., Ltd. Model: DEM-53
Earphone 2	Manufacturer: SANGFAI ELECTRICAL MANUFACTURE LIMITED Model: SF-880KM-53
USB Cable	Manufacturer: kingpower-tech 100cm Cable, Shielded
<p>Note: 1. The information of the EUT is declared by the manufacturer.</p> <p>2. There is more than one Adapter, Battery and Earphone, each one should be applied throughout the compliance test respectively, and however, only the worst case (Adapter 1, Battery 1 and Earphone 1) will be recorded in this report.</p>	

**BLADE A530 (R1803A0100-R5V1) is a variant model of BLADE A530 (R1801A0031-R5V1). Test items tested see the table below. The detailed product change description please refers to the FCC Class II Permission Change Letter.**

<b>Test items</b>	<b>Original (R1801A0031-R5V1)</b>	<b>Variant (R1803A0100-R5V1)</b>
Peak Power Output –Conducted	pass	Refer to the Original
Occupied Bandwidth (20dB)	pass	Refer to the Original
Frequency Separation	pass	Refer to the Original
Time of Occupancy (Dwell Time)	pass	Refer to the Original
Band Edge Compliance	pass	Refer to the Original
Spurious Radiated Emissions in the Restricted Band	pass	Refer to the Original
Number of hopping Frequency	pass	Refer to the Original
Spurious RF Conducted Emissions	pass	Refer to the Original
Radiated Emissions	pass	Only tested the worst case of Original
Conducted Emissions	pass	Only tested the worst case of Original

For variant BLADE A530 (R1803A0100-R5), the difference between Configure 1 and Configure 2 is show in the below table:

	<b>Configure 1</b>	<b>Configure 2</b>
SIM card slot	1* SIM card slot	2* SIM card slot
Other	Same	Same



### 3 Applied Standards

According to the specifications of the manufacturer, it must comply with the requirements of the following standards:

#### Test standards

- **FCC CFR47 Part 15C (2017) Radio Frequency Devices**
- **ANSI C63.10 (2013)**
- **DA00-705 Filing and Frequency Measurement Guidelines For Frequency Hopping Spread Spectrum System (2000).**

## 4 Information about the FHSS characteristics

### 4.1 Pseudorandom Frequency Hopping Sequence

Frequency Hopping Systems. A spread spectrum system in which the carrier is modulated with the coded information in a conventional manner causing a conventional spreading of the RF energy about the frequency carrier. The frequency of the carrier is not fixed but changes at fixed intervals under the direction of a coded sequence. The wide RF bandwidth needed by such a system is not required by spreading of the RF energy about the carrier but rather to accommodate the range of frequencies to which the carrier frequency can hop. The test of a frequency hopping system is that the near term distribution of hops appears random, the long term distribution appears evenly distributed over the hop set, and sequential hops are randomly distributed in both direction and magnitude of change in the hop set.

The selection scheme chooses a segment of 32 hop frequencies spanning about 64 MHz and visits these hops in a pseudo-random order. Next, a different 32-hop segment is chosen, etc. In the page, master page response, slave page response, page scan, inquiry, inquiry response and inquiry scan hopping sequences, the same 32-hop segment is used all the time (the segment is selected by the address; different devices will have different paging segments).

When the basic channel hopping sequence is selected, the output constitutes a pseudo-random sequence that slides through the 79 hops. The principle is depicted in the figure below.

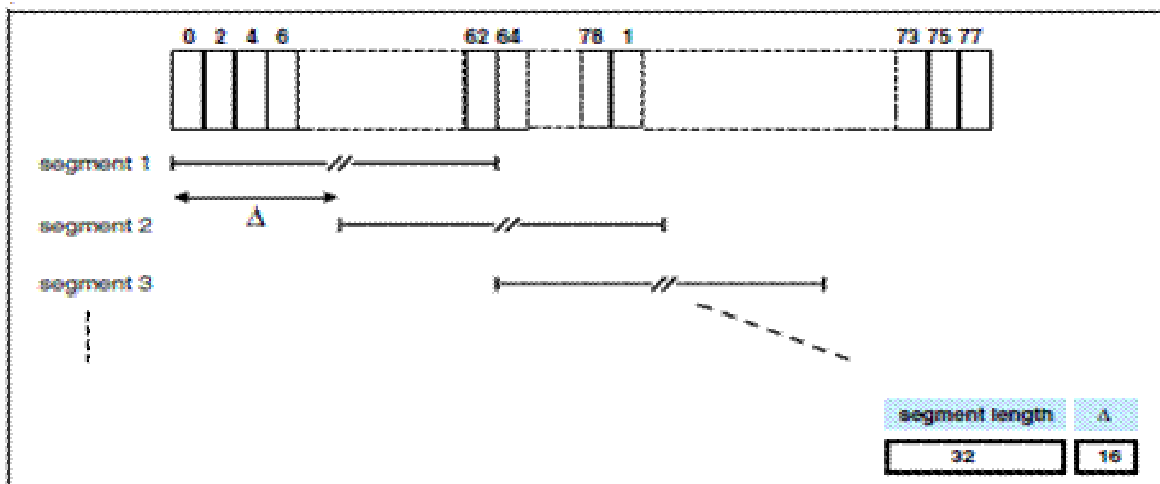

Hop selection scheme in CONNECTION state.

Pseudorandom Frequency Hopping Sequence Table as below:

Channel: 08, 24, 40, 56, 40, 56, 72, 09, 01, 09, 33, 41, 33, 41, 65, 73, 53, 69, 06, 22, 04, 20, 36, 52, 38, 46, 70, 78, 68, 76, 21, 29, 10, 26, 42, 58, 44, 60, 76, 13, 03, 11, 35, 43, 37, 45, 69, 77, 55, 71, 08, 24, 08, 24, 40, 56, 40, 48, 72, 01, 72, 01, 25, 33, 12, 28, 44, 60, 42, 58, 74, 11, 05, 13, 37, 45, etc.

Each frequency used equally on the average by each transmitter.

The system receiver have input bandwidths that match the hopping channel bandwidths of their corresponding transmitters and shift frequencies in synchronization with the transmitted signals.

## 4.2 Equal Hopping Frequency Use

All Bluetooth units participating in the Pico net are time and hop-synchronized to the channel. Each new transmission event begins on the next channel in the hopping sequence after the final channel used in the previous transmission event.

## 4.3 System Receiver Input Bandwidth

Each channel bandwidth is 1MHz. The system receivers have input bandwidths that match the hopping channel bandwidths of their corresponding transmitters and shift frequencies in synchronization with the transmitted signals.

## 4.4 Test Configuration

The EUT has been associated with peripherals and configuration operated in a manner tended to maximize its emission characteristics in a typical application.

The radiated emission was measured in the following position: EUT stand-up position (Z axis), lie-down position (X, Y axis). The worst emission was found in lie-down position (X axis) and the worst case was recorded.

Test Cases	Test Modes
Peak Power Output -Conducted	DH5/2DH5/3DH5
Occupied Bandwidth (20dB)	DH5/2DH5/3DH5
Frequency Separation	DH5/2DH5/3DH5
Time of Occupancy (Dwell Time)	DH5/2DH5/3DH5
Band Edge Compliance	DH5/2DH5/3DH5
Spurious Radiated Emissions in the restricted band	3DH5
Number of Hopping Frequency	DH5/2DH5/3DH5
Spurious RF Conducted Emissions	3DH5
Radiates Emission	3DH5
Conducted Emission	3DH5

## 5 Test Case Results

### 5.1 Peak Power Output –Conducted

#### Ambient condition

Temperature	Relative humidity	Pressure
23°C ~25°C	45%~50%	101.5kPa

#### Methods of Measurement

During the process of the testing, The EUT was connected to the spectrum analyzer and Bluetooth test set via a power splitter with a known loss. The EUT is controlled by the Bluetooth test set to ensure max power transmission with proper modulation. The peak detector is used. RBW is set to 2 MHz; VBW is set to 6 MHz. These measurements have been tested at following channels: 0, 39, and 78.

#### Test Setup

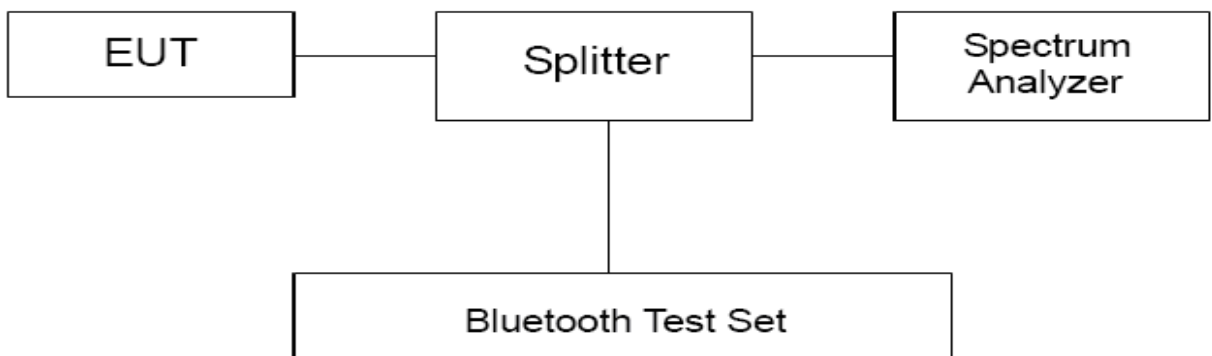

#### Limits

Rule Part 15.247 (b) (1) specifies that " For frequency hopping systems operating in the 2400–2483.5 MHz band employing at least 75 non-overlapping hopping channels, and all frequency hopping systems in the 5725–5850 MHz band: 1 watt. For all other frequency hopping systems in the 2400–2483.5 MHz band: 0.125 watts."

Peak Output Power	$\leq 0.125W$ (21dBm)
-------------------	-----------------------

#### Measurement Uncertainty

The assessed measurement uncertainty to ensure 95% confidence level for the normal distribution is with the coverage factor  $k = 2$ ,  $U=0.44$  dB.

**Test Results**

Channel	Frequency (MHz)	Peak Output Power (dBm)			Conclusion
		DH5	2DH5	3DH5	
0	2402	5.33	5.34	5.59	PASS
39	2441	4.58	4.52	4.76	PASS
78	2480	4.68	4.70	4.94	PASS

Note: The measured power density (dBm) has the offset with cable loss already.

## 5.2 Occupied Bandwidth (20dB)

### Ambient condition

Temperature	Relative humidity	Pressure
23°C ~25°C	45%~50%	101.5kPa

### Method of Measurement

The EUT was connected to the spectrum analyzer and Bluetooth test set via a power splitter with a known loss. The occupied bandwidth is measured using spectrum analyzer. RBW is set to 30kHz and VBW is set to 100kHz on spectrum analyzer. -20dB occupied bandwidths are recorded.

### Test Setup

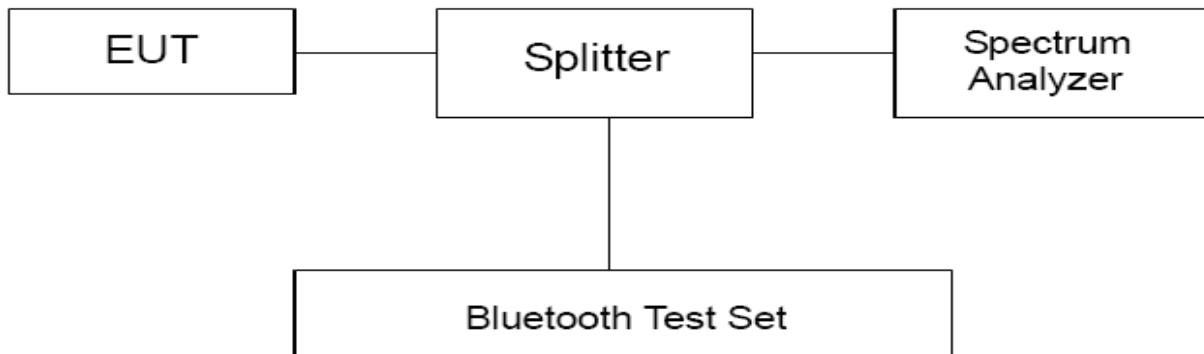

### Limits

No specific occupied bandwidth requirements in part 15.247(a) (1).

### Measurement Uncertainty

The assessed measurement uncertainty to ensure 95% confidence level for the normal distribution is with the coverage factor  $k = 2$ ,  $U=936$  Hz.

**Test Results**

Mode		Channel	Frequency (MHz)	99% bandwidth(kHz)	20dB Bandwidth(kHz)
BT	DH5	0	2402	998.17	1042
		39	2441	998.84	1042
		78	2480	999.56	1043
	2DH5	0	2402	1170.30	1272
		39	2441	1169.70	1270
		78	2480	1168.40	1277
	3DH5	0	2402	1177.40	1276
		39	2441	1167.60	1262
		78	2480	1167.40	1260

BT DH5 CH0, Carrier frequency (MHz): 2402

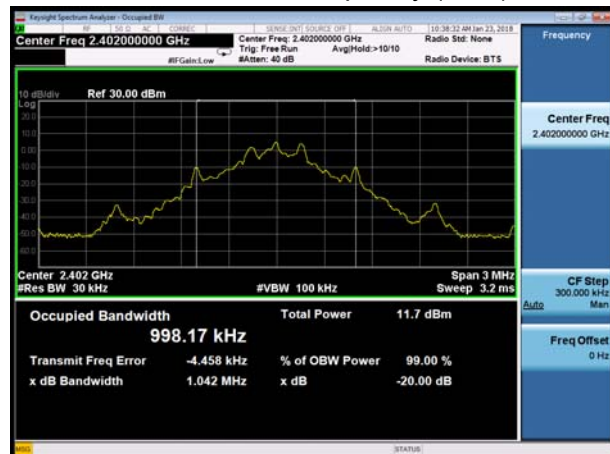

BT 2DH5 CH0, Carrier frequency (MHz): 2402

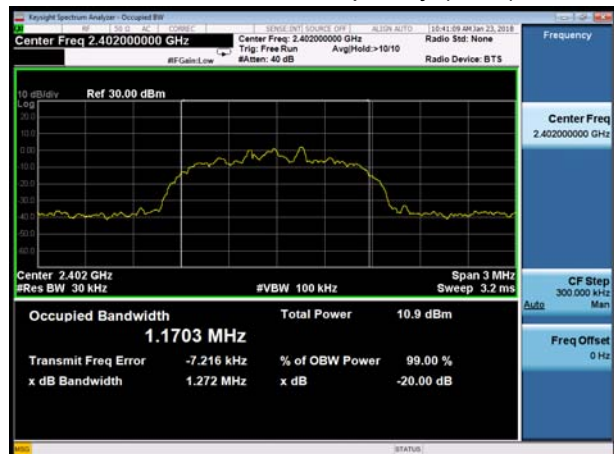

BT DH5 CH39, Carrier frequency (MHz): 2441

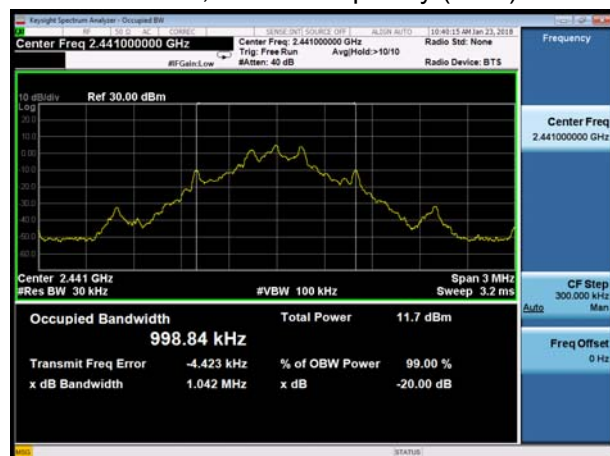

BT 2DH5 CH39, Carrier frequency (MHz): 2441



BT DH5 CH78, Carrier frequency (MHz): 2480



BT 2DH5 CH78, Carrier frequency (MHz): 2480







BT 3DH5 CH0, Carrier frequency (MHz): 2402



BT 3DH5 CH39, Carrier frequency (MHz): 2441

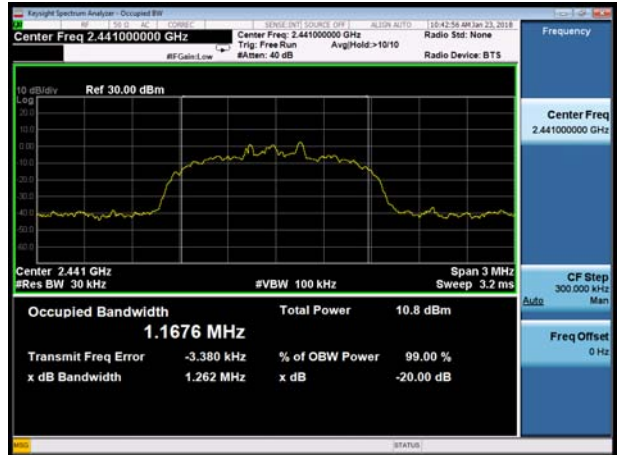

BT 3DH5 CH78, Carrier frequency (MHz): 2480

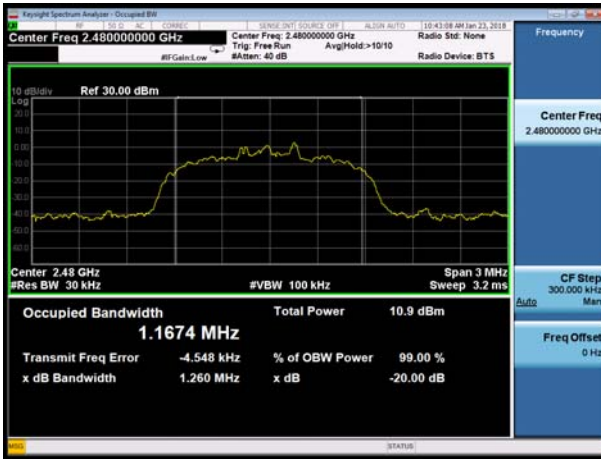

### 5.3 Frequency Separation

#### Ambient condition

Temperature	Relative humidity	Pressure
23°C ~25°C	45%~50%	101.5kPa

#### Method of Measurement

The EUT was connected to the spectrum analyzer and Bluetooth test set via a power splitter with a known loss. RBW is set to 30 kHz and VBW is set to 100 kHz on spectrum analyzer. Set EUT on Hopping on mode.

#### Test setup

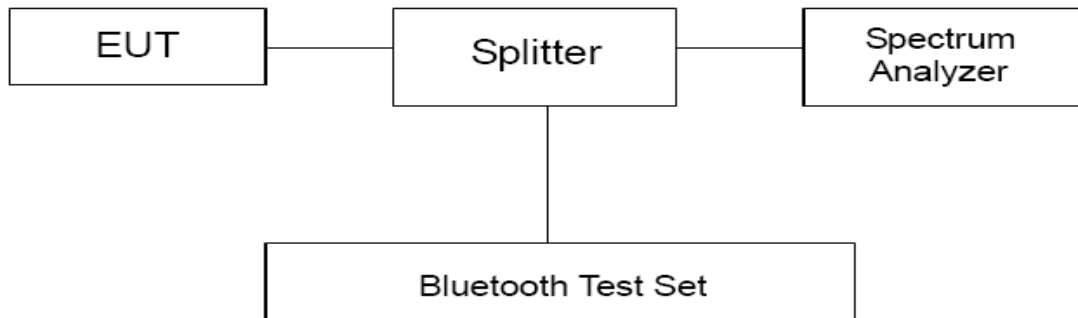

#### Limits

Rule Part 15.247(a)(1) specifies that “Frequency hopping systems shall have hopping channel carrier frequencies separated by a minimum of 25 kHz or the 20 dB bandwidth of the hopping channel, whichever is greater. Alternatively, frequency hopping systems operating in the 2400–2483.5 MHz band may have hopping channel carrier frequencies that are separated by 25 kHz or two-thirds of the 20 dB bandwidth of the hopping channel, whichever is greater, provided the systems operate with an output power no greater than 125 mW. ”

Note: The value of two-thirds of 20 dB bandwidth is always greater than 25 kHz.

#### Measurement Uncertainty

The assessed measurement uncertainty to ensure 95% confidence level for the normal distribution is with the coverage factor  $k = 2$ ,  $U=936$  Hz.

Test Results:

Packet type	Carrier frequency (MHz)	Carrier frequency separation(kHz)	20dB Bandwidth(kHz)	Limit (kHz)	Conclusion
DH5	2441	999	1042	694.67	PASS
2DH5	2441	999	1270	846.67	PASS
3DH5	2441	1005	1262	841.33	PASS

Note: The limit is two-thirds of 20 dB bandwidth.

BT DH5 CH39, Carrier frequency (MHz): 2441



BT 2DH5 CH39, Carrier frequency (MHz): 2441



BT 3DH5 CH39, Carrier frequency (MHz): 2441



### 5.4 Time of Occupancy (Dwell Time)

#### Ambient condition

Temperature	Relative humidity	Pressure
23°C ~25°C	45%~50%	101.5kPa

#### Methods of Measurement

The EUT was connected to the spectrum analyzer and Bluetooth test set via a power splitter with a known loss. RBW is set to 1MHz and VBW is set to 1MHz on spectrum analyzer. The dwell time is calculated by:

Dwell time = time slot length \* hop rate \* 0.4s with:

The selected EUT Packet type uses a slot type of DH5 packet and a hopping rate of 1600(ch\*hop/s) for all channels. So the final hopping rate for all channel is 1600/5=320(ch\*hop/s)

#### Test Setup

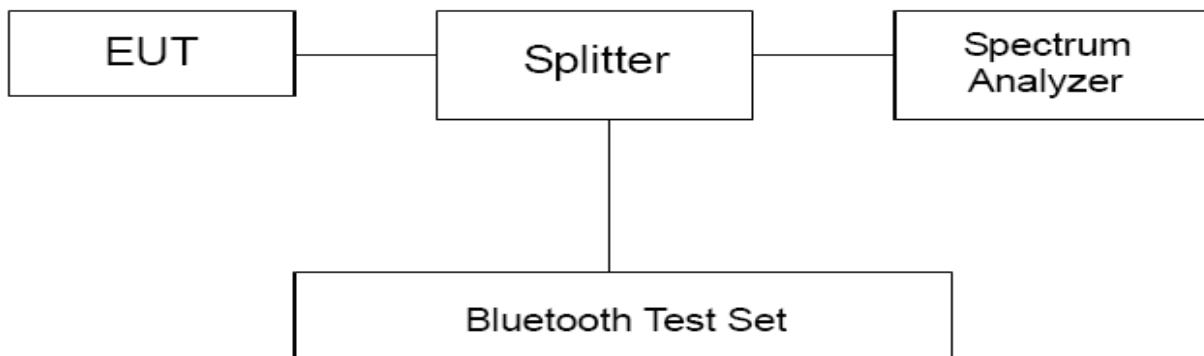

#### Limits

Rule Part15.247(a) specifies that " Frequency hopping systems in the 2400–2483.5 MHz band shall use at least 15 channels. The average time of occupancy on any channel shall not be greater than 0.4 seconds within a period of 0.4 seconds multiplied by the number of hopping channels employed."

Dwell time	≤ 400ms
------------	---------

#### Measurement Uncertainty

The assessed measurement uncertainty to ensure 95% confidence level for the normal distribution is with the coverage factor  $k = 2$ .

Requirements	Uncertainty					
Dwell Time	DH5	$U=0.70ms$	2DH5	$U=0.70ms$	3DH5	$U=0.70ms$

Test Results:

Channel 39					
Packet type	hop rate (1/s)	Time slot length(ms)	Dwell time (ms)	Limit (ms)	Conclusion
DH5	266.67	2.880	307.204	400	PASS
2DH5	266.67	2.880	307.204	400	PASS
3DH5	266.67	2.880	307.204	400	PASS

Note: Dwell time = time slot length \* hop rate \* 0.4s

BT DH5 CH39, Carrier frequency (MHz): 2441

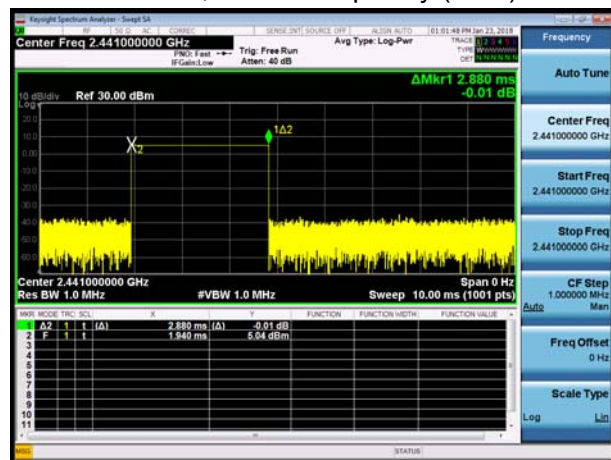

BT 2DH5 CH39, Carrier frequency (MHz): 2441

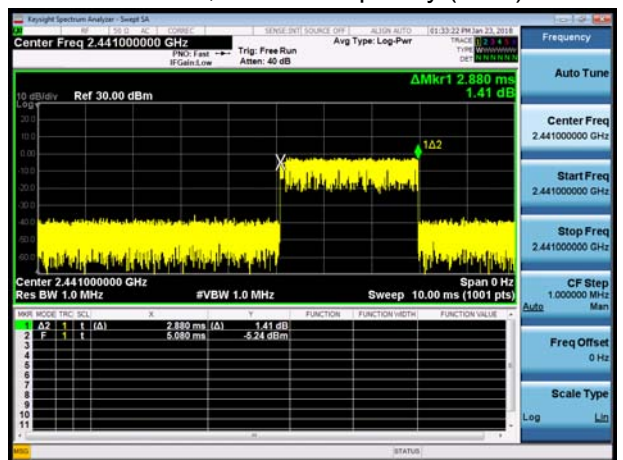

BT 3DH5 CH39, Carrier frequency (MHz): 2441

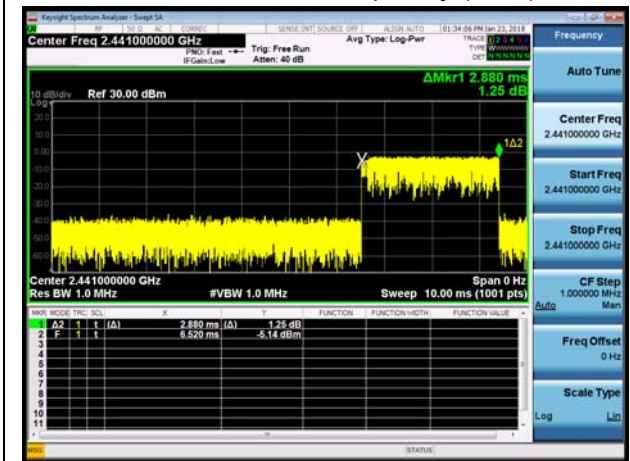

### 5.5 Band Edge Compliance

#### Ambient condition

Temperature	Relative humidity	Pressure
23°C ~25°C	45%~50%	101.5kPa

#### Method of Measurement

The EUT was connected to the spectrum analyzer and Bluetooth test set via a power splitter with a known loss. The lowest and highest channels were measured. The peak detector is used. RBW is set to 100 kHz and VBW is set to 300 kHz on spectrum analyzer. EUT test for Hopping On mode and Hopping Off mode.

#### Test Setup

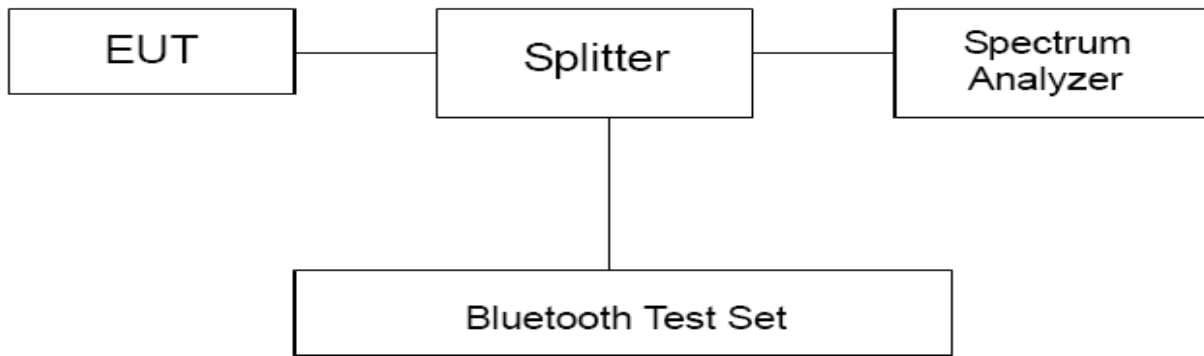

#### Limits

Rule Part 15.247(d) specifies that “In any 100 kHz bandwidth outside the frequency band in which the spread spectrum or digitally modulated intentional radiator is operating, the radio frequency power that is produced by the intentional radiator shall be at least 20 dB below that in the 100 kHz bandwidth within the band that contains the highest level of the desired power, based on either an RF conducted or a radiated measurement, provided the transmitter demonstrates compliance with the peak conducted power limits.”

#### Measurement Uncertainty

The assessed measurement uncertainty to ensure 95% confidence level for the normal distribution is with the coverage factor  $k = 1.96$ .

Frequency	Uncertainty
2GHz-3GHz	1.407 dB

Test Results  
Hopping On

BT DH5 CH0, Carrier frequency (MHz): 2402

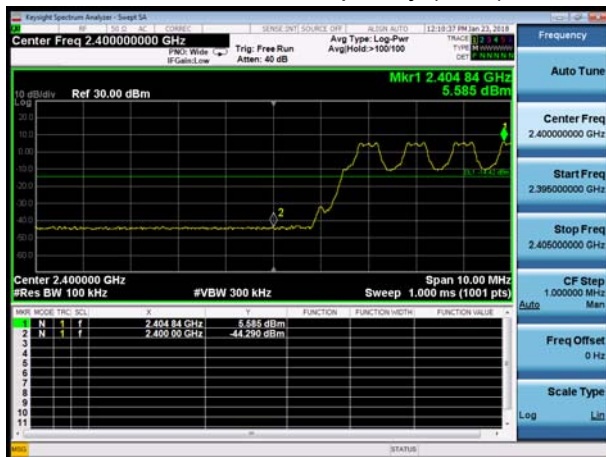

BT DH5 CH78, Carrier frequency (MHz): 2480

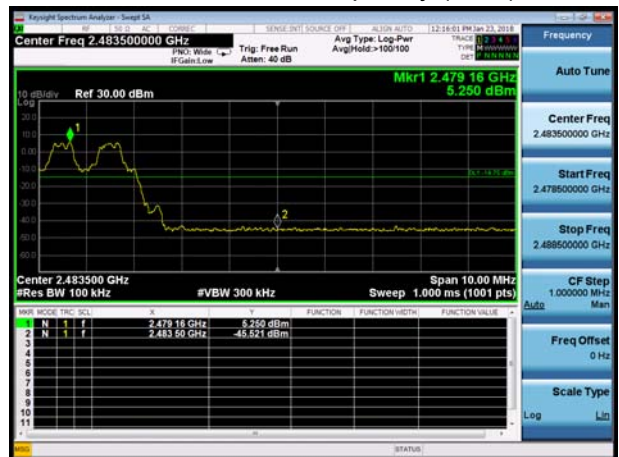

BT 2DH5 CH0, Carrier frequency (MHz): 2402

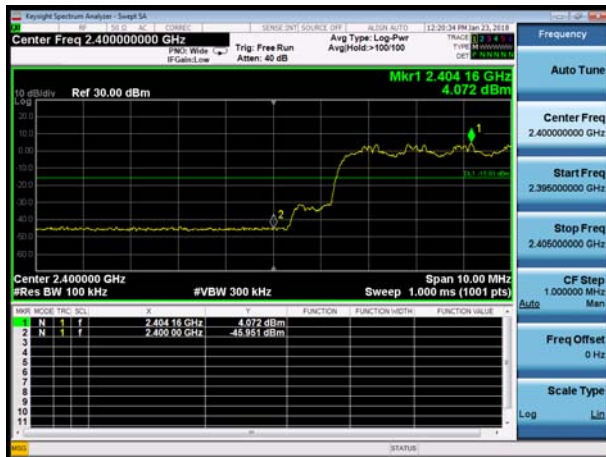

BT 2DH5 CH78, Carrier frequency (MHz): 2480



BT 3DH5 CH0, Carrier frequency (MHz): 2402



BT 3DH5 CH78, Carrier frequency (MHz): 2480



Hopping Off

BT DH5 CH0, Carrier frequency (MHz): 2402

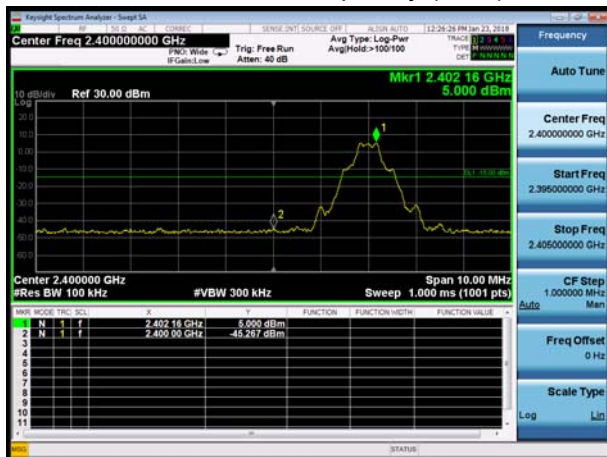

BT DH5 CH78, Carrier frequency (MHz): 2480



BT 2DH5 CH0, Carrier frequency (MHz): 2402

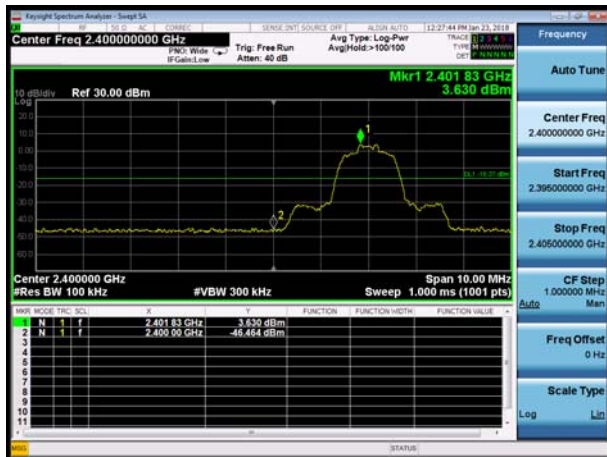

BT 2DH5 CH78, Carrier frequency (MHz): 2480



BT 3DH5 CH0, Carrier frequency (MHz): 2402

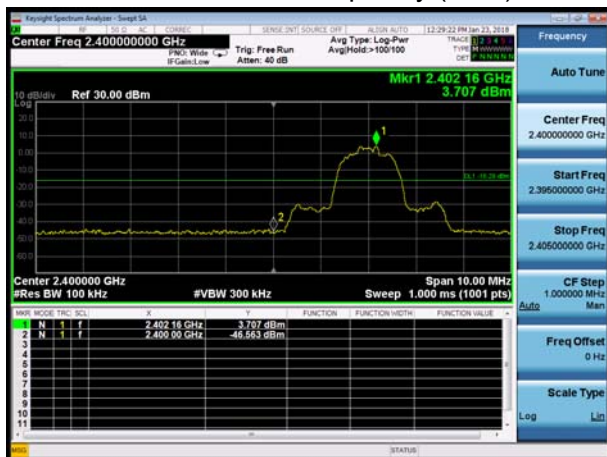

BT 3DH5 CH78, Carrier frequency (MHz): 2480





### 5.6 Spurious Radiated Emissions in the Restricted Band

**Ambient condition**

Temperature	Relative humidity	Pressure
23°C ~25°C	45%~50%	101.5kPa

The Equipment Under Test (EUT) was set up on a non-conductive table in the semi-anechoic chamber. The test was performed at the distance of 3 m between the EUT and the receiving antenna. The turntable shall be rotated from 0 to 360 degrees for detecting the maximum of radiated spurious signal level. The measurements shall be repeated with orthogonal polarization of the test antenna. The data of cable loss and antenna factor has been calibrated in full testing frequency range before the testing.

Set the spectrum analyzer in the following:

- (a) PEAK: RBW=1MHz; VBW=3MHz / Sweep=AUTO
- (b) The dwell time per channel of the hopping signal is less than 100 ms, then the reading obtained with the 10 Hz VBW may be further adjusted by a “duty cycle correction factor”, derived from  $20\log(\text{dwell time}/100 \text{ ms})$ , in an effort to demonstrate compliance with the 15.209 limit. If the emission is pulsed, modify the unit for continuous operation; use the settings shown above, then correct the reading by subtracting the peak- average correction factor, derived from the appropriate duty cycle calculation.

This setting method can refer to **DA00-705**.

The test is in transmitting mode. The field strength of spurious emission was measured in the following position: EUT stand-up position (Z axis), lie-down position (X, Y axis) and docking mode. The worst emission was found in lie-down position (X axis) and the worst case was recorded.

**Test setup**

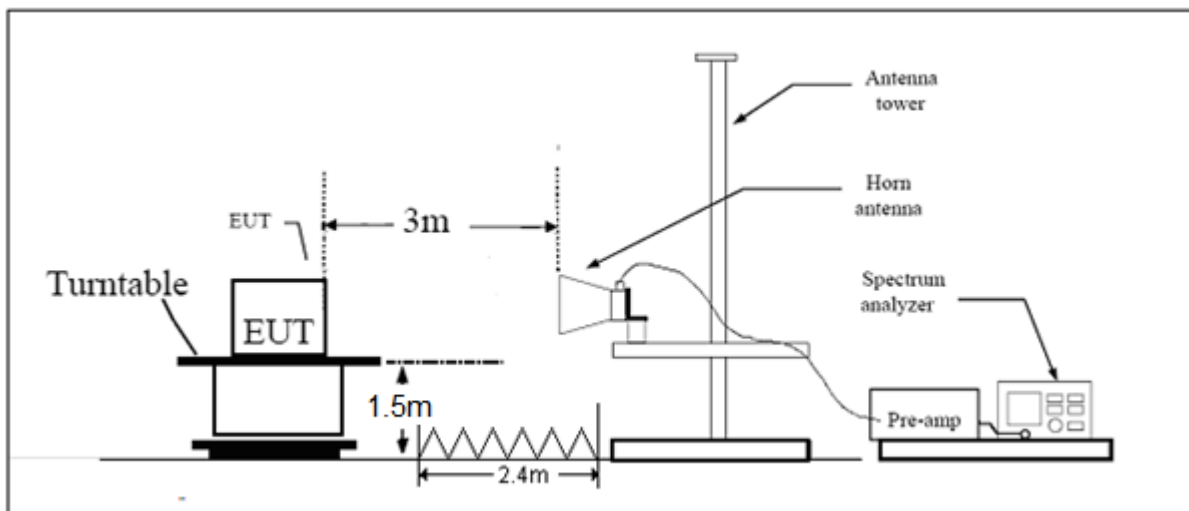

Note: Area side: 2.4mX3.6m

**Limits**

Spurious Radiated Emissions are permitted in any of the frequency bands listed below:

MHz	MHz	MHz	GHz
0.090 - 0.110	16.42 - 16.423	399.9 - 410	4.5 - 5.15
<sup>1</sup> 0.495 - 0.505	16.69475 - 16.69525	608 - 614	5.35 - 5.46
2.1735 - 2.1905	16.80425 - 16.80475	960 - 1240	7.25 - 7.75
4.125 - 4.128	25.5 - 25.67	1300 - 1427	8.025 - 8.5
4.17725 - 4.17775	37.5 - 38.25	1435 - 1626.5	9.0 - 9.2
4.20725 - 4.20775	73 - 74.6	1645.5 - 1646.5	9.3 - 9.5
6.215 - 6.218	74.8 - 75.2	1660 - 1710	10.6 - 12.7
6.26775 - 6.26825	108 - 121.94	1718.8 - 1722.2	13.25 - 13.4
6.31175 - 6.31225	123 - 138	2200 - 2300	14.47 - 14.5
8.291 - 8.294	149.9 - 150.05	2310 - 2390	15.35 - 16.2
8.362 - 8.366	156.52475 - 156.52525	2483.5 - 2500	17.7 - 21.4
8.37625 - 8.38675	156.7 - 156.9	2690 - 2900	22.01 - 23.12
8.41425 - 8.41475	162.0125 - 167.17	3260 - 3267	23.6 - 24.0
12.29 - 12.293	167.72 - 173.2	3332 - 3339	31.2 - 31.8
12.51975 - 12.52025	240 - 285	3345.8 - 3358	36.43 - 36.5
12.57675 - 12.57725	322 - 335.4	3600 - 4400	( <sup>2</sup> )
13.36 - 13.41			

Limit in restricted band

Frequency of emission (MHz)	Field strength(uV/m)	Field strength(dBuV/m)
30-88	100	40
88-216	150	43.5
216-960	200	46
Above960	500	54

**§15.35(b)**

There is also a limit on the radio frequency emissions, as measured using instrumentation with a peak detector function, corresponding to 20 dB above the maximum permitted average limit.

Peak Limit=74dBuV/m

Average Limit=54dBuV/m

**Measurement Uncertainty**

The assessed measurement uncertainty to ensure 95% confidence level for the normal distribution is with the coverage factor  $k = 1.96$ ,  $U = 3.55$  dB.

**Test Results:**  
**The signal beyond the limit is carrier.**

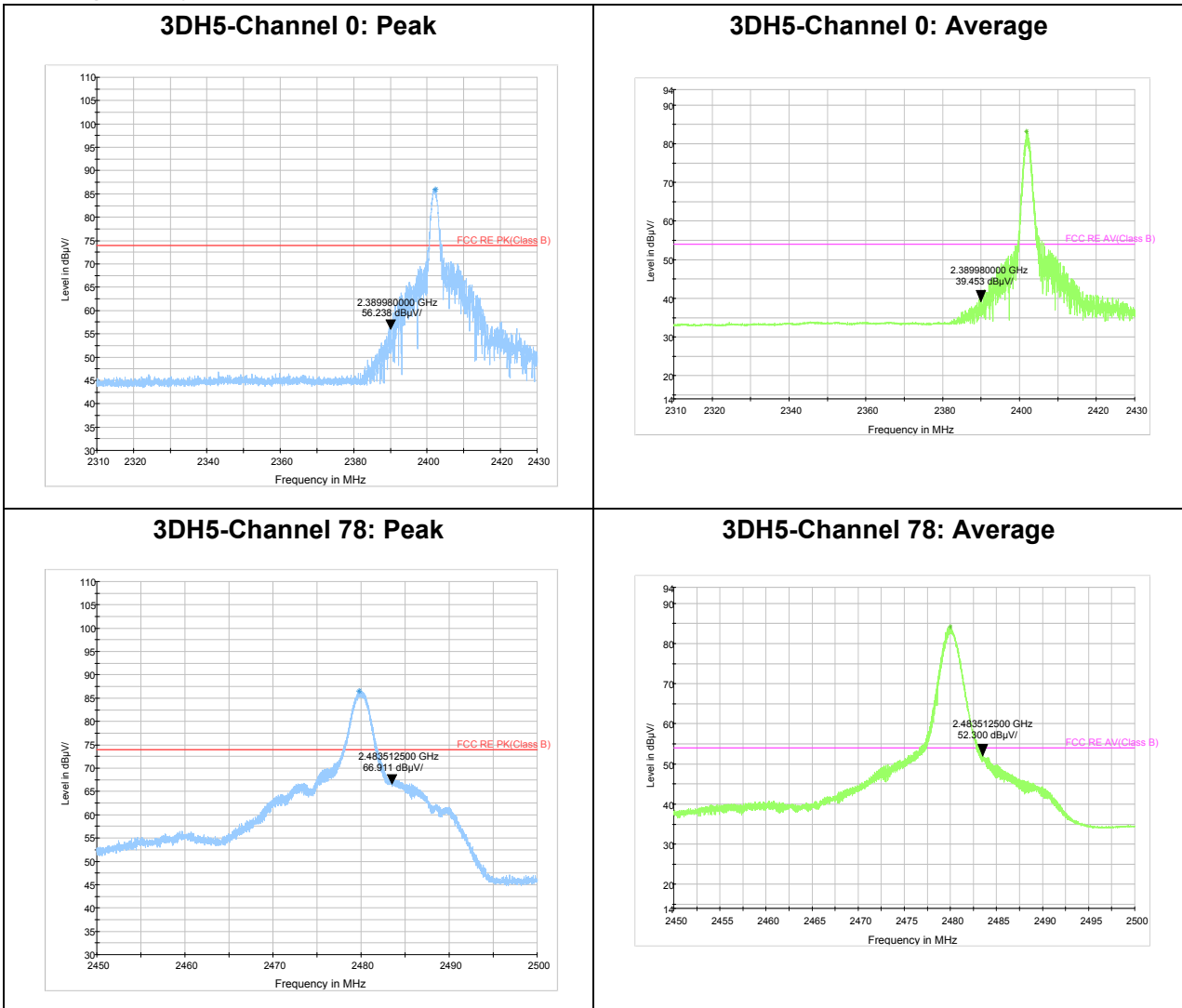

### 5.7 Number of hopping Frequency

**Ambient condition**

Temperature	Relative humidity	Pressure
23°C ~25°C	45%~50%	101.5kPa

**Method of Measurement**

The EUT was connected to the spectrum analyzer and Bluetooth test set via a power splitter with a known loss. RBW is set to 1MHz and VBW is set to 1 MHz on spectrum analyzer. Set EUT on Hopping on mode.

**Test setup**

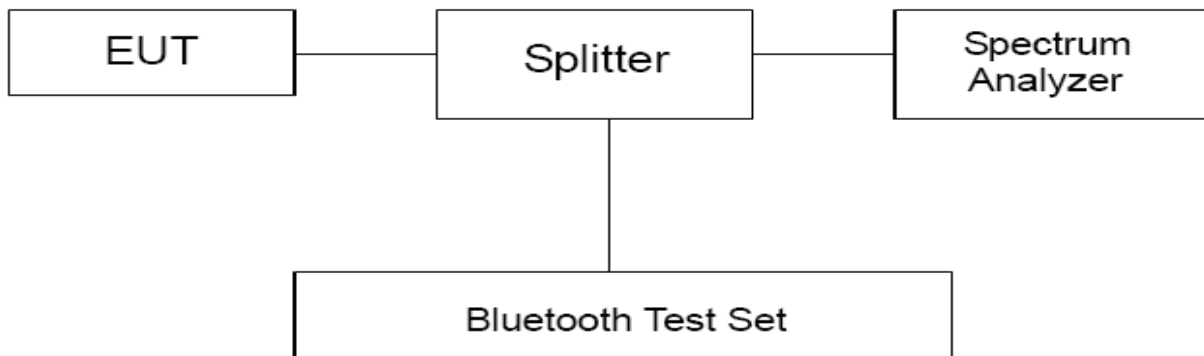

**Limits**

Rule Part 15.247(a) (1) (iii) specifies that” Frequency hopping systems in the 2400–2483.5 MHz band shall use at least 15 channels.”

Limits	≥ 15 channels
--------	---------------

Test Results:

Mode		Number of hopping channels	conclusion
BT	DH5	79	PASS
	2DH5	79	PASS
	3DH5	79	PASS

DH5 2400 MHz – 2483.5 MHz



2DH5 2400 MHz – 2483.5 MHz



3DH5 2400 MHz – 2483.5 MHz



### 5.8 Spurious RF Conducted Emissions

#### Ambient condition

Temperature	Relative humidity	Pressure
23°C ~25°C	45%~50%	101.5kPa

#### Method of Measurement

The EUT was connected to the spectrum analyzer and Bluetooth test set via a power splitter with a known loss. The spectrum analyzer scans from 30MHz to the 10th harmonic of the carrier. The peak detector is used. Set RBW 100kHz and VBW 300 kHz, Sweep is set to ATUO.

The test is in transmitting mode.

#### Test setup

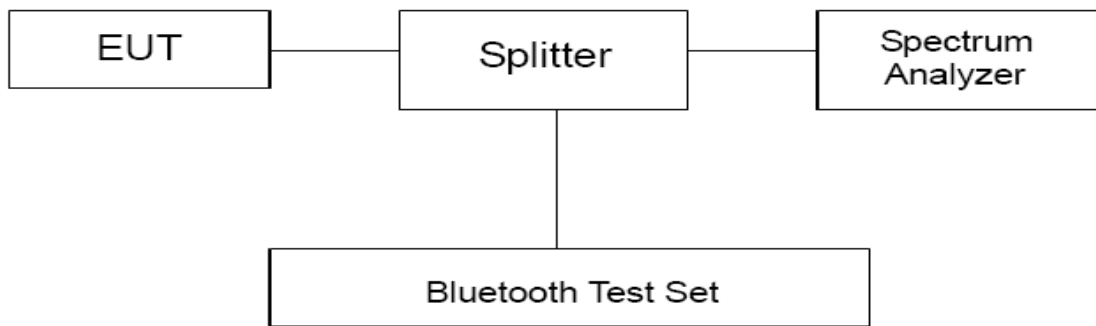

#### Limits

Rule Part 15.247(d) specifies that “In any 100 kHz bandwidth outside the frequency band in which the spread spectrum intentional radiator is operating, the radio frequency power that is produced by the intentional radiator shall be at least 20 dB below that in the 100 kHz bandwidth within the band that contains the highest level of the desired power.”

Mode	Carrier frequency (MHz)	Reference value (dBm)	Limit
EDR (3DH5)	2402	2.66	-17.34
	2441	-0.09	-20.09
	2480	0.30	-19.70

#### Measurement Uncertainty

The assessed measurement uncertainty to ensure 95% confidence level for the normal distribution is with the coverage factor  $k = 1.96$ .

Frequency	Uncertainty
100kHz-2GHz	0.684 dB
2GHz-26GHz	1.407 dB

Test Results:

The signal beyond the limit is carrier.

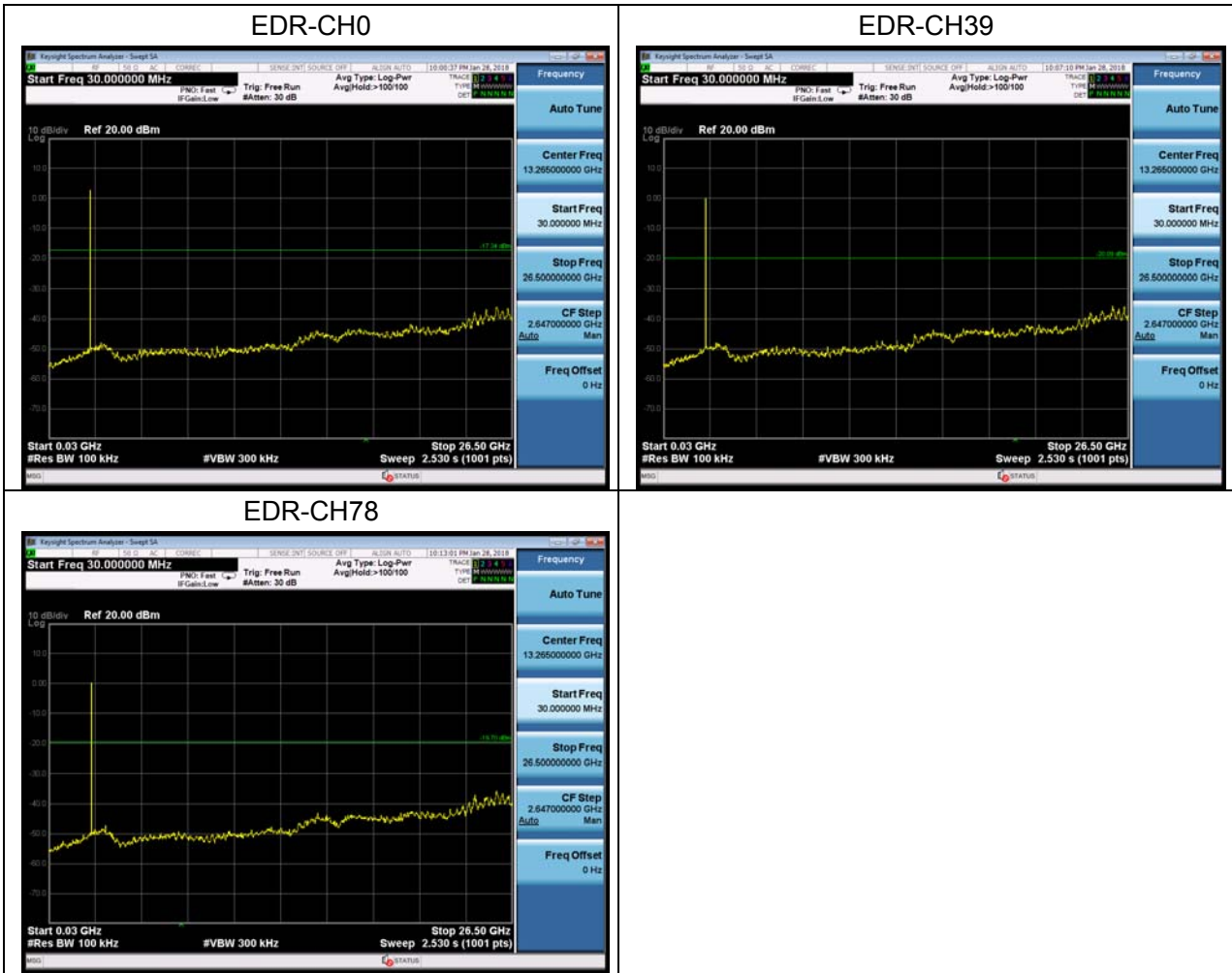

## 5.9 Radiates Emission

### Ambient condition

Temperature	Relative humidity	Pressure
23°C ~25°C	45%~50%	101.5kPa

### Method of Measurement

The test set-up was made in accordance to the general provisions of ANSI C63.10-2013. The Equipment Under Test (EUT) was set up on a non-conductive table in the semi-anechoic chamber. The test was performed at the distance of 3 m between the EUT and the receiving antenna. The radiated emissions measurements were made in a typical installation configuration.

Sweep the whole frequency band through the range from 9 kHz to the 10th harmonic of the carrier, and the emissions less than 20 dB below the permissible value are reported.

During the test, below 30MHz, the center of the loop shall be 1 meters; above 30MHz, the height of receive antenna shall be moved from 1 to 4 meters, and the antenna shall be performed under horizontal and vertical polarization. The turntable shall be rotated from 0 to 360 degrees for detecting the maximum of radiated spurious signal level. The measurements shall be repeated with orthogonal polarization of the test antenna. The data of cable loss and antenna factor has been calibrated in full testing frequency range before the testing.

Set the spectrum analyzer in the following:

Below 1GHz (detector: Peak and Quasi-Peak)

RBW=100kHz / VBW=300kHz / Sweep=AUTO

Above 1GHz(detector: Peak):

(a) PEAK: RBW=1MHz VBW=3MHz/ Sweep=AUTO

(b) AVERAGE: RBW=1MHz / VBW=10Hz / Sweep=AUTO

The radiated emission was measured in the following position: EUT stand-up position (Z axis), lie-down position (X, Y axis). The worst emission was found in lie-down position (X axis) and the worst case was recorded. Then this mode was measured in the following mode: EUT with cradle and EUT without cradle. The worst emission was found in EUT with cradle mode and the worst case was recorded.

The test is in transmitting mode.



**Test setup**  
**9KHz ~ 30MHz**

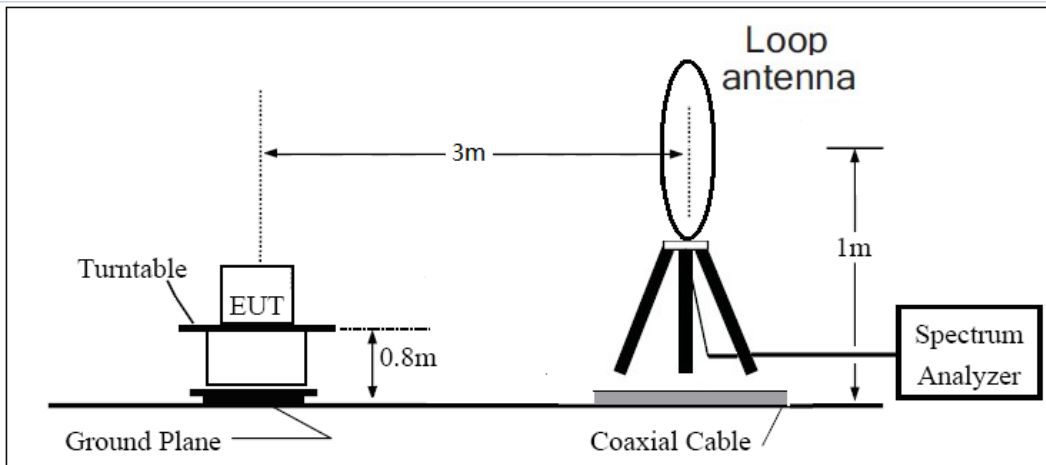

**30MHz ~ 1GHz**

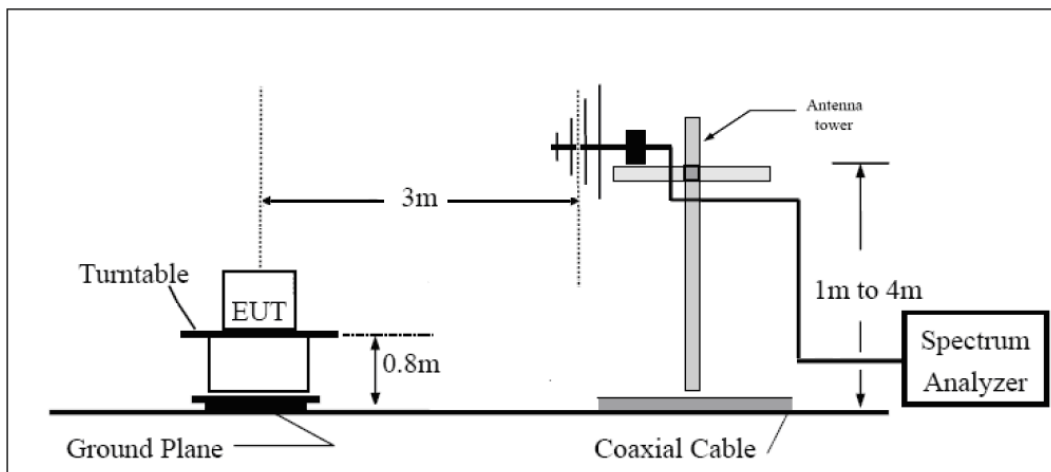

**Above 1GHz**

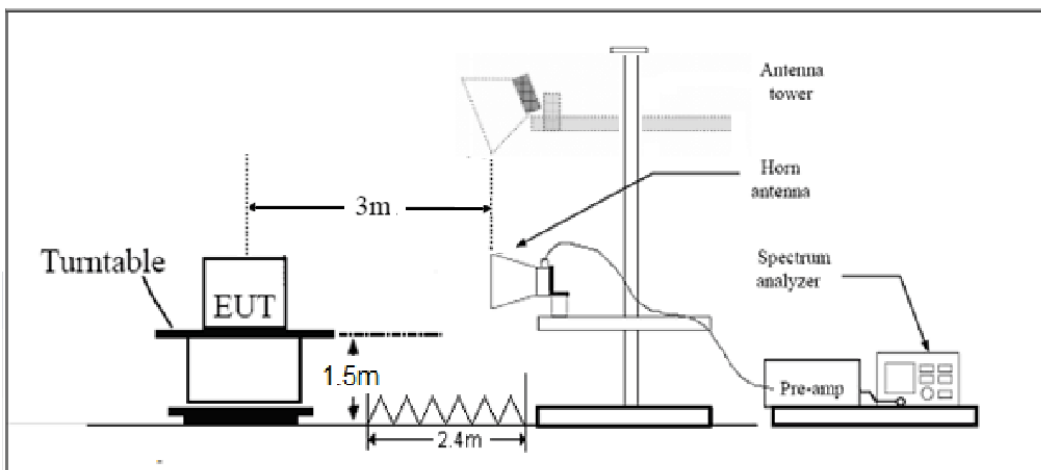

**Limits**

Rule Part 15.247(d) specifies that “In addition, radiated emissions which fall in the restricted bands, as defined in § 15.205(a), must also comply with the radiated emission limits specified in § 15.209(a) (see § 15.205(c)).”

Limit in restricted band

Frequency of emission (MHz)	Field strength(uV/m)	Field strength(dBuV/m)
0.009–0.490	2400/F(kHz)	/
0.490–1.705	24000/F(kHz)	/
1.705–30.0	30	/
30-88	100	40
88-216	150	43.5
216-960	200	46
Above960	500	54

**§15.35(b)**

There is also a limit on the radio frequency emissions, as measured using instrumentation with a peak detector function, corresponding to 20 dB above the maximum permitted average limit.

**Measurement Uncertainty**

The assessed measurement uncertainty to ensure 95% confidence level for the normal distribution is with the coverage factor  $k = 1.96$ .

Frequency	Uncertainty
9KHz-30MHz	3.55 dB
30MHz-200MHz	4.19 dB
200MHz-1GHz	3.63 dB
Above 1GHz	3.68 dB

**Test result**

Sweep from 9 kHz to 30MHz, and the emissions more than 20 dB below the permissible value are not reported.

The following graphs display the maximum values of horizontal and vertical by software.

For above 1GHz, Blue trace uses the peak detection, Green trace uses the average detection.

During the test, the Radiates Emission from 30MHz to 1GHz was performed in all modes with all channels, BT **EDR Channel 0** are selected as the worst condition. The test data of the worst-case condition was recorded in this report.

**Continuous TX mode:**

**Variat**

RE 0.03-1GHz QP Class B

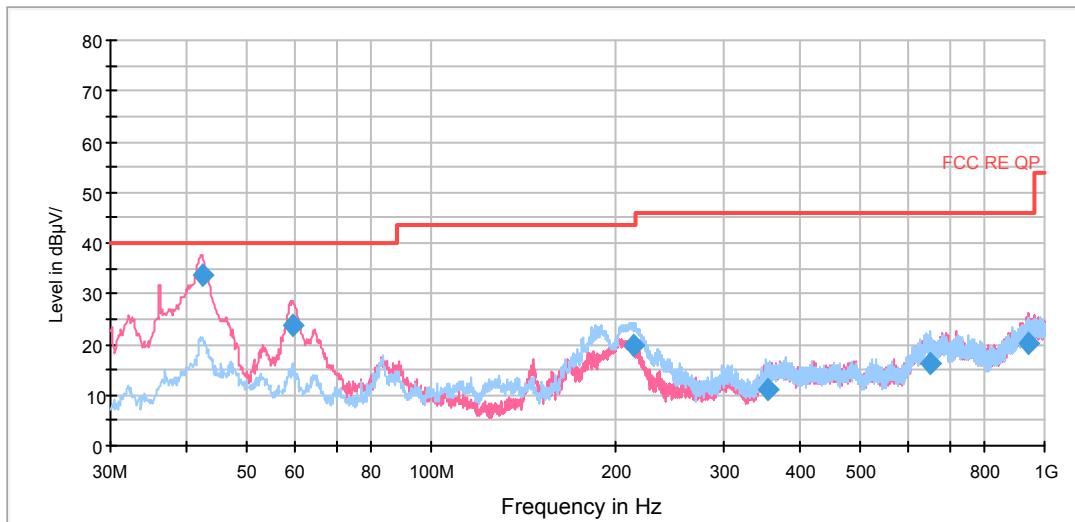

Radiates Emission from 30MHz to 1GHz

Frequency (MHz)	Quasi-Peak (dBuV/m)	Reading value (dBuV/m)	Height (cm)	Polarization	Azimuth (deg)	Correct Factor (dB)	Margin (dB)	Limit (dBuV/m)
42.307500	33.6	51.6	100.0	V	348.0	-18.0	6.4	40.0
59.403750	23.9	45.5	100.0	V	160.0	-21.6	16.1	40.0
213.876250	19.9	45.7	120.0	H	346.0	-25.8	23.6	43.5
353.433750	11.2	31.0	119.0	H	26.0	-19.8	34.8	46.0
653.285000	16.3	31.3	125.0	H	42.0	-15.0	29.7	46.0
943.072500	20.2	30.9	100.0	V	141.0	-10.7	25.8	46.0

**Remark: 1. Quasi-Peak = Reading value + Correction factor**

**2. Correction Factor = Antenna factor+ Insertion loss(cable loss+amplifier gain)**

**3. Margin = Limit – Quasi-Peak**

EDR-Channel 0

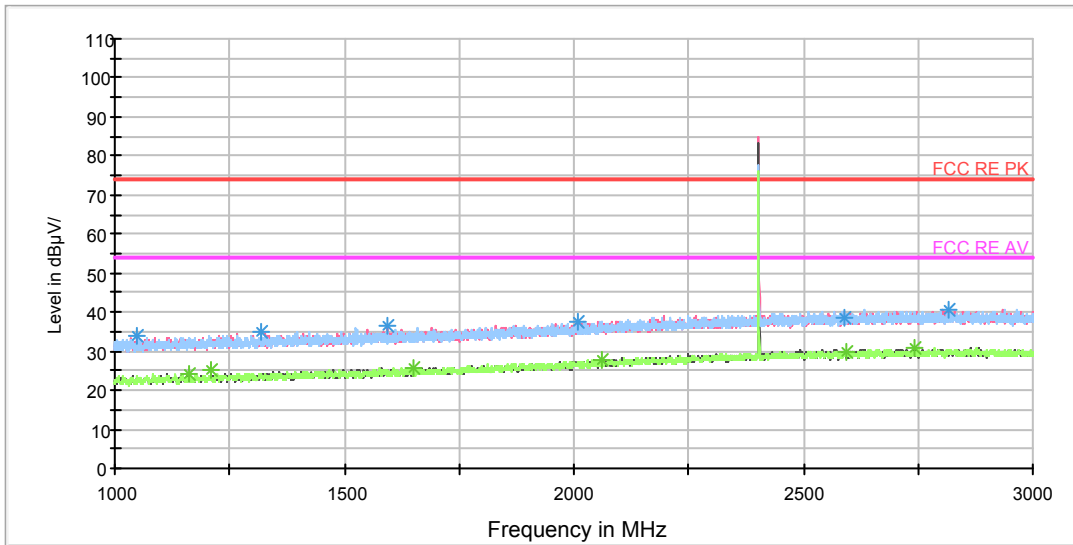

Note: The signal beyond the limit is carrier.  
Radiates Emission from 1GHz to 3GHz

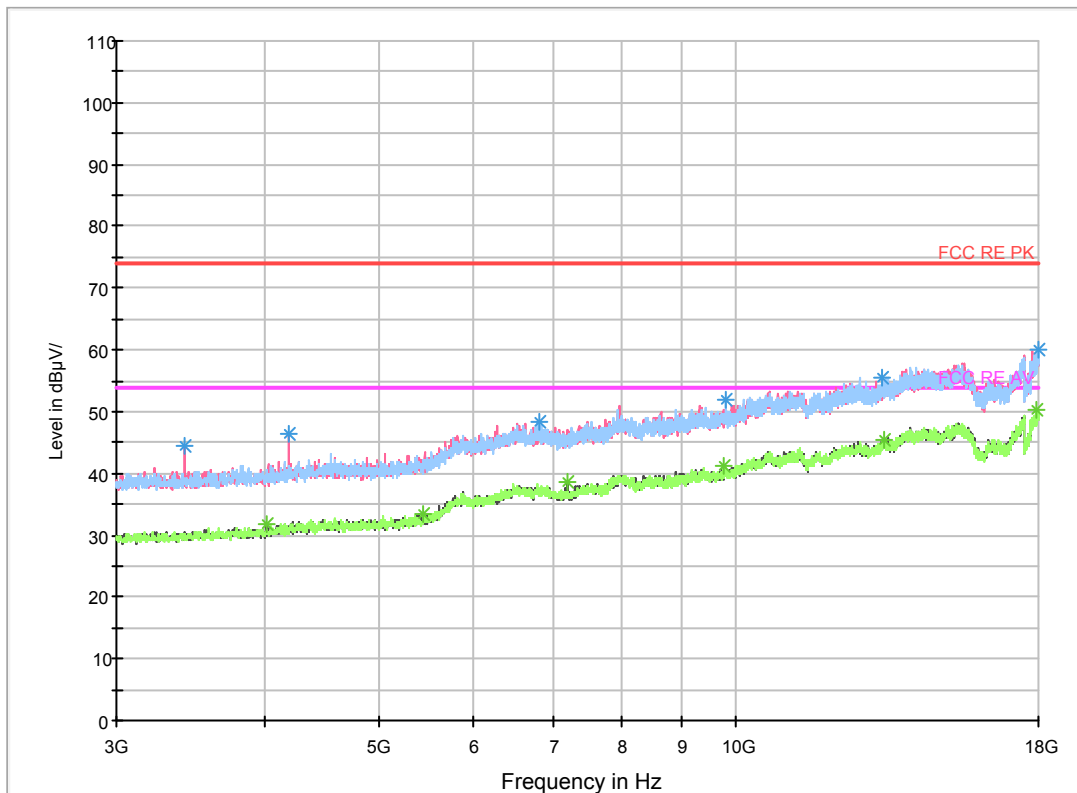

Radiates Emission from 3GHz to 18GHz

Sweep from 18GHz to 26.5GHz, and the emissions more than 20 dB below the permissible value are not reported.

Frequency (MHz)	Peak (dBuV/m)	Height (cm)	Polarization	Azimuth (deg)	Reading value (dBuV/m)	Correct Factor (dB)	Margin (dB)	Limit (dBuV/m)
1047.250000	33.7	100.0	V	0.0	42.7	-9.0	40.3	74
1320.250000	35.2	100.0	H	118.0	42.7	-7.5	38.8	74
1593.000000	36.3	100.0	V	335.0	42.2	-5.9	37.7	74
2010.500000	37.7	100.0	H	298.0	41.1	-3.4	36.3	74
2818.250000	40.7	200.0	V	74.0	41.1	-0.4	33.3	74
2590.000000	38.6	100.0	V	342.0	39.4	-0.8	35.4	74

**Remark: 1. Correction Factor = Antenna factor+ Insertion loss (cable loss + amplifier gain)**

Frequency (MHz)	Average (dBuV/m)	Height (cm)	Polarization	Azimuth (deg)	Reading value (dBuV/m)	Correct Factor (dB)	Margin (dB)	Limit (dBuV/m)
1161.500000	24.0	200.0	V	0.0	32.4	-8.4	30.0	54
1208.000000	25.2	100.0	H	187.0	33.3	-8.1	28.8	54
1650.500000	25.9	100.0	V	351.0	31.5	-5.6	28.1	54
2061.500000	27.8	100.0	H	24.0	30.8	-3.0	26.2	54
2742.250000	31.0	100.0	V	351.0	31.6	-0.6	23.0	54
2594.750000	29.8	100.0	V	0.0	30.6	-0.8	24.2	54

**Remark: 1. Correction Factor = Antenna factor+ Insertion loss (cable loss + amplifier gain)**

Original  
EDR-Channel 39

RE 1G-3GHz PK+AV

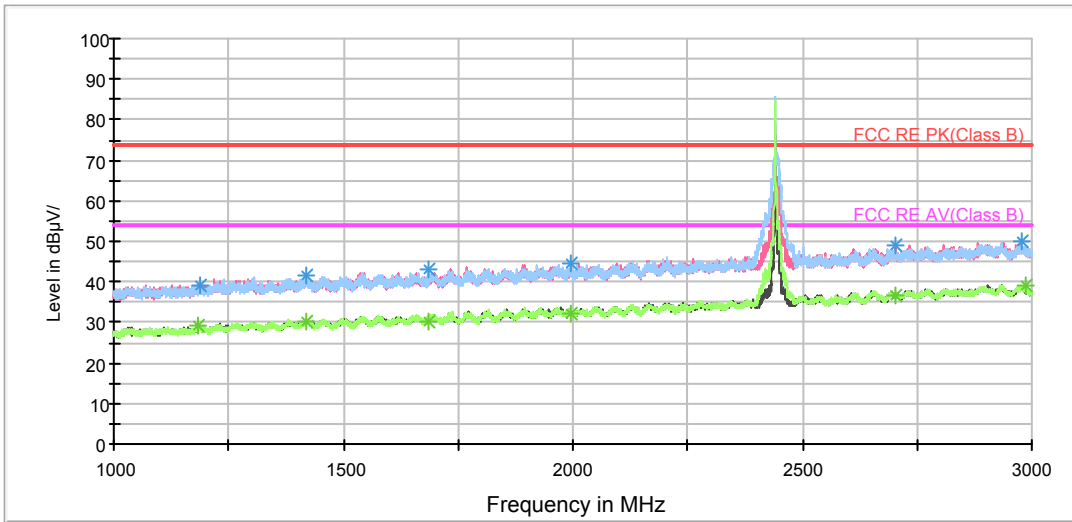

Note: The signal beyond the limit is carrier.  
Radiates Emission from 1GHz to 3GHz

RE 3-18GHz PK+AV

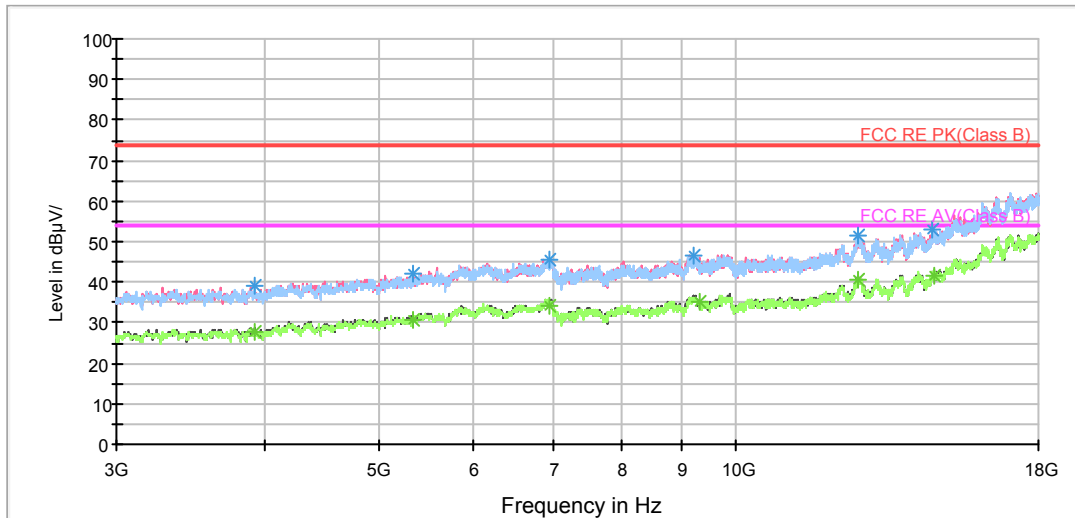

Radiates Emission from 3GHz to 18GHz

BELL\_RE 18-26.5GHz PK+AV

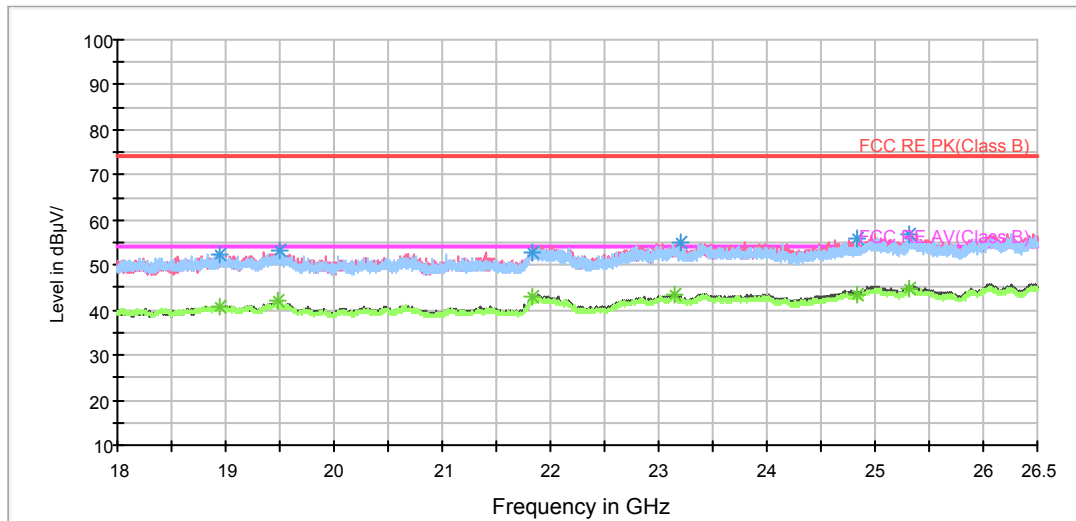

Radiates Emission from 18GHz to 26.5GHz

Frequency (MHz)	Peak (dBuV/m)	Height (cm)	Polarization	Azimuth (deg)	Reading value (dBuV/m)	Correct Factor (dB)	Margin (dB)	Limit (dBuV/m)
1186.000000	39.4	200.0	V	156.0	47.5	-8.1	34.6	74
1420.000000	41.6	100.0	H	227.0	48.5	-6.9	32.4	74
1686.250000	42.9	200.0	H	188.0	47.9	-5.0	31.1	74
1994.250000	44.3	100.0	V	284.0	47.5	-3.2	29.7	74
2704.500000	48.9	100.0	V	80.0	48.8	0.1	25.1	74
2977.000000	49.9	200.0	H	153.0	47.7	2.2	24.1	74

Remark: 1. Correction Factor = Antenna factor+ Insertion loss (cable loss + amplifier gain)

Frequency (MHz)	Average (dBuV/m)	Height (cm)	Polarization	Azimuth (deg)	Reading value (dBuV/m)	Correct Factor (dB)	Margin (dB)	Limit (dBuV/m)
1182.750000	29.2	100.0	V	311.0	37.2	-8.0	24.8	54
1420.000000	30.0	100.0	H	227.0	36.9	-6.9	24.0	54
1686.250000	30.4	200.0	H	188.0	35.4	-5.0	23.6	54
1994.250000	32.4	100.0	V	284.0	35.6	-3.2	21.6	54
2704.500000	36.4	100.0	V	80.0	36.3	0.1	17.6	54
2985.000000	39.2	100.0	H	263.0	37.0	2.2	14.8	54

Remark: 1. Correction Factor = Antenna factor+ Insertion loss (cable loss + amplifier gain)

RE 1G-3GHz PK+AV

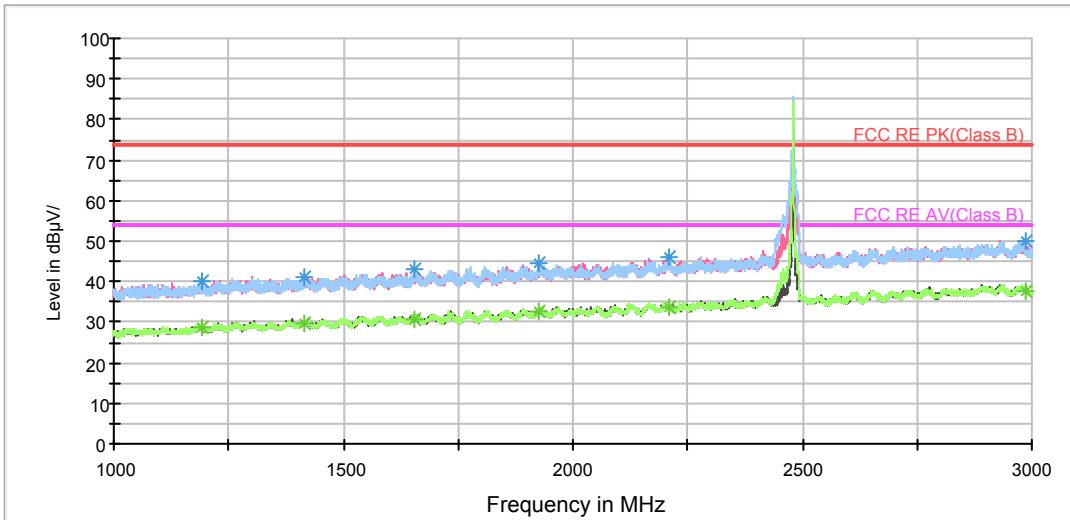

Note: The signal beyond the limit is carrier.  
Radiates Emission from 1GHz to 3GHz

RE 3-18GHz PK+AV

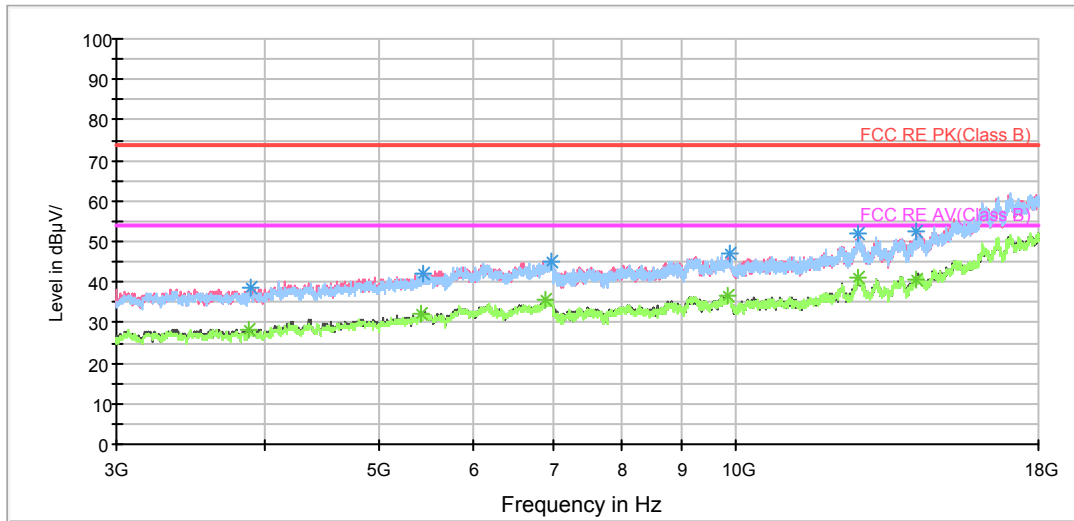

Radiates Emission from 3GHz to 18GHz



BELL\_RE 18-26.5GHz PK+AV

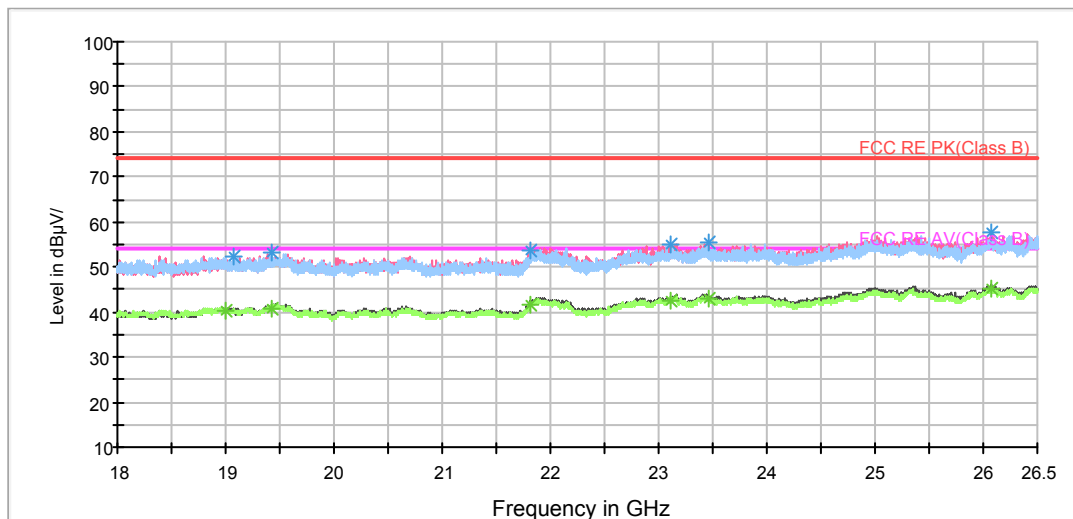

Radiates Emission from 18GHz to 26.5GHz

Frequency (MHz)	Peak (dBuV/m)	Height (cm)	Polarization	Azimuth (deg)	Reading value (dBuV/m)	Correct Factor (dB)	Margin (dB)	Limit (dBuV/m)
1192.000000	40.3	200.0	H	207.0	48.5	-8.2	33.7	74
1416.250000	41.2	200.0	H	117.0	48.2	-7.0	32.8	74
1656.250000	42.9	100.0	H	0.0	48.1	-5.2	31.1	74
1927.500000	44.4	100.0	V	0.0	48.1	-3.7	29.6	74
2208.250000	45.9	100.0	H	177.0	48.1	-2.2	28.1	74
2986.000000	50.2	100.0	V	240.0	48.0	2.2	23.8	74

Remark: 1. Correction Factor = Antenna factor+ Insertion loss (cable loss + amplifier gain)

Frequency (MHz)	Average (dBuV/m)	Height (cm)	Polarization	Azimuth (deg)	Reading value (dBuV/m)	Correct Factor (dB)	Margin (dB)	Limit (dBuV/m)
1190.750000	28.7	200.0	V	0.0	36.9	-8.2	25.3	54
1416.250000	29.6	200.0	H	117.0	36.6	-7.0	24.4	54
1656.250000	30.9	100.0	H	0.0	36.1	-5.2	23.1	54
1927.500000	32.6	100.0	V	0.0	36.3	-3.7	21.4	54
2208.250000	33.7	100.0	H	177.0	35.9	-2.2	20.3	54
2986.000000	37.7	100.0	V	240.0	35.5	2.2	16.3	54

Remark: 1. Correction Factor = Antenna factor+ Insertion loss (cable loss + amplifier gain)

## 5.10 Conducted Emission

### Ambient condition

Temperature	Relative humidity	Pressure
23°C ~25°C	45%~50%	101.5kPa

### Methods of Measurement

The EUT is placed on a non-metallic table of 80cm height above the horizontal metal reference ground plane. During the test, the EUT was operating in its typical mode. The test method is according to ANSI C63.10-2013. Connect the AC power line of the EUT to the L.I.S.N. Use EMI receiver to detect the average and Quasi-peak value. RBW is set to 9 kHz, VBW is set to 30kHz. The measurement result should include both L line and N line.

The test is in transmitting mode.

### Test Setup

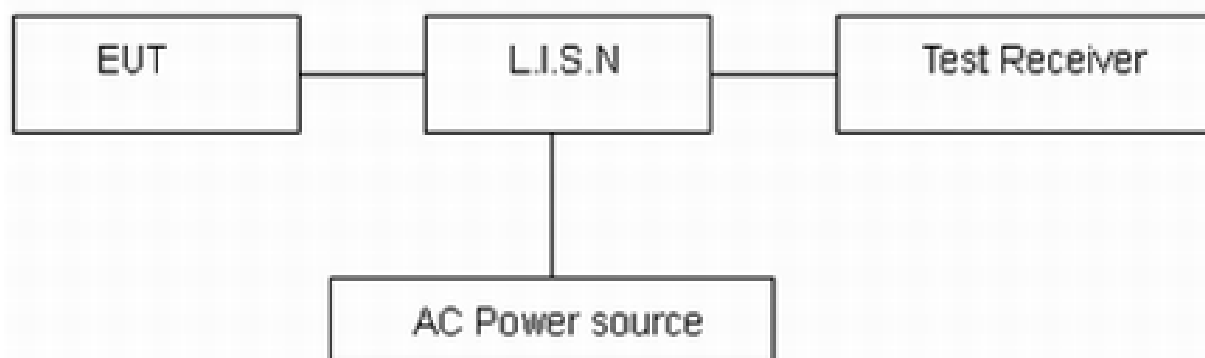

Note: AC Power source is used to 120V/60Hz.

### Limits

Frequency (MHz)	Conducted Limits(dBμV)	
	Quasi-peak	Average
0.15 - 0.5	66 to 56 *	56 to 46 *
0.5 - 5	56	46
5 - 30	60	50

\*: Decreases with the logarithm of the frequency.

### Measurement Uncertainty

The assessed measurement uncertainty to ensure 95% confidence level for the normal distribution is with the coverage factor  $k = 1.96$ ,  $U=2.69$  dB.

**Test Results:**

Following plots, Blue trace uses the peak detection, Green trace uses the average detection. During the test, the Conducted Emission was performed in all modes with all channels, BT **EDR channel 0**, are selected as the worst condition. The test data of the worst-case condition was recorded in this report.

**Variant**

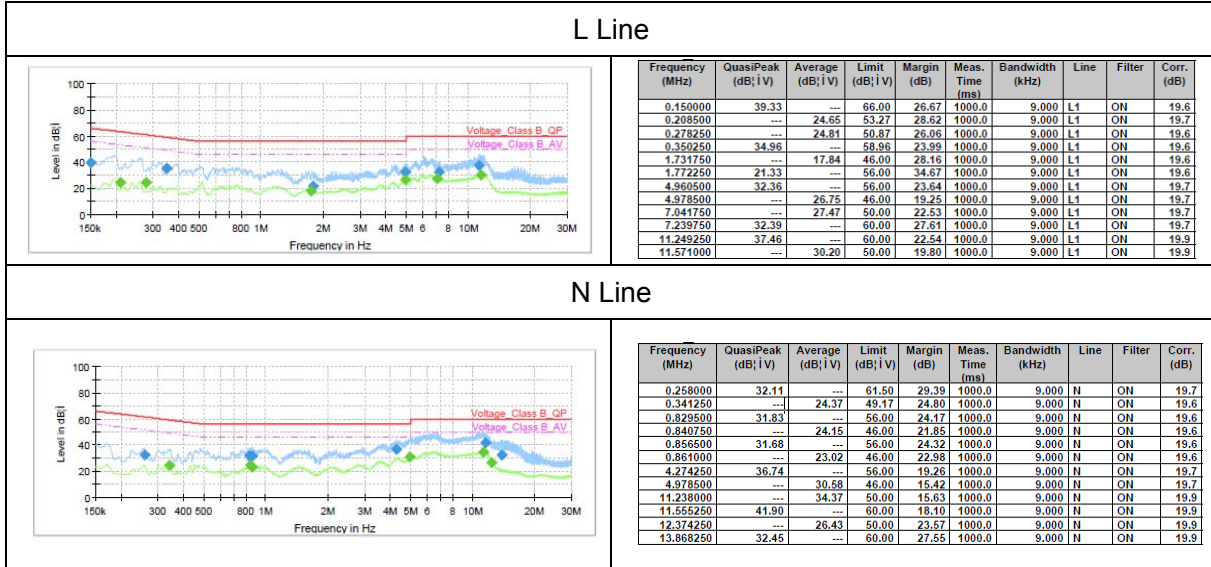

## 6 Main Test Instruments

Name	Manufacturer	Type	Serial Number	Calibration Date	Expiration Date
BT Base Station Simulator	R&S	CBT	100271	2017-05-14	2018-05-13
Loop Antenna	SCHWARZBECK	FMZB1519	1519-047	2017-02-18	2020-02-17
EMI Test Receiver	R&S	ESCS30	100138	2017-12-17	2018-12-16
Artificial main network	R&S	ENV216	101171	2016-12-16	2019-12-15
Signal Analyzer	R&S	FSV30	100815	2017-12-17	2018-12-16
EMI Test Receiver	R&S	ESCI	100948	2017-05-20	2018-05-19
TRILOG Broadband Antenna	Schwarzbeck	VULB 9163	9163-201	2017-11-18	2020-11-17
Double Ridged Waveguide Horn Antenna	R&S	HF907	100126	2014-12-06	2019-12-05
Spectrum Analyzer	Agilent	N9010A	MY47191109	2017-05-20	2018-05-19
Standard Gain Horn	ETS-Lindgren	3160-09	00102644	2015-01-30	2020-01-29
pre-Amplifier	R&S	SCU18	102327	2017-06-18	2018-06-17
RF Cable	Agilent	SMA 15cm	0001	/	/
Power Splitter	Hua Xiang	SHX-GF2-2-13	10120101	/	/
Software (CE)	R&S	EMC32	9.26.0	/	/
Software (RE/RSE)	R&S	EMC32	8.52.0	/	/

\*\*\*\*\*END OF REPORT \*\*\*\*\*