



FCC RF Test Report

APPLICANT : ZTE CORPORATION
EQUIPMENT : LTE Digital Mobile Phone
BRAND NAME : ZTE
MODEL NAME : Z839
FCC ID : SRQ-Z839
STANDARD : 47 CFR Part 2, 22(H), 24(E), 27(L), 27(F)
CLASSIFICATION : PCS Licensed Transmitter Held to Ear (F)

The product was received on Apr. 05, 2017 and completely tested on Apr. 20, 2017. We, Sporton International (KunShan) INC., would like to declare that the tested sample has been evaluated in accordance with the test procedures given in ANSI / TIA / EIA-603-D-2010 and the testing has shown the tested sample to be in compliance with the applicable technical standards.

The test results in this report apply exclusively to the tested model / sample. Without written approval of Sporton International (KunShan) INC., the test report shall not be reproduced except in full.

Prepared by: James Huang / Manager

Approved by: Jones Tsai / Manager



Sporton International (KunShan) INC.

No.3-2, Pingxiang Road, Kunshan Development Zone, Jiangsu, China



TABLE OF CONTENTS

REVISION HISTORY.....3
SUMMARY OF TEST RESULT4
1 GENERAL DESCRIPTION5
1.1 Applicant5
1.2 Manufacturer.....5
1.3 Product Feature of Equipment Under Test.....5
1.4 Product Specification of Equipment Under Test.....6
1.5 Modification of EUT6
1.6 Maximum ERP/EIRP Power, Frequency Tolerance, and Emission Designator7
1.7 Testing Location8
1.8 Applicable Standards.....8
2 TEST CONFIGURATION OF EQUIPMENT UNDER TEST9
2.1 Test Mode9
2.2 Connection Diagram of Test System.....11
2.3 Support Unit used in test configuration and system12
2.4 Measurement Results Explanation Example.....12
2.5 Frequency List of Low/Middle/High Channels13
3 CONDUCTED TEST ITEMS15
3.1 Measuring Instruments15
3.2 Test Setup15
3.3 Test Result of Conducted Test15
3.4 Conducted Output Power and ERP/EIRP16
3.5 Peak-to-Average Ratio17
3.6 Occupied Bandwidth.....18
3.7 Conducted Band Edge19
3.8 Conducted Spurious Emission21
3.9 Frequency Stability22
4 RADIATED TEST ITEMS23
4.1 Measuring Instruments23
4.2 Test Setup23
4.3 Test Result of Radiated Test23
4.4 Radiated Spurious Emission24
5 LIST OF MEASURING EQUIPMENT25
6 UNCERTAINTY OF EVALUATION26
APPENDIX A. TEST RESULTS OF CONDUCTED TEST
APPENDIX B. TEST RESULTS OF RADIATED TEST
APPENDIX C. TEST SETUP PHOTOGRAPHS



REVISION HISTORY

REPORT NO.	VERSION	DESCRIPTION	ISSUED DATE
FG740501	Rev. 01	Initial issue of report	May 25, 2017



SUMMARY OF TEST RESULT

Report Section	FCC Rule	Description	Limit	Result	Remark
3.4	§2.1046	Conducted Output Power	Reporting Only	PASS	-
	§22.913(a)(2)	Effective Radiated Power (Band 5)	ERP < 7 Watt	PASS	-
	§27.50(b)(10)	Effective Radiated Power (Band 13)	ERP < 3 Watt	PASS	-
	§24.232(c)	Equivalent Isotropic Radiated Power (Band 2)	EIRP < 2Watt	PASS	-
	§27.50(d)(4)	Equivalent Isotropic Radiated Power (Band 4)	EIRP < 1Watt	PASS	-
3.5	§24.232(d)	Peak-to-Average Ratio	<13 dB	PASS	-
3.6	§2.1049	Occupied Bandwidth	Reporting Only	PASS	-
3.7	§2.1051 §22.917(a) §24.238(a) §27.53(c)(2)(4) §27.53(h)	Conducted Band Edge Measurement (Band 2) (Band 4) (Band 5) (Band 13)	< 43+10log ₁₀ (P[Watts])	PASS	-
3.8	§2.1051 §22.917(a) §24.238(a) §27.53(c)(2) §27.53(h)	Conducted Spurious Emission (Band 2) (Band 4) (Band 5) (Band 13)	< 43+10log ₁₀ (P[Watts])	PASS	-
3.9	§2.1055 §22.355	Frequency Stability Temperature & Voltage	< 2.5 ppm for Part 22	PASS	-
	§2.1055 §24.235 §27.54		Within Authorized Band		
4.4	§2.1053 §22.917(a) §24.238(a) §27.53(c)(2) §27.53(f) §27.53(h)	Radiated Spurious Emission (Band 2) (Band 4) (Band 5) (Band 13)	< 43+10log ₁₀ (P[Watts])	PASS	Under limit 22.69 dB at 1560.000 MHz



1 General Description

1.1 Applicant

ZTE CORPORATION

ZTE Plaza, Keji Road South, Hi-Tech, Industrial Park, Nanshan District, Shenzhen, Guangdong, 518057, P. R. China

1.2 Manufacturer

ZTE CORPORATION

ZTE Plaza, Keji Road South, Hi-Tech, Industrial Park, Nanshan District, Shenzhen, Guangdong, 518057, P. R. China

1.3 Product Feature of Equipment Under Test

Product Feature	
Equipment	LTE Digital Mobile Phone
Brand Name	ZTE
Model Name	Z839
FCC ID	SRQ-Z839
EUT supports Radios application	LTE/ WLAN 2.4GHz 802.11b/g/n HT20/ Bluetooth v3.0 + EDR/Bluetooth v4.0 LE
IMEI Code	Conducted: 004401784153914/004401784153901 Radiation: 004401784150688/004401784150601
HW Version	Z839HW1.0
SW Version	Z839V1.0.0B01
EUT Stage	Identical Prototype



1.4 Product Specification of Equipment Under Test

Standards-related Product Specification	
Tx Frequency	LTE Band 2 : 1850.7 MHz ~ 1909.3 MHz LTE Band 4 : 1710.7 MHz ~ 1754.3 MHz LTE Band 5 : 824.7 MHz ~ 848.3 MHz LTE Band 13 : 779.5 MHz ~ 784.5 MHz
Rx Frequency	LTE Band 2 : 1930.7 MHz ~ 1989.3 MHz LTE Band 4 : 2110.7 MHz ~ 2154.3 MHz LTE Band 5 : 869.7 MHz ~ 893.3 MHz LTE Band 13 : 748.5 MHz ~ 753.5 MHz
Bandwidth	LTE Band 2 : 1.4MHz / 3MHz / 5MHz / 10MHz / 15MHz / 20MHz LTE Band 4 : 1.4MHz / 3MHz / 5MHz / 10MHz / 15MHz / 20MHz LTE Band 5 : 1.4MHz / 3MHz / 5MHz / 10MHz LTE Band 13 : 5MHz / 10MHz
Maximum Output Power to Antenna	LTE Band 2 : 22.99 dBm LTE Band 4 : 22.92 dBm LTE Band 5 : 23.23 dBm LTE Band 13 : 23.17 dBm
Antenna Gain	LTE Band 2 : 2.2 dBi LTE Band 4 : 2.3 dBi LTE Band 5 : 1.6 dBi LTE Band 13 : 2.3 dBi
Type of Modulation	QPSK / 16QAM

1.5 Modification of EUT

No modifications are made to the EUT during all test items.



1.6 Maximum ERP/EIRP Power, Frequency Tolerance, and Emission Designator

LTE Band 2		QPSK			16QAM		
BW (MHz)	Frequency Range (MHz)	Emission Designator (99%OBW)	Frequency Tolerance (ppm)	Maximum EIRP(W)	Emission Designator (99%OBW)	Frequency Tolerance (ppm)	Maximum EIRP(W)
1.4	1850.7 ~ 1909.3	1M09G7D	-	0.3221	1M10W7D	-	0.2624
3	1851.5 ~ 1908.5	2M72G7D	-	0.3055	2M73W7D	-	0.2529
5	1852.5 ~ 1907.5	4M52G7D	-	0.3112	4M52W7D	-	0.2606
10	1855.0 ~ 1905.0	9M03G7D	0.0023	0.3304	9M05W7D	-	0.2606
15	1857.5 ~ 1902.5	13M5G7D	-	0.3141	13M5W7D	-	0.2523
20	1860.0 ~ 1900.0	18M4G7D	-	0.3266	18M5W7D	-	0.2582
LTE Band 4		QPSK			16QAM		
BW (MHz)	Frequency Range (MHz)	Emission Designator (99%OBW)	Frequency Tolerance (ppm)	Maximum EIRP(W)	Emission Designator (99%OBW)	Frequency Tolerance (ppm)	Maximum EIRP(W)
1.4	1710.7 ~ 1754.3	1M10G7D	-	0.3258	1M10W7D	-	0.2673
3	1711.5 ~ 1753.5	2M74G7D	-	0.3228	2M73W7D	-	0.2655
5	1712.5 ~ 1752.5	4M52G7D	-	0.3214	4M51W7D	-	0.2692
10	1715.0 ~ 1750.0	9M05G7D	0.0018	0.3162	9M03W7D	-	0.2679
15	1717.5 ~ 1747.5	13M5G7D	-	0.3319	13M6W7D	-	0.2655
20	1720.0 ~ 1745.0	18M4G7D	-	0.3327	18M5W7D	-	0.2661
LTE Band 5		QPSK			16QAM		
BW (MHz)	Frequency Range (MHz)	Emission Designator (99%OBW)	Frequency Tolerance (ppm)	Maximum ERP(W)	Emission Designator (99%OBW)	Frequency Tolerance (ppm)	Maximum ERP(W)
1.4	824.7 ~ 848.3	1M10G7D	-	0.1799	1M10W7D	-	0.1538
3	825.5 ~ 847.5	2M75G7D	-	0.1786	2M72W7D	-	0.1524
5	826.5 ~ 846.5	4M52G7D	-	0.1854	4M52W7D	-	0.1531
10	829.0 ~ 844.0	9M09G7D	0.0026	0.1849	9M03W7D	-	0.1560
LTE Band 13		QPSK			16QAM		
BW (MHz)	Frequency Range (MHz)	Emission Designator (99%OBW)	Frequency Tolerance (ppm)	Maximum ERP(W)	Emission Designator (99%OBW)	Frequency Tolerance (ppm)	Maximum ERP(W)
5	779.5 ~ 784.5	4M53G7D	-	0.2104	4M51W7D	-	0.1837
10	782.0	9M01G7D	0.0028	0.2148	9M05W7D	-	0.1714



1.7 Testing Location

Test Site	Sporton International (KunShan) INC.		
Test Site Location	No.3-2, Pingxiang Road, Kunshan Development Zone, Jiangsu, China TEL: +86-0512-5790-0158 FAX: +86-0512-5790-0958		
Test Site No.	Sporton Site No.		FCC Registration No.
	TH01-KS	03CH03-KS	306251

1.8 Applicable Standards

According to the specifications of the manufacturer, the EUT must comply with the requirements of the following standards:

- ♦ 47 CFR Part 2, 22(H), 24(E), 27(L), 27(F)
- ♦ ANSI / TIA / EIA-603-D-2010
- ♦ FCC KDB 971168 D01 Power Meas. License Digital Systems v02r02
- ♦ FCC KDB 412172 D01 Determining ERP and EIRP v01r01

Remark:

1. All test items were verified and recorded according to the standards and without any deviation during the test.
2. This EUT has also been tested and complied with the requirements of FCC Part 15, Subpart B, recorded in a separate test report.



2 Test Configuration of Equipment Under Test

2.1 Test Mode

Antenna port conducted and radiated test items listed below are performed according to KDB 971168 D01 Power Meas. License Digital Systems v02r02 with maximum output power.

Radiated measurements are performed by rotating the EUT in three different orthogonal test planes to find the maximum emission.

Test Items	Band	Bandwidth (MHz)						Modulation		RB #			Test Channel		
		1.4	3	5	10	15	20	QPSK	16QAM	1	Half	Full	L	M	H
Max. Output Power	2	Y	Y	Y	Y	Y	Y	Y	Y	Y	Y	Y	Y	Y	Y
	4	Y	Y	Y	Y	Y	Y	Y	Y	Y	Y	Y	Y	Y	Y
	5	Y	Y	Y	Y	-	-	Y	Y	Y	Y	Y	Y	Y	Y
	13	-	-	Y	Y	-	-	Y	Y	Y	Y	Y	Y	Y	Y
Peak-to-Average Ratio	2						Y	Y	Y	Y		Y	Y	Y	Y
	4						Y	Y	Y	Y		Y	Y	Y	Y
	5				Y	-	-	Y	Y	Y		Y	Y	Y	Y
	13	-	-		Y	-	-	Y	Y	Y		Y	Y	Y	Y
26dB and 99% Bandwidth	2	Y	Y	Y	Y	Y	Y	Y	Y			Y	Y	Y	Y
	4	Y	Y	Y	Y	Y	Y	Y	Y			Y	Y	Y	Y
	5	Y	Y	Y	Y	-	-	Y	Y			Y	Y	Y	Y
	13	-	-	Y	Y	-	-	Y	Y			Y	Y	Y	Y
Conducted Band Edge	2	Y	Y	Y	Y	Y	Y	Y	Y	Y		Y	Y		Y
	4	Y	Y	Y	Y	Y	Y	Y	Y	Y		Y	Y		Y
	5	Y	Y	Y	Y	-	-	Y	Y	Y		Y	Y		Y
	13	-	-	Y	Y	-	-	Y	Y	Y		Y	Y		Y



Test Items	Band	Bandwidth (MHz)						Modulation		RB #			Test Channel		
		1.4	3	5	10	15	20	QPSK	16QAM	1	Half	Full	L	M	H
Conducted Spurious Emission	2	√	√	√	√	√	√	√	√	√			√	√	√
	4	√	√	√	√	√	√	√	√	√			√	√	√
	5	√	√	√	√	-	-	√	√	√			√	√	√
	13	-	-	√	√	-	-	√	√	√			√	√	√
Frequency Stability	2				√			√				√		√	
	4				√			√				√		√	
	5				√	-	-	√				√		√	
	13	-	-		√	-	-	√				√		√	
E.R.P./ E.I.R.P.	2	√	√	√	√	√	√	√	√	√			√	√	√
	4	√	√	√	√	√	√	√	√	√			√	√	√
	5	√	√	√	√	-	-	√	√	√			√	√	√
	13	-	-	√	√			√	√	√			√	√	√
Radiated Spurious Emission	2	√	√	√	√	√	√	√		√				√	
	4	√	√	√	√	√	√	√		√				√	
	5	√	√	√	√	-	-	√		√				√	
	13	-	-	√	√	-	-	√		√				√	
Note	<p>1. The mark “√” means that this configuration is chosen for testing</p> <p>2. The mark “-” means that this bandwidth is not supported.</p> <p>3. The device is investigated from 30MHz to 10 times of fundamental signal for radiated spurious emission test under different RB size/offset and modulations in exploratory test. Subsequently, only the worst case emissions are reported.</p>														

2.2 Connection Diagram of Test System

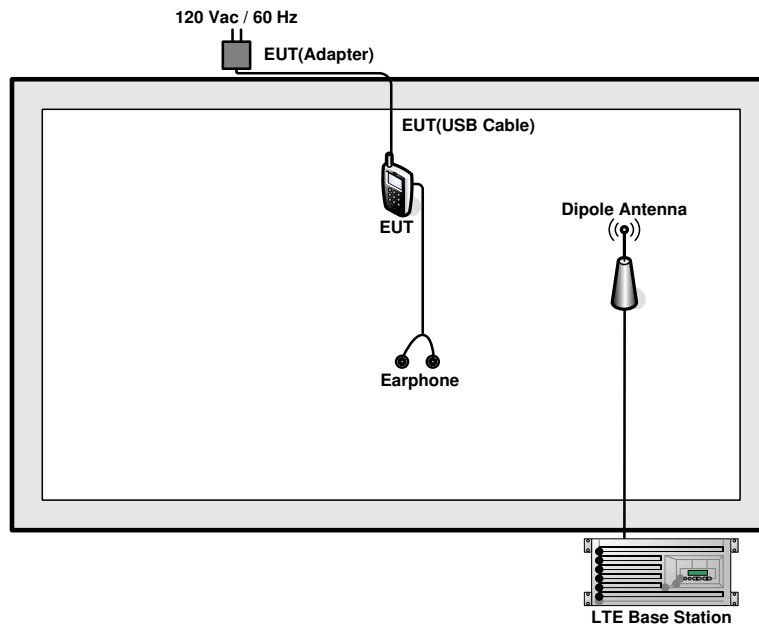



2.3 Support Unit used in test configuration and system

Item	Equipment	Trade Name	Model No.	FCC ID	Data Cable	Power Cord
1.	LTE Base Station	Anritsu	MT8820C	N/A	N/A	Unshielded, 1.8 m
2.	DC Power Supply	GW	GPS-3030D	N/A	N/A	Unshielded, 1.8 m
3.	Earphone	Lenovo	SH100	N/A	Unshielded,1.2m	N/A

2.4 Measurement Results Explanation Example

For all conducted test items:

The offset level is set in the spectrum analyzer to compensate the RF cable loss factor between EUT conducted output port and spectrum analyzer. With the offset compensation, the spectrum analyzer reading level is exactly the EUT RF output level.

The spectrum analyzer offset is derived from RF cable loss.

$$\text{Offset} = \text{RF cable loss.}$$

Following shows an offset computation example with cable loss 5.2 dB.

Example :

$$\begin{aligned} \text{Offset(dB)} &= \text{RF cable loss(dB)}. \\ &= 5.2 \text{ (dB)} \end{aligned}$$



2.5 Frequency List of Low/Middle/High Channels

LTE Band 2 Channel and Frequency List				
BW [MHz]	Channel/Frequency(MHz)	Lowest	Middle	Highest
20	Channel	18700	18900	19100
	Frequency	1860	1880	1900
15	Channel	18675	18900	19125
	Frequency	1857.5	1880	1902.5
10	Channel	18650	18900	19150
	Frequency	1855	1880	1905
5	Channel	18625	18900	19175
	Frequency	1852.5	1880	1907.5
3	Channel	18615	18900	19185
	Frequency	1851.5	1880	1908.5
1.4	Channel	18607	18900	19193
	Frequency	1850.7	1880	1909.3

LTE Band 4 Channel and Frequency List				
BW [MHz]	Channel/Frequency(MHz)	Lowest	Middle	Highest
20	Channel	20050	20175	20300
	Frequency	1720	1732.5	1745
15	Channel	20025	20175	20325
	Frequency	1717.5	1732.5	1747.5
10	Channel	20000	20175	20350
	Frequency	1715	1732.5	1750
5	Channel	19975	20175	20375
	Frequency	1712.5	1732.5	1752.5
3	Channel	19965	20175	20385
	Frequency	1711.5	1732.5	1753.5
1.4	Channel	19957	20175	20393
	Frequency	1710.7	1732.5	1754.3



LTE Band 5 Channel and Frequency List				
BW [MHz]	Channel/Frequency(MHz)	Lowest	Middle	Highest
10	Channel	20450	20525	20600
	Frequency	829	836.5	844
5	Channel	20425	20525	20625
	Frequency	826.5	836.5	846.5
3	Channel	20415	20525	20635
	Frequency	825.5	836.5	847.5
1.4	Channel	20407	20525	20643
	Frequency	824.7	836.5	848.3

LTE Band 13 Channel and Frequency List				
BW [MHz]	Channel/Frequency(MHz)	Lowest	Middle	Highest
10	Channel	-	23230	-
	Frequency	-	782	-
5	Channel	23205	23230	23255
	Frequency	779.5	782	784.5

3 Conducted Test Items

3.1 Measuring Instruments

See list of measuring instruments of this test report.

3.2 Test Setup

3.2.1 Conducted Output Power

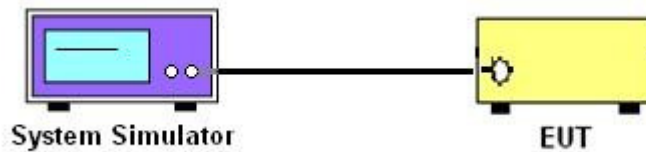

3.2.2 Peak-to-Average Ratio, Occupied Bandwidth ,Conducted Band-Edge and Conducted Spurious Emission

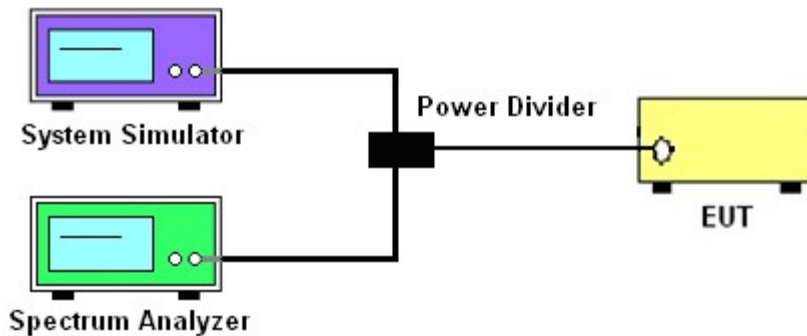

3.2.3 Frequency Stability

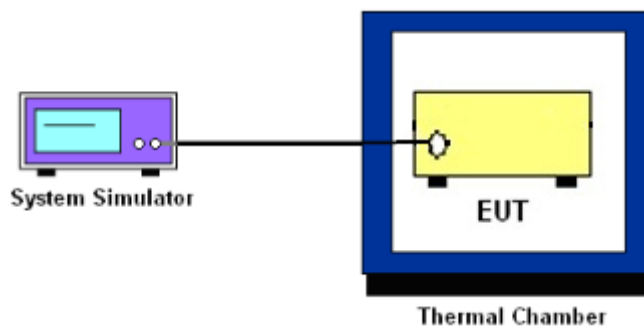

3.3 Test Result of Conducted Test

Please refer to Appendix A.



3.4 Conducted Output Power and ERP/EIRP

3.4.1 Description of the Conducted Output Power Measurement and ERP/EIRP Measurement

A system simulator was used to establish communication with the EUT. Its parameters were set to force the EUT transmitting at maximum output power. The measured power in the radio frequency on the transmitter output terminals shall be reported.

The ERP of mobile transmitters must not exceed 7 Watts for LTE Band 5.

The ERP of mobile transmitters must not exceed 3 Watts for Band 13.

The EIRP of mobile transmitters must not exceed 2 Watts for LTE Band 2.

The EIRP of mobile transmitters must not exceed 1 Watts for LTE Band 4.

According to KDB 412172 D01 Power Approach,

$EIRP = P_T + G_T - L_C$, $ERP = EIRP - 2.15$, where

P_T = transmitter output power in dBm

G_T = gain of the transmitting antenna in dBi

L_C = signal attenuation in the connecting cable between the transmitter and antenna in dB

3.4.2 Test Procedures

1. The transmitter output port was connected to the system simulator.
2. Set EUT at maximum power through the system simulator.
3. Select lowest, middle, and highest channels for each band and different modulation.
4. Measure and record the power level from the system simulator.



3.5 Peak-to-Average Ratio

3.5.1 Description of the PAR Measurement

Power Complementary Cumulative Distribution Function (CCDF) curves provide a means for characterizing the power peaks of a digitally modulated signal on a statistical basis. A CCDF curve depicts the probability of the peak signal amplitude exceeding the average power level. Most contemporary measurement instrumentation include the capability to produce CCDF curves for an input signal provided that the instrument's resolution bandwidth can be set wide enough to accommodate the entire input signal bandwidth. In measuring transmissions in this band using an average power technique, the peak-to-average ratio (PAR) of the transmission may not exceed 13 dB.

3.5.2 Test Procedures

1. The testing follows FCC KDB 971168 v02r02 Section 5.7.1.
2. The EUT was connected to spectrum and system simulator via a power divider.
3. Set the CCDF (Complementary Cumulative Distribution Function) option in spectrum analyzer.
4. The highest RF powers were measured and recorded the maximum PAPR level associated with a probability of 0.1 %.
5. Record the deviation as Peak to Average Ratio.



3.6 Occupied Bandwidth

3.6.1 Description of Occupied Bandwidth Measurement

The occupied bandwidth is the width of a frequency band such that, below the lower and above the upper frequency limits, the mean powers emitted are each equal to a specified percentage 0.5% of the total mean transmitted power.

The 26 dB emission bandwidth is defined as the frequency range between two points, one above and one below the carrier frequency, at which the spectral density of the emission is attenuated 26 dB below the maximum in-band spectral density of the modulated signal. Spectral density (power per unit bandwidth) is to be measured with a detector of resolution bandwidth equal to approximately 1.0% of the emission bandwidth.

3.6.2 Test Procedures

1. The testing follows FCC KDB 971168 v02r02 Section 4.1 and 4.2.
2. The EUT was connected to spectrum analyzer and system simulator via a power divider.
3. The spectrum analyzer center frequency is set to the nominal EUT channel center frequency. The span range for the spectrum analyzer shall be between two and five times the anticipated OBW.
4. The nominal resolution bandwidth (RBW) shall be in the range of 1 to 5 % of the anticipated OBW, and the VBW shall be at least 3 times the RBW.
5. Set the detection mode to peak, and the trace mode to max hold.
6. Determine the reference value: Set the EUT to transmit a modulated signal. Allow the trace to stabilize. Set the spectrum analyzer marker to the highest level of the displayed trace.
(this is the reference value)
7. Determine the “-26 dB down amplitude” as equal to (Reference Value – X).
8. Place two markers, one at the lowest and the other at the highest frequency of the envelope of the spectral display such that each marker is at or slightly below the “-X dB down amplitude” determined in step 6. If a marker is below this “-X dB down amplitude” value it shall be placed as close as possible to this value. The OBW is the positive frequency difference between the two markers.
9. Use the 99 % power bandwidth function of the spectrum analyzer and report the measured bandwidth.



3.7 Conducted Band Edge

3.7.1 Description of Conducted Band Edge Measurement

22.917(a)

For operations in the 824 – 849 MHz band, the FCC limit is $43 + 10\log_{10}(P[\text{Watts}])$ dB below the transmitter power $P(\text{Watts})$ in a 100kHz bandwidth. However, in the 1MHz bands immediately outside and adjacent to the licensee's frequency block, a resolution bandwidth of at least one percent of the emission bandwidth of the fundamental emission of the transmitter may be employed.

24.238 (a)

For operations in the 1850-1910 and 1930-1990 MHz band, the FCC limit is $43 + 10\log_{10}(P[\text{Watts}])$ dB below the transmitter power $P(\text{Watts})$ in a 1MHz bandwidth. However, in the 1 MHz bands immediately outside and adjacent to the frequency block a resolution bandwidth of at least one percent of the emission bandwidth of the fundamental emission of the transmitter may be employed.

27.53 (c)

For operations in the 776-788 MHz band, the FCC limit is $43 + 10\log_{10}(P[\text{Watts}])$ dB below the transmitter power $P(\text{Watts})$ in a 100 kHz bandwidth. However, in the 100 kHz bands immediately outside and adjacent to the frequency block, a resolution bandwidth of at least 30 kHz may be employed. In addition, the power of any unwanted emissions in any 6.25 kHz bandwidth for all frequencies between 763-775 MHz and 793-806 MHz shall be attenuated below the transmitter power, P (dBW), by at least $65 + 10 \log_{10} p(\text{watts})$, dB, for mobile and portable equipment.

27.53 (h)

For operations in the 1710 – 1755 MHz band, the FCC limit is $43 + 10\log_{10}(P[\text{Watts}])$ dB below the transmitter power $P(\text{Watts})$ in a 1 MHz bandwidth. However, in the 1MHz bands immediately outside and adjacent to the licensee's frequency block, a resolution bandwidth of at least one percent of the emission bandwidth of the fundamental emission of the transmitter may be employed.



3.7.2 Test Procedures

1. The testing follows FCC KDB 971168 v02r02 Section 6.0.
2. The EUT was connected to spectrum analyzer and system simulator via a power divider.
3. The band edges of low and high channels for the highest RF powers were measured.
4. Set RBW \geq 1% EBW in the 1MHz band immediately outside and adjacent to the band edge.
5. Beyond the 1 MHz band from the band edge, RBW=1MHz was used.
6. Set spectrum analyzer with RMS detector.
7. The RF fundamental frequency should be excluded against the limit line in the operating frequency band.
8. Checked that all the results comply with the emission limit line.

Example:

The limit line is derived from $43 + 10\log(P)$ dB below the transmitter power P(Watts)
= P(W)- [43 + 10log(P)] (dB)
= [30 + 10log(P)] (dBm) - [43 + 10log(P)] (dB) = -13dBm.



3.8 Conducted Spurious Emission

3.8.1 Description of Conducted Spurious Emission Measurement

The power of any emission outside of the authorized operating frequency ranges must be lower than the transmitter power (P) by a factor of at least $43 + 10 \log (P)$ dB.

It is measured by means of a calibrated spectrum analyzer and scanned from 30 MHz up to a frequency including its 10th harmonic.

3.8.2 Test Procedures

1. The testing follows FCC KDB 971168 v02r02 Section 6.0.
2. The EUT was connected to spectrum analyzer and system simulator via a power divider.
3. The RF output of EUT was connected to the spectrum analyzer by RF cable and attenuator. The path loss was compensated to the results for each measurement.
4. The middle channel for the highest RF power within the transmitting frequency was measured.
5. The conducted spurious emission for the whole frequency range was taken.
6. Make the measurement with the spectrum analyzer's RBW = 1MHz, VBW = 3MHz.
7. Set spectrum analyzer with RMS detector.
8. Taking the record of maximum spurious emission.
9. The RF fundamental frequency should be excluded against the limit line in the operating frequency band.
10. The limit line is derived from $43 + 10\log(P)$ dB below the transmitter power P(Watts)
= P(W)- [43 + 10log(P)] (dB)
= [30 + 10log(P)] (dBm) - [43 + 10log(P)] (dB)
= -13dBm.



3.9 Frequency Stability

3.9.1 Description of Frequency Stability Measurement

The frequency stability shall be measured by variation of ambient temperature and variation of primary supply voltage to ensure that the fundamental emission stays within the authorized frequency block. The frequency stability of the transmitter shall be maintained within $\pm 0.00025\%$ ($\pm 2.5\text{ppm}$) of the center frequency.

3.9.2 Test Procedures for Temperature Variation

1. The testing follows FCC KDB 971168 v02r02 Section 9.0.
2. The EUT was set up in the thermal chamber and connected with the system simulator.
3. With power OFF, the temperature was decreased to -30°C and the EUT was stabilized before testing. Power was applied and the maximum change in frequency was recorded within one minute.
4. With power OFF, the temperature was raised in 10°C step up to 50°C . The EUT was stabilized at each step for at least half an hour. Power was applied and the maximum frequency change was recorded within one minute.

3.9.3 Test Procedures for Voltage Variation

1. The testing follows FCC KDB 971168 v02r02 Section 9.0.
2. The EUT was placed in a temperature chamber at $20\pm 5^{\circ}\text{C}$ and connected with the system simulator.
3. The power supply voltage to the EUT was varied from 85% to 115% of the nominal value measured at the input to the EUT.
4. The variation in frequency was measured for the worst case.

4 Radiated Test Items

4.1 Measuring Instruments

See list of measuring instruments of this test report.

4.2 Test Setup

4.2.1 For radiated test from 30MHz to 1GHz

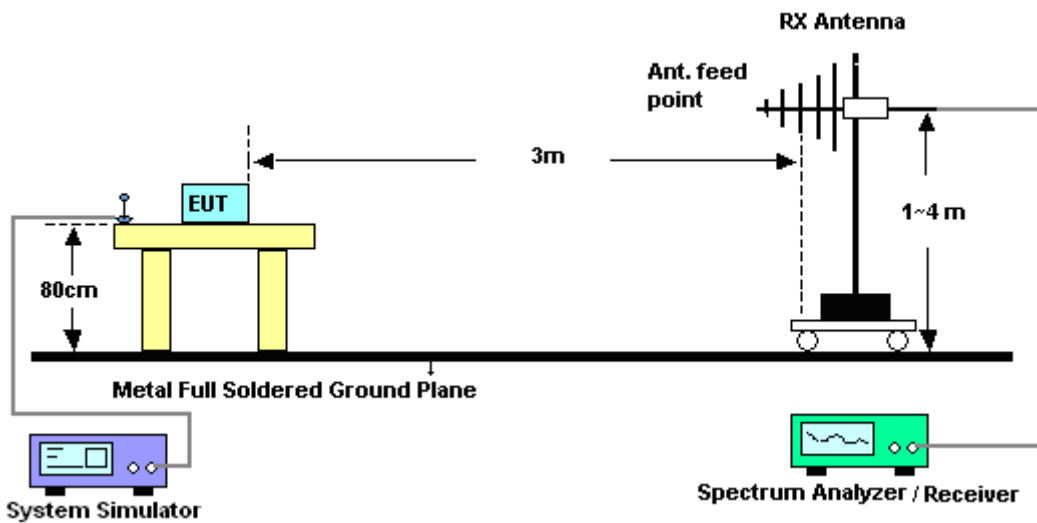

4.2.2 For radiated test above 1GHz

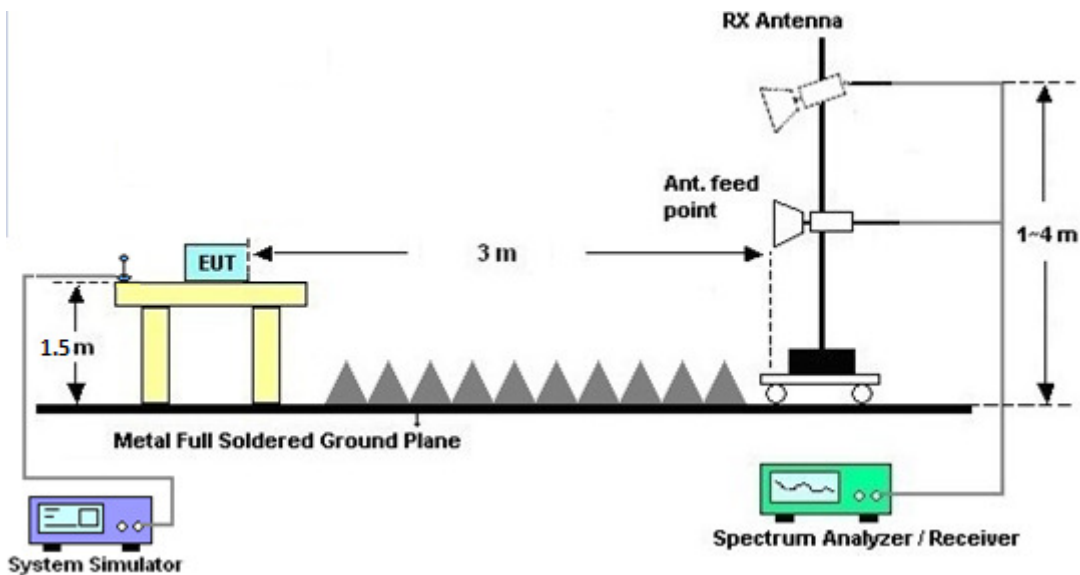

4.3 Test Result of Radiated Test

Please refer to Appendix B.



4.4 Radiated Spurious Emission

4.4.1 Description of Radiated Spurious Emission

The radiated spurious emission was measured by substitution method according to ANSI / TIA / EIA-603-D-2010. The power of any emission outside of the authorized operating frequency ranges must be attenuated below the transmitter power (P) by a factor of at least $43 + 10 \log (P)$ dB.

For LTE Band 13

For operations in the 746-758 MHz, 775-788 MHz, and 805-806 MHz bands, emissions in the band 1559-1610 MHz shall be limited to -70 dBW/MHz equivalent isotropically radiated power (EIRP) for wideband signals, and -80 dBW EIRP for discrete emissions of less than 700 Hz bandwidth.

The spectrum is scanned from 30 MHz up to a frequency including its 10th harmonic.

4.4.2 Test Procedures

1. The testing follows FCC KDB 971168 v02r02 Section 5.8 and ANSI / TIA-603-D-2010 Section 2.2.12.
2. The EUT was placed on a turntable with 0.8 meter height for frequency below 1GHz and 1.5 meter height for frequency above 1GHz respectively above ground.
3. The EUT was set 3 meters from the receiving antenna mounted on the antenna tower.
4. The table was rotated 360 degrees to determine the position of the highest spurious emission.
5. The height of the receiving antenna is varied between 1m to 4m to search the maximum spurious emission for both horizontal and vertical polarizations.
6. During the measurement, the system simulator parameters were set to force the EUT transmitting at maximum output power.
7. Make the measurement with the spectrum analyzer's RBW = 1MHz, VBW = 3MHz, taking the record of maximum spurious emission.
8. A horn antenna was substituted in place of the EUT and was driven by a signal generator.
9. Tune the output power of signal generator to the same emission level with EUT maximum spurious emission.
10. $EIRP \text{ (dBm)} = S.G. \text{ Power} - Tx \text{ Cable Loss} + Tx \text{ Antenna Gain}$
11. $ERP \text{ (dBm)} = EIRP - 2.15$
12. The RF fundamental frequency should be excluded against the limit line in the operating frequency band.

The limit line is derived from $43 + 10\log(P)$ dB below the transmitter power P(Watts)
 $= P(W) - [43 + 10\log(P)] \text{ (dB)}$
 $= [30 + 10\log(P)] \text{ (dBm)} - [43 + 10\log(P)] \text{ (dB)}$
 $= -13\text{dBm}.$



5 List of Measuring Equipment

Instrument	Manufacturer	Model No.	Serial No.	Characteristics	Calibration Date	Test Date	Due Date	Remark
Spectrum Analyzer	R&S	FSV40	101040	10Hz~40GHz	Aug. 9, 2016	Apr. 14, 2017~ Apr. 15, 2017	Aug. 8, 2017	Conducted (TH01-KS)
Thermal Chamber	Ten Billion	TTC-B3S	TBN-960502	-40~+150°C	Oct.13, 2016	Apr. 14, 2017~ Apr. 15, 2017	Oct.13, 2017	Conducted (TH01-KS)
Radio communication	Anritsu	MT8820C	6201300652	2G/3G/LTE Band	Aug. 08, 2016	Apr. 14, 2017~ Apr. 15, 2017	Aug. 07, 2017	Conducted (TH01-KS)
EXA Spectrum Analyzer	Keysight	N9010A	MY55150244	10Hz-44GHz	Apr. 22, 2016	Apr. 14, 2017~ Apr. 20, 2017	Apr. 21, 2017	Radiation (03CH03-KS)
Bilog Antenna	TeseQ	CBL6112D	35406	25MHz-2GHz	Apr. 22, 2016	Apr. 14, 2017~ Apr. 20, 2017	Apr 21, 2017	Radiation (03CH03-KS)
Horn Antenna	Schwarzbeck	BBHA9120D	9120D-1356	1GHz~18GHz	Apr. 22, 2016	Apr. 14, 2017~ Apr. 20, 2017	Apr 21, 2017	Radiation (03CH03-KS)
SHF-EHF Horn	com-power	AH-840	101070	18GHz ~40GHz	Oct. 19, 2016	Apr. 14, 2017~ Apr. 20, 2017	Oct. 18, 2017	Radiation (03CH03-KS)
Amplifier	SONOMA	310N	187289	9kHz~1GHz	Aug. 09, 2016	Apr. 14, 2017~ Apr. 20, 2017	Aug. 08, 2017	Radiation (03CH03-KS)
high gain Amplifier	MITEQ	AMF-7D-00 101800-30-1 0P	2025788	1Ghz-18Ghz	Jan. 19, 2017	Apr. 14, 2017~ Apr. 20, 2017	Jan. 18, 2018	Radiation (03CH03-KS)
Amplifier	MITEQ	TTA1840-35 -HG	1887435	18~40GHz	Oct. 13, 2016	Apr. 14, 2017~ Apr. 20, 2017	Oct. 12, 2017	Radiation (03CH03-KS)
Amplifier	Agilent	8449B	3008A02370	1GHz~26.5GHz	Oct. 13, 2016	Apr. 14, 2017~ Apr. 20, 2017	Oct. 12, 2017	Radiation (03CH03-KS)
AC Power Source	Chroma	61601	F104090004	N/A	NCR	Apr. 14, 2017~ Apr. 20, 2017	NCR	Radiation (03CH03-KS)
Turn Table	ChamPro	EM 1000-T	060762-T	0~360 degree	NCR	Apr. 14, 2017~ Apr. 20, 2017	NCR	Radiation (03CH03-KS)
Antenna Mast	ChamPro	EM 1000-A	060762-A	1 m~4 m	NCR	Apr. 14, 2017~ Apr. 20, 2017	NCR	Radiation (03CH03-KS)

NCR: No Calibration Required



6 Uncertainty of Evaluation

Uncertainty of Radiated Emission Measurement (30 MHz ~ 1000 MHz)

Measuring Uncertainty for a Level of Confidence of 95% ($U = 2Uc(y)$)	2.8dB
-------------------------------------------------------------------------	-------

Uncertainty of Radiated Emission Measurement (1 GHz ~ 40 GHz)

Measuring Uncertainty for a Level of Confidence of 95% ($U = 2Uc(y)$)	3.3dB
-------------------------------------------------------------------------	-------



Appendix A. Test Results of Conducted Test

Conducted Output Power(Average power)

LTE Band 2 Maximum Average Power [dBm]						
BW [MHz]	RB Size	RB Offset	Mod	Lowest	Middle	Highest
20	1	0	QPSK	22.93	22.94	22.84
20	1	49		22.87	22.87	22.79
20	1	99		22.69	22.71	22.62
20	50	0		21.74	21.93	21.84
20	50	24		21.70	21.79	21.79
20	50	50		21.71	21.75	21.67
20	100	0		21.64	21.74	21.77
20	1	0	16-QAM	21.58	21.92	21.66
20	1	49		21.56	21.79	21.83
20	1	99		21.45	21.89	21.50
20	50	0		20.86	20.85	20.88
20	50	24		20.54	20.71	20.75
20	50	50		20.74	20.68	20.72
20	100	0		20.65	20.84	20.69
15	1	0	QPSK	22.61	22.77	22.77
15	1	37		22.74	22.63	22.72
15	1	74		22.73	22.76	22.55
15	36	0		21.67	21.80	21.90
15	36	20		21.72	21.72	21.78
15	36	39		21.76	21.72	21.74
15	75	0		21.65	21.75	21.77
15	1	0	16-QAM	21.53	21.76	21.80
15	1	37		21.47	21.43	21.55
15	1	74		21.82	21.75	21.32
15	36	0		20.81	20.81	20.87
15	36	20		20.64	20.73	20.72
15	36	39		20.78	20.63	20.68
15	75	0		20.67	20.75	20.61



LTE Band 2 Maximum Average Power [dBm]						
BW [MHz]	RB Size	RB Offset	Mod	Lowest	Middle	Highest
10	1	0	QPSK	22.77	22.86	22.67
10	1	25		22.94	22.96	22.76
10	1	49		22.69	22.99	22.70
10	25	0		21.72	21.80	21.70
10	25	12		21.73	21.84	21.79
10	25	25		21.59	21.78	21.57
10	50	0		21.72	21.75	21.67
10	1	0	16-QAM	21.81	21.82	21.96
10	1	25		21.96	21.94	21.91
10	1	49		21.89	21.87	21.83
10	25	0		20.67	20.62	20.72
10	25	12		20.89	20.75	20.63
10	25	25		20.49	20.53	20.52
10	50	0		20.75	20.65	20.62
5	1	0	QPSK	22.43	22.53	22.60
5	1	12		22.73	22.64	22.64
5	1	24		22.51	22.67	22.49
5	12	0		21.62	21.76	21.67
5	12	7		21.67	21.69	21.64
5	12	13		21.63	21.70	21.55
5	25	0		21.65	21.77	21.61
5	1	0	16-QAM	21.65	21.89	21.89
5	1	12		21.89	21.85	21.55
5	1	24		21.96	21.85	21.62
5	12	0		20.64	20.66	20.59
5	12	7		20.52	20.70	20.59
5	12	13		20.50	20.67	20.58
5	25	0		20.54	20.89	20.79



LTE Band 2 Maximum Average Power [dBm]						
BW [MHz]	RB Size	RB Offset	Mod	Lowest	Middle	Highest
3	1	0	QPSK	22.57	22.65	22.31
3	1	8		22.60	22.57	22.36
3	1	14		22.65	22.54	22.42
3	8	0		21.61	21.75	21.64
3	8	4		21.63	21.80	21.63
3	8	7		21.63	21.82	21.64
3	15	0		21.57	21.71	21.55
3	1	0	16-QAM	21.77	21.57	21.66
3	1	8		21.76	21.41	21.29
3	1	14		21.83	21.76	21.34
3	8	0		20.63	20.63	20.79
3	8	4		20.78	20.48	20.49
3	8	7		20.81	20.50	20.55
3	15	0		20.82	20.32	20.60
1.4	1	0	QPSK	22.52	22.72	22.46
1.4	1	3		22.69	22.79	22.57
1.4	1	5		22.69	22.58	22.50
1.4	3	0		22.67	22.71	22.53
1.4	3	1		22.77	22.88	22.56
1.4	3	3		22.70	22.80	22.54
1.4	6	0		21.69	21.81	21.60
1.4	1	0	16-QAM	21.63	21.97	21.66
1.4	1	3		21.70	21.99	21.72
1.4	1	5		21.62	21.51	21.67
1.4	3	0		21.49	21.85	21.94
1.4	3	1		21.72	21.94	21.62
1.4	3	3		21.94	21.95	21.96
1.4	6	0		20.46	20.69	20.24



LTE Band 4 Maximum Average Power [dBm]						
BW [MHz]	RB Size	RB Offset	Mod	Lowest	Middle	Highest
20	1	0	QPSK	22.49	22.68	22.81
20	1	49		22.60	22.92	22.90
20	1	99		22.56	22.80	22.33
20	50	0		21.77	21.84	21.75
20	50	24		21.62	21.68	21.77
20	50	50		21.58	21.77	21.70
20	100	0		21.71	21.84	21.72
20	1	0	16-QAM	21.95	21.83	21.95
20	1	49		21.90	21.73	21.79
20	1	99		21.70	21.71	21.57
20	50	0		20.73	20.76	20.94
20	50	24		20.56	20.68	20.70
20	50	50		20.62	20.68	20.74
20	100	0		20.64	20.81	20.86
15	1	0	QPSK	22.56	22.64	22.89
15	1	37		22.39	22.91	22.69
15	1	74		22.20	22.72	22.52
15	36	0		21.64	21.76	21.87
15	36	20		21.63	21.72	21.67
15	36	39		21.52	21.77	21.63
15	75	0		21.61	21.77	21.77
15	1	0	16-QAM	21.94	21.81	21.86
15	1	37		21.23	21.86	21.84
15	1	74		21.54	21.84	21.74
15	36	0		20.55	20.75	20.97
15	36	20		20.66	20.70	20.82
15	36	39		20.43	20.77	20.67
15	75	0		20.73	20.56	20.80



LTE Band 4 Maximum Average Power [dBm]						
BW [MHz]	RB Size	RB Offset	Mod	Lowest	Middle	Highest
10	1	0	QPSK	22.51	22.60	22.70
10	1	25		22.52	22.58	22.50
10	1	49		22.23	22.55	22.43
10	25	0		21.62	21.74	21.72
10	25	12		21.46	21.70	21.74
10	25	25		21.53	21.67	21.75
10	50	0		21.48	21.69	21.78
10	1	0	16-QAM	21.78	21.98	21.95
10	1	25		21.66	21.84	21.97
10	1	49		21.62	21.69	21.45
10	25	0		20.66	20.93	20.74
10	25	12		20.61	20.90	20.99
10	25	25		20.48	20.87	20.73
10	50	0		20.50	20.77	20.63
5	1	0	QPSK	22.59	22.46	22.63
5	1	12		22.45	22.77	22.50
5	1	24		22.28	22.55	22.36
5	12	0		21.51	21.59	21.70
5	12	7		21.52	21.69	21.72
5	12	13		21.44	21.65	21.62
5	25	0		21.44	21.64	21.59
5	1	0	16-QAM	21.71	21.83	21.90
5	1	12		21.63	22.00	21.51
5	1	24		21.52	21.58	21.50
5	12	0		20.54	20.59	20.75
5	12	7		20.37	20.59	20.57
5	12	13		20.38	20.55	20.66
5	25	0		20.48	20.55	20.61



LTE Band 4 Maximum Average Power [dBm]						
BW [MHz]	RB Size	RB Offset	Mod	Lowest	Middle	Highest
3	1	0	QPSK	22.53	22.50	22.79
3	1	8		22.38	22.45	22.61
3	1	14		22.32	22.63	22.52
3	8	0		21.61	21.59	21.66
3	8	4		21.55	21.60	21.68
3	8	7		21.51	21.66	21.61
3	15	0		21.47	21.67	21.70
3	1	0	16-QAM	21.75	21.68	21.94
3	1	8		21.60	21.84	21.83
3	1	14		21.63	21.90	21.68
3	8	0		20.40	20.42	20.95
3	8	4		20.27	20.44	20.41
3	8	7		20.30	20.52	20.48
3	15	0		20.23	20.77	20.61
1.4	1	0	QPSK	22.38	22.50	22.54
1.4	1	3		22.42	22.60	22.65
1.4	1	5		22.32	22.61	22.53
1.4	3	0		22.46	22.62	22.83
1.4	3	1		22.49	22.68	22.65
1.4	3	3		22.48	22.64	22.49
1.4	6	0		21.53	21.61	21.60
1.4	1	0	16-QAM	21.48	21.56	21.65
1.4	1	3		21.39	21.97	21.45
1.4	1	5		21.20	21.80	21.57
1.4	3	0		21.30	21.65	21.48
1.4	3	1		21.60	21.72	21.69
1.4	3	3		21.76	21.76	21.35
1.4	6	0		20.51	20.48	20.48



LTE Band 5 Maximum Average Power [dBm]						
BW [MHz]	RB Size	RB Offset	Mod	Lowest	Middle	Highest
10	1	0	QPSK	22.73	23.02	22.74
10	1	25		22.97	23.22	23.05
10	1	49		22.78	22.77	22.66
10	25	0		21.93	22.01	22.01
10	25	12		21.91	21.95	22.07
10	25	25		21.82	22.10	21.89
10	50	0		21.91	21.95	22.02
10	1	0	16-QAM	21.69	22.47	22.17
10	1	25		21.98	21.81	22.48
10	1	49		21.66	21.69	22.25
10	25	0		21.00	21.04	21.30
10	25	12		21.10	21.10	21.49
10	25	25		21.09	21.16	21.28
10	50	0		20.93	21.00	20.95
5	1	0	QPSK	22.99	23.18	23.21
5	1	12		23.17	23.17	23.23
5	1	24		23.10	22.72	22.93
5	12	0		21.98	22.03	22.05
5	12	7		21.94	21.90	21.99
5	12	13		22.03	21.87	21.96
5	25	0		21.92	21.90	22.00
5	1	0	16-QAM	21.90	22.00	22.26
5	1	12		22.11	21.79	21.82
5	1	24		22.40	21.79	21.69
5	12	0		20.95	21.02	21.11
5	12	7		20.91	20.76	20.97
5	12	13		21.00	20.85	20.94
5	25	0		20.99	21.09	21.16



LTE Band 5 Maximum Average Power [dBm]						
BW [MHz]	RB Size	RB Offset	Mod	Lowest	Middle	Highest
3	1	0	QPSK	23.03	22.90	23.07
3	1	8		22.80	22.61	22.71
3	1	14		22.74	22.71	22.76
3	8	0		21.90	22.02	22.06
3	8	4		21.98	21.93	22.00
3	8	7		21.95	21.90	21.98
3	15	0		21.99	21.96	22.04
3	1	0	16-QAM	22.19	22.38	22.02
3	1	8		22.12	22.12	22.16
3	1	14		22.07	21.99	22.12
3	8	0		20.75	20.92	21.19
3	8	4		21.09	20.94	21.23
3	8	7		21.06	20.82	20.82
3	15	0		21.14	20.86	21.02
1.4	1	0	QPSK	22.72	22.72	23.05
1.4	1	3		22.75	22.76	23.01
1.4	1	5		22.84	22.67	22.89
1.4	3	0		22.75	22.81	23.10
1.4	3	1		22.75	22.85	23.09
1.4	3	3		22.74	22.89	23.04
1.4	6	0		21.81	21.98	22.09
1.4	1	0	16-QAM	22.00	22.00	22.12
1.4	1	3		22.08	22.31	22.41
1.4	1	5		21.74	22.42	22.31
1.4	3	0		21.91	22.26	22.22
1.4	3	1		21.83	22.26	22.26
1.4	3	3		21.76	21.86	22.25
1.4	6	0		20.68	20.44	21.04



LTE Band 13 Maximum Average Power [dBm]						
BW [MHz]	RB Size	RB Offset	Mod	Lowest	Middle	Highest
10	1	0	QPSK		23.17	
10	1	25			22.99	
10	1	49			22.88	
10	25	0			22.02	
10	25	12			21.94	
10	25	25			21.89	
10	50	0			22.00	
10	1	0	16-QAM		22.19	
10	1	25			21.70	
10	1	49			22.04	
10	25	0			21.13	
10	25	12			21.09	
10	25	25			21.01	
10	50	0			20.78	
5	1	0	QPSK	22.77	22.91	23.08
5	1	12		22.93	22.86	23.03
5	1	24		22.76	22.85	22.93
5	12	0		22.14	22.10	21.94
5	12	7		21.97	21.90	21.83
5	12	13		21.95	21.87	21.85
5	25	0		22.04	21.86	21.87
5	1	0	16-QAM	22.03	22.49	22.02
5	1	12		21.83	22.12	21.60
5	1	24		21.71	22.01	22.17
5	12	0		20.99	20.93	20.96
5	12	7		21.05	20.92	20.83
5	12	13		20.79	20.80	20.84
5	25	0		20.78	20.82	20.96



ERP/EIRP

LTE Band 2 (G _T - L _C = 2.2 dB) QPSK									
Bandwidth	1.4M			3M			5M		
Channel	18607	18900	19193	18615	18900	19185	18625	18900	19175
	(Low)	(Mid)	(High)	(Low)	(Mid)	(High)	(Low)	(Mid)	(High)
Frequency	1850.7	1880	1909.3	1851.5	1880	1908.5	1852.5	1880	1907.5
(MHz)									
Conducted Power (dBm)	22.77	22.88	22.56	22.65	22.54	22.42	22.73	22.64	22.64
Conducted Power (Watts)	0.1892	0.1941	0.1803	0.1841	0.1795	0.1746	0.1875	0.1837	0.1837
EIRP(dBm)	24.97	25.08	24.76	24.85	24.74	24.62	24.93	24.84	24.84
EIRP(Watts)	0.3141	0.3221	0.2992	0.3055	0.2979	0.2897	0.3112	0.3048	0.3048

LTE Band 2 (G _T - L _C = 2.2 dB) QPSK									
Bandwidth	10M			15M			20M		
Channel	18650	18900	19150	18675	18900	19125	18650	18900	19100
	(Low)	(Mid)	(High)	(Low)	(Mid)	(High)	(Low)	(Mid)	(High)
Frequency	1855	1880	1905	1857.5	1880	1902.5	1860	1880	1900
(MHz)									
Conducted Power (dBm)	22.69	22.99	22.70	22.61	22.77	22.77	22.93	22.94	22.84
Conducted Power (Watts)	0.1858	0.1991	0.1862	0.1824	0.1892	0.1892	0.1963	0.1968	0.1923
EIRP(dBm)	24.89	25.19	24.90	24.81	24.97	24.97	25.13	25.14	25.04
EIRP(Watts)	0.3083	0.3304	0.3090	0.3027	0.3141	0.3141	0.3258	0.3266	0.3192



LTE Band 2 (G _T - L _C = 2.2 dB) 16QAM									
Bandwidth	1.4M			3M			5M		
Channel	18607	18900	19193	18615	18900	19185	18625	18900	19175
	(Low)	(Mid)	(High)	(Low)	(Mid)	(High)	(Low)	(Mid)	(High)
Frequency (MHz)	1850.7	1880	1909.3	1851.5	1880	1908.5	1852.5	1880	1907.5
Conducted Power (dBm)	21.70	21.99	21.72	21.83	21.76	21.34	21.96	21.85	21.62
Conducted Power (Watts)	0.1479	0.1581	0.1486	0.1524	0.1500	0.1361	0.1570	0.1531	0.1452
EIRP(dBm)	23.90	24.19	23.92	24.03	23.96	23.54	24.16	24.05	23.82
EIRP(Watts)	0.2455	0.2624	0.2466	0.2529	0.2489	0.2259	0.2606	0.2541	0.2410

LTE Band 2 (G _T - L _C = 2.2 dB) 16QAM									
Bandwidth	10M			15M			20M		
Channel	18650	18900	19150	18675	18900	19125	18650	18900	19100
	(Low)	(Mid)	(High)	(Low)	(Mid)	(High)	(Low)	(Mid)	(High)
Frequency (MHz)	1855	1880	1905	1857.5	1880	1902.5	1860	1880	1900
Conducted Power (dBm)	21.96	21.94	21.91	21.82	21.75	21.32	21.58	21.92	21.66
Conducted Power (Watts)	0.1570	0.1563	0.1552	0.1521	0.1496	0.1355	0.1439	0.1556	0.1466
EIRP(dBm)	24.16	24.14	24.11	24.02	23.95	23.52	23.78	24.12	23.86
EIRP(Watts)	0.2606	0.2594	0.2576	0.2523	0.2483	0.2249	0.2388	0.2582	0.2432



LTE Band 4 (G _T - L _C = 2.3 dB) QPSK									
Bandwidth	1.4M			3M			5M		
Channel	19957	20175	20393	19965	20175	20385	19975	20175	20375
	(Low)	(Mid)	(High)	(Low)	(Mid)	(High)	(Low)	(Mid)	(High)
Frequency (MHz)	1710.7	1732.5	1754.3	1711.5	1732.5	1753.5	1712.5	1732.5	1752.5
Conducted Power (dBm)	22.46	22.62	22.83	22.53	22.50	22.79	22.45	22.77	22.50
Conducted Power (Watts)	0.1762	0.1828	0.1919	0.1791	0.1778	0.1901	0.1758	0.1892	0.1778
EIRP(dBm)	24.76	24.92	25.13	24.83	24.80	25.09	24.75	25.07	24.80
EIRP(Watts)	0.2992	0.3105	0.3258	0.3041	0.3020	0.3228	0.2985	0.3214	0.3020

LTE Band 4 (G _T - L _C = 2.3 dB) QPSK									
Bandwidth	10M			15M			20M		
Channel	20000	20175	20350	20025	20175	20325	20050	20175	20300
	(Low)	(Mid)	(High)	(Low)	(Mid)	(High)	(Low)	(Mid)	(High)
Frequency (MHz)	1715	1732.5	1750	1717.5	1732.5	1747.5	1720	1732.5	1745
Conducted Power (dBm)	22.51	22.60	22.70	22.39	22.91	22.69	22.60	22.92	22.90
Conducted Power (Watts)	0.1782	0.1820	0.1862	0.1734	0.1954	0.1858	0.1820	0.1959	0.1950
EIRP(dBm)	24.81	24.90	25.00	24.69	25.21	24.99	24.90	25.22	25.20
EIRP(Watts)	0.3027	0.3090	0.3162	0.2944	0.3319	0.3155	0.3090	0.3327	0.3311



LTE Band 4 (G _T - L _C = 2.3 dB) 16QAM									
Bandwidth	1.4M			3M			5M		
Channel	19957	20175	20393	19965	20175	20385	19975	20175	20375
	(Low)	(Mid)	(High)	(Low)	(Mid)	(High)	(Low)	(Mid)	(High)
Frequency (MHz)	1710.7	1732.5	1754.3	1711.5	1732.5	1753.5	1712.5	1732.5	1752.5
Conducted Power (dBm)	21.39	21.97	21.45	21.75	21.68	21.94	21.63	22.00	21.51
Conducted Power (Watts)	0.1377	0.1574	0.1396	0.1496	0.1472	0.1563	0.1455	0.1585	0.1416
EIRP(dBm)	23.69	24.27	23.75	24.05	23.98	24.24	23.93	24.30	23.81
EIRP(Watts)	0.2339	0.2673	0.2371	0.2541	0.2500	0.2655	0.2472	0.2692	0.2404

LTE Band 4 (G _T - L _C = 2.3 dB) 16QAM									
Bandwidth	10M			15M			20M		
Channel	20000	20175	20350	20025	20175	20325	20050	20175	20300
	(Low)	(Mid)	(High)	(Low)	(Mid)	(High)	(Low)	(Mid)	(High)
Frequency (MHz)	1715	1732.5	1750	1717.5	1732.5	1747.5	1720	1732.5	1745
Conducted Power (dBm)	21.78	21.98	21.98	21.94	21.81	21.86	21.95	21.83	21.95
Conducted Power (Watts)	0.1507	0.1578	0.1578	0.1563	0.1517	0.1535	0.1567	0.1524	0.1567
EIRP(dBm)	24.08	24.28	24.25	24.24	24.11	24.16	24.25	24.13	24.25
EIRP(Watts)	0.2559	0.2679	0.2661	0.2655	0.2576	0.2606	0.2661	0.2588	0.2661



LTE Band 5 ($G_T - L_C = 1.6$ dB) QPSK									
Bandwidth	1.4M			3M			5M		
Channel	20407	20525	20643	20415	20525	20635	20425	20525	20625
	(Low)	(Mid)	(High)	(Low)	(Mid)	(High)	(Low)	(Mid)	(High)
Frequency (MHz)	824.7	836.5	848.3	825.5	836.5	847.5	826.5	836.5	846.5
Conducted Power (dBm)	22.75	22.81	23.10	23.03	22.90	23.07	23.17	23.17	23.23
Conducted Power (Watts)	0.1884	0.1910	0.2042	0.2009	0.1950	0.2028	0.2075	0.2075	0.2104
ERP(dBm)	22.20	22.26	22.55	22.48	22.35	22.52	22.62	22.62	22.68
ERP(Watts)	0.1660	0.1683	0.1799	0.1770	0.1718	0.1786	0.1828	0.1828	0.1854

LTE Band 5 ($G_T - L_C = 1.6$ dB) QPSK			
Bandwidth	10M		
Channel	20450	20525	20600
	(Low)	(Mid)	(High)
Frequency (MHz)	829	836.5	844
Conducted Power (dBm)	22.97	23.22	23.05
Conducted Power (Watts)	0.1982	0.2099	0.2018
ERP(dBm)	22.42	22.67	22.50
ERP(Watts)	0.1746	0.1849	0.1778



LTE Band 5 (G _T - L _C = 1.6 dB) 16QAM									
Bandwidth	1.4M			3M			5M		
Channel	20407	20525	20643	20415	20525	20635	20425	20525	20625
	(Low)	(Mid)	(High)	(Low)	(Mid)	(High)	(Low)	(Mid)	(High)
Frequency (MHz)	824.7	836.5	848.3	825.5	836.5	847.5	826.5	836.5	846.5
Conducted Power (dBm)	21.74	22.42	22.31	22.19	22.38	22.02	22.40	21.79	21.69
Conducted Power (Watts)	0.1493	0.1746	0.1702	0.1656	0.1730	0.1592	0.1738	0.1510	0.1476
ERP(dBm)	21.19	21.87	21.76	21.64	21.83	21.47	21.85	21.24	21.14
ERP(Watts)	0.1315	0.1538	0.1500	0.1459	0.1524	0.1403	0.1531	0.1330	0.1300

LTE Band 5 (G _T - L _C = 1.6 dB) 16QAM			
Bandwidth	10M		
Channel	20450	20525	20600
	(Low)	(Mid)	(High)
Frequency (MHz)	829	836.5	844
Conducted Power (dBm)	21.98	21.81	22.48
Conducted Power (Watts)	0.1578	0.1517	0.1770
ERP(dBm)	21.43	21.26	21.93
ERP(Watts)	0.1390	0.1337	0.1560



LTE Band 13 (G _T - L _C = 2.3 dB) QPSK						
Bandwidth	5M			10M		
Channel	23205	23230	23255	23230		
	(Low)	(Mid)	(High)	-	(Mid)	-
Frequency	779.5	782	784.5	-	782	-
(MHz)						
Conducted Power (dBm)	22.77	22.91	23.08		23.17	
Conducted Power (Watts)	0.1892	0.1954	0.2032		0.2075	
ERP(dBm)	22.92	23.06	23.23		23.32	
ERP(Watts)	0.1959	0.2023	0.2104		0.2148	

LTE Band 13 (G _T - L _C = 2.3 dB) 16QAM						
Bandwidth	5M			10M		
Channel	23205	23230	23255	23230		
	(Low)	(Mid)	(High)	-	(Mid)	-
Frequency	779.5	782	784.5	-	782	-
(MHz)						
Conducted Power (dBm)	22.03	22.49	22.02		22.19	
Conducted Power (Watts)	0.1596	0.1774	0.1592		0.1656	
ERP(dBm)	22.18	22.64	22.17		22.34	
ERP(Watts)	0.1652	0.1837	0.1648		0.1714	



Peak-to-Average Ratio

Mode	LTE Band 2 / 20MHz				
Mod.	QPSK		16QAM		Limit: 13dB
RB Size	1RB	Full RB	1RB	Full RB	Result
Lowest CH	4.23	4.87	5.48	5.83	PASS
Middle CH	3.22	4.29	3.65	5.39	
Highest CH	4.03	4.52	5.19	5.59	

Mode	LTE Band 4 / 20MHz				
Mod.	QPSK		16QAM		Limit: 13dB
RB Size	1RB	Full RB	1RB	Full RB	Result
Lowest CH	3.10	4.43	3.86	5.45	PASS
Middle CH	3.62	4.64	4.64	5.71	
Highest CH	3.54	4.12	4.46	5.28	

Mode	LTE Band 5 / 10MHz				
Mod.	QPSK		16QAM		Limit: 13dB
RB Size	1RB	Full RB	1RB	Full RB	Result
Lowest CH	4.20	4.00	5.10	5.39	PASS
Middle CH	3.83	4.99	4.75	5.86	
Highest CH	3.97	4.26	4.87	4.84	

Mode	LTE Band 13 / 10MHz				
Mod.	QPSK		16QAM		Limit: 13dB
RB Size	1RB	Full RB	1RB	Full RB	Result
Lowest CH	-	-	-	-	PASS
Middle CH	2.38	4.41	3.01	5.42	
Highest CH	-	-	-	-	



LTE Band 2 / 20MHz / QPSK

Lowest Channel / 1RB



Date: 14 APR 2017 13:43:27

Lowest Channel / Full RB

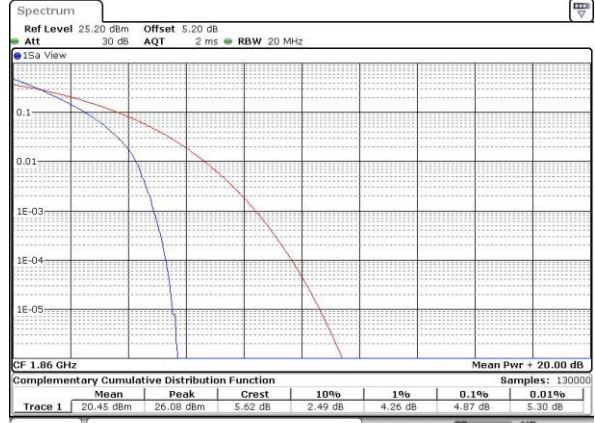

Date: 14 APR 2017 13:43:38

Middle Channel / 1RB



Date: 14 APR 2017 13:43:53

Middle Channel / Full RB



Date: 14 APR 2017 13:44:04

Highest Channel / 1RB



Date: 14 APR 2017 13:44:14

Highest Channel / Full RB



Date: 14 APR 2017 13:44:25



LTE Band 2 / 20MHz / 16QAM

Lowest Channel / 1RB

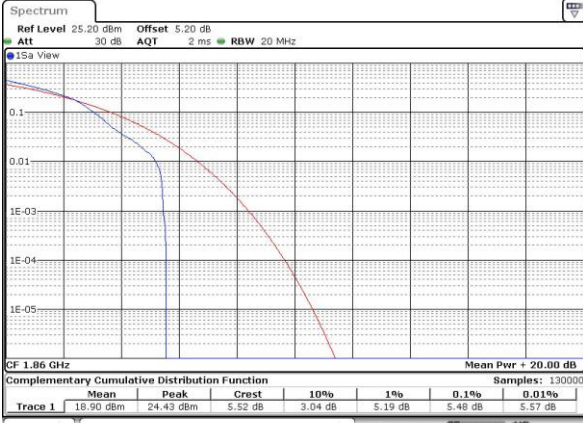

Date: 14 APR 2017 13:42:11

Lowest Channel / Full RB

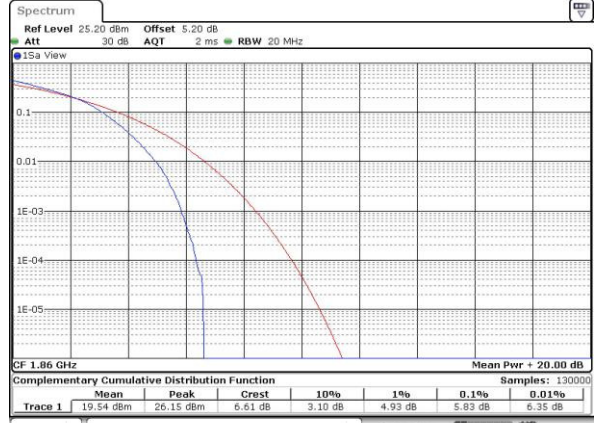

Date: 14 APR 2017 13:42:22

Middle Channel / 1RB



Date: 14 APR 2017 13:42:33

Middle Channel / Full RB

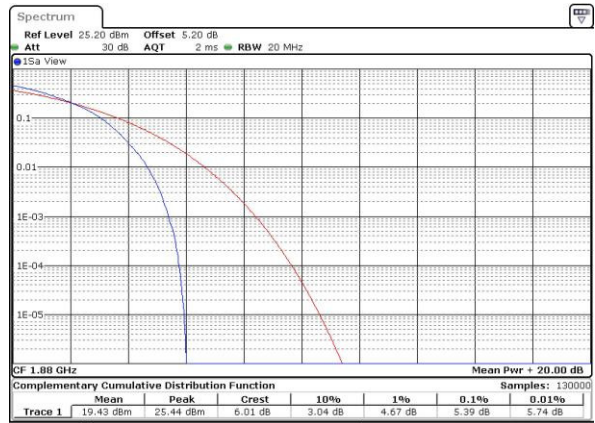

Date: 14 APR 2017 13:42:44

Highest Channel / 1RB



Date: 14 APR 2017 13:42:57

Highest Channel / Full RB



Date: 14 APR 2017 13:43:09



LTE Band 4 / 20MHz / QPSK

Lowest Channel / 1RB

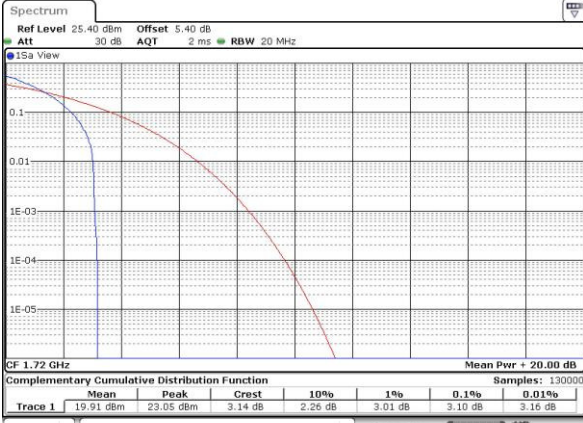

Date: 14 APR 2017 23:53:55

Lowest Channel / Full RB

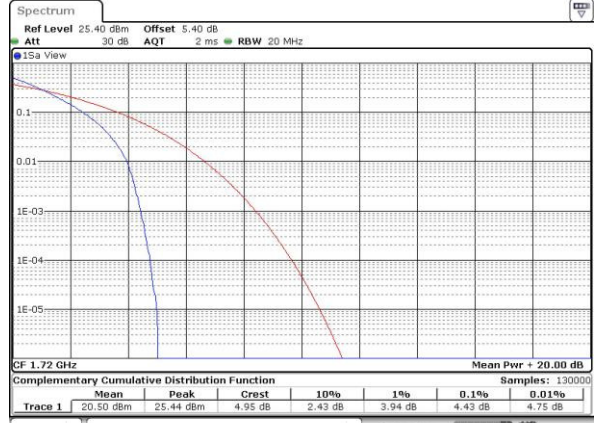

Date: 14 APR 2017 23:54:06

Middle Channel / 1RB



Date: 14 APR 2017 23:54:16

Middle Channel / Full RB



Date: 14 APR 2017 23:54:33

Highest Channel / 1RB

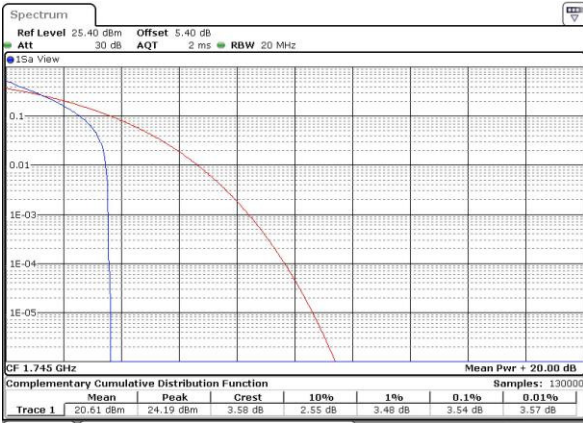

Date: 14 APR 2017 23:54:44

Highest Channel / Full RB



Date: 14 APR 2017 23:54:56



LTE Band 4 / 20MHz / 16QAM

Lowest Channel / 1RB

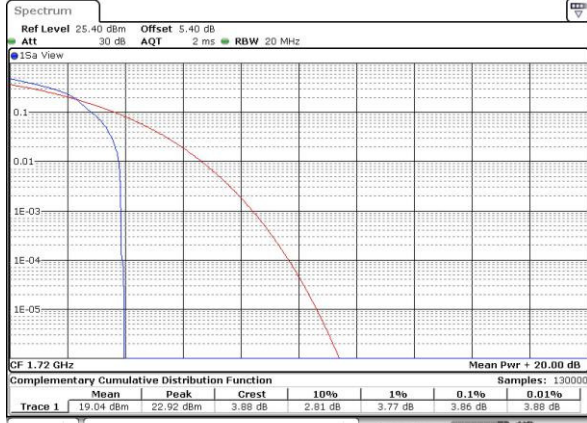

Date: 14 APR 2017 23:52:19

Lowest Channel / Full RB

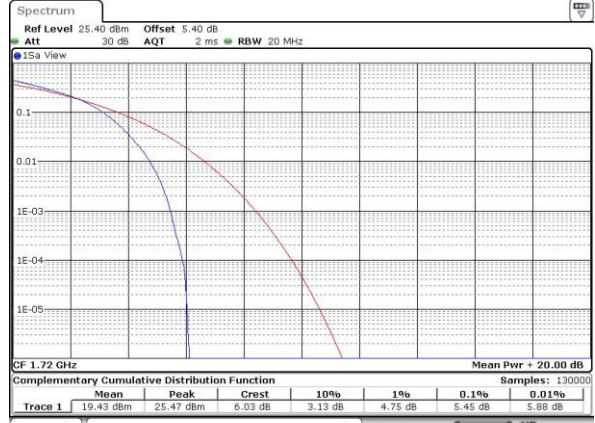

Date: 14 APR 2017 23:52:56

Middle Channel / 1RB

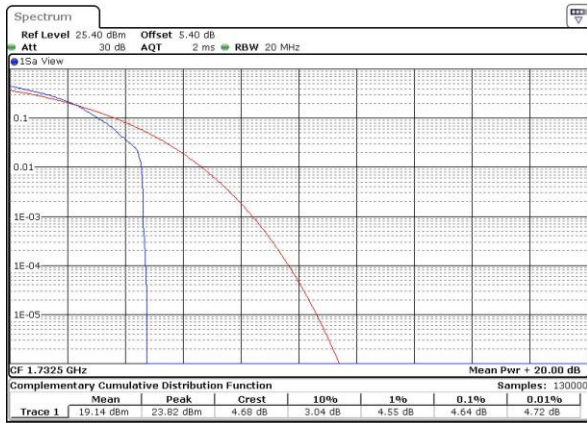

Date: 14 APR 2017 23:53:09

Middle Channel / Full RB



Date: 14 APR 2017 23:53:23

Highest Channel / 1RB



Date: 14 APR 2017 23:53:34

Highest Channel / Full RB

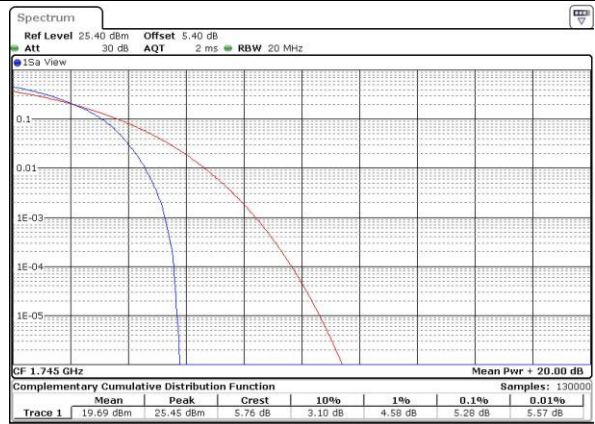

Date: 14 APR 2017 23:53:44



LTE Band 5 / 10MHz / QPSK

Lowest Channel / 1RB

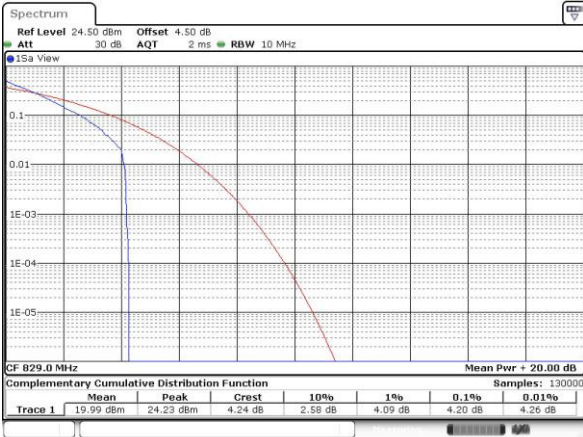

Date: 14 APR 2017 16:00:35

Lowest Channel / Full RB

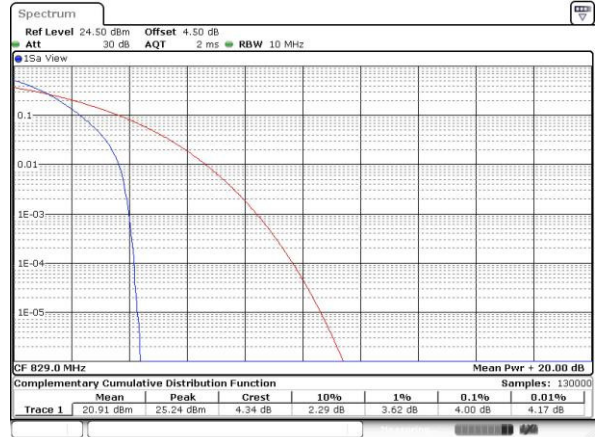

Date: 14 APR 2017 16:00:46

Middle Channel / 1RB

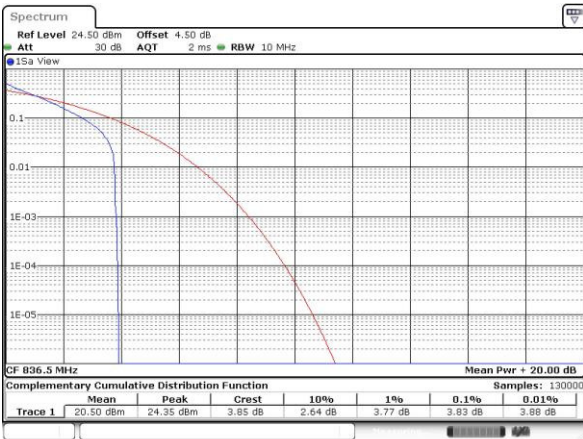

Date: 14 APR 2017 16:00:57

Middle Channel / Full RB

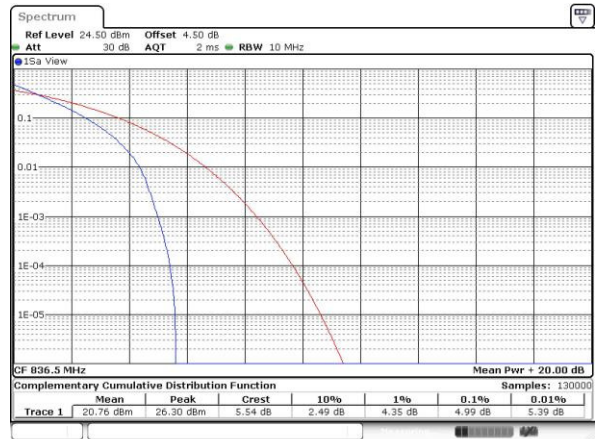

Date: 14 APR 2017 16:01:07

Highest Channel / 1RB

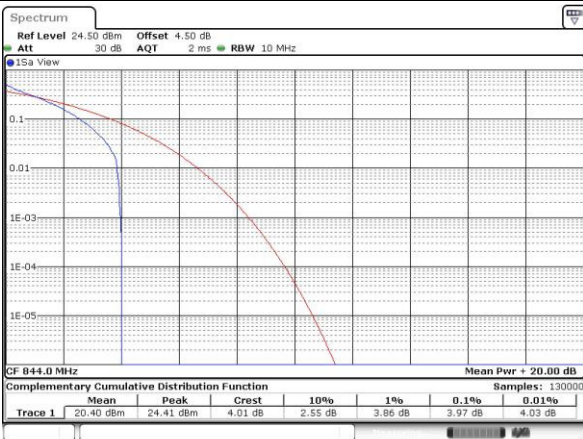

Date: 14 APR 2017 16:01:18

Highest Channel / Full RB

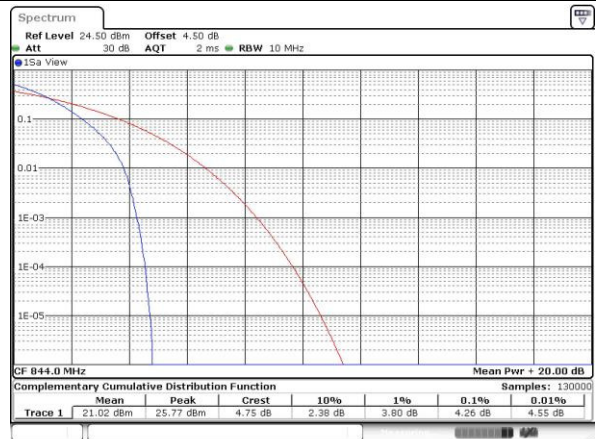

Date: 14 APR 2017 16:01:29



LTE Band 5 / 10MHz / 16QAM

Lowest Channel / 1RB

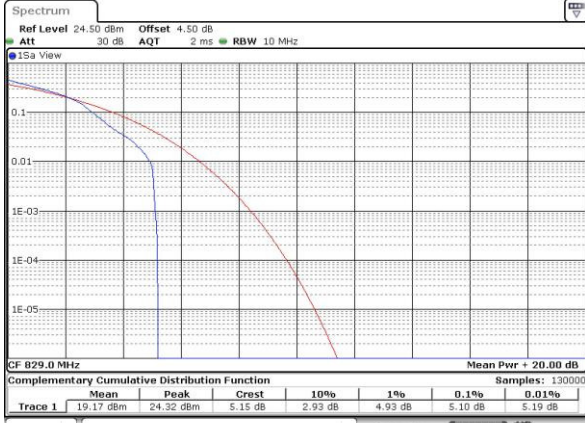

Date: 14 APR 2017 15:58:30

Lowest Channel / Full RB

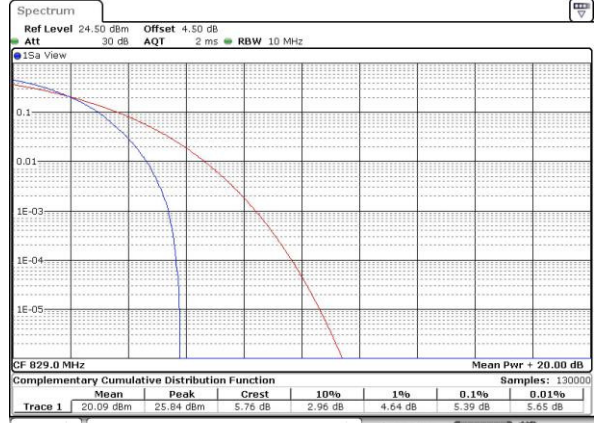

Date: 14 APR 2017 15:59:39

Middle Channel / 1RB

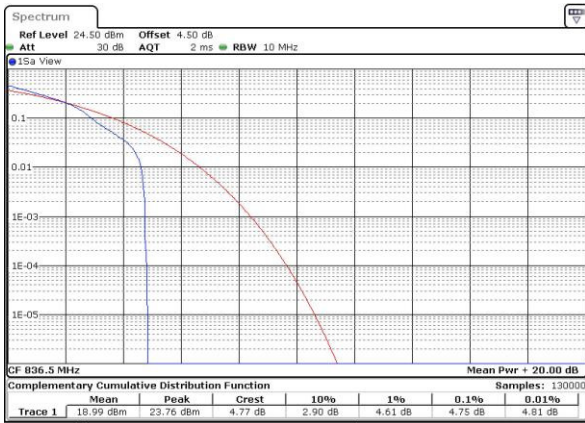

Date: 14 APR 2017 15:59:51

Middle Channel / Full RB



Date: 14 APR 2017 16:00:02

Highest Channel / 1RB



Date: 14 APR 2017 16:00:13

Highest Channel / Full RB



Date: 14 APR 2017 16:00:23



LTE Band 13 / 10MHz / QPSK

Middle Channel/ 1RB

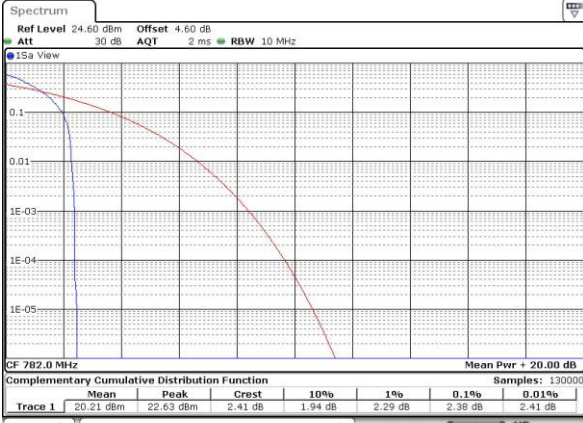

Date: 15 APR 2017 01:20:43

Middle Channel / Full RB



Date: 15 APR 2017 01:20:53

LTE Band 13 / 10MHz / 16QAM

Middle Channel/ 1RB



Date: 15 APR 2017 01:20:33

Middle Channel / Full RB

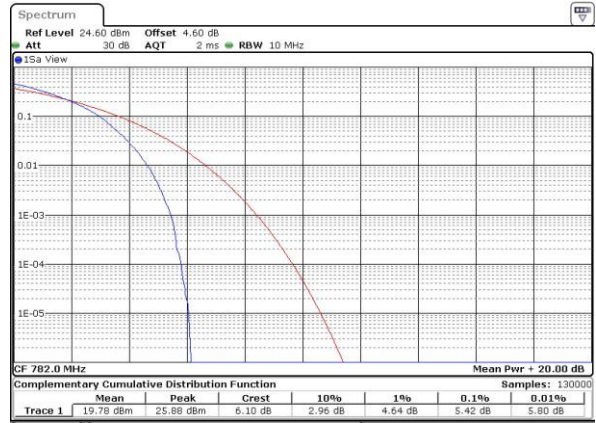

Date: 15 APR 2017 01:21:03



26dB Bandwidth

Mode	LTE Band 2 : 26dB BW(MHz)											
	1.4MHz		3MHz		5MHz		10MHz		15MHz		20MHz	
Mod.	QPSK	16QAM	QPSK	16QAM	QPSK	16QAM	QPSK	16QAM	QPSK	16QAM	QPSK	16QAM
Lowest CH	1.27	1.29	3.02	3.02	4.93	4.86	9.99	9.79	14.42	14.72	20.14	20.38
Middle CH	1.28	1.27	2.99	3.02	4.96	4.92	9.91	9.89	14.18	14.42	20.14	20.02
Highest CH	1.26	1.28	3.05	3.02	4.81	4.97	9.67	9.83	14.39	14.45	20.18	20.34

Mode	LTE Band 4 : 26dB BW(MHz)											
	1.4MHz		3MHz		5MHz		10MHz		15MHz		20MHz	
Mod.	QPSK	16QAM	QPSK	16QAM	QPSK	16QAM	QPSK	16QAM	QPSK	16QAM	QPSK	16QAM
Lowest CH	1.30	1.28	3.06	3.03	5.06	4.97	9.77	9.67	14.69	14.27	20.18	20.34
Middle CH	1.27	1.30	3.00	3.04	5.00	4.93	9.81	9.81	14.42	14.33	20.10	20.18
Highest CH	1.29	1.28	3.03	2.98	4.91	4.95	9.83	9.75	14.45	14.51	20.14	20.18

Mode	LTE Band 5 : 26dB BW(MHz)											
	1.4MHz		3MHz		5MHz		10MHz		15MHz		20MHz	
Mod.	QPSK	16QAM	QPSK	16QAM	QPSK	16QAM	QPSK	16QAM	QPSK	16QAM	QPSK	16QAM
Lowest CH	1.26	1.28	3.02	3.03	5.03	5.01	9.83	9.83	-	-	-	-
Middle CH	1.28	1.26	2.99	3.03	5.02	5.01	9.75	9.93	-	-	-	-
Highest CH	1.30	1.29	3.05	3.01	4.87	4.98	9.75	9.87	-	-	-	-

Mode	LTE Band 13 : 26dB BW(MHz)											
	1.4MHz		3MHz		5MHz		10MHz		15MHz		20MHz	
Mod.	QPSK	16QAM	QPSK	16QAM	QPSK	16QAM	QPSK	16QAM	QPSK	16QAM	QPSK	16QAM
Lowest CH	-	-	-	-	4.88	4.86	-	-	-	-	-	-
Middle CH	-	-	-	-	4.85	4.94	9.89	9.79	-	-	-	-
Highest CH	-	-	-	-	4.88	4.88	-	-	-	-	-	-



LTE Band 2

Lowest Channel / 1.4MHz / QPSK

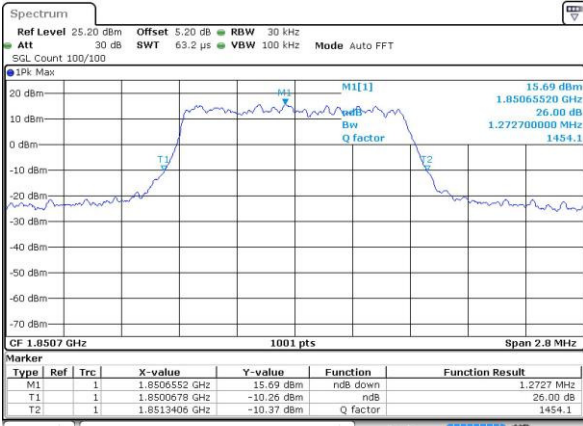

Date: 14 APR 2017 11:45:13

Lowest Channel / 1.4MHz / 16QAM

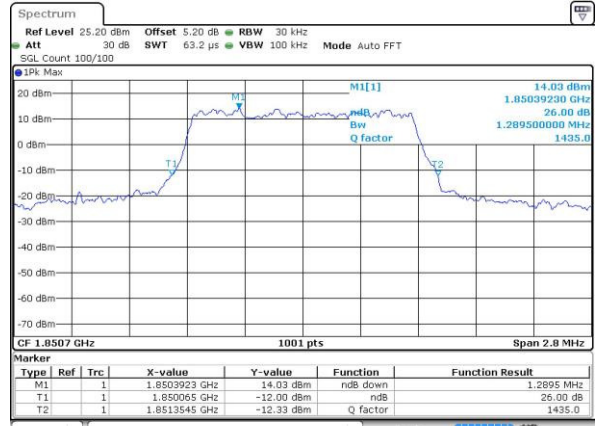

Date: 14 APR 2017 11:45:24

Middle Channel / 1.4MHz / QPSK

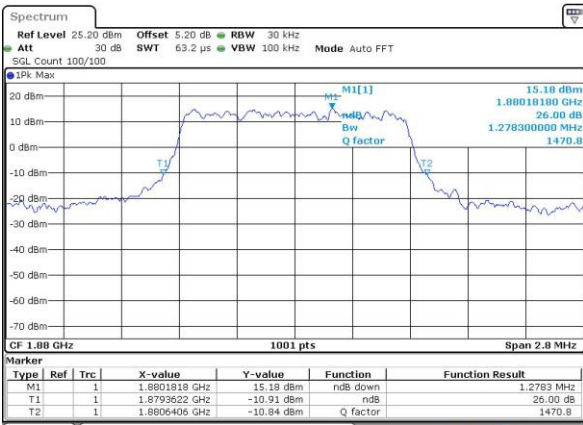

Date: 14 APR 2017 11:52:28

Middle Channel / 1.4MHz / 16QAM

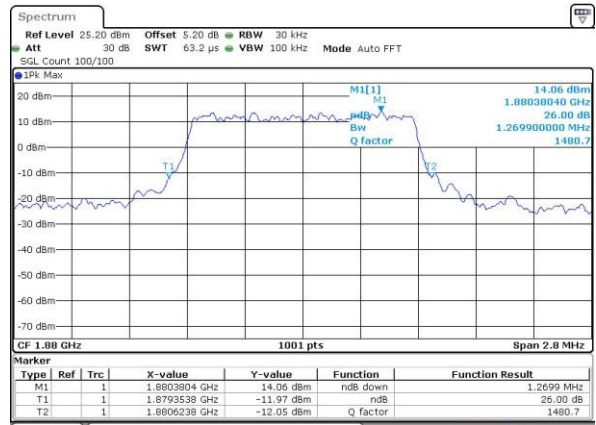

Date: 14 APR 2017 11:52:37

Highest Channel / 1.4MHz / QPSK

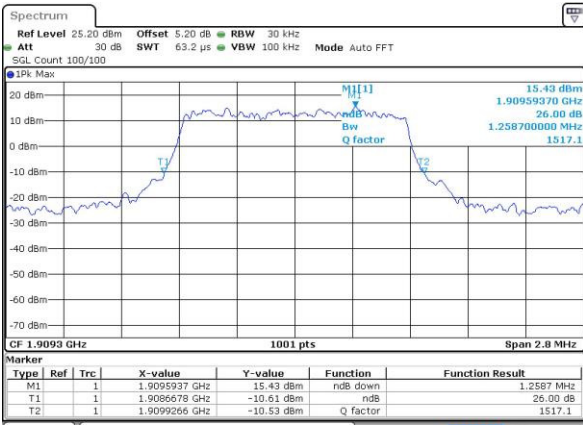

Date: 14 APR 2017 11:55:03

Highest Channel / 1.4MHz / 16QAM

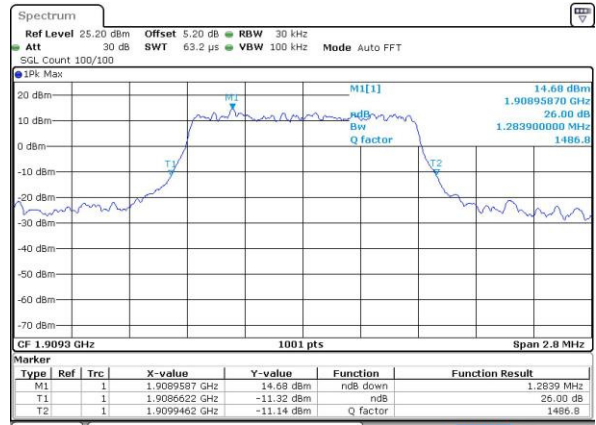

Date: 14 APR 2017 11:55:15



LTE Band 2

Lowest Channel / 3MHz / QPSK

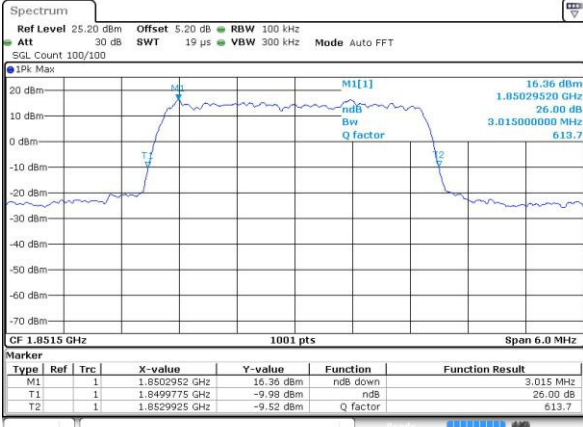

Date: 14 APR 2017 12:02:16

Lowest Channel / 3MHz / 16QAM

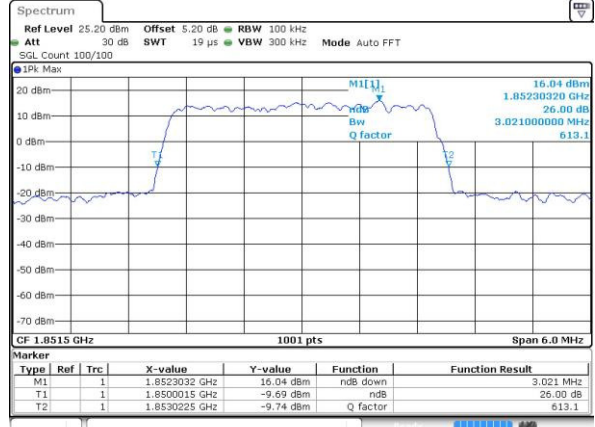

Date: 14 APR 2017 12:02:27

Middle Channel / 3MHz / QPSK

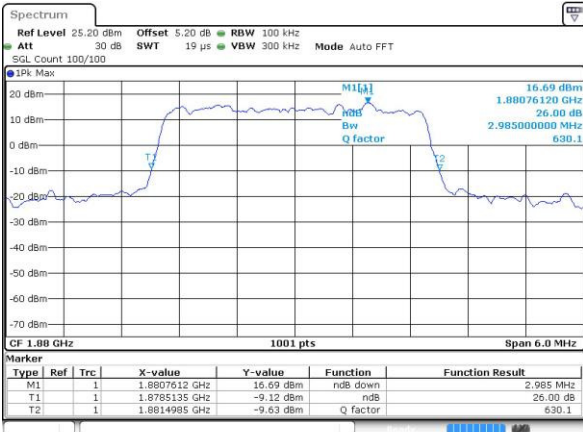

Date: 14 APR 2017 12:09:29

Middle Channel / 3MHz / 16QAM

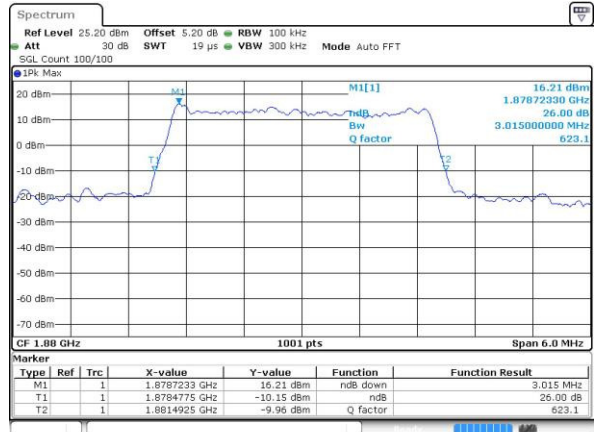

Date: 14 APR 2017 12:09:40

Highest Channel / 3MHz / QPSK



Date: 14 APR 2017 12:12:06

Highest Channel / 3MHz / 16QAM

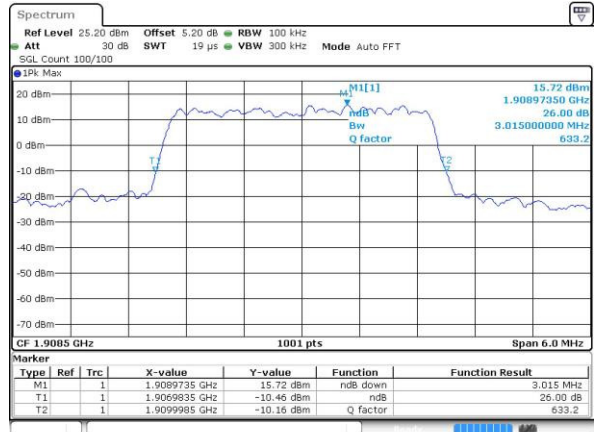

Date: 14 APR 2017 12:12:18



LTE Band 2

Lowest Channel / 5MHz / QPSK

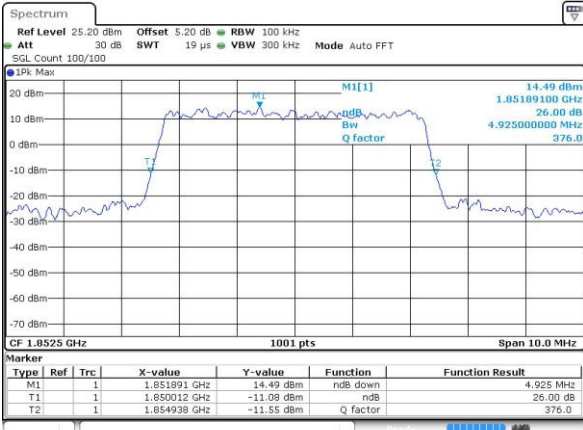

Date: 14 APR 2017 12:19:19

Lowest Channel / 5MHz / 16QAM

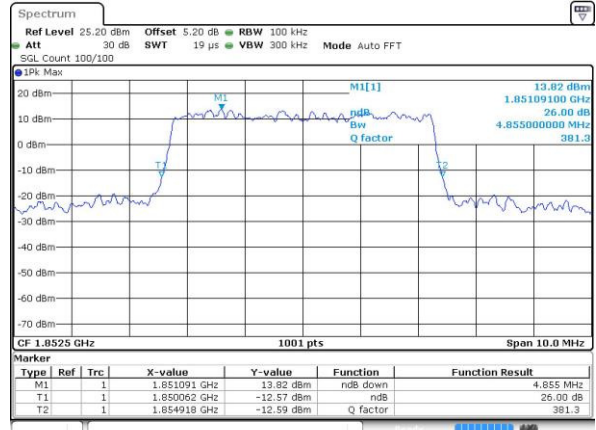

Date: 14 APR 2017 12:19:30

Middle Channel / 5MHz / QPSK

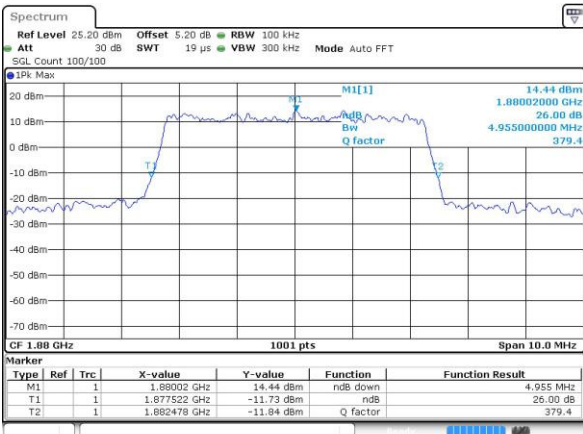

Date: 14 APR 2017 12:26:32

Middle Channel / 5MHz / 16QAM

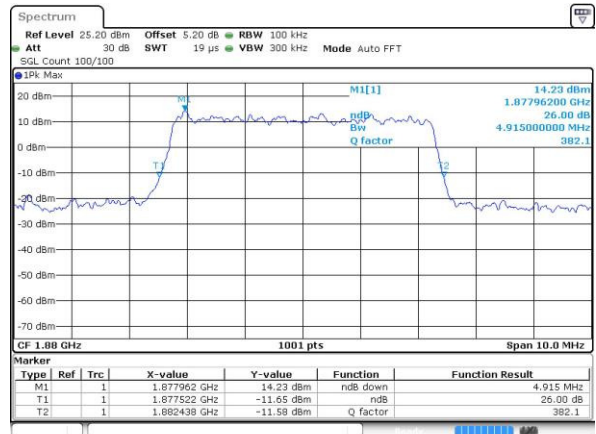

Date: 14 APR 2017 12:26:43

Highest Channel / 5MHz / QPSK

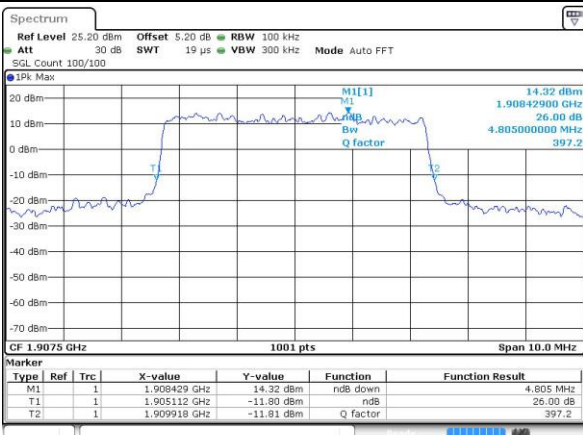

Date: 14 APR 2017 12:29:10

Highest Channel / 5MHz / 16QAM

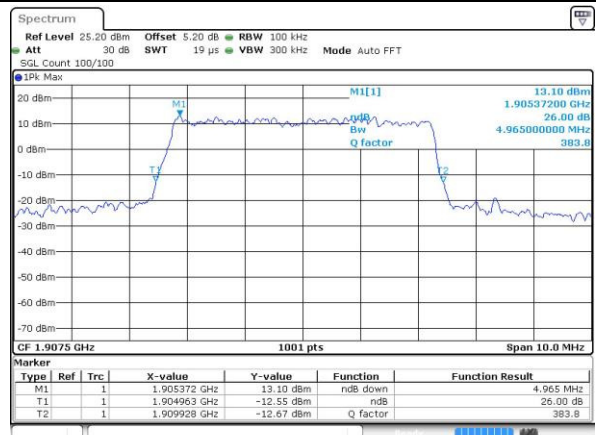

Date: 14 APR 2017 12:29:21



LTE Band 2

Lowest Channel / 10MHz / QPSK

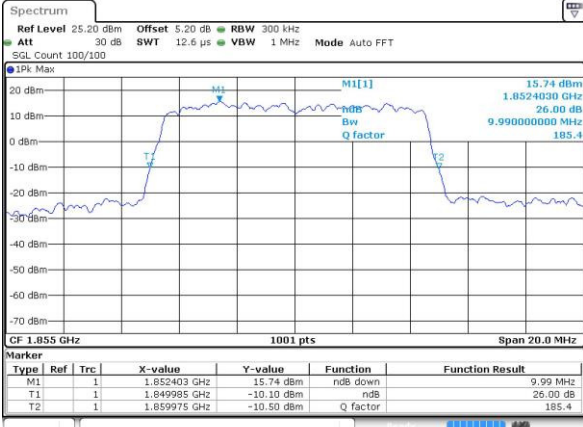

Date: 14 APR 2017 12:36:23

Lowest Channel / 10MHz / 16QAM

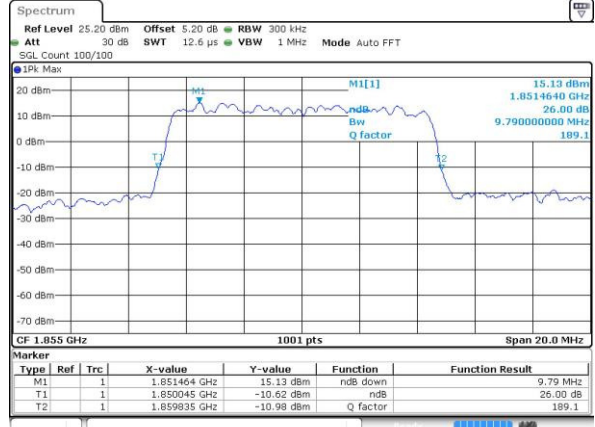

Date: 14 APR 2017 12:36:34

Middle Channel / 10MHz / QPSK

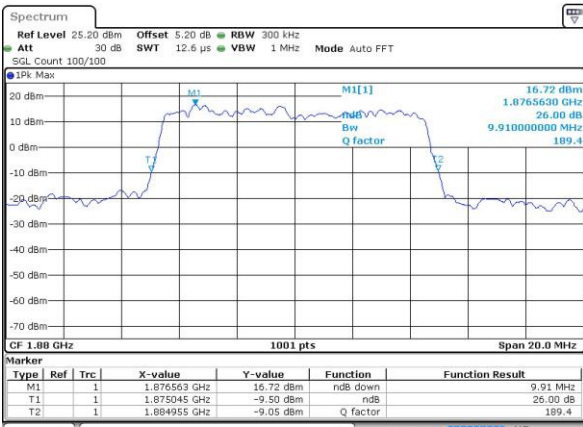

Date: 14 APR 2017 12:43:35

Middle Channel / 10MHz / 16QAM

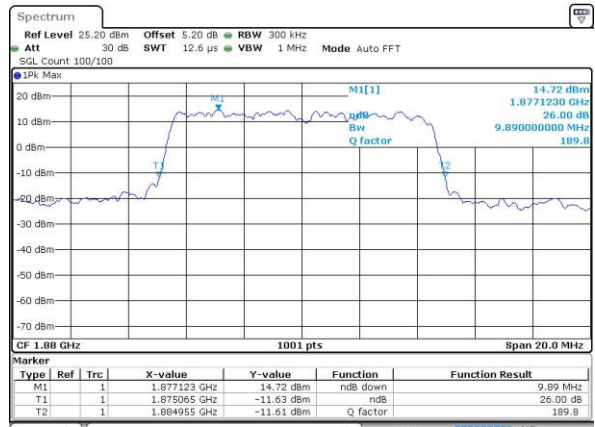

Date: 14 APR 2017 12:43:47

Highest Channel / 10MHz / QPSK

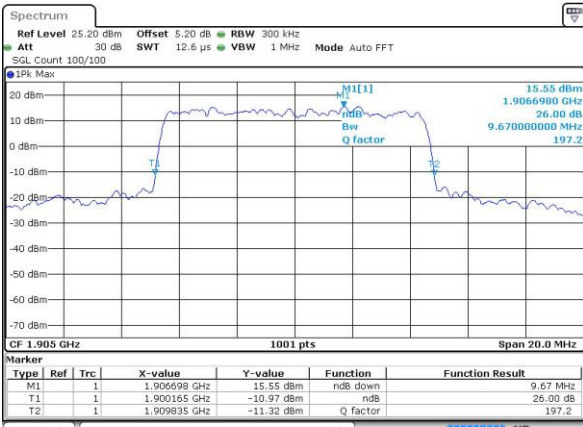

Date: 14 APR 2017 12:46:13

Highest Channel / 10MHz / 16QAM

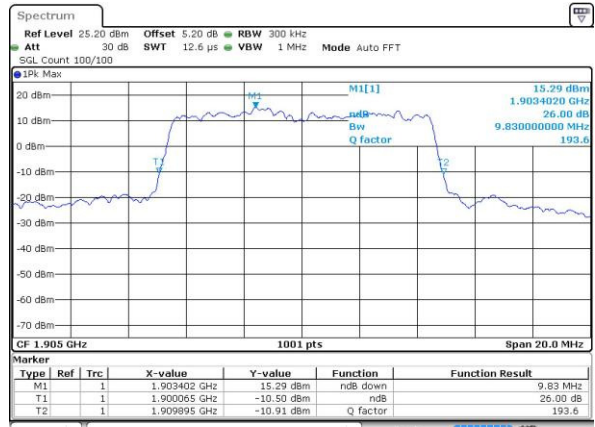

Date: 14 APR 2017 12:46:24



LTE Band 2

Lowest Channel / 15MHz / QPSK

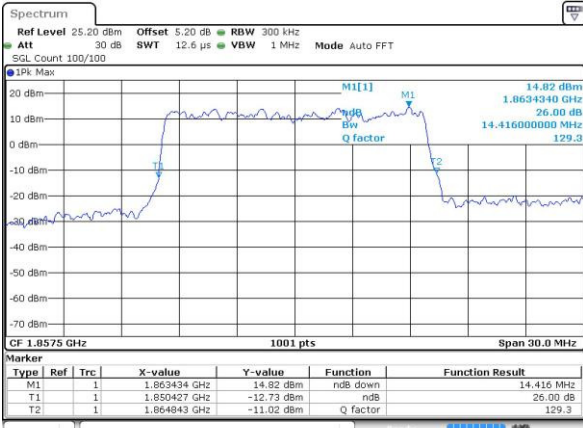

Date: 14 APR 2017 12:53:26

Lowest Channel / 15MHz / 16QAM

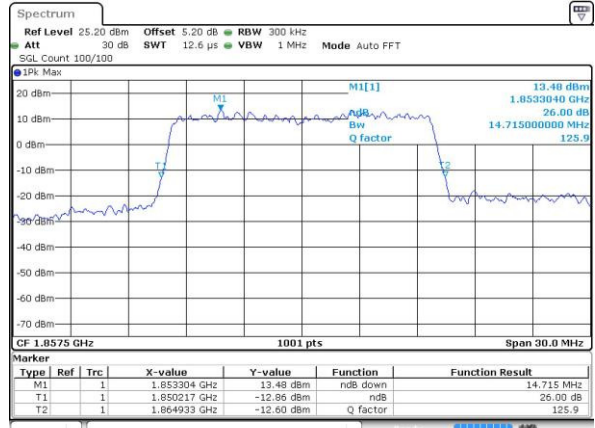

Date: 14 APR 2017 12:53:37

Middle Channel / 15MHz / QPSK

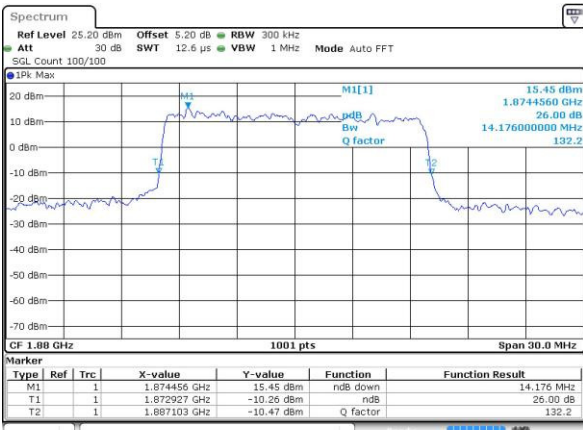

Date: 14 APR 2017 13:00:39

Middle Channel / 15MHz / 16QAM

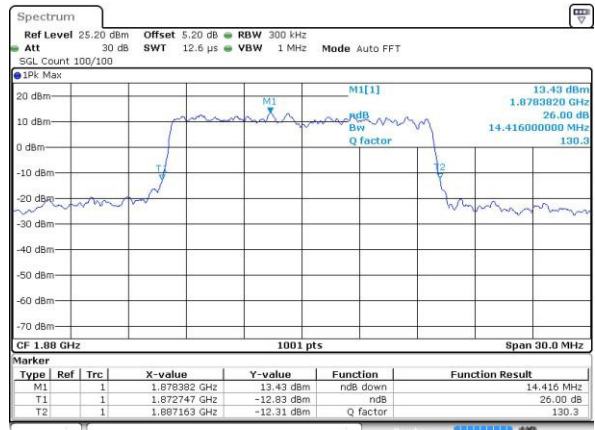

Date: 14 APR 2017 13:00:50

Highest Channel / 15MHz / QPSK

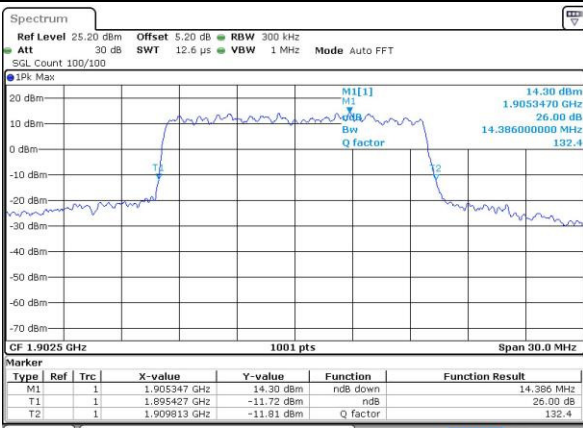

Date: 14 APR 2017 13:03:16

Highest Channel / 15MHz / 16QAM

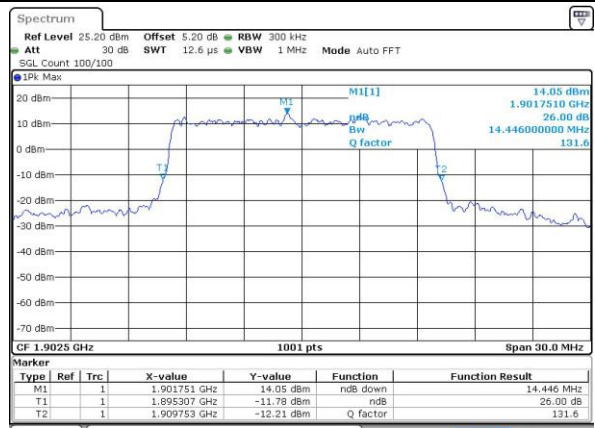

Date: 14 APR 2017 13:03:28



LTE Band 2

Lowest Channel / 20MHz / QPSK

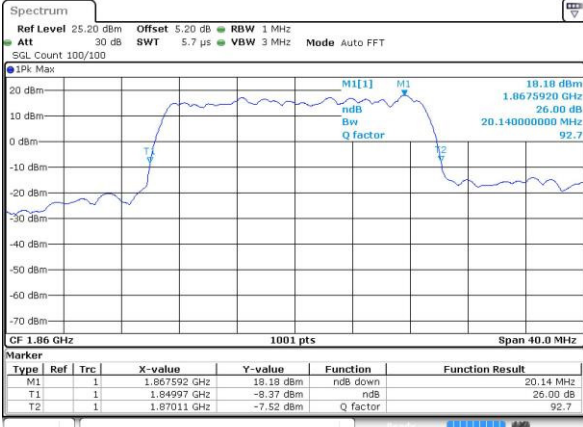

Date: 14 APR 2017 13:10:29

Lowest Channel / 20MHz / 16QAM

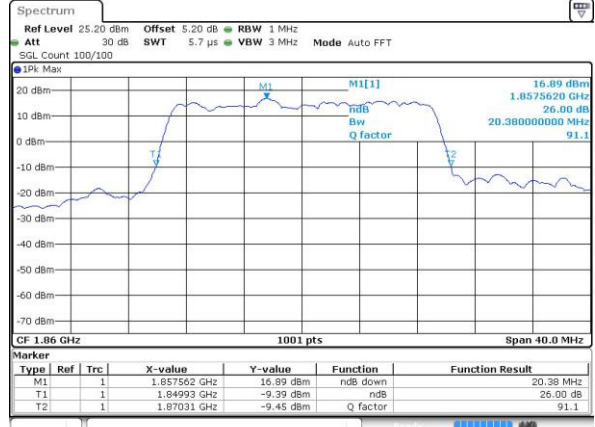

Date: 14 APR 2017 13:10:40

Middle Channel / 20MHz / QPSK

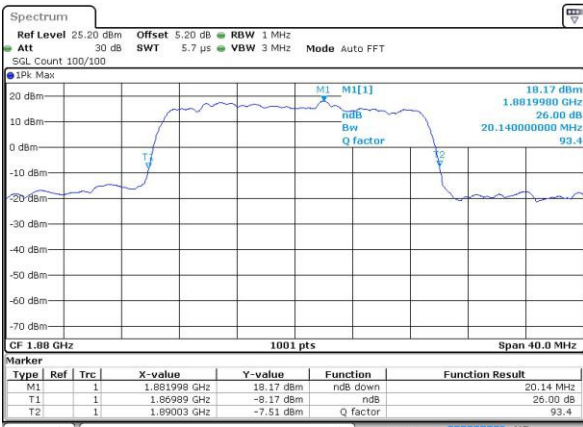

Date: 14 APR 2017 13:17:42

Middle Channel / 20MHz / 16QAM

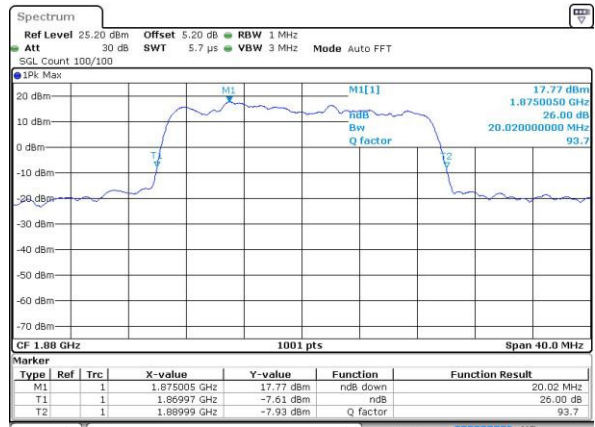

Date: 14 APR 2017 13:17:53

Highest Channel / 20MHz / QPSK

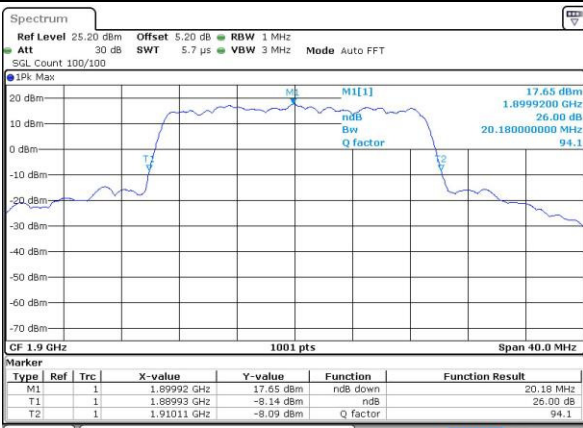

Date: 14 APR 2017 13:20:19

Highest Channel / 20MHz / 16QAM

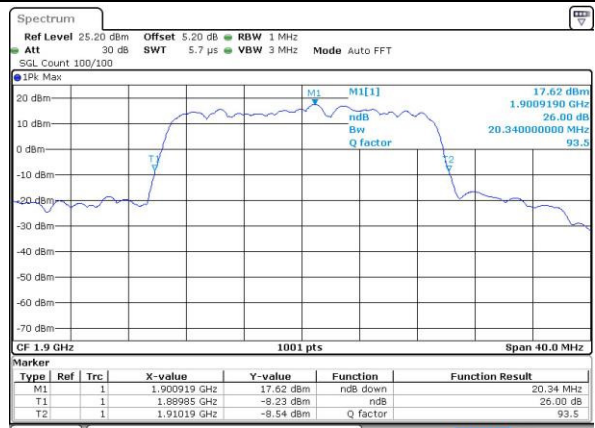

Date: 14 APR 2017 13:20:31