



FCC RF Test Report

APPLICANT : ZTE CORPORATION
EQUIPMENT : Wireless Access Terminal
BRAND NAME : ZTE
MODEL NAME : WF723
FCC ID : SRQ-Z723EL
STANDARD : FCC 47 CFR Part 2, 22(H), 24(E), 27(L)
CLASSIFICATION : PCS Licensed Transmitter (PCB)

The product testing was completed on Jan. 18, 2017. We, Sporton International (Kunshan) Inc., would like to declare that the tested sample has been evaluated in accordance with the test procedures given in ANSI / TIA / EIA-603-D-2010 and has been in compliance with the applicable technical standards.

The test results in this report apply exclusively to the tested model / sample. Without written approval of Sporton International (Kunshan) Inc., the test report shall not be reproduced except in full.



Approved by: James Huang / Manager

Sporton International (Kunshan) Inc.

No.3-2 Ping-Xiang Rd, Kunshan Development Zone Kunshan City Jiangsu Province 215335 China



TABLE OF CONTENTS

REVISION HISTORY..... 3

SUMMARY OF TEST RESULT 4

1 GENERAL DESCRIPTION 5

 1.1 Applicant..... 5

 1.2 Manufacturer 5

 1.3 Product Feature of Equipment Under Test 5

 1.4 Product Specification of Equipment Under Test 6

 1.5 Modification of EUT 6

 1.6 Maximum ERP/EIRP Power, Frequency Tolerance, and Emission Designator 6

 1.7 Testing Location 7

 1.8 Applicable Standards 7

2 TEST CONFIGURATION OF EQUIPMENT UNDER TEST 8

 2.1 Test Mode..... 8

 2.2 Connection Diagram of Test System 9

 2.3 Support Unit used in test configuration 9

 2.4 Measurement Results Explanation Example 9

3 CONDUCTED TEST RESULT..... 10

 3.1 Measuring Instruments..... 10

 3.2 Test Setup 10

 3.3 Test Result of Conducted Test..... 10

 3.4 Conducted Output Power and ERP/EIRP 11

 3.5 Peak-to-Average Ratio 12

 3.6 99% Occupied Bandwidth and 26dB Bandwidth Measurement..... 13

 3.7 Conducted Band Edge 14

 3.8 Conducted Spurious Emission 15

 3.9 Frequency Stability..... 16

4 RADIATED TEST ITEMS 17

 4.1 Measuring Instruments..... 17

 4.2 Test Setup 17

 4.3 Test Result of Radiated Test..... 17

 4.4 Field Strength of Spurious Radiation Measurement 18

5 LIST OF MEASURING EQUIPMENT 19

6 UNCERTAINTY OF EVALUATION 20

APPENDIX A. TEST RESULTS OF CONDUCTED TEST

APPENDIX B. TEST RESULTS OF RADIATED TEST

APPENDIX C. TEST SETUP PHOTOGRAPHS

APPENDIX D. PRODUCT EQUALITY DECLARATION



REVISION HISTORY

REPORT NO.	VERSION	DESCRIPTION	ISSUED DATE
FG710507-01	Rev. 01	Initial issue of report	Sep. 20, 2017



SUMMARY OF TEST RESULT

Report Section	FCC Rule	Description	Limit	Result	Remark
3.4	§2.1046	Conducted Output Power	Reporting Only	PASS	-
	§22.913(a)(2)	Effective Radiated Power	< 7 Watts	PASS	-
	§24.232(c)	Equivalent Isotropic Radiated Power	< 2 Watts	PASS	-
	§27.50(d)(4)	Equivalent Isotropic Radiated Power	< 1 Watts	PASS	-
3.5	§24.232(d)	Peak-to-Average Ratio	< 13 dB	PASS	-
3.6	§2.1049 §22.917(b) §24.238(b) §27.53(g)	Occupied Bandwidth	Reporting Only	PASS	-
3.7	§2.1051 §22.917(a) §24.238(a) §27.53(h)	Band Edge Measurement	< 43+10log10(P[Watts])	PASS	-
3.8	§2.1051 §22.917(a) §24.238(a) §27.53(h)	Conducted Emission	< 43+10log10(P[Watts])	PASS	-
3.9	§2.1055 §22.355	Frequency Stability for Temperature & Voltage	< 2.5 ppm for Part 22H	PASS	-
	§2.1055 §24.235 §27.54		Within Authorized Band		
4.4	§2.1053 §22.917(a) §24.238(a) §27.53(h)	Field Strength of Spurious Radiation	< 43+10log10(P[Watts])	PASS	Under limit 34.56 dB at 5640.000 MHz



1 General Description

1.1 Applicant

ZTE CORPORATION

ZTE Plaza, Keji Road South, Hi-Tech, Industrial Park, Nanshan District, Shenzhen, Guangdong, 518057, P.R.China

1.2 Manufacturer

ZTE CORPORATION

ZTE Plaza, Keji Road South, Hi-Tech, Industrial Park, Nanshan District, Shenzhen, Guangdong, 518057, P.R.China

1.3 Product Feature of Equipment Under Test

Product Feature	
Equipment	Wireless Access Terminal
Brand Name	ZTE
Model Name	WF723
FCC ID	SRQ-Z723EL
EUT supports Radios application	WCDMA/HSPA/HSPA+(16QAM uplink is not supported)
IMEI Code	Conducted: 863579030001274 Radiation: 863579030001316 for 22(H) 863579030001324 for 24(E), 27(L)
HW Version	Z723ELHVV1.0
SW Version	WF723V1.0.0B01
EUT Stage	Identical Prototype

Remark:

1. The above EUT's information was declared by manufacturer. Please refer to the specifications or user's manual for more detailed description.
2. The report is in accordance with C2PC rule, the product equality declaration as Appendix D. Based on the similarity between current and previous project, software open WCDMA Band 2/4/5 and disable LTE band 2/4/12/13, WCDMA band for full test, other test cases were performed on original report which can be referred to Sporton Report Number FG710507A.



1.4 Product Specification of Equipment Under Test

Standards-related Product Specification	
Tx Frequency	WCDMA: Band V: 826.4 MHz ~ 846.6 MHz Band II: 1852.4 MHz ~ 1907.6 MHz Band IV: 1712.4 MHz ~ 1752.6 MHz
Rx Frequency	WCDMA: Band V: 871.4 MHz ~ 891.6 MHz Band II: 1932.4 MHz ~ 1987.6 MHz Band IV: 2112.4 MHz ~ 2152.6 MHz
Maximum Output Power to Antenna	WCDMA: Band V: 24.10 dBm Band II: 22.04 dBm Band IV: 23.46 dBm
Antenna Type	Fixed External Antenna
Antenna Gain	Cellular Band: -1.30 dBi PCS Band: 1.00 dBi AWS Band: -0.50 dBi
Type of Modulation	WCDMA : BPSK (Uplink) HSDPA : QPSK (Uplink) HSUPA : QPSK (Uplink) HSPA+ : 16QAM (uplink is not supported)

1.5 Modification of EUT

No modifications are made to the EUT during all test items.

1.6 Maximum ERP/EIRP Power, Frequency Tolerance, and Emission Designator

FCC Rule	System	Type of Modulation	Maximum ERP/EIRP (W)	Frequency Tolerance (ppm)	Emission Designator
Part 22H	WCDMA Band V RMC 12.2Kbps	BPSK	0.1161	0.0263 ppm	4M16F9W
Part 24E	WCDMA Band II RMC 12.2Kbps	BPSK	0.2014	0.0144 ppm	4M16F9W
Part 27L	WCDMA Band IV RMC 12.2Kbps	BPSK	0.1977	0.0208 ppm	4M17F9W



1.7 Testing Location

Sporton Lab is accredited to ISO 17025 by National Voluntary Laboratory Accreditation Program (NVLAP code: 600155-0) and the FCC designation No is CN5013.

Test Site	Sporton International (Kunshan) Inc.		
Test Site Location	No.3-2 Ping-Xiang Rd, Kunshan Development Zone Kunshan City Jiangsu Province 215335 China TEL : +86-512-57900158 FAX : +86-512-57900958		
Test Site No.	Sporton Site No.		FCC Test Firm Registration No.
	TH01-KS	03CH02-KS	630927

Note: The test site complies with ANSI C63.4 2014 requirement.

1.8 Applicable Standards

According to the specifications of the manufacturer, the EUT must comply with the requirements of the following standards:

- 47 CFR Part 2, 22(H), 24(E), 27(L)
- ANSI / TIA / EIA-603-D-2010
- FCC KDB 971168 D01 Power Meas. License Digital Systems v02r02
- FCC KDB 412172 D01 Determining ERP and EIRP v01r01

Remark:

1. All test items were verified and recorded according to the standards and without any deviation during the test.
2. This EUT has also been tested and complied with the requirements of FCC Part 15, Subpart B, recorded in a separate test report.



2 Test Configuration of Equipment Under Test

2.1 Test Mode

Antenna port conducted and radiated test items were performed according to KDB 971168 D01 Power Meas. License Digital Systems v02r02 with maximum output power.

Radiated measurements were performed with rotating EUT in different three orthogonal test planes to find the maximum emission.

Radiated emissions were investigated as following frequency range:

1. 30 MHz to 10th harmonic for WCDMA Band V.
2. 30 MHz to 10th harmonic for WCDMA Band IV.
3. 30 MHz to 10th harmonic for WCDMA Band II.

All modes and data rates and positions were investigated.

Test modes are chosen to be reported as the worst case configuration below:

Test Modes		
Band	Radiated TCs	Conducted TCs
WCDMA Band V	■ RMC 12.2Kbps Link	■ RMC 12.2Kbps Link
WCDMA Band II	■ RMC 12.2Kbps Link	■ RMC 12.2Kbps Link
WCDMA Band IV	■ RMC 12.2Kbps Link	■ RMC 12.2Kbps Link

2.2 Connection Diagram of Test System

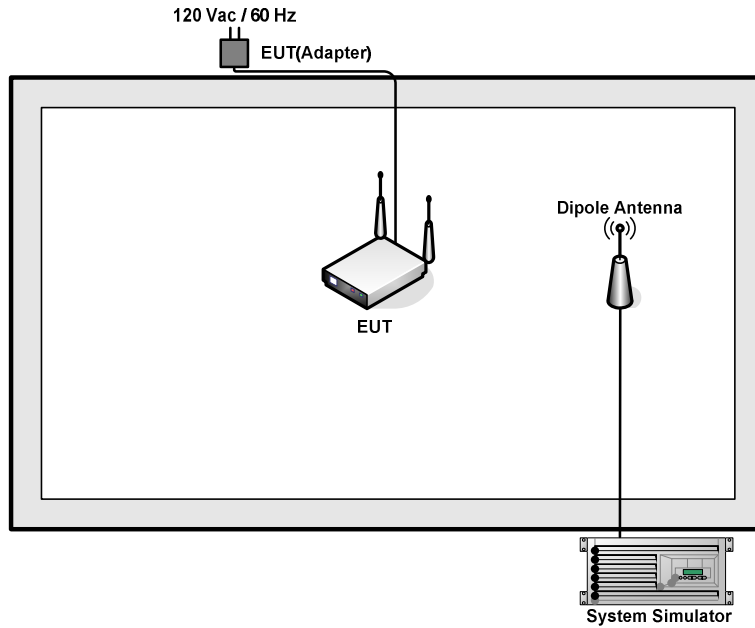

2.3 Support Unit used in test configuration

Item	Equipment	Trade Name	Model No.	FCC ID	Data Cable	Power Cord
1.	System Simulator	R&S	CMU 200	N/A	N/A	Unshielded, 1.8 m
2.	DC Power Supply	GW INSTRON	GPS-3030D	N/A	N/A	Unshielded, 1.8 m

2.4 Measurement Results Explanation Example

For all conducted test items:

The offset level is set in the spectrum analyzer to compensate the RF cable loss and attenuator factor between RF conducted output port and spectrum analyzer. With the offset compensation, the spectrum analyzer reading level will be exactly the RF output level.

The spectrum analyzer offset is derived from RF cable loss and attenuator factor.

Offset = RF cable loss + attenuator factor.

The following shows an offset computation example with RF cable loss 4.2 dB and a 10dB attenuator.

Example :

$$\begin{aligned} \text{Offset(dB)} &= \text{RF cable loss(dB)} + \text{attenuator factor(dB)} \\ &= 4.2 + 10 = 14.2 \text{ (dB)} \end{aligned}$$

3 Conducted Test Result

3.1 Measuring Instruments

See list of measuring instruments of this test report.

3.2 Test Setup

3.2.1 Conducted Output Power



3.2.2 Peak-to-Average Ratio, Occupied Bandwidth, Conducted Band-Edge and Conducted Spurious Emission

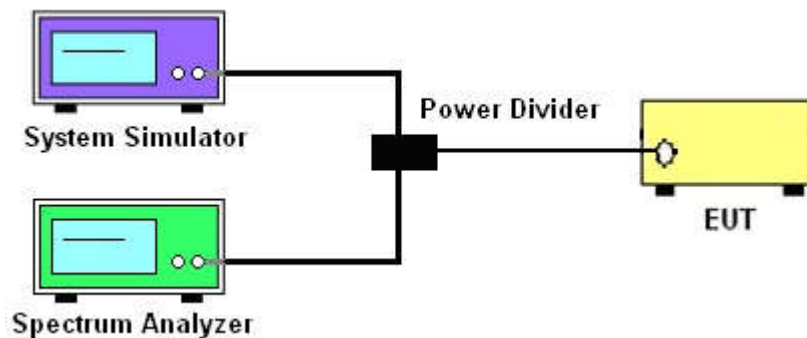

3.2.3 Frequency Stability

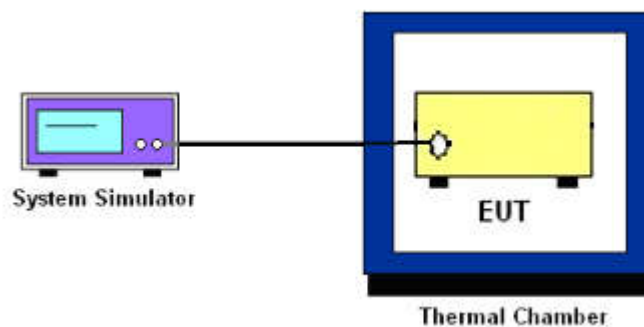

3.3 Test Result of Conducted Test

Please refer to Appendix A.



3.4 Conducted Output Power and ERP/EIRP

3.4.1 Description of the Conducted Output Power and ERP/EIRP

A system simulator was used to establish communication with the EUT. Its parameters were set to enforce EUT transmitting at the maximum power. The measured power in the radio frequency on the transmitter output terminals shall be reported.

The ERP of mobile transmitters must not exceed 7 Watts for WCDMA Band V.

The EIRP of mobile transmitters must not exceed 2 Watts for WCDMA Band II.

The EIRP of mobile transmitters must not exceed 1 Watts for WCDMA Band IV.

According to KDB 412172 D01 Power Approach,

$EIRP = P_T + G_T - L_C$, $ERP = EIRP - 2.15$, where

P_T = transmitter output power in dBm

G_T = gain of the transmitting antenna in dBi

L_C = signal attenuation in the connecting cable between the transmitter and antenna in dB

3.4.2 Test Procedures

1. The transmitter output port was connected to the system simulator.
2. Set EUT at maximum power through system simulator.
3. Select lowest, middle, and highest channels for each band and different modulation.
4. Measure the maximum burst average power for WCDMA.



3.5 Peak-to-Average Ratio

3.5.1 Description of the PAR Measurement

The peak-to-average ratio (PAR) of the transmission may not exceed 13 dB.

3.5.2 Test Procedures

1. The testing follows FCC KDB 971168 D01 v02r02 Section 5.7.1.
2. The EUT was connected to spectrum analyzer and system simulator via a power divider.
3. Set EUT to transmit at maximum output power.
4. When the duty cycle is less than 98%, then signal gating will be implemented on the spectrum analyzer by triggering from the system simulator.
5. Set the CCDF (Complementary Cumulative Distribution Function) option of the spectrum analyzer.
6. Record the maximum PAPR level associated with a probability of 0.1%.



3.6 99% Occupied Bandwidth and 26dB Bandwidth Measurement

3.6.1 Description of 99% Occupied Bandwidth and 26dB Bandwidth Measurement

The occupied bandwidth is the width of a frequency band such that, below the lower and above the upper frequency limits, the mean powers emitted are each equal to a specified percentage 0.5% of the total mean transmitted power.

The 26 dB emission bandwidth is defined as the frequency range between two points, one above and one below the carrier frequency, at which the spectral density of the emission is attenuated 26 dB below the maximum in-band spectral density of the modulated signal. Spectral density (power per unit bandwidth) is to be measured with a detector of resolution bandwidth equal to approximately 1.0% of the emission bandwidth.

3.6.2 Test Procedures

1. The testing follows FCC KDB 971168 v02r02 Section 4.2.
2. The EUT was connected to spectrum analyzer and system simulator via a power divider.
3. The spectrum analyzer center frequency is set to the nominal EUT channel center frequency. The span range for the spectrum analyzer shall be between two and five times the anticipated OBW.
4. The nominal resolution bandwidth (RBW) shall be in the range of 1 to 5 % of the anticipated OBW, and the VBW shall be at least 3 times the RBW.
5. Set the detection mode to peak, and the trace mode to max hold.
6. Determine the reference value: Set the EUT to transmit a modulated signal. Allow the trace to stabilize. Set the spectrum analyzer marker to the highest level of the displayed trace.
(this is the reference value)
7. Determine the “-26 dB down amplitude” as equal to (Reference Value – X).
8. Place two markers, one at the lowest and the other at the highest frequency of the envelope of the spectral display such that each marker is at or slightly below the “-X dB down amplitude” determined in step 6. If a marker is below this “-X dB down amplitude” value it shall be placed as close as possible to this value. The OBW is the positive frequency difference between the two markers.
9. Use the 99 % power bandwidth function of the spectrum analyzer and report the measured bandwidth.



3.7 Conducted Band Edge

3.7.1 Description of Conducted Band Edge Measurement

The power of any emission outside of the authorized operating frequency ranges must be lower than the transmitter power (P) by a factor of at least $43 + 10 \log (P)$ dB.

3.7.2 Test Procedures

1. The testing follows FCC KDB 971168 D01 v02r02 Section 6.0.
2. The EUT was connected to the spectrum analyzer and system simulator via a power divider.
3. The RF output of EUT was connected to the spectrum analyzer by an RF cable and attenuator. The path loss was compensated to the results for each measurement.
4. The band edges of low and high channels for the highest RF powers were measured.
5. The RF fundamental frequency should be excluded against the limit line in the operating frequency band.
6. The limit line is derived from $43 + 10\log(P)$ dB below the transmitter power P(Watts)
= $P(W) - [43 + 10\log(P)]$ (dB)
= $[30 + 10\log(P)]$ (dBm) - $[43 + 10\log(P)]$ (dB)
= -13dBm.



3.8 Conducted Spurious Emission

3.8.1 Description of Conducted Spurious Emission Measurement

The power of any emission outside of the authorized operating frequency ranges must be lower than the transmitter power (P) by a factor of at least $43 + 10 \log (P)$ dB.

It is measured by means of a calibrated spectrum analyzer and scanned from 30 MHz up to a frequency including its 10th harmonic.

3.8.2 Test Procedures

1. The testing follows FCC KDB 971168 D01 v02r02 Section 6.0.
2. The EUT was connected to the spectrum analyzer and system simulator via a power divider.
3. The RF output of EUT was connected to the spectrum analyzer by an RF cable and attenuator.
The path loss was compensated to the results for each measurement.
4. The middle channel for the highest RF power within the transmitting frequency was measured.
5. The conducted spurious emission for the whole frequency range was taken.
6. The RF fundamental frequency should be excluded against the limit line in the operating frequency band.
7. The limit line is derived from $43 + 10\log(P)$ dB below the transmitter power P(Watts)
= $P(W) - [43 + 10\log(P)]$ (dB)
= $[30 + 10\log(P)]$ (dBm) - $[43 + 10\log(P)]$ (dB)
= -13dBm.



3.9 Frequency Stability

3.9.1 Description of Frequency Stability Measurement

The frequency stability shall be measured by variation of ambient temperature and variation of primary supply voltage to ensure that the fundamental emission stays within the authorized frequency block. The frequency stability of the transmitter shall be maintained within $\pm 0.00025\%$ ($\pm 2.5\text{ppm}$) of the center frequency.

3.9.2 Test Procedures for Temperature Variation

1. The testing follows FCC KDB 971168 D01 v02r02 Section 9.0.
2. The EUT was set up in the thermal chamber and connected with the system simulator.
3. With power OFF, the temperature was decreased to -30°C and the EUT was stabilized before testing. Power was applied and the maximum change in frequency was recorded within one minute.
4. With power OFF, the temperature was raised in 10°C steps up to 50°C . The EUT was stabilized at each step for at least half an hour. Power was applied and the maximum frequency change was recorded within one minute.

3.9.3 Test Procedures for Voltage Variation

1. The testing follows FCC KDB 971168 D01 v02r02 Section 9.0.
2. The EUT was placed in a temperature chamber at $20\pm 5^{\circ}\text{C}$ and connected with the system simulator.
3. The power supply voltage to the EUT was varied from 85% to 115% of the nominal value measured at the input to the EUT.
4. The variation in frequency was measured for the worst case.

4 Radiated Test Items

4.1 Measuring Instruments

See list of measuring instruments of this test report.

4.2 Test Setup

4.2.1 For radiated test from 30MHz to 1GHz

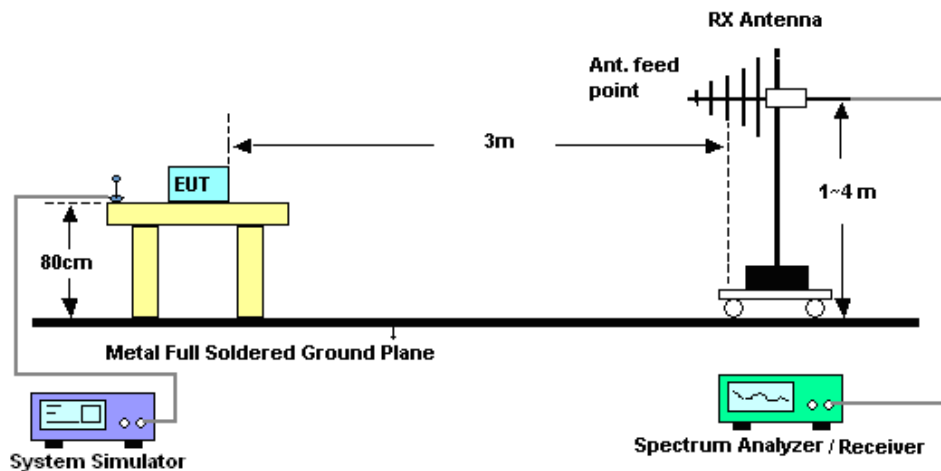

4.2.2 For radiated test above 1GHz

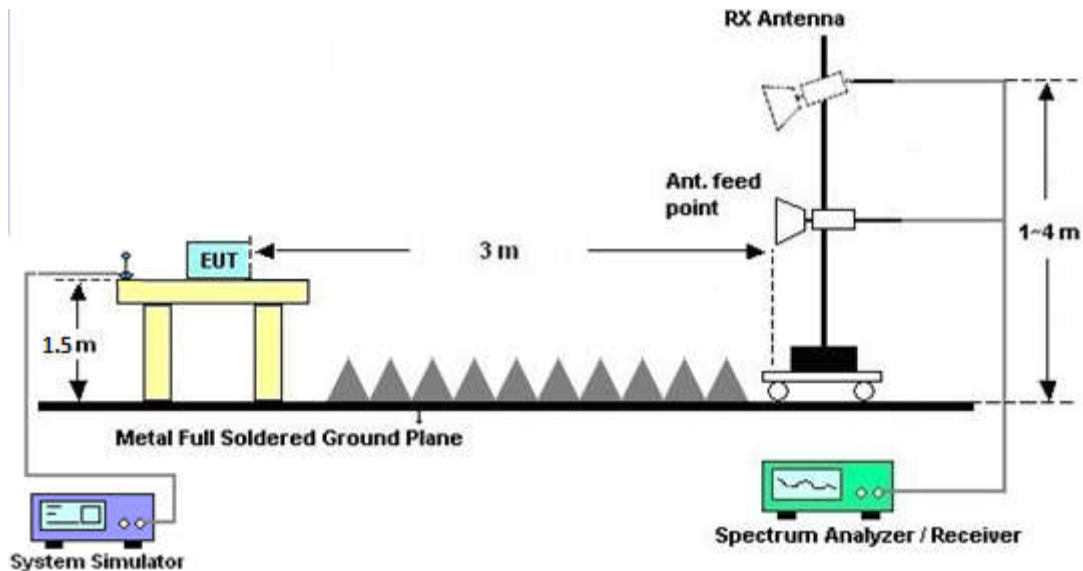

4.3 Test Result of Radiated Test

Please refer to Appendix B.



4.4 Field Strength of Spurious Radiation Measurement

4.4.1 Description of Field Strength of Spurious Radiated Measurement

The power of any emission outside of the authorized operating frequency ranges must be attenuated below the transmitter power (P) by a factor of at least $43 + 10 \log (P)$ dB. The spectrum is scanned from 30 MHz up to a frequency including its 10th harmonic.

4.4.2 Test Procedures

1. The testing follows FCC KDB 971168 D01 v02r02 Section 5.8 and ANSI / TIA-603-D-2010 Section 2.2.12.
2. The EUT was placed on a rotatable wooden table 0.8 meters for frequency below 1GHz and 1.5 meter for frequency above 1GHz above the ground.
3. The EUT was set 3 meters from the receiving antenna, which was mounted on the antenna tower.
4. The table was rotated 360 degrees to determine the position of the highest spurious emission.
5. The height of the receiving antenna is varied between one meter and four meters to search for the maximum spurious emission for both horizontal and vertical polarizations.
6. Make the measurement with the spectrum analyzer's RBW = 1MHz, VBW = 3MHz, taking record of maximum spurious emission.
7. A horn antenna was substituted in place of the EUT and was driven by a signal generator.
8. Tune the output power of signal generator to the same emission level with EUT maximum spurious emission.
9. Taking the record of output power at antenna port.
10. Repeat step 7 to step 8 for another polarization.
11. $EIRP \text{ (dBm)} = S.G. \text{ Power} - Tx \text{ Cable Loss} + Tx \text{ Antenna Gain}$
12. $ERP \text{ (dBm)} = EIRP - 2.15$
13. The RF fundamental frequency should be excluded against the limit line in the operating frequency band.
14. The limit line is derived from $43 + 10\log(P)$ dB below the transmitter power P(Watts)
 $= P(W) - [43 + 10\log(P)] \text{ (dB)}$
 $= [30 + 10\log(P)] \text{ (dBm)} - [43 + 10\log(P)] \text{ (dB)}$
 $= -13dBm.$



5 List of Measuring Equipment

Instrument	Manufacturer	Model No.	Serial No.	Characteristics	Calibration Date	Test Date	Due Date	Remark
Spectrum Analyzer	R&S	FSV40	101040	10Hz~40GHz	Aug. 09, 2016	Jan. 17, 2017	Aug. 08, 2017	Conducted (TH01-KS)
Radio Communicatio	Anritsu	MT8820C	6201300652	2G/3G/4G/CDMA	Aug. 08, 2016	Jan. 17, 2017	Aug. 07, 2017	Conducted (TH01-KS)
Thermal Chamber	Ten Billion	TTC-B3S	TBN-960502	-40~+150°C	Oct. 13, 2016	Jan. 17, 2017	Oct. 12, 2017	Conducted (TH01-KS)
EXA Spectrum Analyzer	Keysight	N9010A	MY55150208	10Hz~44GHz, MAX 30dB	Apr. 22, 2016	Jan. 16, 2017~Jan. 18, 2017	Apr. 21, 2017	Radiation (03CH02-KS)
Bilog Antenna	TeseQ	CBL6112D	37879	30MHz~2GHz	Aug. 20, 2016	Jan. 16, 2017~Jan. 18, 2017	Aug. 19, 2017	Radiation (03CH02-KS)
Double Ridge Horn Antenna	ETS-Lindgren	3117	75957	1GHz~18GHz	Oct. 22, 2016	Jan. 16, 2017~Jan. 18, 2017	Oct. 21, 2017	Radiation (03CH02-KS)
SHF-EHF Horn	Schwarzbeck	BBHA 9170	BBHA170249	15GHz~40GHz	Mar. 03, 2016	Jan. 16, 2017~Jan. 18, 2017	Mar. 02, 2017	Radiation (03CH02-KS)
Amplifier	com-power	PA-103A	161069	1kHz~1000MHz / 32 dB	Apr. 22, 2016	Jan. 16, 2017~Jan. 18, 2017	Apr. 21, 2017	Radiation (03CH02-KS)
Amplifier	Agilent	8449B	3008A02384	1~26.5GHz Gain 30dB	Oct. 13, 2016	Jan. 16, 2017~Jan. 18, 2017	Oct. 12, 2017	Radiation (03CH02-KS)
AC Power Source	Chroma	61601	616010002473	N/A	NCR	Jan. 16, 2017~Jan. 18, 2017	NCR	Radiation (03CH02-KS)
Turn Table	MF	MF7802	N/A	0~360 degree	NCR	Jan. 16, 2017~Jan. 18, 2017	NCR	Radiation (03CH02-KS)
Antenna Mast	MF	MF7802	N/A	1 m~4 m	NCR	Jan. 16, 2017~Jan. 18, 2017	NCR	Radiation (03CH02-KS)

NCR: No Calibration Required



6 Uncertainty of Evaluation

Uncertainty of Radiated Emission Measurement (30 MHz ~ 1000 MHz)

Measuring Uncertainty for a Level of Confidence of 95% ($U = 2Uc(y)$)	5.2dB
---	-------

Uncertainty of Radiated Emission Measurement (1GHz ~ 18GHz)

Measuring Uncertainty for a Level of Confidence of 95% ($U = 2Uc(y)$)	4.7dB
---	-------

Uncertainty of Radiated Emission Measurement (18GHz ~ 40GHz)

Measuring Uncertainty for a Level of Confidence of 95% ($U = 2Uc(y)$)	5.3dB
---	-------



Appendix A. Test Results of Conducted Test

Conducted Output Power(Average power)

Conducted Power (*Unit: dBm)									
Band	WCDMA Band V			WCDMA Band II			WCDMA Band IV		
Channel	4132	4182	4233	9262	9400	9538	1312	1413	1513
Frequency	826.4	836.4	846.6	1852.4	1880	1907.6	1712.4	1732.6	1752.6
AMR 12.2Kbps	24.08	24.06	24.01	21.95	22.02	21.89	23.44	23.36	23.36
RMC 12.2Kbps	24.10	24.07	24.02	21.96	22.04	21.91	23.46	23.38	23.37
HSDPA Subtest-1	23.34	23.40	23.31	20.88	20.98	20.84	22.88	22.63	22.92
HSDPA Subtest-2	23.44	23.57	23.16	20.93	21.06	20.84	22.73	22.72	22.84
HSDPA Subtest-3	22.96	23.14	22.74	20.56	20.70	20.38	22.31	22.29	22.42
HSDPA Subtest-4	22.97	23.16	22.74	20.55	20.64	20.44	22.30	22.29	22.46
HSUPA Subtest-1	23.11	23.25	22.89	21.07	21.26	20.94	22.52	22.84	22.51
HSUPA Subtest-2	22.57	22.52	22.21	19.14	19.18	18.94	21.33	21.67	21.80
HSUPA Subtest-3	22.55	22.50	22.29	20.19	20.23	19.99	21.45	21.30	21.48
HSUPA Subtest-4	23.08	23.10	22.68	19.31	19.29	18.97	21.83	21.66	21.92
HSUPA Subtest-5	23.57	23.51	23.21	21.12	21.11	20.93	22.71	22.93	22.78



ERP/EIRP

WCDMA Band V ($G_T - L_C = -1.30\text{dB}$)			
Channel	4132	4182	4233
	(Low)	(Mid)	(High)
Frequency	826.4	836.4	846.6
(MHz)			
Conducted Power (dBm)	24.10	24.07	24.02
Conducted Power (Watts)	0.2570	0.2553	0.2523
ERP(dBm)	20.65	20.62	20.57
ERP(Watts)	0.1161	0.1153	0.1140

WCDMA Band II ($G_T - L_C = 1.00\text{dB}$)			
Channel	9262	9400	9538
	(Low)	(Mid)	(High)
Frequency	1852.4	1880	1907.6
(MHz)			
Conducted Power (dBm)	21.96	22.04	21.91
Conducted Power (Watts)	0.1570	0.1600	0.1552
EIRP(dBm)	22.96	23.04	22.91
EIRP(Watts)	0.1977	0.2014	0.1954

WCDMA Band IV ($G_T - L_C = -0.50\text{dB}$)			
Channel	1312	1413	1513
	(Low)	(Mid)	(High)
Frequency	1712.4	1732.6	1752.6
(MHz)			
Conducted Power (dBm)	23.46	23.38	23.37
Conducted Power (Watts)	0.2218	0.2178	0.2173
EIRP(dBm)	22.96	22.88	22.87
EIRP(Watts)	0.1977	0.1941	0.1936



Peak-to-Average Ratio

Mode	WCDMA Band V	WCDMA Band II	WCDMA Band IV	Limit: 13dB
Mod.	RMC 12.2Kbps	RMC 12.2Kbps	RMC 12.2Kbps	Result
Lowest CH	3.28	3.68	3.48	PASS
Middle CH	3.10	3.65	3.57	
Highest CH	3.07	3.77	3.68	



WCDMA Band V (RMC 12.2Kbps)

Lowest Channel

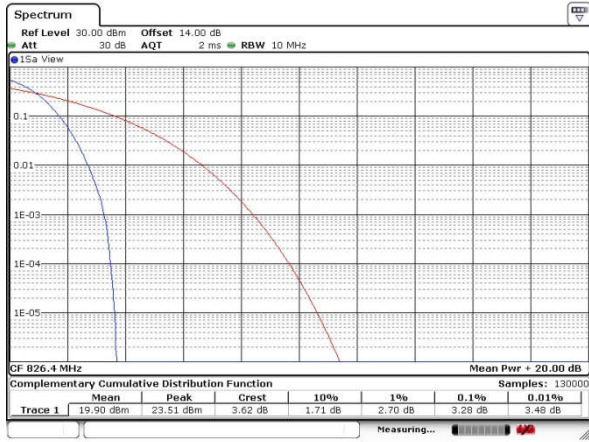

Date: 17 JAN 2017 16:11:12

WCDMA Band II (RMC 12.2Kbps)

Lowest Channel

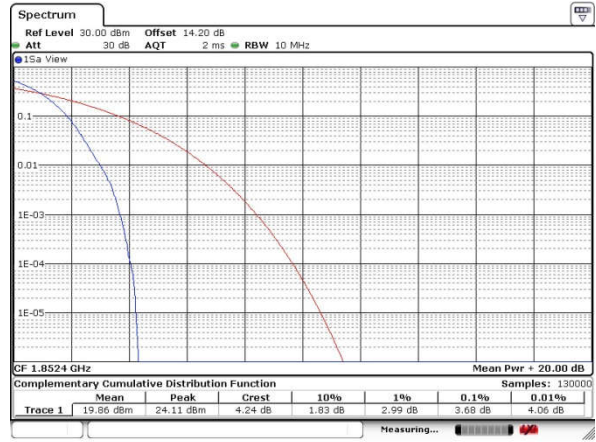

Date: 17 JAN 2017 16:27:30

Middle Channel

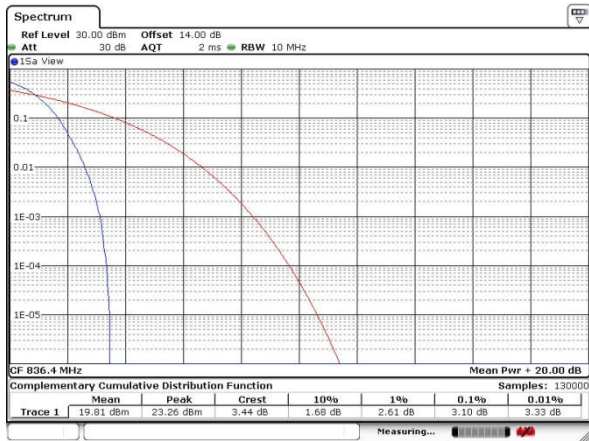

Date: 17 JAN 2017 16:11:19

Middle Channel

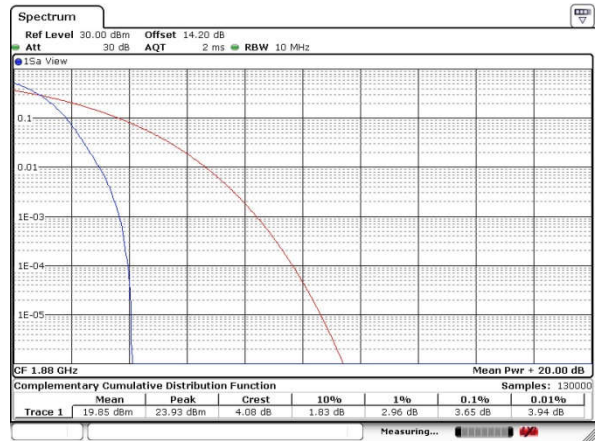

Date: 17 JAN 2017 16:27:38

Highest Channel

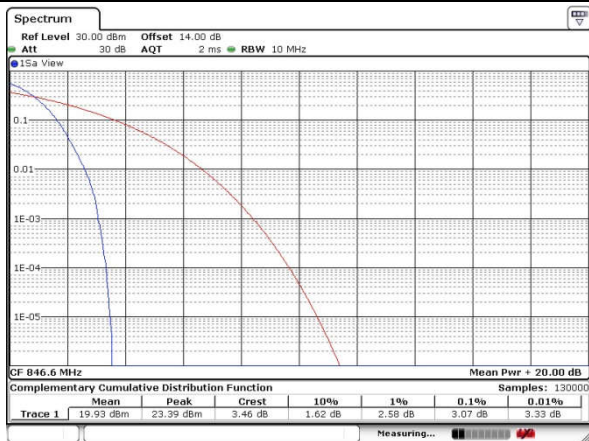

Date: 17 JAN 2017 16:11:26

Highest Channel



Date: 17 JAN 2017 16:27:45



WCDMA Band IV (RMC 12.2Kbps)

Lowest Channel

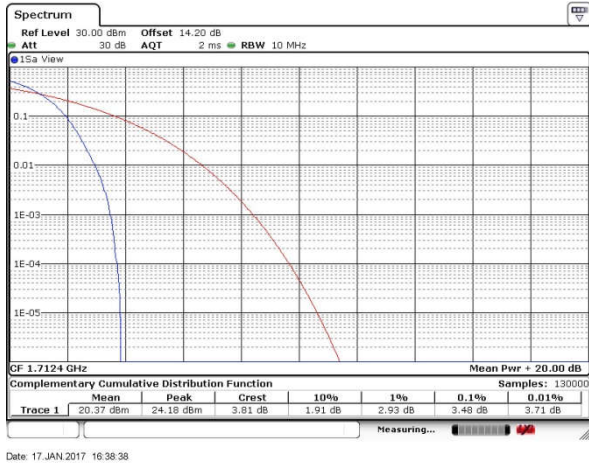

Date: 17.JAN.2017 16:38:38

Middle Channel

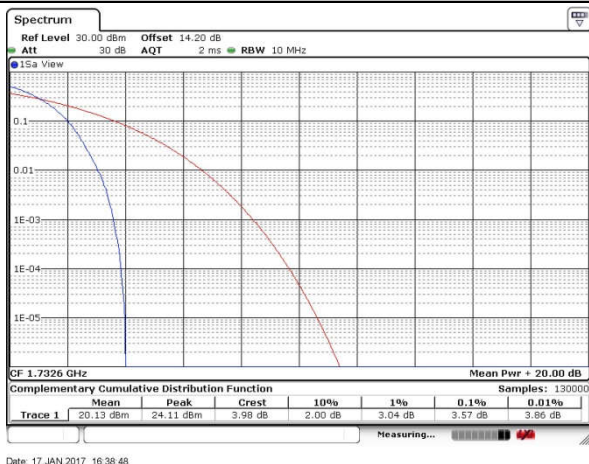

Date: 17.JAN.2017 16:38:48

Highest Channel

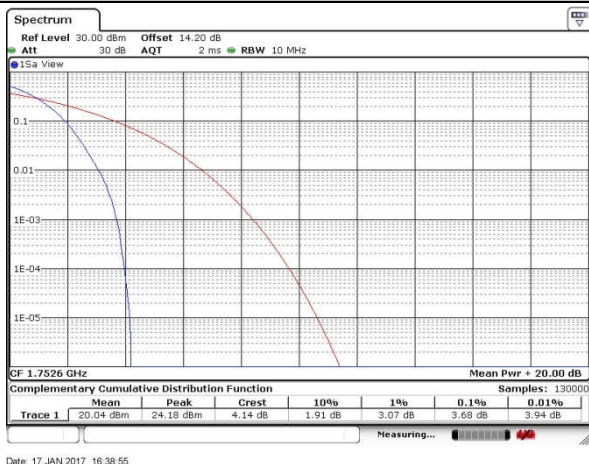

Date: 17.JAN.2017 16:38:55



26dB Bandwidth

Mode	WCDMA Band V	WCDMA Band II	WCDMA Band IV
Mod.	RMC 12.2Kbps	RMC 12.2Kbps	RMC 12.2Kbps
Lowest CH	4.71	4.72	4.71
Middle CH	4.71	4.72	4.71
Highest CH	4.73	4.71	4.70



WCDMA Band V (RMC 12.2Kbps)

Lowest Channel

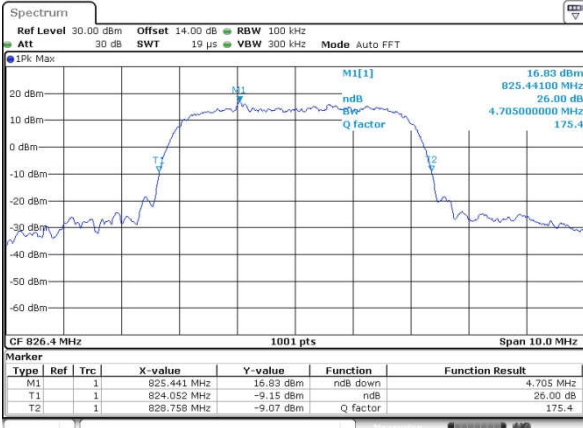

Date: 17 JAN 2017 15:50:18

WCDMA Band II (RMC 12.2Kbps)

Lowest Channel

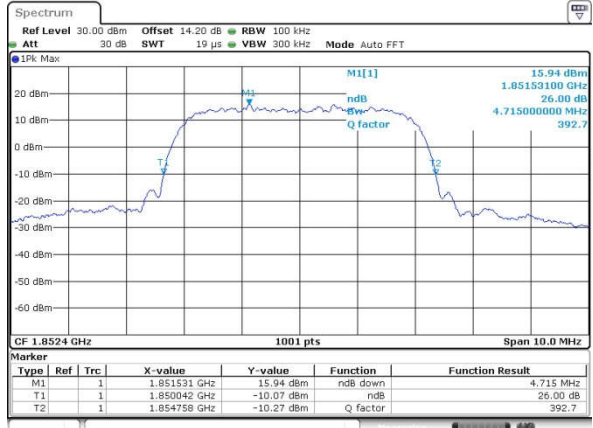

Date: 17 JAN 2017 16:13:45

Middle Channel

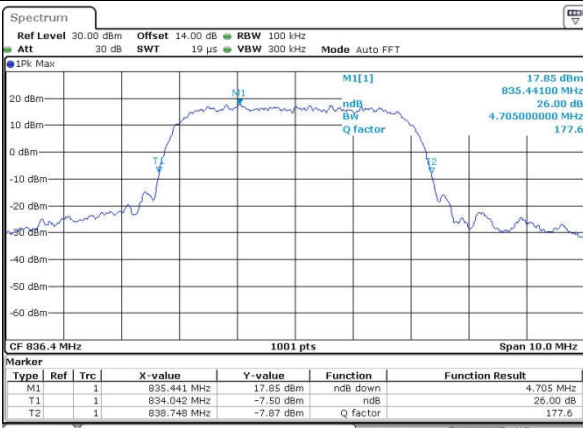

Date: 17 JAN 2017 15:50:46

Middle Channel

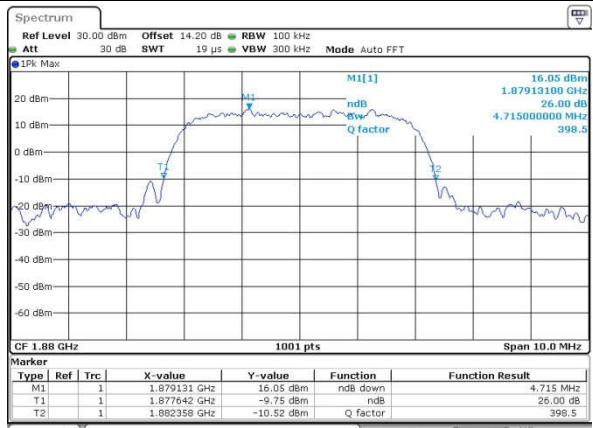

Date: 17 JAN 2017 16:14:13

Highest Channel

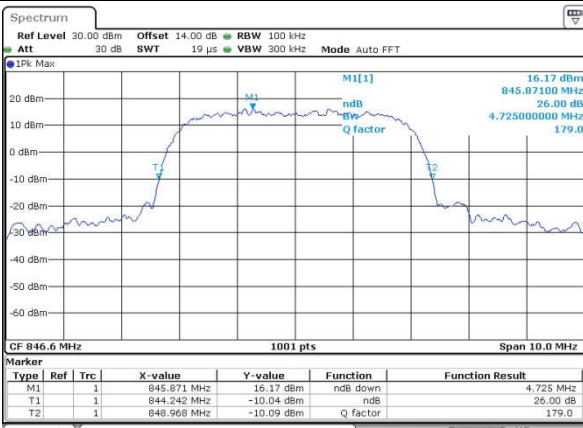

Date: 17 JAN 2017 15:51:14

Highest Channel

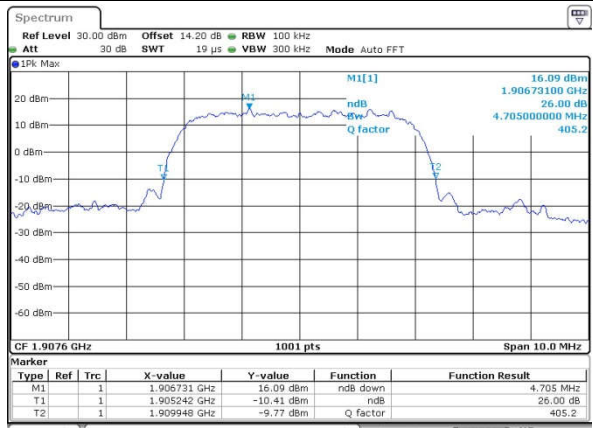

Date: 17 JAN 2017 16:14:41



WCDMA Band IV (RMC 12.2Kbps)

Lowest Channel

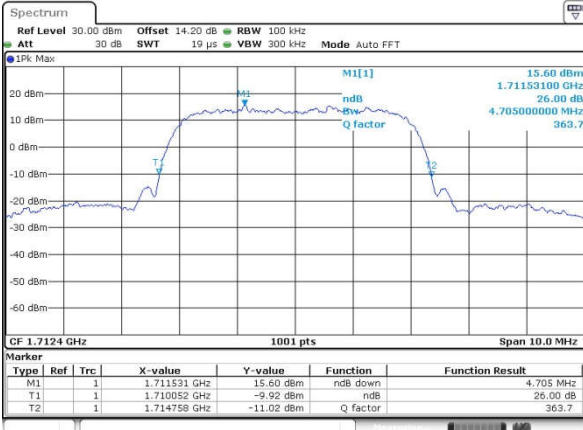

Date: 17 JAN 2017 16:28:50

Middle Channel

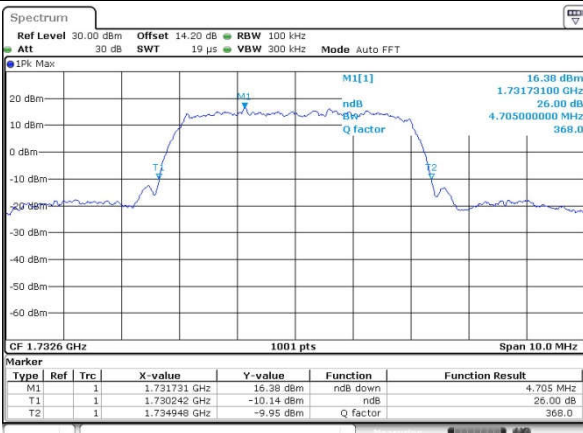

Date: 17 JAN 2017 16:29:19

Highest Channel

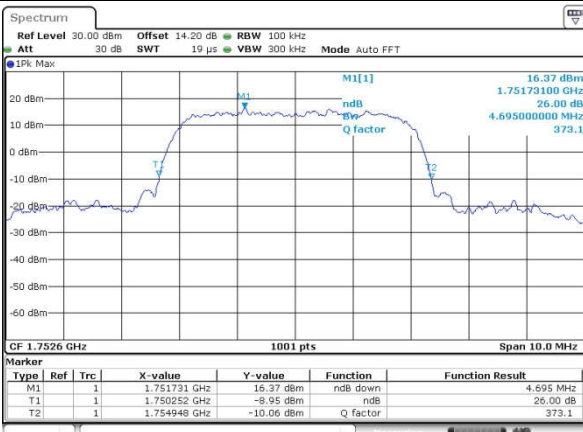

Date: 17 JAN 2017 16:29:47



Occupied Bandwidth

Mode	WCDMA Band V	WCDMA Band II	WCDMA Band IV
Mod.	RMC 12.2Kbps	RMC 12.2Kbps	RMC 12.2Kbps
Lowest CH	4.16	4.15	4.17
Middle CH	4.15	4.16	4.16
Highest CH	4.13	4.15	4.16



WCDMA Band V (RMC 12.2Kbps)

Lowest Channel

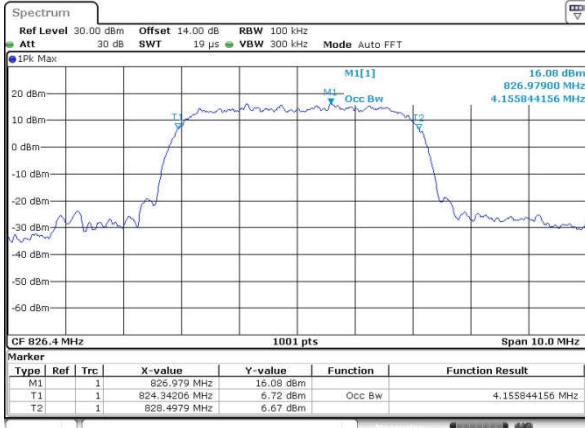

Date: 17 JAN 2017 15:52:30

WCDMA Band II (RMC 12.2Kbps)

Lowest Channel

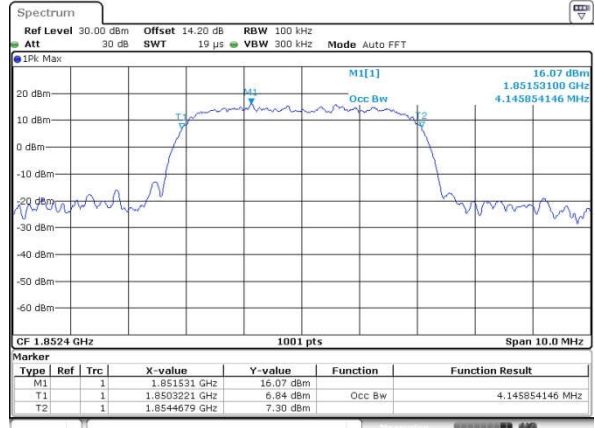

Date: 17 JAN 2017 16:16:44

Middle Channel

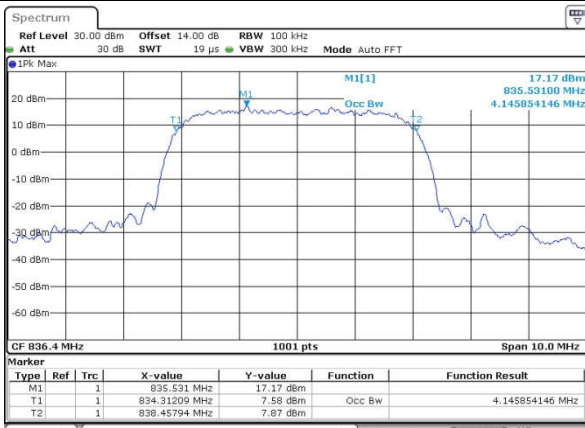

Date: 17 JAN 2017 15:52:59

Middle Channel

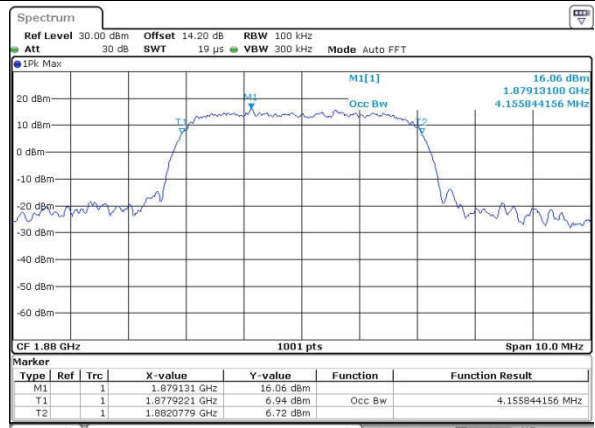

Date: 17 JAN 2017 16:17:12

Highest Channel

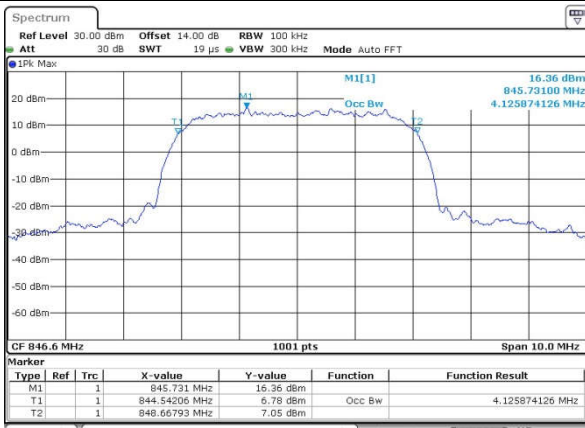

Date: 17 JAN 2017 15:53:27

Highest Channel

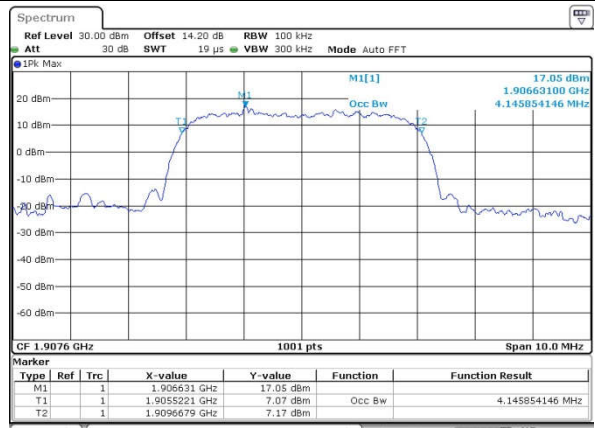

Date: 17 JAN 2017 16:17:40



WCDMA Band IV (RMC 12.2Kbps)

Lowest Channel

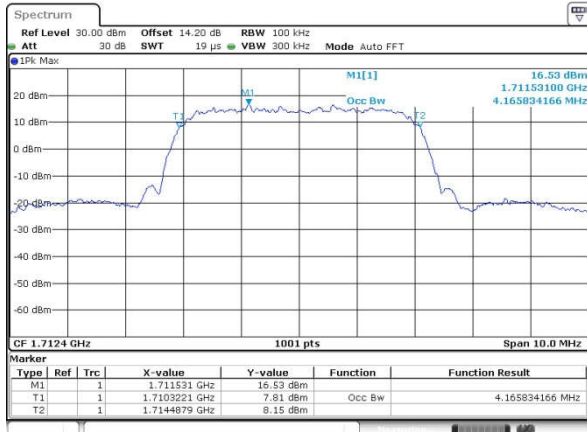

Date: 17 JAN 2017 16:32:00

Middle Channel

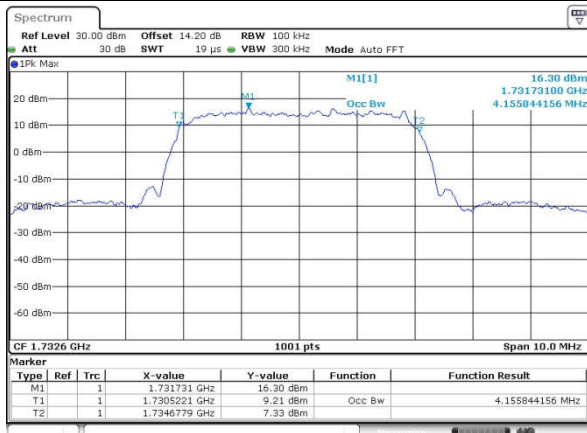

Date: 17 JAN 2017 16:32:28

Highest Channel

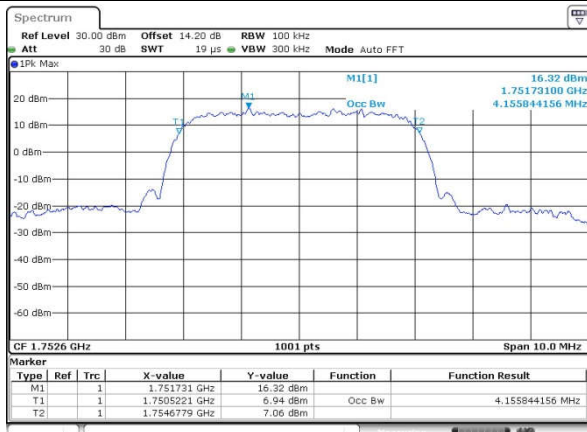

Date: 17 JAN 2017 16:32:56



Conducted Band Edge

WCDMA Band V (RMC 12.2Kbps)

Lowest Band Edge

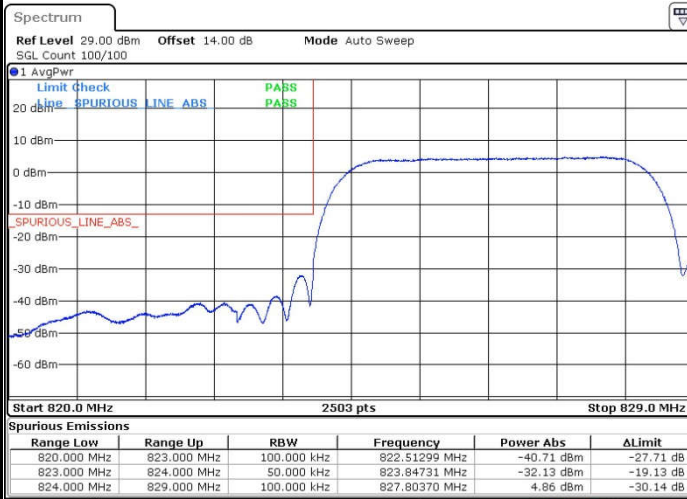

Date: 17.JAN.2017 16:01:31

Highest Band Edge

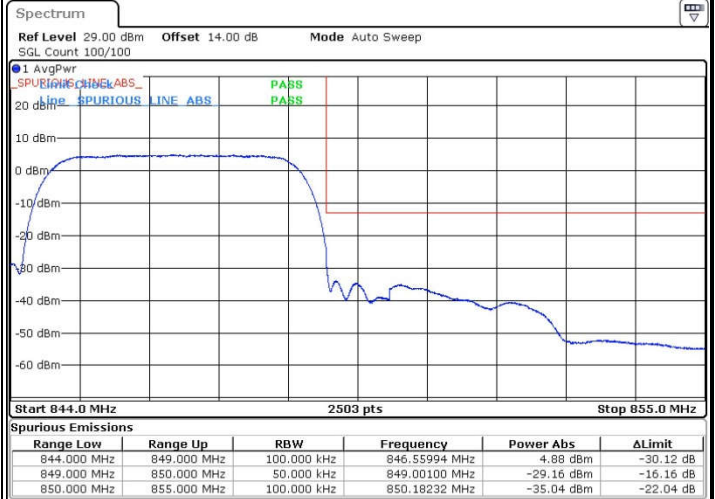

Date: 17.JAN.2017 16:04:12

WCDMA Band II (RMC 12.2Kbps)

Lowest Band Edge

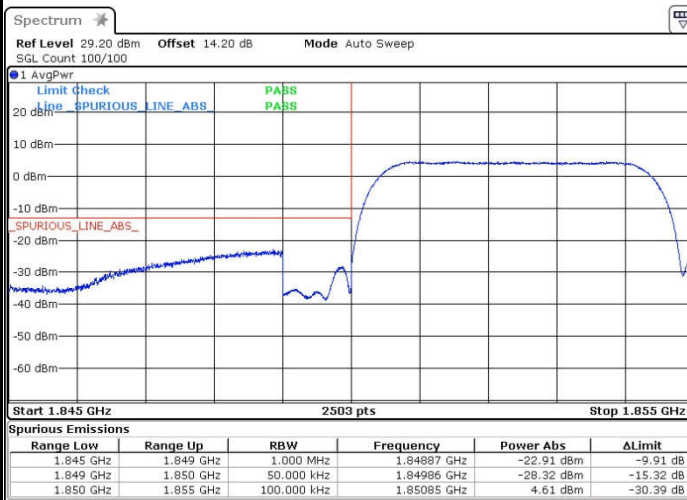

Date: 17.JAN.2017 16:20:23

Highest Band Edge

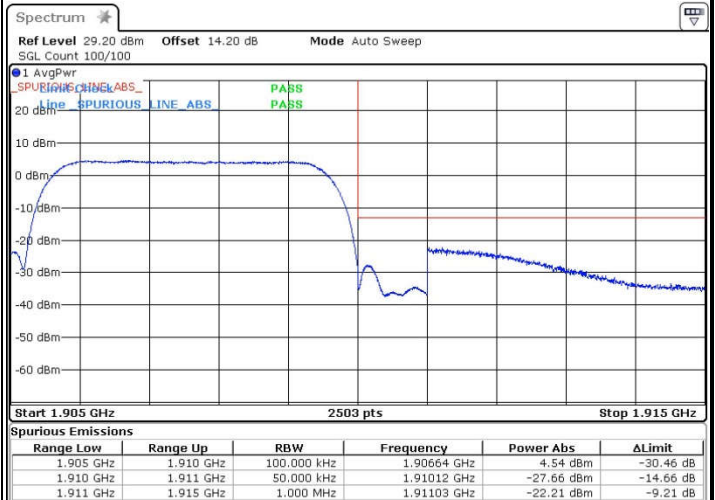

Date: 17.JAN.2017 16:23:04



WCDMA Band IV (RMC 12.2Kbps)

Lowest Band Edge

Highest Band Edge

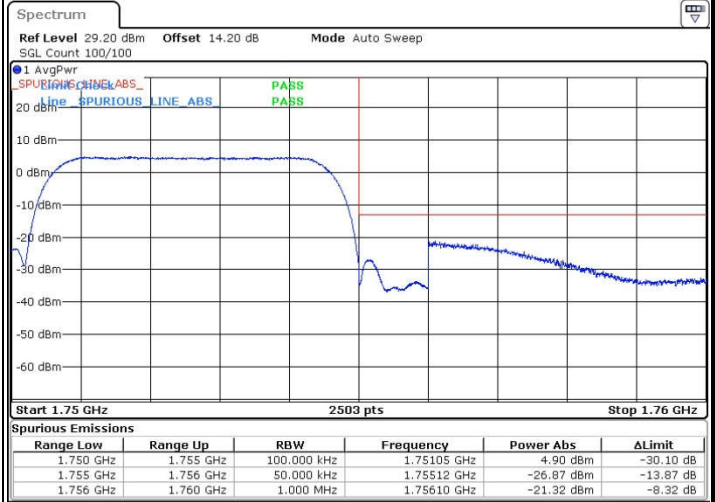
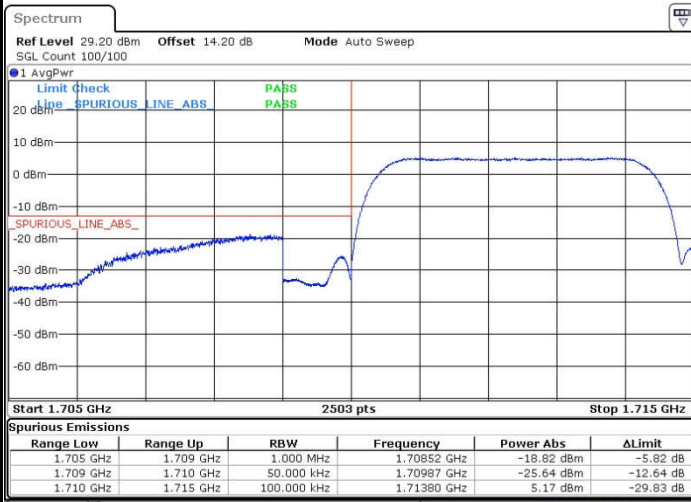

Date: 17.JAN.2017 16:35:40

Date: 17.JAN.2017 16:38:21



Conducted Spurious Emission

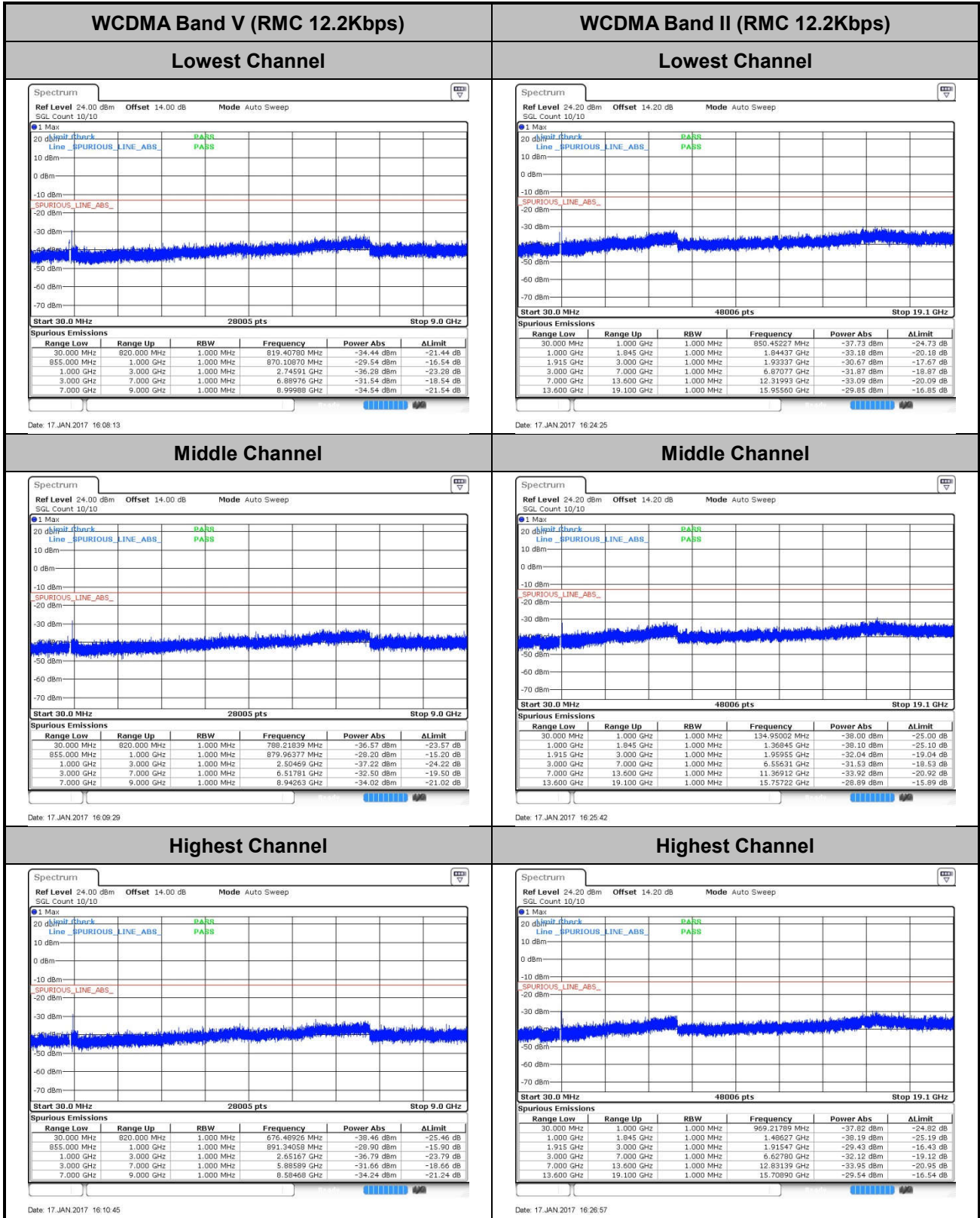



WCDMA Band IV (RMC 12.2Kbps)

Lowest Channel

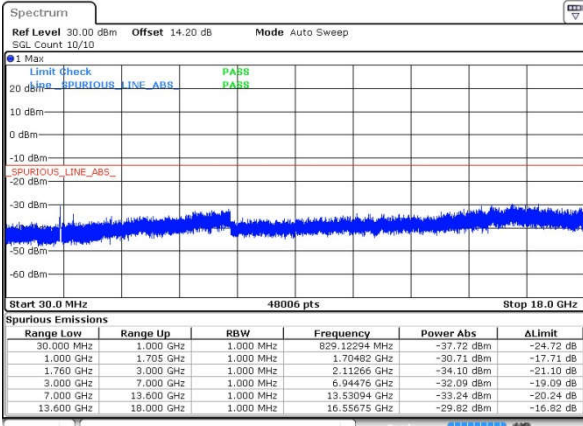

Date: 17.JAN.2017 16:40:33

Middle Channel

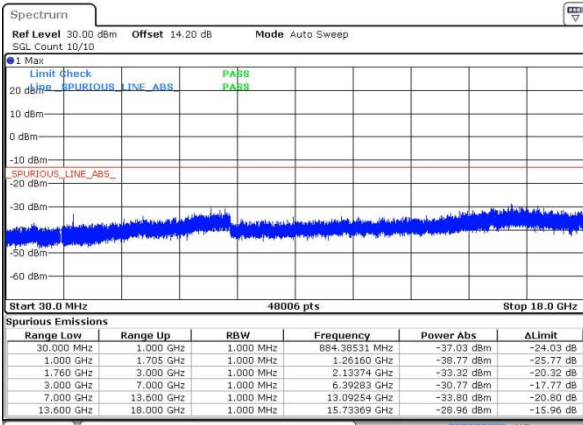

Date: 17.JAN.2017 16:41:51

Highest Channel

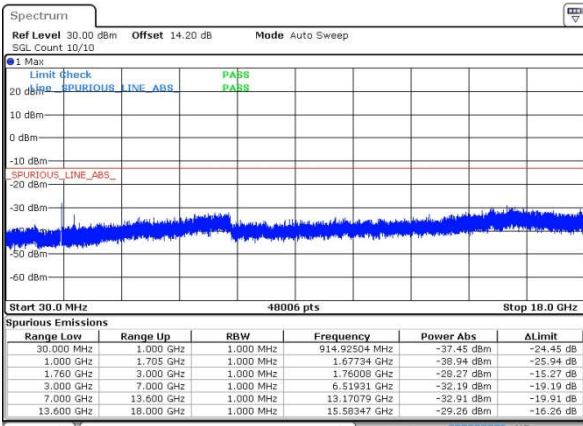

Date: 17.JAN.2017 16:43:06



Frequency Stability

Test Conditions	Middle Channel	WCDMA Band V (RMC 12.2Kbps)	Limit 2.5ppm
Temperature (°C)	Voltage (Volt)	Deviation (ppm)	Result
50	Normal Voltage	0.0143	PASS
40	Normal Voltage	0.0120	
30	Normal Voltage	0.0215	
20(Ref.)	Normal Voltage	0.0000	
10	Normal Voltage	0.0132	
0	Normal Voltage	0.0203	
-10	Normal Voltage	0.0060	
-20	Normal Voltage	0.0143	
-30	Normal Voltage	0.0036	
20	Maximum Voltage	0.0120	
20	Normal Voltage	0.0012	
20	Battery End Point	0.0263	

Note: Normal Voltage = 3.8V. ; Battery End Point (BEP) = 3.5V. ; Maximum Voltage =4.2V

Test Conditions	Middle Channel	WCDMA Band II (RMC 12.2Kbps)	Limit Note 2.
Temperature (°C)	Voltage (Volt)	Deviation (ppm)	Result
50	Normal Voltage	0.0032	PASS
40	Normal Voltage	0.0037	
30	Normal Voltage	0.0021	
20(Ref.)	Normal Voltage	0.0000	
10	Normal Voltage	0.0043	
0	Normal Voltage	0.0005	
-10	Normal Voltage	0.0037	
-20	Normal Voltage	0.0117	
-30	Normal Voltage	0.0005	
20	Maximum Voltage	0.0043	
20	Normal Voltage	0.0059	
20	Battery End Point	0.0144	

Note:

1. Normal Voltage = 3.8V. ; Battery End Point (BEP) = 3.5V. ; Maximum Voltage =4.2V
2. The frequency fundamental emissions stay within the authorized frequency block based on the frequency deviation measured is small.



Test Conditions	Middle Channel	WCDMA Band IV (RMC 12.2Kbps)	Limit Note 2.
Temperature (°C)	Voltage (Volt)	Deviation (ppm)	Result
50	Normal Voltage	0.0023	PASS
40	Normal Voltage	0.0063	
30	Normal Voltage	0.0040	
20(Ref.)	Normal Voltage	0.0000	
10	Normal Voltage	0.0006	
0	Normal Voltage	0.0017	
-10	Normal Voltage	0.0121	
-20	Normal Voltage	0.0087	
-30	Normal Voltage	0.0052	
20	Maximum Voltage	0.0046	
20	Normal Voltage	0.0069	
20	Battery End Point	0.0208	

Note:

1. Normal Voltage = 3.8V. ; Battery End Point (BEP) = 3.5V. ; Maximum Voltage =4.2V
2. The frequency fundamental emissions stay within the authorized frequency block based on the frequency deviation measured is small.



Appendix B. Test Results of Radiated Test

Radiated Spurious Emission

WCDMA Band V(RMC 12.2Kbps)									
Channel	Frequency (MHz)	ERP (dBm)	Limit (dBm)	Over Limit (dB)	SPA Reading (dBm)	S.G. Power (dBm)	TX Cable loss (dB)	TX Antenna Gain (dBi)	Polarization (H/V)
Middle	1674	-50.47	-13	-37.47	-55.64	-52.79	1.33	5.80	H
	2512	-53.95	-13	-40.95	-63.30	-57.12	1.58	6.90	H
	3348	-63.08	-13	-50.08	-72.29	-66.58	1.85	7.50	H
	1670	-58.07	-13	-45.07	-60.47	-60.39	1.33	5.80	V
	2512	-59.81	-13	-46.81	-67.78	-62.98	1.58	6.90	V
	3345	-66.31	-13	-53.31	-75.33	-69.81	1.85	7.50	V

Remark: Spurious emissions within 30-1000MHz were found more than 20dB below limit line.

WCDMA Band II(RMC 12.2Kbps)									
Channel	Frequency (MHz)	EIRP (dBm)	Limit (dBm)	Over Limit (dB)	SPA Reading (dBm)	S.G. Power (dBm)	TX Cable loss (dB)	TX Antenna Gain (dBi)	Polarization (H/V)
Middle	3759	-53.22	-13	-40.22	-67.46	-54.93	5.08	6.80	H
	5640	-47.56	-13	-34.56	-64.36	-49.23	8.03	9.70	H
	7521	-55.19	-13	-42.19	-76.49	-57.57	9.43	11.81	H
	3759	-57.93	-13	-44.93	-70.36	-59.64	5.08	6.80	V
	5640	-54.53	-13	-41.53	-71.62	-56.20	8.03	9.70	V
	7521	-54.80	-13	-41.80	-75.94	-57.18	9.43	11.81	V

Remark: Spurious emissions within 30-1000MHz were found more than 20dB below limit line.

WCDMA Band IV(RMC 12.2Kbps)									
Channel	Frequency (MHz)	EIRP (dBm)	Limit (dBm)	Over Limit (dB)	SPA Reading (dBm)	S.G. Power (dBm)	TX Cable loss (dB)	TX Antenna Gain (dBi)	Polarization (H/V)
Middle	3465	-65.54	-13	-52.54	-74.44	-69.51	4.87	8.84	H
	5199	-53.62	-13	-40.62	-64.55	-55.06	7.70	9.14	H
	6930	-56.97	-13	-43.97	-75.44	-58.65	8.98	10.66	H
	3465	-62.98	-13	-49.98	-74.6	-66.95	4.87	8.84	V
	5199	-51.79	-13	-38.79	-65.84	-53.23	7.70	9.14	V
	6930	-57.51	-13	-44.51	-75.53	-59.19	8.98	10.66	V

Remark: Spurious emissions within 30-1000MHz were found more than 20dB below limit line.



Appendix D. Product Equality Declaration