



In Collaboration with
s p e a g
 CALIBRATION LABORATORY

Add: No.51 Xueyuan Road, Haidian District, Beijing, 100191, China
 Tel: +86-10-62304633-2079 Fax: +86-10-62304633-2504
 E-mail: cttl@chinattl.com http://www.chinattl.cn

Appendix (Additional assessments outside the scope of CNAS L0570)

Antenna Parameters with Head TSL

Impedance, transformed to feed point	53.4Ω+ 4.29jΩ
Return Loss	- 25.5dB

Antenna Parameters with Body TSL

Impedance, transformed to feed point	51.0Ω+ 6.61jΩ
Return Loss	- 23.6dB

General Antenna Parameters and Design

Electrical Delay (one direction)	1.265 ns
----------------------------------	----------

After long term use with 100W radiated power, only a slight warming of the dipole near the feedpoint can be measured.

The dipole is made of standard semirigid coaxial cable. The center conductor of the feeding line is directly connected to the second arm of the dipole. The antenna is therefore short-circuited for DC-signals. On some of the dipoles, small end caps are added to the dipole arms in order to improve matching when loaded according to the position as explained in the "Measurement Conditions" paragraph. The SAR data are not affected by this change. The overall dipole length is still according to the Standard. No excessive force must be applied to the dipole arms, because they might bend or the soldered connections near the feedpoint may be damaged.

Additional EUT Data

Manufactured by	SPEAG
-----------------	-------



In Collaboration with
s p e a g
CALIBRATION LABORATORY

Add: No.51 Xueyuan Road, Haidian District, Beijing, 100191, China
Tel: +86-10-62304633-2079 Fax: +86-10-62304633-2504
E-mail: cttl@chinattl.com http://www.chinattl.cn

DASY5 Validation Report for Head TSL

Date: 08.29.2017

Test Laboratory: CTTL, Beijing, China

DUT: Dipole 2450 MHz; Type: D2450V2; Serial: D2450V2 - SN: 786

Communication System: UID 0, CW; Frequency: 2450 MHz; Duty Cycle: 1:1

Medium parameters used: $f = 2450$ MHz; $\sigma = 1.822$ S/m; $\epsilon_r = 39.65$; $\rho = 1000$ kg/m³

Phantom section: Left Section

Measurement Standard: DASY5 (IEEE/IEC/ANSI C63.19-2007)

DASY5 Configuration:

- Probe: EX3DV4 - SN3617; ConvF(7.74, 7.74, 7.74); Calibrated: 1/23/2017;
- Sensor-Surface: 1.4mm (Mechanical Surface Detection)
- Electronics: DAE4 Sn1331; Calibrated: 1/19/2017
- Phantom: Triple Flat Phantom 5.1C; Type: QD 000 P51 CA; Serial: 1161/1
- Measurement SW: DASY52, Version 52.10 (0); SEMCAD X Version 14.6.10 (7417)

Dipole Calibration/Zoom Scan (7x7x7) (7x7x7)/Cube 0: Measurement grid: dx=5mm, dy=5mm, dz=5mm

Reference Value = 105.1 V/m; Power Drift = -0.03 dB

Peak SAR (extrapolated) = 27.5 W/kg

SAR(1 g) = 13.2 W/kg; SAR(10 g) = 6.16 W/kg

Maximum value of SAR (measured) = 22.2 W/kg

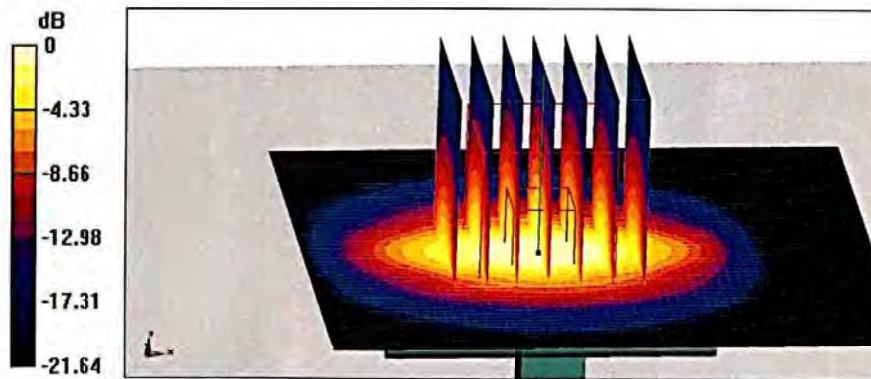

0 dB = 22.2 W/kg = 13.46 dBW/kg



In Collaboration with
s p e a g
CALIBRATION LABORATORY

Add: No.51 Xueyuan Road, Haidian District, Beijing, 100191, China
Tel: +86-10-62304633-2079 Fax: +86-10-62304633-2504
E-mail: cttl@chinattl.com http://www.chinattl.cn

Impedance Measurement Plot for Head TSL

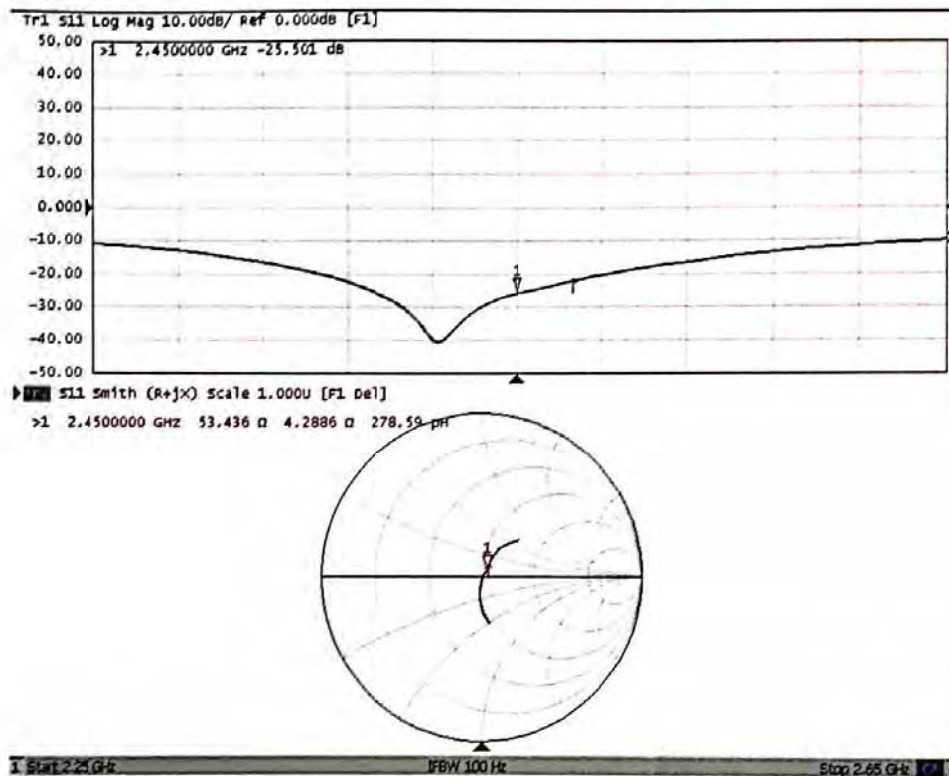



In Collaboration with
s p e a g
CALIBRATION LABORATORY

Add: No.51 Xueyuan Road, Haidian District, Beijing, 100191, China
Tel: +86-10-62304633-2079 Fax: +86-10-62304633-2504
E-mail: cttl@chinattl.com http://www.chinattl.cn

DASY5 Validation Report for Body TSL

Date: 08.29.2017

Test Laboratory: CTTL, Beijing, China

DUT: Dipole 2450 MHz; Type: D2450V2; Serial: D2450V2 - SN: 786

Communication System: UID 0, CW; Frequency: 2450 MHz; Duty Cycle: 1:1

Medium parameters used: $f = 2450$ MHz; $\sigma = 1.943$ S/m; $\epsilon_r = 52.45$; $\rho = 1000$ kg/m³

Phantom section: Right Section

Measurement Standard: DASY5 (IEEE/IEC/ANSI C63.19-2007)

DASY5 Configuration:

- Probe: EX3DV4 - SN3617; ConvF(7.8, 7.8, 7.8); Calibrated: 1/23/2017;
- Sensor-Surface: 1.4mm (Mechanical Surface Detection)
- Electronics: DAE4 Sn1331; Calibrated: 1/19/2017
- Phantom: Triple Flat Phantom 5.1C; Type: QD 000 P51 CA; Serial: 1161/1
- Measurement SW: DASY52, Version 52.10 (0); SEMCAD X Version 14.6.10 (7417)

Dipole Calibration/Zoom Scan (7x7x7) (7x7x7)/Cube 0: Measurement grid: dx=5mm, dy=5mm, dz=5mm

Reference Value = 92.28 V/m; Power Drift = -0.01 dB

Peak SAR (extrapolated) = 27.0 W/kg

SAR(1 g) = 12.7 W/kg; SAR(10 g) = 5.87 W/kg

Maximum value of SAR (measured) = 21.5 W/kg

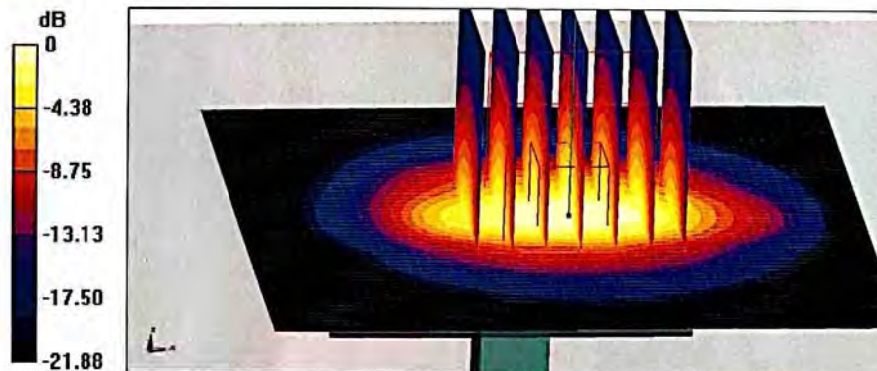
**0 dB = 21.5 W/kg = 13.32 dBW/kg**



In Collaboration with
s p e a g
CALIBRATION LABORATORY

Add: No.51 Xueyuan Road, Haidian District, Beijing, 100191, China
Tel: +86-10-62304633-2079 Fax: +86-10-62304633-2504
E-mail: cttl@chinattl.com http://www.chinattl.cn

Impedance Measurement Plot for Body TSL

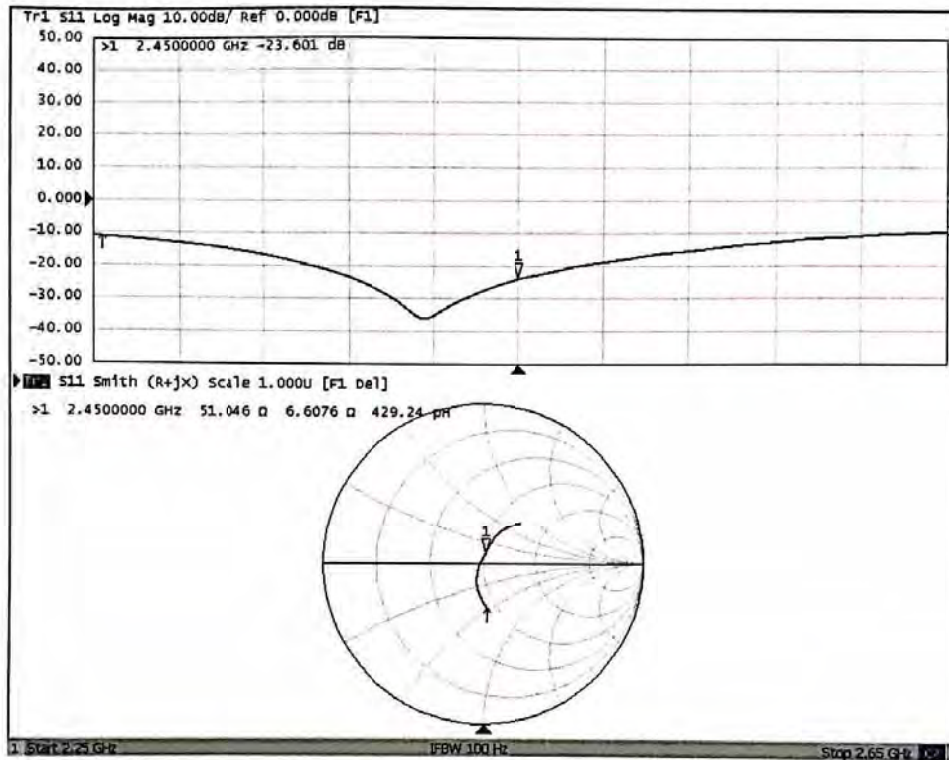



ANNEX H: D2600V2 Dipole Calibration Certificate

**Calibration Laboratory of
Schmid & Partner
Engineering AG**
Zeughausstrasse 43, 8004 Zurich, Switzerland



S Schweizerischer Kalibrierdienst
C Service suisse d'étalonnage
S Servizio svizzero di taratura
S Swiss Calibration Service

Accredited by the Swiss Accreditation Service (SAS)
The Swiss Accreditation Service is one of the signatories to the EA
Multilateral Agreement for the recognition of calibration certificates

Accreditation No.: **SCS 108**

Client **TA (Auden)**

Certificate No: **D2600V2-1025_Dec14**

CALIBRATION CERTIFICATE			
Object	D2600V2 - SN: 1025		
Calibration procedure(s)	QA CAL-05.v9 Calibration procedure for dipole validation kits above 700 MHz		
Calibration date:	December 08, 2014		
This calibration certificate documents the traceability to national standards, which realize the physical units of measurements (SI). The measurements and the uncertainties with confidence probability are given on the following pages and are part of the certificate.			
All calibrations have been conducted in the closed laboratory facility: environment temperature (22 ± 3)°C and humidity < 70%.			
Calibration Equipment used (M&TE critical for calibration)			
Primary Standards	ID #	Cal Date (Certificate No.)	Scheduled Calibration
Power meter EPM-442A	GB37480704	07-Oct-14 (No. 217-02020)	Oct-15
Power sensor HP 8481A	US37292783	07-Oct-14 (No. 217-02020)	Oct-15
Power sensor HP 8481A	MY41092317	07-Oct-14 (No. 217-02021)	Oct-15
Reference 20 dB Attenuator	SN: 5058 (20k)	03-Apr-14 (No. 217-01918)	Apr-15
Type-N mismatch combination	SN: 5047.2 / 06327	03-Apr-14 (No. 217-01921)	Apr-15
Reference Probe ES3DV3	SN: 3205	30-Dec-13 (No. ES3-3205_Dec13)	Dec-14
DAE4	SN: 601	18-Aug-14 (No. DAE4-601_Aug14)	Aug-15
Secondary Standards	ID #	Check Date (in house)	Scheduled Check
RF generator R&S SMT-06	100005	04-Aug-99 (in house check Oct-13)	In house check: Oct-16
Network Analyzer HP 8753E	US37390585 S4206	18-Oct-01 (in house check Oct-14)	In house check: Oct-15
Calibrated by:	Name Michael Weber	Function Laboratory Technician	Signature
Approved by:	Name Katja Pokovic	Function Technical Manager	Signature
			Issued: December 9, 2014
This calibration certificate shall not be reproduced except in full without written approval of the laboratory.			

**Calibration Laboratory of
Schmid & Partner
Engineering AG**
Zeughausstrasse 43, 8004 Zurich, Switzerland



S Schweizerischer Kalibrierdienst
S Service suisse d'étalonnage
C Servizio svizzero di taratura
S Swiss Calibration Service

Accredited by the Swiss Accreditation Service (SAS)

The Swiss Accreditation Service is one of the signatories to the EA
Multilateral Agreement for the recognition of calibration certificates

Accreditation No.: **SCS 108**

Glossary:

TSL	tissue simulating liquid
ConvF	sensitivity in TSL / NORM x,y,z
N/A	not applicable or not measured

Calibration is Performed According to the Following Standards:

- IEEE Std 1528-2013, "IEEE Recommended Practice for Determining the Peak Spatial-Averaged Specific Absorption Rate (SAR) in the Human Head from Wireless Communications Devices: Measurement Techniques", June 2013
- IEC 62209-1, "Procedure to measure the Specific Absorption Rate (SAR) for hand-held devices used in close proximity to the ear (frequency range of 300 MHz to 3 GHz)", February 2005
- KDB 865664, "SAR Measurement Requirements for 100 MHz to 6 GHz"

Additional Documentation:

- DASY4/5 System Handbook

Methods Applied and Interpretation of Parameters:

- Measurement Conditions:** Further details are available from the Validation Report at the end of the certificate. All figures stated in the certificate are valid at the frequency indicated.
- Antenna Parameters with TSL:** The dipole is mounted with the spacer to position its feed point exactly below the center marking of the flat phantom section, with the arms oriented parallel to the body axis.
- Feed Point Impedance and Return Loss:** These parameters are measured with the dipole positioned under the liquid filled phantom. The impedance stated is transformed from the measurement at the SMA connector to the feed point. The Return Loss ensures low reflected power. No uncertainty required.
- Electrical Delay:** One-way delay between the SMA connector and the antenna feed point. No uncertainty required.
- SAR measured:** SAR measured at the stated antenna input power.
- SAR normalized:** SAR as measured, normalized to an input power of 1 W at the antenna connector.
- SAR for nominal TSL parameters:** The measured TSL parameters are used to calculate the nominal SAR result.

The reported uncertainty of measurement is stated as the standard uncertainty of measurement multiplied by the coverage factor $k=2$, which for a normal distribution corresponds to a coverage probability of approximately 95%.

Measurement Conditions

DASY system configuration, as far as not given on page 1.

DASY Version	DASY5	V52.8.8
Extrapolation	Advanced Extrapolation	
Phantom	Modular Flat Phantom	
Distance Dipole Center - TSL	10 mm	with Spacer
Zoom Scan Resolution	dx, dy, dz = 5 mm	
Frequency	2600 MHz ± 1 MHz	

Head TSL parameters

The following parameters and calculations were applied.

	Temperature	Permittivity	Conductivity
Nominal Head TSL parameters	22.0 °C	39.0	1.96 mho/m
Measured Head TSL parameters	(22.0 ± 0.2) °C	39.1 ± 6 %	2.02 mho/m ± 6 %
Head TSL temperature change during test	< 0.5 °C	----	----

SAR result with Head TSL

SAR averaged over 1 cm³ (1 g) of Head TSL	Condition	
SAR measured	250 mW input power	14.4 W/kg
SAR for nominal Head TSL parameters	normalized to 1W	56.9 W/kg ± 17.0 % (k=2)

SAR averaged over 10 cm³ (10 g) of Head TSL	condition	
SAR measured	250 mW input power	6.40 W/kg
SAR for nominal Head TSL parameters	normalized to 1W	25.4 W/kg ± 16.5 % (k=2)

Body TSL parameters

The following parameters and calculations were applied.

	Temperature	Permittivity	Conductivity
Nominal Body TSL parameters	22.0 °C	52.5	2.16 mho/m
Measured Body TSL parameters	(22.0 ± 0.2) °C	50.5 ± 6 %	2.22 mho/m ± 6 %
Body TSL temperature change during test	< 0.5 °C	----	----

SAR result with Body TSL

SAR averaged over 1 cm³ (1 g) of Body TSL	Condition	
SAR measured	250 mW input power	14.4 W/kg
SAR for nominal Body TSL parameters	normalized to 1W	56.4 W/kg ± 17.0 % (k=2)

SAR averaged over 10 cm³ (10 g) of Body TSL	condition	
SAR measured	250 mW input power	6.36 W/kg
SAR for nominal Body TSL parameters	normalized to 1W	25.1 W/kg ± 16.5 % (k=2)

Appendix (Additional assessments outside the scope of SCS108)**Antenna Parameters with Head TSL**

Impedance, transformed to feed point	49.7 Ω - 6.2 j Ω
Return Loss	- 24.2 dB

Antenna Parameters with Body TSL

Impedance, transformed to feed point	46.6 Ω - 5.4 j Ω
Return Loss	- 23.6 dB

General Antenna Parameters and Design

Electrical Delay (one direction)	1.150 ns
----------------------------------	----------

After long term use with 100W radiated power, only a slight warming of the dipole near the feedpoint can be measured.

The dipole is made of standard semirigid coaxial cable. The center conductor of the feeding line is directly connected to the second arm of the dipole. The antenna is therefore short-circuited for DC-signals. On some of the dipoles, small end caps are added to the dipole arms in order to improve matching when loaded according to the position as explained in the "Measurement Conditions" paragraph. The SAR data are not affected by this change. The overall dipole length is still according to the Standard.

No excessive force must be applied to the dipole arms, because they might bend or the soldered connections near the feedpoint may be damaged.

Additional EUT Data

Manufactured by	SPEAG
Manufactured on	May 13, 2008

DASY5 Validation Report for Head TSL

Date: 08.12.2014

Test Laboratory: SPEAG, Zurich, Switzerland

DUT: Dipole 2600 MHz; Type: D2600V2; Serial: D2600V2 - SN: 1025

Communication System: UID 0 - CW; Frequency: 2600 MHz

Medium parameters used: $f = 2600$ MHz; $\sigma = 2.02$ S/m; $\epsilon_r = 39.1$; $\rho = 1000$ kg/m³

Phantom section: Flat Section

Measurement Standard: DASY5 (IEEE/IEC/ANSI C63.19-2011)

DASY52 Configuration:

- Probe: ES3DV3 - SN3205; ConvF(4.46, 4.46, 4.46); Calibrated: 30.12.2013;
- Sensor-Surface: 3mm (Mechanical Surface Detection)
- Electronics: DAE4 Sn601; Calibrated: 18.08.2014
- Phantom: Flat Phantom 5.0 (front); Type: QD000P50AA; Serial: 1001
- DASY52 52.8.8(1222); SEMCAD X 14.6.10(7331)

Dipole Calibration for Head Tissue/Pin=250 mW, d=10mm/Zoom Scan (7x7x7)/Cube 0:

Measurement grid: dx=5mm, dy=5mm, dz=5mm

Reference Value = 102.3 V/m; Power Drift = 0.03 dB

Peak SAR (extrapolated) = 30.9 W/kg

SAR(1 g) = 14.4 W/kg; SAR(10 g) = 6.4 W/kg

Maximum value of SAR (measured) = 19.4 W/kg

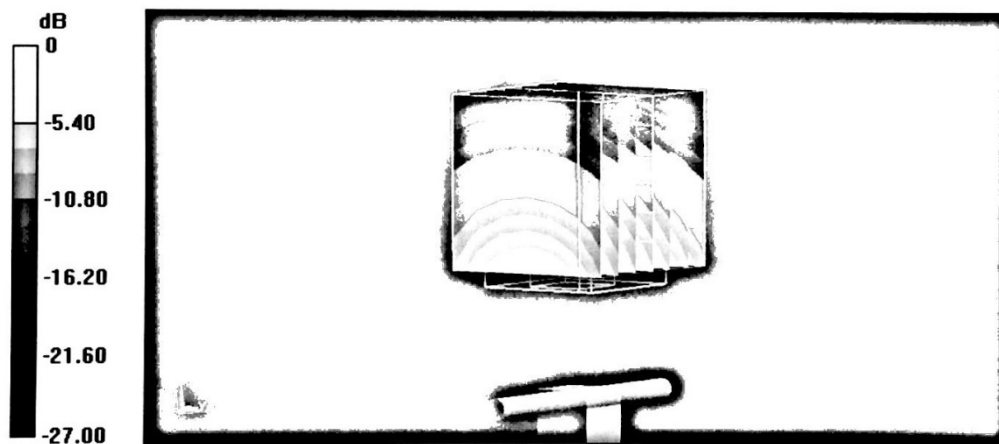

0 dB = 19.4 W/kg = 12.88 dBW/kg



Impedance Measurement Plot for Head TSL

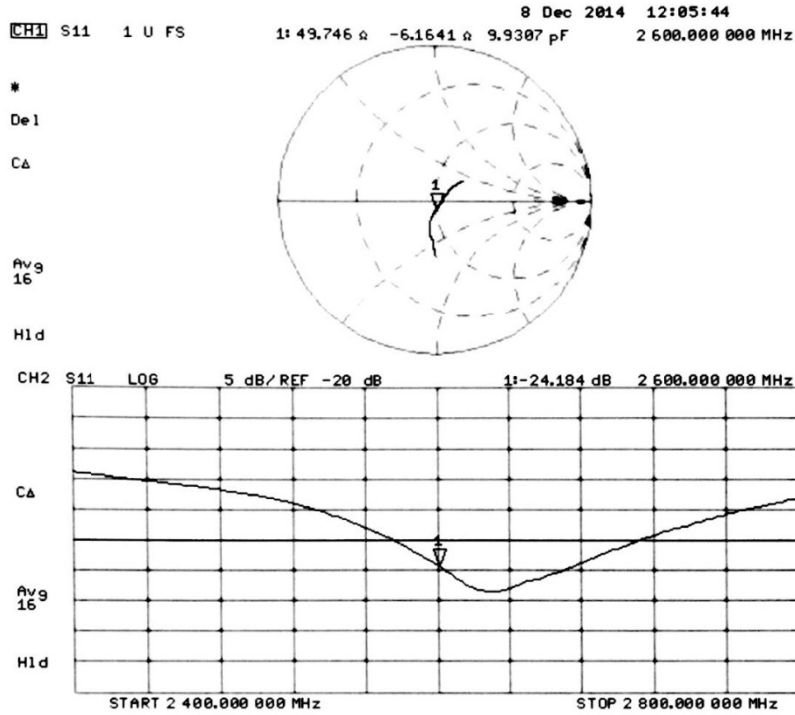

DASY5 Validation Report for Body TSL

Date: 08.12.2014

Test Laboratory: SPEAG, Zurich, Switzerland

DUT: Dipole 2600 MHz; Type: D2600V2; Serial: D2600V2 - SN: 1025

Communication System: UID 0 - CW; Frequency: 2600 MHz

Medium parameters used: $f = 2600$ MHz; $\sigma = 2.22$ S/m; $\epsilon_r = 50.5$; $\rho = 1000$ kg/m³

Phantom section: Flat Section

Measurement Standard: DASY5 (IEEE/IEC/ANSI C63.19-2011)

DASY52 Configuration:

- Probe: ES3DV3 - SN3205; ConvF(4.24, 4.24, 4.24); Calibrated: 30.12.2013;
- Sensor-Surface: 3mm (Mechanical Surface Detection)
- Electronics: DAE4 Sn601; Calibrated: 18.08.2014
- Phantom: Flat Phantom 5.0 (back); Type: QD000P50AA; Serial: 1002
- DASY52 52.8.8(1222); SEMCAD X 14.6.10(7331)

Dipole Calibration for Body Tissue/Pin=250 mW, d=10mm/Zoom Scan (7x7x7)/Cube 0:

Measurement grid: dx=5mm, dy=5mm, dz=5mm

Reference Value = 96.72 V/m; Power Drift = 0.02 dB

Peak SAR (extrapolated) = 30.9 W/kg

SAR(1 g) = 14.4 W/kg; SAR(10 g) = 6.36 W/kg

Maximum value of SAR (measured) = 19.3 W/kg

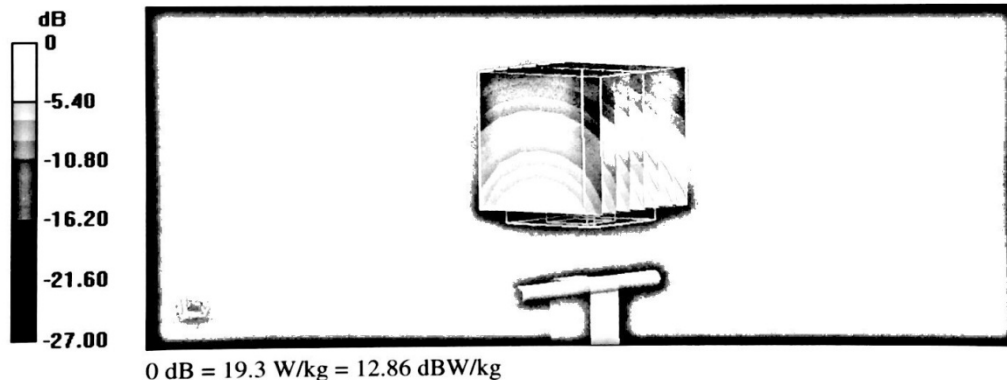



Impedance Measurement Plot for Body TSL

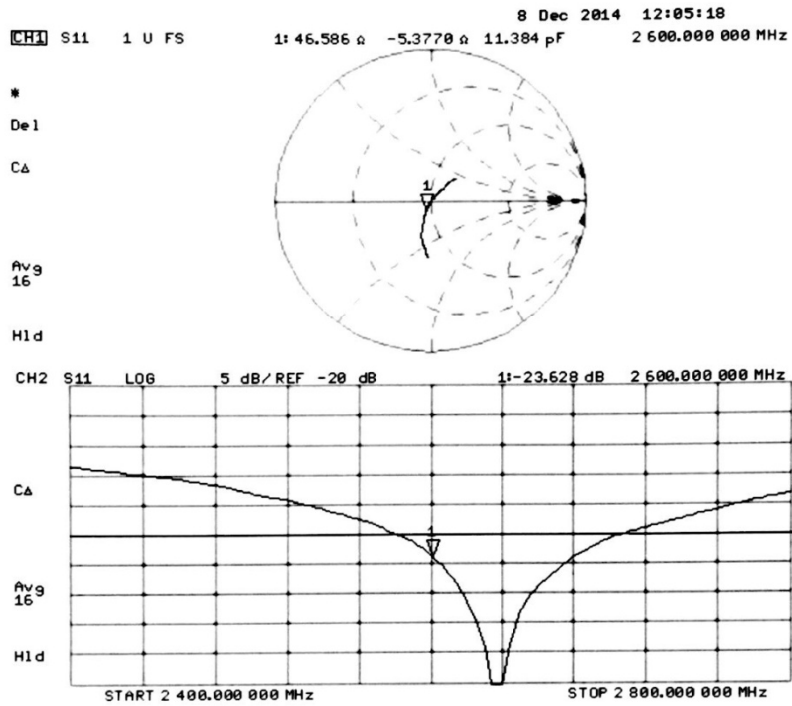



ANNEX I: DAE4 Calibration Certificate



In Collaboration with
s p e a g
CALIBRATION LABORATORY



中国认可
国际互认
校准
CALIBRATION
CNAS L0570

Add: No.51 Xueyuan Road, Haidian District, Beijing, 100191, China
Tel: +86-10-62304633-2218 Fax: +86-10-62304633-2209
E-mail: ctl@chinattl.com [Http://www.chinattl.cn](http://www.chinattl.cn)

Client : **TA(Shanghai)**

Certificate No: **Z17-97011**

CALIBRATION CERTIFICATE

Object: **DAE4 - SN: 1291**

Calibration Procedure(s): **FD-Z11-002-01
Calibration Procedure for the Data Acquisition Electronics (DAEx)**

Calibration date: **January 19, 2017**

This calibration Certificate documents the traceability to national standards, which realize the physical units of measurements(SI). The measurements and the uncertainties with confidence probability are given on the following pages and are part of the certificate.

All calibrations have been conducted in the closed laboratory facility: environment temperature(22±3)°C and humidity<70%.

Calibration Equipment used (M&TE critical for calibration)

Primary Standards	ID #	Cal Date(Calibrated by, Certificate No.)	Scheduled Calibration
Process Calibrator 753	1971018	27-June-16 (CTTL, No:J16X04778)	June-17

	Name	Function	Signature
Calibrated by:	Yu Zongying	SAR Test Engineer	
Reviewed by:	Qi Dianyuan	SAR Project Leader	
Approved by:	Lu Bingsong	Deputy Director of the laboratory	

Issued: January 20, 2017

This calibration certificate shall not be reproduced except in full without written approval of the laboratory.



Add: No.51 Xueyuan Road, Haidian District, Beijing, 100191, China
Tel: +86-10-62304633-2218 Fax: +86-10-62304633-2209
E-mail: cttl@chinattl.com Http://www.chinattl.cn

Glossary:

DAE data acquisition electronics
Connector angle information used in DASY system to align probe sensor X to the robot coordinate system.

Methods Applied and Interpretation of Parameters:

- *DC Voltage Measurement:* Calibration Factor assessed for use in DASY system by comparison with a calibrated instrument traceable to national standards. The figure given corresponds to the full scale range of the voltmeter in the respective range.
- *Connector angle:* The angle of the connector is assessed measuring the angle mechanically by a tool inserted. Uncertainty is not required.
- The report provide only calibration results for DAE, it does not contain other performance test results.

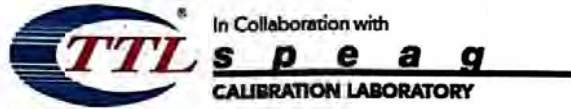

Add: No.51 Xueyuan Road, Haidian District, Beijing, 100191, China
Tel: +86-10-62304633-2218 Fax: +86-10-62304633-2209
E-mail: ttl@chinattl.com Http://www.chinattl.cn

DC Voltage Measurement

A/D - Converter Resolution nominal
High Range: 1LSB = 6.1μV, full range = -100...+300 mV
Low Range: 1LSB = 61nV, full range = -1.....+3mV
DASY measurement parameters: Auto Zero Time: 3 sec; Measuring time: 3 sec

Calibration Factors	X	Y	Z
High Range	402.659 ± 0.15% (k=2)	403.334 ± 0.15% (k=2)	403.248 ± 0.15% (k=2)
Low Range	3.97545 ± 0.7% (k=2)	3.93432 ± 0.7% (k=2)	3.99217 ± 0.7% (k=2)

Connector Angle

Connector Angle to be used in DASY system	309° ± 1 °
---	------------

ANNEX J: The EUT Appearances and Test Configuration



Front Side



Back Side
For Single Screen Mode



Front Side



Back Side

For Double Screen Mode
Picture 11: Constituents of EUT



Picture 12: Left Hand Touch Cheek Position



Picture 13: Left Hand Tilt 15 Degree Position

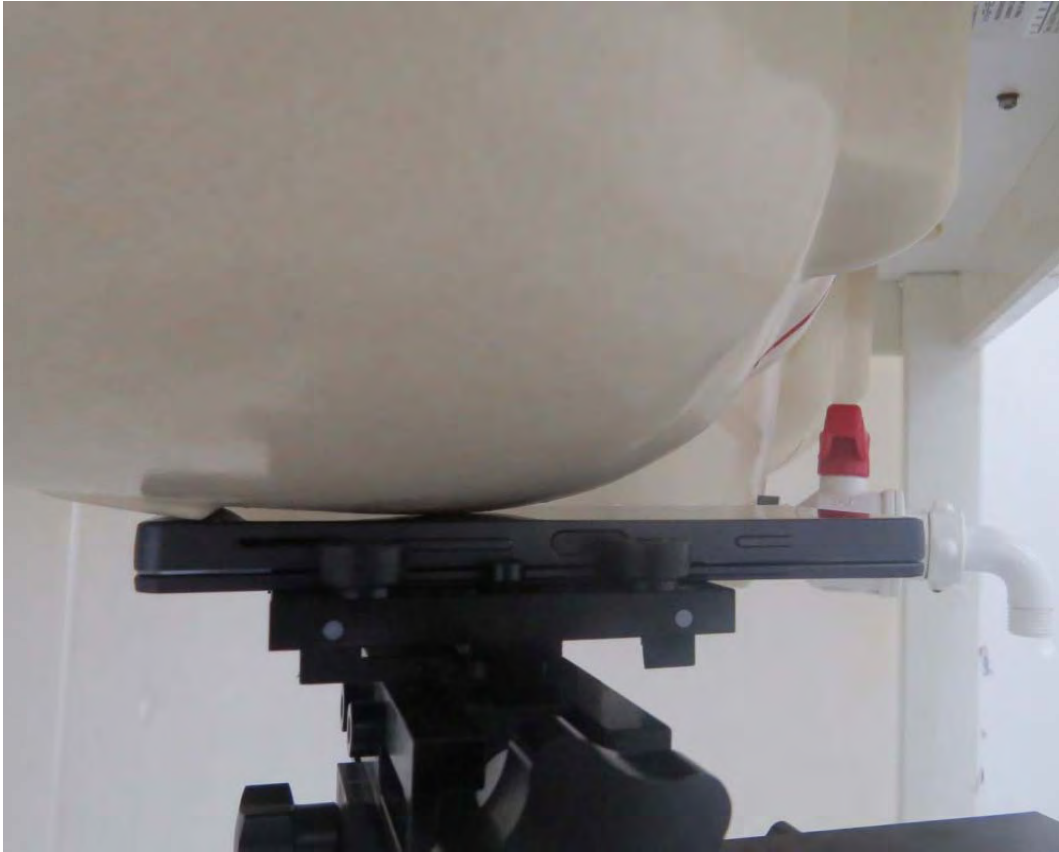

Picture 14: Right Hand Touch Cheek Position



Picture 15: Right Hand Tilt 15 Degree Position



Picture 16: Back Side, the distance from handset to the bottom of the Phantom is 10mm
For Single Screen Mode



Picture 17: Front Side, the distance from handset to the bottom of the Phantom is 10mm
For Single Screen Mode

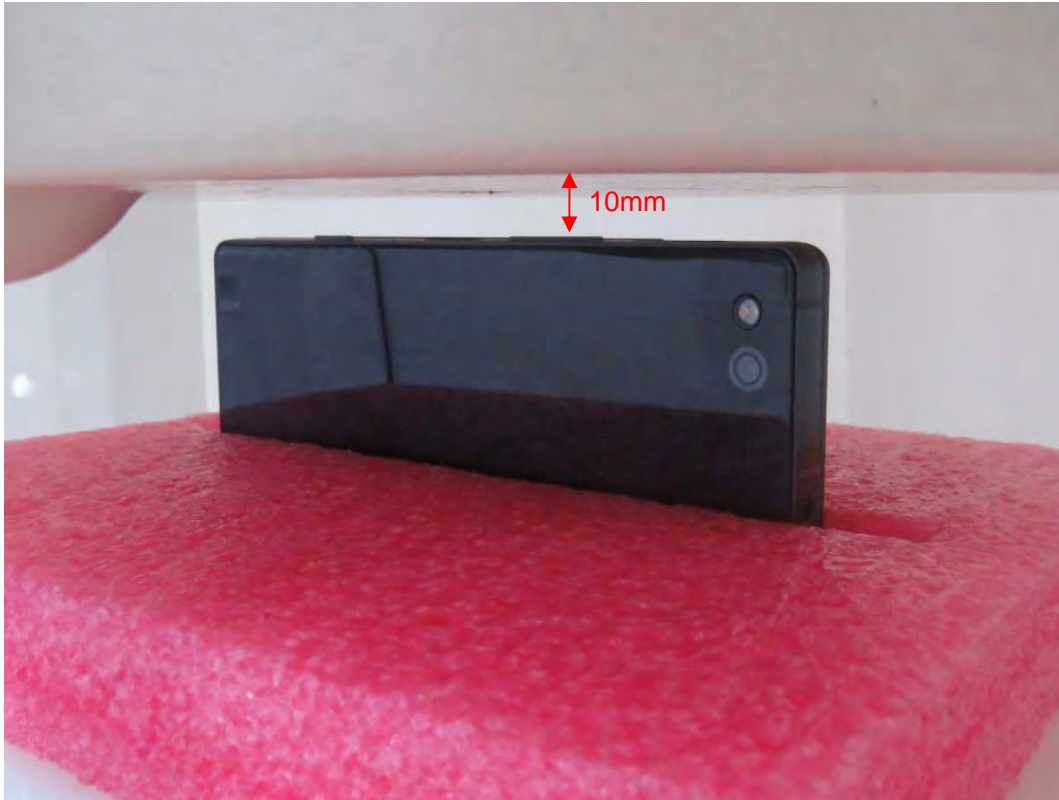

Picture 18: Left Side, the distance from handset to the bottom of the Phantom is 10mm
For Single Screen Mode

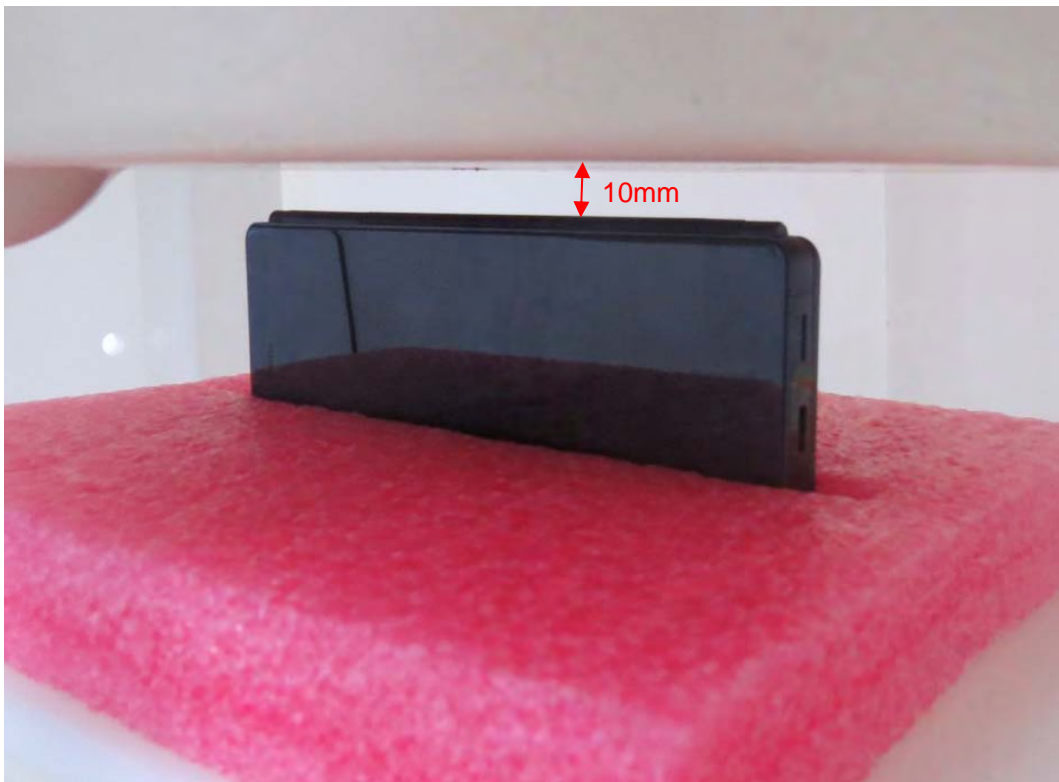

Picture 19: Right Side, the distance from handset to the bottom of the Phantom is 10mm
For Single Screen Mode



Picture 20: Top Side, the distance from handset to the bottom of the Phantom is 10mm
For Single Screen Mode



Picture 21: Bottom Side, the distance from handset to the bottom of the Phantom is 10mm
For Single Screen Mode

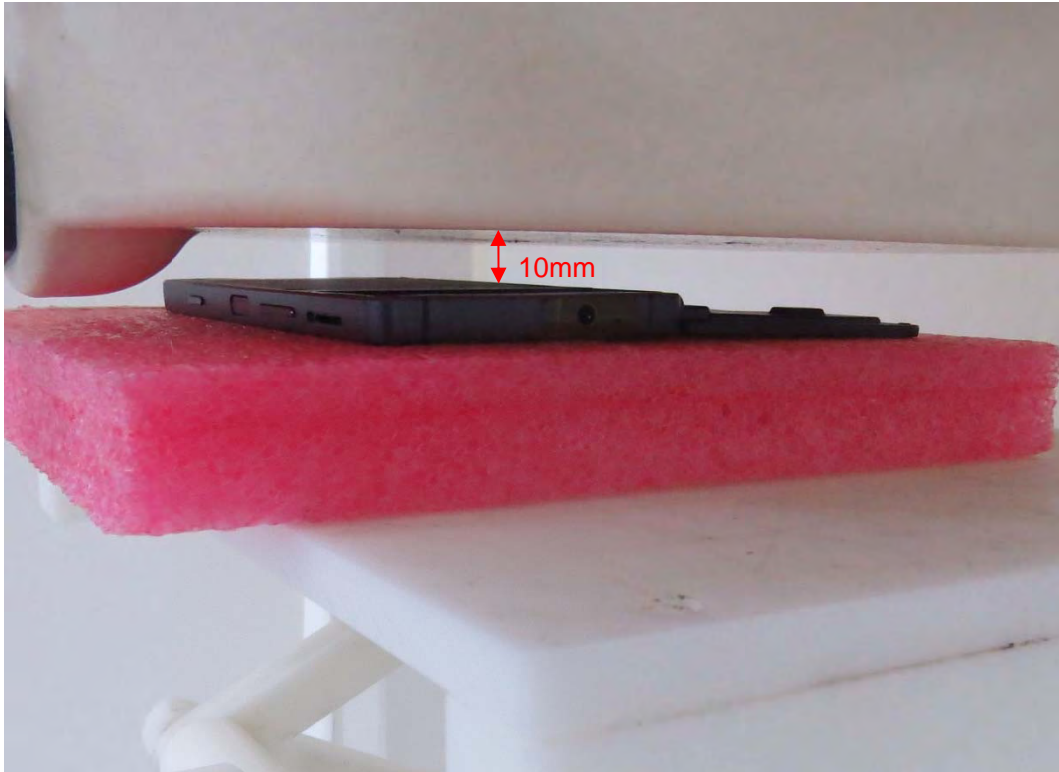

Picture 22: Back Side, the distance from handset to the bottom of the Phantom is 10mm
For Double Screen Mode



Picture 23: Front Side, the distance from handset to the bottom of the Phantom is 10mm
For Double Screen Mode



Picture 24: Left Side, the distance from handset to the bottom of the Phantom is 10mm
For Double Screen Mode



Picture 25: Right Side, the distance from handset to the bottom of the Phantom is 10mm
For Double Screen Mode



Picture 26: Top Side, the distance from handset to the bottom of the Phantom is 10mm
For Double Screen Mode



Picture 27: Bottom Side, the distance from handset to the bottom of the Phantom is 10mm
For Double Screen Mode



Picture 28: Back Side, the distance from handset to the bottom of the Phantom is 0mm
For Single Screen Mode



Picture 29: Front Side, the distance from handset to the bottom of the Phantom is 0mm
For Single Screen Mode

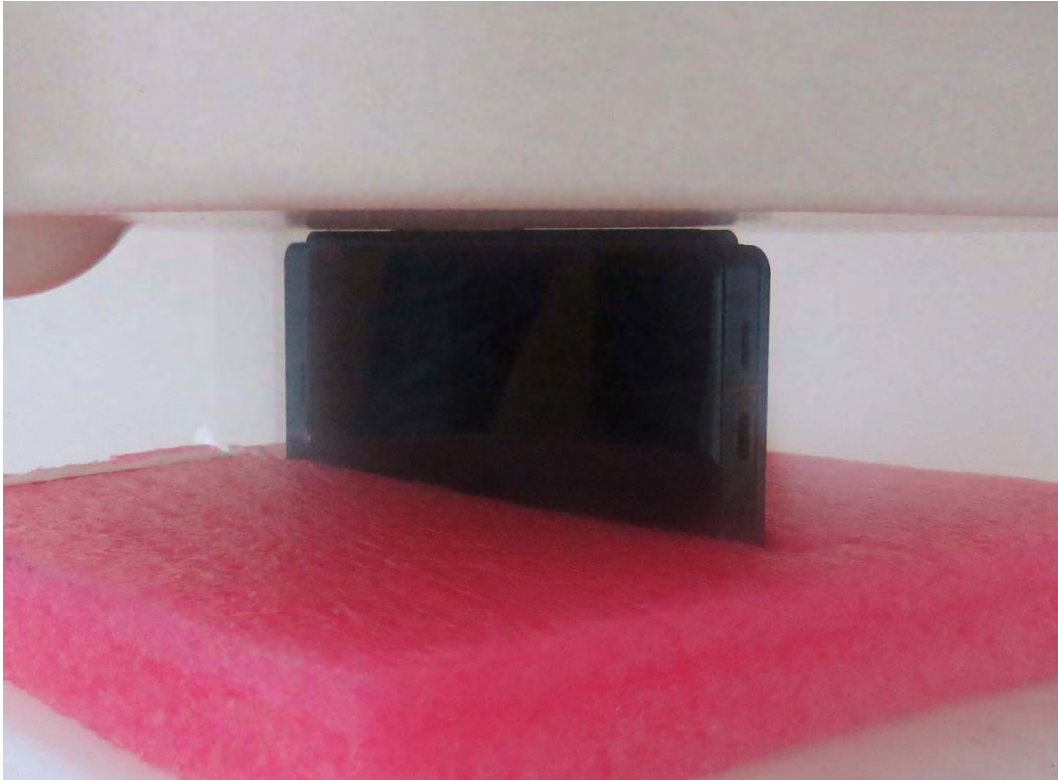

Picture 30: Right Side, the distance from handset to the bottom of the Phantom is 0mm
For Single Screen Mode

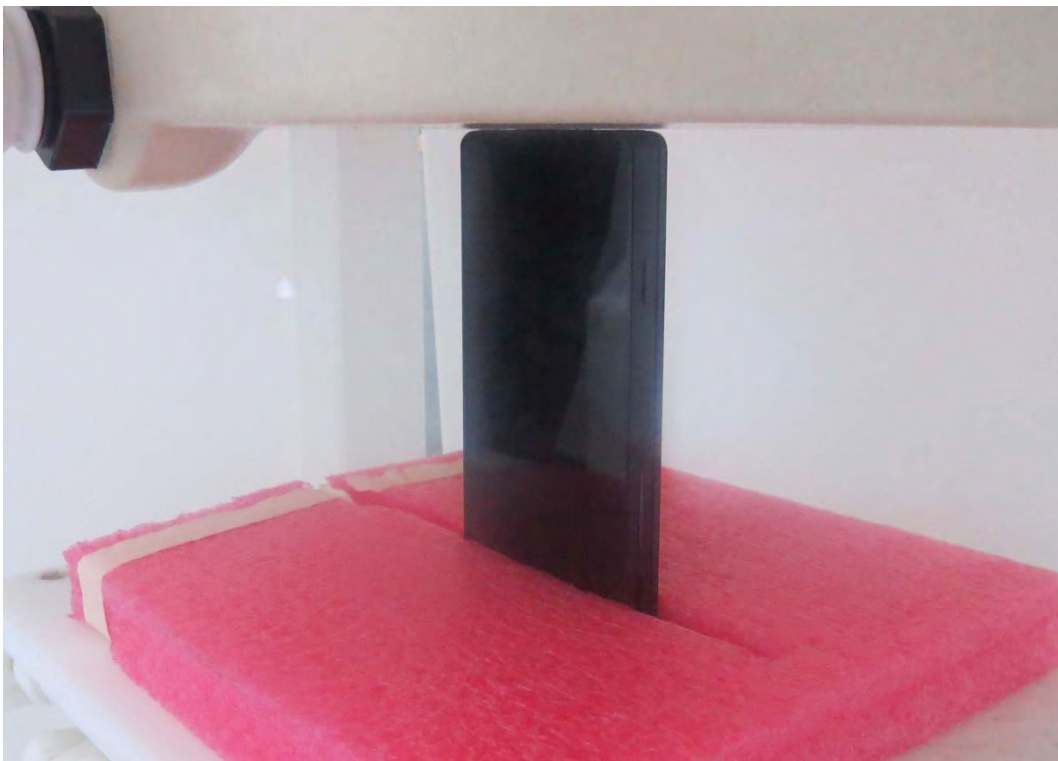

Picture 31: Top Side, the distance from handset to the bottom of the Phantom is 0mm
For Single Screen Mode

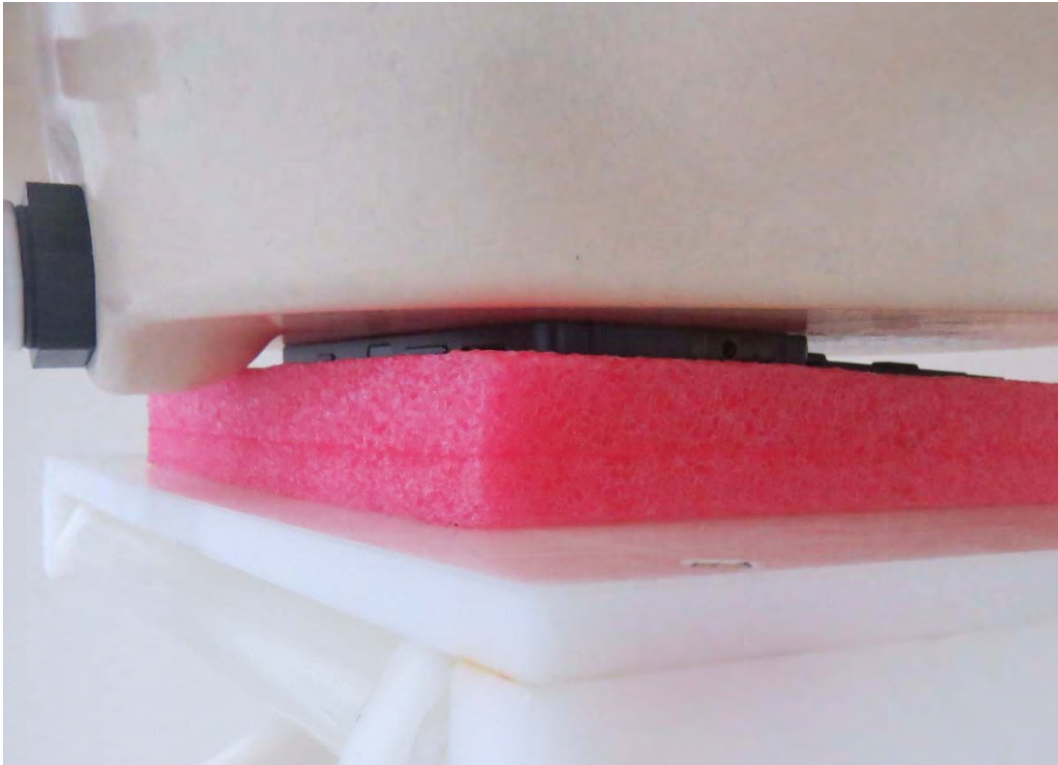

Picture 32: Back Side, the distance from handset to the bottom of the Phantom is 0mm
For Double Screen Mode

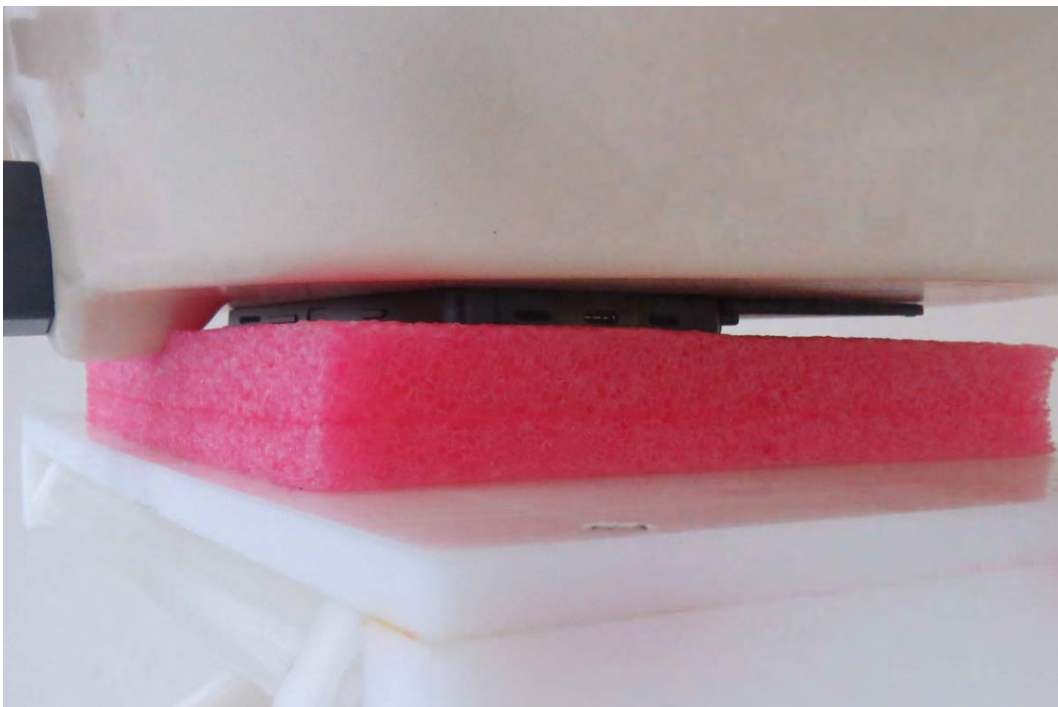

Picture 33: Front Side, the distance from handset to the bottom of the Phantom is 0mm
For Double Screen Mode



Picture 34: Top Side, the distance from handset to the bottom of the Phantom is 0mm
For Double Screen Mode



Picture 35: Bottom Side, the distance from handset to the bottom of the Phantom is 0mm
For Double Screen Mode