



RF TEST REPORT

Applicant ZTE Corporation
FCC ID SRQ-ZTEZ999
Product LTE/WCDMA/GSM Multi-Mode Digital Mobile Phone
Marketing ZTE Axon M / ZTE AXON M / Axon M / AXON M
Model Z999
Report No. RXA1711-0362RF04
Issue Date December 1, 2017

TA Technology (Shanghai) Co., Ltd. tested the above equipment in accordance with the requirements in **FCC CFR47 Part 15C (2017)**. The test results show that the equipment tested is capable of demonstrating compliance with the requirements as documented in this report.

Performed by: Xianqing Li

Approved by: Kai Xu

TA Technology (Shanghai) Co., Ltd.

No.145, Jintang Rd, Tangzhen Industry Park, Pudong Shanghai, China

TEL: +86-021-50791141/2/3

FAX: +86-021-50791141/2/3-8000



TABLE OF CONTENT

1. Test Laboratory	4
1.1. Notes of the test report	4
1.2. Test facility	4
1.3. Testing Location	5
2. General Description of Equipment under Test	6
3. Applied Standards	7
4. Test Configuration	8
5. Test Case Results	9
5.1. Average Power Output –Conducted	9
5.2. 6dB Bandwidth	12
5.3. Band Edge	17
5.4. Power Spectral Density	20
5.5. Spurious RF Conducted Emissions	25
5.6. Radiated Emissions in the Restricted Band	32
5.7. Radiates Emission	37
5.8. Conducted Emission	71
6. Main Test Instruments	73
ANNEX A: EUT Appearance and Test Setup	74
A.1 EUT Appearance	74
A.2 Test Setup	76



Summary of measurement results

Number	Summary of measurements of results	Clause in FCC rules	Verdict
1	Maximum Average conducted output power	15.247(b)(3)	PASS
2	6 dB bandwidth	15.247(a)(2)	PASS
3	Power spectral density	15.247(e)	PASS
4	Band Edge	15.247(d)	PASS
5	Spurious RF Conducted Emissions	15.247(d)	PASS
6	Radiated Emissions in restricted frequency bands	15.247(d),15.205,15.209	PASS
7	Radiated Emissions	15.247(d),15.205,15.209	PASS
8	Conducted Emissions	15.207	PASS
Date of Testing: November 9, 2017 ~ November 24, 2017			

1. Test Laboratory

1.1. Notes of the test report

This report shall not be reproduced in full or partial, without the written approval of **TA technology (shanghai) co., Ltd.** The results documented in this report apply only to the tested sample, under the conditions and modes of operation as described herein. Measurement Uncertainties were not taken into account and are published for informational purposes only. This report is written to support regulatory compliance of the applicable standards stated above. This report must not be used by the client to claim product certification, approval, or endorsement by any government agencies.

1.2. Test facility

CNAS (accreditation number: L2264)

TA Technology (Shanghai) Co., Ltd. has obtained the accreditation of China National Accreditation Service for Conformity Assessment (CNAS).

FCC (Designation number: CN1179, Test Firm Registration Number: 446626)

TA Technology (Shanghai) Co., Ltd. has been listed on the US Federal Communications Commission list of test facilities recognized to perform electromagnetic emissions measurements.

IC (recognition number is 8510A)

TA Technology (Shanghai) Co., Ltd. has been listed by industry Canada to perform electromagnetic emission measurement.

VCCI (recognition number is C-4595, T-2154, R-4113, G-10766)

TA Technology (Shanghai) Co., Ltd. has been listed by industry Japan to perform electromagnetic emission measurement.

A2LA (Certificate Number: 3857.01)

TA Technology (Shanghai) Co., Ltd. has been listed by American Association for Laboratory Accreditation to perform electromagnetic emission measurement.



1.3. Testing Location

Company: TA Technology (Shanghai) Co., Ltd.
Address: No.145, Jintang Rd, Tangzhen Industry Park, Pudong
City: Shanghai
Post code: 201201
Country: P. R. China
Contact: Xu Kai
Telephone: +86-021-50791141/2/3
Fax: +86-021-50791141/2/3-8000
Website: <http://www.ta-shanghai.com>
E-mail: xukai@ta-shanghai.com

2. General Description of Equipment under Test

Client Information

Applicant	ZTE Corporation
Applicant address	ZTE Plaza, Keji Road South, Hi-Tech, Industrial Park, Nanshan District, Shenzhen, Guangdong, 518057, P.R.China
Manufacturer	ZTE Corporation
Manufacturer address	ZTE Plaza, Keji Road South, Hi-Tech, Industrial Park, Nanshan District, Shenzhen, Guangdong, 518057, P.R.China

General information

EUT Description	
Model	Z999
IMEI	86673303000429
Hardware Version	ZTE AXON M MP
Software Version	AXONMB01-DE_ACC01a
Power Supply	Battery/AC adapter
Antenna Type	Internal Antenna
Antenna Gain	-2.88 dBi for 2412MHz -3.02 dBi for 2437MHz -3.02 dBi for 2452MHz -3.02 dBi for 2462MHz
additional beamforming gain	0 dB
Test Mode	Bluetooth(Low Energy) 802.11b 802.11g, 802.11n(HT20/HT40);
Modulation Type	BLE :GFSK 802.11b: DSSS; 802.11g/n(HT20/HT40): OFDM
Max. Conducted Power	Wi-Fi 2.4G :16.00dBm BLE : 2.17dBm
Operating Frequency Range(s)	802.11b/g/n(HT20): 2412 ~ 2462 MHz 802.11n(HT40): 2422 ~ 2452 MHz BLE: 2402 ~2480 MHz
EUT Accessory	
Battery	Manufacturer: SCUD (Fujian) Electronics Co., Ltd. Model: Li3931T44P8h686049
Earphone	Manufacturer: KINGSTATE ELECTRONICS CORP. Model: KJAG4020AWKCB-2
Note: The information of the EUT is declared by the manufacturer.	



3. Applied Standards

According to the specifications of the manufacturer, it must comply with the requirements of the following standards:

Test standards

- **FCC CFR47 Part 15C (2017) Radio Frequency Devices**
- **ANSI C63.10 (2013)**
- **KDB 558074 D01 DTS Meas Guidance v04**

4. Test Configuration

Test Mode

The EUT has been associated with peripherals and configuration operated in a manner tended to maximize its emission characteristics in a typical application.

The radiated emission was measured in the following position: EUT stand-up position (Z axis), lie-down position (X, Y axis). The worst emission was found in lie-down position (X axis) and the worst case was recorded.

In order to find the worst case condition, Pre-tests are needed at the presence of different data rate. Preliminary tests have been done on all the configuration for confirming worst case. Data rate below means worst-case rate of each test item.

The test software is used QRCT

Worst-case data rates are shown as following table.

Band	Data Rate
Bluetooth(Low Energy)	1Mbps
802.11b	1 Mbps
802.11g	6 Mbps
802.11n HT20	MCS0
802.11n HT40	MCS0

5. Test Case Results

5.1. Average Power Output –Conducted

Ambient condition

Temperature	Relative humidity	Pressure
23°C ~25°C	45%~50%	101.5kPa

Methods of Measurement

During the process of the testing, The EUT was connected to Power meter with a known loss. The EUT is max power transmission with proper modulation. The Average detector is used. We use Maximum Average Conducted Output Power Level Method in KDB 558074 D01/KDB662911 D01 for this test.

Test Setup

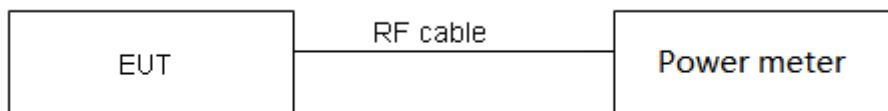

Limits

Rule Part 15.247 (b) (3) specifies that " For systems using digital modulation in the 902–928 MHz, 2400–2483.5 MHz: 1 Watt."

Average Output Power	$\leq 1W$ (30dBm)
----------------------	-------------------

Measurement Uncertainty

The assessed measurement uncertainty to ensure 95% confidence level for the normal distribution is with the coverage factor $k = 2$, $U = 0.44$ dB.

Test Results

Single Antenna Power Index			
Packet Type	CH1	CH6	CH11
802.11b	16	16	16
802.11g	14	14	14
802.11n HT20	13	13	13
Packet Type	CH3	CH6	CH9
802.11n HT40	13	13	13

Band	T _{on} (ms)	T _(on+off) (ms)	Duty cycle	Duty cycle correction Factor(dB)
802.11b	12.40	12.55	0.00	NA
802.11g	2.07	2.18	0.95	0.22
802.11n HT20	0.95	1.06	0.89	0.49
802.11n HT40	1.92	2.04	0.94	0.26
BLE	0.41	0.63	0.646	1.894

Note: when Duty cycle>0.98, Duty cycle correction Factor not required.



Network Standards	Carrier frequency (MHz)	Read Value (dBm)	Average Output Power(dBm)	Limit (dBm)	Conclusion
802.11b	2412	15.85	15.85	30	PASS
	2437	15.10	15.10	30	PASS
	2462	16.00	16.00	30	PASS
802.11g	2412	13.10	13.32	30	PASS
	2437	13.15	13.37	30	PASS
	2462	13.06	13.28	30	PASS
802.11n HT20	2412	11.95	12.44	30	PASS
	2437	11.71	12.20	30	PASS
	2462	11.81	12.30	30	PASS
802.11n HT40	2422	12.20	12.46	30	PASS
	2437	11.87	12.13	30	PASS
	2452	10.71	10.97	30	PASS
Bluetooth (Low Energy)	2402	-0.81	1.08	30	PASS
	2440	0.28	2.17	30	PASS
	2480	-0.85	1.04	30	PASS
Note:Output Power=Read Value+Duty cycle correction factor					

5.2. 6dB Bandwidth

Ambient condition

Temperature	Relative humidity	Pressure
23°C ~25°C	45%~50%	101.5kPa

Method of Measurement

The EUT was connected to the spectrum analyzer through an external attenuator (20dB) and a known loss cable. RBW is set to 100 kHz; VBW is set to 300 kHz on spectrum analyzer.

Test Setup

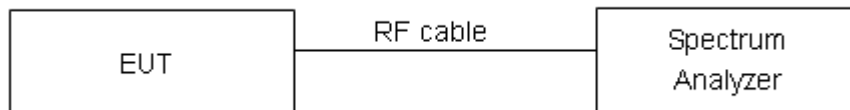

Limits

Rule Part 15.247 (a) (2) specifies that “Systems using digital modulation techniques may operate in the 902–928 MHz, 2400–2483.5 MHz bands. The minimum 6 dB bandwidth shall be at least 500 kHz.”

minimum 6 dB bandwidth	≥ 500 kHz
------------------------	-----------

Measurement Uncertainty

The assessed measurement uncertainty to ensure 95% confidence level for the normal distribution is with the coverage factor $k = 2$, $U = 936$ Hz.

Test Results:

Network Standards	Carrier frequency (MHz)	99% bandwidth (MHz)	Minimum 6 dB bandwidth (MHz)	Limit (kHz)	Conclusion
802.11b	2412	12.799	7.615	500	PASS
	2437	12.959	8.079	500	PASS
	2462	13.004	7.135	500	PASS
802.11g	2412	16.366	15.500	500	PASS
	2437	16.361	15.930	500	PASS
	2462	16.359	16.120	500	PASS
802.11n HT20	2412	17.548	17.180	500	PASS
	2437	17.549	16.050	500	PASS
	2462	17.577	17.630	500	PASS
802.11n HT40	2422	36.102	35.210	500	PASS
	2437	35.950	35.160	500	PASS
	2452	35.869	35.210	500	PASS
Bluetooth (Low Energy)	2402	1.0863	0.6694	500	PASS
	2440	1.0840	0.6685	500	PASS
	2480	1.0898	0.6663	500	PASS

802.11b, Carrier frequency (MHz): 2412



802.11g, Carrier frequency (MHz): 2412



802.11b, Carrier frequency (MHz): 2437



802.11g, Carrier frequency (MHz): 2437



802.11b, Carrier frequency (MHz): 2462



802.11g, Carrier frequency (MHz): 2462





802.11n(HT20), Carrier frequency (MHz): 2412

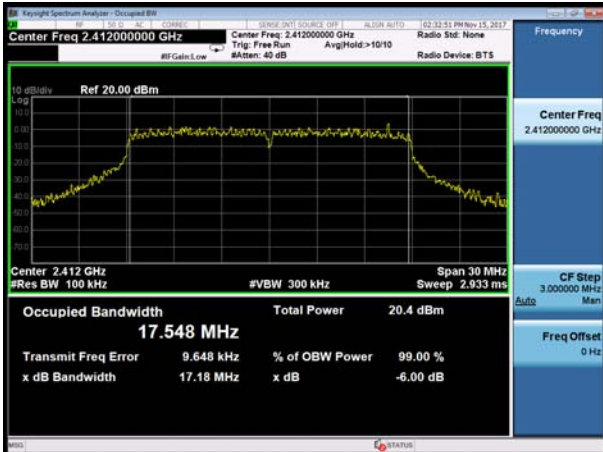

802.11n(HT40), Carrier frequency (MHz): 2422

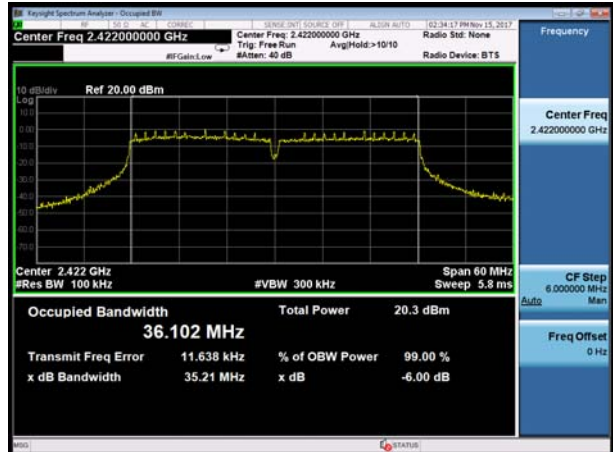

802.11n(HT20), Carrier frequency (MHz): 2437

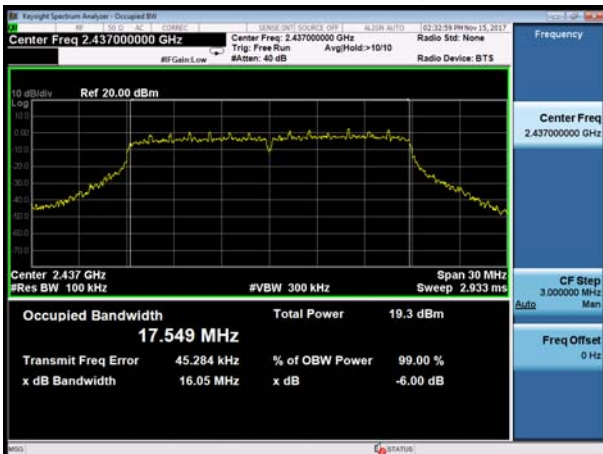

802.11n(HT40), Carrier frequency (MHz): 2437



802.11n(HT20), Carrier frequency (MHz):2462



802.11n(HT40), Carrier frequency (MHz):2452



BLE Carrier frequency (MHz): 2402



BLE Carrier frequency (MHz): 2440



BLE Carrier frequency (MHz): 2480



5.3. Band Edge

Ambient condition

Temperature	Relative humidity	Pressure
23°C ~25°C	45%~50%	101.5kPa

Method of Measurement

The EUT was connected to the spectrum analyzer through an external attenuator (20dB) and a known loss cable the band edge of the lowest and highest channels were measured. The peak detector is used and RBW is set to 100 kHz and VBW is set to 300 kHz on spectrum analyzer. Spectrum analyzer plots are included on the following pages.

Test Setup

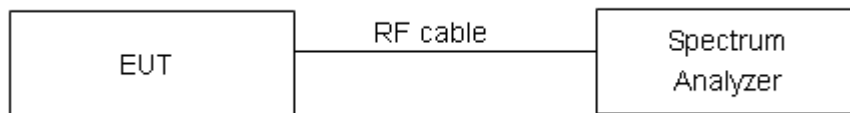

Limits

Rule Part 15.247(d) specifies that “In any 100 kHz bandwidth outside the frequency band in which the spread spectrum or digitally modulated intentional radiator is operating, the radio frequency power that is produced by the intentional radiator shall be at least 20 dB below that in the 100 kHz bandwidth within the band that contains the highest level of the desired power, based on either an RF conducted or a radiated measurement, provided the transmitter demonstrates compliance with the peak conducted power limits.”

Measurement Uncertainty

The assessed measurement uncertainty to ensure 95% confidence level for the normal distribution is with the coverage factor $k = 1.96$.

Frequency	Uncertainty
2GHz-3GHz	1.407 dB



Test Results: PASS

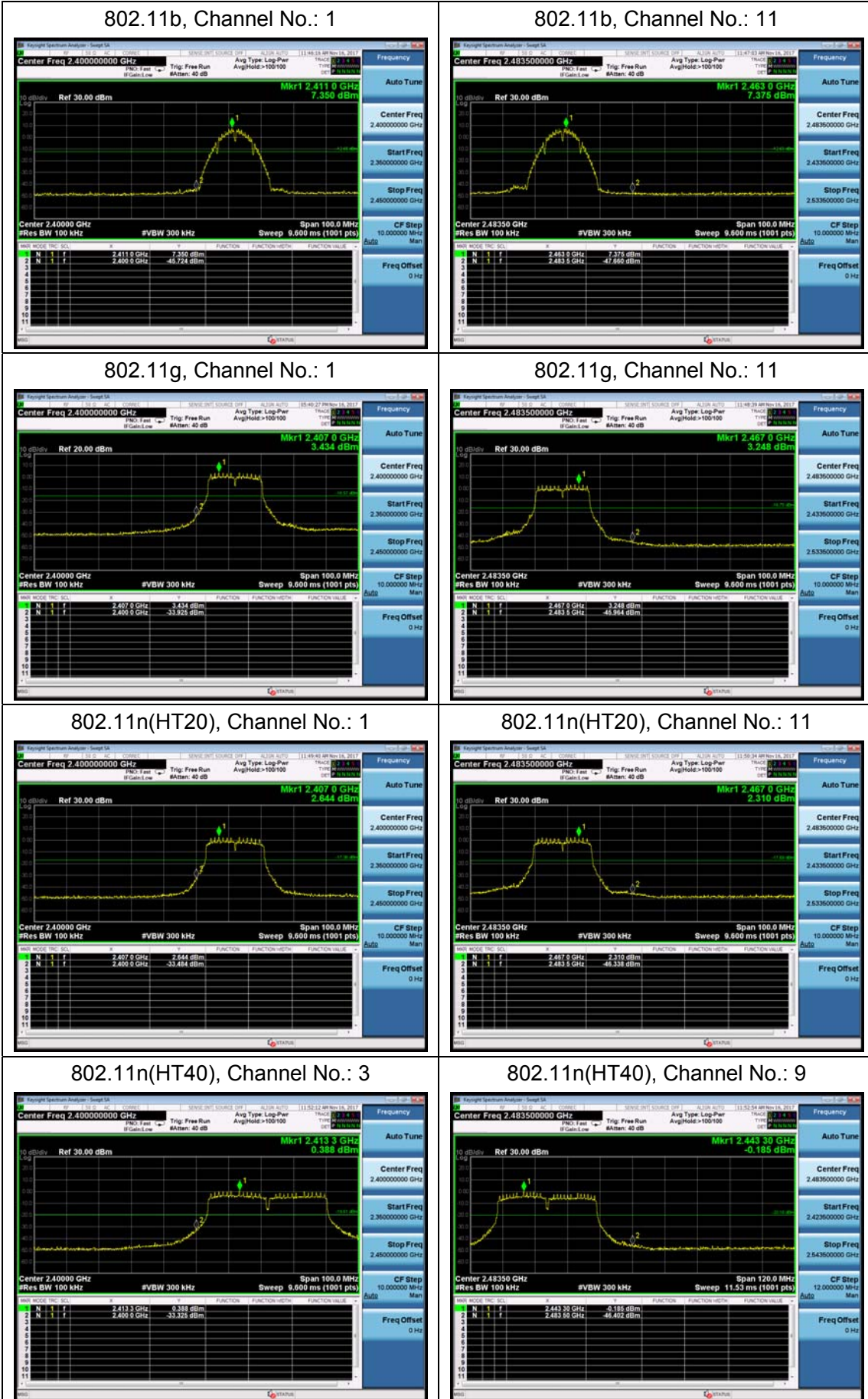

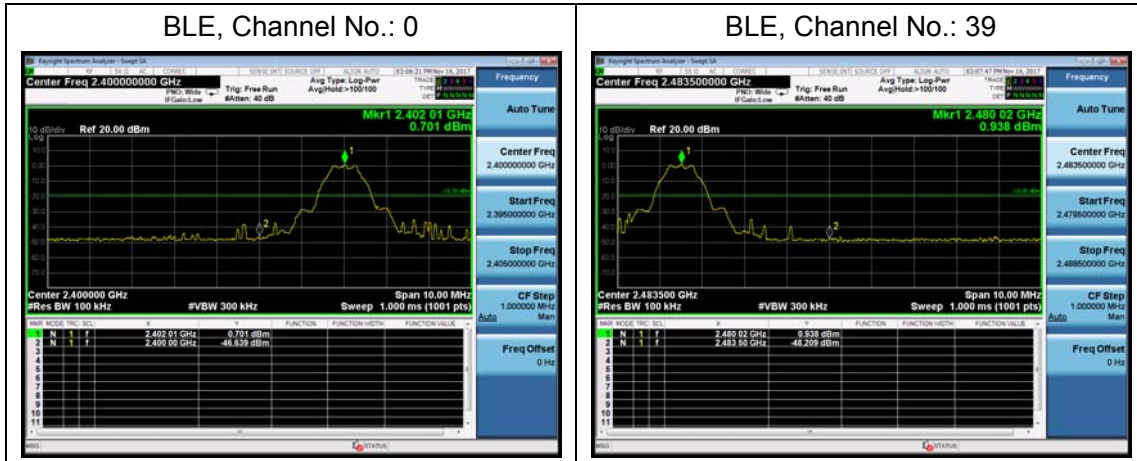

5.4. Power Spectral Density

Ambient condition

Temperature	Relative humidity	Pressure
23°C ~25°C	45%~50%	101.5kPa

Method of Measurement

The EUT was connected to the spectrum analyzer through an external attenuator (20dB) and a known loss cable.

RBW is set to 3 kHz and VBW is set to 10 kHz for BLE/ Wi-Fi 2.4G on spectrum analyzer.

Set the span to 1.5 times the DTS channel bandwidth. Sweep time = auto couple. Trace mode = max hold. The Average power spectral density is recorded.

Test setup

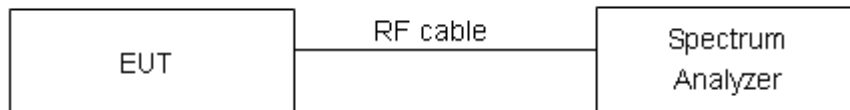

Limits

Rule Part 15.247(e) specifies that” For digitally modulated systems, the power spectral density conducted from the intentional radiator to the antenna shall not be greater than 8 dBm in any 3 kHz band during any time interval of continuous transmission. ”

Limits	≤ 8 dBm / 3kHz
--------	----------------

Measurement Uncertainty

The assessed measurement uncertainty to ensure 95% confidence level for the normal distribution is with the coverage factor $k = 2$, $U = 0.75\text{dB}$.

**Test Results:**

Network Standards	Channel Number	Read Value (dBm)	Power Spectral Density (dBm / 3kHz)	Limit (dBm / 3kHz)	Conclusion
802.11b	1	-17.58	-17.58	8	PASS
	6	-16.87	-16.87	8	PASS
	11	-17.06	-17.06	8	PASS
802.11g	1	-21.07	-20.84	8	PASS
	6	-20.72	-20.49	8	PASS
	11	-21.30	-21.07	8	PASS
802.11n HT20	1	-22.33	-21.84	8	PASS
	6	-21.89	-21.40	8	PASS
	11	-22.45	-21.96	8	PASS
802.11n HT40	3	-24.52	-24.25	8	PASS
	6	-24.31	-24.05	8	PASS
	9	-25.47	-25.21	8	PASS
Bluetooth (Low Energy)	0	-20.13	-18.23	8	PASS
	19	-18.36	-16.47	8	PASS
	39	-19.34	-17.44	8	PASS

Note: Power Spectral Density =Read Value+Duty cycle correction factor

802.11b, Channel No.: 1



802.11g, Channel No.: 1

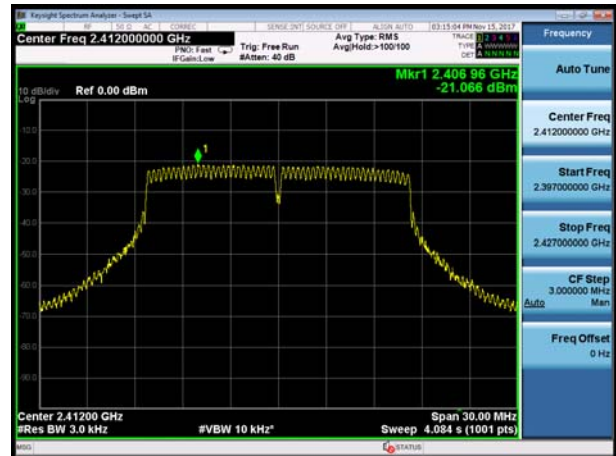

802.11b, Channel No.: 6



802.11g, Channel No.: 6

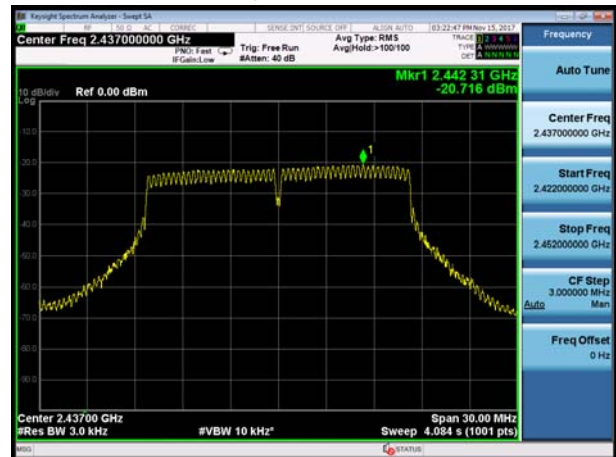

802.11b, Channel No.: 11



802.11g, Channel No.: 11



802.11n(HT20), Channel No. 1

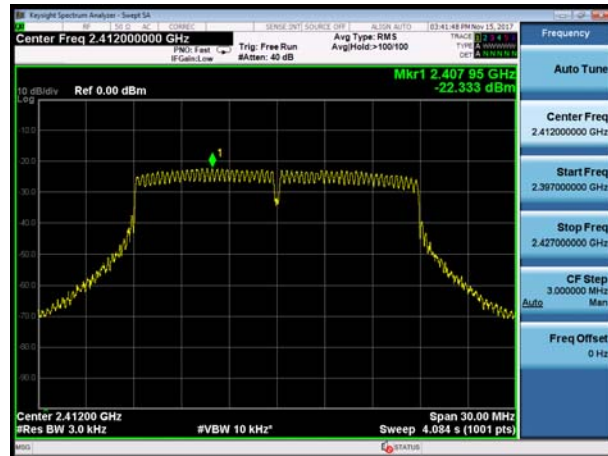

802.11n(HT40), Channel No. 3



802.11n(HT20), Channel No. 6



802.11n(HT40), Channel No. 6



802.11n(HT20), Channel No. 11

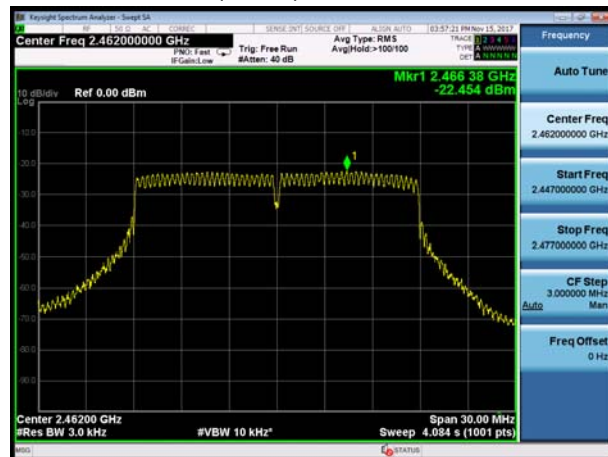

802.11n(HT40), Channel No. 9





BLE, Channel No.: 0



BLE, Channel No.: 19

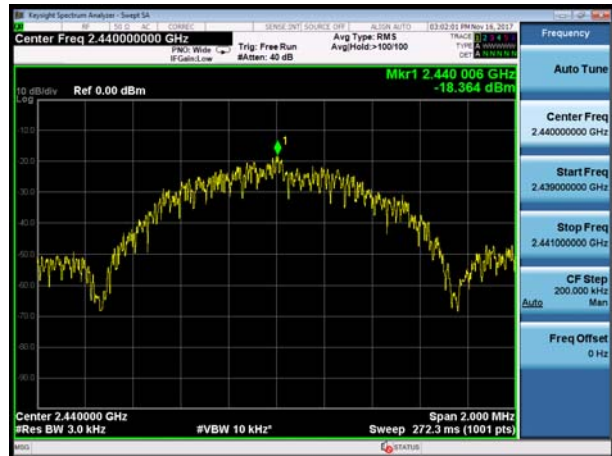

BLE, Channel No.: 39



5.5. Spurious RF Conducted Emissions

Ambient condition

Temperature	Relative humidity	Pressure
23°C ~25°C	45%~50%	101.5kPa

Method of Measurement

The EUT was connected to the spectrum analyzer with a known loss. The spectrum analyzer scans from 30MHz to the 10th harmonic of the carrier. The peak detector is used. Set RBW to100kHz and VBW to 300 kHz, Sweep is set to ATUO.

The test is in transmitting mode.

Test setup



Limits

Rule Part 15.247(d) pacifies that “In any 100 kHz bandwidth outside the frequency band in which the spread spectrum intentional radiator is operating, the radio frequency power that is produced by the intentional radiator shall be at least 20 dB below that in the 100 kHz bandwidth within the band that contains the highest level of the desired power.”

Network Standards	Carrier frequency (MHz)	Reference value (dBm)	Limit
802.11b	2412	9.815	-10.185
	2437	9.970	-10.03
	2462	9.476	-10.524
802.11g	2412	8.567	-11.433
	2437	8.833	-11.167
	2462	8.353	-11.647
802.11n HT20	2412	8.064	-11.936
	2437	8.303	-11.697
	2462	8.317	-11.683
802.11n HT40	2422	6.194	-13.806
	2437	6.278	-13.722
	2452	5.314	-14.686
Bluetooth (Low Energy)	2402	-3.012	-23.012
	2440	-0.996	-20.996
	2480	-1.321	-21.321

**Measurement Uncertainty**

The assessed measurement uncertainty to ensure 95% confidence level for the normal distribution is with the coverage factor $k = 1.96$.

Frequency	Uncertainty
100kHz-2GHz	0.684 dB
2GHz-26GHz	1.407 dB



Test Result:

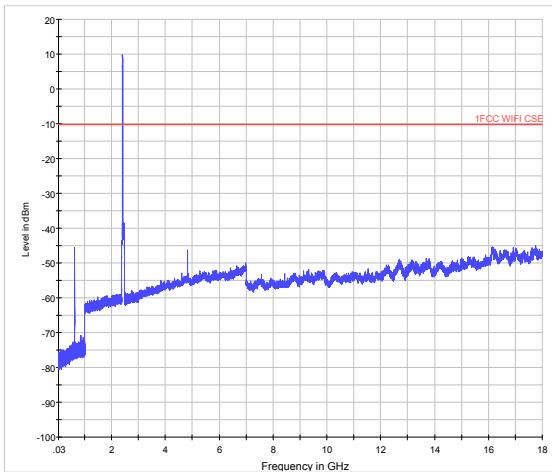

802.11b CH1 30MHz to 18GHz

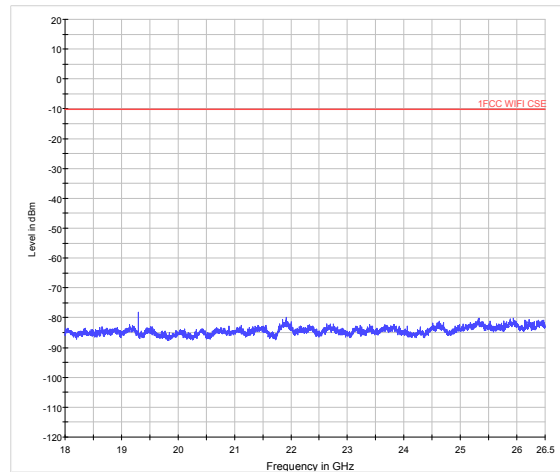

802.11b CH1 18GHz to 26.5GHz

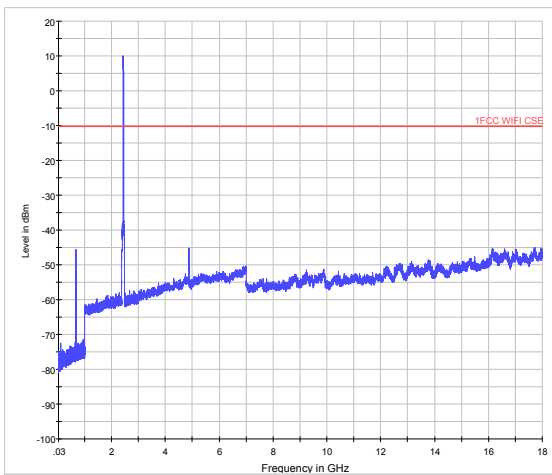

802.11b CH6 30MHz to 18GHz

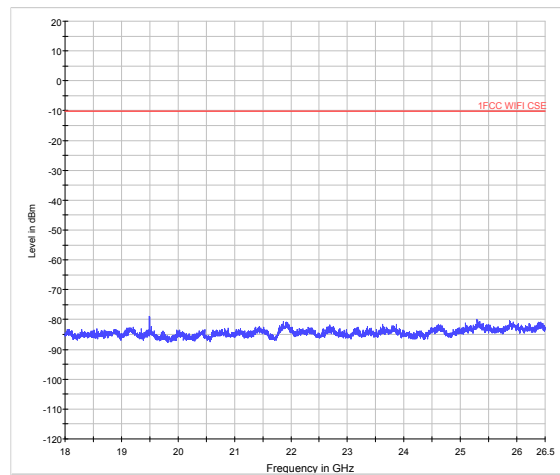

802.11b CH6 18GHz to 26.5GHz

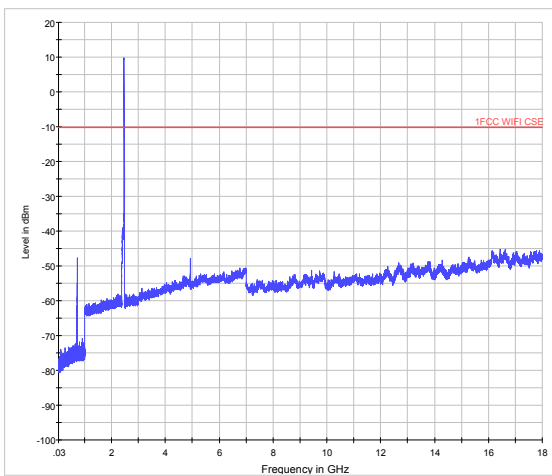

802.11b CH11 30MHz to 18GHz

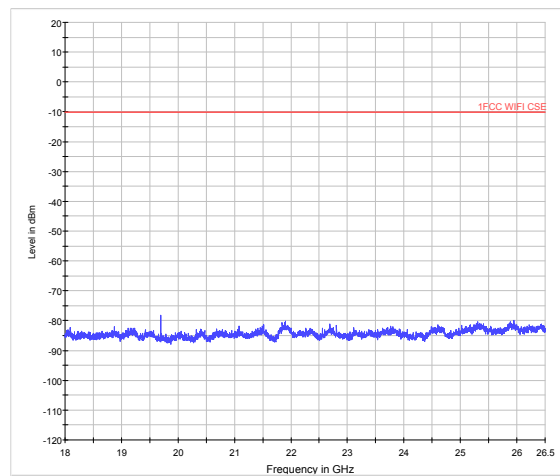

802.11b CH11 18GHz to 26.5GHz

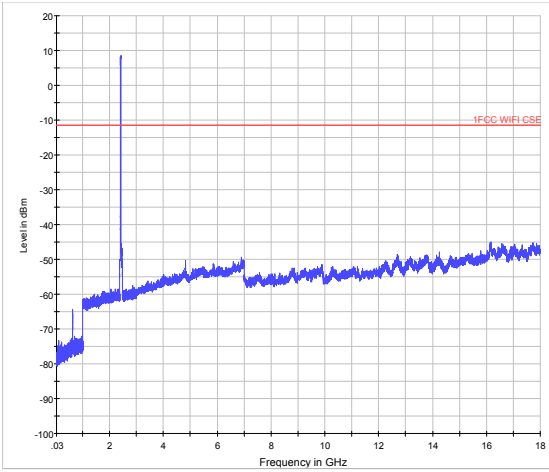

802.11g CH1 30MHz to 18GHz

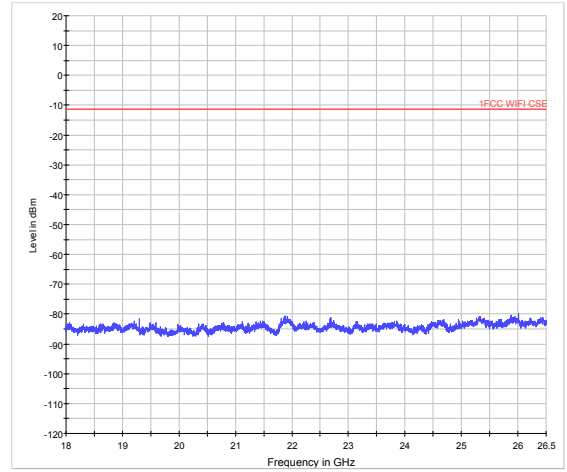

802.11g CH1 18GHz to 26.5GHz

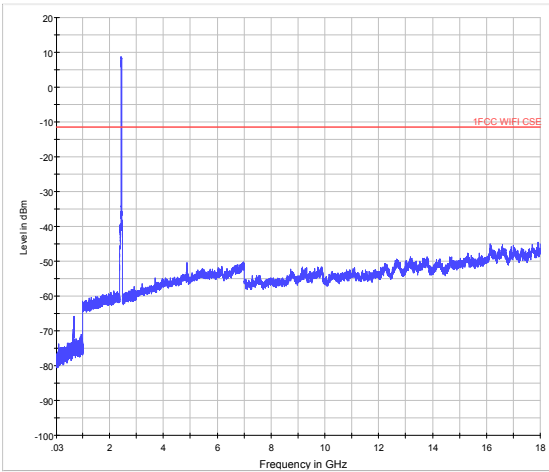

802.11g CH6 30MHz to 18GHz

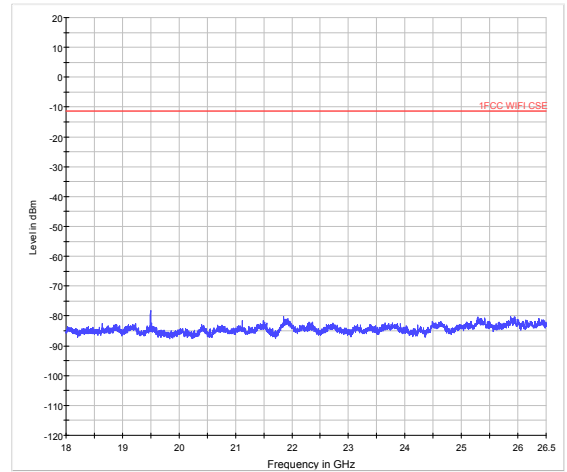

802.11g CH6 18GHz to 26.5GHz

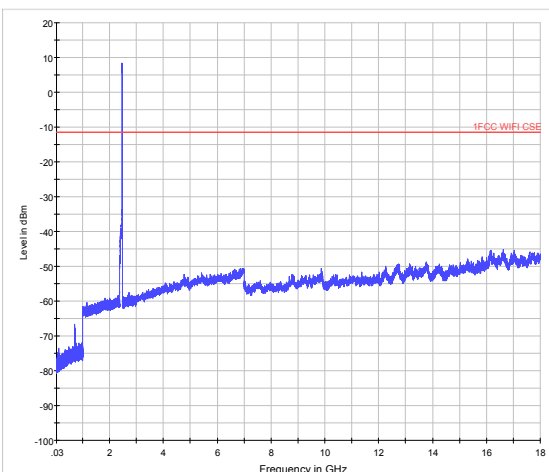

802.11g CH11 30MHz to 18GHz

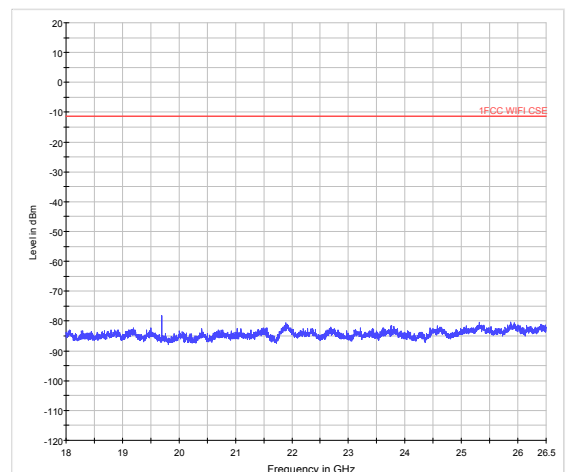

802.11g CH11 18GHz to 26.5GHz

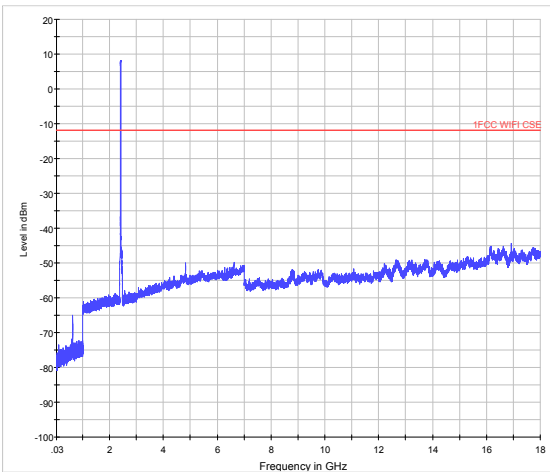

802.11n (HT20) CH1 30MHz to 18GHz

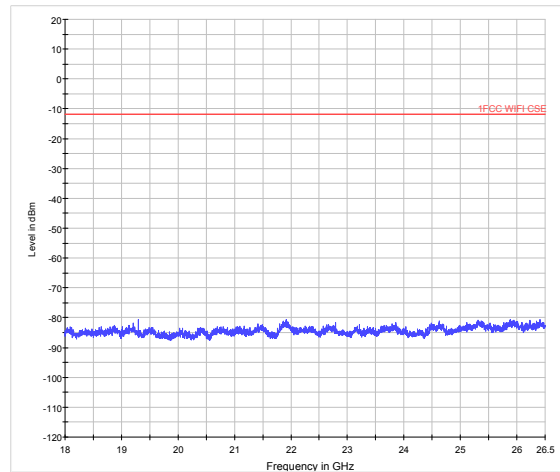

802.11n (HT20) CH1 18GHz to 26.5GHz

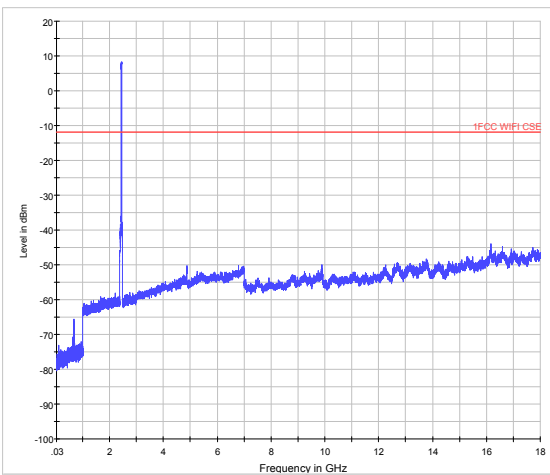

802.11n (HT20) CH6 30MHz to 18GHz

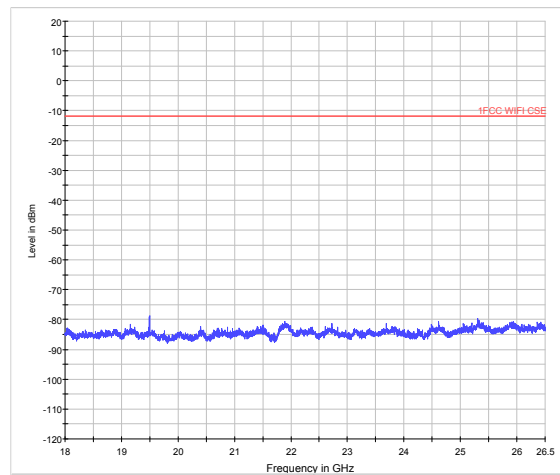

802.11n (HT20) CH6 18GHz to 26.5GHz

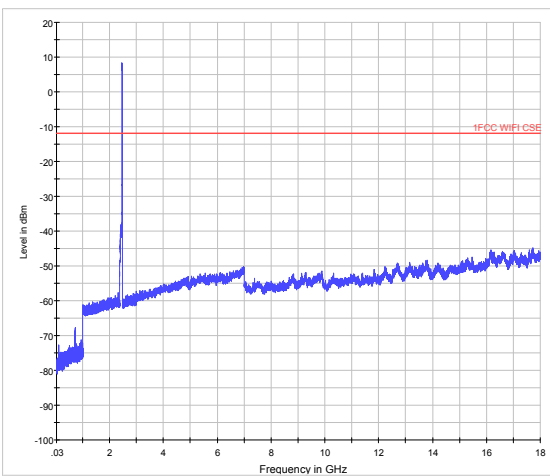

802.11n (HT20) CH11 30MHz to 18GHz

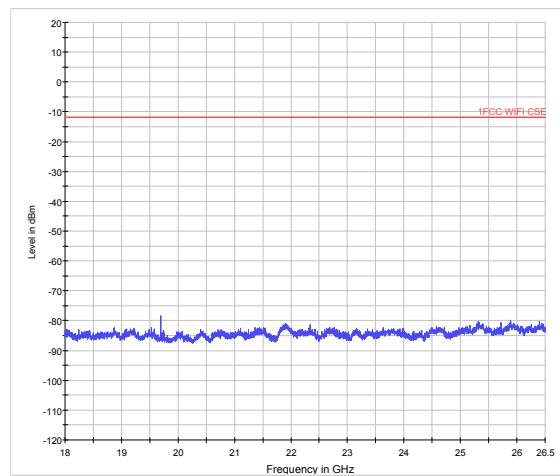

802.11n (HT20) CH11 18GHz to 26.5GHz

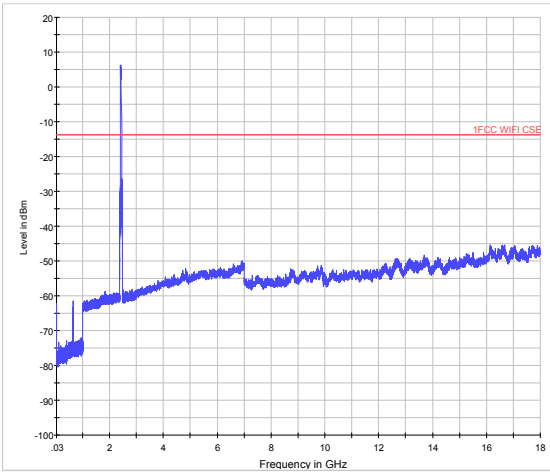

802.11n (HT40) CH3 30MHz to 18GHz

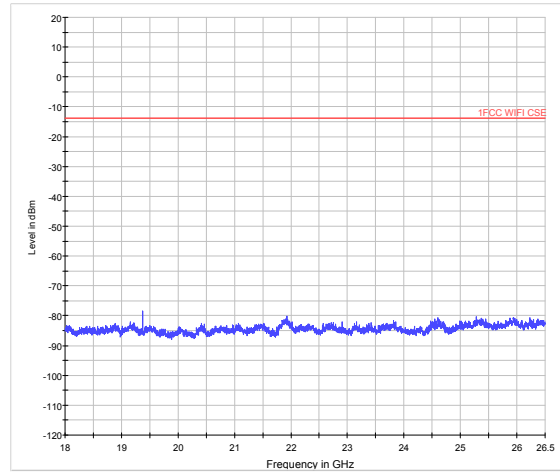

802.11n (HT40) CH3 18MHz to 26.5GHz

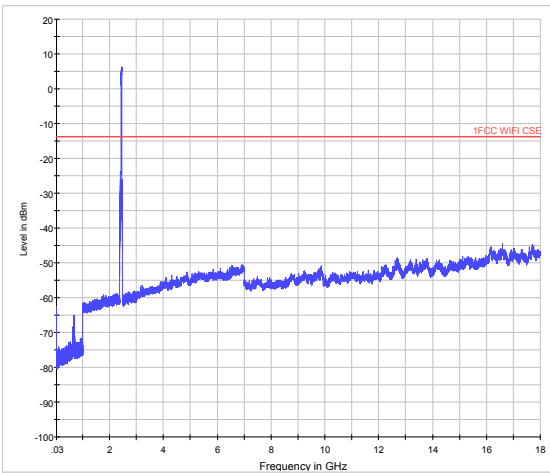

802.11n (HT40) CH6 30MHz to 18GHz

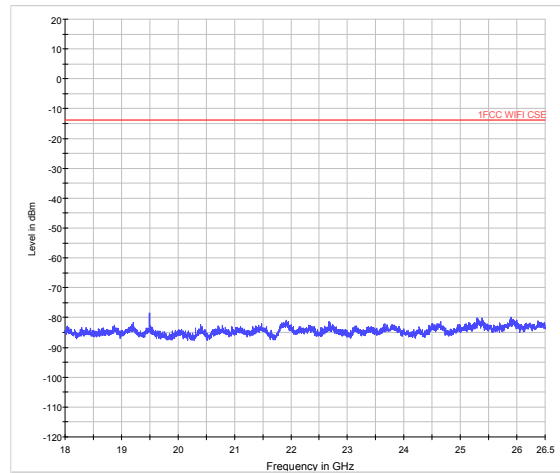

802.11n (HT40) CH6 18MHz to 26.5GHz

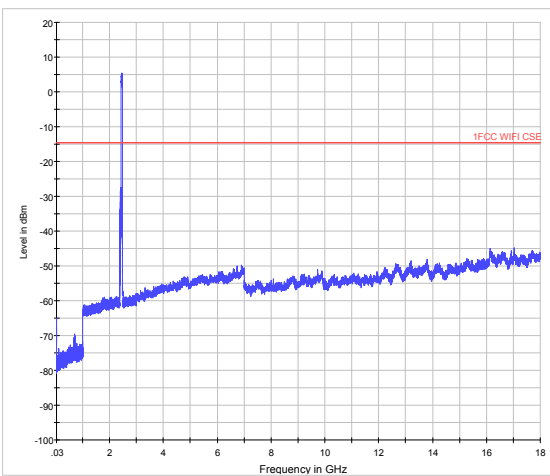

802.11n (HT40) CH9 30MHz to 18GHz

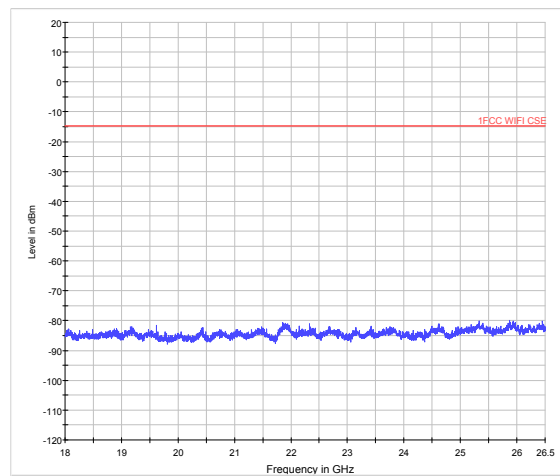

802.11n (HT40) CH9 18MHz to 26.5GHz

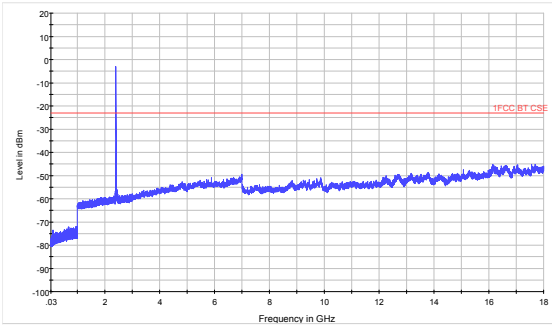

BLE CH0 30MHz to 18GHz

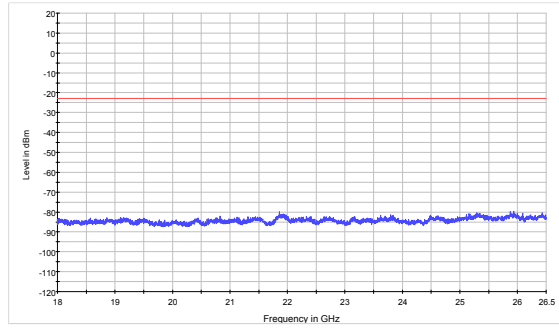

BLE CH0 18GHz to 26.5GHz

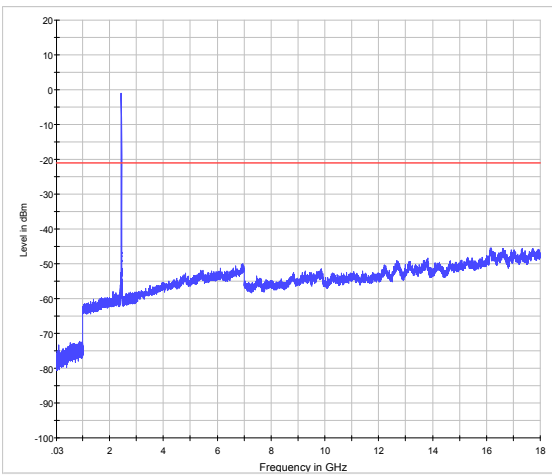

BLE CH19 30MHz to 18GHz

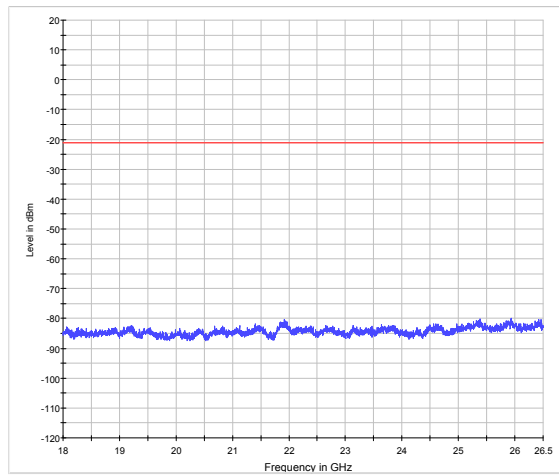

BLE CH19 18GHz to 26.5GHz

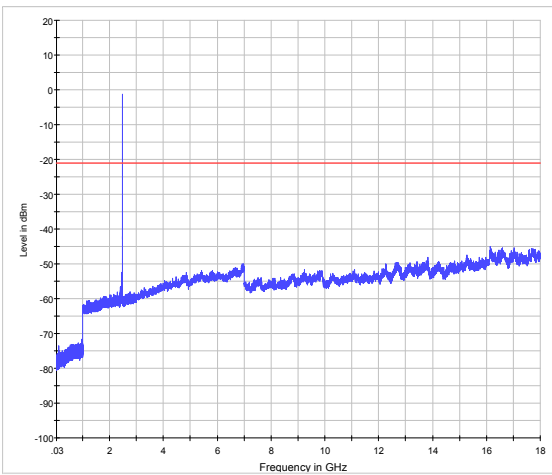

BLE CH39 18GHz to 26.5GHz

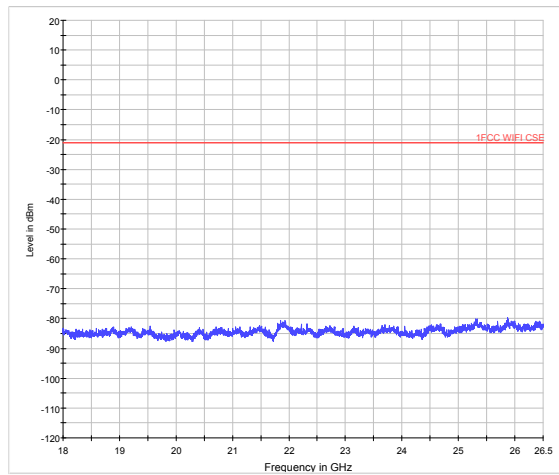

BLE CH39 18GHz to 26.5GHz

5.6. Radiated Emissions in the Restricted Band

Ambient condition

Temperature	Relative humidity	Pressure
23°C ~25°C	45%~50%	101.5kPa

Method of Measurement

The Equipment Under Test (EUT) was set up on a non-conductive table in the semi-anechoic chamber. The test was performed at the distance of 3 m between the EUT and the receiving antenna. The turntable shall be rotated from 0 to 360 degrees for detecting the maximum of radiated spurious signal level. The measurements shall be repeated with orthogonal polarization of the test antenna. RBW is set to 100kHz. The data of cable loss and antenna factor has been calibrated in full testing frequency range before the testing. Sweep the whole frequency band through the range from 9kHz to the 10th harmonic of the carrier, and the emissions less than 20 dB below the permissible value are reported.

Set the spectrum analyzer in the following:

- (a) PEAK: RBW=1MHz /VBW=3MHz / Sweep=AUTO
- (b) AVERAGE: RBW=1MHz /VBW=3MHz / Sweep=AUTO

This setting method can refer to **KDB 558074**.

The field strength of spurious emission was measured in the following position: EUT stand-up position (Z axis), lie-down position (X, Y axis). The worst emission was found in stand-up position (Y axis) and the antenna is vertical.

The test is in transmitting mode.

Test setup

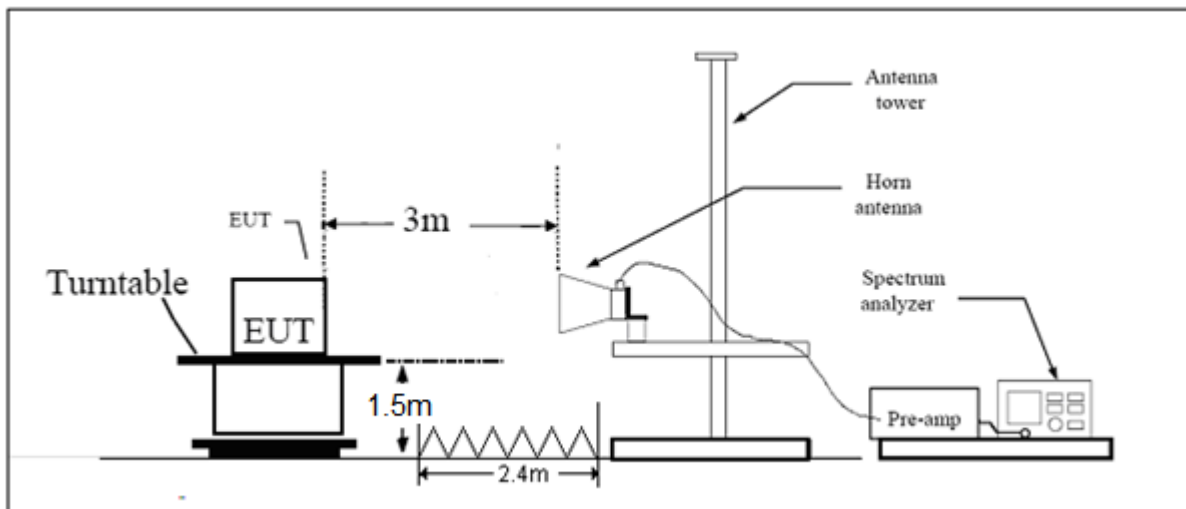

Note: Area side: 2.4mX3.6m

Limits

Spurious Radiated Emissions are permitted in any of the frequency bands listed below:

MHz	MHz	MHz	GHz
0.090 - 0.110	16.42 - 16.423	399.9 - 410	4.5 - 5.15
¹ 0.495 - 0.505	16.69475 - 16.69525	608 - 614	5.35 - 5.46
2.1735 - 2.1905	16.80425 - 16.80475	960 - 1240	7.25 - 7.75
4.125 - 4.128	25.5 - 25.67	1300 - 1427	8.025 - 8.5
4.17725 - 4.17775	37.5 - 38.25	1435 - 1626.5	9.0 - 9.2
4.20725 - 4.20775	73 - 74.6	1645.5 - 1646.5	9.3 - 9.5
6.215 - 6.218	74.8 - 75.2	1660 - 1710	10.6 - 12.7
6.26775 - 6.26825	108 - 121.94	1718.8 - 1722.2	13.25 - 13.4
6.31175 - 6.31225	123 - 138	2200 - 2300	14.47 - 14.5
8.291 - 8.294	149.9 - 150.05	2310 - 2390	15.35 - 16.2
8.362 - 8.366	156.52475 - 156.52525	2483.5 - 2500	17.7 - 21.4
8.37625 - 8.38675	156.7 - 156.9	2690 - 2900	22.01 - 23.12
8.41425 - 8.41475	162.0125 - 167.17	3260 - 3267	23.6 - 24.0
12.29 - 12.293	167.72 - 173.2	3332 - 3339	31.2 - 31.8
12.51975 - 12.52025	240 - 285	3345.8 - 3358	36.43 - 36.5
12.57675 - 12.57725	322 - 335.4	3600 - 4400	(²)
13.36 - 13.41			

Limit in restricted band

Frequency of emission (MHz)	Field strength(uV/m)	Field strength(dBuV/m)
30-88	100	40
88-216	150	43.5
216-960	200	46
Above960	500	54

§15.35(b)

There is also a limit on the radio frequency emissions, as measured using instrumentation with a peak detector function, corresponding to 20 dB above the maximum permitted average limit.

Peak Limit=74 dBuV/m

Average Limit=54 dBuV/m

Measurement Uncertainty

The assessed measurement uncertainty to ensure 95% confidence level for the normal distribution is with the coverage factor $k = 1.96$, $U = 3.55$ dB.



Test Results: PASS

The signal beyond the limit is carrier.

802.11b-Channel 1: Peak

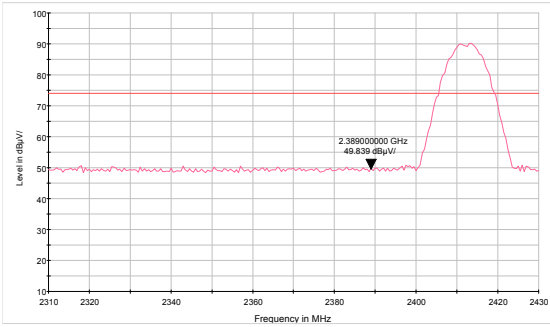

802.11b-Channel 11: Peak

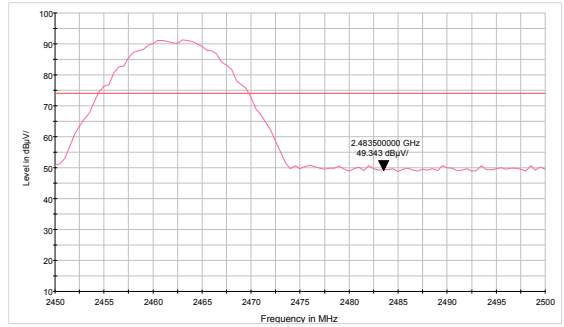

802.11b-Channel 1: Average

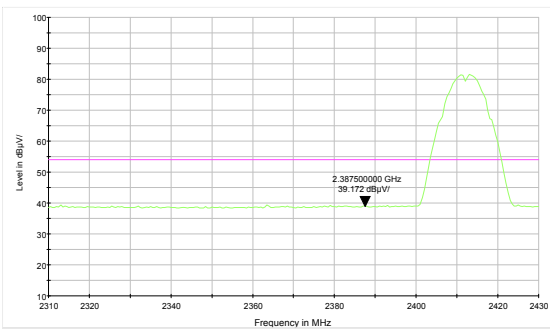

802.11b-Channel 11: Average

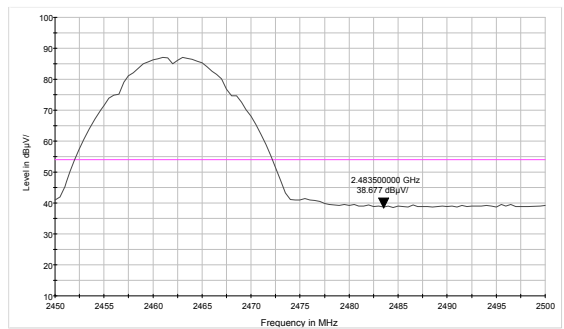

802.11g-Channel 1: Peak

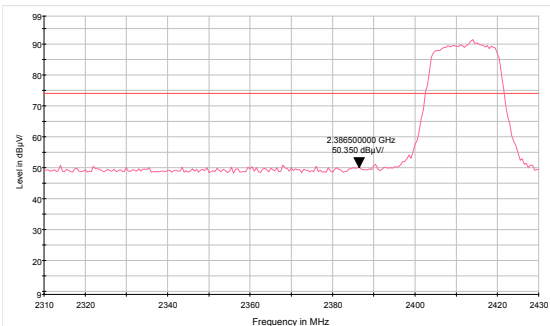

802.11g-Channel 11: Peak

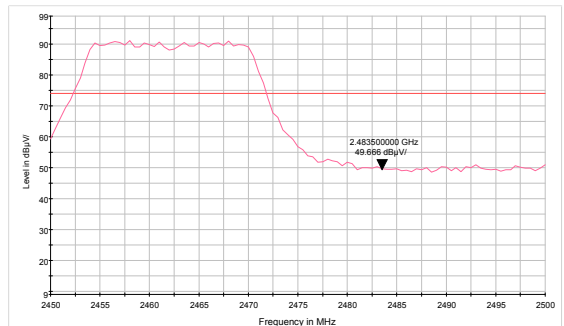

802.11g-Channel 1: Average

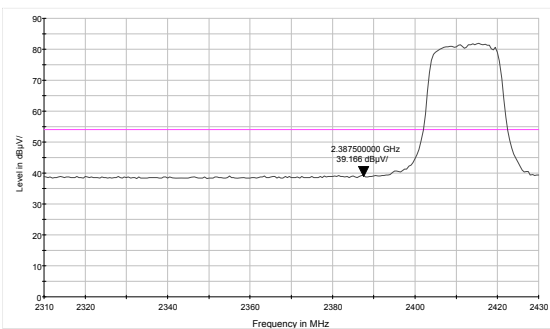

802.11g-Channel 11: Average

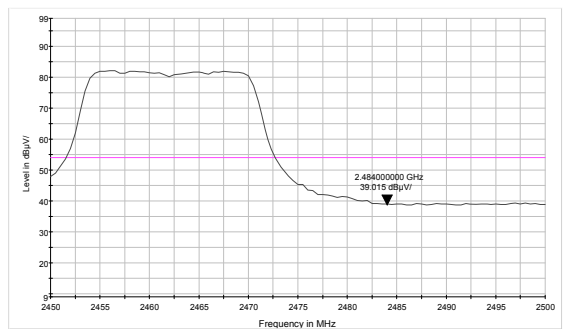

802.11n HT20 -Channel 1: Peak

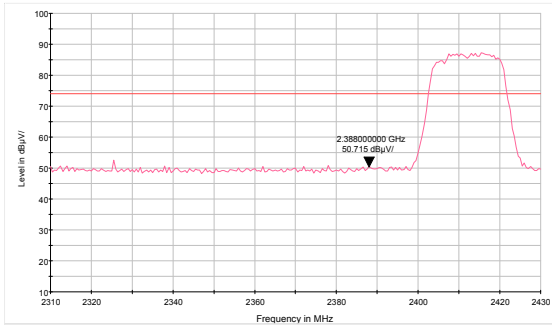

802.11n HT20-Channel 11: Peak

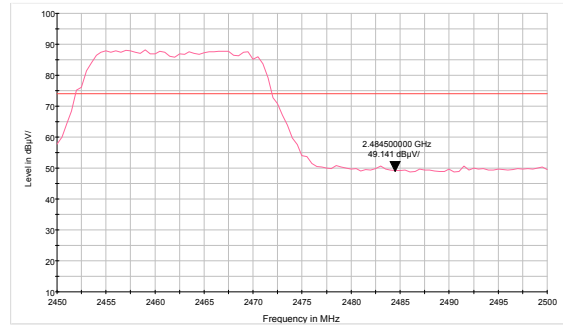

802.11n HT20-Channel 1: Average

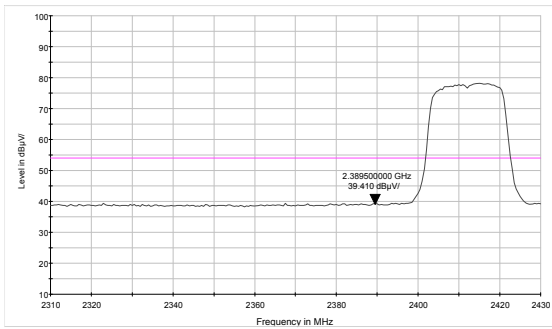

802.11n HT20-Channel 11: Average

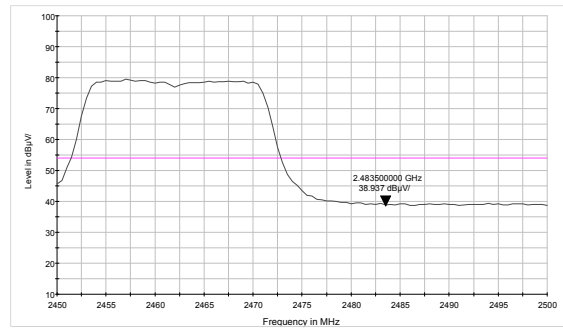

802.11n HT40 -Channel 3: Peak

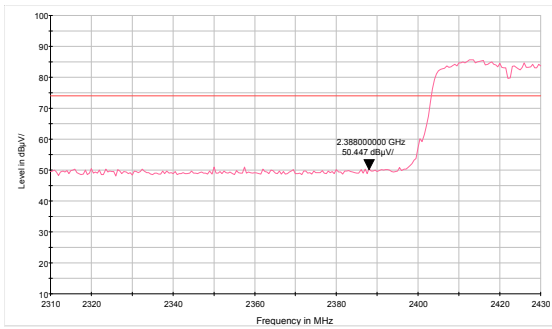

802.11n HT40-Channel 9: Peak

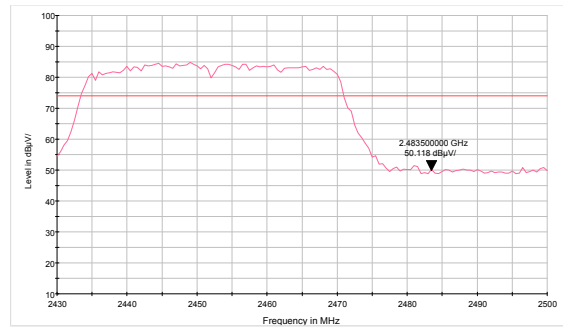

802.11n HT40-Channel 3: Average

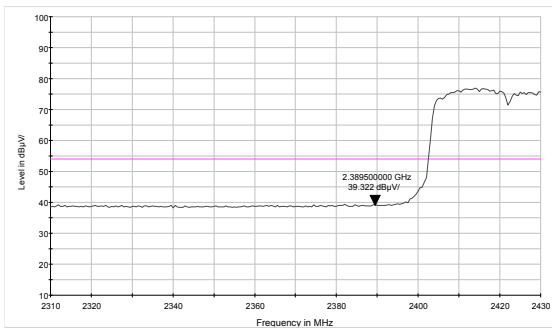

802.11n HT40-Channel 9: Average

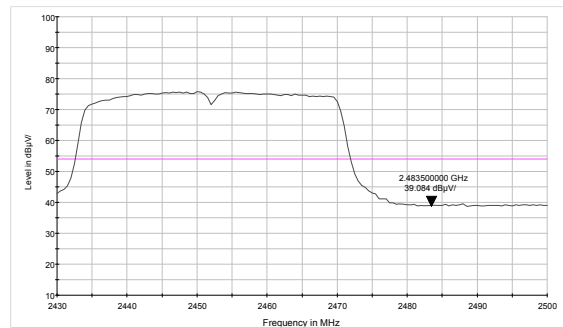

BLE -Channel 0: Peak

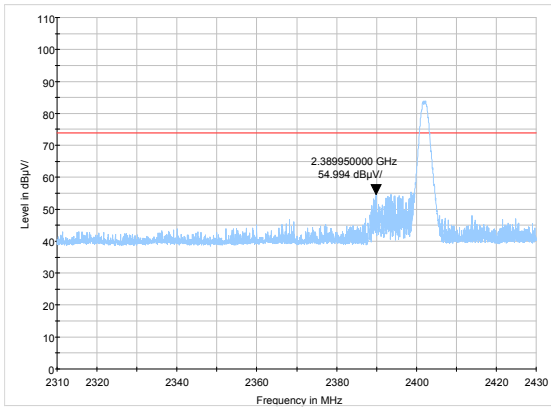

BLE -Channel 39: Peak

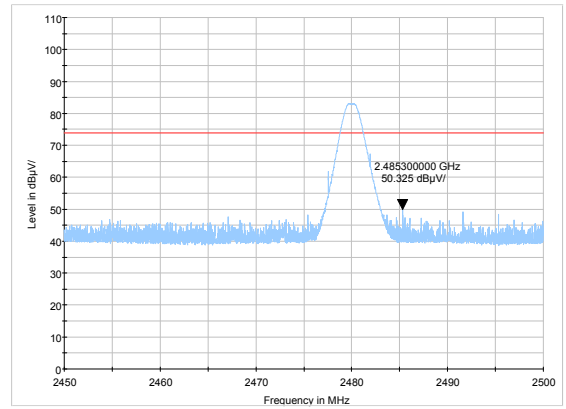

BLE -Channel 0: Average

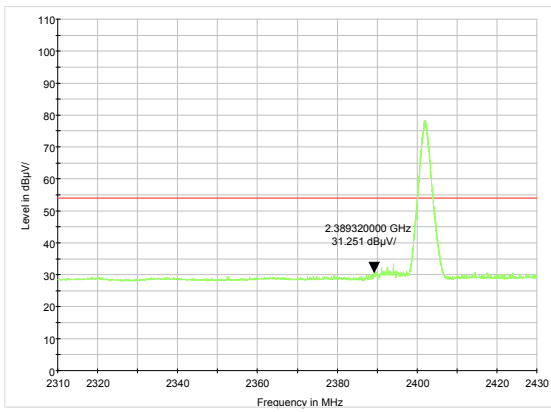

BLE -Channel 39: Average

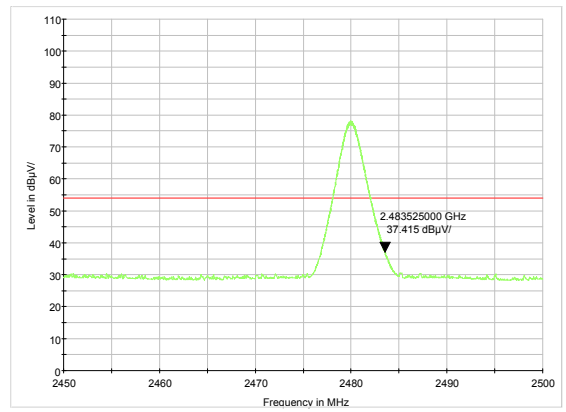

5.7. Radiates Emission

Ambient condition

Temperature	Relative humidity	Pressure
23°C ~25°C	45%~50%	102.5kPa

Method of Measurement

The test set-up was made in accordance to the general provisions of ANSI C63.10-2013. The Equipment Under Test (EUT) was set up on a non-conductive table in the semi-anechoic chamber. The test was performed at the distance of 3 m between the EUT and the receiving antenna. The radiated emissions measurements were made in a typical installation configuration.

Sweep the whole frequency band through the range from 9 kHz to the 10th harmonic of the carrier, and the emissions less than 20 dB below the permissible value are reported.

During the test, below 30MHz, the center of the loop shall be 1 meters; above 30MHz, the height of receive antenna shall be moved from 1 to 4 meters, and the antenna shall be performed under horizontal and vertical polarization. The turntable shall be rotated from 0 to 360 degrees for detecting the maximum of radiated spurious signal level. The measurements shall be repeated with orthogonal polarization of the test antenna. The data of cable loss and antenna factor has been calibrated in full testing frequency range before the testing.

Set the spectrum analyzer in the following:

Below 1GHz (detector: Peak and Quasi-Peak)

RBW=100 kHz / VBW=300 kHz / Sweep=AUTO

Above 1GHz (detector: Peak):

(a) PEAK: RBW=1MHz / VBW=3MHz / Sweep=AUTO

(b) AVERAGE: RBW=1MHz / VBW=3MHz / Sweep=AUTO

The radiated emission was measured in the following position: EUT stand-up position (Z axis), lie-down position (X, Y axis). The worst emission was found in lie-down position (X axis) and the worst case was recorded.

The test is in transmitting mode.

Test setup

9KHz ~ 30MHz

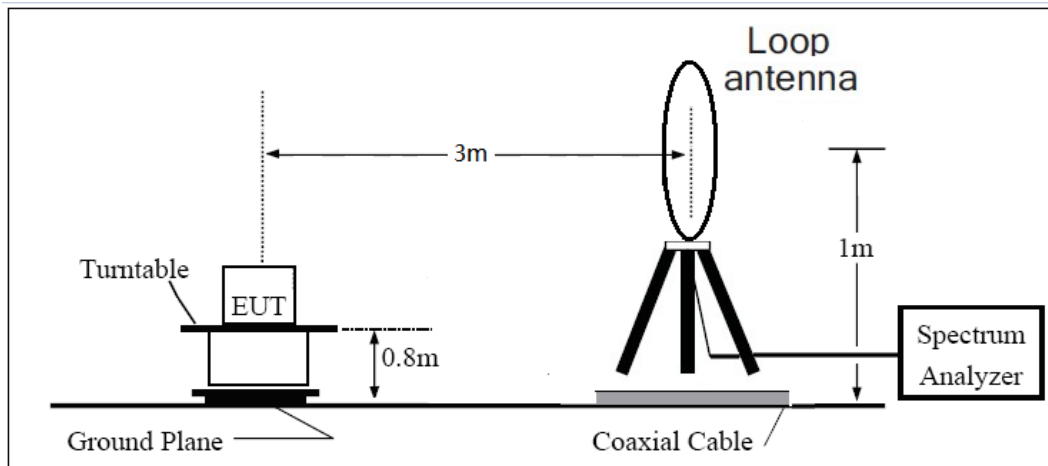

30MHz ~ 1GHz

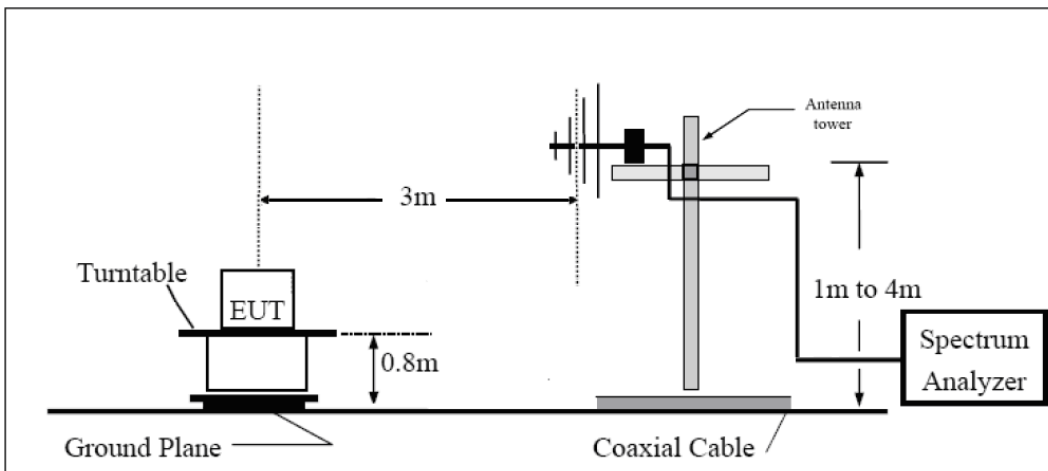

Above 1GHz

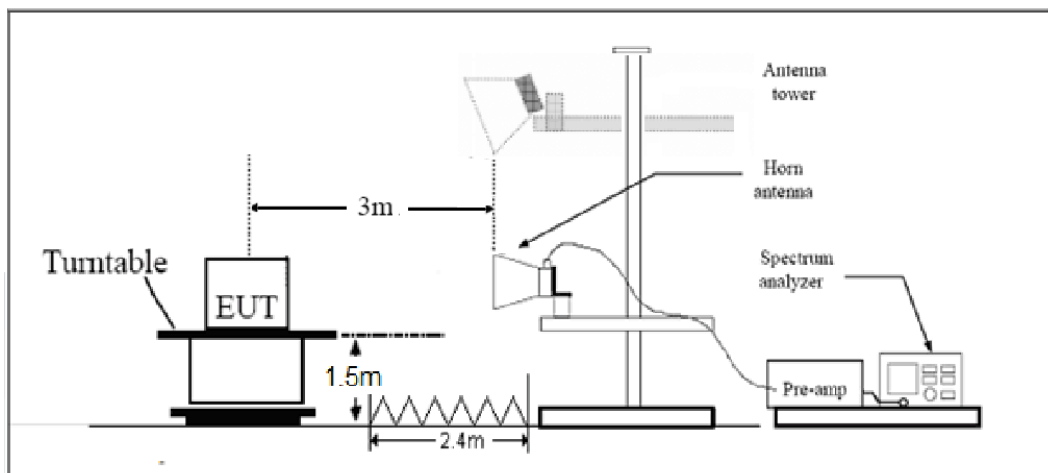

Note: Area side:2.4mX3.6m

Limits

Rule Part 15.247(d) specifies that “In addition, radiated emissions which fall in the restricted bands, as defined in § 15.205(a), must also comply with the radiated emission limits specified in § 15.209(a) (see § 15.205(c)).”

Limit in restricted band

Frequency of emission (MHz)	Field strength(uV/m)	Field strength(dBuV/m)
0.009–0.490	2400/F(kHz)	/
0.490–1.705	24000/F(kHz)	/
1.705–30.0	30	/
30-88	100	40
88-216	150	43.5
216-960	200	46
Above960	500	54

§15.35(b)

There is also a limit on the radio frequency emissions, as measured using instrumentation with a peak detector function, corresponding to 20 dB above the maximum permitted average limit.

Measurement Uncertainty

The assessed measurement uncertainty to ensure 95% confidence level for the normal distribution is with the coverage factor $k = 1.96$.

Frequency	Uncertainty
9KHz-30MHz	3.55 dB
30MHz-200MHz	4.19 dB
200MHz-1GHz	3.63 dB
Above 1GHz	3.68 dB

Test result

Sweep from 9 kHz to 30MHz, and the emissions more than 20 dB below the permissible value are not reported.

The following graphs display the maximum values of horizontal and vertical by software.

For above 1GHz, Blue trace uses the peak detection, Green trace uses the average detection.

During the test, the Radiates Emission from 30MHz to 1GHz was performed in all modes with all channels, 802.11n (HT20) CH1 are selected as the worst condition. The test data of the worst-case condition was recorded in this report.

Continuous TX mode:

FCC RE 0.03-1GHz QP Class B

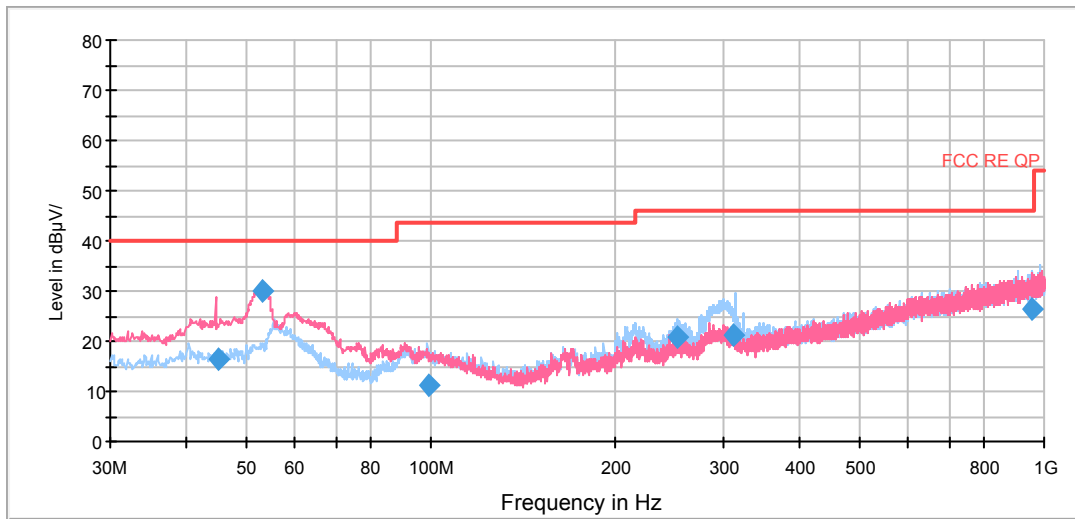

Radiates Emission from 30MHz to 1GHz

Frequency (MHz)	Quasi-Peak (dBuV/m)	Reading value (dBuV/m)	Height (cm)	Polarization	Azimuth (deg)	Correct Factor (dB)	Margin (dB)	Limit (dBuV/m)
45.150000	16.5	3.3	100.0	V	0.0	13.2	23.5	40.0
52.997500	30.0	17.0	100.0	V	288.0	13.0	10.0	40.0
98.990000	11.0	-2.2	100.0	H	199.0	13.2	32.5	43.5
251.930000	20.8	6.4	125.0	H	117.0	14.4	25.2	46.0
312.557500	21.2	5.3	100.0	H	20.0	15.9	24.8	46.0
955.060000	26.5	-0.8	100.0	H	0.0	27.3	19.5	46.0

- Remark:**
1. Quasi-Peak = Reading value + Correction factor
 2. Correction Factor = Antenna factor+ Insertion loss(cable loss+amplifier gain)
 3. Margin = Limit – Quasi-Peak

802.11b CH1

RE 1G-6GHz PK+AV Class B

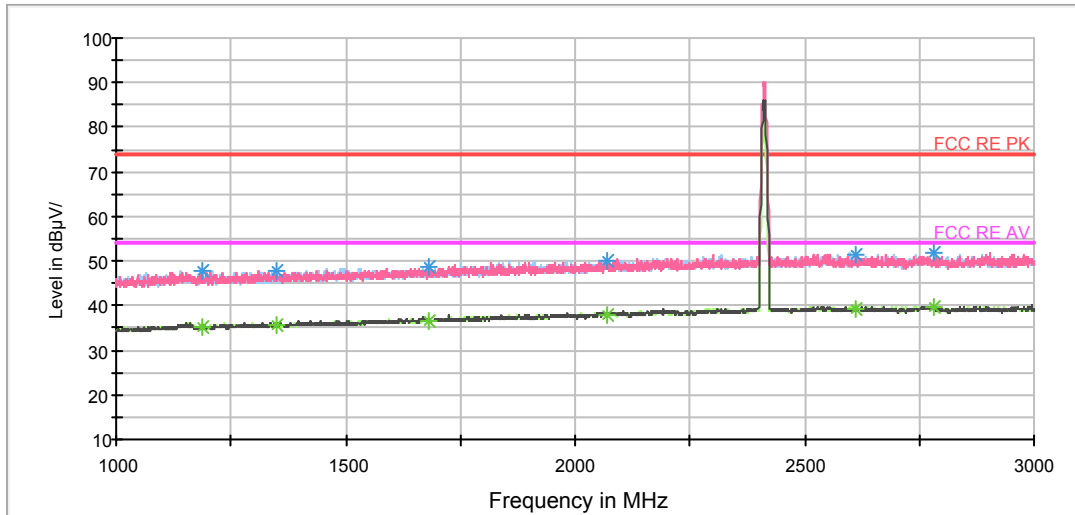

Note: The signal beyond the limit is carrier.
Radiates Emission from 1GHz to 3GHz

RE 3-18GHz PK+AV

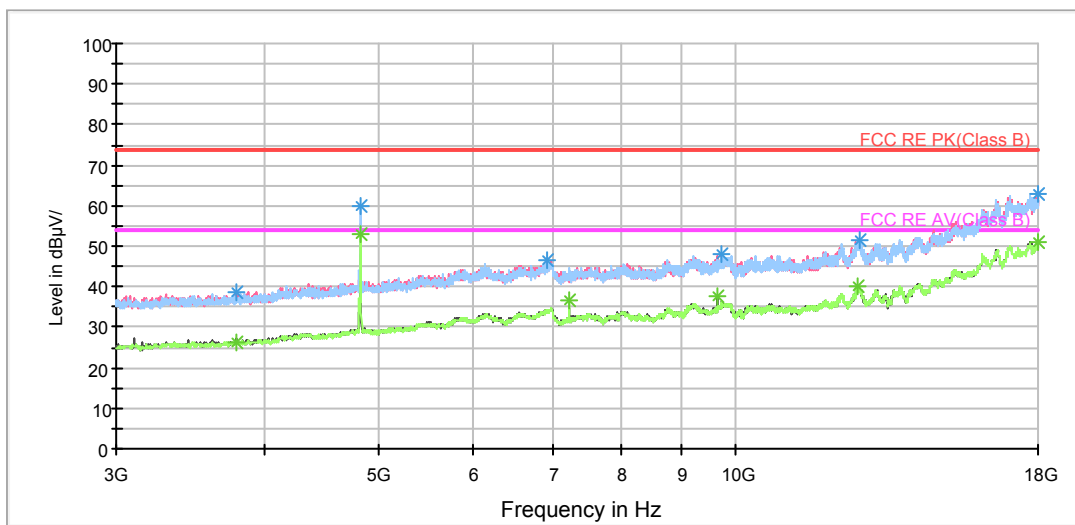

Radiates Emission from 3GHz to 18GHz

RE 18-26.5GHz PK+AV

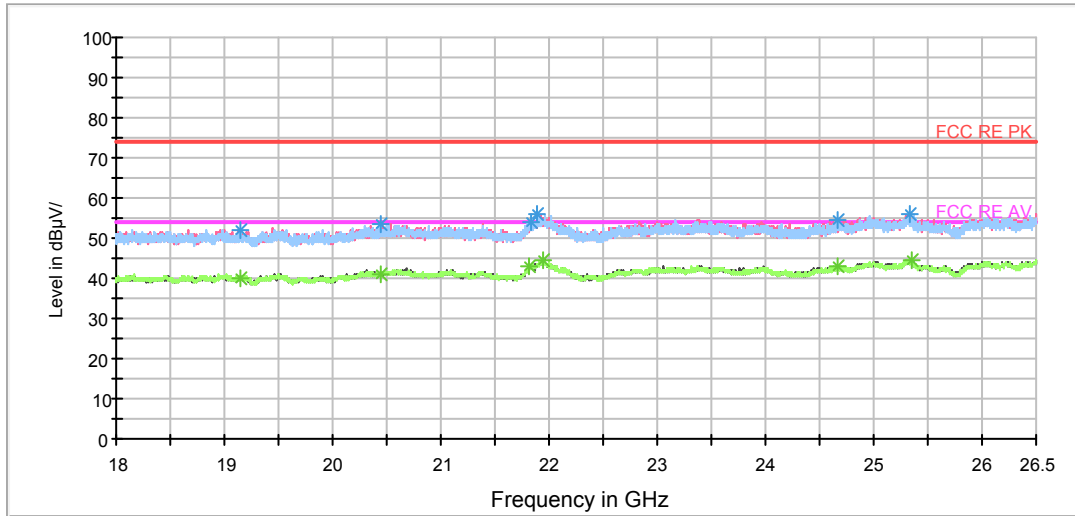

Radiates Emission from 18GHz to 26.5GHz

Frequency (MHz)	Peak (dBuV/m)	Height (cm)	Polarization	Azimuth (deg)	Reading value (dBuV/m)	Correct Factor (dB)	Margin (dB)	Limit (dBuV/m)
1187.500000	47.9	100.0	V	158.0	45.5	2.4	26.1	74
1351.500000	48.0	100.0	H	154.0	45.1	2.9	26.0	74
1681.500000	48.8	100.0	H	290.0	44.8	4.0	25.2	74
2072.000000	50.2	100.0	V	0.0	44.7	5.5	23.8	74
2611.000000	51.5	100.0	V	0.0	44.2	7.3	22.5	74
2782.500000	52.1	100.0	H	218.0	44.7	7.4	21.9	74

Remark: 1. Correction Factor = Antenna factor+ Insertion loss (cable loss + amplifier gain)

Frequency (MHz)	Average (dBuV/m)	Height (cm)	Polarization	Azimuth (deg)	Reading value (dBuV/m)	Correct Factor (dB)	Margin (dB)	Limit (dBuV/m)
1153.500000	36.0	100.0	H	255.0	33.7	2.3	18.0	54
1393.500000	36.4	100.0	V	0.0	33.4	3.0	17.6	54
1725.000000	39.1	100.0	V	356.0	34.9	4.2	14.9	54
2057.000000	38.6	100.0	V	3.0	33.2	5.4	15.4	54
2296.500000	38.8	100.0	V	30.0	32.4	6.4	15.2	54
2591.000000	39.2	100.0	V	174.0	32.0	7.2	14.8	54

Remark: 1. Correction Factor = Antenna factor+ Insertion loss (cable loss + amplifier gain)

802.11b CH6

RE 1G-6GHz PK+AV Class B

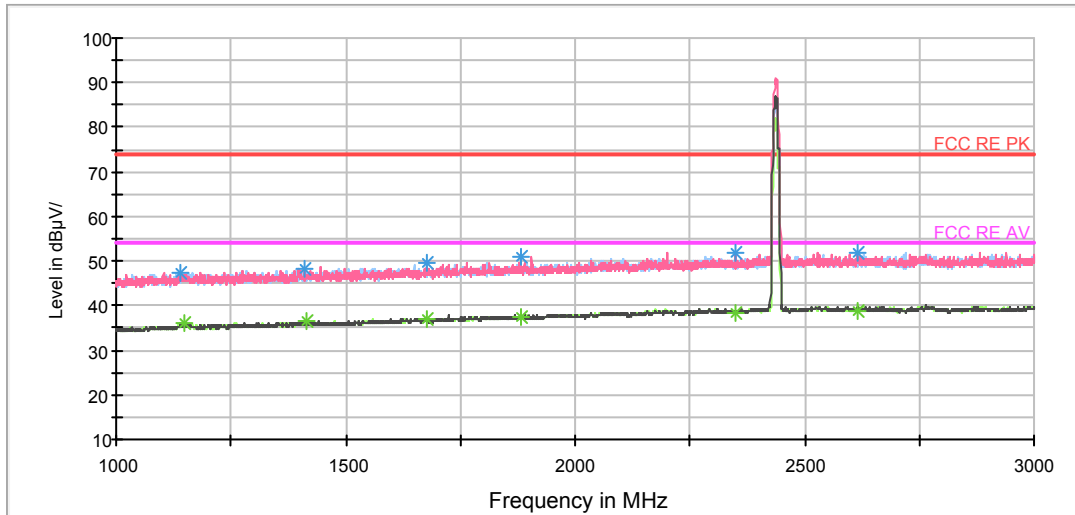

Note: The signal beyond the limit is carrier.
Radiates Emission from 1GHz to 3GHz

RE 3-18GHz PK+AV

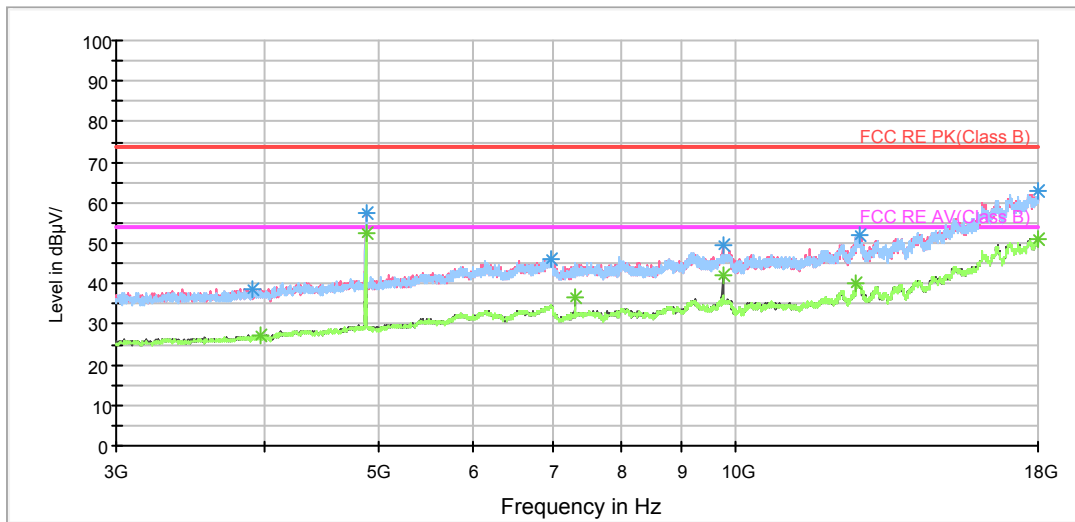

Radiates Emission from 3GHz to 18GHz

RE 18-26.5GHz PK+AV

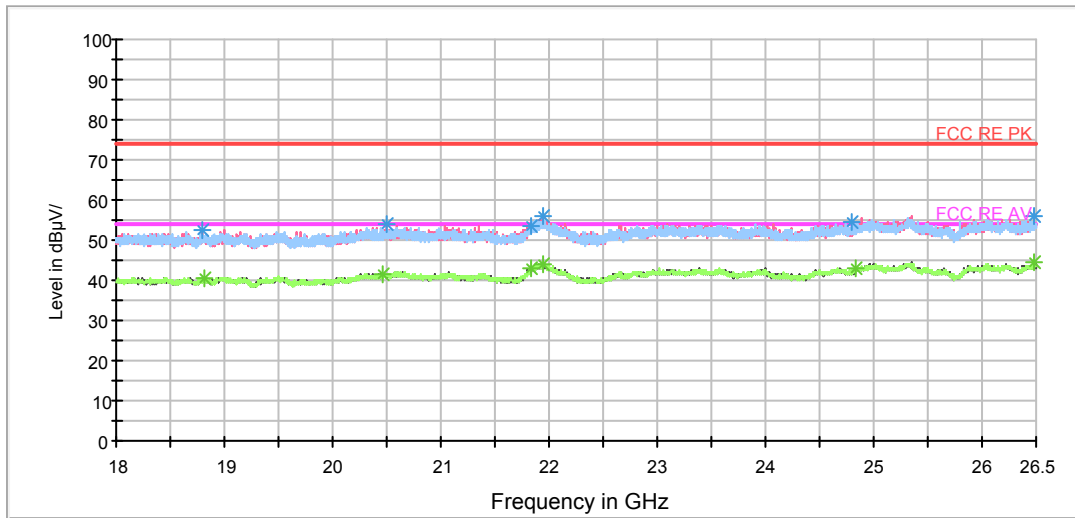

Radiates Emission from 18GHz to 26.5GHz

Frequency (MHz)	Peak (dBuV/m)	Height (cm)	Polarization	Azimuth (deg)	Reading value (dBuV/m)	Correct Factor (dB)	Margin (dB)	Limit (dBuV/m)
1141.000000	47.3	100.0	H	146.0	45.0	2.3	26.7	74
1410.000000	48.2	100.0	V	0.0	45.1	3.1	25.8	74
1677.500000	49.4	100.0	H	347.0	45.4	4.0	24.6	74
1881.000000	50.8	100.0	V	118.0	46.0	4.8	23.2	74
2350.500000	51.7	100.0	V	10.0	45.1	6.6	22.3	74
2614.000000	51.9	100.0	V	94.0	44.6	7.3	22.1	74

Remark: 1. Correction Factor = Antenna factor+ Insertion loss (cable loss + amplifier gain)

Frequency (MHz)	Average (dBuV/m)	Height (cm)	Polarization	Azimuth (deg)	Reading value (dBuV/m)	Correct Factor (dB)	Margin (dB)	Limit (dBuV/m)
1150.000000	36.3	100.0	H	300.0	34.0	2.3	17.7	54
1415.500000	36.3	100.0	V	248.0	33.2	3.1	17.7	54
1677.500000	36.8	100.0	H	347.0	32.8	4.0	17.2	54
1881.000000	37.3	100.0	V	118.0	32.5	4.8	16.7	54
2350.500000	38.5	100.0	V	10.0	31.9	6.6	15.5	54
2614.000000	38.9	100.0	V	94.0	31.6	7.3	15.1	54

Remark: 1. Correction Factor = Antenna factor+ Insertion loss (cable loss + amplifier gain)

802.11b CH11

RE 1G-6GHz PK+AV Class B

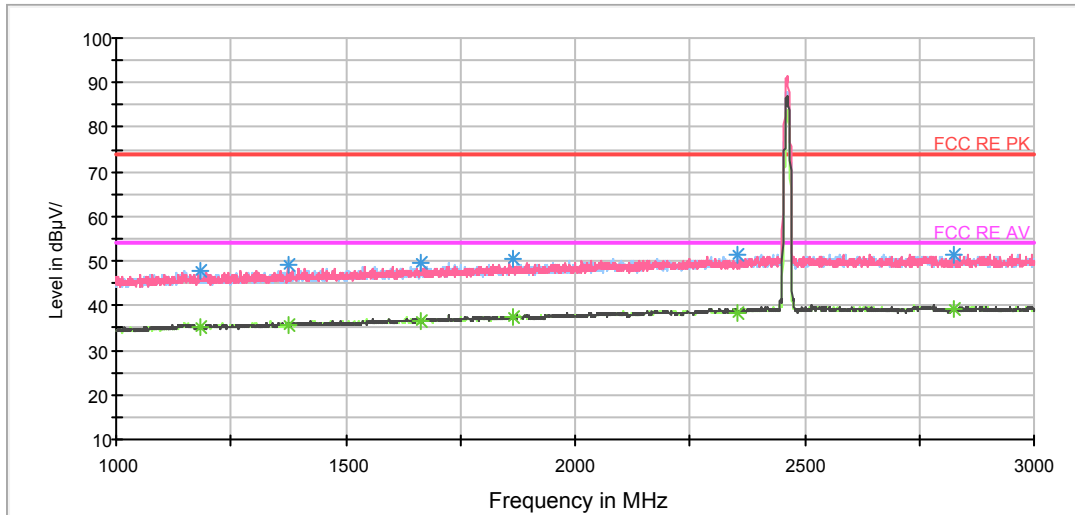

Note: The signal beyond the limit is carrier.
Radiates Emission from 1GHz to 3GHz

RE 3-18GHz PK+AV

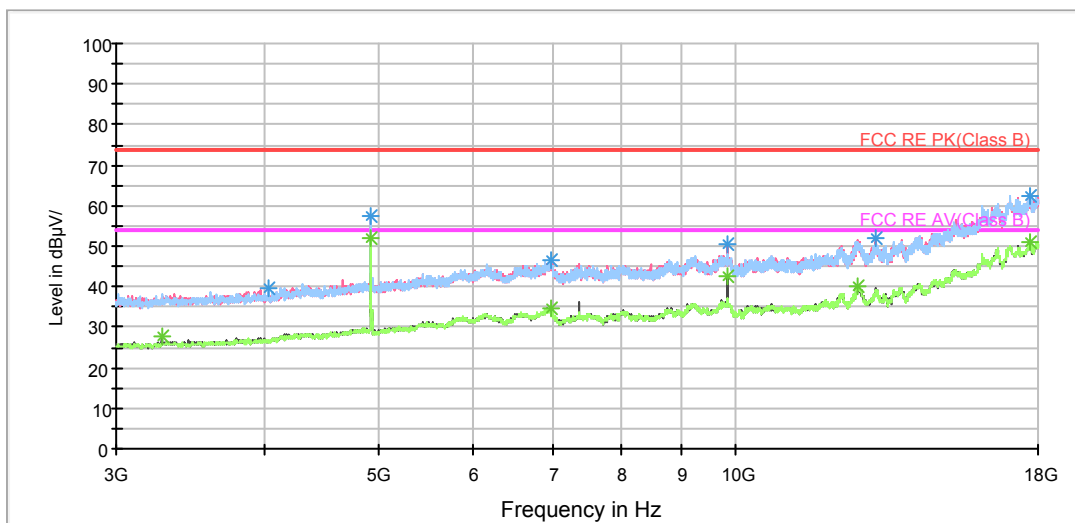

Radiates Emission from 3GHz to 18GHz



RE 18-26.5GHz PK+AV

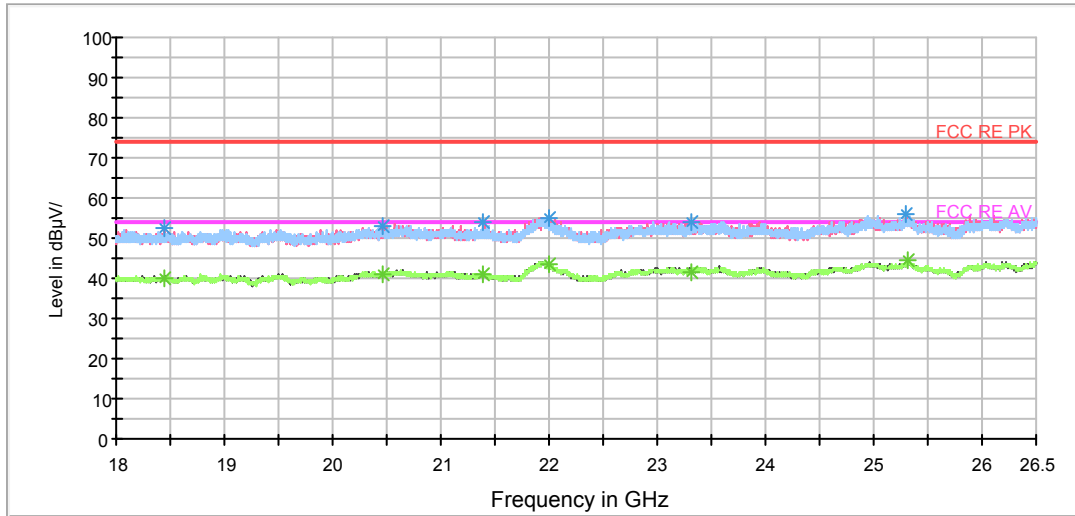

Radiates Emission from 18GHz to 26.5GHz

Frequency (MHz)	Peak (dBuV/m)	Height (cm)	Polarization	Azimuth (deg)	Reading value (dBuV/m)	Correct Factor (dB)	Margin (dB)	Limit (dBuV/m)
1184.000000	47.6	100.0	H	352.0	45.2	2.4	26.4	74
1373.500000	49.0	100.0	V	2.0	46.0	3.0	25.0	74
1664.000000	49.6	100.0	H	280.0	45.6	4.0	24.4	74
1864.500000	50.5	100.0	H	0.0	45.8	4.7	23.5	74
2354.500000	51.2	100.0	H	0.0	44.6	6.6	22.8	74
2827.000000	51.6	100.0	H	143.0	44.2	7.4	22.4	74

Remark: 1. Correction Factor = Antenna factor+ Insertion loss (cable loss + amplifier gain)

Frequency (MHz)	Average (dBuV/m)	Height (cm)	Polarization	Azimuth (deg)	Reading value (dBuV/m)	Correct Factor (dB)	Margin (dB)	Limit (dBuV/m)
1184.000000	35.2	100.0	H	352.0	32.8	2.4	18.8	54
1373.500000	35.7	100.0	V	2.0	32.7	3.0	18.3	54
1664.000000	36.5	100.0	H	280.0	32.5	4.0	17.5	54
1864.500000	37.3	100.0	H	0.0	32.6	4.7	16.7	54
2354.500000	38.3	100.0	H	0.0	31.7	6.6	15.7	54
2827.000000	39.2	100.0	H	143.0	31.8	7.4	14.8	54

Remark: 1. Correction Factor = Antenna factor+ Insertion loss (cable loss + amplifier gain)

802.11g CH1

RE 1G-6GHz PK+AV Class B

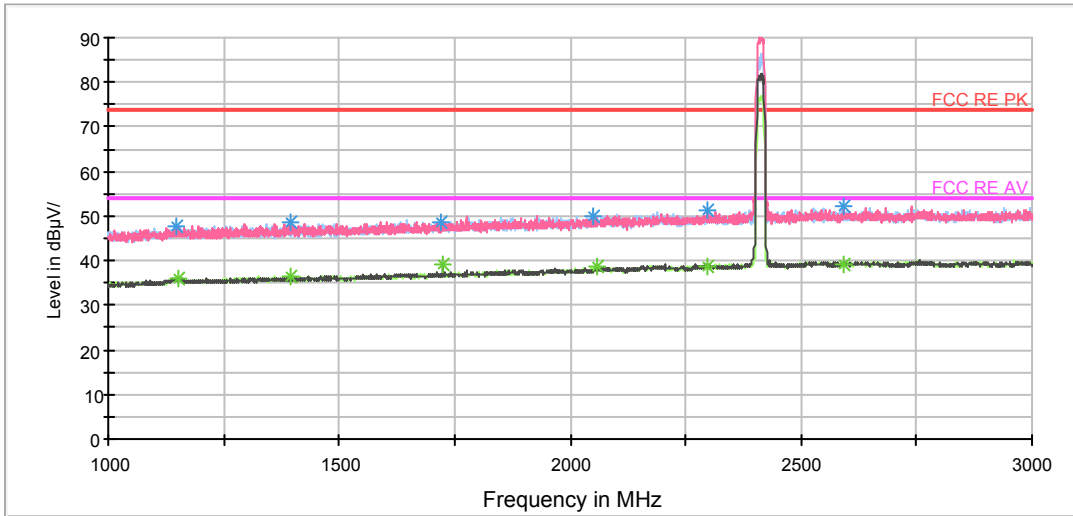

Note: The signal beyond the limit is carrier.
Radiates Emission from 1GHz to 3GHz

RE 3-18GHz PK+AV

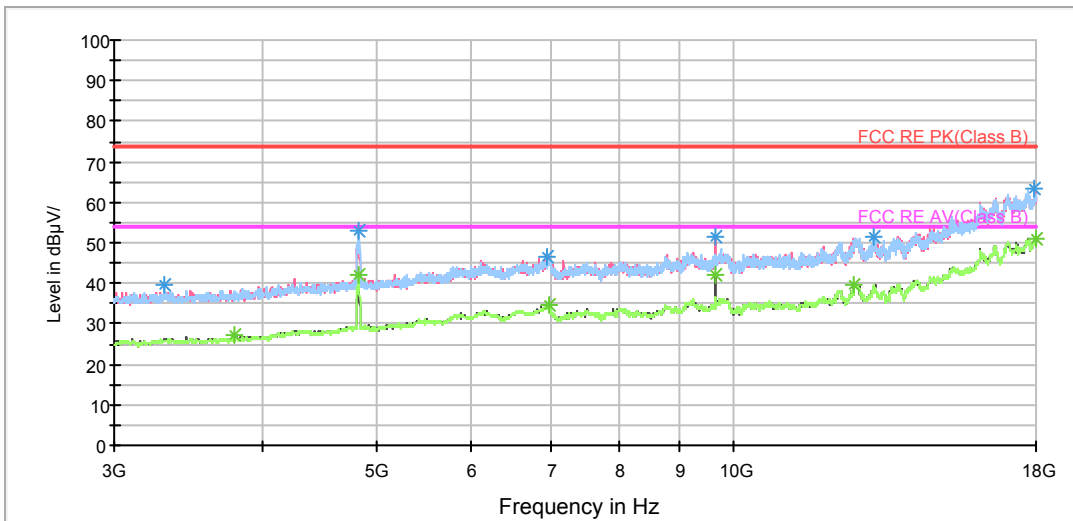

Radiates Emission from 3GHz to 18GHz

RE 18-26.5GHz PK+AV

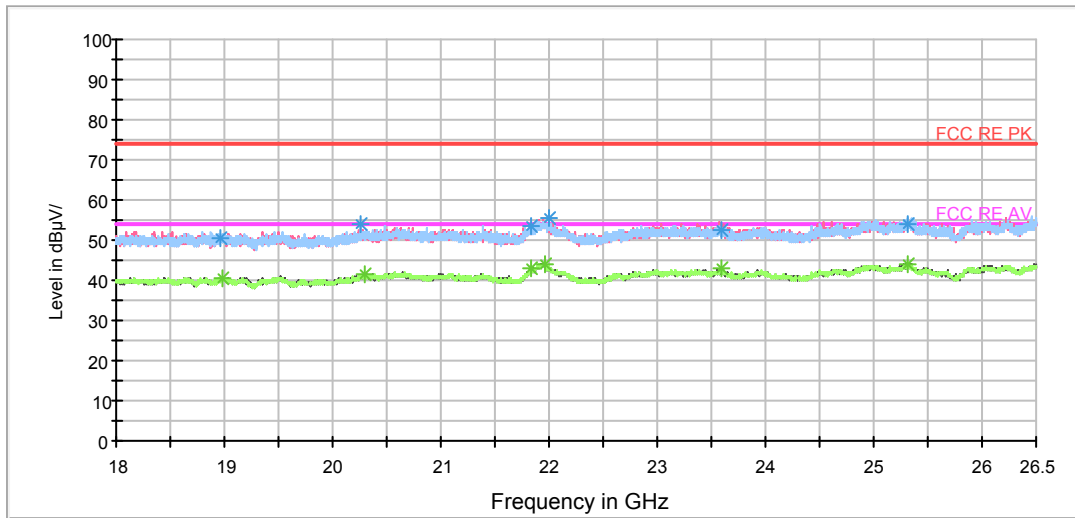

Radiates Emission from 18GHz to 26.5GHz

Frequency (MHz)	Peak (dBuV/m)	Height (cm)	Polarization	Azimuth (deg)	Reading value (dBuV/m)	Correct Factor (dB)	Margin (dB)	Limit (dBuV/m)
1146.000000	47.8	100.0	V	18.0	45.5	2.3	26.2	74
1394.000000	48.5	100.0	V	255.0	45.5	3.0	25.5	74
1720.000000	48.7	100.0	H	337.0	44.5	4.2	25.3	74
2049.500000	49.8	100.0	H	347.0	44.4	5.4	24.2	74
2296.500000	51.4	100.0	V	30.0	45.0	6.4	22.6	74
2591.000000	52.0	100.0	V	174.0	44.8	7.2	22.0	74

Remark: 1. Correction Factor = Antenna factor+ Insertion loss (cable loss + amplifier gain)

Frequency (MHz)	Average (dBuV/m)	Height (cm)	Polarization	Azimuth (deg)	Reading value (dBuV/m)	Correct Factor (dB)	Margin (dB)	Limit (dBuV/m)
1153.500000	36.0	100.0	H	255.0	33.7	2.3	18.0	54
1393.500000	36.4	100.0	V	0.0	33.4	3.0	17.6	54
1725.000000	39.1	100.0	V	356.0	34.9	4.2	14.9	54
2057.000000	38.6	100.0	V	3.0	33.2	5.4	15.4	54
2296.500000	38.8	100.0	V	30.0	32.4	6.4	15.2	54
2591.000000	39.2	100.0	V	174.0	32.0	7.2	14.8	54

Remark: 1. Correction Factor = Antenna factor+ Insertion loss (cable loss + amplifier gain)

802.11g CH6

RE 1G-6GHz PK+AV Class B

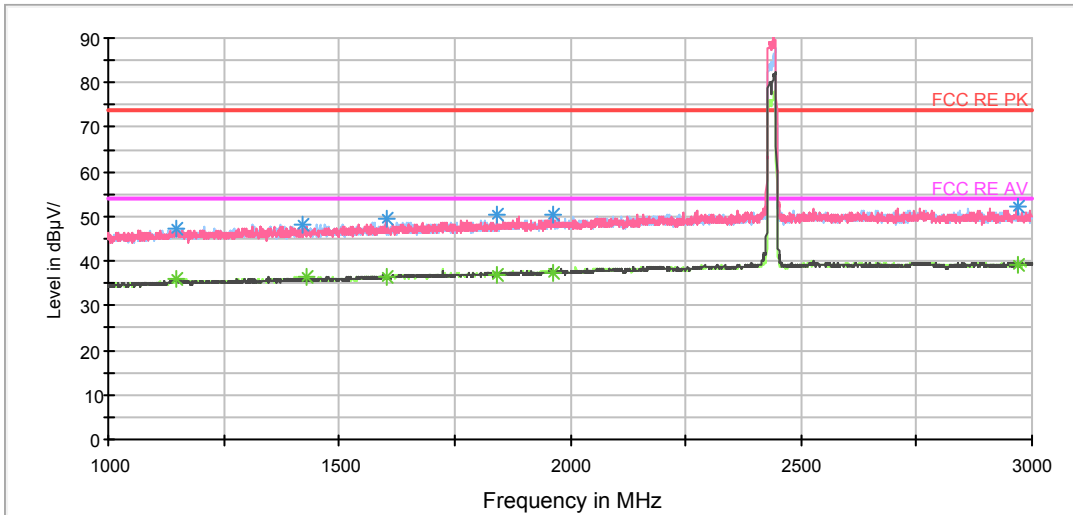

Note: The signal beyond the limit is carrier.
Radiates Emission from 1GHz to 3GHz

RE 3-18GHz PK+AV

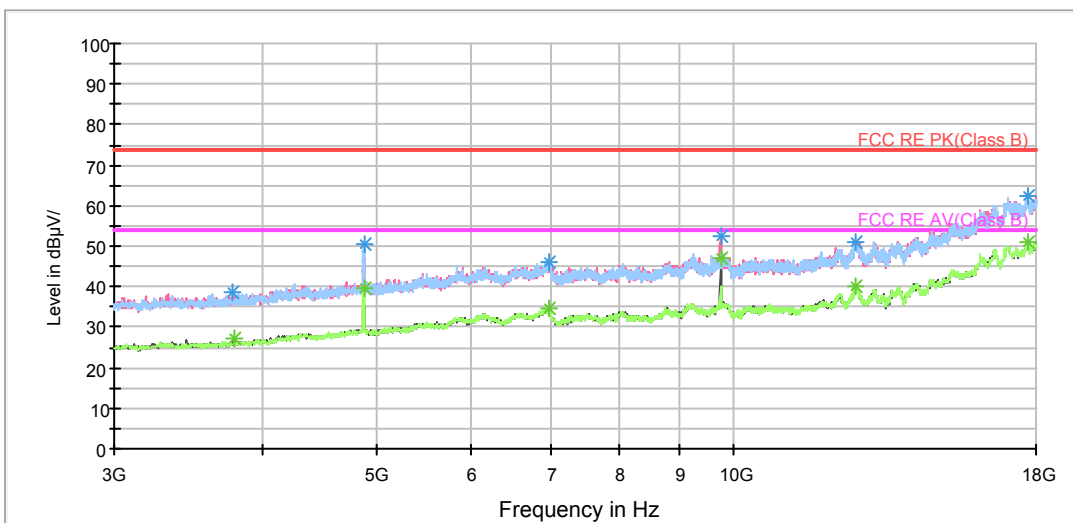

Radiates Emission from 3GHz to 18GHz

RE 18-26.5GHz PK+AV

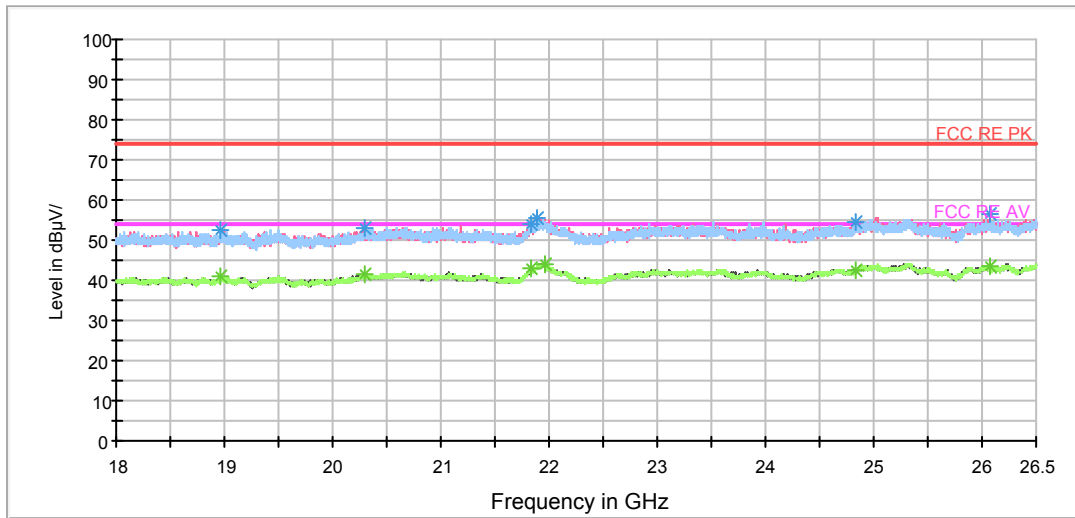

Radiates Emission from 18GHz to 26.5GHz

Frequency (MHz)	Peak (dBuV/m)	Height (cm)	Polarization	Azimuth (deg)	Reading value (dBuV/m)	Correct Factor (dB)	Margin (dB)	Limit (dBuV/m)
1145.500000	47.2	100.0	H	315.0	44.9	2.3	26.8	74
1419.000000	48.0	100.0	H	337.0	44.9	3.1	26.0	74
1601.000000	49.5	100.0	V	198.0	45.8	3.7	24.5	74
1842.000000	50.2	100.0	V	72.0	45.6	4.6	23.8	74
1962.500000	50.2	100.0	H	0.0	45.1	5.1	23.8	74
2971.000000	52.1	100.0	V	0.0	44.6	7.5	21.9	74

Remark: 1. Correction Factor = Antenna factor+ Insertion loss (cable loss + amplifier gain)

Frequency (MHz)	Average (dBuV/m)	Height (cm)	Polarization	Azimuth (deg)	Reading value (dBuV/m)	Correct Factor (dB)	Margin (dB)	Limit (dBuV/m)
1146.000000	36.1	100.0	V	124.0	33.8	2.3	17.9	54
1430.000000	36.5	100.0	V	2.0	33.3	3.2	17.5	54
1601.000000	36.5	100.0	V	198.0	32.8	3.7	17.5	54
1842.000000	37.0	100.0	V	72.0	32.4	4.6	17.0	54
1962.500000	37.4	100.0	H	0.0	32.3	5.1	16.6	54
2971.500000	39.0	100.0	H	355.0	31.5	7.5	15.0	54

Remark: 1. Correction Factor = Antenna factor+ Insertion loss (cable loss + amplifier gain)

802.11g CH11

RE 1G-6GHz PK+AV Class B

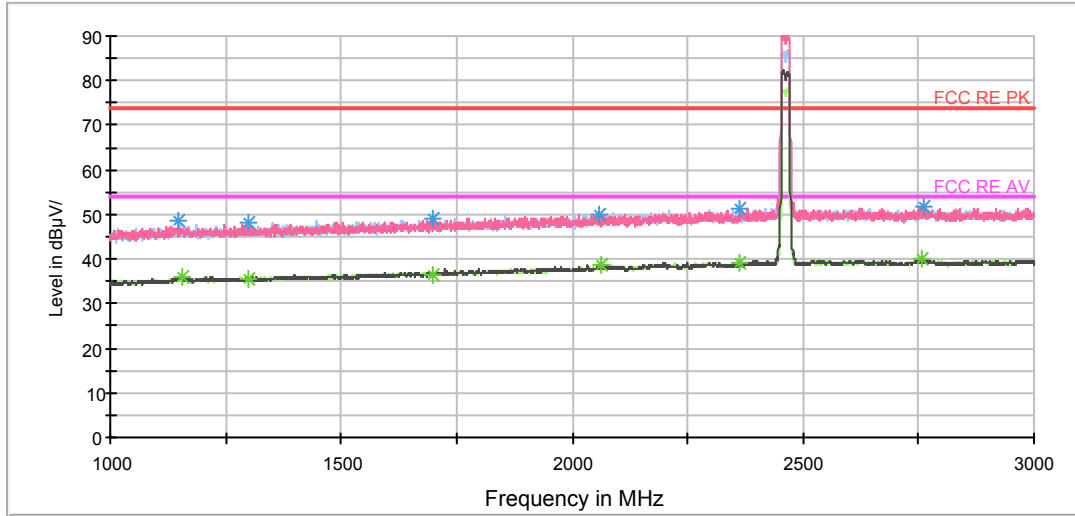

Note: The signal beyond the limit is carrier.
Radiates Emission from 1GHz to 3GHz

RE 3-18GHz PK+AV

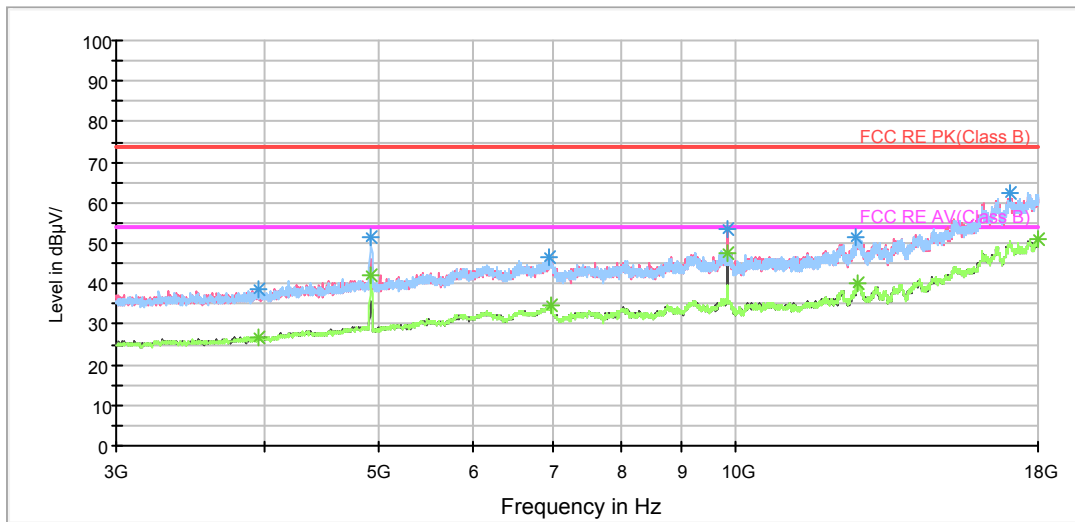

Radiates Emission from 3GHz to 18GHz

RE 18-26.5GHz PK+AV

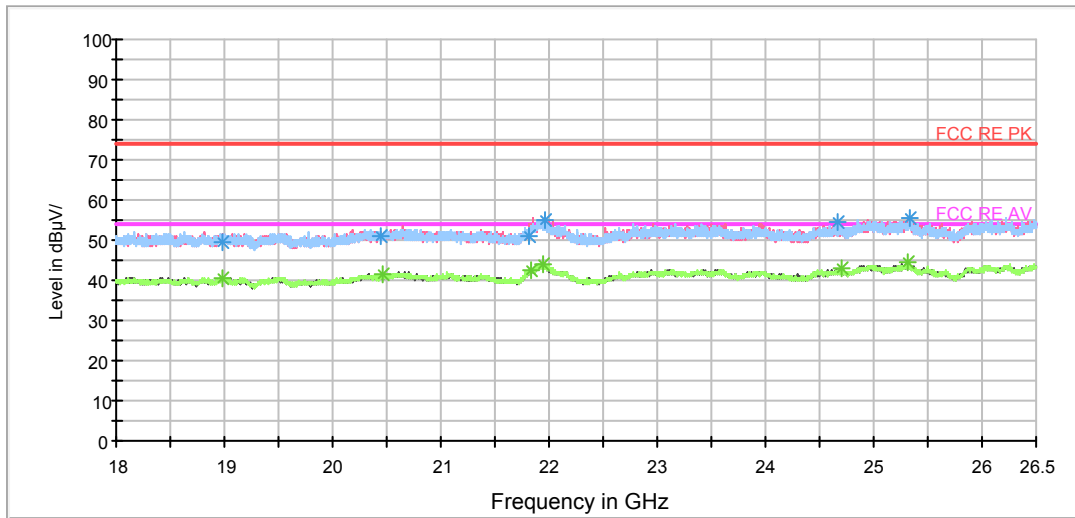

Radiates Emission from 18GHz to 26.5GHz

Frequency (MHz)	Peak (dBuV/m)	Height (cm)	Polarization	Azimuth (deg)	Reading value (dBuV/m)	Correct Factor (dB)	Margin (dB)	Limit (dBuV/m)
1149.000000	48.5	100.0	H	259.0	46.2	2.3	25.5	74
1300.000000	48.1	100.0	H	307.0	45.3	2.8	25.9	74
1698.000000	48.9	100.0	H	307.0	44.8	4.1	25.1	74
2060.500000	50.1	100.0	V	0.0	44.6	5.5	23.9	74
2362.500000	51.5	100.0	H	353.0	44.8	6.7	22.5	74
2760.500000	51.6	100.0	V	297.0	44.2	7.4	22.4	74

Remark: 1. Correction Factor = Antenna factor+ Insertion loss (cable loss + amplifier gain)

Frequency (MHz)	Average (dBuV/m)	Height (cm)	Polarization	Azimuth (deg)	Reading value (dBuV/m)	Correct Factor (dB)	Margin (dB)	Limit (dBuV/m)
1155.500000	36.1	100.0	V	213.0	33.8	2.3	17.9	54
1300.000000	35.4	100.0	H	307.0	32.6	2.8	18.6	54
1698.000000	36.5	100.0	H	307.0	32.4	4.1	17.5	54
2064.500000	38.7	100.0	H	88.0	33.2	5.5	15.3	54
2362.500000	39.0	100.0	H	353.0	32.3	6.7	15.0	54
2756.500000	39.9	100.0	V	3.0	32.5	7.4	14.1	54

Remark: 1. Correction Factor = Antenna factor+ Insertion loss (cable loss + amplifier gain)

802.11n (HT20) CH1

RE 1G-6GHz PK+AV Class B

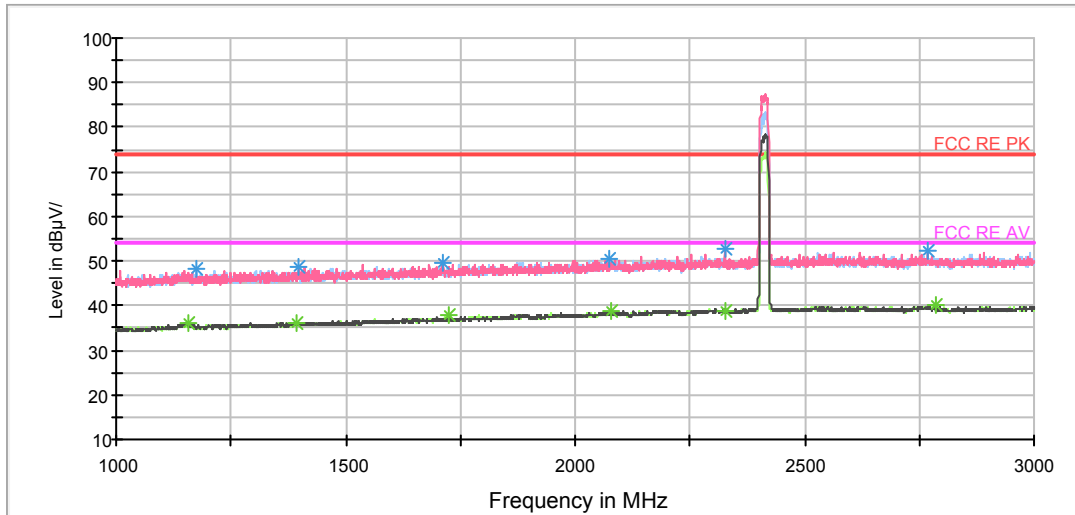

Note: The signal beyond the limit is carrier.
Radiates Emission from 1GHz to 3GHz

RE 3-18GHz PK+AV

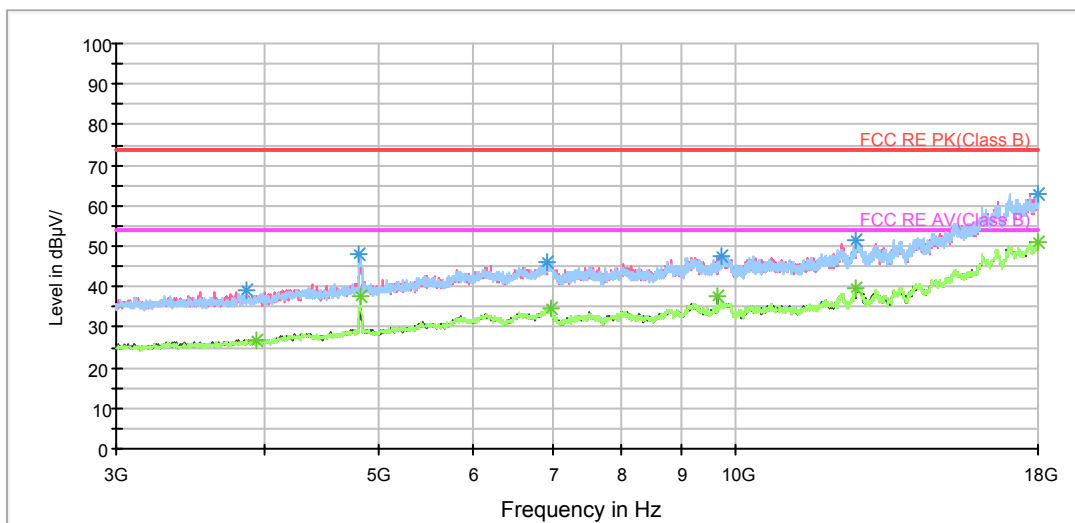

Radiates Emission from 3GHz to 18GHz

RE 18-26.5GHz PK+AV

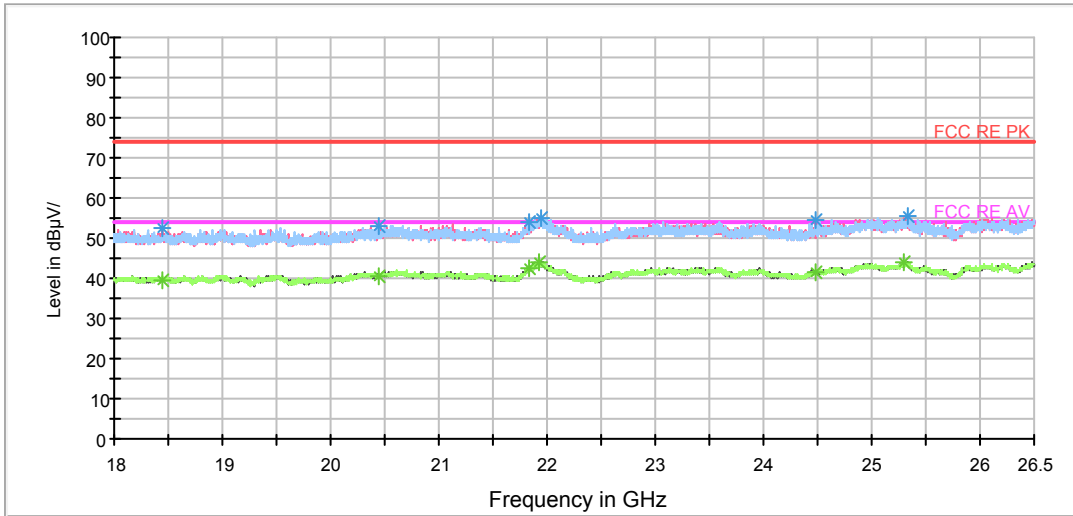

Radiates Emission from 18GHz to 26.5GHz

Frequency (MHz)	Peak (dBuV/m)	Height (cm)	Polarization	Azimuth (deg)	Reading value (dBuV/m)	Correct Factor (dB)	Margin (dB)	Limit (dBuV/m)
1173.500000	48.1	100.0	H	305.0	45.7	2.4	25.9	74
1399.500000	48.7	100.0	V	3.0	45.6	3.1	25.3	74
1710.000000	49.8	100.0	V	161.0	45.7	4.1	24.2	74
2073.500000	50.5	100.0	H	0.0	45.0	5.5	23.5	74
2325.500000	52.7	100.0	V	15.0	46.2	6.5	21.3	74
2769.000000	52.3	100.0	V	3.0	44.9	7.4	21.7	74

Remark: 1. Correction Factor = Antenna factor+ Insertion loss (cable loss + amplifier gain)

Frequency (MHz)	Average (dBuV/m)	Height (cm)	Polarization	Azimuth (deg)	Reading value (dBuV/m)	Correct Factor (dB)	Margin (dB)	Limit (dBuV/m)
1155.500000	36.3	100.0	V	32.0	34.0	2.3	17.7	54
1395.000000	36.3	100.0	V	0.0	33.3	3.0	17.7	54
1725.000000	38.0	100.0	H	11.0	33.8	4.2	16.0	54
2078.000000	38.6	100.0	H	357.0	33.1	5.5	15.4	54
2325.500000	39.0	100.0	V	15.0	32.5	6.5	15.0	54
2784.000000	40.0	100.0	H	249.0	32.6	7.4	14.0	54

Remark: 1. Correction Factor = Antenna factor+ Insertion loss (cable loss + amplifier gain)

802.11n (HT20) CH6

RE 1G-6GHz PK+AV Class B

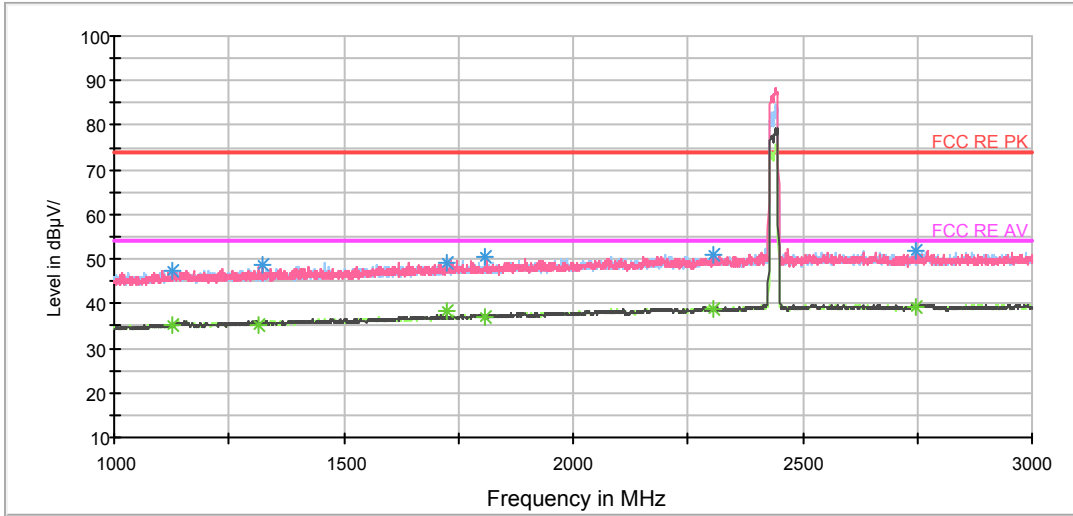

Note: The signal beyond the limit is carrier.
Radiates Emission from 1GHz to 3GHz

RE 3-18GHz PK+AV

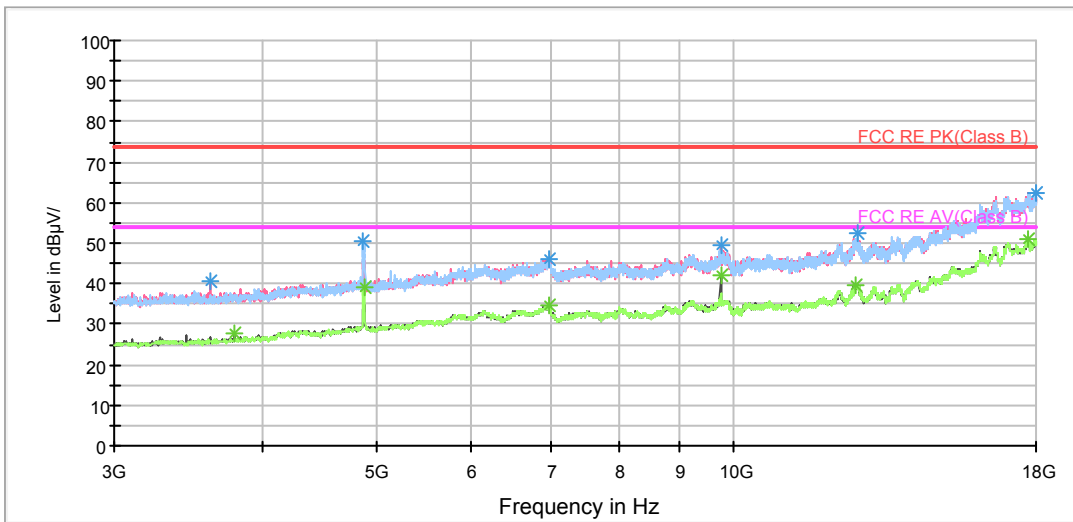

Radiates Emission from 3GHz to 18GHz

RE 18-26.5GHz PK+AV

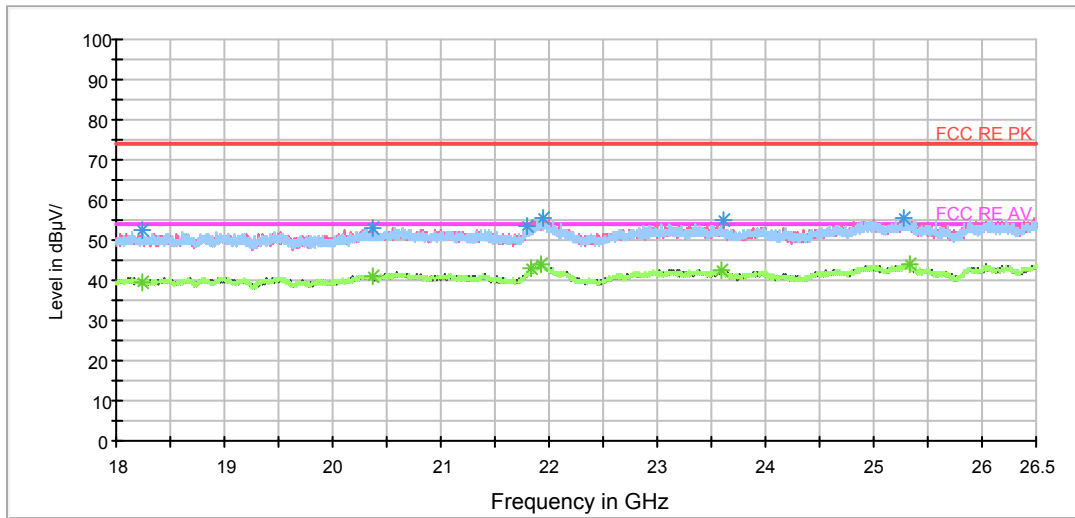

Radiates Emission from 18GHz to 26.5GHz

Frequency (MHz)	Peak (dBuV/m)	Height (cm)	Polarization	Azimuth (deg)	Reading value (dBuV/m)	Correct Factor (dB)	Margin (dB)	Limit (dBuV/m)
1127.500000	47.5	100.0	V	222.0	45.3	2.2	26.5	74
1323.000000	48.6	100.0	V	117.0	45.8	2.8	25.4	74
1725.000000	49.1	100.0	H	0.0	44.9	4.2	24.9	74
1808.000000	50.5	100.0	H	226.0	46.0	4.5	23.5	74
2305.000000	51.1	100.0	V	0.0	44.7	6.4	22.9	74
2747.000000	51.8	100.0	V	140.0	44.4	7.4	22.2	74

Remark: 1. Correction Factor = Antenna factor+ Insertion loss (cable loss + amplifier gain)

Frequency (MHz)	Average (dBuV/m)	Height (cm)	Polarization	Azimuth (deg)	Reading value (dBuV/m)	Correct Factor (dB)	Margin (dB)	Limit (dBuV/m)
1127.500000	35.1	100.0	V	222.0	32.9	2.2	18.9	54
1316.500000	35.4	100.0	V	29.0	32.6	2.8	18.6	54
1725.000000	38.3	100.0	H	0.0	34.1	4.2	15.7	54
1808.000000	37.0	100.0	H	226.0	32.5	4.5	17.0	54
2305.000000	38.9	100.0	V	0.0	32.5	6.4	15.1	54
2747.000000	39.4	100.0	V	140.0	32.0	7.4	14.6	54

Remark: 1. Correction Factor = Antenna factor+ Insertion loss (cable loss + amplifier gain)

802.11n (HT20) CH11

RE 1G-6GHz PK+AV Class B

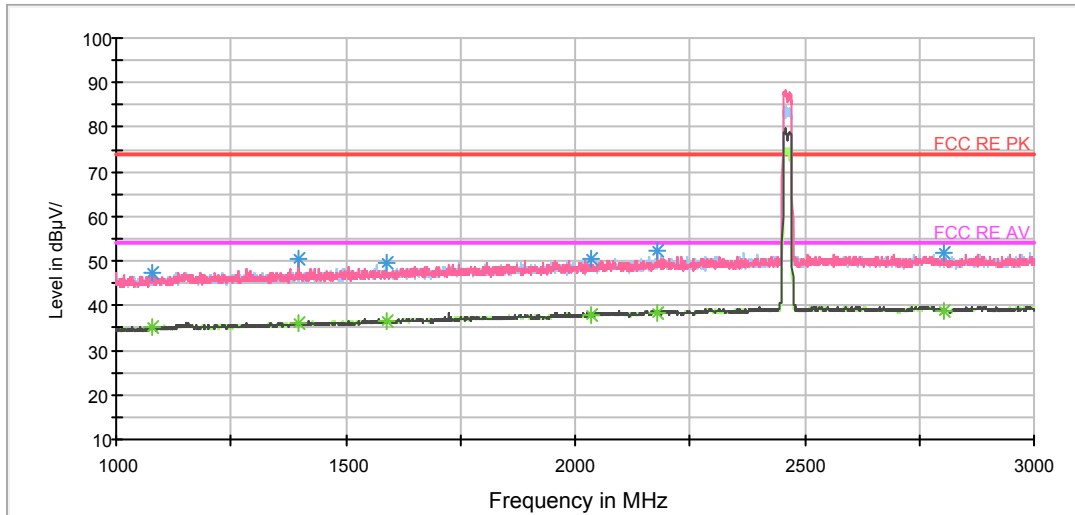

Note: The signal beyond the limit is carrier.
Radiates Emission from 1GHz to 3GHz

RE 3-18GHz PK+AV

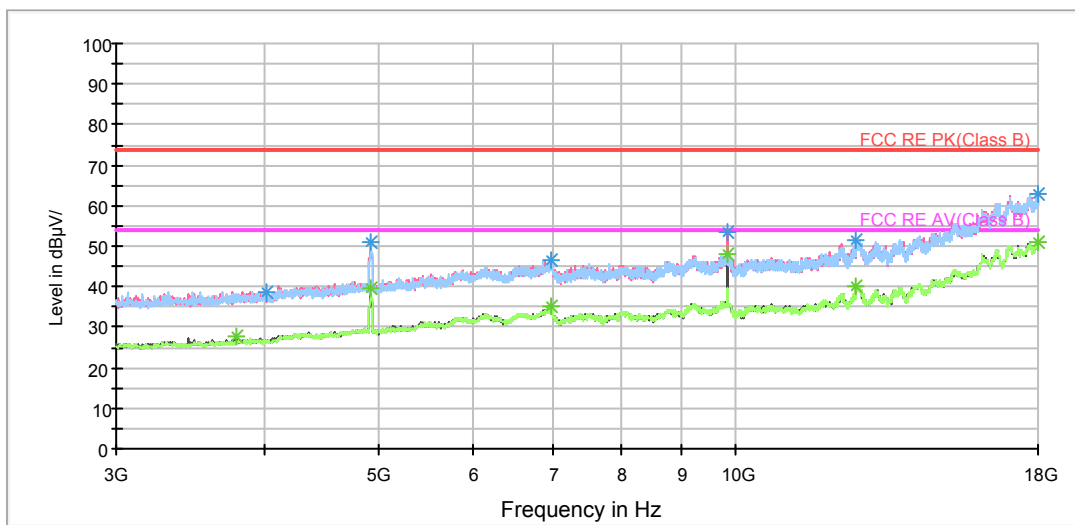

Radiates Emission from 3GHz to 18GHz

RE 18-26.5GHz PK+AV

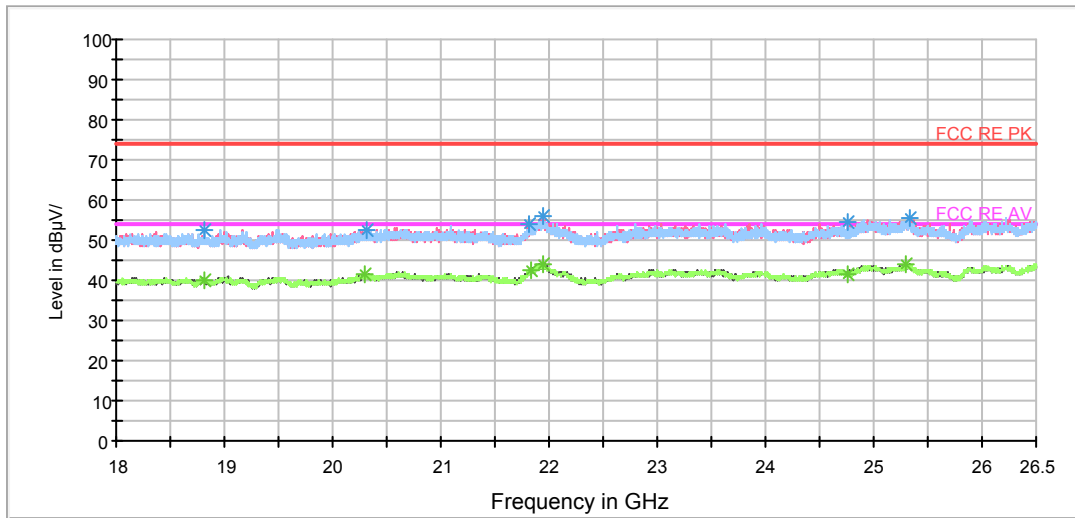

Radiates Emission from 18GHz to 26.5GHz

Frequency (MHz)	Peak (dBuV/m)	Height (cm)	Polarization	Azimuth (deg)	Reading value (dBuV/m)	Correct Factor (dB)	Margin (dB)	Limit (dBuV/m)
1077.000000	47.3	100.0	H	353.0	45.2	2.1	26.7	74
1397.000000	50.4	100.0	V	0.0	47.3	3.1	23.6	74
1587.500000	49.4	100.0	H	243.0	45.7	3.7	24.6	74
2034.000000	50.5	100.0	V	0.0	45.2	5.3	23.5	74
2180.000000	52.2	100.0	V	148.0	46.3	5.9	21.8	74
2804.000000	51.9	100.0	V	4.0	44.5	7.4	22.1	74

Remark: 1. Correction Factor = Antenna factor+ Insertion loss (cable loss + amplifier gain)

Frequency (MHz)	Average (dBuV/m)	Height (cm)	Polarization	Azimuth (deg)	Reading value (dBuV/m)	Correct Factor (dB)	Margin (dB)	Limit (dBuV/m)
1077.000000	35.0	100.0	H	353.0	32.9	2.1	19.0	54
1397.000000	36.0	100.0	V	0.0	32.9	3.1	18.0	54
1587.500000	36.4	100.0	H	243.0	32.7	3.7	17.6	54
2034.000000	37.8	100.0	V	0.0	32.5	5.3	16.2	54
2180.000000	38.6	100.0	V	148.0	32.7	5.9	15.4	54
2804.000000	38.9	100.0	V	4.0	31.5	7.4	15.1	54

Remark: 1. Correction Factor = Antenna factor+ Insertion loss (cable loss + amplifier gain)

802.11n (HT40) CH3

RE 1G-6GHz PK+AV Class B

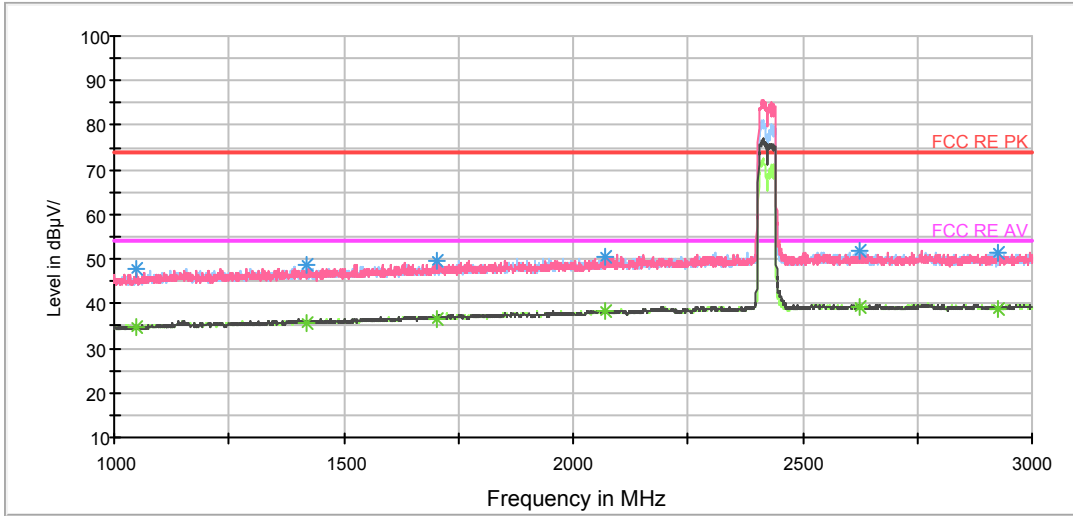

Note: The signal beyond the limit is carrier.
Radiates Emission from 1GHz to 3GHz

RE 3-18GHz PK+AV

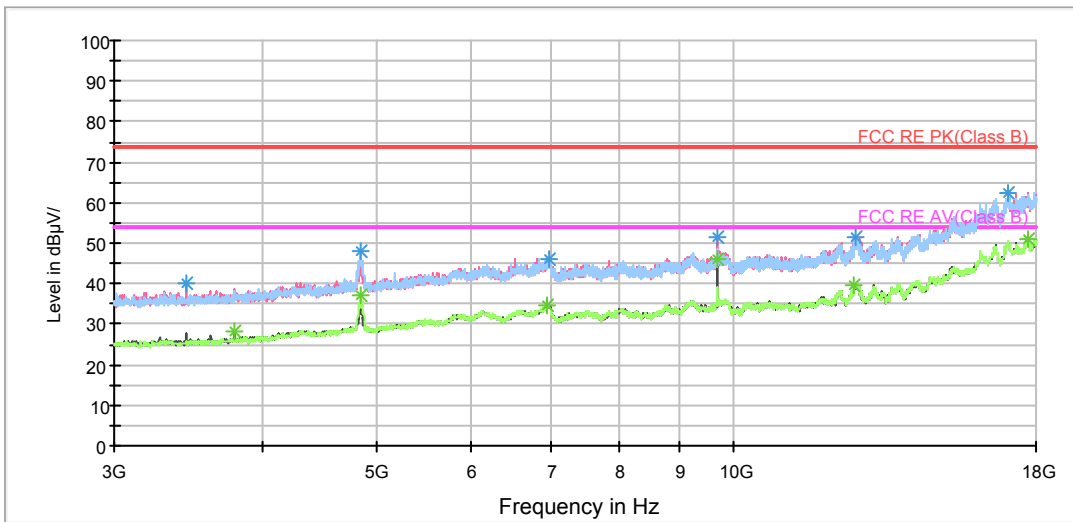

Radiates Emission from 3GHz to 18GHz

RE 18-26.5GHz PK+AV

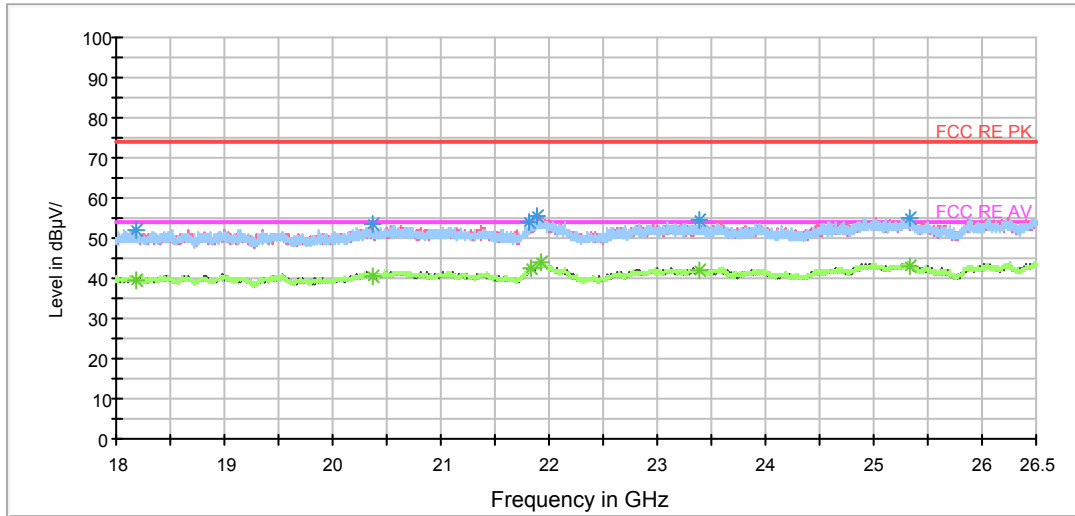

Radiates Emission from 18GHz to 26.5GHz

Frequency (MHz)	Peak (dBuV/m)	Height (cm)	Polarization	Azimuth (deg)	Reading value (dBuV/m)	Correct Factor (dB)	Margin (dB)	Limit (dBuV/m)
1047.500000	47.9	100.0	H	323.0	45.9	2.0	26.1	74
1417.500000	48.5	100.0	H	342.0	45.4	3.1	25.5	74
1704.000000	49.4	100.0	H	114.0	45.3	4.1	24.6	74
2070.500000	50.5	100.0	H	359.0	45.0	5.5	23.5	74
2626.500000	51.8	100.0	V	17.0	44.5	7.3	22.2	74
2926.500000	51.5	100.0	V	148.0	44.0	7.5	22.5	74

Remark: 1. Correction Factor = Antenna factor+ Insertion loss (cable loss + amplifier gain)

Frequency (MHz)	Average (dBuV/m)	Height (cm)	Polarization	Azimuth (deg)	Reading value (dBuV/m)	Correct Factor (dB)	Margin (dB)	Limit (dBuV/m)
1047.500000	34.9	100.0	H	323.0	32.9	2.0	19.1	54
1417.500000	35.8	100.0	H	342.0	32.7	3.1	18.2	54
1704.000000	36.7	100.0	H	114.0	32.6	4.1	17.3	54
2070.500000	38.5	100.0	H	359.0	33.0	5.5	15.5	54
2626.500000	39.3	100.0	V	17.0	32.0	7.3	14.7	54
2926.500000	38.8	100.0	V	148.0	31.3	7.5	15.2	54

Remark: 1. Correction Factor = Antenna factor+ Insertion loss (cable loss + amplifier gain)

802.11n (HT40) CH6

RE 1G-6GHz PK+AV Class B

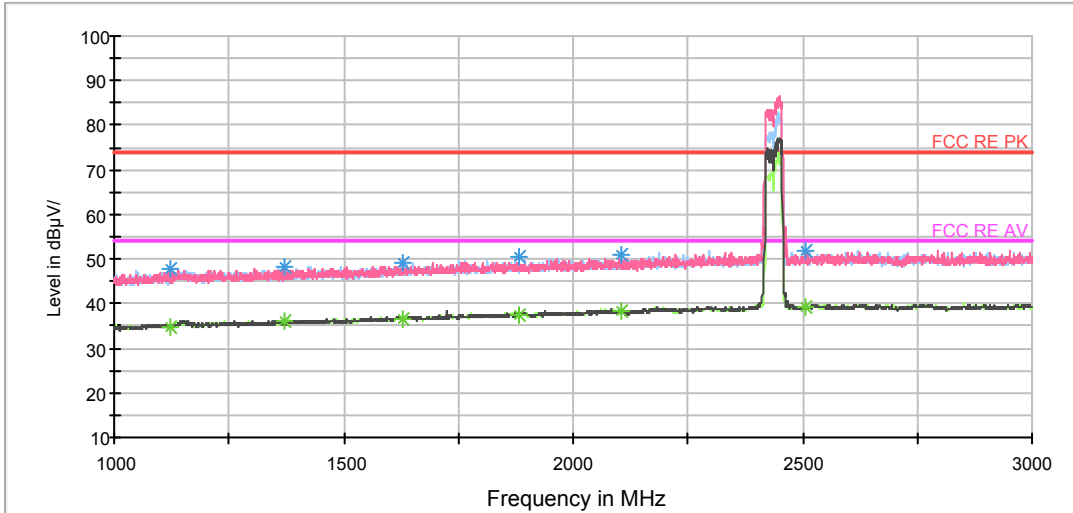

Note: The signal beyond the limit is carrier.
Radiates Emission from 1GHz to 3GHz

RE 3-18GHz PK+AV

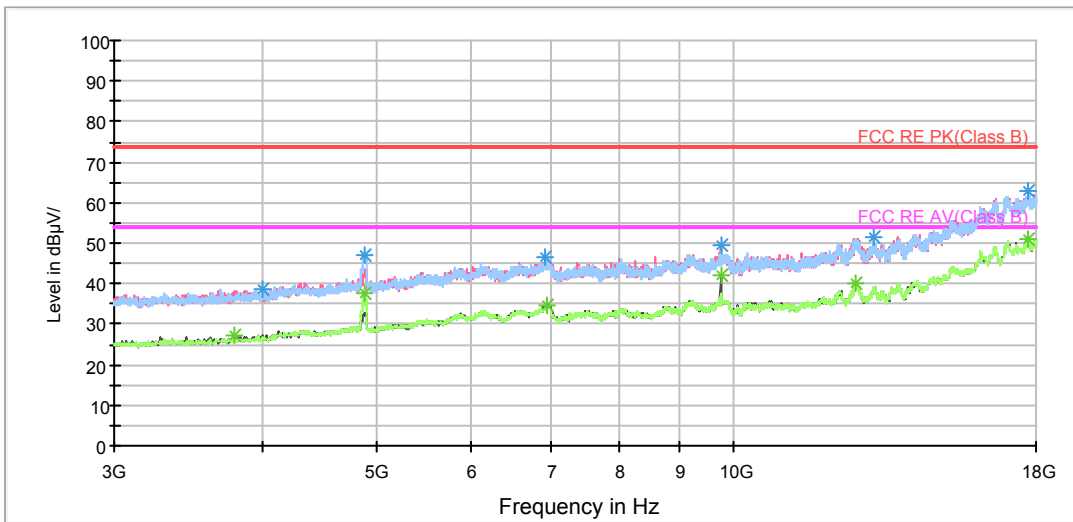

Radiates Emission from 3GHz to 18GHz

RE 18-26.5GHz PK+AV

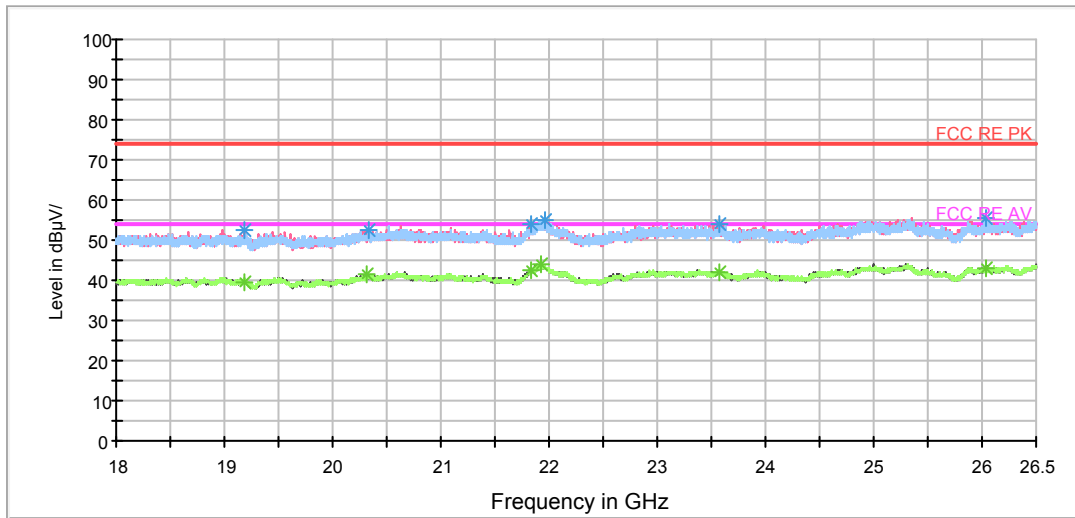

Radiates Emission from 18GHz to 26.5GHz

Frequency (MHz)	Peak (dBuV/m)	Height (cm)	Polarization	Azimuth (deg)	Reading value (dBuV/m)	Correct Factor (dB)	Margin (dB)	Limit (dBuV/m)
1123.000000	48.0	100.0	V	349.0	45.8	2.2	26.0	74
1370.000000	48.5	100.0	V	1.0	45.5	3.0	25.5	74
1627.500000	49.0	100.0	V	0.0	45.2	3.8	25.0	74
1881.500000	50.4	100.0	V	230.0	45.6	4.8	23.6	74
2106.500000	51.0	100.0	H	211.0	45.4	5.6	23.0	74
2508.000000	51.9	100.0	V	66.0	44.7	7.2	22.1	74

Remark: 1. Correction Factor = Antenna factor+ Insertion loss (cable loss + amplifier gain)

Frequency (MHz)	Average (dBuV/m)	Height (cm)	Polarization	Azimuth (deg)	Reading value (dBuV/m)	Correct Factor (dB)	Margin (dB)	Limit (dBuV/m)
1123.000000	34.9	100.0	V	349.0	32.7	2.2	19.1	54
1370.000000	35.9	100.0	V	1.0	32.9	3.0	18.1	54
1629.000000	36.4	100.0	H	359.0	32.6	3.8	17.6	54
1881.500000	37.5	100.0	V	230.0	32.7	4.8	16.5	54
2106.500000	38.2	100.0	H	211.0	32.6	5.6	15.8	54
2508.000000	39.2	100.0	V	66.0	32.0	7.2	14.8	54

Remark: 1. Correction Factor = Antenna factor+ Insertion loss (cable loss + amplifier gain)

802.11n (HT40) CH9

RE 1G-6GHz PK+AV Class B

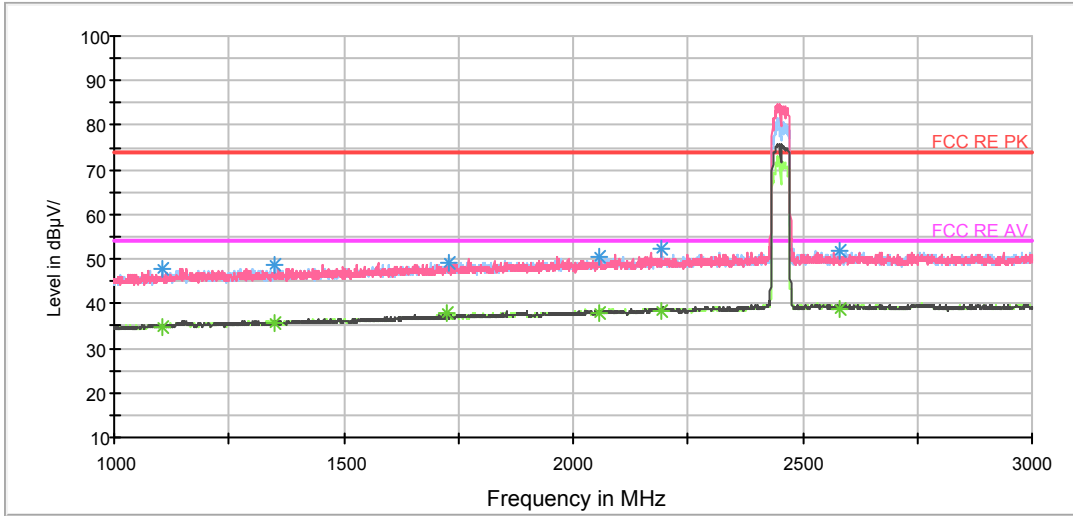

Note: The signal beyond the limit is carrier.
Radiates Emission from 1GHz to 3GHz

RE 3-18GHz PK+AV

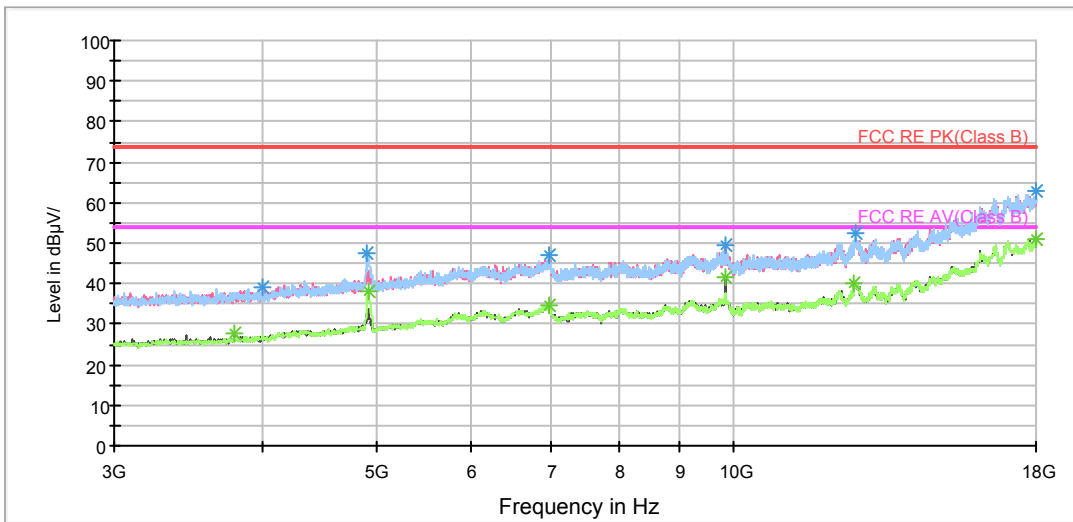

Radiates Emission from 3GHz to 18GHz

RE 18-26.5GHz PK+AV

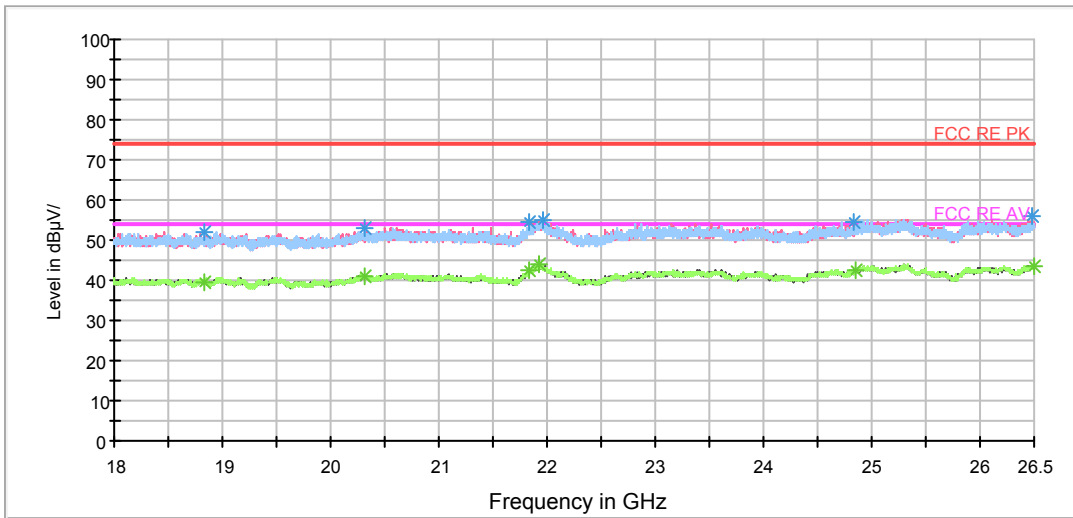

Radiates Emission from 18GHz to 26.5GHz

Frequency (MHz)	Peak (dBuV/m)	Height (cm)	Polarization	Azimuth (deg)	Reading value (dBuV/m)	Correct Factor (dB)	Margin (dB)	Limit (dBuV/m)
1105.000000	47.9	100.0	H	0.0	45.8	2.1	26.1	74
1350.500000	48.5	100.0	H	356.0	45.6	2.9	25.5	74
1729.500000	49.1	100.0	V	212.0	44.9	4.2	24.9	74
2056.000000	50.4	100.0	H	342.0	45.0	5.4	23.6	74
2192.500000	52.4	100.0	V	2.0	46.4	6.0	21.6	74
2582.000000	52.1	100.0	H	359.0	44.9	7.2	21.9	74

Remark: 1. Correction Factor = Antenna factor+ Insertion loss (cable loss + amplifier gain)

Frequency (MHz)	Average (dBuV/m)	Height (cm)	Polarization	Azimuth (deg)	Reading value (dBuV/m)	Correct Factor (dB)	Margin (dB)	Limit (dBuV/m)
1105.000000	34.8	100.0	H	0.0	32.7	2.1	19.2	54
1350.500000	35.6	100.0	H	356.0	32.7	2.9	18.4	54
1725.000000	38.0	100.0	H	342.0	33.8	4.2	16.0	54
2056.000000	38.0	100.0	H	342.0	32.6	5.4	16.0	54
2192.500000	38.4	100.0	V	2.0	32.4	6.0	15.6	54
2582.000000	39.0	100.0	H	359.0	31.8	7.2	15.0	54

Remark: 1. Correction Factor = Antenna factor+ Insertion loss (cable loss + amplifier gain)

BLE-Channel 0

FCC RE 1G-3GHz PK+AV Class B

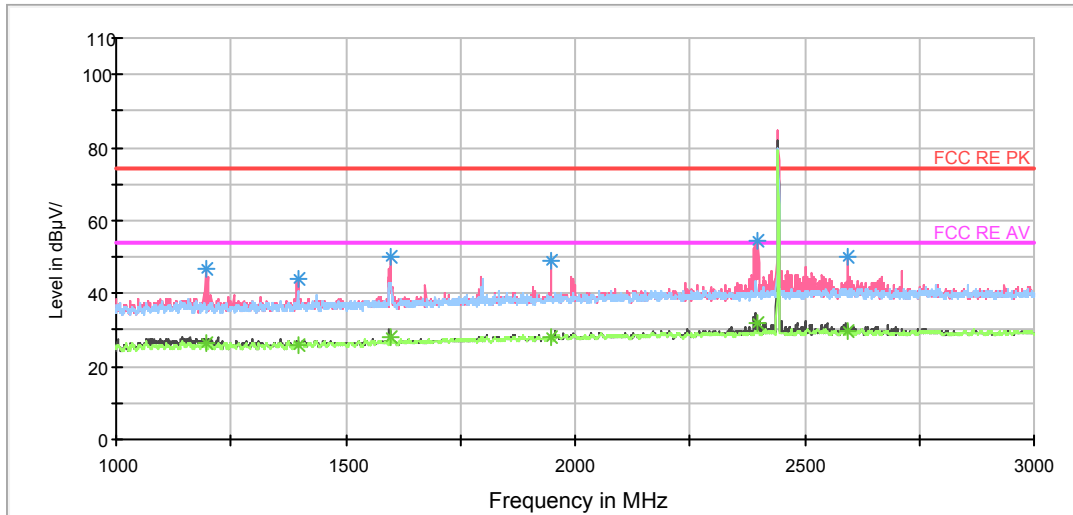

Note: The signal beyond the limit is carrier.
Radiates Emission from 1GHz to 3GHz

RE 3-18GHz PK+AV

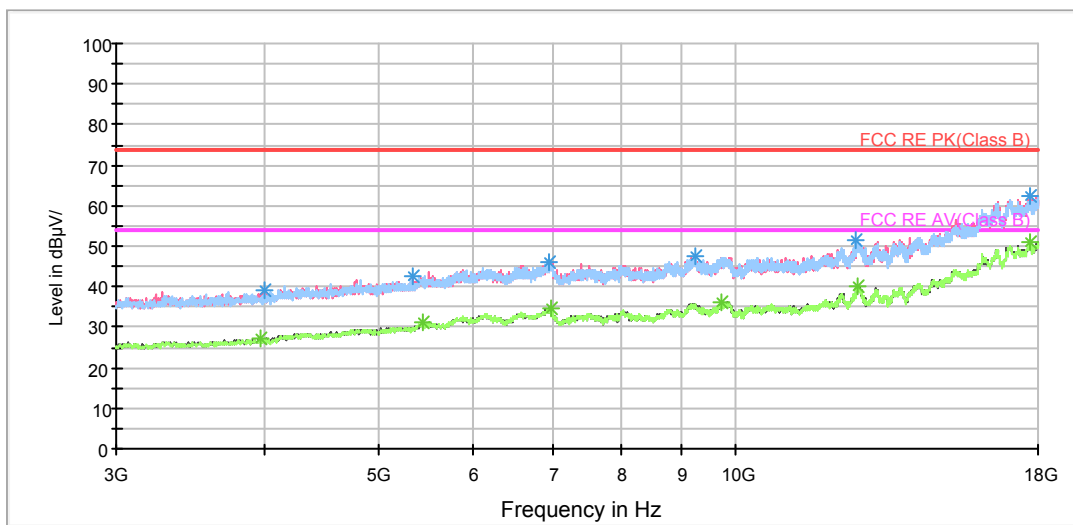

Radiates Emission from 3GHz to 18GHz



RE 18-26.5GHz PK+AV

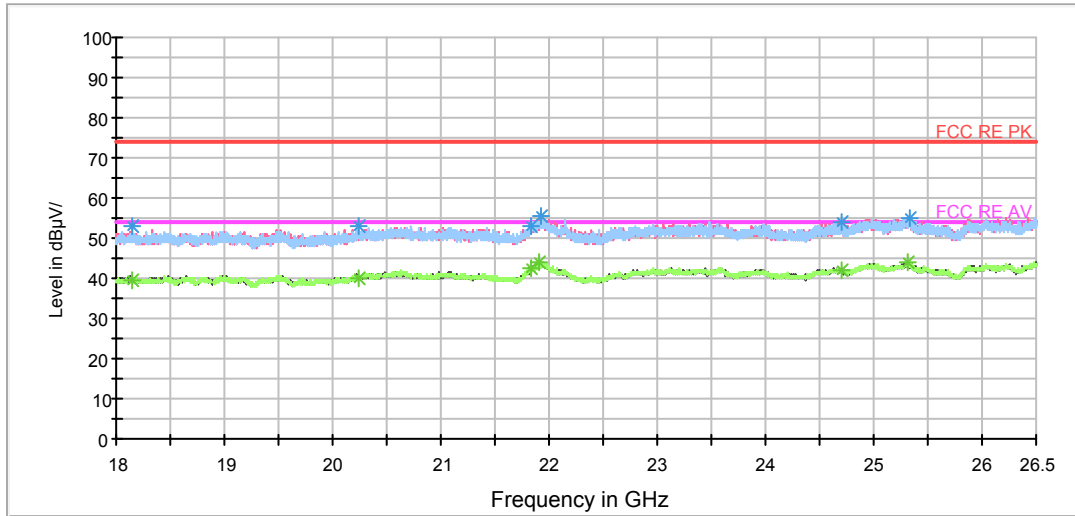

Radiates Emission from 18GHz to 26.5GHz

Frequency (MHz)	Peak (dBuV/m)	Height (cm)	Polarization	Azimuth (deg)	Reading value (dBuV/m)	Correct Factor (dB)	Margin (dB)	Limit (dBuV/m)
1194.500000	46.7	100.0	V	350.0	54.3	-7.6	27.3	74
1396.000000	43.8	100.0	V	200.0	50.8	-7.0	30.2	74
1598.500000	49.9	100.0	V	341.0	56.2	-6.3	24.1	74
1946.500000	48.9	100.0	V	313.0	53.9	-5.0	25.1	74
2399.500000	54.6	100.0	V	0.0	57.8	-3.2	19.4	74
2593.000000	50.1	100.0	V	358.0	52.9	-2.8	23.9	74

Remark: 1. Correction Factor = Antenna factor+ Insertion loss (cable loss + amplifier gain)

Frequency (MHz)	Average (dBuV/m)	Height (cm)	Polarization	Azimuth (deg)	Reading value (dBuV/m)	Correct Factor (dB)	Margin (dB)	Limit (dBuV/m)
1194.500000	26.3	100.0	V	350.0	33.9	-7.6	27.7	54
1396.000000	25.9	100.0	V	200.0	32.9	-7.0	28.1	54
1598.500000	28.1	100.0	V	341.0	34.4	-6.3	25.9	54
1946.500000	28.0	100.0	V	313.0	33.0	-5.0	26.0	54
2399.500000	31.7	100.0	V	0.0	34.9	-3.2	22.3	54
2593.000000	29.9	100.0	V	358.0	32.7	-2.8	24.1	54

Remark: 1. Correction Factor = Antenna factor+ Insertion loss (cable loss + amplifier gain)

BLE-Channel 19

FCC RE 1G-3GHz PK+AV Class B

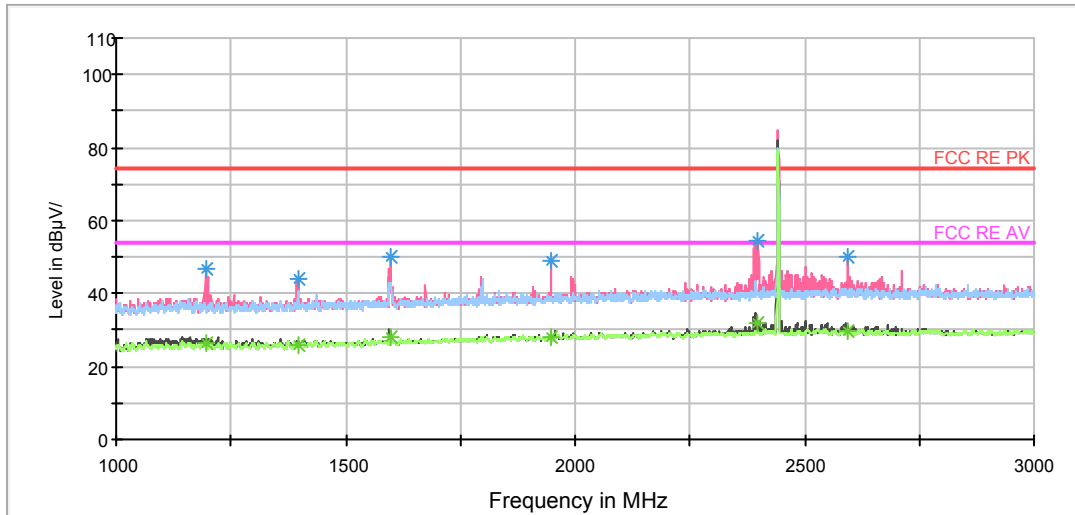

Note: The signal beyond the limit is carrier.
Radiates Emission from 1GHz to 3GHz

RE 3-18GHz PK+AV

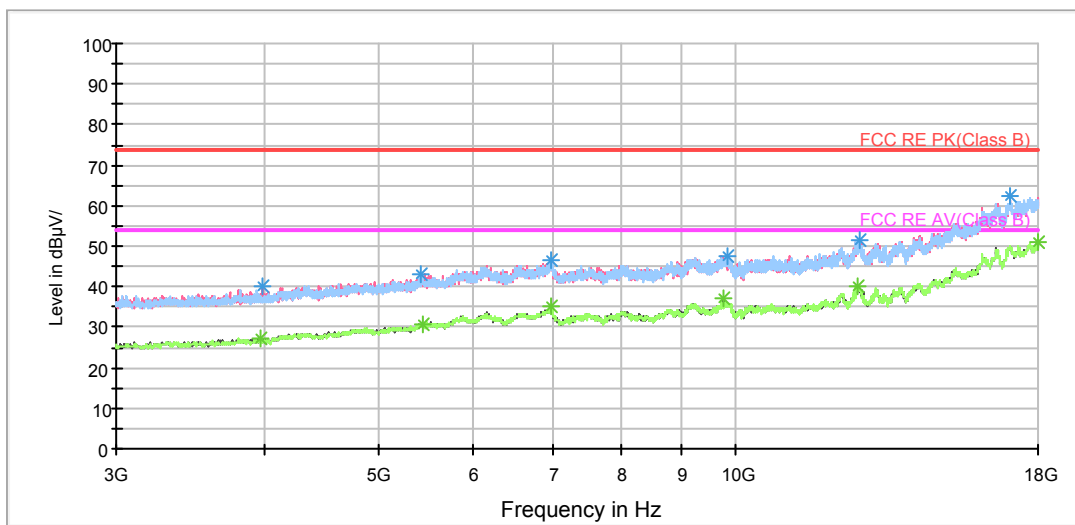

Radiates Emission from 3GHz to 18GHz

RE 18-26.5GHz PK+AV

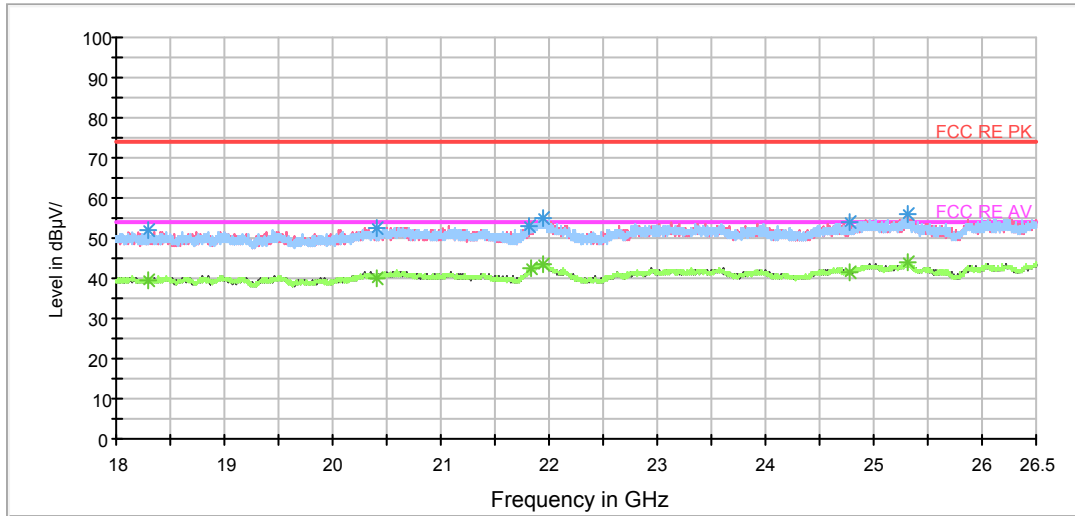

Radiates Emission from 18GHz to 26.5GHz

Frequency (MHz)	Peak (dBuV/m)	Height (cm)	Polarization	Azimuth (deg)	Reading value (dBuV/m)	Correct Factor (dB)	Margin (dB)	Limit (dBuV/m)
1194.500000	46.7	100.0	V	350.0	54.3	-7.6	27.3	74
1396.000000	43.8	100.0	V	200.0	50.8	-7.0	30.2	74
1598.500000	49.9	100.0	V	341.0	56.2	-6.3	24.1	74
1946.500000	48.9	100.0	V	313.0	53.9	-5.0	25.1	74
2399.500000	54.6	100.0	V	0.0	57.8	-3.2	19.4	74
2593.000000	50.1	100.0	V	358.0	52.9	-2.8	23.9	74

Remark: 1. Correction Factor = Antenna factor+ Insertion loss (cable loss + amplifier gain)

Frequency (MHz)	Average (dBuV/m)	Height (cm)	Polarization	Azimuth (deg)	Reading value (dBuV/m)	Correct Factor (dB)	Margin (dB)	Limit (dBuV/m)
1194.500000	26.3	100.0	V	350.0	33.9	-7.6	27.7	54
1396.000000	25.9	100.0	V	200.0	32.9	-7.0	28.1	54
1598.500000	28.1	100.0	V	341.0	34.4	-6.3	25.9	54
1946.500000	28.0	100.0	V	313.0	33.0	-5.0	26.0	54
2399.500000	31.7	100.0	V	0.0	34.9	-3.2	22.3	54
2593.000000	29.9	100.0	V	358.0	32.7	-2.8	24.1	54

Remark: 1. Correction Factor = Antenna factor+ Insertion loss (cable loss + amplifier gain)

BLE-Channel 39

FCC RE 1G-3GHz PK+AV Class B

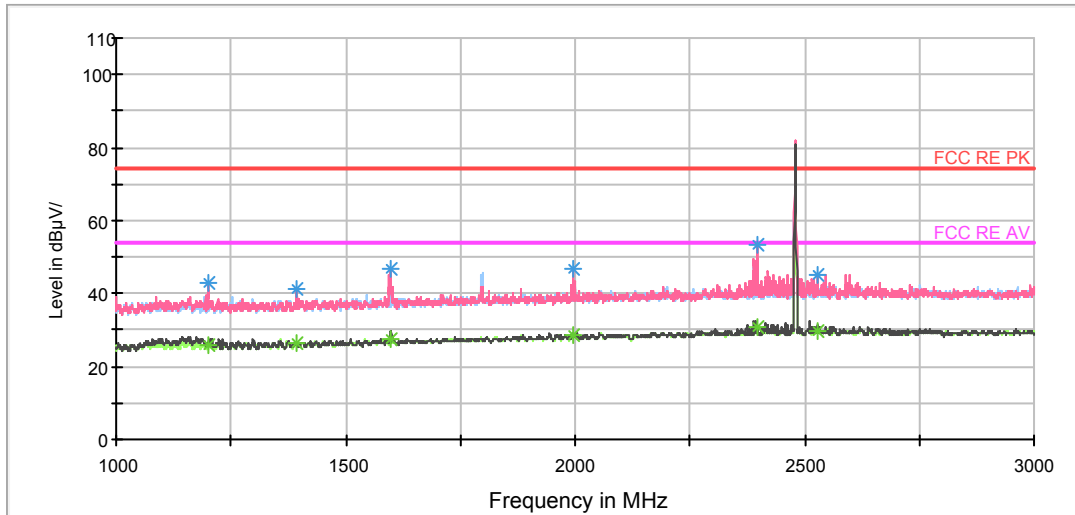

Note: The signal beyond the limit is carrier.
Radiates Emission from 1GHz to 3GHz

RE 3-18GHz PK+AV

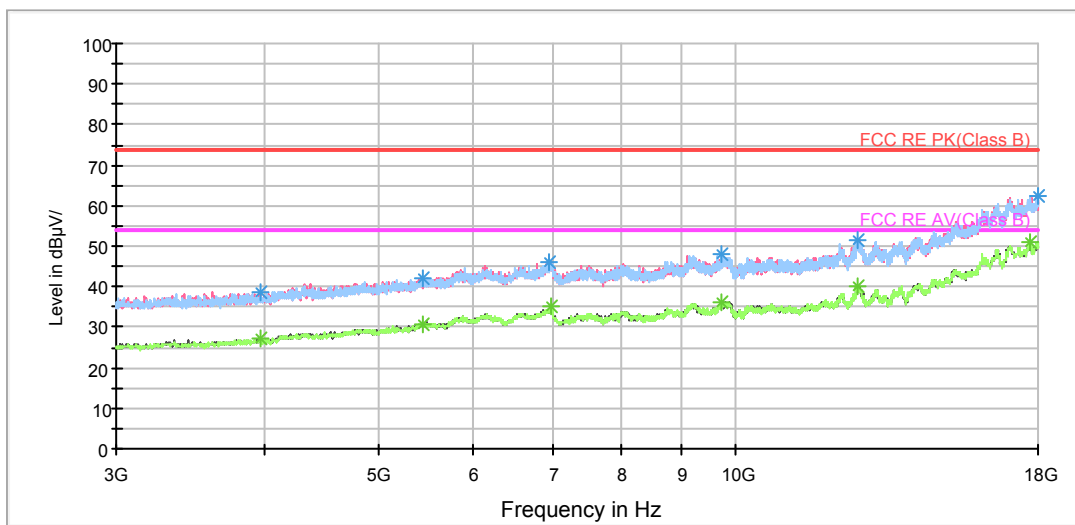

Radiates Emission from 3GHz to 18GHz

RE 18-26.5GHz PK+AV

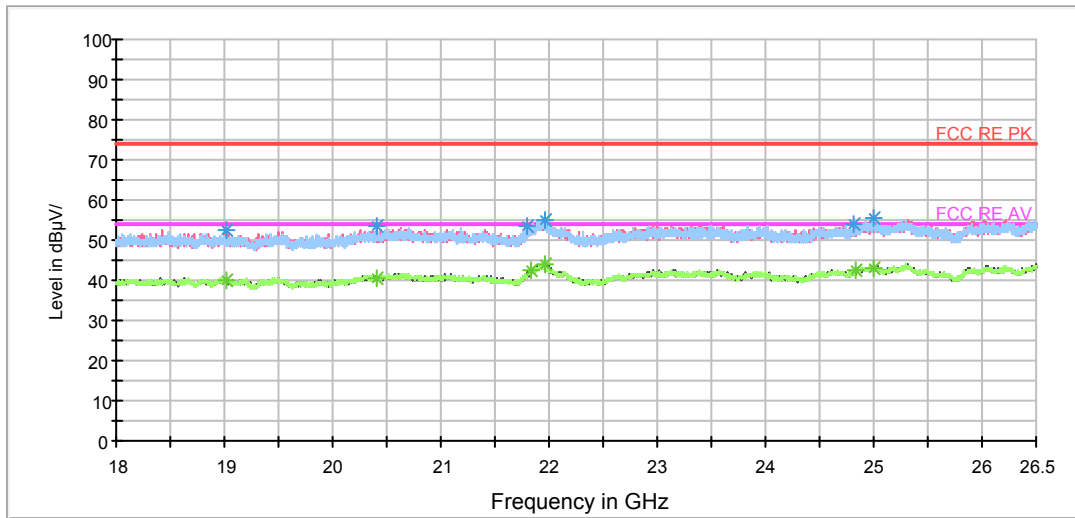

Radiates Emission from 18GHz to 26.5GHz

Frequency (MHz)	Peak (dBuV/m)	Height (cm)	Polarization	Azimuth (deg)	Reading value (dBuV/m)	Correct Factor (dB)	Margin (dB)	Limit (dBuV/m)
1199.500000	43.0	100.0	V	295.0	50.6	-7.6	31.0	74
1393.500000	41.4	100.0	V	303.0	48.4	-7.0	32.6	74
1599.000000	46.7	100.0	V	0.0	53.0	-6.3	27.3	74
1996.500000	46.6	100.0	V	2.0	51.4	-4.8	27.4	74
2397.000000	53.2	100.0	V	2.0	56.4	-3.2	20.8	74
2528.000000	45.3	100.0	V	0.0	48.1	-2.8	28.7	74

Remark: 1. Correction Factor = Antenna factor+ Insertion loss (cable loss + amplifier gain)

Frequency (MHz)	Average (dBuV/m)	Height (cm)	Polarization	Azimuth (deg)	Reading value (dBuV/m)	Correct Factor (dB)	Margin (dB)	Limit (dBuV/m)
1199.500000	26.0	100.0	V	295.0	33.6	-7.6	28.0	54
1393.500000	26.2	100.0	V	303.0	33.2	-7.0	27.8	54
1597.500000	27.7	100.0	V	244.0	34.0	-6.3	26.3	54
1996.500000	28.6	100.0	V	2.0	33.4	-4.8	25.4	54
2397.000000	30.8	100.0	V	2.0	34.0	-3.2	23.2	54
2528.000000	29.4	100.0	V	0.0	32.2	-2.8	24.6	54

Remark: 1. Correction Factor = Antenna factor+ Insertion loss (cable loss + amplifier gain)

5.8. Conducted Emission

Ambient condition

Temperature	Relative humidity	Pressure
23°C ~25°C	45%~50%	101.5kPa

Methods of Measurement

The EUT is placed on a non-metallic table of 80cm height above the horizontal metal reference ground plane. During the test, the EUT was operating in its typical mode. The test method is according to ANSI C63.10-2013. Connect the AC power line of the EUT to the L.I.S.N. Use EMI receiver to detect the average and Quasi-peak value. RBW is set to 9 kHz, VBW is set to 30kHz. The measurement result should include both L line and N line.

The test is in transmitting mode.

Test Setup

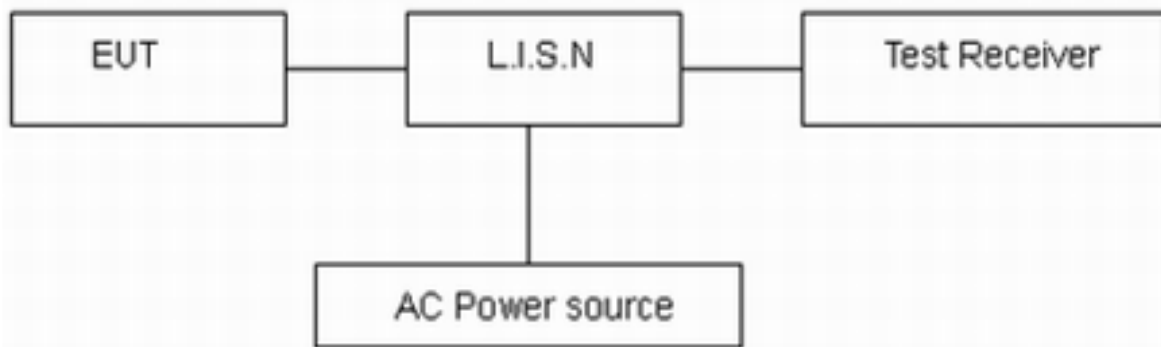

Note: AC Power source is used to change the voltage 110V/60Hz.

Limits

Frequency (MHz)	Conducted Limits(dBμV)	
	Quasi-peak	Average
0.15 - 0.5	66 to 56 *	56 to 46*
0.5 - 5	56	46
5 - 30	60	50

*: Decreases with the logarithm of the frequency.

Measurement Uncertainty

The assessed measurement uncertainty to ensure 95% confidence level for the normal distribution is with the coverage factor $k = 1.96$, $U = 2.69$ dB.

Test Results:

Following plots, Blue trace uses the peak detection and Green trace uses the average detection. During the test, the Conducted Emission was performed in all modes with all channels, 802.11b, Channel 11 are selected as the worst condition. The test data of the worst-case condition was recorded in this report.

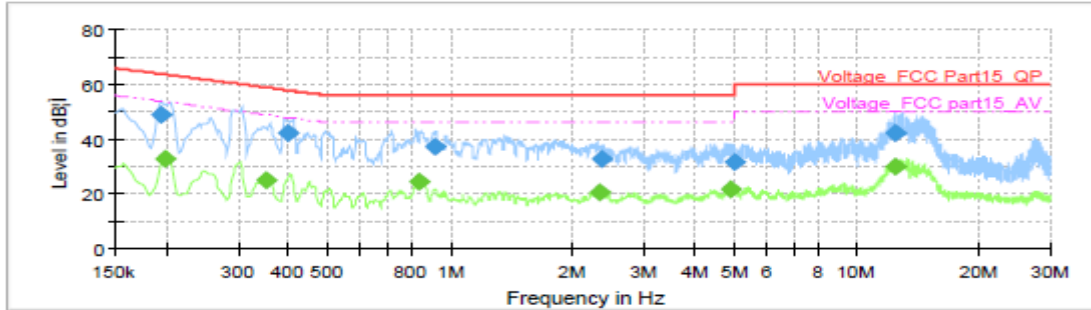

Frequency (MHz)	QuasiPeak (dB; i V)	Average (dB; i V)	Limit (dB; i V)	Margin (dB)	Meas. Time (ms)	Bandwidth (kHz)	Line	Filter	Corr. (dB)
0.195000	48.86	---	63.82	14.96	1000.0	9.000	L1	ON	19.5
0.199500	---	32.79	53.63	20.84	1000.0	9.000	L1	ON	19.5
0.352500	---	25.01	48.90	23.89	1000.0	9.000	L1	ON	19.5
0.397500	42.21	---	57.91	15.69	1000.0	9.000	L1	ON	19.5
0.840750	---	24.54	46.00	21.46	1000.0	9.000	L1	ON	19.5
0.921750	37.37	---	56.00	18.63	1000.0	9.000	L1	ON	19.5
2.337000	---	20.53	46.00	25.47	1000.0	9.000	L1	ON	19.5
2.348250	32.94	---	56.00	23.06	1000.0	9.000	L1	ON	19.5
4.911000	---	21.48	46.00	24.52	1000.0	9.000	L1	ON	19.6
4.994250	31.58	---	56.00	24.42	1000.0	9.000	L1	ON	19.6
12.439500	---	29.89	50.00	20.11	1000.0	9.000	L1	ON	19.7
12.444000	42.33	---	60.00	17.67	1000.0	9.000	L1	ON	19.7

L Line

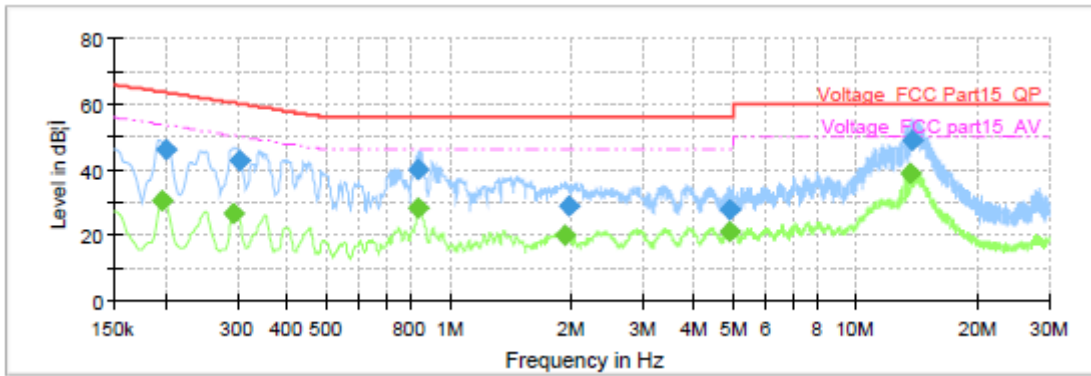

Frequency (MHz)	QuasiPeak (dB; i V)	Average (dB; i V)	Limit (dB; i V)	Margin (dB)	Meas. Time (ms)	Bandwidth (kHz)	Line	Filter	Corr. (dB)
0.197250	---	30.49	53.73	23.24	1000.0	9.000	N	ON	19.5
0.201750	45.94	---	63.54	17.59	1000.0	9.000	N	ON	19.5
0.296250	---	26.42	50.35	23.92	1000.0	9.000	N	ON	19.5
0.303000	43.05	---	60.16	17.11	1000.0	9.000	N	ON	19.5
0.838500	---	28.45	46.00	17.55	1000.0	9.000	N	ON	19.5
0.840750	40.04	---	56.00	15.96	1000.0	9.000	N	ON	19.5
1.932000	---	19.77	46.00	26.23	1000.0	9.000	N	ON	19.5
1.972500	29.09	---	56.00	26.91	1000.0	9.000	N	ON	19.5
4.884000	---	21.02	46.00	24.98	1000.0	9.000	N	ON	19.6
4.890750	27.55	---	56.00	28.45	1000.0	9.000	N	ON	19.6
13.708500	---	39.09	50.00	10.91	1000.0	9.000	N	ON	19.7
13.807500	49.07	---	60.00	10.93	1000.0	9.000	N	ON	19.7

N Line



6. Main Test Instruments

Name	Manufacturer	Type	Serial Number	Calibration Date	Expiration Date
Spectrum Analyzer	R&S	FSV30	100815	2016-12-16	2017-12-15
EMI Test Receiver	R&S	ESCI	100948	2017-05-20	2018-05-19
TRILOG Broadband Antenna	Schwarzbeck	VULB 9163	9163-201	2014-12-06	2017-12-05
Double Ridged Waveguide Horn Antenna	R&S	HF907	100126	2014-12-06	2017-12-05
Loop Antenna	SCHWARZBECK	FMZB1519	1519-047	2017-02-18	2020-02-17
Standard Gain Horn	ETS-Lindgren	3160-09	00102644	2015-01-30	2018-01-29
EMI Test Receiver	R&S	ESCS30	100138	2016-12-16	2017-12-15
LISN	R&S	ENV216	101171	2016-12-16	2019-12-15
Spectrum Analyzer	Agilent	N9010A	MY47191109	2017-05-20	2018-05-19
Power meter	R&S	NRP2	1144.1374K02 -104306-EX	2016-12-22	2017-12-21
Power Sensor	R&S	NRP-Z21	104799	2016-12-22	2017-12-21
RF Cable	Agilent	SMA 15cm	0001	2017-08-04	2018-02-03
Software (CE)	ROHDE&SCHW ARZ	ESXS-K1	2.2	/	/
Software (RE/RSE)	ROHDE&SCHW ARZ	EMC32	8.52.0	/	/

*****END OF REPORT *****

ANNEX A: EUT Appearance and Test Setup

A.1 EUT Appearance



Front Side



Back Side

For Single Screen Mode



Front Side



Back Side

**For Double Screen Mode
Picture 1 EUT and Accessory**

A.2 Test Setup

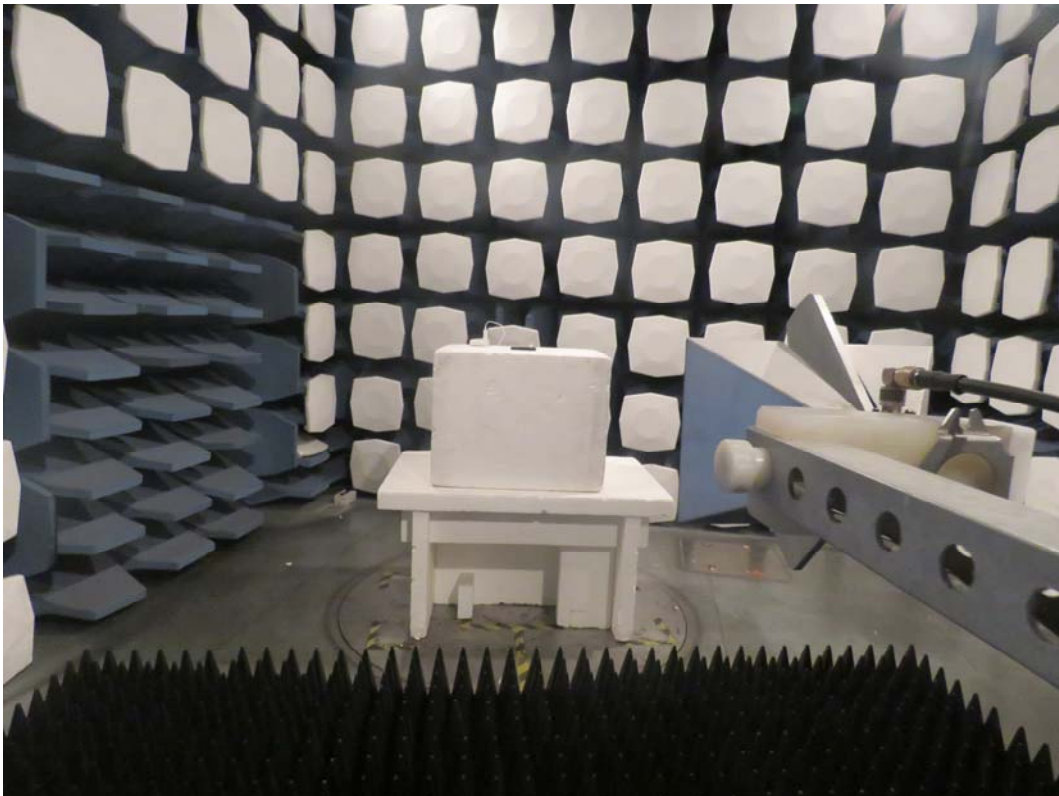
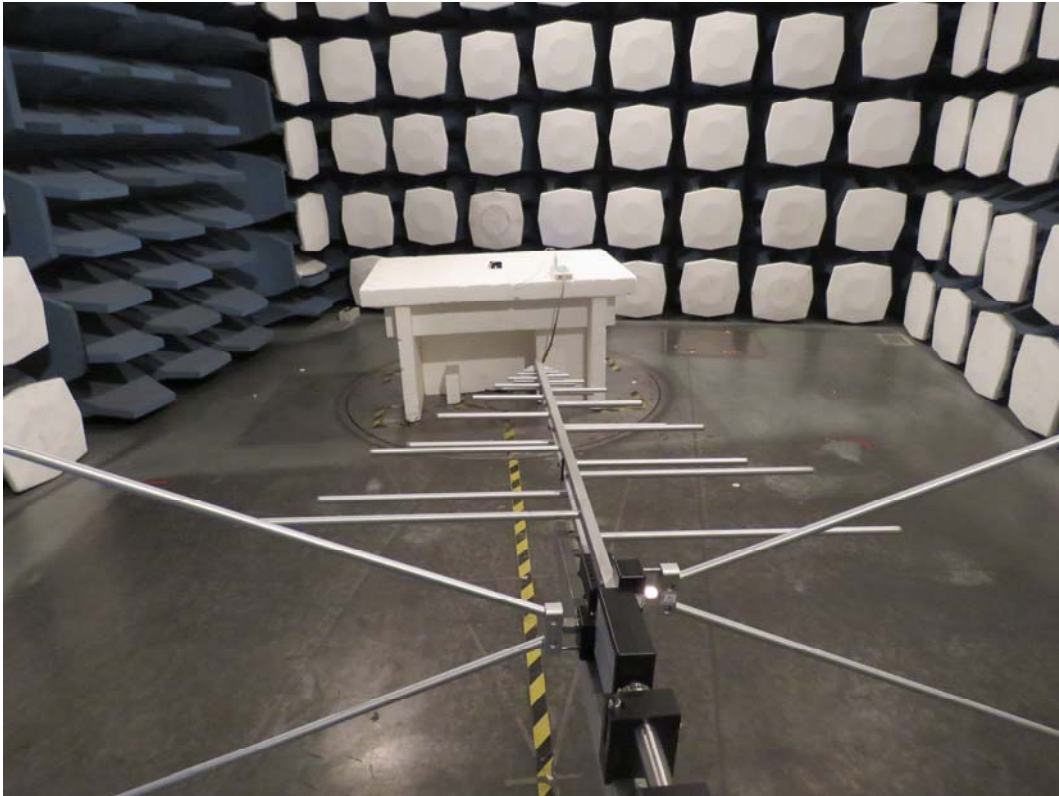

Picture 2 Radiated Emission Test Setup



Picture 3 Conducted Emission Test Setup