

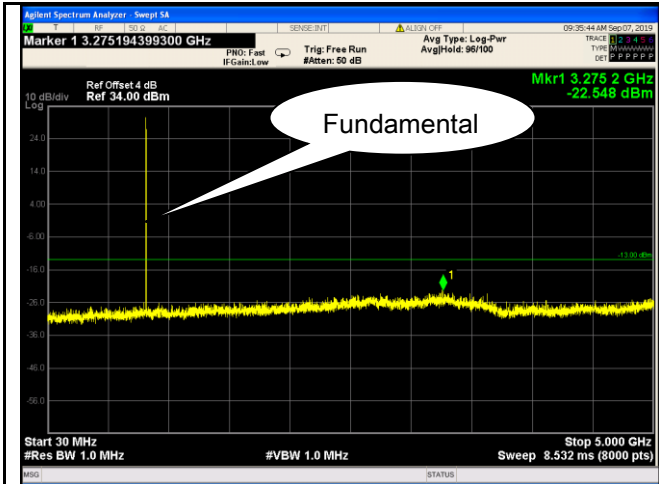

BUREAU VERITAS

Test Report No.	Q200102S012 -FCC-R1
Page	46 of 91

EGPRS (MSC 1): Cellular Band (Part 22H) result



GSM 850 - Low Channel

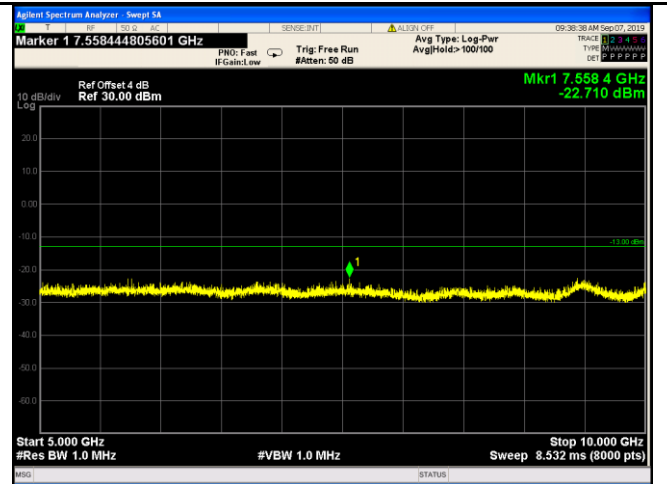

GSM 850 - Low Channel-1

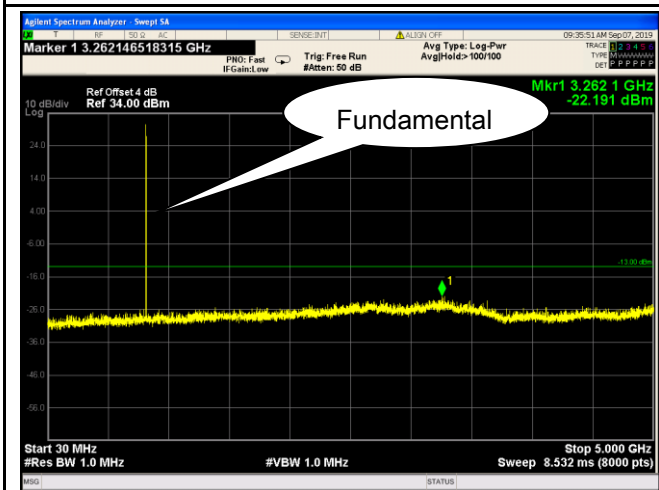

GSM 850 Middle Channel

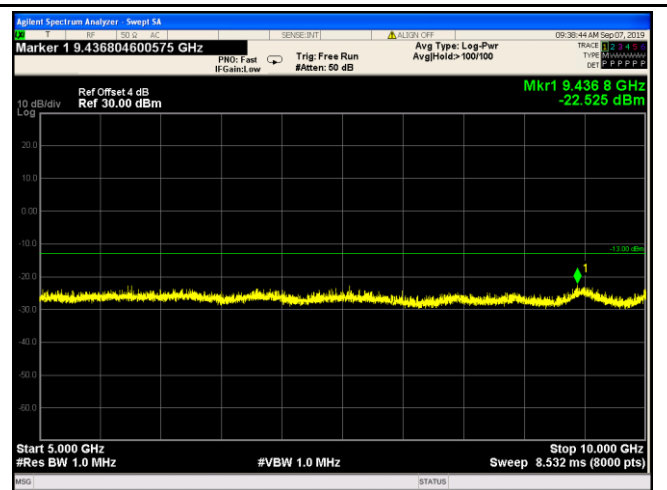

GSM 850 Middle Channel-1

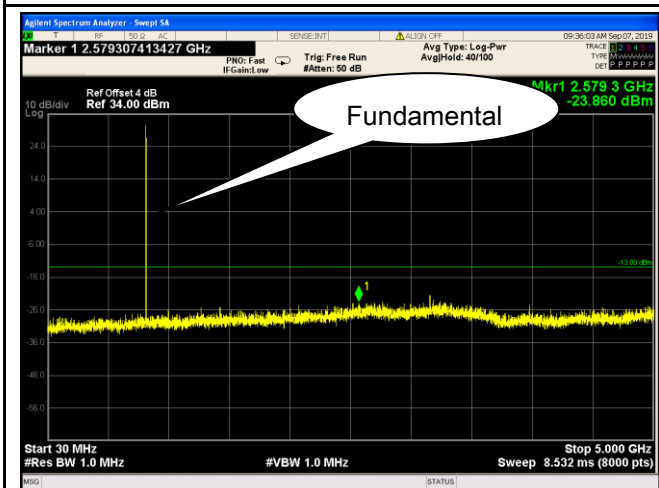

GSM 850 - High Channel

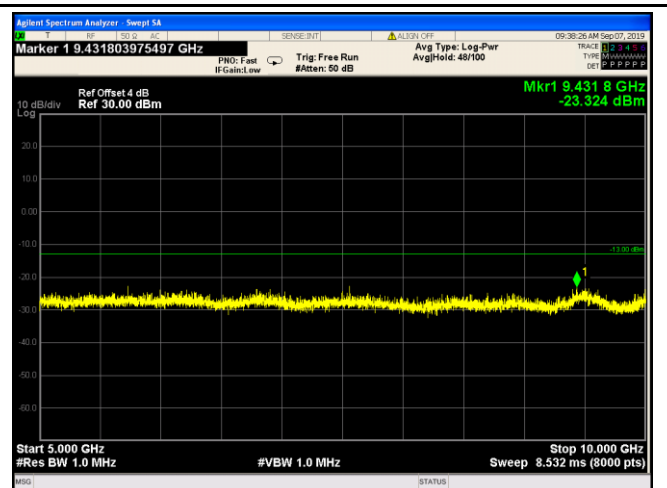

GSM 850 - High Channel-1



Test Report No.	Q200102S012 -FCC-R1
Page	47 of 91

PCS Band (Part24E) result

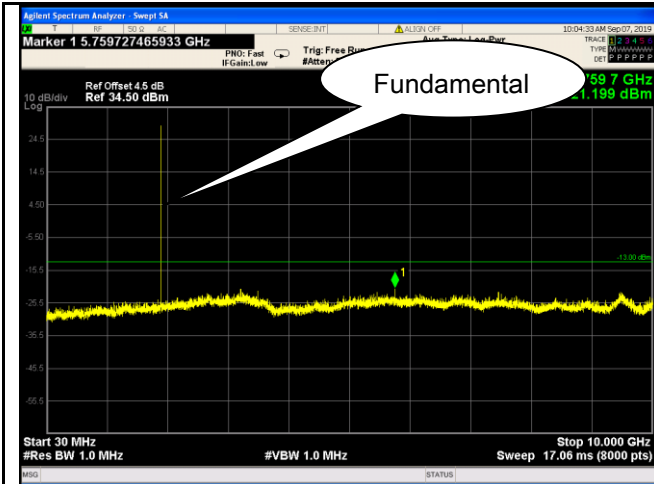

PCS1900 - Low Channel

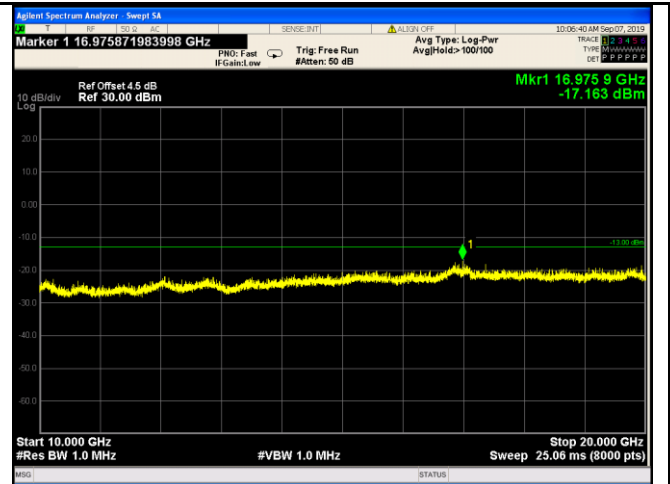

PCS1900 - Low Channel-1

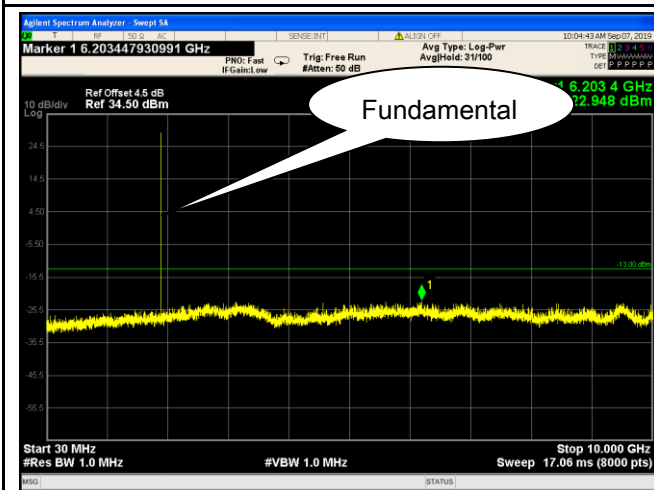

PCS1900 - Middle Channel

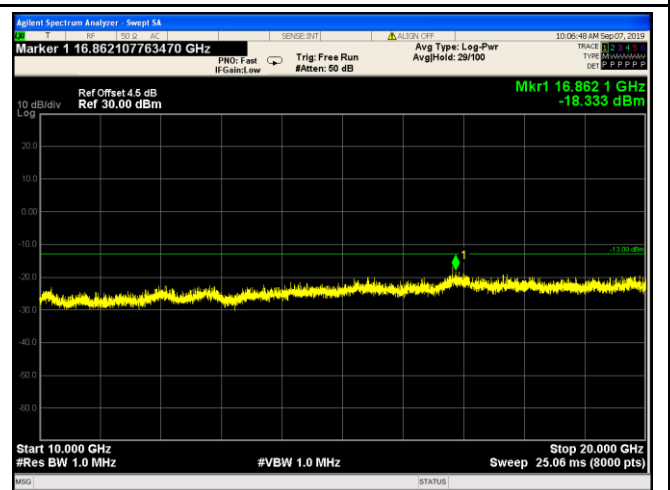

PCS1900 - Middle Channel-1

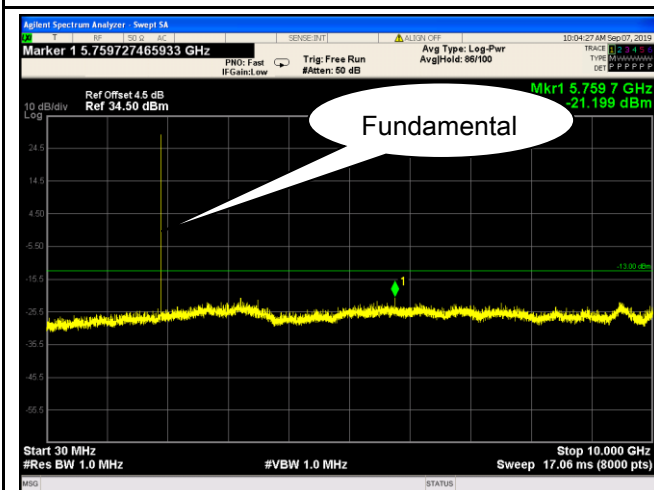

PCS1900 - High Channel

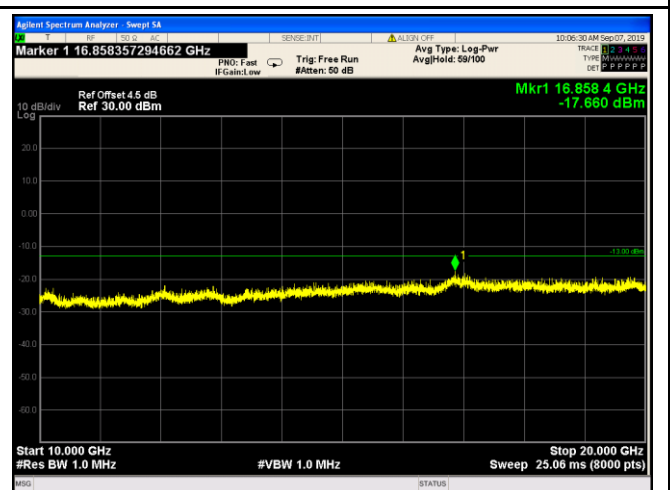

PCS1900 - High Channel-1



Test Report No.	Q200102S012 -FCC-R1
Page	48 of 91

RMC

UMTS-FDD Band V (Part 22H)

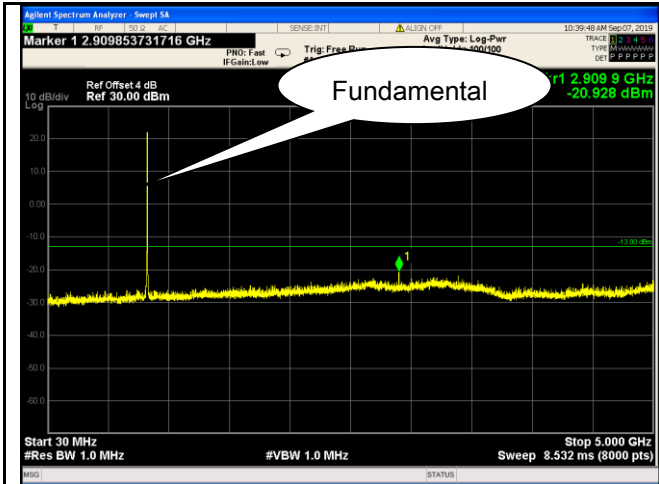

Band V - Low Channel

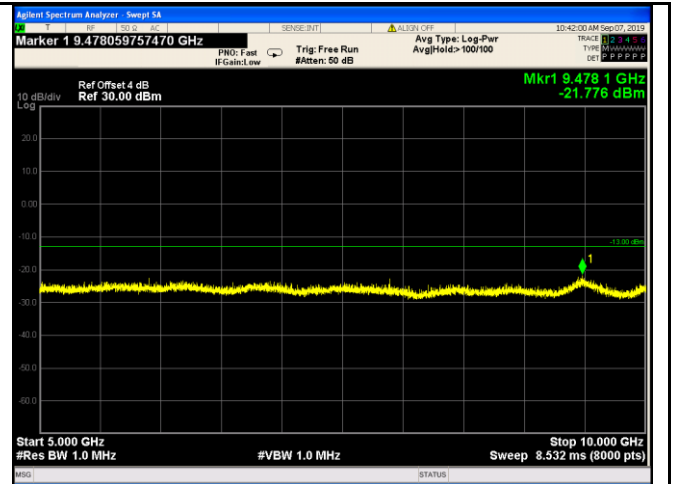

Band V - Low Channel-1

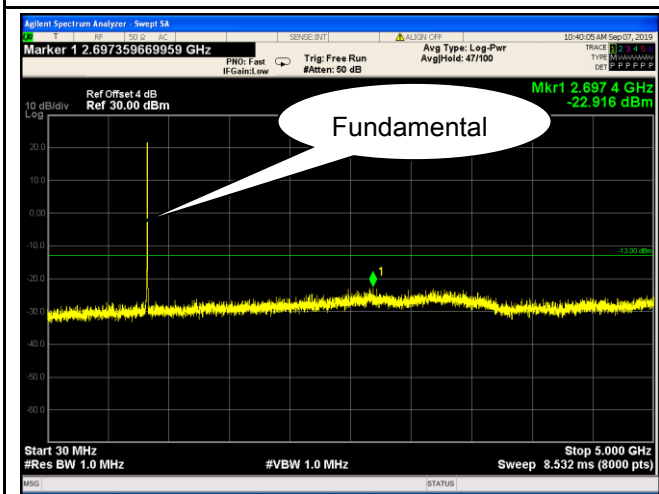

Band V - Middle Channel

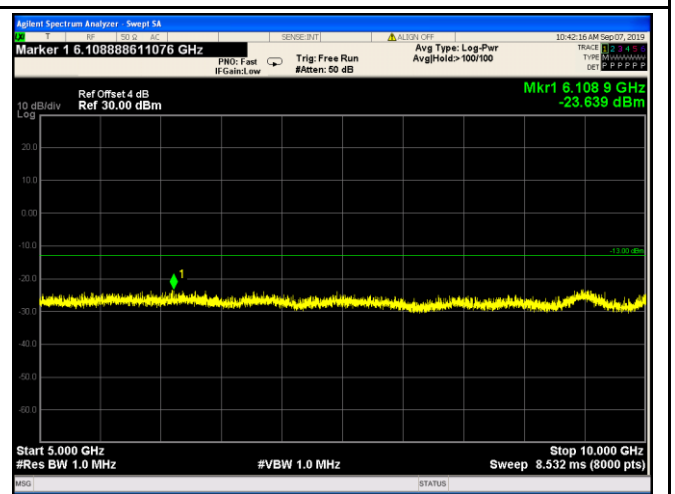

Band V - Middle Channel-1

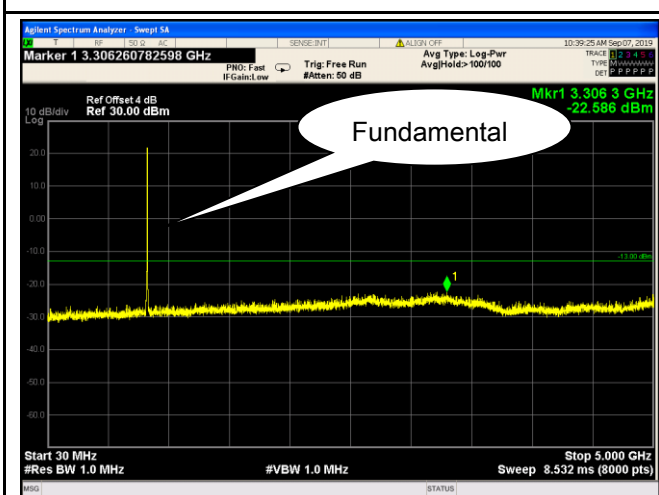

Band V - High Channel

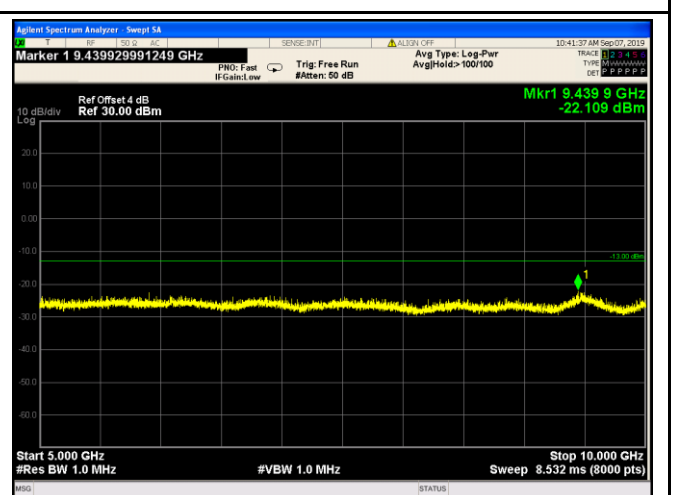

Band V - High Channel-1



Test Report No.	Q200102S012 -FCC-R1
Page	49 of 91

UMTS-FDD Band II (Part 24E)

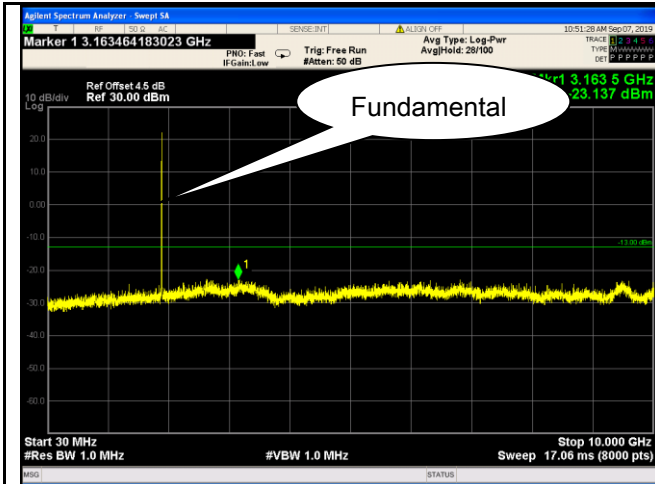

Band II - Low Channel

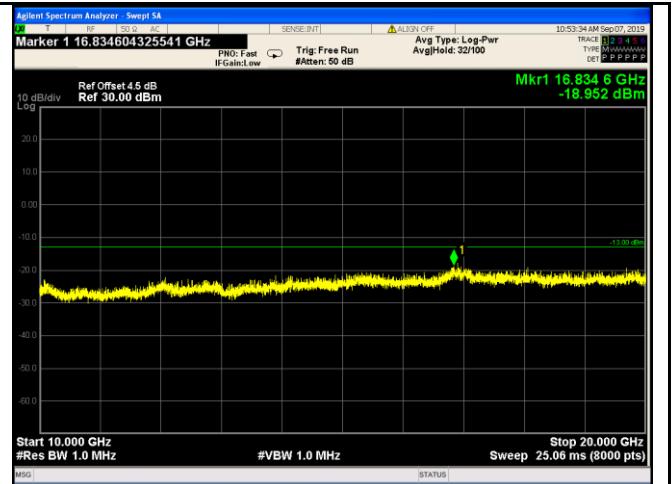

Band II - Low Channel-1

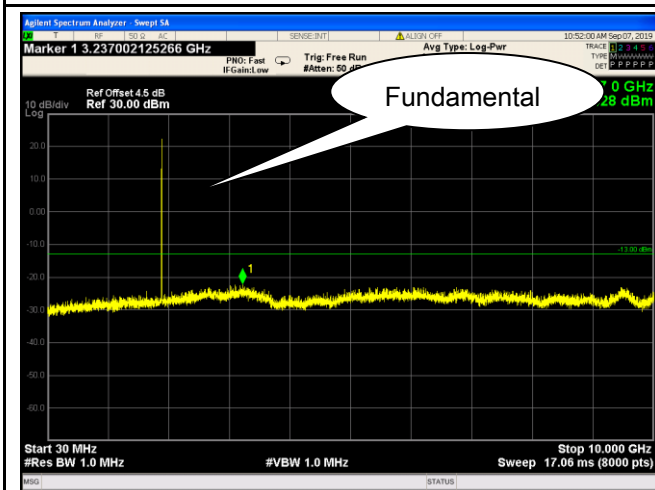

Band II - Middle Channel

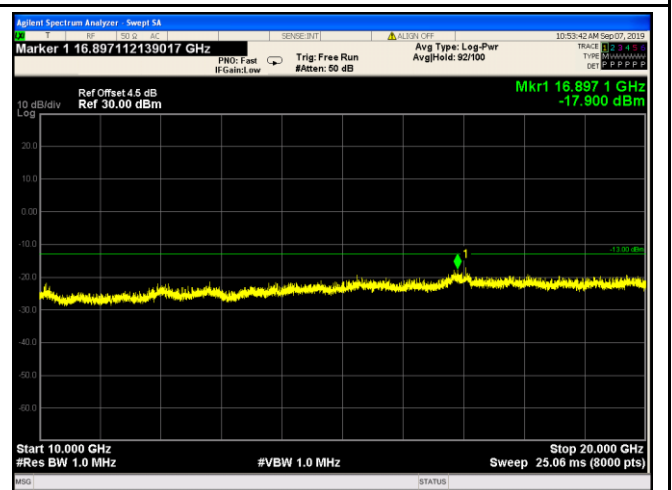

Band II - Middle Channel-1

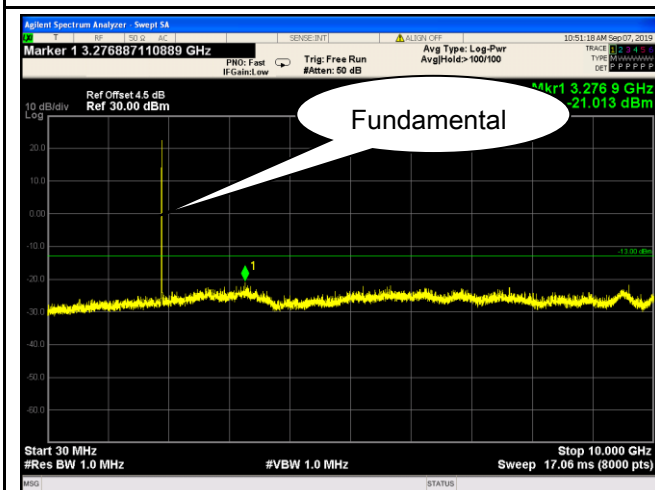

Band II - High Channel

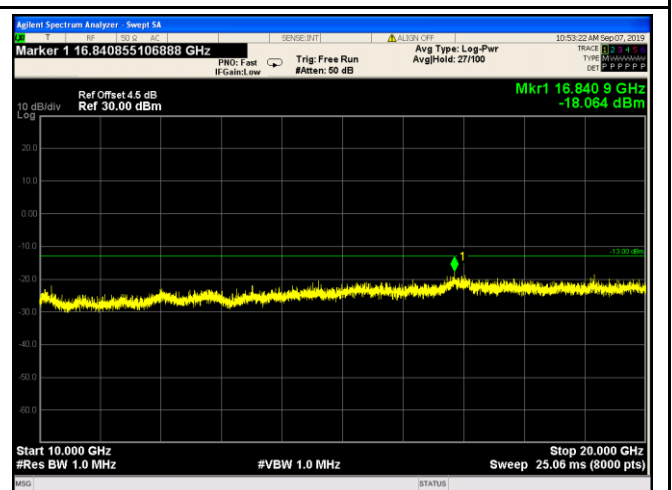

Band II - High Channel-1



Test Report No.	Q200102S012 -FCC-R1
Page	50 of 91

UMTS-FDD Band IV (Part 27H)

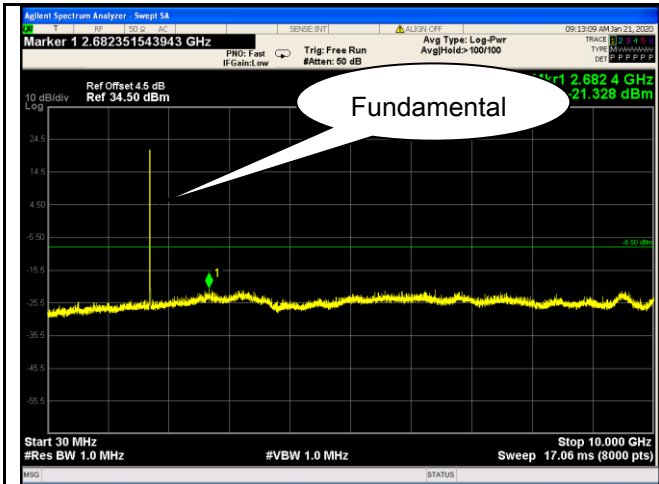

Band IV - Low Channel

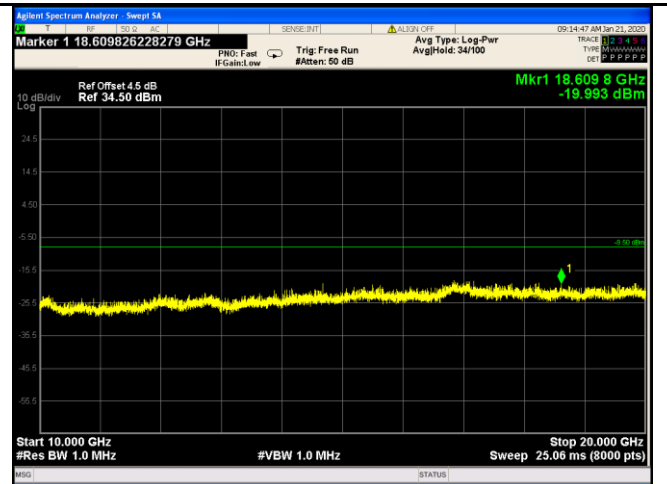

Band IV - Low Channel-1

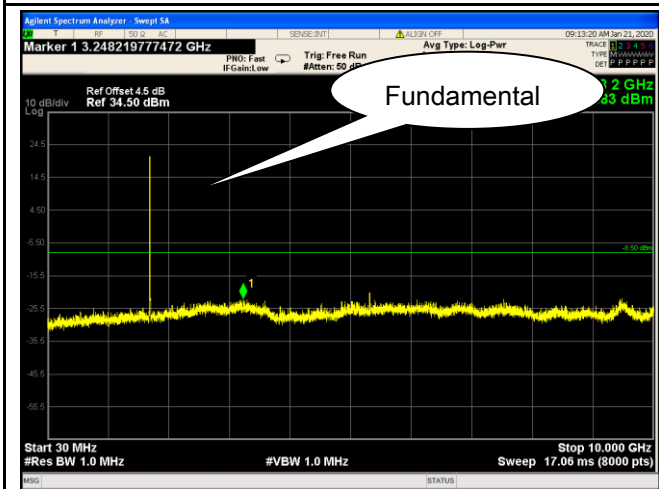

Band IV - Middle Channel

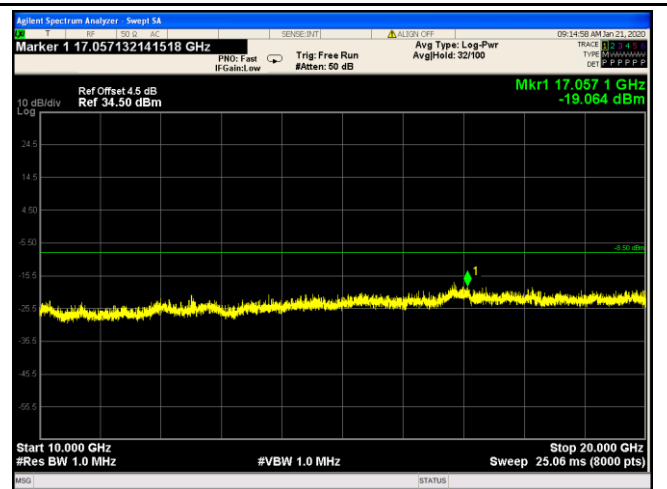

Band IV - Middle Channel-1

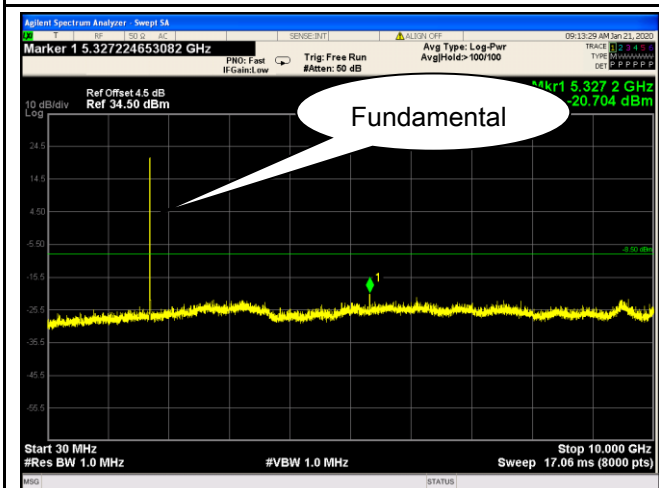

Band IV - High Channel

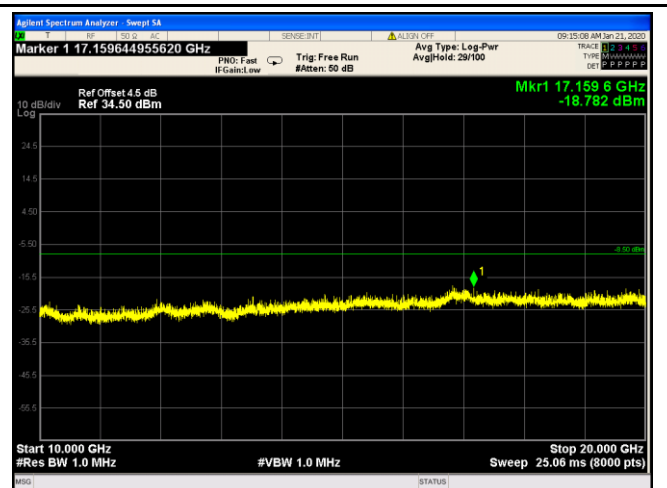

Band IV - High Channel-1



Test Report No.	Q200102S012 -FCC-R1
Page	51 of 91

HSDPA:
UMTS-FDD Band V (Part 22H)

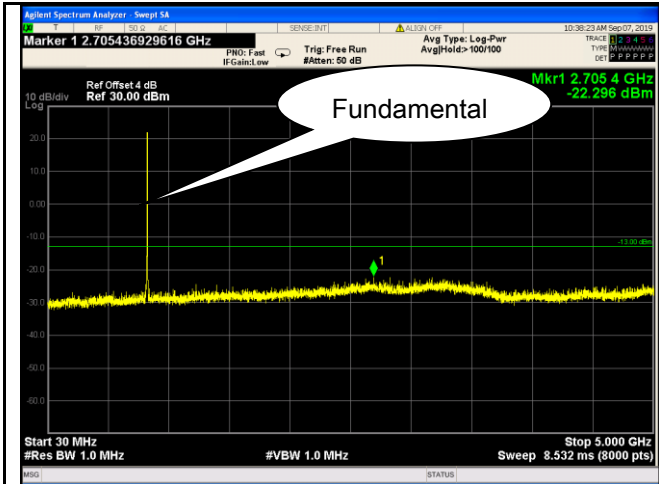

Band V - Low Channel

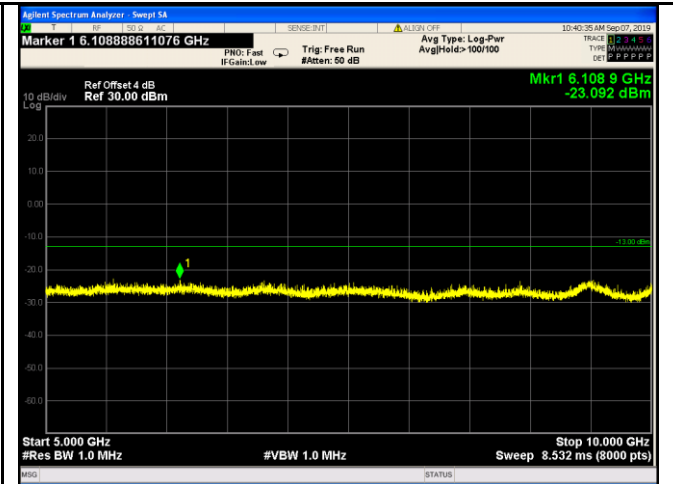

Band V - Low Channel-1

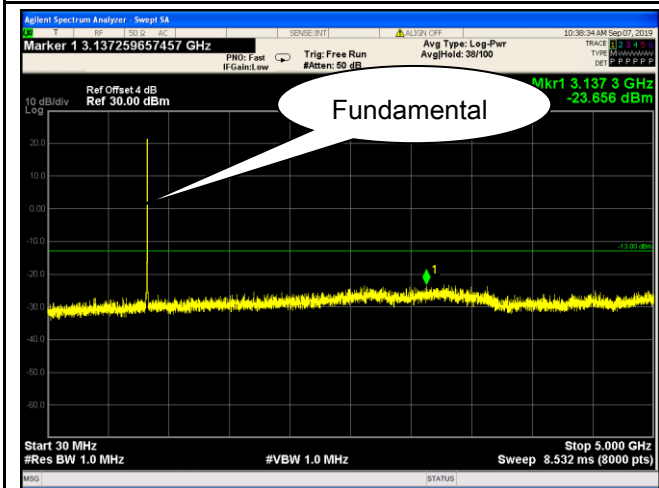

Band V - Middle Channel

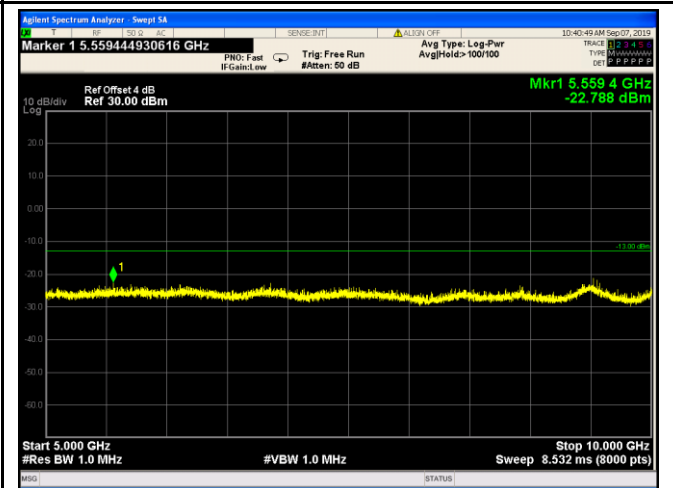

Band V - Middle Channel-1

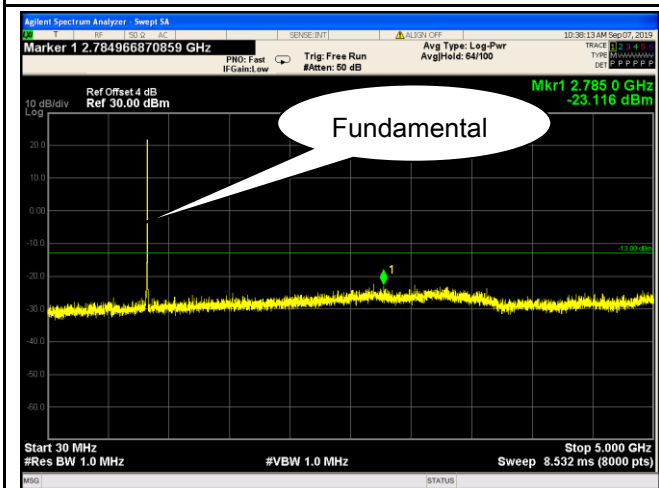

Band V - High Channel

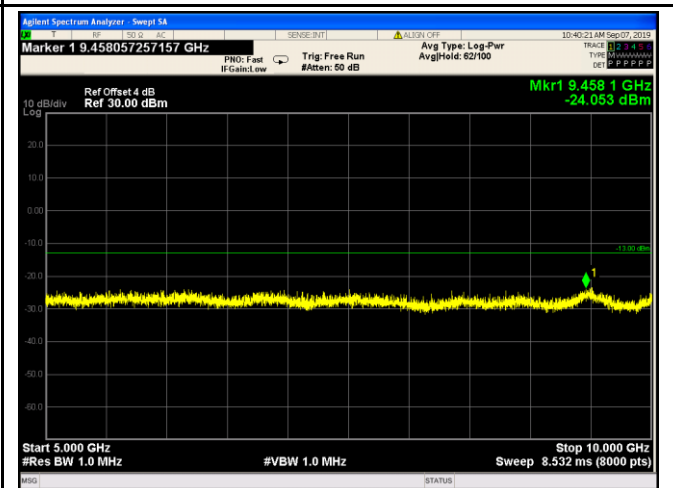

Band V - High Channel-1



Test Report No.	Q200102S012 -FCC-R1
Page	52 of 91

UMTS-FDD Band II (Part 24E)

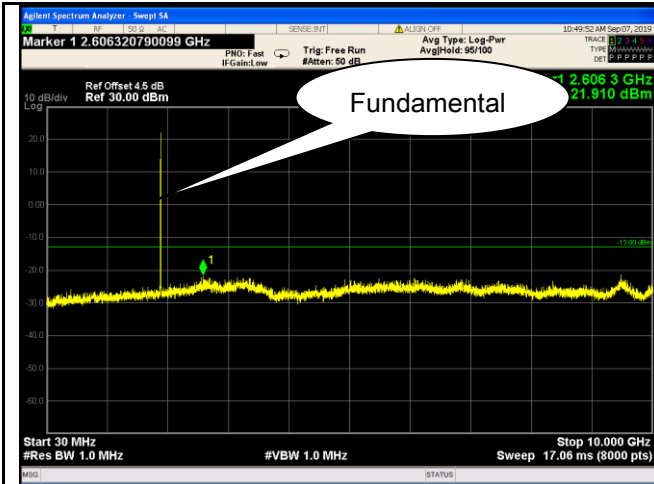

Band II - Low Channel

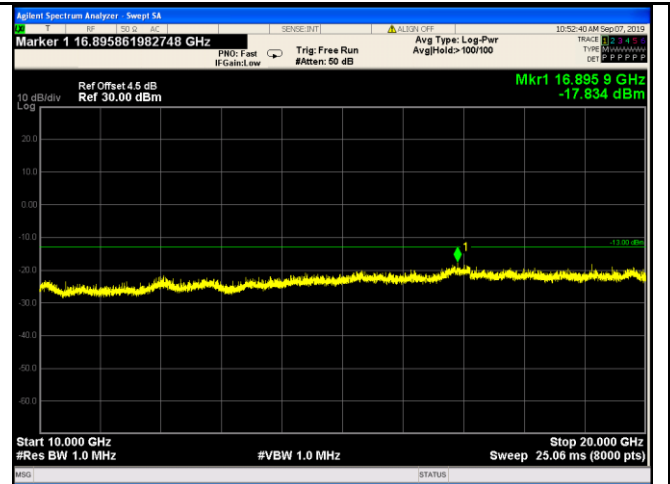

Band II - Low Channel-1

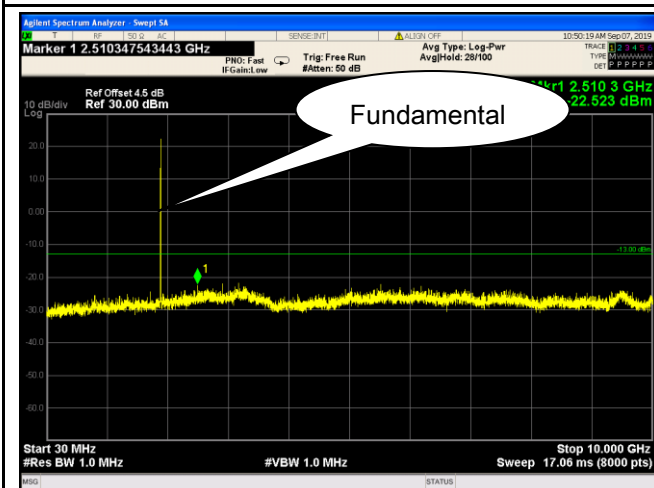

Band II - Middle Channel

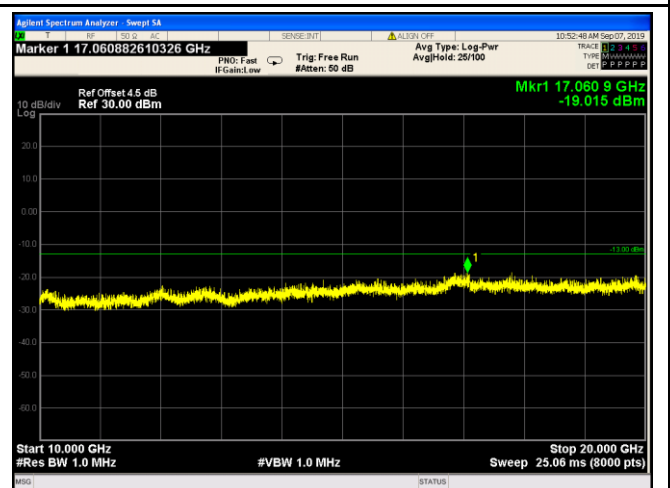

Band II - Middle Channel-1

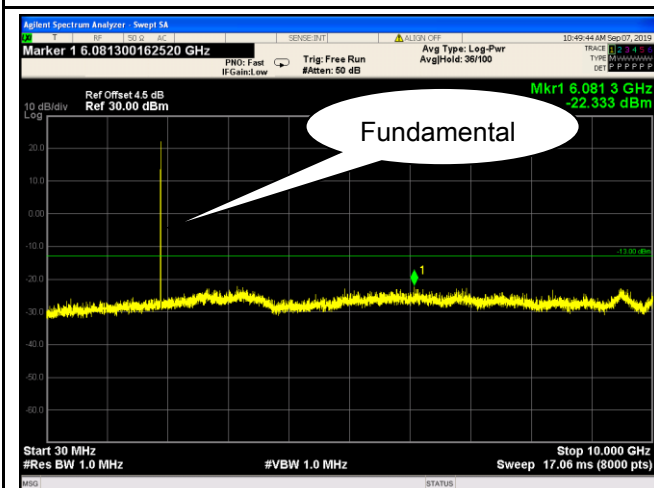

Band II - High Channel

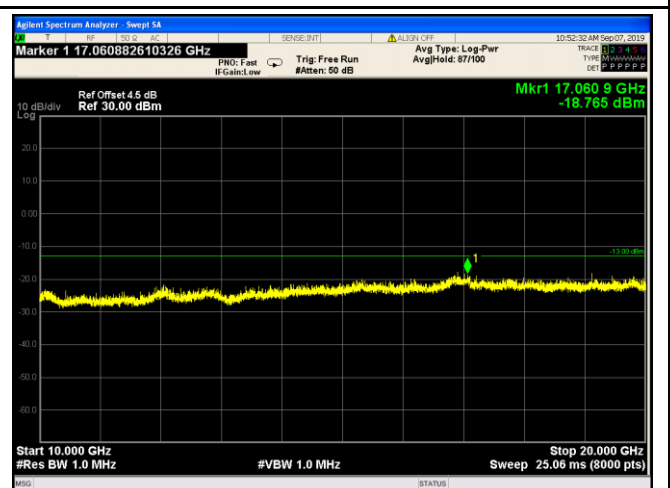

Band II - High Channel-1



Test Report No.	Q200102S012 -FCC-R1
Page	53 of 91

UMTS-FDD Band IV (Part 27H)

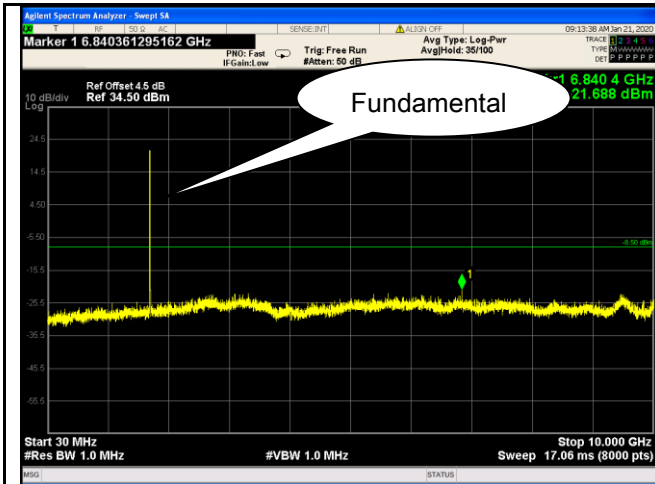

Band IV - Low Channel

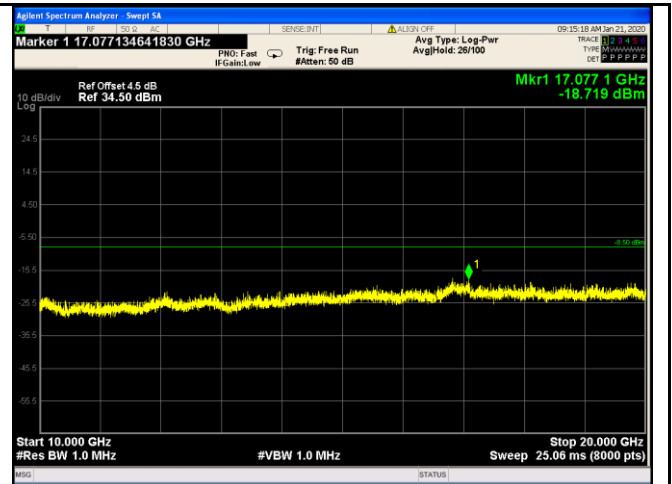

Band IV - Low Channel-1

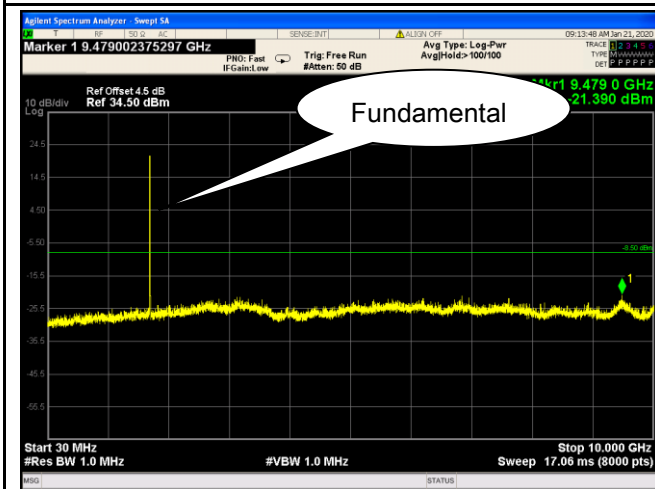

Band IV - Middle Channel

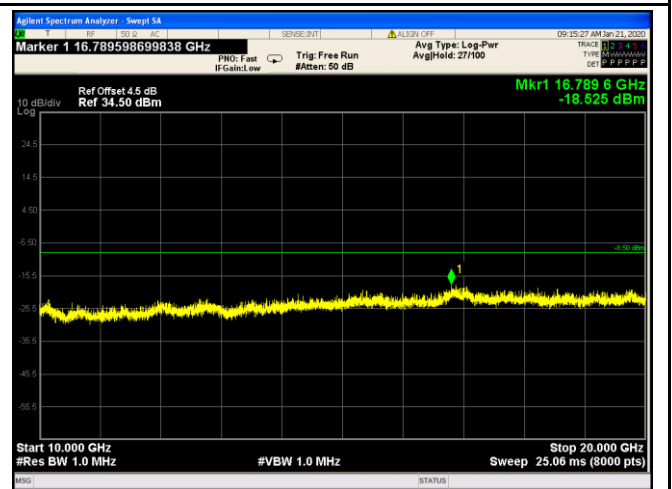

Band IV - Middle Channel-1

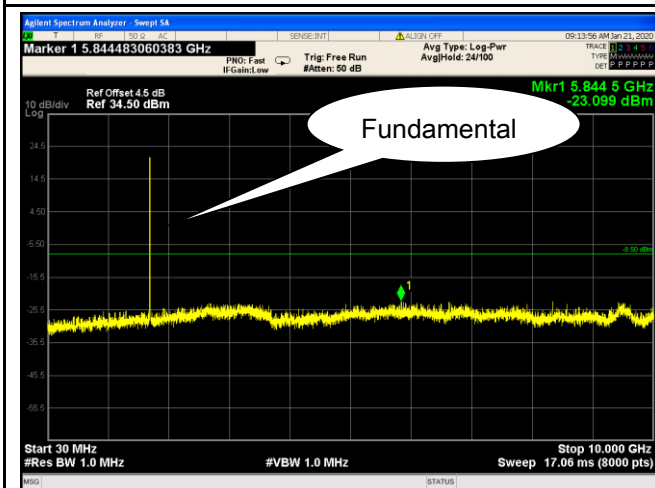

Band IV - High Channel

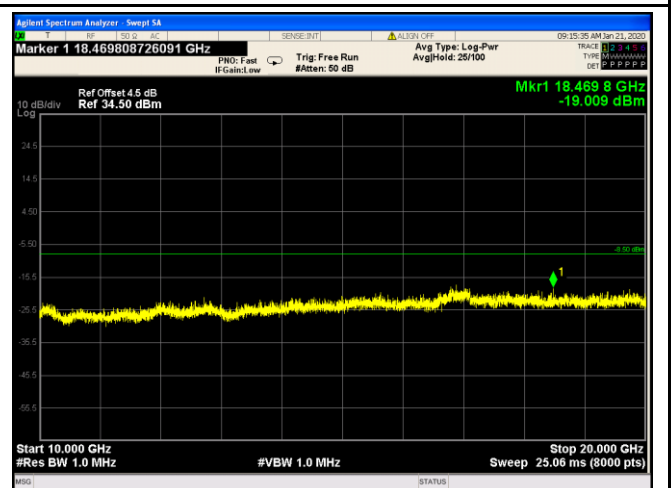

Band IV - High Channel-1



BUREAU
VERITAS

Test Report No.	Q200102S012 -FCC-R1
Page	54 of 91

HSUPA:

UMTS-FDD Band V (Part 22H)

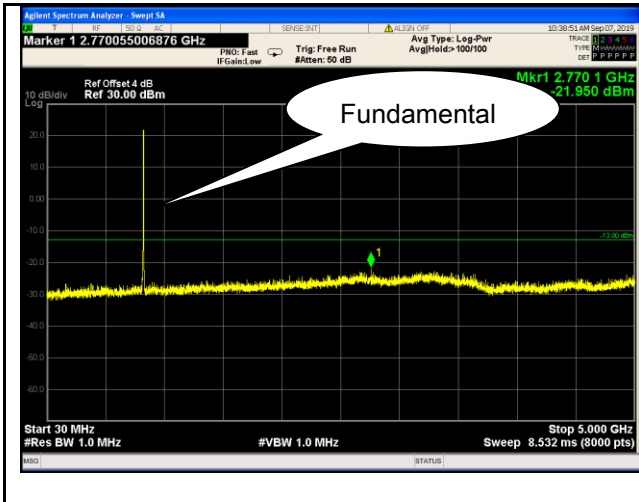

Band V - Low Channel

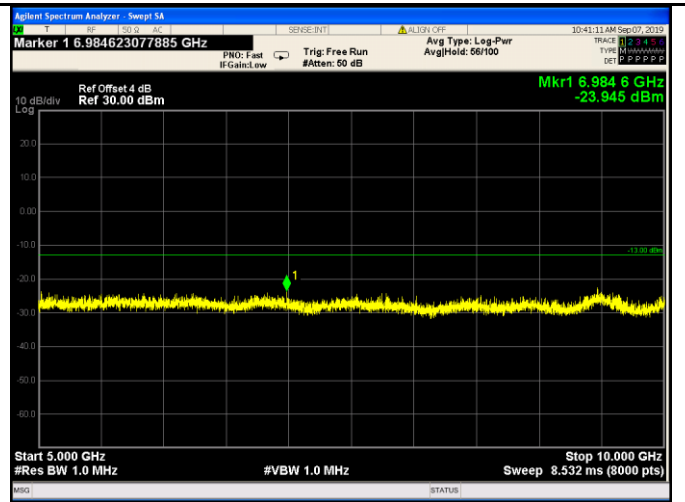

Band V - Low Channel-1

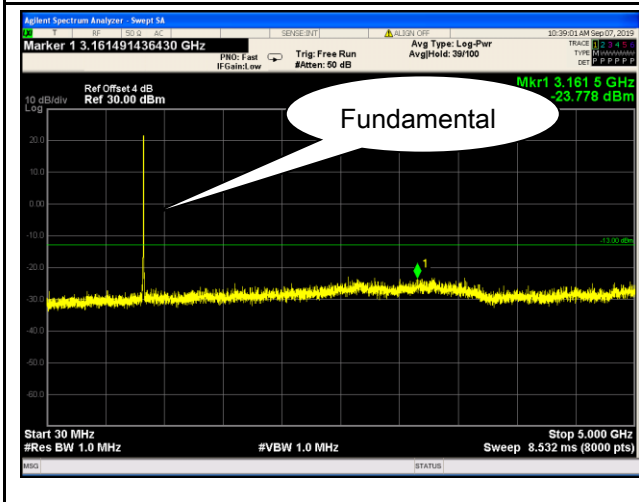

Band V - Middle Channel

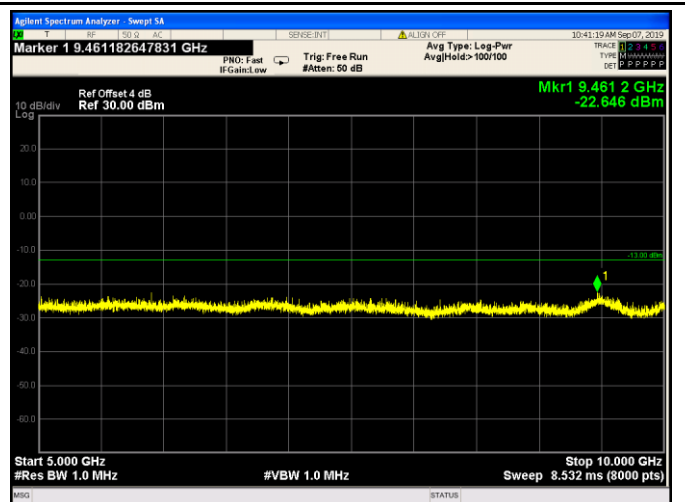

Band V - Middle Channel-1

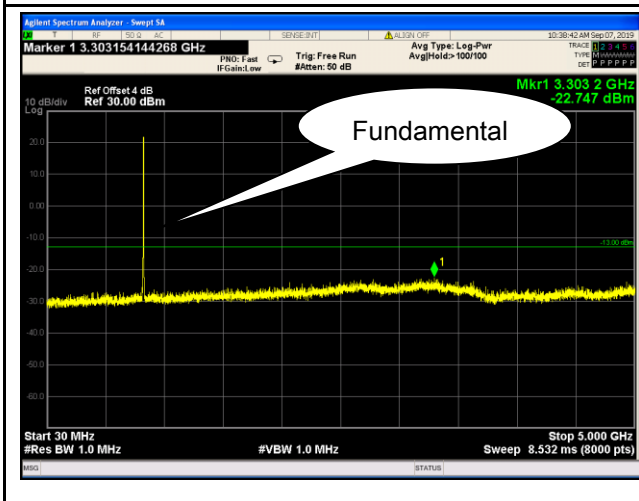

Band V - High Channel

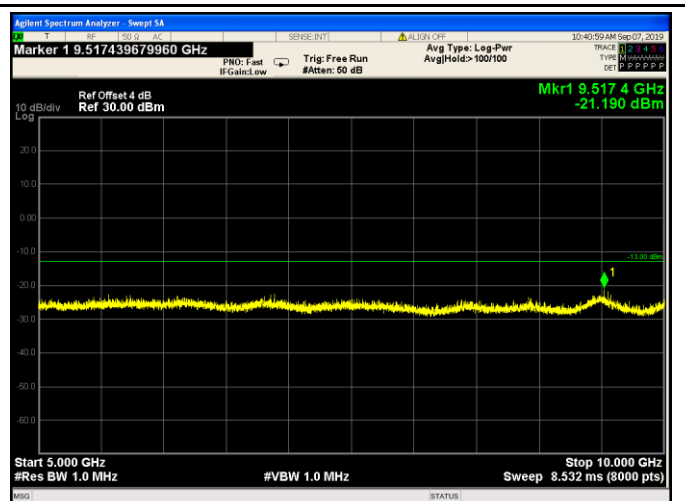

Band V - High Channel-1



Test Report No.	Q200102S012 -FCC-R1
Page	55 of 91

UMTS-FDD Band II (Part 24E)

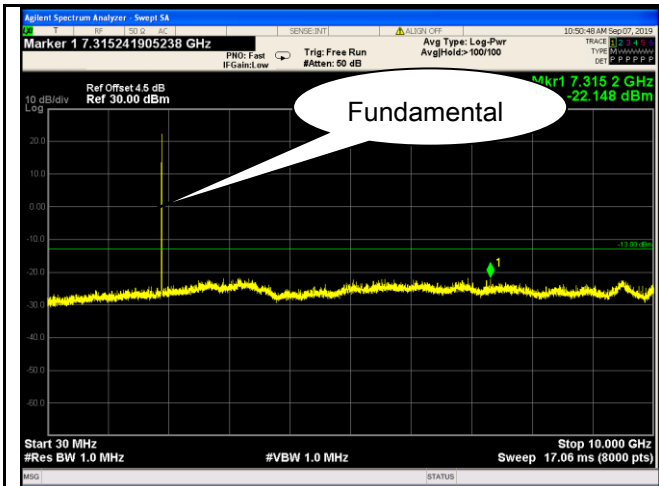

Band II - Low Channel

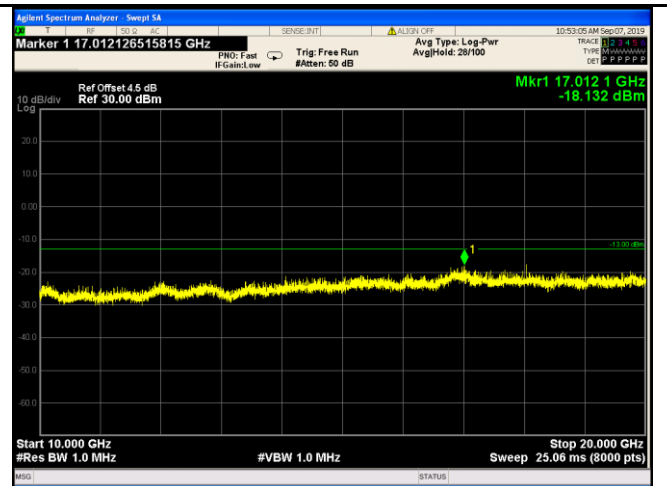

Band II - Low Channel-1

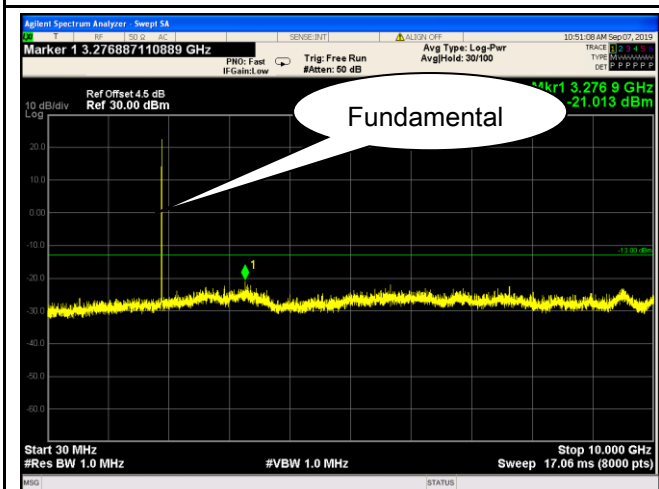

Band II - Middle Channel

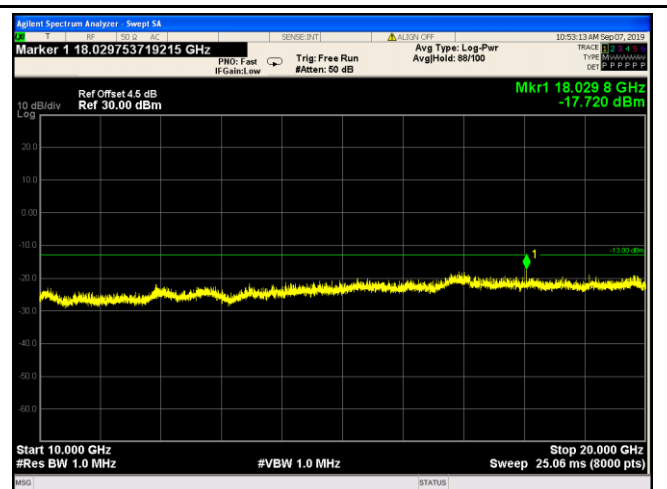

Band II - Middle Channel-1

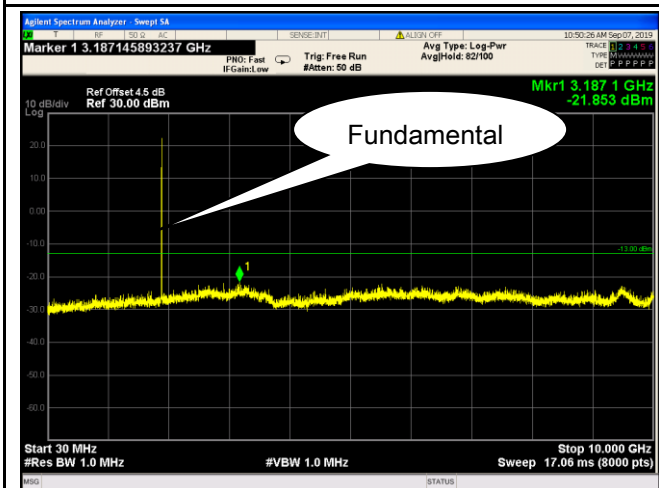

Band II - High Channel

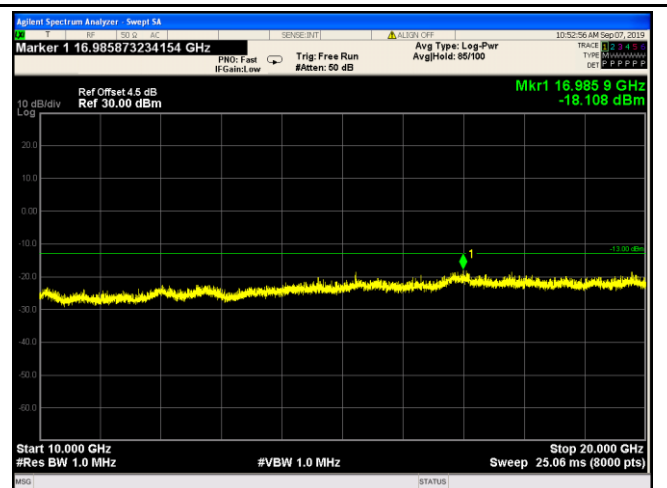

Band II - High Channel-1



Test Report No.	Q200102S012 -FCC-R1
Page	56 of 91

UMTS-FDD Band IV (Part 27H)

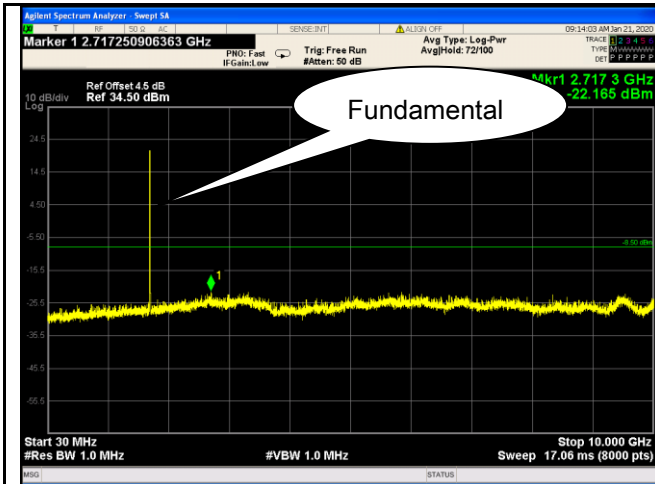

Band IV - Low Channel

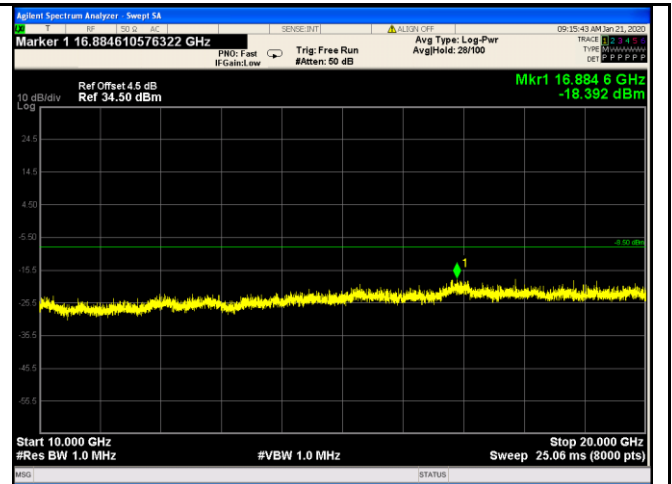

Band IV - Low Channel-1

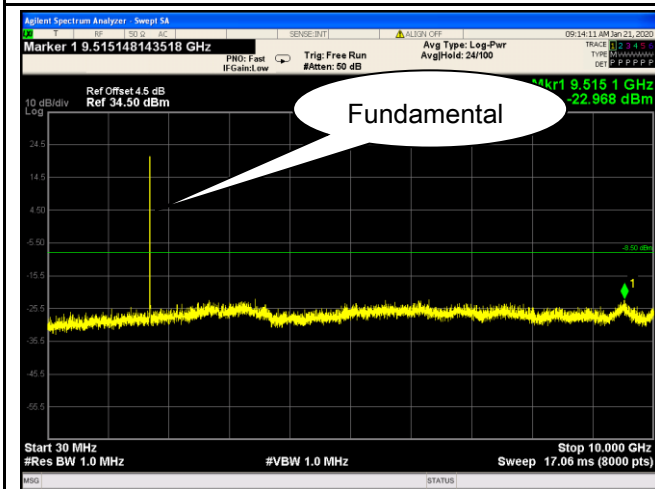

Band IV - Middle Channel

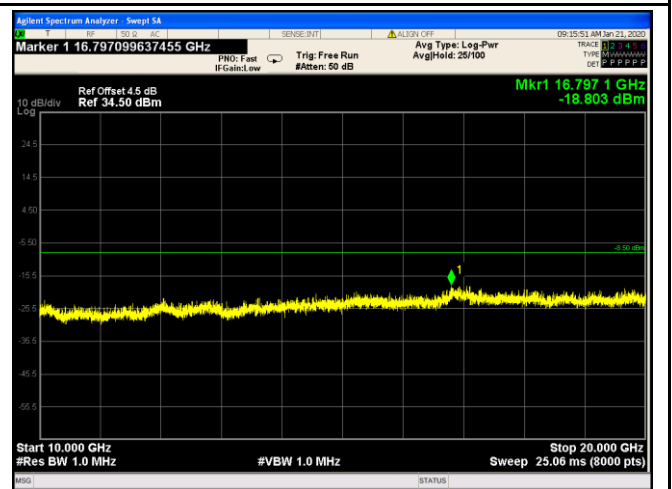

Band IV - Middle Channel-1

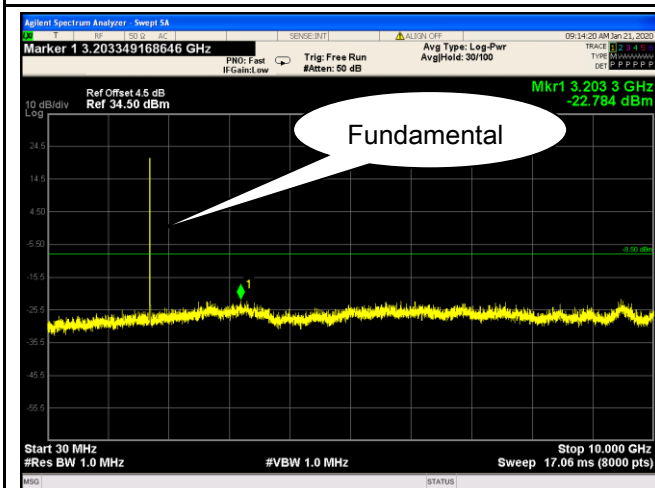

Band IV - High Channel

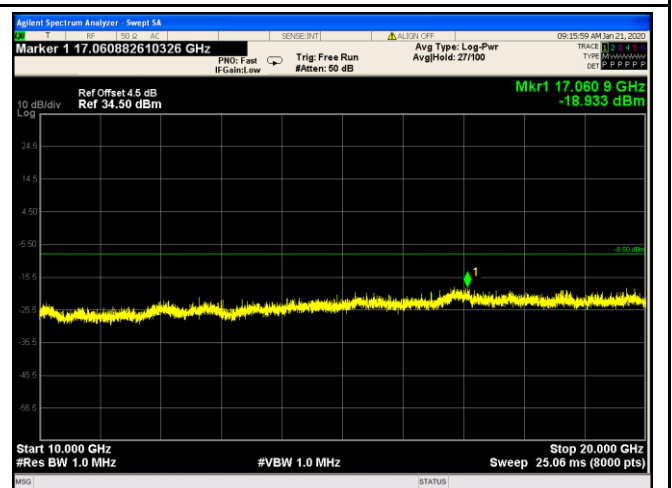

Band IV - High Channel-1

6.5 Spurious Radiated Emissions

Temperature	26 °C
Relative Humidity	56%
Atmospheric Pressure	1023mbar
Test date :	Sep. 5,2019
Tested By :	Aaron Liang

Requirement(s):

Spec	Item	Requirement	Applicable
§2.1053, §22.917 & §24.238 § 27.53(h)	a)	The power of any emission outside of the authorized operating frequency ranges must be attenuated below the transmitter power (P) by a factor of at least $43 + 10 \log (P)$ dB. The spectrum is scanned from 30 MHz up to a frequency including its 10th harmonic.	<input checked="" type="checkbox"/>

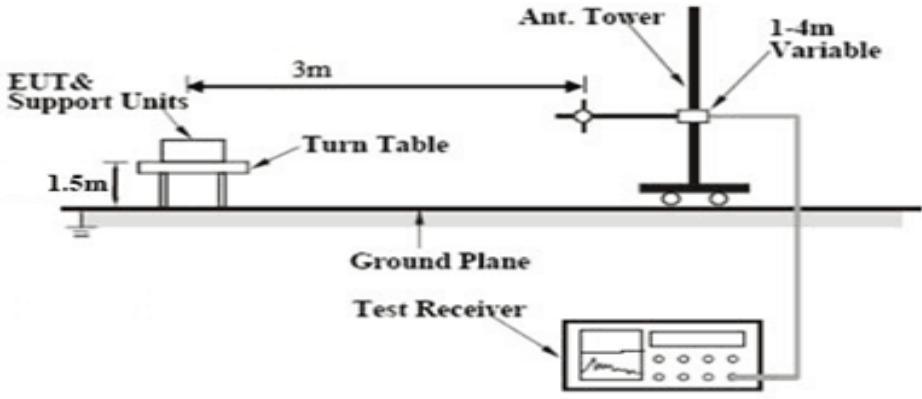
Test setup	
------------	--

Test Procedure	<ol style="list-style-type: none"> The transmitter was placed on a wooden turntable, and it was transmitting into a non-radiating load which was also placed on the turntable. The measurement antenna was placed at a distance of 3 meters from the EUT. During the tests, the antenna height and polarization as well as EUT azimuth were varied in order to identify the maximum level of emissions from the EUT. The test was performed by placing the EUT on 3-orthogonal axis. Remove the EUT and replace it with substitution antenna. A signal generator was connected to the substitution antenna by a non-radiating cable. The absolute levels of the spurious emissions were measured by the substitution. <p>Sample Calculation:</p> <p>EUT Field Strength = Raw Amplitude (dBμV/m) – Amplifier Gain (dB) + Antenna Factor (dB) + Cable Loss (dB) + Filter Attenuation (dB, if used)</p>
----------------	--

Remark	
--------	--



BUREAU
VERITAS

Test Report No.	Q200102S012 -FCC-R1
Page	58 of 91

Result	<input checked="" type="checkbox"/> Pass	<input type="checkbox"/> Fail
--------	--	-------------------------------

Test Data Yes N/A

Test Plot Yes (See below) N/A

Cellular Band (Part 22H) result

Low channel

Frequency (MHz)	Antenna Polarization (H/V)	Corrected Reading (dBm)	Limit (dBm)	Margin (dB)
1648.4	V	-42.15	-13	-29.15
1648.4	H	-45.36	-13	-32.36
148.6	V	-50.68	-13	-37.68
514.3	H	-53.47	-13	-40.47

Middle channel

Frequency (MHz)	Antenna Polarization (H/V)	Corrected Reading (dBm)	Limit (dBm)	Margin (dB)
1673.2	V	-41.85	-13	-28.85
1673.2	H	-43.26	-13	-30.26
199.6	V	-51.05	-13	-38.05
355.7	H	-52.36	-13	-39.36

High channel

Frequency (MHz)	Antenna Polarization (H/V)	Corrected Reading (dBm)	Limit (dBm)	Margin (dB)
1697.6	V	-42.15	-13	-29.15
1697.6	H	-42.95	-13	-29.95
419.5	V	-50.11	-13	-37.11
799.5	H	-52.65	-13	-39.65

Note:

- 1, The testing has been conformed to $10 \times 848.8 \text{ MHz} = 8,488 \text{ MHz}$
- 2, All other emissions more than 30 dB below the limit
- 3, GSM voice , GPRS and EGPRS mode were investigated. The results above show only the worse cases
- 4, X-Axis, Y-Axis and Z-Axis were investigated. The results above show only the worst case.

PCS Band (Part24E) result

Low channel

Frequency (MHz)	Antenna Polarization (H/V)	Corrected Reading (dBm)	Limit (dBm)	Margin (dB)
3700.4	V	-38.95	-13	-25.95
3700.4	H	-43.57	-13	-30.57
5550.6	V	-37.95	-13	-24.95
5550.6	H	-38.15	-13	-25.15
147.2	V	-48.62	-13	-35.62
295.4	H	-53.12	-13	-40.12

Middle channel

Frequency (MHz)	Antenna Polarization (H/V)	Corrected Reading (dBm)	Limit (dBm)	Margin (dB)
3760	V	-39.51	-13	-26.51
3760	H	-41.15	-13	-28.15
5640	V	-36.55	-13	-23.55
5640	H	-37.18	-13	-24.18
331.2	V	-48.95	-13	-35.95
400.5	H	-49.99	-13	-36.99

High channel

Frequency (MHz)	Antenna Polarization (H/V)	Corrected Reading (dBm)	Limit (dBm)	Margin (dB)
3819.6	V	-38.95	-13	-25.95
3819.6	H	-40.61	-13	-27.61
5729.4	V	-36.15	-13	-23.15
5729.4	H	-38.55	-13	-25.55
579.1	V	-49.85	-13	-36.85
356.5	H	-50.36	-13	-37.36



Test Report No.	Q200102S012 -FCC-R1
Page	61 of 91

Note:

- 1, The testing has been conformed to $10 \times 1909.8 \text{ MHz} = 19,098 \text{ MHz}$
- 2, All other emissions more than 30 dB below the limit
- 3, GSM voice , GPRS and EGPRS mode were investigated. The results above show only the worse cases
- 4, X-Axis, Y-Axis and Z-Axis were investigated. The results above show only the worst case.

UMTS-FDD Band V (Part 22H)

Low channel

Frequency (MHz)	Antenna Polarization (H/V)	Corrected Reading (dBm)	Limit (dBm)	Margin (dB)
1648.4	V	-44.01	-13	-31.01
1648.4	H	-46.95	-13	-33.95
277.9	V	-48.95	-13	-35.95
654.2	H	-50.65	-13	-37.65

Middle channel

Frequency (MHz)	Antenna Polarization (H/V)	Corrected Reading (dBm)	Limit (dBm)	Margin (dB)
1673.2	V	-45.39	-13	-32.39
1673.2	H	-47.65	-13	-34.65
224.5	V	-47.98	-13	-34.98
476.3	H	-51.26	-13	-38.26

High channel

Frequency (MHz)	Antenna Polarization (H/V)	Corrected Reading (dBm)	Limit (dBm)	Margin (dB)
1697.6	V	-43.12	-13	-30.12
1697.6	H	-45.95	-13	-32.95
556.2	V	-50.65	-13	-37.65
487.9	H	-52.16	-13	-39.16

Note:

- 1, The testing has been conformed to $10 \times 846.6 \text{ MHz} = 8,466 \text{ MHz}$
- 2, All other emissions more than 30 dB below the limit
- 3, RMC, HSUPA and HSDPA mode were investigated. The results above show only the worse cases
- 4, X-Axis, Y-Axis and Z-Axis were investigated. The results above show only the worst case.

UMTS-FDD Band II (Part 24E)

Low channel

Frequency (MHz)	Antenna Polarization (H/V)	Corrected Reading (dBm)	Limit (dBm)	Margin (dB)
3700.4	V	-20.98	-13	-7.98
3700.4	H	-24.06	-13	-11.06
5550.6	V	-28.64	-13	-15.64
5550.6	H	-29.41	-13	-16.41
635.2	V	-39.95	-13	-26.95
617.5	H	-40.17	-13	-27.17

Middle channel

Frequency (MHz)	Antenna Polarization (H/V)	Corrected Reading (dBm)	Limit (dBm)	Margin (dB)
3760	V	-21.12	-13	-8.12
3760	H	-23.57	-13	-10.57
5640	V	-27.43	-13	-14.43
5640	H	-29.11	-13	-16.11
358.6	V	-43.62	-13	-30.62
478.2	H	-44.87	-13	-31.87

High channel

Frequency (MHz)	Antenna Polarization (H/V)	Corrected Reading (dBm)	Limit (dBm)	Margin (dB)
3819.6	V	-21.62	-13	-8.62
3819.6	H	-24.61	-13	-11.61
5729.4	V	-28.76	-13	-15.76
5729.4	H	-29.03	-13	-16.03
579.1	V	-40.58	-13	-27.58
356.5	H	-42.68	-13	-29.68



Test Report No.	Q200102S012 -FCC-R1
Page	64 of 91

Note:

- 1, *The testing has been conformed to $10 \times 1907.6 \text{ MHz} = 19,076 \text{ MHz}$*
- 2, *All other emissions more than 30 dB below the limit*
- 3, *RMC, HSUPA and HSDPA mode were investigated. The results above show only the worse cases*
- 4, *X-Axis, Y-Axis and Z-Axis were investigated. The results above show only the worst case*

UMTS-FDD Band IV (Part 27H)

Low channel

Frequency (MHz)	Antenna Polarization (H/V)	Corrected Reading (dBm)	Limit (dBm)	Margin (dB)
3430.5	V	-24.05	-13	-11.05
3430.5	H	-26.14	-13	-13.14
5145.5	V	-26.31	-13	-13.31
5145.5	H	-27.31	-13	-14.31
631.7	V	-51.84	-13	-28.84
378.6	H	-55.33	-13	-27.33

Middle channel

Frequency (MHz)	Antenna Polarization (H/V)	Corrected Reading (dBm)	Limit (dBm)	Margin (dB)
3461.2	V	-21.67	-13	-8.67
3469.7	H	-24.66	-13	-11.66
5191.5	V	-27.34	-13	-14.34
5191.5	H	-28.6	-13	-15.6
631.7	V	-50.23	-13	-28.23
378.6	H	-54.6	-13	-29.6

High channel

Frequency (MHz)	Antenna Polarization (H/V)	Corrected Reading (dBm)	Limit (dBm)	Margin (dB)
3511.4	V	-21.92	-13	-8.92
3511.4	H	-25.12	-13	-12.12
5266.8	V	-38.3	-13	-25.3
5266.8	H	-37.19	-13	-24.19
631.7	V	-53.93	-13	-28.93
378.6	H	-56.37	-13	-27.37



Test Report No.	Q200102S012 -FCC-R1
Page	66 of 91

Note:

1, The testing has been conformed to $10 \times 1907.6 \text{ MHz} = 19,076 \text{ MHz}$

2, All other emissions more than 30 dB below the limit

3, RMC, HSUPA and HSDPA mode were investigated. The results above show only the worse cases

4, X-Axis, Y-Axis and Z-Axis were investigated. The results above show only the worst case

6.6 Band Edge

Temperature	26 °C
Relative Humidity	56%
Atmospheric Pressure	1023mbar
Test date :	Sep. 07,2019 to Jan. 20,2020
Tested By :	Aaron Liang

Requirement(s):

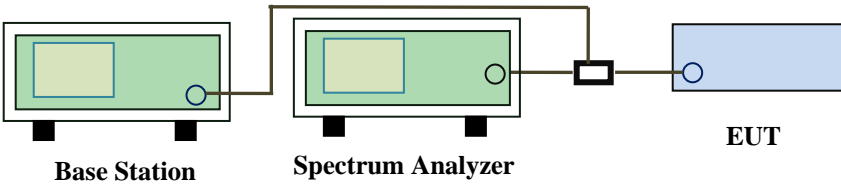
Spec	Item	Requirement	Applicable
§22.917(a) §24.238(a) § 27.53(h)	a)	The power of any emission outside of the authorized operating frequency ranges must be lower than the transmitter power (P) by a factor of at least $43 + 10 \log (P)$ dB.	<input checked="" type="checkbox"/>
Test setup	 <p>The diagram shows a Base Station (green box) connected to a Spectrum Analyzer (green box) and an EUT (blue box). A power divider is used to connect the Spectrum Analyzer and the EUT to the Base Station.</p>		
Procedure	<ul style="list-style-type: none"> - The EUT was connected to Spectrum Analyzer and Base Station via power divider. - The Band Edges of low and high channels for the highest RF powers were measured. Setting RBW as roughly BW/100. 		
Remark			
Result	<input checked="" type="checkbox"/> Pass <input type="checkbox"/> Fail		

Test Data Yes N/A

Test Plot Yes (See below) N/A

GSM Voice:

Cellular Band (Part 22H) result

Frequency (MHz)	Emission (dBm)	Limit (dBm)
823.995	-15.484	-13
949.017	-16.931	-13

PCS Band (Part24E) result

Frequency (MHz)	Emission (dBm)	Limit (dBm)
1849.992	-17.01	-13
1910.018	-15.538	-13

GPRS:

Cellular Band (Part 22H) result

Frequency (MHz)	Emission (dBm)	Limit (dBm)
823.976	-15.542	-13
849.022	-16.587	-13

PCS Band (Part24E) result

Frequency (MHz)	Emission (dBm)	Limit (dBm)
1849.984	-16.594	-13
1910.028	-17.048	-13

EGPRS (MSC1):

Cellular Band (Part 22H) result

Frequency (MHz)	Emission (dBm)	Limit (dBm)
823.979	-14.299	-13
849.019	-13.491	-13

PCS Band (Part24E) result

Frequency (MHz)	Emission (dBm)	Limit (dBm)
1849.949	-15.356	-13
1910.021	-15.522	-13

RMC:

UMTS-FDD Band V (Part 22H)

Frequency (MHz)	Emission (dBm)	Limit (dBm)
823.13	-27.399	-13
849.22	-24.523	-13

UMTS-FDD Band II (Part 24E)

Frequency (MHz)	Emission (dBm)	Limit (dBm)
1850	-17.471	-13
1910.12	-20.407	-13

UMTS-FDD Band IV (Part 27H)

Frequency (MHz)	Emission (dBm)	Limit (dBm)
1710	-21.683	-13
1755	-25.201	-13

HSDPA:

UMTS-FDD Band V (Part 22H)

Frequency (MHz)	Emission (dBm)	Limit (dBm)
822.98	-28.462	-13
849.23	-24.247	-13

UMTS-FDD Band II (Part 24E)

Frequency (MHz)	Emission (dBm)	Limit (dBm)
1850	-17.677	-13
1910.02	-19.709	-13

UMTS-FDD Band IV (Part 27H)

Frequency (MHz)	Emission (dBm)	Limit (dBm)
1710	-22.154	-13
1755	-21.433	-13

HSUPA:

UMTS-FDD Band V (Part 22H)

Frequency (MHz)	Emission (dBm)	Limit (dBm)
823.46	-28.427	-13
849.25	-23.585	-13

UMTS-FDD Band II (Part 24E)

Frequency (MHz)	Emission (dBm)	Limit (dBm)
1850	-17.498	-13
1910.09	-20.128	-13



Test Report No.	Q200102S012 -FCC-R1
Page	71 of 91

UMTS-FDD Band IV (Part 27H)

Frequency (MHz)	Emission (dBm)	Limit (dBm)
1710	-21.91	-13
1755	-25.201	-13



**GSM Voice:
Test Plots**

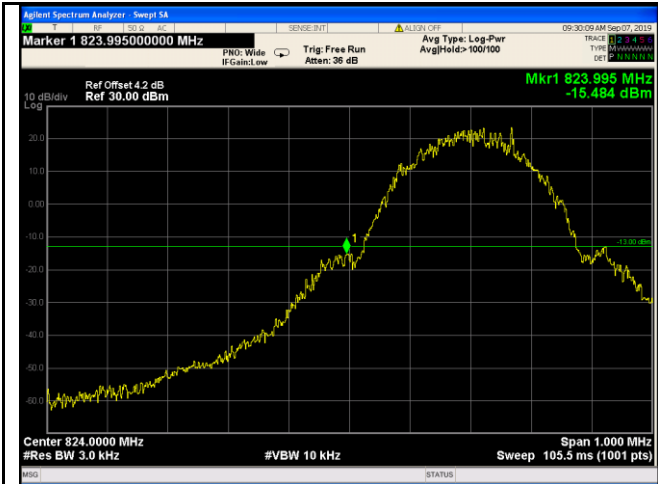

Cellular Band - Low Channel

Note: Offset=Cable loss (4.0) + 10log
(3.18/3)=4.0+0.2=4.2dB



Cellular Band - High Channel

Note: Offset=Cable loss (4.0) + 10log
(3.18/3)=4.0+0.2=4.2dB

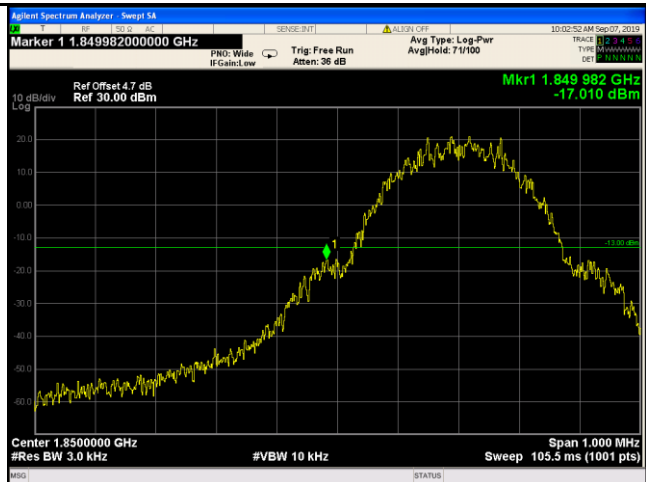

PCS Band - Low Channel

Note: Offset=Cable loss (4.0) + 10log
(3.13/3)=4.5+0.2=4.7dB



PCS Band - High Channel

Note: Offset=Cable loss (4.0) + 10log
(3.18/3)=4.5+0.3=4.8dB



Test Report No.	Q200102S012 -FCC-R1
Page	73 of 91

GPRS:
Test Plots

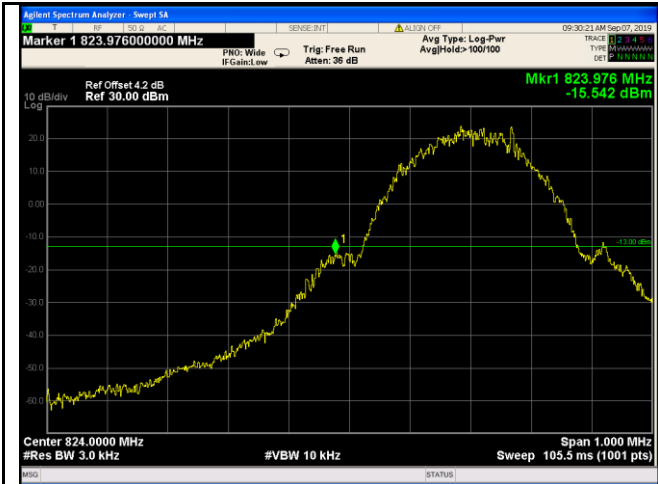

Cellular Band - Low Channel

Note: Offset=Cable loss (4.0) + 10log
(3.17/3)=4.0+0.2=4.2dB



Cellular Band - High Channel

Note: Offset=Cable loss (4.0) + 10log
(3.20/3)=4.0+0.2=4.2dB

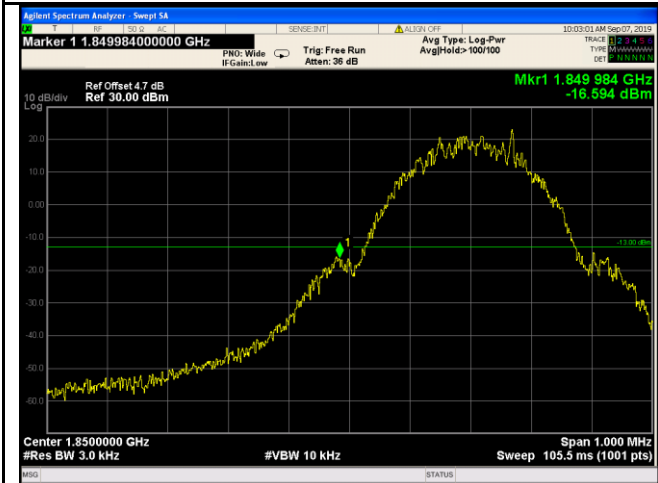

PCS Band - Low Channel

Note: Offset=Cable loss (4.5) + 10log
(3.14/3)=4.5+0.2=4.7dB



PCS Band - High Channel

Note: Offset=Cable loss (4.5) + 10log
(3.18/3)=4.5+0.3=4.8dB



Test Report No.	Q200102S012 -FCC-R1
Page	74 of 91

EGPRS (MSC1):
Test Plots

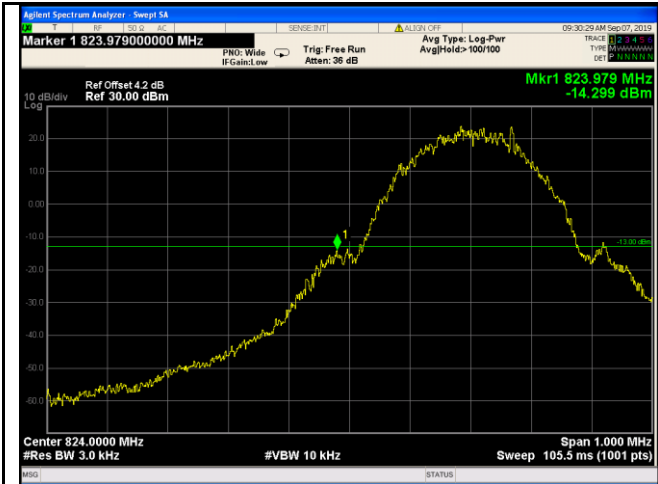

Cellular Band - Low Channel

Note: Offset=Cable loss (4.0) + 10log
(3.16/3)=4.0+0.2=4.2dB



Cellular Band - High Channel

Note: Offset=Cable loss (4.0) + 10log
(3.17/3)=4.0+0.3=4.3dB

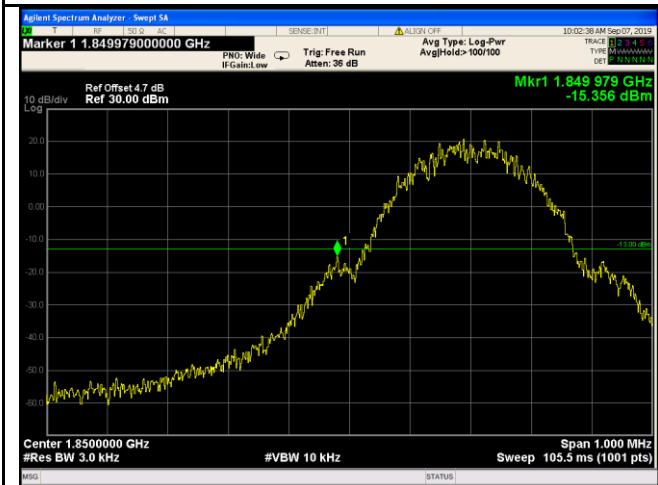

PCS Band - Low Channel

Note: Offset=Cable loss (4.5) + 10log
(3.18/3)=4.5+0.2=4.7dB

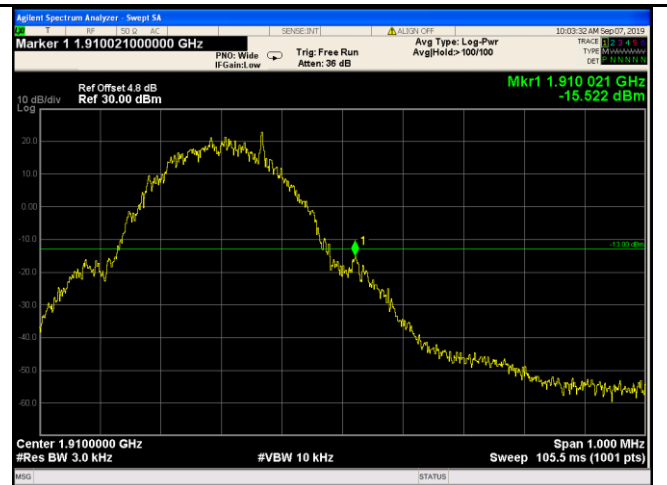

PCS Band - High Channel

Note: Offset=Cable loss (4.5) + 10log
(3.18/3)=4.5+0.3=4.8dB



Test Report No.	Q200102S012 -FCC-R1
Page	75 of 91

RMC:

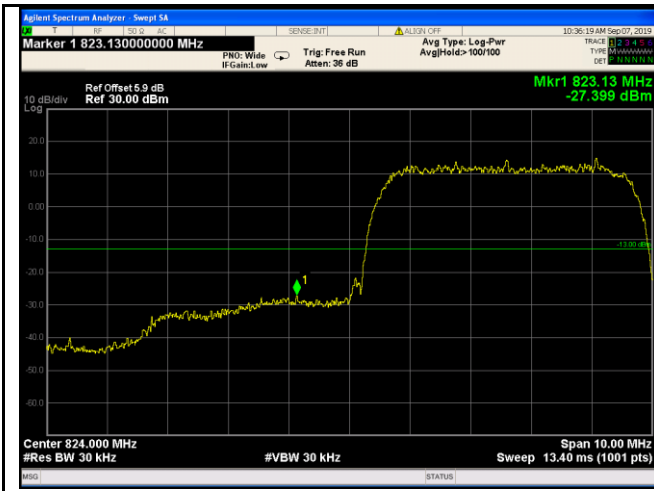

UMTS-FDD Band V - Low Channel

Note: Offset=Cable loss (4.0) + 10log
 (46.81/30)=4.0+1.9=5.9 dB

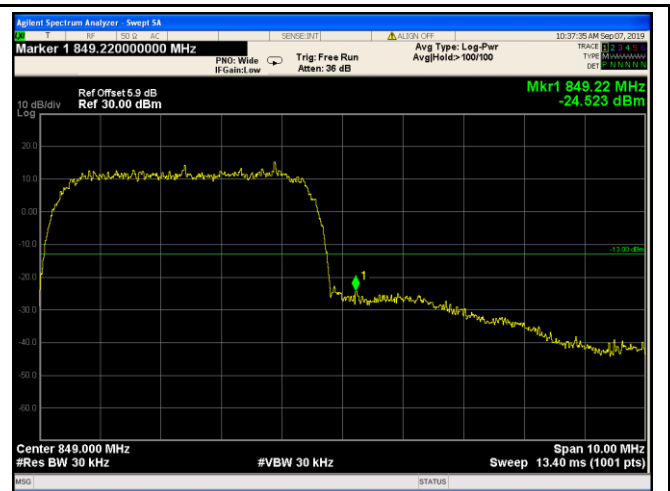

UMTS-FDD Band V - High Channel

Note: Offset=Cable loss (4.0) + 10log
 (46.82/30)=4.0+1.9 =5.9dB

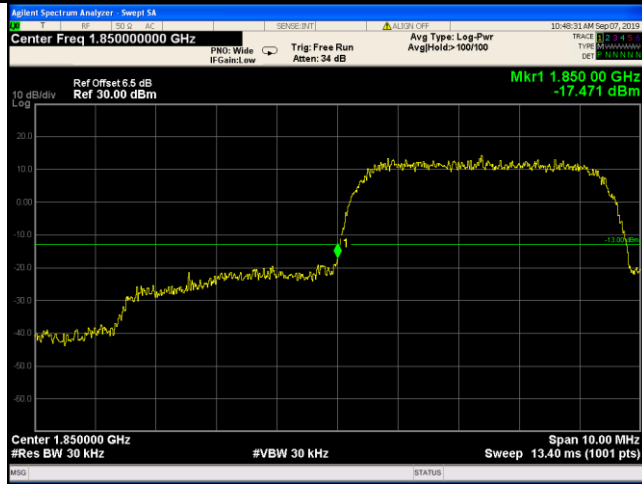

UMTS-FDD Band II - Low Channel

Note: Offset=Cable loss (4.5) + 10log
 (47.04 /30)=4.5+2.0 =6.5dB



UMTS-FDD Band II - High Channel

Note: Offset=Cable loss (4.5) + 10log
 (47.37/30)=4.5+2.0=6.5dB