

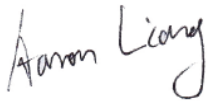
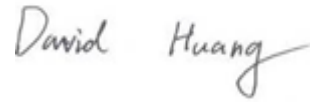

RF TEST REPORT

Report No.: Q200102S012-FCC-R4

Supersede Report No.: N/A

Applicant	ZTE Corporation
Product Name	3G Smart Feature Phone
Model No.	Z2317
Serial No.	N/A
Test Standard	FCC Part 15.247, ANSI C63.10: 2013
Test Date	Sep 02 to 09, 2019
Issue Date	Jan. 21, 2020
Test Result	<input checked="" type="checkbox"/> Pass <input type="checkbox"/> Fail
Equipment complied with the specification	<input checked="" type="checkbox"/>
Equipment did not comply with the specification	<input type="checkbox"/>
	
Aaron Liang Test Engineer	David Huang Checked By
<p>This test report may be reproduced in full only Test result presented in this test report is applicable to the tested sample only</p>	

Issued by:

BUREAU VERITAS (SHENZHEN) CONSUMER PRODUCTS SERVICES CO., LTD

Zone A, Floor 1, Building 2 Wan Ye Long Technology Park

South Side of Zhoushi Road, Bao'an District, Shenzhen, Guangdong China 518108

Phone: +86 0755 2601 4629801 Email: China@siemic.com.cn



Test Report No.	Q200102S012-FCC-R4
Page	2 of 39

This page has been left blank intentionally.



Test Report No.	Q200102S012-FCC-R4
Page	3 of 39

CONTENTS

1. REPORT REVISION HISTORY	4
2. CUSTOMER INFORMATION	4
3. TEST SITE INFORMATION	4
4. EQUIPMENT UNDER TEST (EUT) INFORMATION	5
5. TEST SUMMARY	7
6. MEASUREMENTS, EXAMINATION AND DERIVED RESULTS	8
6.1 ANTENNA REQUIREMENT	8
6.2 DTS (6 DB) CHANNEL BANDWIDTH	9
6.3 MAXIMUM OUTPUT POWER	12
6.4 POWER SPECTRAL DENSITY	15
6.5 BAND-EDGE & UNWANTED EMISSIONS INTO RESTRICTED FREQUENCY BANDS.....	17
6.6 AC POWER LINE CONDUCTED EMISSIONS	20
6.7 RADIATED EMISSIONS & RESTRICTED BAND	24
ANNEX A. TEST INSTRUMENT	32
ANNEX B. TEST SETUP AND SUPPORTING EQUIPMENT	35
ANNEX C. USER MANUAL / BLOCK DIAGRAM / SCHEMATICS / PARTLIST/ DECLARATION OF SIMILARITY.....	39



Test Report No.	Q200102S012-FCC-R4
Page	4 of 39

1. Report Revision History

Report No.	Report Version	Description	Issue Date
Q200102S012-FCC-R4	NONE	Original	Jan. 21, 2020

2. Customer information

Applicant Name	ZTE Corporation
Applicant Add	ZTE Plaza, Keji Road South, Hi-Tech, Industrial Park, Nanshan District, Shenzhen, Guangdong, 518057, P.R. China
Manufacturer	ZTE Corporation
Manufacturer Add	ZTE Plaza, Keji Road South, Hi-Tech, Industrial Park, Nanshan District, Shenzhen, Guangdong, 518057, P.R. China

3. Test site information

Lab performing tests	BUREAU VERITAS (SHENZHEN) CONSUMER PRODUCTS SERVICES CO., LTD
Lab Address	Zone A, Floor 1, Building 2 Wan Ye Long Technology Park South Side of Zhoushi Road, Bao'an District, Shenzhen, Guangdong China 518108
FCC Test Site No.	535293
IC Test Site No.	4842E-1
Test Software	Radiated Emission Program-To Shenzhen v2.0



Test Report No.	Q200102S012-FCC-R4
Page	5 of 39

4. Equipment under Test (EUT) Information

Description of EUT:	3G Smart Feature Phone
Main Model:	Z2317
Serial Model:	N/A
Date EUT received:	Aug 28, 2019
Test Date(s):	Sep 02 to 09, 2019
Equipment Category :	DTS
Antenna Gain:	GSM850: -1dBi PCS1900: -1.5dBi UMTS-FDD Band V: -1dBi UMTS-FDD Band II: -1.5dBi WIFI: 0dBi Bluetooth/BLE: 0dBi
Antenna Type:	PIFA antenna
Type of Modulation:	GSM / GPRS: GMSK EGPRS: GMSK UMTS-FDD: QPSK 802.11b/g/n: DSSS, OFDM Bluetooth: GFSK, π /4DQPSK, 8DPSK BLE: GFSK GPS: BPSK
RF Operating Frequency (ies):	GSM850 TX: 824.2 ~ 848.8 MHz; RX: 869.2 ~ 893.8 MHz PCS1900 TX: 1850.2 ~ 1909.8 MHz; RX: 1930.2 ~ 1989.8 MHz UMTS-FDD Band V TX: 826.4 ~ 846.6 MHz; RX: 871.4 ~ 891.6 MHz UMTS-FDD Band II TX: 1852.4 ~ 1907.6 MHz; RX: 1932.4 ~ 1987.6 MHz WIFI: 802.11b/g/n(20M): 2412-2462 MHz WIFI: 802.11n(40M): 2422-2452 MHz Bluetooth& BLE: 2402-2480 MHz



Test Report No.	Q200102S012-FCC-R4
Page	6 of 39

GPS: 1575.42 MHz

Max. Output Power: -0.29dBm

Number of Channels: GSM 850: 124CH
PCS1900: 299CH
UMTS-FDD Band V: 102CH
UMTS-FDD Band II: 277CH
WIFI :802.11b/g/n(20M): 11CH
WIFI :802.11n(40M): 7CH
Bluetooth: 79CH
BLE: 40CH
GPS:1CH

Port: Please refer to the user's manual

Trade Name : ZTE

Adapter 1:
Model: TPA-97050050U01
Input: AC100-240V~50/60Hz,0.15A
Output: DC 5.0V, 500mA

Input Power: Adapter 2:
Model: 50.069MX03
Input: AC100-240V~50/60Hz,0.2A
Output: DC 5.0V, 500mA

Battery :
Model: 5C1001
Spec: 3.7V, 1000mAh/3.7Wh
Limited charge voltage: 4.2

FCC ID: SRQ-ZTEZ2317



Test Report No.	Q200102S012-FCC-R4
Page	7 of 39

5. Test Summary

The product was tested in accordance with the following specifications.

All testing has been performed according to below product classification:

FCC Rules	Description of Test	Result
§15.203	Antenna Requirement	Compliance
§15.247 (a)(2)	DTS (6 dB) CHANNEL BANDWIDTH	Compliance
§15.247(b)(3)	Conducted Maximum Output Power	Compliance
§15.247(e)	Power Spectral Density	Compliance
§15.247(d)	Band-Edge & Unwanted Emissions into Restricted Frequency Bands	Compliance
§15.207 (a),	AC Power Line Conducted Emissions	Compliance
§15.205, §15.209, §15.247(d)	Radiated Emissions & Unwanted Emissions into Restricted Frequency Bands	Compliance

Measurement Uncertainty

Emissions		
Test Item	Description	Uncertainty
Band-Edge & Unwanted Emissions into Restricted Frequency Bands and Radiated Emissions & Unwanted Emissions into Restricted Frequency Bands	Confidence level of approximately 95% (in the case where distributions are normal), with a coverage factor of 2 (for EUTs < 0.5m X 0.5m X 0.5m)	+5.6dB/-4.5dB
-	-	-



Test Report No.	Q200102S012-FCC-R4
Page	8 of 39

6. Measurements, Examination And Derived Results

6.1 Antenna Requirement

Applicable Standard

According to § 15.203, an intentional radiator shall be designed to ensure that no antenna other than that furnished by the responsible party shall be used with the device. The use of a permanently attached antenna or of an antenna that uses a unique coupling to the intentional radiator shall be considered sufficient to comply with the provisions of this section. The manufacturer may design the unit so that a broken antenna can be replaced by the user, but the user of a standard antenna jack or electrical connector is prohibited. The structure and application of the EUT were analyzed to determine compliance with section §15.203 of the rules. §15.203 state that the subject device must meet the following criteria:

- a. Antenna must be permanently attached to the unit.
- b. Antenna must use a unique type of connector to attach to the EUT.

Unit must be professionally installed, and installer shall be responsible for verifying that the correct antenna is employed with the unit.

And according to FCC 47 CFR section 15.247 (b), if the transmitting antennas of directional gain greater than 6dBi are used, the power shall be reduced by the amount in dB that the directional gain of the antenna exceeds 6 dBi.

Antenna Connector Construction

The EUT has 2 antennas:

A permanently attached PIFA antenna for Bluetooth/BLE/WIF/GPS, the gain is 0dBi for Bluetooth/BLE, the gain is 0dBi for WIFI.

A permanently attached PIFA antenna for GSM/PCS/UMTS, the gain is -1dBi for GSM850, -1.5dBi for PCS1900, -1dBi for UMTS-FDD Band V, -1.5dBi for UMTS-FDD Band II.

The antenna meets up with the ANTENNA REQUIREMENT.

Result: Compliance.

6.2 DTS (6 dB) Channel Bandwidth

Temperature	25°C
Relative Humidity	57%
Atmospheric Pressure	1024mbar
Test date :	Sep 05 , 2019
Tested By :	Aaron Liang

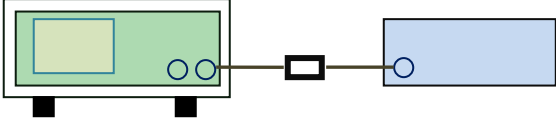
Spec	Item	Requirement	Applicable
§ 15.247(a)(2)	a)	6dB BW ≥ 500kHz;	<input checked="" type="checkbox"/>
RSS Gen(4.6.1)	b)	99% BW: For FCC reference only; required by IC.	<input checked="" type="checkbox"/>
Test Setup	 <p style="text-align: center;">Spectrum Analyzer EUT</p>		
Test Procedure	<p>558074 D01 DTS MEAS Guidance v05r02, 8.1 DTS bandwidth <u>6dB Emission bandwidth measurement procedure</u></p> <ul style="list-style-type: none"> - Set RBW = 100 kHz. - Set the video bandwidth (VBW) ≥ 3 RBW. - Detector = Peak. - Trace mode = max hold. - Sweep = auto couple. - Allow the trace to stabilize. <p>Measure the maximum width of the emission that is constrained by the frequencies associated with the two outermost amplitude points (upper and lower frequencies) that are attenuated by 6 dB relative to the maximum level measured in the fundamental emission.</p>		
Remark			
Result	<input checked="" type="checkbox"/> Pass <input type="checkbox"/> Fail		

Test Data Yes N/A

Test Plot Yes (See below) N/A



Test Report No.	Q200102S012-FCC-R4
Page	10 of 39

6dB Bandwidth measurement result

Test Data

CH	Frequency (MHz)	6dB Bandwidth (kHz)	99% Occupied Bandwidth (MHz)
Low	2402	0.704	1.0224
Mid	2440	0.696	1.0216
High	2480	0.696	1.0185

Test Plots

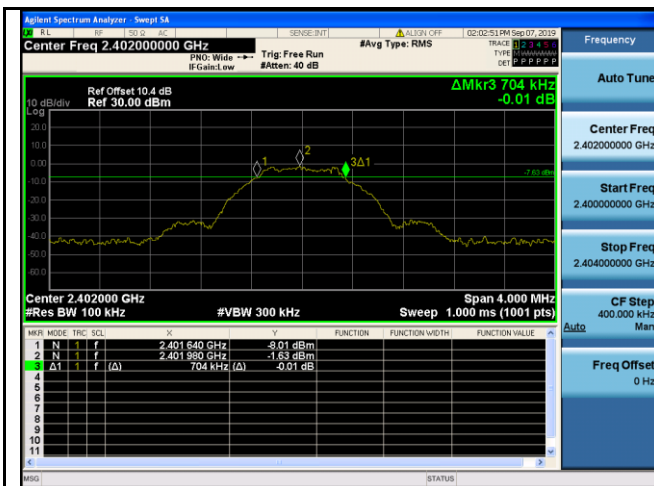

6dB Bandwidth - Low CH 2402



6dB Bandwidth - Mid CH 2440



6dB Bandwidth - High CH 2480



BUREAU VERITAS

Test Report No.	Q200102S012-FCC-R4
Page	11 of 39

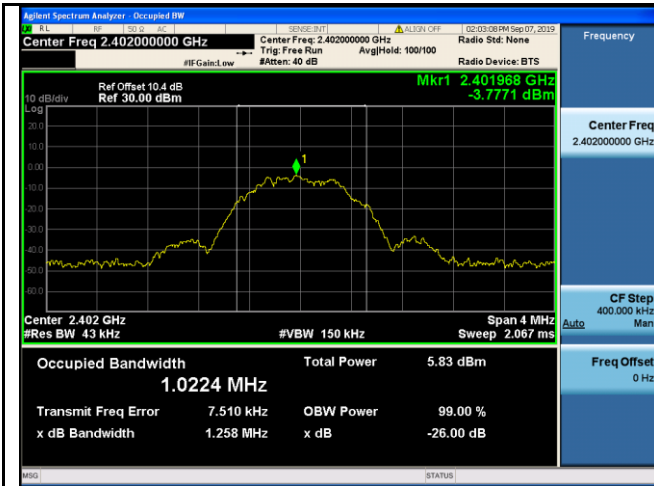

99% Occupied Bandwidth - Low CH 2402

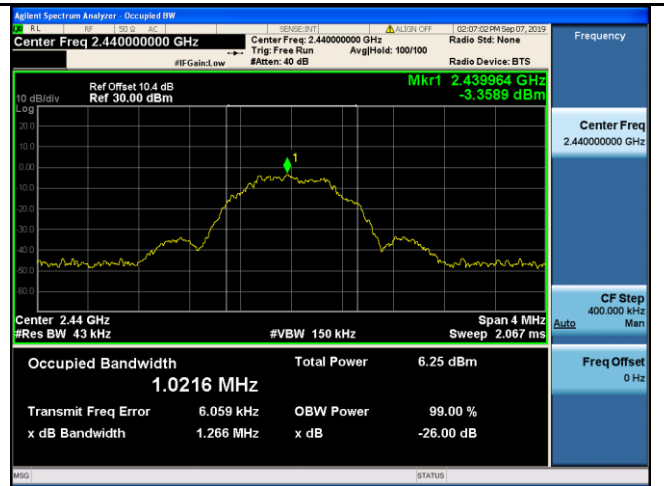

99% Occupied Bandwidth - Mid CH 2440

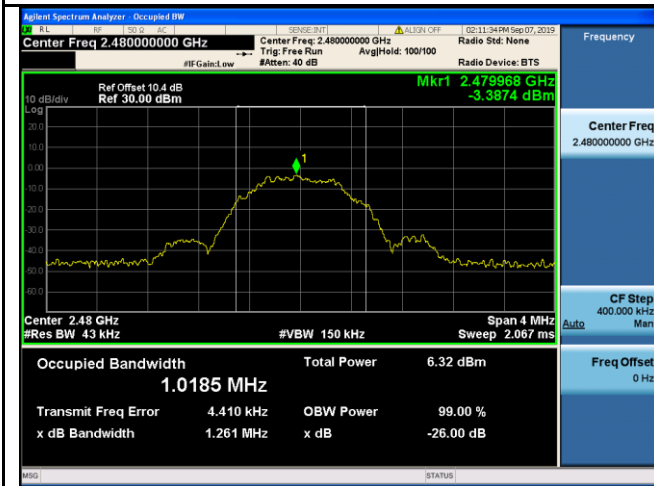

99% Occupied Bandwidth - High CH 2480

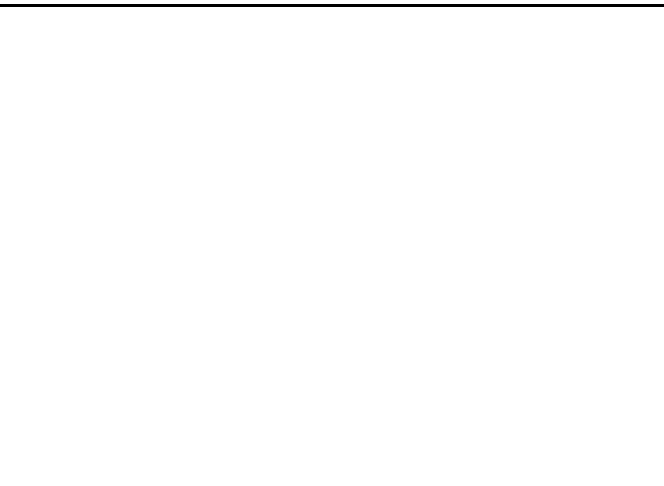

6.3 Maximum Output Power

Temperature	25°C
Relative Humidity	57%
Atmospheric Pressure	1024mbar
Test date :	Sep 07 , 2019
Tested By :	Aaron Liang

Requirement(s):

Spec	Item	Requirement	Applicable
§15.247(b) (3),RSS210 (A8.4)	a)	FHSS in 2400-2483.5MHz with ≥ 75 channels: ≤ 1 Watt	<input type="checkbox"/>
	b)	FHSS in 5725-5850MHz: ≤ 1 Watt	<input type="checkbox"/>
	c)	For all other FHSS in the 2400-2483.5MHz band: ≤ 0.125 Watt.	<input type="checkbox"/>
	d)	FHSS in 902-928MHz with ≥ 50 channels: ≤ 1 Watt	<input type="checkbox"/>
	e)	FHSS in 902-928MHz with ≥ 25 & <50 channels: ≤ 0.25 Watt	<input type="checkbox"/>
	f)	DTS in 902-928MHz, 2400-2483.5MHz: ≤ 1 Watt	<input checked="" type="checkbox"/>

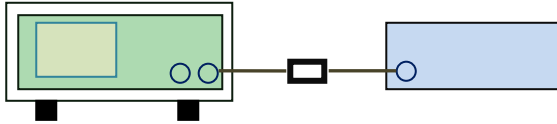
Test Setup	 <p style="text-align: center;">Spectrum Analyzer EUT</p>
------------	--

Test Procedure	<p>558074 D01 DTS MEAS Guidance v05r02, 9.1.2 Integrated band power method Maximum output power measurement procedure</p> <ol style="list-style-type: none"> Set the RBW \geq DTS bandwidth. Set VBW $\geq 3 \times$ RBW. Set span $\geq 3 \times$ RBW Sweep time = auto couple. Detector = peak. Trace mode = max hold. Allow trace to fully stabilize. Use peak marker function to determine the peak amplitude level.
----------------	---

Remark	
Result	<input checked="" type="checkbox"/> Pass <input type="checkbox"/> Fail



Test Report No.	Q200102S012-FCC-R4
Page	13 of 39

Test Data Yes N/A
 Test Plot Yes (See below) N/A

Output Power measurement result

Test Data

Type	CH	Frequency (MHz)	Conducted Power (dBm)	Limit (dBm)	Result
Output power	Low	2402	-0.30	30	Pass
	Mid	2440	0.14	30	Pass
	High	2480	0.11	30	Pass

Test Plots

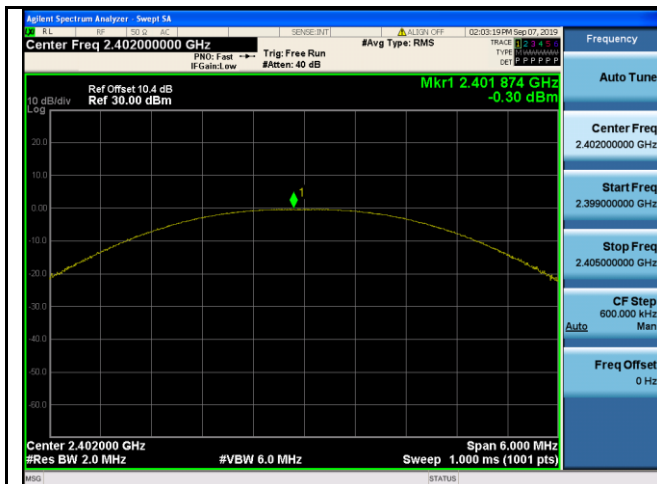

PK Output power - Low CH 2402

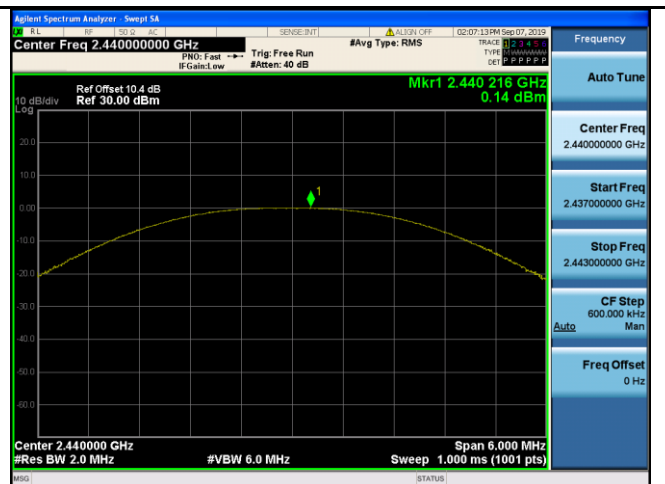

PK Output power - Mid CH 2440

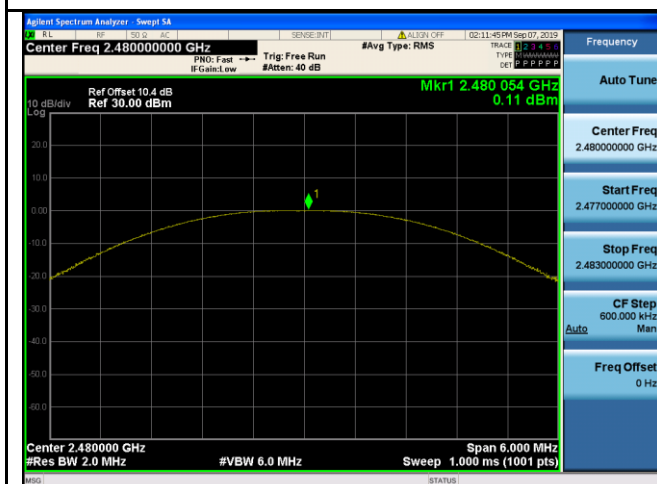

PK Output power - High CH 2480



BUREAU
VERITAS

Test Report No.	Q200102S012-FCC-R4
Page	14 of 39

Average OUTPUT POWER(FOR REFERENCE)

Test Data

CH	Frequency (MHz)	Average Power (dBm)
Low	2402	-0.63
Mid	2441	-0.29
High	2480	-0.63

6.4 Power Spectral Density

Temperature	25°C
Relative Humidity	57%
Atmospheric Pressure	1024mbar
Test date :	November 24, 2018
Tested By :	Aaron Liang

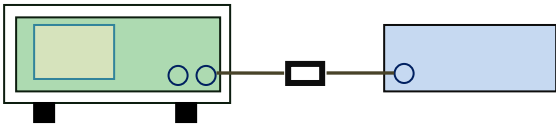
Spec	Item	Requirement	Applicable
§15.247(e)	a)	The power spectral density conducted from the intentional radiator to the antenna shall not be greater than 8 dBm in any 3 kHz band during any time interval of continuous transmission.	<input checked="" type="checkbox"/>
Test Setup	 <p style="text-align: center;">Spectrum Analyzer EUT</p>		
Test Procedure	<p>558074 D01 DTS MEAS Guidance v05r02, 10.2 power spectral density method power spectral density measurement procedure</p> <ul style="list-style-type: none"> - a) Set analyzer center frequency to DTS channel center frequency. - b) Set the span to 1.5 times the DTS bandwidth. - c) Set the RBW to: $3 \text{ kHz} \leq \text{RBW} \leq 100 \text{ kHz}$. - d) Set the VBW $\geq 3 \times \text{RBW}$. - e) Detector = peak. - f) Sweep time = auto couple. - g) Trace mode = max hold. - h) Allow trace to fully stabilize. - i) Use the peak marker function to determine the maximum amplitude level within the RBW. - j) If measured value exceeds limit, reduce RBW (no less than 3 kHz) and repeat. 		
Remark			
Result	<input checked="" type="checkbox"/> Pass <input type="checkbox"/> Fail		

Test Data Yes N/A
 Test Plot Yes (See below) N/A



Test Report No.	Q200102S012-FCC-R4
Page	16 of 39

Power Spectral Density measurement result

Test Data

Type	CH	Freq (MHz)	PSD (dBm)	Limit (dBm)	Result
PSD	Low	2402	-16.01	8	Pass
	Mid	2440	-15.53	8	Pass
	High	2480	-15.49	8	Pass

Test Plots

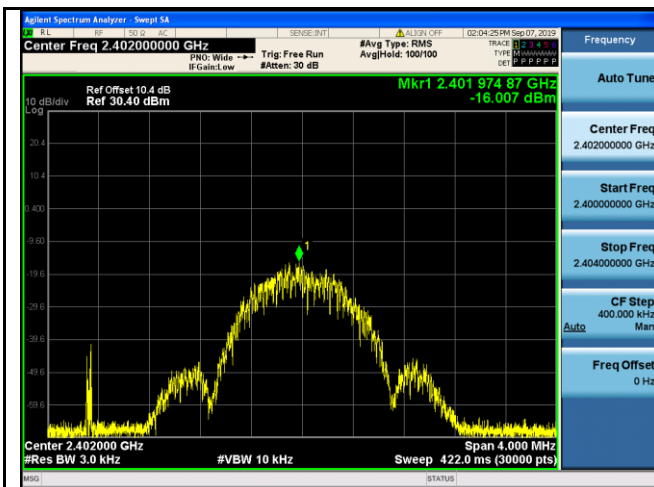

PSD - Low CH 2402

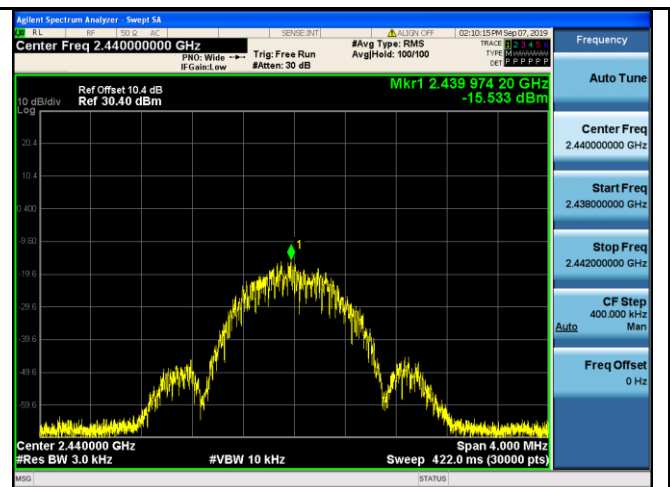

PSD - Mid CH 2440

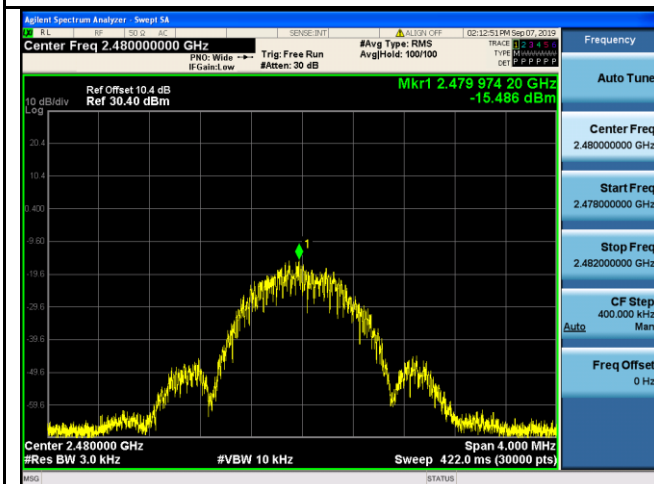

PSD - High CH 2480

6.5 Band-Edge & Unwanted Emissions into Restricted Frequency Bands

Temperature	26°C
Relative Humidity	55%
Atmospheric Pressure	1010mbar
Test date :	Sep 05 , 2019
Tested By :	Aaron Liang

Requirement(s):

Spec	Item	Requirement	Applicable
§15.247(d)	a)	In any 100 kHz bandwidth outside the frequency band in which the spread spectrum or digitally modulated intentional radiator is operating, the radio frequency power that is produced by the intentional radiator shall be at least 20 dB below that in the 100 kHz bandwidth within the band that contains the highest level of the desired power, based on either an RF conducted or a radiated measurement, provided the transmitter demonstrates compliance with the peak conducted power limits.	<input checked="" type="checkbox"/>

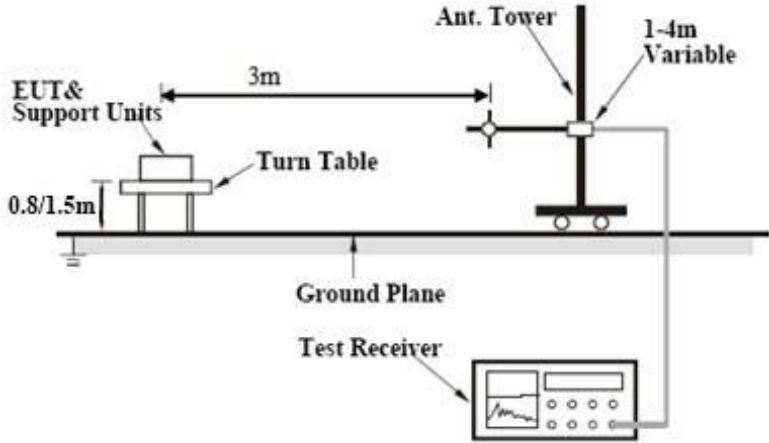
Test Setup	
------------	--

Test Procedure	<p>Radiated Method Only</p> <ul style="list-style-type: none"> - 1. Check the calibration of the measuring instrument using either an internal calibrator or a known signal from an external generator. - 2. Position the EUT without connection to measurement instrument. Put it on the Rotated table and turn on the EUT and make it operate in transmitting mode. Then set it to Low Channel and High Channel within its operating range, and make sure the instrument is operated in its linear range.
----------------	---



BUREAU
VERITAS

Test Report No.	Q200102S012-FCC-R4
Page	18 of 39

	<ul style="list-style-type: none"> - 3. First, set both RBW and VBW of spectrum analyzer to 100 kHz with a convenient frequency span including 100kHz bandwidth from band edge, check the emission of EUT, if pass then set Spectrum Analyzer as below: <ul style="list-style-type: none"> a. The resolution bandwidth and video bandwidth of test receiver/spectrum analyzer is 120 kHz for Quasiy Peak detection at frequency below 1GHz. b. The resolution bandwidth of test receiver/spectrum analyzer is 1MHz and video bandwidth is 3MHz with Peak detection for Peak measurement at frequency above 1GHz. c. The resolution bandwidth of test receiver/spectrum analyzer is 1MHz and the video bandwidth is 10Hz with Peak detection for Average Measurement as below at frequency above 1GHz. - 4. Measure the highest amplitude appearing on spectral display and set it as a reference level. Plot the graph with marking the highest point and edge frequency. - 5. Repeat above procedures until all measured frequencies were complete.
Remark	
Result	<input checked="" type="checkbox"/> Pass <input type="checkbox"/> Fail

Test Data Yes N/A

Test Plot Yes (See below) N/A



Test Report No.	Q200102S012-FCC-R4
Page	19 of 39

Test Plots

Band Edge measurement result

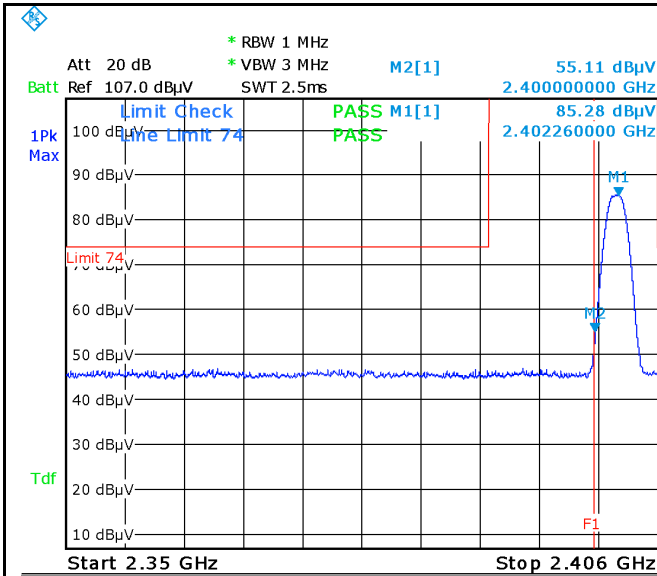

Date: 5.SEP.2019 14:25:59

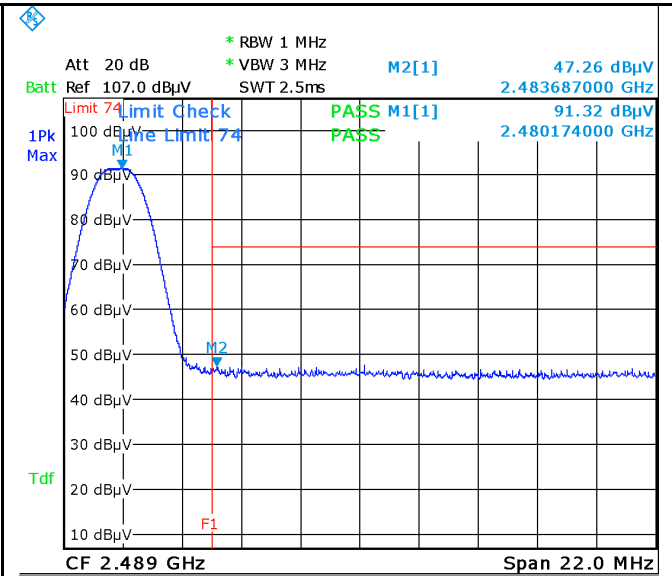

Date: 5.SEP.2019 14:07:39

Band Edge, Left Side (Peak)

Note: F1 is frequency 2390MHz; F2 is frequency 2400MHz

Band Edge, Right Side (Peak)

Note: F1 is frequency 2483.5MHz

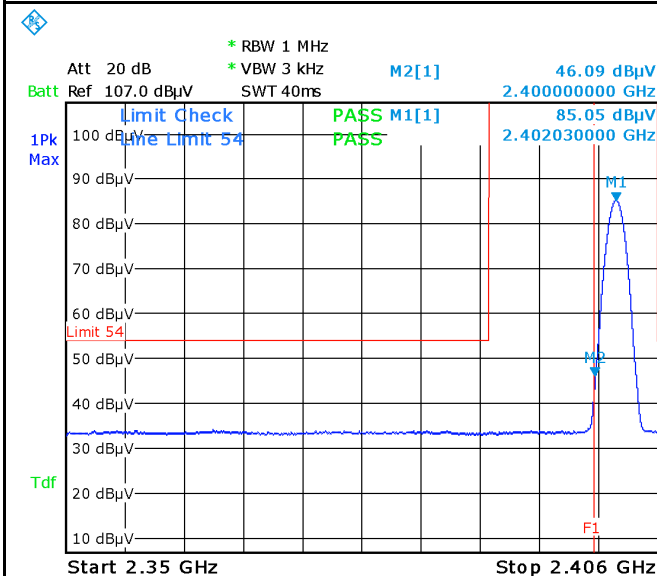

Date: 5.SEP.2019 14:27:45

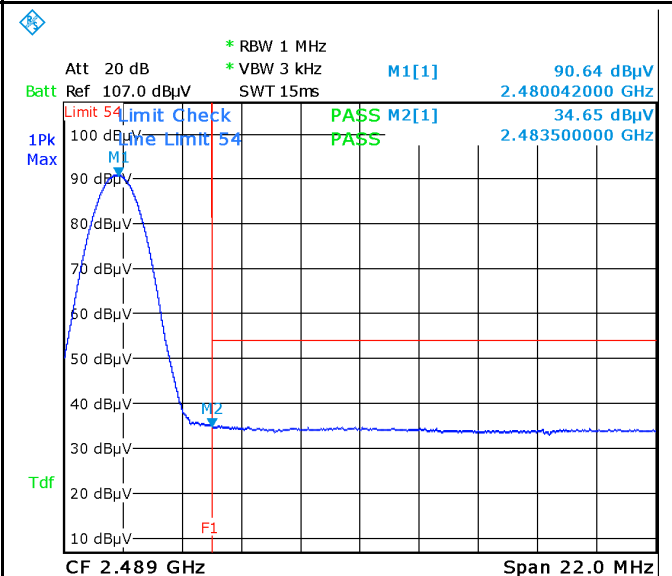

Date: 5.SEP.2019 14:09:45

Band Edge, Left Side-AV

Band Edge, Right Side-AV

Note: Both Horizontal and vertical polarities were investigated.

6.6 AC Power Line Conducted Emissions

Temperature	26°C
Relative Humidity	55%
Atmospheric Pressure	1010mbar
Test date :	Sep 05 , 2019
Tested By :	Aaron Liang

Requirement(s):

Spec	Item	Requirement	Applicable														
47CFR§15.207, RSS210 (A8.1)	a)	For Low-power radio-frequency devices that is designed to be connected to the public utility (AC) power line, the radio frequency voltage that is conducted back onto the AC power line on any frequency or frequencies, within the band 150 kHz to 30 MHz, shall not exceed the limits in the following table, as measured using a 50 [mu] H/50 ohms line impedance stabilization network (LISN). The lower limit applies at the boundary between the frequencies ranges.	<input checked="" type="checkbox"/>														
		<table border="1"> <thead> <tr> <th rowspan="2">Frequency ranges (MHz)</th> <th colspan="2">Limit (dBµV)</th> </tr> <tr> <th>QP</th> <th>Average</th> </tr> </thead> <tbody> <tr> <td>0.15 ~ 0.5</td> <td>66 – 56</td> <td>56 – 46</td> </tr> <tr> <td>0.5 ~ 5</td> <td>56</td> <td>46</td> </tr> <tr> <td>5 ~ 30</td> <td>60</td> <td>50</td> </tr> </tbody> </table>		Frequency ranges (MHz)	Limit (dBµV)		QP	Average	0.15 ~ 0.5	66 – 56	56 – 46	0.5 ~ 5	56	46	5 ~ 30	60	50
		Frequency ranges (MHz)			Limit (dBµV)												
				QP	Average												
0.15 ~ 0.5	66 – 56	56 – 46															
0.5 ~ 5	56	46															
5 ~ 30	60	50															

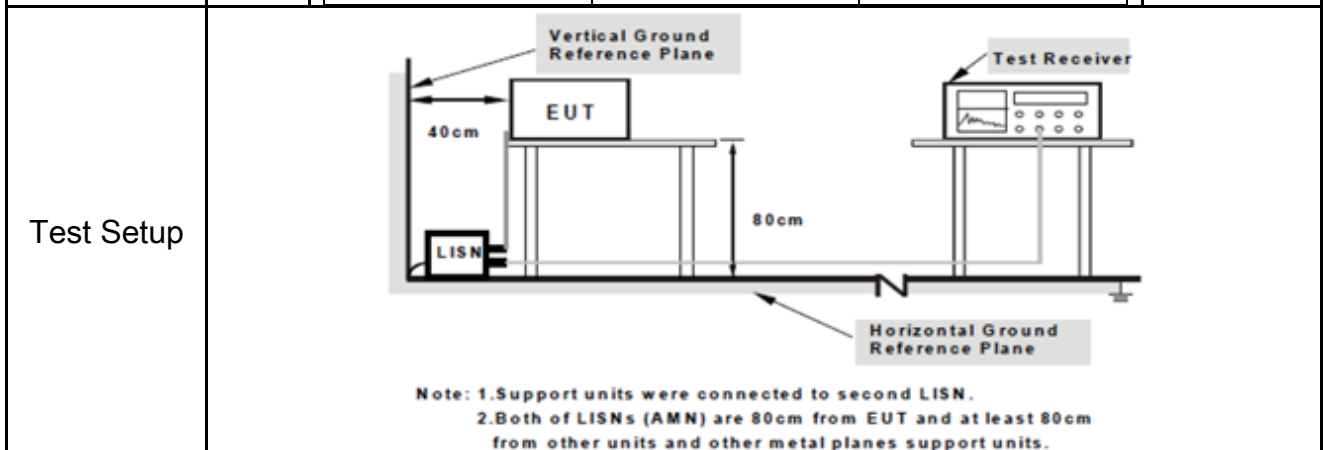

Procedure	<ol style="list-style-type: none"> The EUT and supporting equipment were set up in accordance with the requirements of the standard on top of a 1.5m x 1m x 0.8m high, non-metallic table. The power supply for the EUT was fed through a 50W/50mH EUT LISN, connected to filtered mains. The RF OUT of the EUT LISN was connected to the EMI test receiver via a low-loss
-----------	---



BUREAU
VERITAS

Test Report No.	Q200102S012-FCC-R4
Page	21 of 39

	<p>coaxial cable.</p> <ol style="list-style-type: none">4. All other supporting equipment were powered separately from another main supply.5. The EUT was switched on and allowed to warm up to its normal operating condition.6. A scan was made on the NEUTRAL line (for AC mains) or Earth line (for DC power) over the required frequency range using an EMI test receiver.7. High peaks, relative to the limit line, The EMI test receiver was then tuned to the selected frequencies and the necessary measurements made with a receiver bandwidth setting of 10 kHz.8. Step 7 was then repeated for the LIVE line (for AC mains) or DC line (for DC power).
Remark	
Result	<input checked="" type="checkbox"/> Pass <input type="checkbox"/> Fail

Test Data Yes N/A

Test Plot Yes (See below) N/A

Test Mode: **Transmitting Mode**

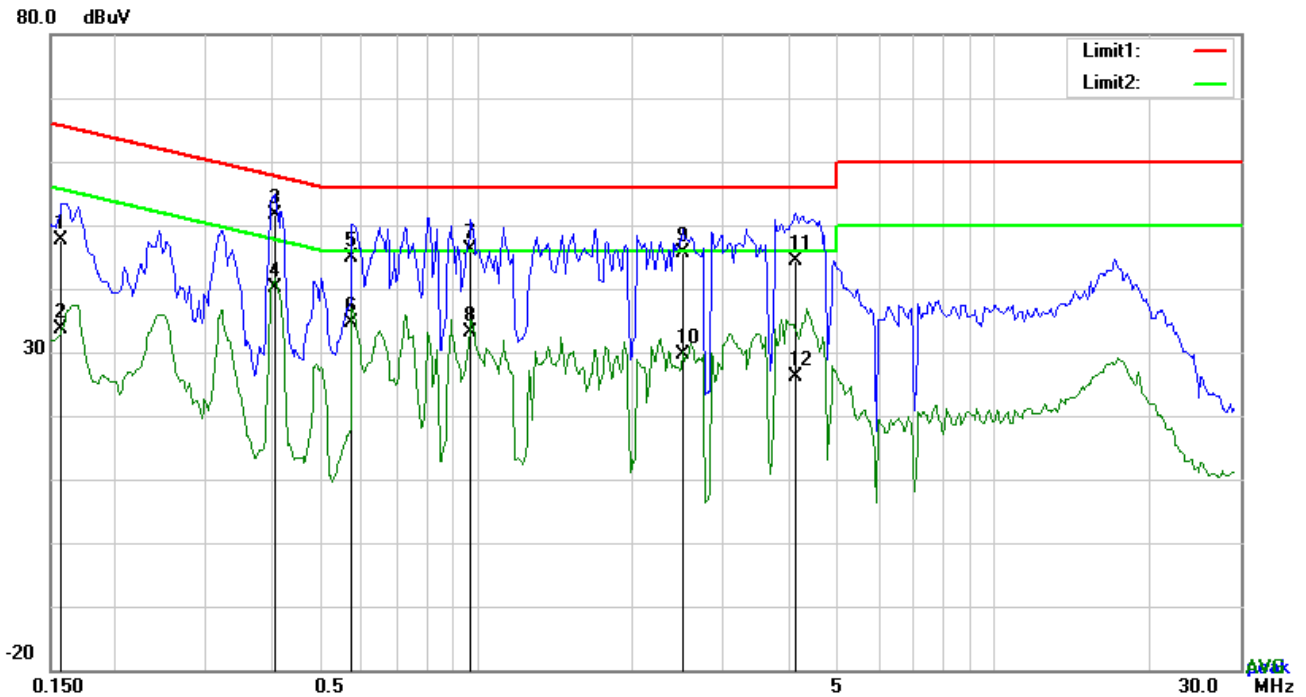

Test Data

Phase Line Plot at 120Vac, 60Hz

No.	P/L	Frequency (MHz)	Reading (dBμV)	Detector	Corrected (dB)	Result (dBμV)	Limit (dBμV)	Margin (dB)
1	L1	0.1578	37.41	QP	10.12	47.53	65.58	-18.05
2	L1	0.1578	23.56	AVG	10.12	33.68	55.58	-21.90
3	L1	0.4074	41.41	QP	10.10	51.51	57.70	-6.19
4	L1	0.4074	30.11	AVG	10.10	40.21	47.70	-7.49
5	L1	0.5751	34.71	QP	10.10	44.81	56.00	-11.19
6	L1	0.5751	24.65	AVG	10.10	34.75	46.00	-11.25
7	L1	0.9768	36.03	QP	10.13	46.16	56.00	-9.84
8	L1	0.9768	22.94	AVG	10.13	33.07	46.00	-12.93
9	L1	2.5017	35.56	QP	10.16	45.72	56.00	-10.28
10	L1	2.5017	19.49	AVG	10.16	29.65	46.00	-16.35
11	L1	4.1388	34.17	QP	10.18	44.35	56.00	-11.65
12	L1	4.1388	16.04	AVG	10.18	26.22	46.00	-19.78

Test Mode:	Transmitting Mode
-------------------	--------------------------

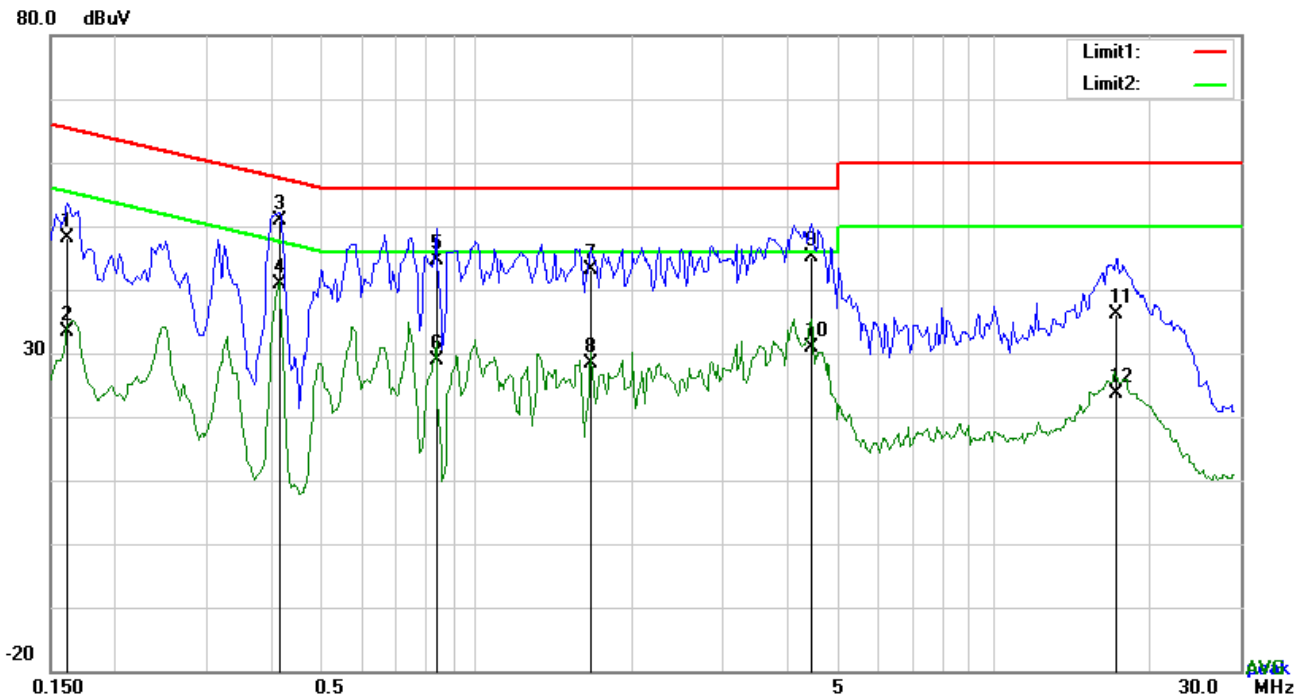

Test Data

Phase Neutral Plot at 120Vac, 60Hz

No.	P/L	Frequency (MHz)	Reading (dBμV)	Detector	Corrected (dB)	Result (dBμV)	Limit (dBμV)	Margin (dB)
1	N	0.1617	38.08	QP	10.14	48.22	65.38	-17.16
2	N	0.1617	23.31	AVG	10.14	33.45	55.38	-21.93
3	N	0.4152	40.66	QP	10.12	50.78	57.54	-6.76
4	N	0.4152	30.86	AVG	10.12	40.98	47.54	-6.56
5	N	0.8364	34.45	QP	10.14	44.59	56.00	-11.41
6	N	0.8364	18.68	AVG	10.14	28.82	46.00	-17.18
7	N	1.6632	33.00	QP	10.16	43.16	56.00	-12.84
8	N	1.6632	18.10	AVG	10.16	28.26	46.00	-17.74
9	N	4.4352	35.04	QP	10.20	45.24	56.00	-10.76
10	N	4.4352	20.63	AVG	10.20	30.83	46.00	-15.17
11	N	17.2896	25.73	QP	10.34	36.07	60.00	-23.93
12	N	17.2896	13.36	AVG	10.34	23.70	50.00	-26.30

6.7 Radiated Emissions & Restricted Band

Temperature	26°C
Relative Humidity	55%
Atmospheric Pressure	1010mbar
Test date :	Sep 05 , 2019
Tested By :	Aaron Liang

Requirement(s):

Spec	Item	Requirement	Applicable																
47CFR§15.247(d), RSS210 (A8.5)	a)	Except higher limit as specified elsewhere in other section, the emissions from the low-power radio-frequency devices shall not exceed the field strength levels specified in the following table and the level of any unwanted emissions shall not exceed the level of the fundamental emission. The tighter limit applies at the band edges	<input checked="" type="checkbox"/>																
		<table border="1"> <thead> <tr> <th>Frequency range (MHz)</th> <th>Field Strength (µV/m)</th> </tr> </thead> <tbody> <tr> <td>0.009~0.490</td> <td>2400/F(KHz)</td> </tr> <tr> <td>0.490~1.705</td> <td>24000/F(KHz)</td> </tr> <tr> <td>1.705~30.0</td> <td>30</td> </tr> <tr> <td>30 – 88</td> <td>100</td> </tr> <tr> <td>88 – 216</td> <td>150</td> </tr> <tr> <td>216 960</td> <td>200</td> </tr> <tr> <td>Above 960</td> <td>500</td> </tr> </tbody> </table>		Frequency range (MHz)	Field Strength (µV/m)	0.009~0.490	2400/F(KHz)	0.490~1.705	24000/F(KHz)	1.705~30.0	30	30 – 88	100	88 – 216	150	216 960	200	Above 960	500
		Frequency range (MHz)		Field Strength (µV/m)															
0.009~0.490		2400/F(KHz)																	
0.490~1.705		24000/F(KHz)																	
1.705~30.0		30																	
30 – 88		100																	
88 – 216		150																	
216 960	200																		
Above 960	500																		
For non-restricted band, In any 100 kHz bandwidth outside the frequency band in which the spread spectrum or digitally modulated intentional radiator is operating, the radio frequency power that is produced by the intentional radiator shall be at least 20 dB or 30dB below that in the 100 kHz bandwidth within the band that contains the highest level of the desired power, determined by the measurement method on output power to be used. Attenuation below the general limits specified in § 15.209(a) is not required	<input checked="" type="checkbox"/>																		
<input checked="" type="checkbox"/> 20 dB down <input type="checkbox"/> 30 dB down																			
c)	or restricted band, emission must also comply with the radiated emission limits specified in 15.209	<input checked="" type="checkbox"/>																	

Test Setup

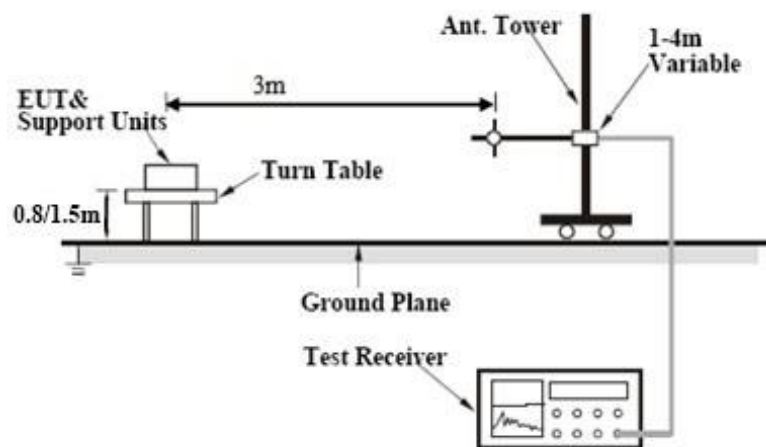
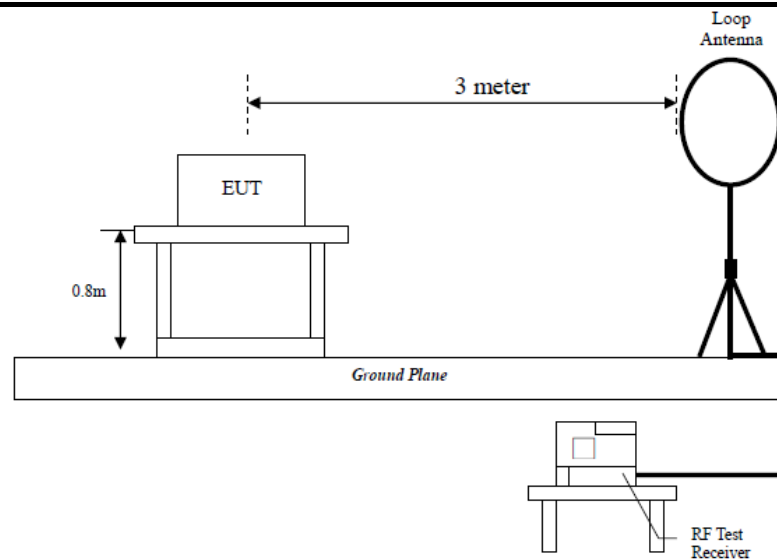

Procedure

1. The EUT was switched on and allowed to warm up to its normal operating condition.
2. The test was carried out at the selected frequency points obtained from the EUT characterization. Maximization of the emissions, was carried out by rotating the EUT, changing the antenna polarization, and adjusting the antenna height in the following manner:
 - a. Vertical or horizontal polarization (whichever gave the higher emission level over a full rotation of the EUT) was chosen.
 - b. The EUT was then rotated to the direction that gave the maximum emission.
 - c. Finally, the antenna height was adjusted to the height that gave the maximum emission.
3. The resolution bandwidth and video bandwidth of test receiver/spectrum analyzer is 120 kHz for Quasi Peak detection at frequency below 1GHz.
4. The resolution bandwidth of test receiver/spectrum analyzer is 1MHz and video bandwidth is 3MHz with Peak detection for Peak measurement at frequency above 1GHz.



Test Report No.	Q200102S012-FCC-R4
Page	26 of 39

	<p>The resolution bandwidth of test receiver/spectrum analyzer is 1MHz and the video bandwidth is 10Hz with Peak detection for Average Measurement as below at frequency above 1GHz.</p> <p>5. Steps 2 and 3 were repeated for the next frequency point, until all selected frequency points were measured.</p>
Remark	
Result	<input checked="" type="checkbox"/> Pass <input type="checkbox"/> Fail

Test Data Yes N/A
 Test Plot Yes (See below) N/A

Test Result:

Test Mode:	Transmitting Mode
-------------------	-------------------

Frequency range: 9KHz - 30MHz

Freq. (MHz)	Detection value	Factor (dB/m)	Reading (dBuV/m)	Result (dBuV/m)	Limit@3m (dBuV/m)	Margin (dB)
--	--	--	--	--	--	>20
--	--	--	--	--	--	>20

Note:

The amplitude of spurious emissions which are attenuated by more than 20dB below the permissible value has no need to be reported.

Distance extrapolation factor = 40 log (specific distance/test distance)(dB);

Limit line = specific limits(dBuv) + distance extrapolation factor.

Test Mode:	Transmitting Mode
-------------------	--------------------------

30MHz -1GHz

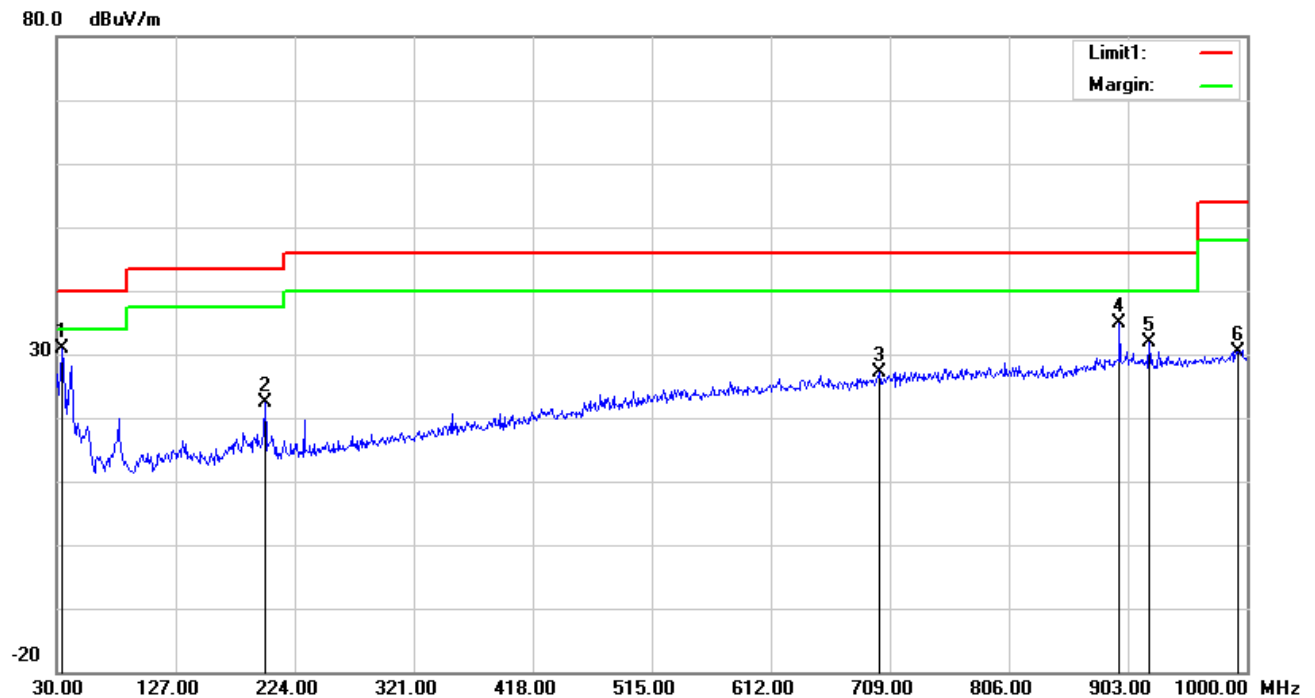

Test Data

Vertical Polarity Plot @3m

No.	P/L	Frequency (MHz)	Reading (dBuV/m)	Ant_F (dB/m)	PA_G (dB)	Cab_L (dB)	Result (dBuV/m)	Limit (dBuV/m)	Margin (dB)	Height (cm)	Degr ee (°)
1	H	34.8500	36.02	17.00	22.25	0.15	30.92	40.00	-9.08	S	169
2	H	199.7500	31.65	11.50	22.38	1.55	22.32	43.50	-21.18	100	143
3	H	700.2700	24.63	21.50	21.36	2.41	27.18	46.00	-18.82	200	217
4	H	896.2100	29.44	23.73	20.89	2.65	34.93	46.00	-11.07	100	139
5	H	920.4600	26.62	23.49	20.84	2.67	31.94	46.00	-14.06	100	143
6	H	993.2100	24.20	24.21	20.70	2.75	30.46	54.00	-23.54	200	90

30MHz -1GHz

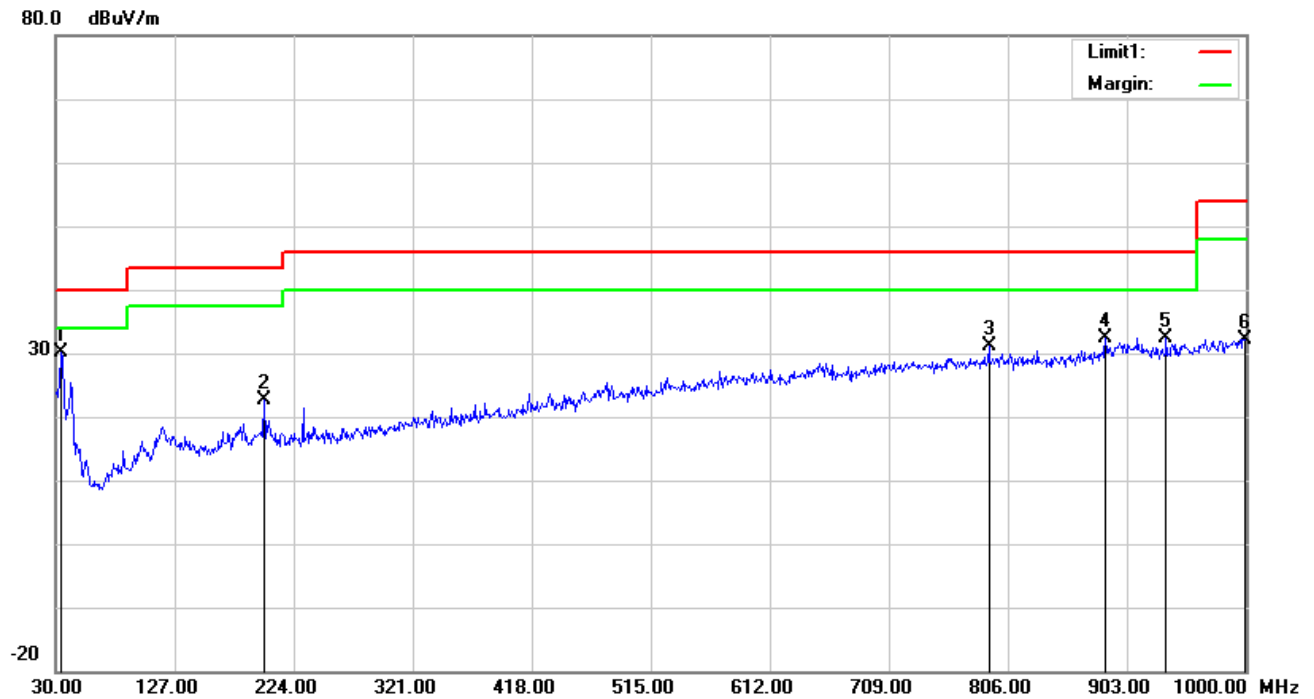

Test Data

Horizontal Polarity Plot @3m

N o.	P/ L	Frequency (MHz)	Reading (dBuV/m)	Ant_F (dB/m)	PA_G (dB)	Cab_L (dB)	Result (dBuV/m)	Limit (dBuV/m)	Margin (dB)	Height (cm)	Degr ee (°)
1	V	34.8500	35.11	17.00	22.25	0.15	30.01	40.00	-9.99	100	130
2	V	199.7500	32.03	11.50	22.38	1.55	22.70	43.50	-20.80	100	74
3	V	790.4800	27.67	22.11	21.17	2.54	31.15	46.00	-14.85	100	42
4	V	885.5400	27.35	23.26	20.92	2.64	32.33	46.00	-13.67	100	19
5	V	935.0100	26.89	23.52	20.81	2.69	32.29	46.00	-13.71	100	301
6	V	999.0300	25.79	24.37	20.69	2.76	32.23	54.00	-21.77	100	68

Above 1GHz

Test Mode:	Transmitting Mode
-------------------	--------------------------

Low Channel: GFSK Mode (Worst Case) (2402 MHz)

ANTENNA POLARITY & test distance: HORIZONTAL at 3 m								
NO	FREQ. (MHz)	EMISSION LEVEL (dBuV/m)	LIMIT (dBuV/m)	MARGIN (dB)	ANTENNA HEIGHT (m)	TABLE ANGLE (Degree)	RAW VALUE (dBuV)	CORRECTION FACTOR (dB/m)
1	4804	49.87PK	74	-24.13	270	220	63.62	-13.75
2	4804	34.86AV	54	-19.14	326	180	48.61	-13.75
ANTENNA POLARITY & test distance: Vertical at 3 m								
NO	FREQ. (MHz)	EMISSION LEVEL (dBuV/m)	LIMIT (dBuV/m)	MARGIN (dB)	ANTENNA HEIGHT (m)	TABLE ANGLE (Degree)	RAW VALUE (dBuV)	CORRECTION FACTOR (dB/m)
1	4804	49.68PK	74	-24.32	311	275	63.43	-13.75
2	4804	34.87AV	54	-19.13	202	64	48.62	-13.75

REMARKS:

1. Emission level (dBuV/m) = Raw Value (dBuV) + Correction Factor (dB/m).
2. Correction Factor (dB/m) = Antenna Factor (dB/m) + Cable Factor (dB)-Preamplifier Gain.
3. Only emissions significantly above equipment noise floor are reported.
4. Margin value = Emission level – Limit value.
5. The testing has been conformed to $10 \times 2402 \text{ MHz} = 24,020 \text{ MHz}$
6. X-Axis, Y-Axis and Z-Axis were investigated. The results above show only the worst case.

Middle Channel: GFSK Mode (Worst Case) (2440 MHz)

ANTENNA POLARITY & test distance: HORIZONTAL at 3 m								
NO	FREQ. (MHz)	EMISSION LEVEL (dBuV/m)	LIMIT (dBuV/m)	MARGIN (dB)	ANTENNA HEIGHT (m)	TABLE ANGLE (Degree)	RAW VALUE (dBuV)	CORRECTION FACTOR (dB/m)
1	4804	49.65PK	74	-15.4	357	356	62.35	-3.75
2	4804	34.77AV	54	-3.77	131	314	53.98	-3.75
ANTENNA POLARITY & test distance: Vertical at 3 m								
NO	FREQ. (MHz)	EMISSION LEVEL (dBuV/m)	LIMIT (dBuV/m)	MARGIN (dB)	ANTENNA HEIGHT (m)	TABLE ANGLE (Degree)	RAW VALUE (dBuV)	CORRECTION FACTOR (dB/m)
1	4804	49.76 PK	74	-24.24	221	57	63.51	-13.75
2	4804	34.65 AV	54	-19.35	357	183	48.4	-13.75

REMARKS:

1. Emission level (dBuV/m) = Raw Value (dBuV) + Correction Factor (dB/m).
2. Correction Factor (dB/m) = Antenna Factor (dB/m) + Cable Factor (dB)-Pre-amplifier Gain.
3. Only emissions significantly above equipment noise floor are reported.
4. Margin value = Emission level – Limit value.
5. The testing has been conformed to $10 \times 2440 \text{ MHz} = 24,400 \text{ MHz}$
6. X-Axis, Y-Axis and Z-Axis were investigated. The results above show only the worst case.

High Channel: GFSK Mode (Worst Case) (2480 MHz)

ANTENNA POLARITY & test distance: HORIZONTAL at 3 m								
NO	FREQ. (MHz)	EMISSION LEVEL (dBuV/m)	LIMIT (dBuV/m)	MARGIN (dB)	ANTENNA HEIGHT (m)	TABLE ANGLE (Degree)	RAW VALUE (dBuV)	CORRECTION FACTOR (dB/m)
1	4960	50.47PK	74	-23.53	239	316	64.22	-13.75
2	4960	35.59AV	54	-18.41	224	152	49.34	-13.75
ANTENNA POLARITY & test distance: Vertical at 3 m								
NO	FREQ. (MHz)	EMISSION LEVEL (dBuV/m)	LIMIT (dBuV/m)	MARGIN (dB)	ANTENNA HEIGHT (m)	TABLE ANGLE (Degree)	RAW VALUE (dBuV)	CORRECTION FACTOR (dB/m)
1	4960	50.14PK	74	-23.86	325	353	63.89	-13.75
2	4960	35.26AV	54	-18.74	115	3	49.01	-13.75

REMARKS:

1. Emission level (dBuV/m) = Raw Value (dBuV) + Correction Factor (dB/m).
2. Correction Factor (dB/m) = Antenna Factor (dB/m) + Cable Factor (dB)-Preamplifier Gain.
3. Only emissions significantly above equipment noise floor are reported.
4. Margin value = Emission level – Limit value.
5. The testing has been conformed to $10 \times 2462 \text{ MHz} = 24,620 \text{ MHz}$
6. X-Axis, Y-Axis and Z-Axis were investigated. The results above show only the worst case.



Test Report No.	Q200102S012-FCC-R4
Page	32 of 39

Annex A. TEST INSTRUMENT

RE& RSE

Frequency Range Below 1GHz

Equipment	Manufacturer	Model No.	Serial No.	Last Cal.	Next Cal.
EMI Test Receiver	Rohde&Schwarz	ESL6	1300.5001K06-100262-eQ	Apr. 04, 19	Apr. 03, 20
Bilog Antenna	Sunol Sciences	JB6	A110712	Apr. 08, 19	Apr. 07, 20
Active Antenna	CMO-POWER	AL-130	121031	Mar. 27, 19	Mar. 26, 20
Signal Amplifier	HP	8447E	443008	Mar. 28, 19	Mar. 27, 20
3m Semi-anechoic Chamber	SAEMC	9m*6m*6m	N/A	Oct. 18,18	Oct. 17,21
Test Software	EZ-EMC	ICP-03A1	N/A	N/A	N/A

RE& RSE

Frequency Range Above 1GHz

Equipment	Manufacturer	Model No.	Serial No.	Last Cal.	Next Cal.
Spectrum	Agilent	E4446A	MY46180622	8-May-19	7-May-20
MXA signal analyzer	Agilent	N9020A	MY49100060	Mar. 28, 19	Mar. 27, 20
Horn Antenna	COM-POWER	HAH-118	71259	Mar. 22, 19	Mar. 21, 20
Horn Antenna	COM-POWER	HAH-118	71283	Mar. 20, 19	Mar. 19, 20



BUREAU
VERITAS

Test Report No.	Q200102S012-FCC-R4
Page	33 of 39

SHF-EHF Horn	Schwarzbeck	BBHA9170	BBHA9170147	Jun. 30, 19	Jun. 29, 20
SHF-EHF Horn	Schwarzbeck	BBHA9170	BBHA9170242	Jun. 30, 19	Jun. 29, 20
AMPLIFIER	EM Electronic Corporation	EM01G26G	60613	Mar. 28, 19	Mar. 27, 20
AMPLIFIER	Emc Instruments Corporation	Emc012645	980077	Jan. 04, 19	Jan. 03,20
3m Semi-anechoic	SAEMC	9m*6m*6m	N/A	Oct. 18,18	Oct. 17,21
Test Software	EZ-EMC	ICP-03A1	N/A	N/A	N/A

Antenna Port Conducted RF measurement

Equipment	Manufacturer	Model No.	Serial No.	Last Cal.	Next Cal.
Wireless Connectivity	R&S	CMW270	1201.0002K75	Nov. 29, 18	Nov. 28, 19
MXA VEXTOR SIGNAL	Agilent	n5182a	MY50140530	Mar. 28,19	Mar. 27,20
MXA signal analyzer	Agilent	n9020a	MY49100060	Mar. 28,19	Mar. 27,20
RF Control Unit	Tonscend	JS0806-2	188060112	Mar. 28,19	Mar. 27,20
Signal Generation	Agilent	E4421B	US40051152	Nov. 29, 18	Nov. 28, 19
DC Power Supply	Agilent	E3640A	MY40004013	Mar. 28,19	Mar. 27,20
Programmable Temperature &	Hongjin	HYC-TH-225DH	DG-180746	Mar. 28,19	Mar. 27,20



BUREAU
VERITAS

Test Report No.	Q200102S012-FCC-R4
Page	34 of 39

Test System	Tonscend	JS 1120- 3	N/A	N/A	N/A
Power Splitter	Weinschel	1580-1	TL177	Mar. 20,19	Mar. 19,20
Universal Radio Communication	ROHDE&SCHWARZ	CMU200	112012	Mar. 28,19	Mar. 27,20
Universal Radio Communication	ROHDE&SCHWARZ	CMU200	121393	Mar. 28,19	Mar. 27,20
Wireless Communication Test Set	ROHDE&SCHWARZ	CMW500	1201.0002K500- 155842-Gd	Aug. 06, 19	Aug. 05, 20

Annex B. TEST SETUP AND SUPPORTING EQUIPMENT

Annex B.i. TEST SET UP BLOCK

Block Configuration Diagram for AC Line Conducted Emissions

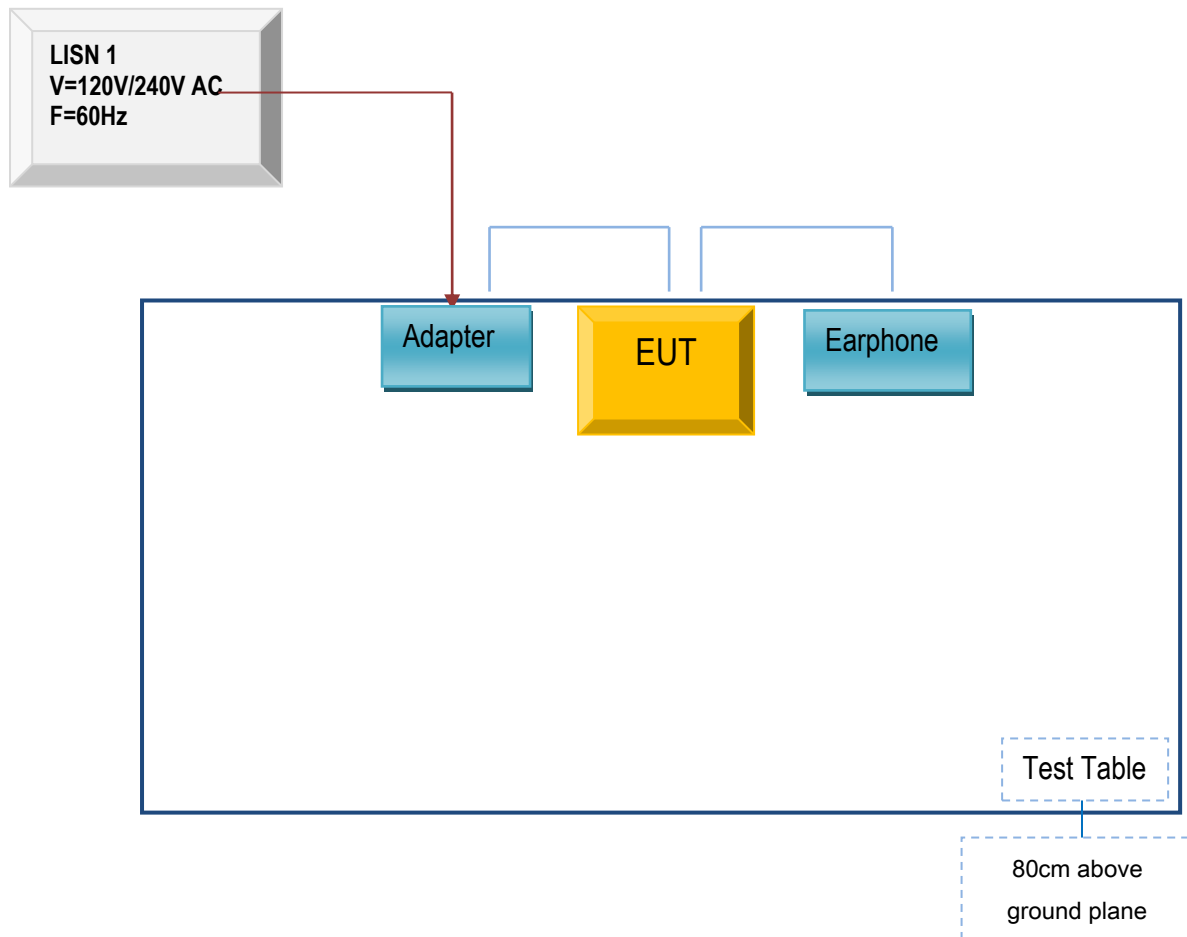



BUREAU
VERITAS

Test Report No.	Q200102S012-FCC-R4
Page	36 of 39

Block Configuration Diagram for Radiated Emissions (Below 1GHz) .

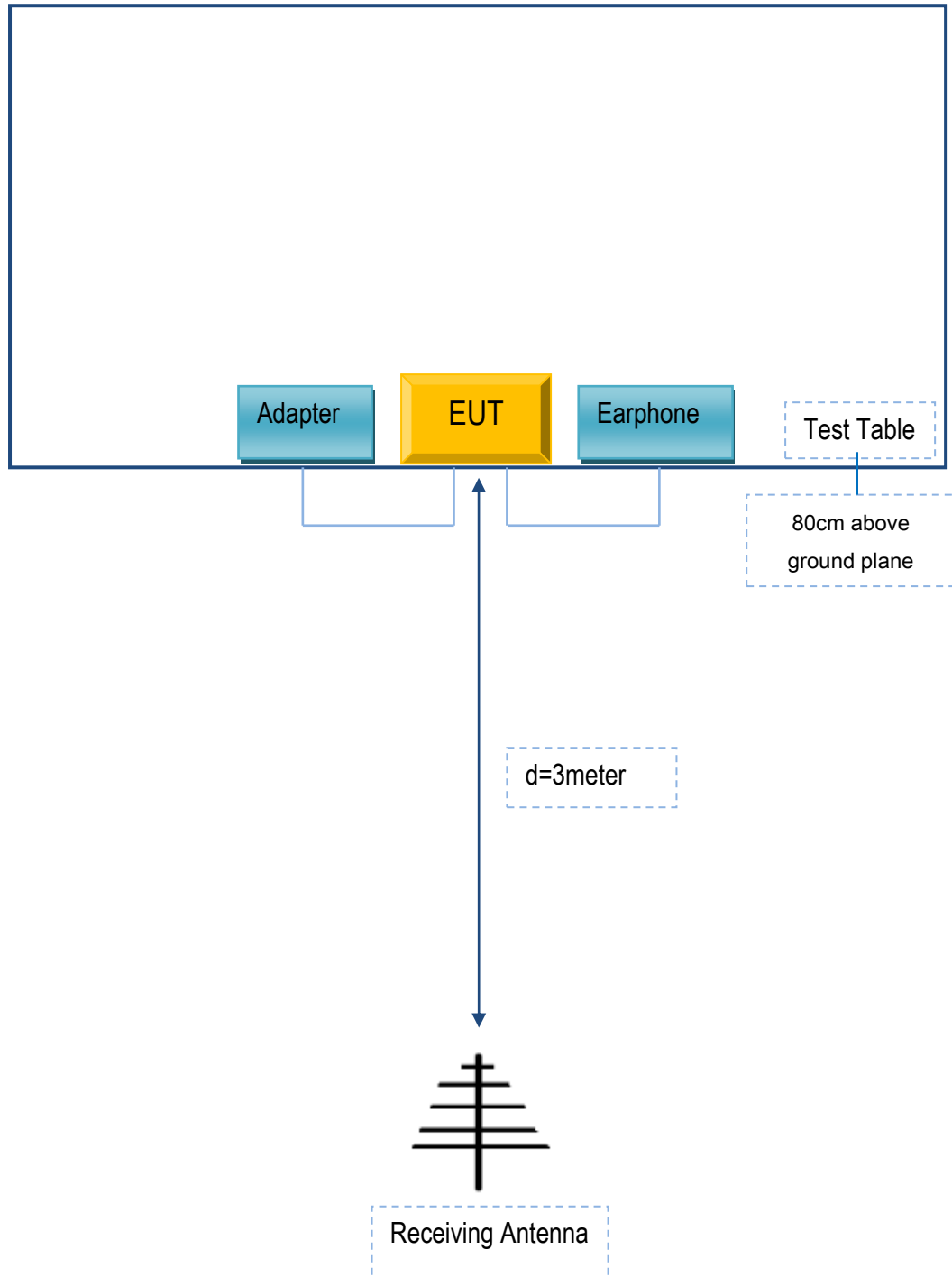

Block Configuration Diagram for Radiated Emissions (Above 1GHz) .

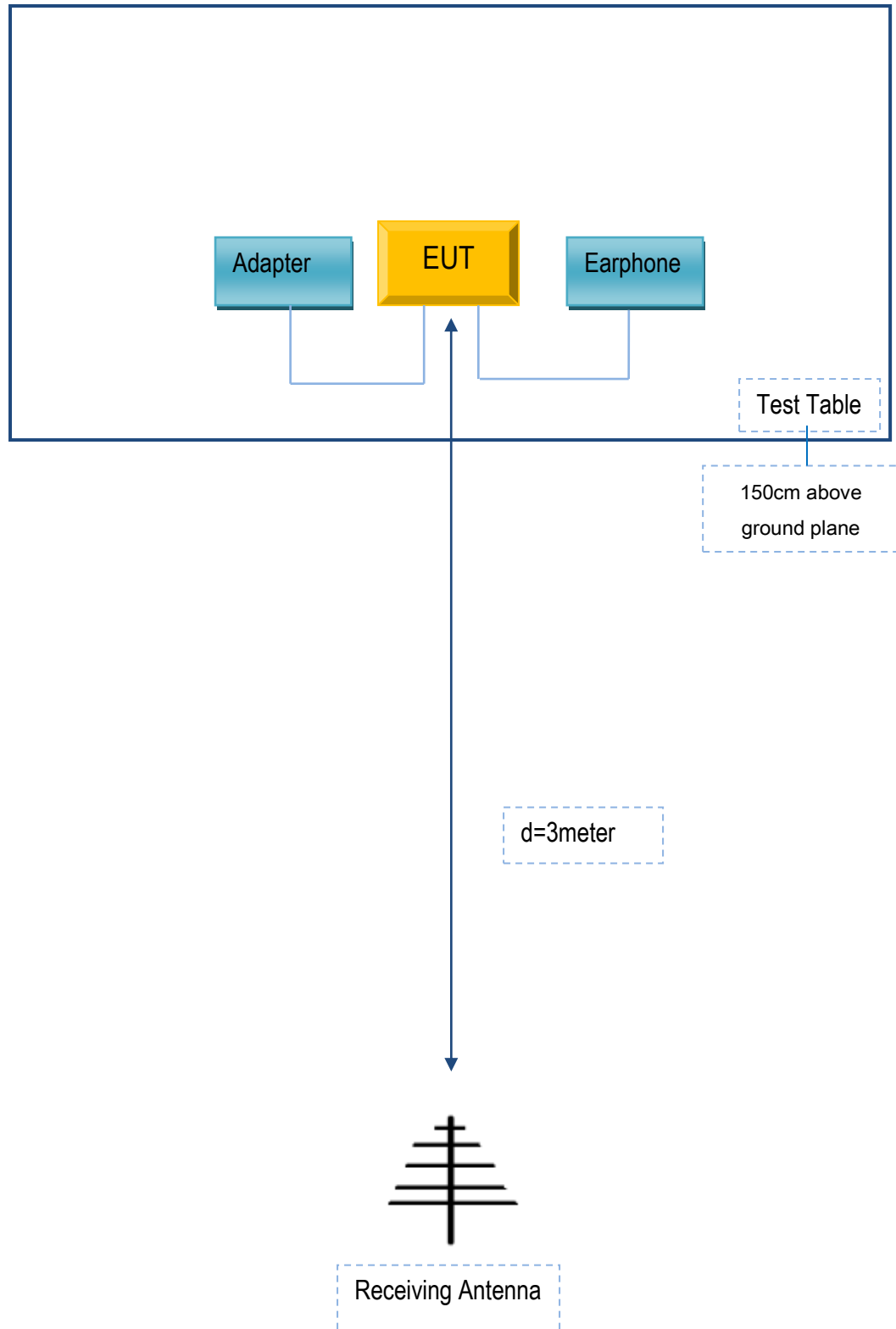

Annex C. ii. SUPPORTING EQUIPMENT DESCRIPTION

The following is a description of supporting equipment and details of cables used with the EUT.

Supporting Equipment:

Manufacturer	Equipment Description	Model	Serial No
N/A	N/A	N/A	N/A

Supporting Cable:

Cable type	Shield Type	Ferrite Core	Length	Serial No
N/A	N/A	N/A	N/A	N/A



Test Report No.	Q200102S012-FCC-R4
Page	39 of 39

Annex C. User Manual / Block Diagram / Schematics / Partlist/ DECLARATION OF SIMILARITY

Please see the attachment