



EMC TEST REPORT

Applicant ZTE Corporation
FCC ID SRQ-ZTEZ2312
Product LTE/WCDMA/CDMA/GSM(EDGE)
Feature Phone
Model ZTE Z2312, ZTE Z2312B
Marketing ZTE Z2312, ZTE Z2312B
Report No. R1812A0563-E1
Issue Date December 29, 2018

TA Technology (Shanghai) Co., Ltd. tested the above equipment in accordance with the requirements in **FCC Code CFR47 Part15B (2017)/ ANSI C63.4 (2014)**. The test results show that the equipment tested is capable of demonstrating compliance with the requirements as documented in this report.

Wei Liu

Guangchang Fan

Performed by: Wei Liu/ Manager

Approved by: Guangchang Fan/ Director

TA Technology (Shanghai) Co., Ltd.

No.145, Jintang Rd, Tangzhen Industry Park, Pudong Shanghai, China

TEL: +86-021-50791141/2/3

FAX: +86-021-50791141/2/3-8000



Table of Contents

1	Test Laboratory.....	4
1.1	Notes of the Test Report.....	4
1.2	Test facility.....	4
1.3	Testing Location.....	5
2	General Description of Equipment under Test.....	6
2.1	Client Information.....	6
2.2	General information.....	6
2.3	Applied Standards.....	8
2.4	Test Mode.....	9
3	Test Case Results.....	10
3.1	Radiated Emission.....	10
3.2	Conducted Emission.....	15
4	Main Test Instrument.....	17



Summary of measurement results

Number	Test Case	Clause in FCC Rules	Conclusion
1	Radiated Emission	15.109, ANSI C63.4-2014	PASS
2	Conducted Emission	15.107, ANSI C63.4-2014	PASS
Test Date: February 11, 2018 ~ February 28, 2018 and December 10, 2018			

1 Test Laboratory

1.1 Notes of the Test Report

This report shall not be reproduced in full or partial, without the written approval of **TA technology (shanghai) co., Ltd.** The results documented in this report apply only to the tested sample, under the conditions and modes of operation as described herein. Measurement Uncertainties were not taken into account and are published for informational purposes only. This report is written to support regulatory compliance of the applicable standards stated above.

1.2 Test facility

CNAS (accreditation number: L2264)

TA Technology (Shanghai) Co., Ltd. has obtained the accreditation of China National Accreditation Service for Conformity Assessment (CNAS).

FCC (Designation number: CN1179, Test Firm Registration Number: 446626)

TA Technology (Shanghai) Co., Ltd. has been listed on the US Federal Communications Commission list of test facilities recognized to perform electromagnetic emissions measurements.

IC (recognition number is 8510A)

TA Technology (Shanghai) Co., Ltd. has been listed by industry Canada to perform electromagnetic emission measurement.

VCCI (recognition number is C-4595, T-2154, R-4113, G-10766)

TA Technology (Shanghai) Co., Ltd. has been listed by industry Japan to perform electromagnetic emission measurement.

A2LA (Certificate Number: 3857.01)

TA Technology (Shanghai) Co., Ltd. has been listed by American Association for Laboratory Accreditation to perform electromagnetic emission measurement.



1.3 Testing Location

Company: TA Technology (Shanghai) Co., Ltd.
Address: No.145, Jintang Rd, Tangzhen Industry Park, Pudong Shanghai, China
City: Shanghai
Post code: 201201
Country: P. R. China
Contact: Xu Kai
Telephone: +86-021-50791141/2/3
Fax: +86-021-50791141/2/3-8000
Website: <http://www.ta-shanghai.com>
E-mail: xukai@ta-shanghai.com

2 General Description of Equipment under Test

2.1 Client Information

Applicant	ZTE Corporation
Applicant address	ZTE Plaza, Keji Road South, Hi-Tech, Industrial Park, Nanshan District, Shenzhen, Guangdong, 518057, P.R.China
Manufacturer	ZTE Corporation
Manufacturer address	ZTE Plaza, Keji Road South, Hi-Tech, Industrial Park, Nanshan District, Shenzhen, Guangdong, 518057, P.R.China

2.2 General information

EUT Description	
Device Type:	Portable Device
Model Number:	ZTE Z2312, ZTE Z2312B
IMEI:	868350030025522
HW Version:	A53A_V3.0G
SW Version:	H3G_ZTE-Z2312V1.0.1
Antenna Type:	PIFA antenna
Test Mode:	Transfer Data Mode
EUT Accessory	
Battery	Manufacturer: ShenZhen Ruide Electronic Industrial Co.,Ltd Model: BP-4L
Earphone	Manufacturer: SHENZHEN JUDEXING TECHNOLOGY CO., LTD. Model: JDX-A-RO-B2419-01
Auxiliary test equipment	
PC 1	PC Manufacturer: Microsoft Corporation Model: L20170076
PC 2	PC Manufacturer: Dell Model: E5430 (SN : R98M9 A02)
USB Cable	100cm Cable, Shielded
Note: The information of the EUT is declared by the manufacturer.	

The difference between model ZTE Z2312 and ZTE Z2312B is show in the below table:

		ZTE Z2312	ZTE Z2312B
Software Modifications	Camera function	Support	Removed
Hardware Modification	Camera	Support	Removed
	Flash Light	Support	Removed
Mechanical shell		With camera	no camera
Accessory		Same	Same
Note: There are more than one Model, each one should be applied throughout the compliance test respectively, however, only the worst case (model: ZTE Z2312) will be recorded in this report.			



2.3 Applied Standards

According to the specifications of the manufacturer, it must comply with the requirements of the following standards:

Test standards

FCC Code CFR47 Part15B (2017)

ANSI C63.4 (2014)

2.4 Test Mode

Test Mode	
Mode 1:	Adapter + USB cable + Camera On +GPS Rx + MP3 +Idle
Mode 2:	Adapter + USB cable + MP3 +Idle
Mode 3:	Adapter + USB cable + Idle
Mode 4:	USB Copy(EUT with PC) + USB cable + Camera On + MP3 + GPS Rx +Idle
Mode 5:	Camera On + GPS Rx +Idle
Mode 6:	MP3+Idle
Mode 7:	Idle

During the test, the preliminary test was performed in all modes (Camera/MP3/GPS) with all frequency bands (GSM/ WCDMA / BT/ Wi-Fi), mode 4 (USB Copy + USB cable + Camera On + MP3 + GPS Rx +Idle) selected as the worst condition. The test data of the worst-case condition was recorded in this report.

3 Test Case Results

3.1 Radiated Emission

Ambient condition

Temperature	Relative humidity	Pressure
24°C~26°C	45%~50%	102.5kPa

Methods of Measurement

The EUT is placed on a non-metallic table 0.8m above the horizontal metal reference ground plane. The distance between EUT and receive antenna should be 3 meters. During the test, the EUT was operating in its typical mode. The test method is according to ANSI C63.4-2014. Sweep the whole frequency band through the range from 30MHz to the 5th harmonic of the carrier. During the test, the height of receive antenna shall be moved from 1 to 4 meters, and the antenna shall be performed under horizontal and vertical polarization. The turn table shall be rotated from 0 to 360 degrees for detecting the maximum of radiated signal level.

The data of cable loss and antenna factor has been calibrated in full testing frequency range before the testing. During the test, the EUT is worked at maximum output power.

Set the spectrum analyzer in the following:

Below 1GHz:

RBW=100 kHz / VBW=300 kHz / Sweep=AUTO

Above 1GHz:

(a) PEAK: RBW=1MHz / VBW=3MHz/ Sweep=AUTO

(b) AVERAGE: RBW=1MHz / VBW=1Hz / Sweep=AUTO

The radiated emission was measured in the following position: EUT stand-up position (Z axis), lie-down position (X, Y axis). The worst emission was found in lie-down position (X axis) and the worst case was recorded.

During the test, EUT is connected to a laptop via a USB cable in the case of Transfer Data mode. The EUT is used as the peripheral equipment of the PC. The data is transferred from EUT to PC; PC is connected to server via a long LAN cable.

Test Setup

Below 1GHz

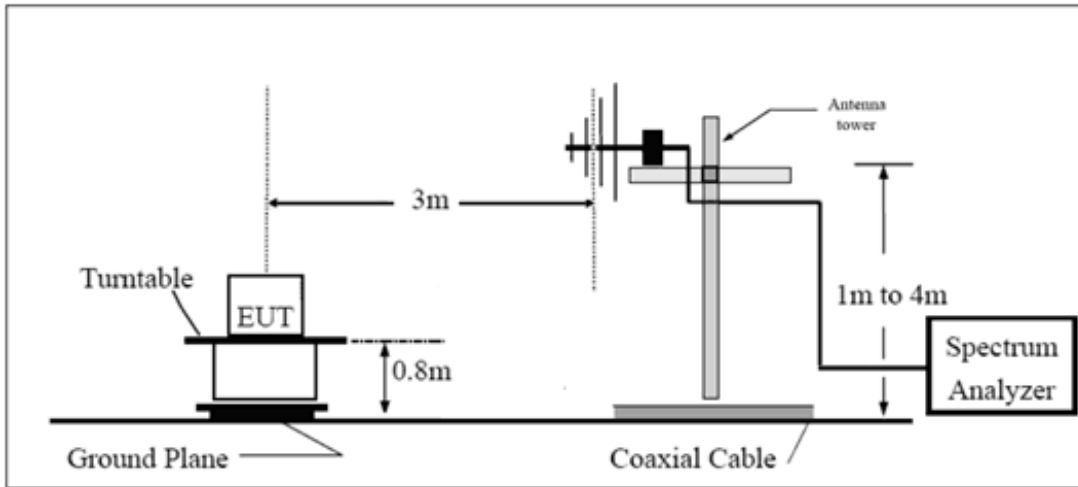

Above 1GHz

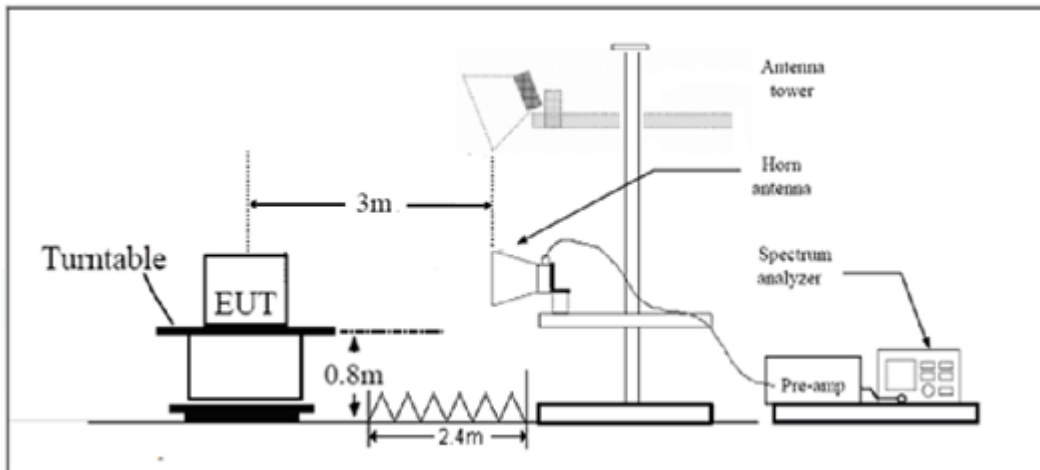

Note: Area side:2.4mX3.6m

Antenna Tower meets ANSI C63.4 requirements for measurements above 1 GHz by keeping the antenna aimed at the EUT during the antenna's ascent/ descent along the antenna mast.

Limits

Frequency (MHz)	Field Strength (dB μ V/m)	Detector
30 -88	40.0	Quasi-peak
88-216	43.5	Quasi-peak
216 – 960	46.0	Quasi-peak
960-1000	54.0	Quasi-peak
1000-5 th harmonic of the highest frequency or 40GHz, which is lower	54 74	Average Peak

Measurement Uncertainty

The assessed measurement uncertainty to ensure 95% confidence level for the normal distribution is with the coverage factor $k = 1.96$. $U = 3.704$ dB.

Test Results

The following graphs display the maximum values of horizontal and vertical by software.
 For above 1GHz, Blue trace uses the peak detection, Green trace uses the average detection.

RE 0.03-1GHz QP Class B

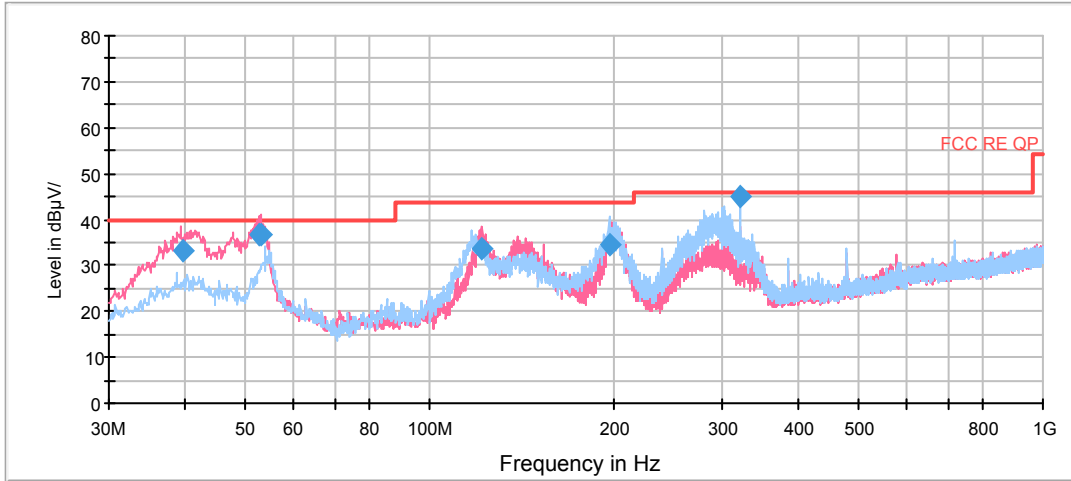

Radiated Emission from 30MHz to 1GHz

Frequency (MHz)	Quasi-Peak (dBuV/m)	Reading value (dBuV/m)	Height (cm)	Polarization	Azimuth (deg)	Correct Factor (dB)	Margin (dB)	Limit (dBuV/m)
39.536250	33.1	16.2	100.0	V	332.0	16.9	6.9	40.0
52.870000	36.5	22.6	100.0	V	91.0	13.9	3.5	40.0
52.957500	36.9	23.0	100.0	V	104.0	13.9	3.1	40.0
121.868750	33.7	22.5	100.0	V	308.0	11.2	9.8	43.5
196.672500	34.7	23.0	100.0	H	50.0	11.7	8.8	43.5
320.272500	45.0	29.1	100.0	H	254.0	15.9	1.0	46.0

- Remark:**
1. Quasi-Peak = Reading value + Correction factor
 2. Correction Factor = Antenna factor+ Insertion loss(cable loss+amplifier gain)
 3. Margin = Limit – Quasi-Peak

FCC RE 1G-18GHz PK+AV Class B

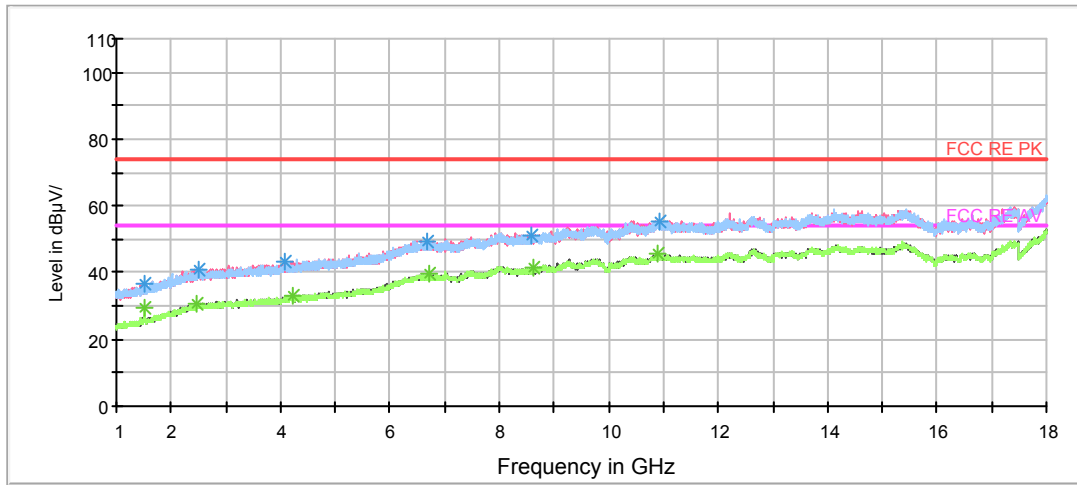

Radiated Emission from 1GHz to 18GHz

Frequency (MHz)	Peak (dBuV/m)	Reading value (dBuV/m)	Height (cm)	Polarization	Azimuth (deg)	Correct Factor (dB)	Margin (dB)	Limit (dBuV/m)
1520.625000	36.4	45.8	100.0	H	254.0	-9.4	37.6	74
2491.750000	41.1	45.4	200.0	V	7.0	-4.3	32.9	74
4070.625000	43.3	45.1	100.0	V	0.0	-1.8	30.7	74
6688.625000	49.6	44.2	200.0	V	77.0	5.4	24.4	74
8569.250000	50.9	43.0	200.0	V	63.0	7.9	23.1	74
10928.000000	55.5	42.4	100.0	V	358.0	13.1	18.5	74

Frequency (MHz)	Average (dBuV/m)	Reading value (dBuV/m)	Height (cm)	Polarization	Azimuth (deg)	Correct Factor (dB)	Margin (dB)	Limit (dBuV/m)
1520.625000	29.2	38.6	100.0	H	254.0	-9.4	24.8	54
2479.000000	30.6	34.9	100.0	V	198.0	-4.3	23.4	54
4227.875000	33.0	34.4	100.0	V	272.0	-1.4	21.0	54
6716.250000	39.6	34.2	100.0	H	60.0	5.4	14.4	54
8633.000000	41.4	33.3	100.0	V	198.0	8.1	12.6	54
10891.875000	45.6	32.5	200.0	H	152.0	13.1	8.4	54

3.2 Conducted Emission

Ambient condition

Temperature	Relative humidity	Pressure
24°C ~26°C	50%~55%	102.5kPa

Methods of Measurement

The EUT is placed on a non-metallic table of 80cm height above the horizontal metal reference ground plane. During the test, the EUT was operating in its typical mode. The test method is according to ANSI C63.4-2014. Connect the AC power line of the EUT to the L.I.S.N. Use EMI receiver to detect the average and Quasi-peak value. RBW is set to 9 kHz, VBW is set to 30kHz. The measurement result should include both L line and N line.

During the test, EUT is connected to a laptop via a USB cable in the case of Transfer Data mode. The EUT is used as the peripheral equipment of the PC. The data is transferred from EUT to PC; PC is connected to server via a long LAN cable.

Test Setup

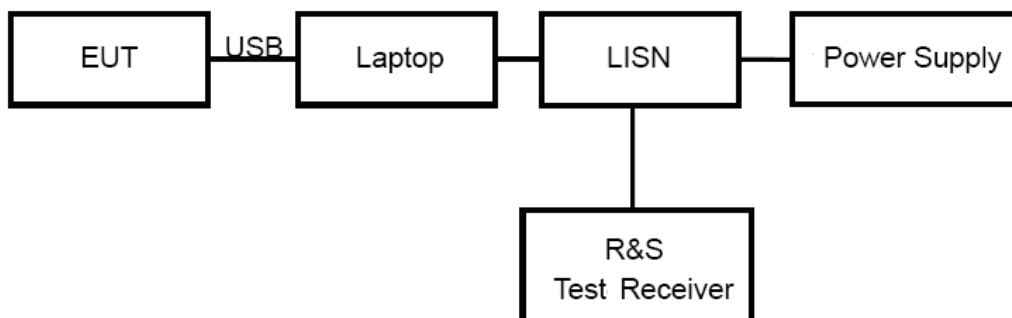

Note: Power Supply is AC Power source and it is used to change the voltage 120V/60Hz.

Limits

Frequency (MHz)	Conducted Limits(dBμV)	
	Quasi-peak	Average
0.15 - 0.5	66 to 56 *	56 to 46 *
0.5 - 5	56	46
5 - 30	60	50

*: Decreases with the logarithm of the frequency.

Measurement Uncertainty

The assessed measurement uncertainty to ensure 95% confidence level for the normal distribution is with the coverage factor $k = 1.96$. $U = 2.57$ dB.

Test Results

Following plots, Blue trace uses the peak detection; Green trace uses the average detection.

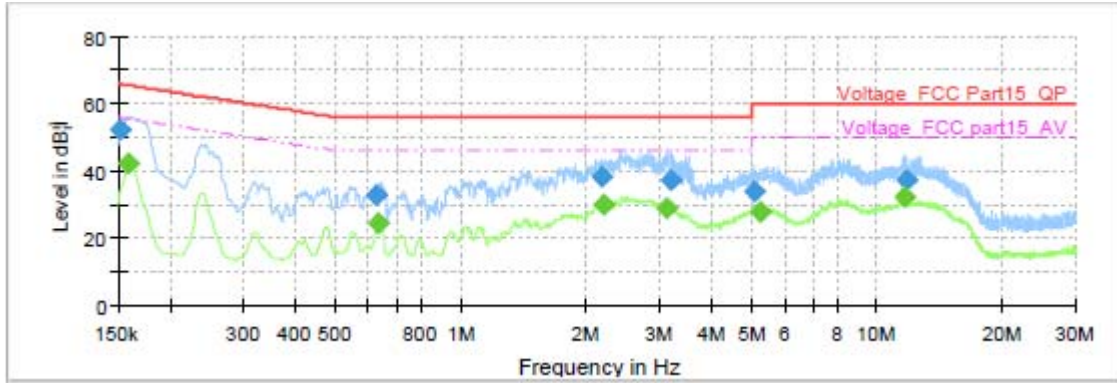

Frequency (MHz)	QuasiPeak (dB; μ V)	Average (dB; μ V)	Limit (dB; μ V)	Margin (dB)	Meas. Time (ms)	Bandwidth (kHz)	Line	Filter	Corr. (dB)
0.152250	52.30	---	65.88	13.58	1000.0	9.000	L1	ON	19.6
0.159000	---	42.19	55.52	13.33	1000.0	9.000	L1	ON	19.6
0.627000	32.52	---	56.00	23.48	1000.0	9.000	L1	ON	19.6
0.631500	---	24.38	46.00	21.62	1000.0	9.000	L1	ON	19.6
2.190750	38.31	---	56.00	17.69	1000.0	9.000	L1	ON	19.6
2.197500	---	29.74	46.00	16.26	1000.0	9.000	L1	ON	19.6
3.117750	---	28.81	46.00	17.19	1000.0	9.000	L1	ON	19.6
3.212250	37.16	---	56.00	18.84	1000.0	9.000	L1	ON	19.6
5.088750	33.85	---	60.00	26.15	1000.0	9.000	L1	ON	19.7
5.253000	---	27.59	50.00	22.41	1000.0	9.000	L1	ON	19.7
11.672250	---	31.97	50.00	18.03	1000.0	9.000	L1	ON	19.9
11.755500	37.42	---	60.00	22.58	1000.0	9.000	L1	ON	19.9

L line

Conducted Emission from 150 KHz to 30 MHz

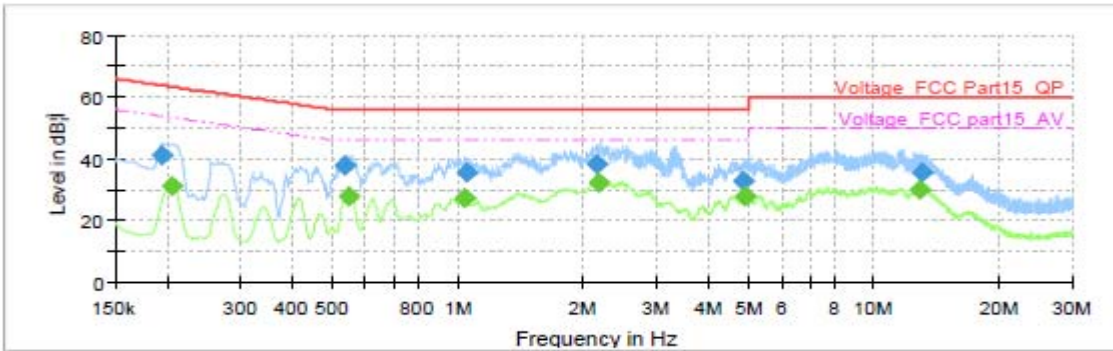

Frequency (MHz)	QuasiPeak (dB; μ V)	Average (dB; μ V)	Limit (dB; μ V)	Margin (dB)	Meas. Time (ms)	Bandwidth (kHz)	Line	Filter	Corr. (dB)
0.195000	40.86	---	63.82	22.97	1000.0	9.000	N	ON	19.7
0.206250	---	31.29	53.36	22.07	1000.0	9.000	N	ON	19.7
0.537000	37.77	---	56.00	18.23	1000.0	9.000	N	ON	19.6
0.548250	---	27.58	46.00	18.42	1000.0	9.000	N	ON	19.6
1.034250	---	27.08	46.00	18.92	1000.0	9.000	N	ON	19.6
1.045500	35.57	---	56.00	20.43	1000.0	9.000	N	ON	19.6
2.145750	38.47	---	56.00	17.53	1000.0	9.000	N	ON	19.6
2.186250	---	32.05	46.00	13.95	1000.0	9.000	N	ON	19.6
4.850250	32.67	---	56.00	23.33	1000.0	9.000	N	ON	19.7
4.915500	---	27.76	46.00	18.24	1000.0	9.000	N	ON	19.7
12.891750	---	30.24	50.00	19.76	1000.0	9.000	N	ON	19.9
13.024500	35.52	---	60.00	24.48	1000.0	9.000	N	ON	19.9

N line

Conducted Emission from 150 KHz to 30 MHz

4 Main Test Instrument

February 11, 2018 ~ February 28, 2018

Name	Manufacturer	Type	Serial Number	Last Cal.	Cal. Due Date
Signal Analyzer	R&S	FSV30	100815	2017-12-17	2018-12-16
EMI Test Receiver	R&S	ESCI	100948	2017-05-20	2018-05-19
Loop Antenna	SCHWARZBECK	FMZB1519	1519-047	2017-02-18	2019-02-17
Trilog Antenna	SCHWARZBECK	VULB 9163	9163-201	2017-11-18	2020-11-17
Horn Antenna	R&S	HF907	100126	2014-12-06	2019-12-05
Horn Antenna	ETS-Lindgren	3160-09	00102643	2015-01-30	2020-01-29
EMI Test Receiver	R&S	ESR	101667	2017-09-06	2018-09-05
LISN	R&S	ENV216	101171	2016-12-16	2019-12-15
Bore Sight Antenna mast	ETS	2171B	00058752	NA	NA
Test software	EMC32	R&S	V9.26.0	NA	NA

December 10, 2018

Name	Manufacturer	Type	Serial Number	Last Cal.	Cal. Due Date
Signal Analyzer	R&S	FSV30	100815	2018-12-17	2019-12-16
EMI Test Receiver	R&S	ESCI	100948	2018-05-20	2019-05-19
Loop Antenna	SCHWARZBECK	FMZB1519	1519-047	2017-02-18	2019-02-17
Trilog Antenna	SCHWARZBECK	VULB 9163	9163-201	2017-11-18	2020-11-17
Horn Antenna	R&S	HF907	100126	2014-12-06	2019-12-05
Horn Antenna	ETS-Lindgren	3160-09	00102643	2015-01-30	2020-01-29
EMI Test Receiver	R&S	ESR	101667	2018-09-06	2019-09-05
LISN	R&S	ENV216	101171	2016-12-16	2019-12-15
Bore Sight Antenna mast	ETS	2171B	00058752	NA	NA
Test software	EMC32	R&S	V9.26.0	NA	NA

*****END OF REPORT *****