



TEST REPORT FOR WLAN TESTING

Report No: SRTC2019-9004(F)-19042601(G)

Product Name: LTE Ufi

Product Model: MF971V

Applicant: ZTE Corporation

Manufacturer: ZTE Corporation

Specification: FCC Part 15, Subpart E (2019)

FCC ID: SRQ-MF993

The State Radio_monitoring_center Testing Center (SRTC)
15th Building, No.30, Shixing Street, Shijingshan District,
Beijing, P.R.China

Tel: 86-10-57996183 Fax: 86-10-57996388

CONTENTS

1. GENERAL INFORMATION	2
1.1 NOTES OF THE TEST REPORT	2
1.2 INFORMATION ABOUT THE TESTING LABORATORY	2
1.3 APPLICANT’S DETAILS	2
1.4 MANUFACTURER’S DETAILS	2
1.5 TEST ENVIRONMENT	3
2. DESCRIPTION OF THE DEVICE UNDER TEST	4
2.1 FINAL EQUIPMENT BUILD STATUS.....	4
2.2 WIRELESS TECHNOLOGY AND FREQUENCY RANGE	4
2.3 SUPPORT EQUIPMENT.....	6
2.4 NOTE.....	7
3 REFERENCE SPECIFICATION	8
4 KEY TO NOTES AND RESULT CODES.....	8
5. RESULT SUMMARY	9
6 TEST RESULT	10
6.1 AVERAGE CONDUCTED OUTPUT POWER	10
6.2 OCCUPIED BANDWIDTH.....	12
6.3 TRANSMITTER POWER SPECTRAL DENSITY.....	13
6.4 UNWANTED CONDUCTED EMISSION MEASUREMENT.....	15
6.5 FREQUENCY STABILITY	16
6.6 UNWANTED RADIATED EMISSION MEASUREMENT	17
6.7 AC POWER LINE CONDUCTED EMISSION	19
6.8 DYNAMIC FREQUENCY SELECTION.....	19
7 MEASUREMENT UNCERTAINTIES	28
8 TEST EQUIPMENTS	29
APPENDIX A – TEST DATA OF CONDUCTED EMISSION	30
APPENDIX B – TEST DATA OF RADIATED EMISSION	30

1. GENERAL INFORMATION

1.1 Notes of the test report

The test report may only be reproduced or published in full. Reproduction or publication of extracts from the report requires the prior written permission of The State Radio_monitoring_center Testing Center (SRTC). The test results relate only to individual items of the samples which have been tested. The certification and accreditation identifiers used in this report shall not be applicable to the tested or calibrated samples thereof. The manufacturer shall not mark the tested samples or items (or a separate part of the item) with the identifiers of certification and accreditation to mislead relevant parties about the tested samples or items.

1.2 Information about the testing laboratory

Company:	The State Radio_monitoring_center Testing Center (SRTC)
Address:	15th Building, No.30 Shixing Street, Shijingshan District, P.R.China
City:	Beijing
Country or Region:	P.R.China
Contacted person:	Liu Jia
Tel:	+86 10 57996183
Fax:	+86 10 57996388
Email:	liujiat@srtc.org.cn

1.3 Applicant's details

Company:	ZTE Corporation
Address:	ZTE Plaza, #55 Keji Road South, Hi-Tech, Industrial Park, Nanshan District,Guangdong
City:	Shenzhen
Country or Region:	P.R.China
Contacted person:	Yang Zhao
Tel:	029-83600770
Fax:	---
Email:	zhao.yangxa@zte.com.cn

1.4 Manufacturer's details

Company:	ZTE Corporation
Address:	ZTE Plaza, #55 Keji Road South, Hi-Tech, Industrial Park, Nanshan District,Guangdong
City:	Shenzhen
Country or Region:	P.R.China
Contacted person:	Yang Zhao
Tel:	029-83600770
Fax:	---
Email:	zhao.yangxa@zte.com.cn

1.5 Test Environment

Date of Receipt of test sample at SRTC:	2019-04-26
Testing Start Date:	2019-05-09
Testing End Date:	2019-05-23

Environmental Data:	Temperature (°C)	Humidity (%)
Ambient	22	30
Maximum Extreme	55	---
Minimum Extreme	-10	---

Normal Supply Voltage (V d.c.):	3.80
Maximum Extreme Supply Voltage (V d.c.):	4.35
Minimum Extreme Supply Voltage (V d.c.):	3.60

2. DESCRIPTION OF THE DEVICE UNDER TEST

2.1 Final Equipment Build Status

Frequency Band(s)	U-NII-1:5150MHz-5250MHz
Modulation Type	802.11a 802.11n (HT20/HT40) 802.11ac (VHT20/VHT40/VHT80)
Antenna Type	PIFA Antenna
Antenna Gain	Antenna 1: 1.25 dBi Antenna 2: 1.35 dBi
Power Supply	Battery/AC adapter
HW Version	dqaA
SW Version	BD_MF971VV1.0.0B01
IMEI	869626021438454

2.2 Wireless Technology and Frequency Range

Wireless Technology		Bandwidth	Channel	Frequency(MHz)
Wi-Fi	U-NII-1	20MHz	36	5180
			40	5200
			44	5220
			48	5240
		40MHz	38	5190
			46	5230
			80MHz	42

Duty Cycle Result

Mode	Duty Cycle (%)	Correction Factor(dB)	Mode	Duty Cycle (%)	Correction Factor(dB)
11a	95.72%	0.19	11ac VHT20	94.93%	0.23
11n HT20	95.52%	0.20	11ac VHT40	91.47%	0.39
11n HT40	91.94%	0.36	11ac VHT80	83.88%	1.19

Note

Mode	Frequency (MHz)	99%BW (MHz)	Max frequency edge(MHz)	Max frequency edge limit(MHz)
802.11a	5240	16.274	5248.14	5250
802.11n HT20	5240	17.407	5248.70	5250
802.11n HT20 (MIMO)	5240	17.460	5248.73	5250
802.11n HT40	5230	36.183	5248.09	5250
802.11n HT40 (MIMO)	5230	36.241	5248.12	5250
802.11ac VHT80	5210	75.025	5247.51	5250
802.11ac VHT80(MIMO)	5210	75.231	5247.62	5250

Max frequency edge(MHz)= Frequency(MHz)+ 99%BW(MHz)/2

The last channel of UNII-1 does not cross UNII-2a and does not cross the DFS band.

2.3 Support Equipment

The following support equipment was used to exercise the DUT during testing:

Equipment	Battery
Manufacturer	Zhongshan Tianmao Battery Co., Ltd.
Model Number	Li3823T43P3h715345
Serial Number	---

Equipment	Charger
Manufacturer	AOHAI
Model Number	STC-A51A-B
Serial Number	---

Equipment	Charger
Manufacturer	AOHAI
Model Number	STC-A51A-Z
Serial Number	---

Equipment	Charger
Manufacturer	SHENZHEN RUIJING INDUSTRIAL CO LTD
Model Number	STC-A51A-Z
Serial Number	---

Equipment	USB cable
Manufacturer	Shen Zhen Shi Yi HUA XING Electron Co.,Ltd
Model Number	USB-MU5-W-100-L
Serial Number	---

2.4 Note

Automatically Discontinue Transmission	
Description	The device shall automatically discontinue transmission in case of either absence of information to transmit or operational failure. These provisions are not intended to preclude the transmission of control or signaling information or the use of repetitive codes used by certain digital technologies to complete frame or burst intervals. Applicants shall include in their application for equipment authorization to describe how this requirement is met.
Result	While the EUT is not transmitting any information, the EUT can automatically discontinue transmission and become standby mode for power saving. The EUT can detect the controlling signal of ACK message transmitting from remote device and verify whether it shall resend or discontinue transmission.

The antenna provide to the EUT, please refer to the following table:

Brand	Model	Antenna gain	Frequency Bands(GHz)	Antenna type	Connector Type
N/A	N/A	Ant1:1.25dBi Ant2:1.35dBi	5150MHz-5250MHz	PIFA Antenna	N/A

Manufacturers ensure that their designs will not be modified by the user or third parties arbitrary antenna parameters and performance.

3 REFERENCE SPECIFICATION

Specification	Version	Title
15.35	2019	Measurement detector functions and bandwidths.
15.209	2019	Radiated emission limits; general requirements.
15.205	2019	Restricted bands of operation.
15.207	2019	Conducted limits.
15.407	2019	General technical requirements
ANSI C63.10	2013	Standard of Procedures for Compliance Testing of Unlicensed Wireless Devices
KDB 644545 D03	August 14, 2014	GUIDANCE FOR IEEE Std 802.11acTM DEVICES EMISSION TESTING
KDB 905462 D03	August 22, 2016	U-NII CLIENT DEVICES WITHOUT RADAR DETECTION CAPABILITY
KDB 905462 D02	April 8, 2016	COMPLIANCE MEASUREMENT PROCEDURES FOR UNLICENSED-NATIONAL INFORMATION INFRASTRUCTURE DEVICES OPERATING IN THE 5250-5350 MHz AND 5470-5725 MHz BANDS INCORPORATING DYNAMIC FREQUENCY SELECTION
KDB 662911 D01	October 31, 2013	Emissions Testing of Transmitters with Multiple Outputs in the Same Band
KDB 789033 D02	December 14, 2017	GUIDELINES FOR COMPLIANCE TESTING OF UNLICENSED NATIONAL INFORMATION INFRASTRUCTURE (U-NII) DEVICES PART 15, SUBPART E



4 KEY TO NOTES AND RESULT CODES

The following are the definition of the test result.

Code	Meaning
PASS	Test result shows that the requirements of the relevant specification have been met.
FAIL	Test result shows that the requirements of the relevant specification have not been met.

5. RESULT SUMMARY

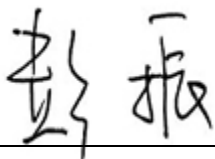
No.	Test case	FCC reference	Verdict
1.	Average Conducted Output Power	15.407(a)	Pass
2.	Occupied Bandwidth	15.407(e)	Pass
3.	Transmitter Power Spectral Density	15.407(a)	Pass
4.	Unwanted Conducted Emission Measurement	15.407(b)	Pass
5.	Frequency Stability	15.407(g)	Pass
6.	Unwanted Radiated Emission Measurement	15.205 15.209 15.35(b)	Pass
7.	AC Power line Conducted Emission	15.207	Pass
8.	DFS	15.407(h)	N/T
9.	Automatically Discontinue Transmission	15.407(c)	Pass(See 2.4Note)
10.	Antenna Requirements	15.407(a) &15.203	Pass(See 2.4Note)

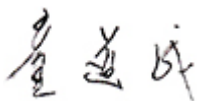
This Test Report Is Issued by: Mr. Peng Zhen 	Checked by: Mr. Li Bin 
Tested by: Tong Daocheng 	Issued date: 20190528

6 TEST RESULT

6.1 Average Conducted Output Power

6.1.1 Ambient condition

Temperature	Relative humidity	Pressure
23°C	42%	101.5kPa

6.1.2 Test Description

A transmitter antenna terminal of EUT is connected to the power meter. Measurement is made using a broadband power meter capable of making peak and average measurements while the EUT is operating at its maximum duty cycle (>98%), at maximum power, and at the appropriate frequencies.

6.1.3 Test limit

FCC Part15.407 (a)(1) ,

(i) For an outdoor access point operating in the band 5.15-5.25 GHz, the maximum conducted output power over the frequency band of operation shall not exceed 1 W provided the maximum antenna gain does not exceed 6 dBi. In addition, the maximum power spectral density shall not exceed 17 dBm in any 1 megahertz band. If transmitting antennas of directional gain greater than 6 dBi are used, both the maximum conducted output power and the maximum power spectral density shall be reduced by the amount in dB that the directional gain of the antenna exceeds 6 dBi. The maximum e.i.r.p. at any elevation angle above 30 degrees as measured from the horizon must not exceed 125 mW (21 dBm).

(ii) For an indoor access point operating in the band 5.15-5.25 GHz, the maximum conducted output power over the frequency band of operation shall not exceed 1 W provided the maximum antenna gain does not exceed 6 dBi. In addition, the maximum power spectral density shall not exceed 17 dBm in any 1 megahertz band. If transmitting antennas of directional gain greater than 6 dBi are used, both the maximum conducted output power and the maximum power spectral density shall be reduced by the amount in dB that the directional gain of the antenna exceeds 6 dBi.

(iii) For fixed point-to-point access points operating in the band 5.15-5.25 GHz, the maximum conducted output power over the frequency band of operation shall not exceed 1 W. In addition, the maximum power spectral density shall not exceed 17 dBm in any 1 megahertz band. Fixed point-to-point U-NII devices may employ antennas with directional gain up to 23 dBi without any corresponding reduction in the maximum conducted output power or maximum power spectral density. For fixed point-to-point transmitters that employ a directional antenna gain greater than 23 dBi, a 1 dB reduction in maximum conducted output power and maximum power spectral density is required for each 1 dB of antenna gain in excess of 23 dBi. Fixed, point-to-point operations exclude the use of point-to-multipoint systems, omnidirectional applications, and multiple collocated transmitters transmitting the same information. The operator of the U-NII device, or if the equipment is professionally installed, the installer, is responsible for ensuring that systems employing high gain directional antennas are used exclusively for fixed, point-to-point operations.

(iv) For client devices in the 5.15-5.25 GHz band, the maximum conducted output power over the frequency band of operation shall not exceed 250 mW provided the maximum antenna gain does not exceed 6 dBi. In addition, the maximum power spectral density shall not exceed 11 dBm in any 1 megahertz band. If transmitting antennas of directional gain greater than 6 dBi are used, both the maximum conducted output power and the maximum power spectral density shall be reduced by the amount in dB that the directional gain of the antenna exceeds 6 dBi.

FCC Part15.407 (a)(2) ,

For the 5.25-5.35 GHz and 5.47-5.725 GHz bands, the maximum conducted output power over the frequency bands of operation shall not exceed the lesser of 250 mW or $11.0 \text{ dBm} + 10 \log B$, where B is the 26 dB emission bandwidth in megahertz. In addition, the maximum power spectral density shall not exceed 11.0 dBm in any 1 megahertz band. If transmitting antennas of directional gain greater than 6 dBi are used, both the maximum conducted output power and the maximum power spectral density shall be reduced by the amount in dB that the directional gain of the antenna exceeds 6 dBi.

FCC Part15.407 (a)(3) ,

For the band 5.725-5.85 GHz, the maximum conducted output power over the frequency band of operation shall not exceed 1 W. In addition, the maximum power spectral density shall not exceed 30.0 dBm in any 500-kHz band. If transmitting antennas of directional gain greater than 6 dBi are used, both the maximum conducted output power and the maximum power spectral density shall be reduced by the amount in dB that the directional gain of the antenna exceeds 6 dBi.

6.1.4 Test Procedure Used

KDB 789033 D02 v02r01, Section E.3.b (Method PM-G).

6.1.5 Test Settings

Measurements perform using a wideband gated RF power meter.

6.1.6 Test Setup

The EUT and measurement equipment were set up as shown in the diagram below.

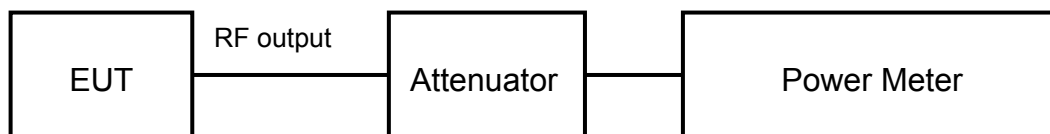

6.1.7 Test result

The test results are shown in Appendix A.

6.2 Occupied Bandwidth

6.2.1 Ambient condition

Temperature	Relative humidity	Pressure
23°C	42%	101.5kPa

6.2.2 Test Description

A transmitter antenna terminal of EUT is connected to the Spectrum Analyzer. This connected to the transmitter antenna terminal of the EUT while the EUT is operating at maximum power and at the appropriate frequencies.

6.2.3 Test limit

Rule FCC Part §15.407(e)

Within the 5.725-5.85 GHz band, the minimum 6 dB bandwidth of U-NII devices shall be at least 500 kHz.

6.2.4 Test Procedure Used

KDB 789033 D02 v02r01, Section D.

6.2.5 Test Settings

For U-NII-1, set $RBW \approx 1\%$ OCB kHz, $VBW \geq 3 \times RBW$, measure the maximum width of the emission that is constrained by the frequencies associated with the two outermost amplitude points (upper and lower frequencies) that are attenuated by 26 dB relative to the maximum level measured in the fundamental emission.

For U-NII-3, Set $RBW = 100$ kHz, $VBW \geq 3 \times RBW$, measure the maximum width of the emission that is constrained by the frequencies associated with the two outermost amplitude points (upper and lower frequencies) that are attenuated by 6 dB relative to the maximum level measured in the fundamental emission.

Note: The automatic bandwidth measurement capability of a spectrum analyzer or EMI receiver may be employed if it implements the functionality described above.

Use the 99 % power bandwidth function of the instrument.

6.2.6 Test Setup

The EUT and measurement equipment were set up as shown in the diagram below.

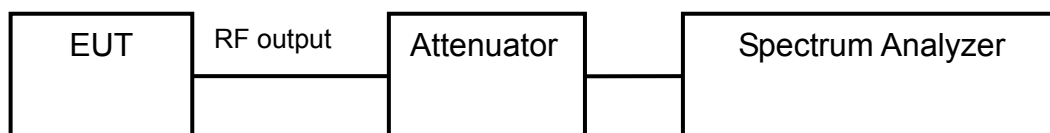

6.2.7 Test result

The test results are shown in Appendix A .

6.3 Transmitter Power Spectral Density

6.3.1 Ambient condition

Temperature	Relative humidity	Pressure
23°C	42%	101.5kPa

6.3.2 Test Description

The peak power density is measured with a spectrum analyzer connected to the antenna terminal of the EUT while the EUT is operating at its maximum duty cycle (>98%), at maximum power, and at the appropriate frequencies. All data rates were investigated and the worst case configuration results are reported in this section.

6.3.3 Test limit

FCC Part15.407 (a)(1) ,

(i) For an outdoor access point operating in the band 5.15-5.25 GHz, the maximum conducted output power over the frequency band of operation shall not exceed 1 W provided the maximum antenna gain does not exceed 6 dBi. In addition, the maximum power spectral density shall not exceed 17 dBm in any 1 megahertz band. If transmitting antennas of directional gain greater than 6 dBi are used, both the maximum conducted output power and the maximum power spectral density shall be reduced by the amount in dB that the directional gain of the antenna exceeds 6 dBi. The maximum e.i.r.p. at any elevation angle above 30 degrees as measured from the horizon must not exceed 125 mW (21 dBm).

(ii) For an indoor access point operating in the band 5.15-5.25 GHz, the maximum conducted output power over the frequency band of operation shall not exceed 1 W provided the maximum antenna gain does not exceed 6 dBi. In addition, the maximum power spectral density shall not exceed 17 dBm in any 1 megahertz band. If transmitting antennas of directional gain greater than 6 dBi are used, both the maximum conducted output power and the maximum power spectral density shall be reduced by the amount in dB that the directional gain of the antenna exceeds 6 dBi.

(iii) For fixed point-to-point access points operating in the band 5.15-5.25 GHz, the maximum conducted output power over the frequency band of operation shall not exceed 1 W. In addition, the maximum power spectral density shall not exceed 17 dBm in any 1 megahertz band. Fixed point-to-point U-NII devices may employ antennas with directional gain up to 23 dBi without any corresponding reduction in the maximum conducted output power or maximum power spectral density. For fixed point-to-point transmitters that employ a directional antenna gain greater than 23 dBi, a 1 dB reduction in maximum conducted output power and maximum power spectral density is required for each 1 dB of antenna gain in excess of 23 dBi. Fixed, point-to-point operations exclude the use of point-to-multipoint systems, omnidirectional applications, and multiple collocated transmitters transmitting the same information. The operator of the U-NII device, or if the equipment is professionally installed, the installer, is responsible for ensuring that systems employing high gain directional antennas are used exclusively for fixed, point-to-point operations.

(iv) For client devices in the 5.15-5.25 GHz band, the maximum conducted output power

over the frequency band of operation shall not exceed 250 mW provided the maximum antenna gain does not exceed 6 dBi. In addition, the maximum power spectral density shall not exceed 11 dBm in any 1 megahertz band. If transmitting antennas of directional gain greater than 6 dBi are used, both the maximum conducted output power and the maximum power spectral density shall be reduced by the amount in dB that the directional gain of the antenna exceeds 6 dBi.

FCC Part15.407 (a)(2) ,

For the 5.25-5.35 GHz and 5.47-5.725 GHz bands, the maximum conducted output power over the frequency bands of operation shall not exceed the lesser of 250 mW or $11.0 \text{ dBm} + 10 \log B$, where B is the 26 dB emission bandwidth in megahertz. In addition, the maximum power spectral density shall not exceed 11.0 dBm in any 1 megahertz band. If transmitting antennas of directional gain greater than 6 dBi are used, both the maximum conducted output power and the maximum power spectral density shall be reduced by the amount in dB that the directional gain of the antenna exceeds 6 dBi.

FCC Part15.407 (a)(3) ,

For the band 5.725-5.85 GHz, the maximum conducted output power over the frequency band of operation shall not exceed 1 W. In addition, the maximum power spectral density shall not exceed 30.0 dBm in any 500-kHz band. If transmitting antennas of directional gain greater than 6 dBi are used, both the maximum conducted output power and the maximum power spectral density shall be reduced by the amount in dB that the directional gain of the antenna exceeds 6 dBi.

6.3.4 Test Procedure Used

KDB 789033 D02 v02r01, Section F.

6.3.5 Test Settings

Set RBW = 500 kHz, VBW =1.5MHz for the band 5.725-5.85 GHz

Set RBW = 1 MHz, VBW =3MHz for the band 5.150-5.250 GHz, 5.250-5.350 GHz and 5.470-5.725 GHz.

The conducted PSD is measured at each antenna port. The measured results at the various antenna ports are then summed mathematically.

6.3.6 Test Setup

The EUT and measurement equipment were set up as shown in the diagram below.

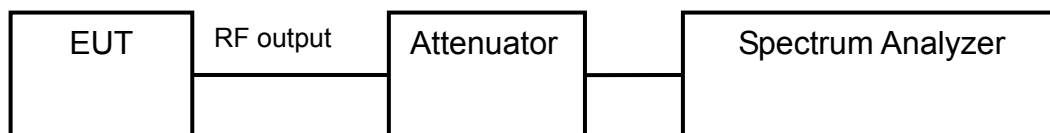

6.3.7 Test result

The test results are shown in Appendix A.

6.4 Unwanted Conducted Emission Measurement

6.4.1 Ambient condition

Temperature	Relative humidity	Pressure
23°C	42%	101.5kPa

6.4.2 Test Description

All out of band emissions are measured with a spectrum analyzer connected to the antenna terminal of the EUT while the EUT is operating at its maximum duty cycle (>98%), at maximum power, and at the appropriate frequencies. All data rates were investigated to determine the worst case configuration.

6.4.3 Test limit

FCC Part 15.407(b),

Undesirable emission limits. Except as shown in paragraph (b)(7) of this section, the maximum emissions outside of the frequency bands of operation shall be attenuated in accordance with the following limits:

- (1) For transmitters operating in the 5.15-5.25 GHz band: All emissions outside of the 5.15-5.35 GHz band shall not exceed an e.i.r.p. of -27 dBm/MHz.
- (2) For transmitters operating in the 5.25-5.35 GHz band: All emissions outside of the 5.15-5.35 GHz band shall not exceed an e.i.r.p. of -27 dBm/MHz.
- (3) For transmitters operating in the 5.47-5.725 GHz band: All emissions outside of the 5.47-5.725 GHz band shall not exceed an e.i.r.p. of -27 dBm/MHz.
- (4) For transmitters operating in the 5.725-5.85 GHz band: All emissions within the frequency range from the band edge to 10 MHz above or below the band edge shall not exceed an e.i.r.p. of -17 dBm/MHz; for frequencies 10 MHz or greater above or below the band edge, emissions shall not exceed an e.i.r.p. of -27 dBm/MHz.

6.4.4 Test Procedure Used

KDB 789033 D02 v02r01, Section G.

6.4.5 Test Settings

- a) Set the center frequency and span to encompass frequency range to be measured.
- b) Set the RBW = 1 MHz.
- c) Set the VBW ≥ 3 MHz.
- d) Detector = peak.
- e) Set span to encompass the spectrum to be examined
- f) Sweep time = auto couple.
- g) Trace mode = max hold.
- h) Allow trace to fully stabilize.
- i) Use the peak marker function to determine the maximum amplitude level.

6.4.6 Test Setup

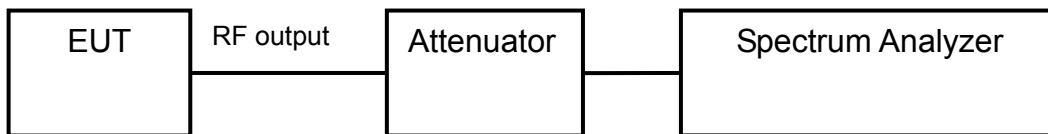

6.4.7 Test result

The test results are shown in Appendix A.

6.5 Frequency Stability

6.5.1 Ambient condition

Temperature	Relative humidity	Pressure
23°C	42%	101.5kPa

6.5.2 Test limit

Manufacturers of U-NII devices are responsible for ensuring frequency stability such that an emission is maintained within the band of operation under all conditions of normal operation as specified in the user’s manual.

6.5.3 Test Procedure Used

1. To ensure emission at the band edge is maintained within the authorized band, those values shall be measured by radiation emissions at upper and lower frequency points, and finally compensated by frequency deviation as procedures below.
2. The EUT was operated at the maximum output power, and connected to the spectrum analyzer, which is set to maximum hold function and peak detector. The peak value of the power envelope was measured and noted. The upper and lower frequency points were respectively measured relatively 10dB lower than the measured peak value.
3. The frequency deviation was calculated by adding the upper frequency point and the lower frequency point divided by two. Those detailed values of frequency deviation are provided in table below.

6.5.4 Test Setup

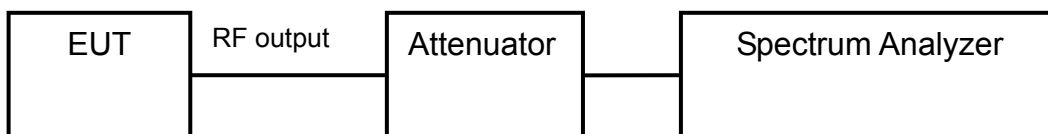

6.5.5 Test result

The test results are shown in Appendix A.

6.6 Unwanted Radiated Emission Measurement

6.6.1 Ambient condition

Temperature	Relative humidity	Pressure
23°C	45%	101.9kPa

6.6.2 Test Description

All out of band radiated spurious emissions are measured with a spectrum analyzer connected to a receive antenna while the EUT is operating at maximum power and at the appropriate frequencies. Only the radiated emissions of the configuration that produced the worst case emissions are reported in this section.

6.6.3 Test limit

FCC Part15.205, 15.209,;

In addition, radiated emissions which fall in the restricted bands, as defined in Section 15.205(a), must also comply with the radiated emission limits specified in Section 15.209(a) (see Section 15.205(c)). All out of band emissions appearing in a restricted band as specified in Section 15.205 of the Title 47 CFR must not exceed the limits shown in below Table per Section 15.209.

Frequency [MHz]	Field strength [μV/m]	Measured Distance [meters]
30~88	100	3
88~216	150	3
216~960	200	3
Above 960	500	3

Radiated Limits

FCC Part15.35(b):

There is also a limit on the radio frequency emissions, as measured using instrumentation with a peak detector function, corresponding to 20 dB above the maximum permitted average limit

Used conversion factor: Limit (dBμV/m) = 20 log (Limit (μV/m)/1μV/m)

Frequency [MHz]	Detector	Unit (dBμV/m)
30~88	Quasi-peak	40.0
88~216	Quasi-peak	43.5
216~960	Quasi-peak	46.0
960~1000	Quasi-peak	54.0
1000~5th harmonic of the highest frequency or 40GHz, whichever is lower	Average	54.0
	Peak	74.0

Conversion Radiated limits

6.6.4 Test Procedure Used

KDB 789033 D02 v02r01, Sections G.3, G.4, G.5, and G.6.

6.6.5 Test Settings

Average Field Strength Measurements

1. Analyzer center frequency was set to the frequency of the radiated spurious emission of interest
2. RBW = 1MHz
3. VBW = 3MHz
4. Detector = power average (RMS)
5. Number of measurement points = 1001 (Number of points must be $> 2 \times \text{span}/\text{RBW}$)
6. Sweep time = auto
7. Trace (RMS) averaging was performed over at least 100 traces

Peak Field Strength Measurements

1. Analyzer center frequency was set to the frequency of the radiated spurious emission of interest
2. RBW = 1MHz
3. VBW = 3MHz
4. Detector = peak
5. Sweep time = auto couple
6. Trace mode = max hold
7. Trace was allowed to stabilize

6.6.6 Test Setup

The EUT and measurement equipment were set up as shown in the diagram below

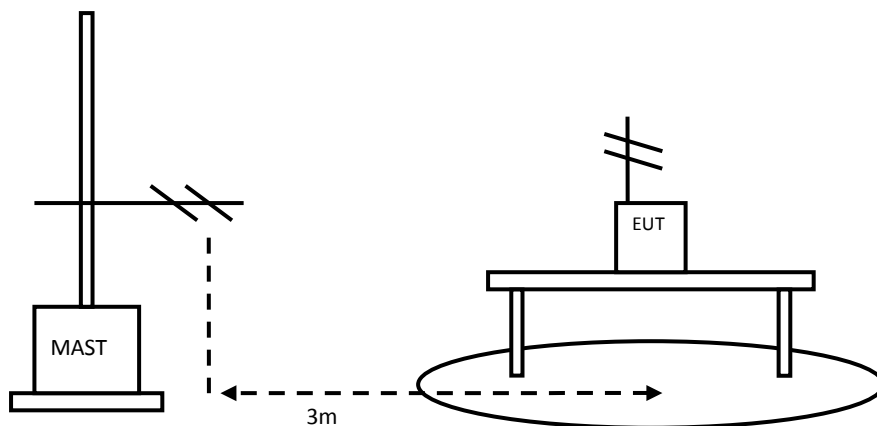

The Equipment Under Test (EUT) was set up on a non-conductive table in the semi-anechoic chamber. The test was performed at the distance of 3 m between the EUT and the receiving antenna. The radiated emissions measurements were made in a typical installation configuration. Then start the test software ES-K1. Sweep the whole frequency band through the range from 30MHz to 1GHz or above, using receive log period antenna HL562 or Ridge horn antenna HF906.

During the test, the antenna height and EUT azimuth were varied in order to identify the

maximum level of emission from the EUT. The height of receive antenna shall be moved from 1 to 4 meters, and the antenna shall be performed under horizontal and vertical polarization. The turn table shall be rotated from 0 to 360 degrees. The measurements shall be repeated with orthogonal polarization of the test antenna. The results shall be showed the worst case of the three orthogonal axes.

The data of cable loss and antenna factor has been calibrated in full testing frequency range before the testing.

6.6.7 Test result

The test results are shown in Appendix B.

6.7 AC Power line Conducted Emission

6.7.1 Ambient condition

Temperature	Relative humidity	Pressure
20.8°C	36.5%	100.9kPa

6.7.2 Test limit

FCC Part 15.207(a),

Frequency of Emission (MHz)	Conducted Limit (dBuV)	
	Quasi-peak	Average
0.15-0.5	66 to 56 *	56 to 46 *
0.5-5	56	46
5-30	60	50

* Decreases with the logarithm of the frequency.

The measurement is made according to ANSI C63.10-2013

6.7.3 Test result

The test results are shown in Appendix B.

6.8 Dynamic Frequency Selection

6.8.1 Ambient condition

Temperature	Relative humidity	Pressure
22°C	42%	101.5kPa

6.8.2 Test limit

FCC Part 15.407(h) and FCC 06-96 APPENDIX “COMPLIANCE MEASUREMENT PROCEDURES FOR UNLICENSED-NATIONAL INFORMATION INFRASTRUCTURE DEVICES OPERATING IN THE 5250-5350 MHz AND 5470-5725 MHz BANDS INCORPORATING DYNAMIC FREQUENCY SELECTION”.

6.8.3 DFS Overview

Table 1: Applicability of DFS Requirements Prior to Use of a Channel

Requirement	Operational Mode		
	Master	Client Without Radar Detection	Client With Radar Detection
<i>Non-Occupancy Period</i>	Yes	Not required	Yes
<i>DFS Detection Threshold</i>	Yes	Not required	Yes
<i>Channel Availability Check Time</i>	Yes	Not required	Not required
<i>U-NII Detection Bandwidth</i>	Yes	Not required	Yes

Table 2: Applicability of DFS requirements during normal operation

Requirement	Operational Mode	
	Master Device or Client with Radar Detection	Client Without Radar Detection
<i>DFS Detection Threshold</i>	Yes	Not required
<i>Channel Closing Transmission Time</i>	Yes	Yes
<i>Channel Move Time</i>	Yes	Yes
<i>U-NII Detection Bandwidth</i>	Yes	Not required
Additional requirements for devices with multiple bandwidth modes	Master Device or Client with Radar Detection	Client Without Radar Detection
<i>U-NII Detection Bandwidth and Statistical Performance Check</i>	All BW modes must be tested	Not required
<i>Channel Move Time and Channel Closing Transmission Time</i>	Test using widest BW mode available	Test using the widest BW mode available for the link
<i>All other tests</i>	Any single BW mode	Not required
Note: Frequencies selected for statistical performance check (Section 7.8.4) should include several frequencies within the radar detection bandwidth and frequencies near the edge of the radar detection bandwidth. For 802.11 devices it is suggested to select frequencies in each of the bonded 20 MHz channels and the channel center frequency.		

Table 3: DFS Detection Thresholds for Master Devices and Client Devices with Radar Detection

Maximum Transmit Power	Value (See Notes 1, 2, and 3)
EIRP \geq 200 milliwatt	-64 dBm
EIRP < 200 milliwatt and power spectral density < 10 dBm/MHz	-62 dBm
EIRP < 200 milliwatt that do not meet the power spectral density requirement	-64 dBm
<p>Note 1: This is the level at the input of the receiver assuming a 0 dBi receive antenna.</p> <p>Note 2: Throughout these test procedures an additional 1 dB has been added to the amplitude of the test transmission waveforms to account for variations in measurement equipment. This will ensure that the test signal is at or above the detection threshold level to trigger a DFS response.</p> <p>Note3: EIRP is based on the highest antenna gain. For MIMO devices refer to KDB Publication 662911 D01.</p>	

Table 4: DFS Response Requirement Values

Parameter	Value
<i>Non-occupancy period</i>	Minimum 30 minutes
<i>Channel Availability Check Time</i>	60 seconds
<i>Channel Move Time</i>	10 seconds See Note 1.
<i>Channel Closing Transmission Time</i>	200 milliseconds + an aggregate of 60 milliseconds over remaining 10 second period. See Notes 1 and 2.
<i>U-NII Detection Bandwidth</i>	Minimum 100% of the U-NII 99% transmission power bandwidth. See Note 3.
<p>Note 1: <i>Channel Move Time</i> and the <i>Channel Closing Transmission Time</i> should be performed with Radar Type 0. The measurement timing begins at the end of the Radar Type 0 burst.</p> <p>Note 2: The <i>Channel Closing Transmission Time</i> is comprised of 200 milliseconds starting at the beginning of the <i>Channel Move Time</i> plus any additional intermittent control signals required to facilitate a <i>Channel</i> move (an aggregate of 60 milliseconds) during the remainder of the 10 second period. The aggregate duration of control signals will not count quiet periods in between transmissions.</p> <p>Note 3: During the <i>U-NII Detection Bandwidth</i> detection test, radar type 0 should be used. For each frequency step the minimum percentage of detection is 90 percent. Measurements are performed with no data traffic.</p>	

Table 5 – Short Pulse Radar Test Waveforms

Radar Type	Pulse Width (μsec)	PRI (μsec)	Number of Pulses	Minimum Percentage of Successful Detection	Minimum Number of Trials
0	1	1428	18	See Note 1	See Note 1
1	1	Test A: 15 unique PRI values randomly selected from the list of 23 PRI values in Table 5a	Roundup $\left\{ \begin{array}{l} \left(\frac{1}{360} \right) \cdot \\ \left(\frac{19 \cdot 10^6}{\text{PRI}_{\mu\text{sec}}} \right) \end{array} \right\}$	60%	30
		Test B: 15 unique PRI values randomly selected within the range of 518-3066 μsec, with a minimum increment of 1 μsec, excluding PRI values selected in Test A			
2	1-5	150-230	23-29	60%	30
3	6-10	200-500	16-18	60%	30
4	11-20	200-500	12-16	60%	30
Aggregate (Radar Types 1-4)				80%	120
Note 1: Short Pulse Radar Type 0 should be used for the detection bandwidth test, channel move time, and channel closing time tests.					

Table 6 – Long Pulse Radar Test Waveform

Radar Type	Pulse Width (μsec)	Chirp Width (MHz)	PRI (μsec)	Number of Pulses per Burst	Number of Bursts	Minimum Percentage of Successful Detection	Minimum Number of Trials
5	50-100	5-20	1000-2000	1-3	8-20	80%	30

Table 7 – Frequency Hopping Radar Test Waveform

Radar Type	Pulse Width (μsec)	PRI (μsec)	Pulses per Hop	Hopping Rate (kHz)	Hopping Sequence Length (msec)	Minimum Percentage of Successful Detection	Minimum Number of Trials
6	1	333	9	0.333	300	70%	30

6.8.4 TEST AND MEASUREMENT SYSTEM

Setup for Client with injection at the Master

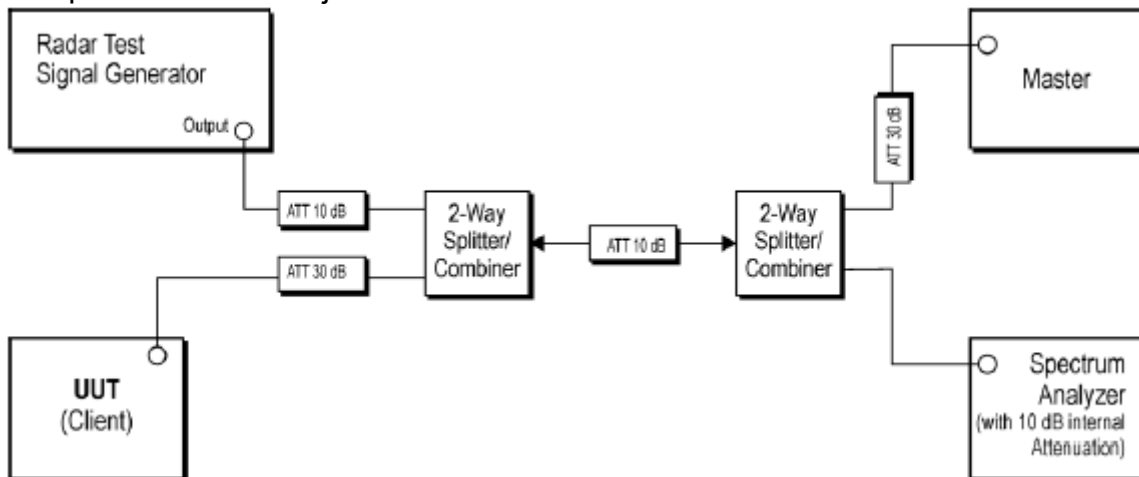

Setup of EUT
CLIENT MODE:

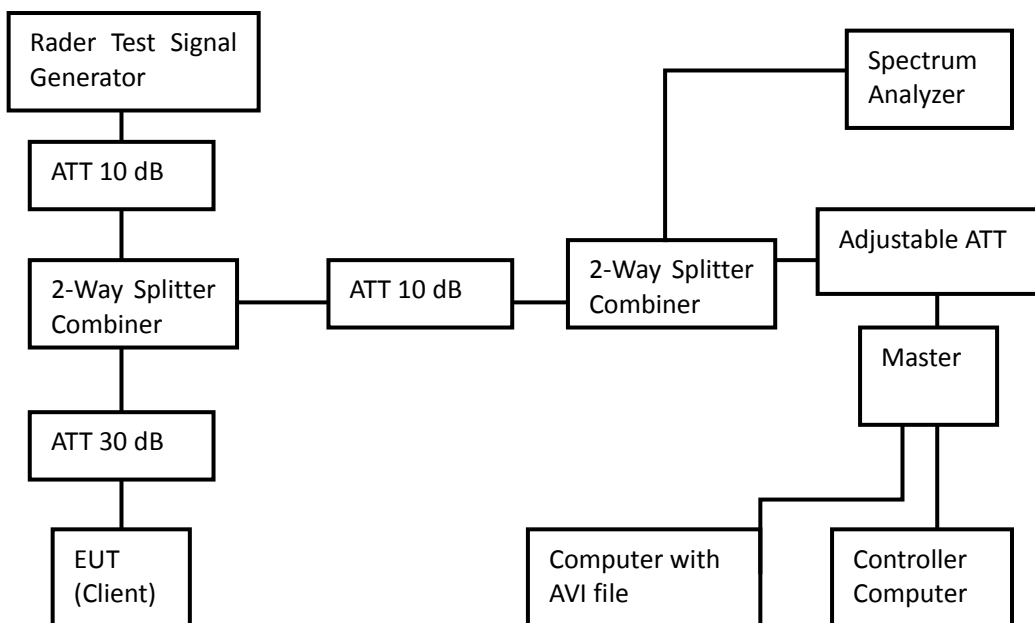

Test Setup Operation

System testing was performed with the designated MPEG-4 (1080P,WEBRip,DD5.1.x264-btbtba) test file that streams full motion video from the Access Point to the Client in full motion video mode using the media player with the V2.61 Codec package.

This file is used by IP and Frame based systems for loading the test channel during the

In-service compliance testing of the device.

The waveform parameters from within the bounds of the signal type are selected randomly using uniform distribution.

A spectrum analyzer is used as a monitor to verify that the EUT has vacated the Channel within the (Channel Closing Transmission Time and Channel Move Time, and does not transmit on a Channel during the Non-Occupancy Period after the detection and Channel move. It is also used to monitor EUT transmissions during the Channel Availability Check Time.

6.8.5 Test Procedure Used

(i) Operational Modes. The DFS requirement applies to the following operational modes:

(A) The requirement for channel availability check time applies in the master operational mode.

(B) The requirement for channel move time applies in both the master and slave operational modes.

(ii) Channel Availability Check Time. A U-NII device shall check if there is a radar system already operating on the channel before it can initiate a transmission on a channel and when it has to move to a new channel. The U-NII device may start using the channel if no radar signal with a power level greater than the interference threshold values listed in paragraph (h)(2) of this section, is detected within 60 seconds.

(iii) Channel Move Time. After a radar's presence is detected, all transmissions shall cease on the operating channel within 10 seconds. Transmissions during this period shall consist of normal traffic for a maximum of 200 ms after detection of the radar signal. In addition, intermittent management and control signals can be sent during the remaining time to facilitate vacating the operating channel.

(iv) Non-occupancy Period. A channel that has been flagged as containing a radar system, either by a channel availability check or in-service monitoring, is subject to a non-occupancy period of at least 30 minutes. The non-occupancy period starts at the time when the radar system is detected.

6.8.6 RADAR WAVEFORM

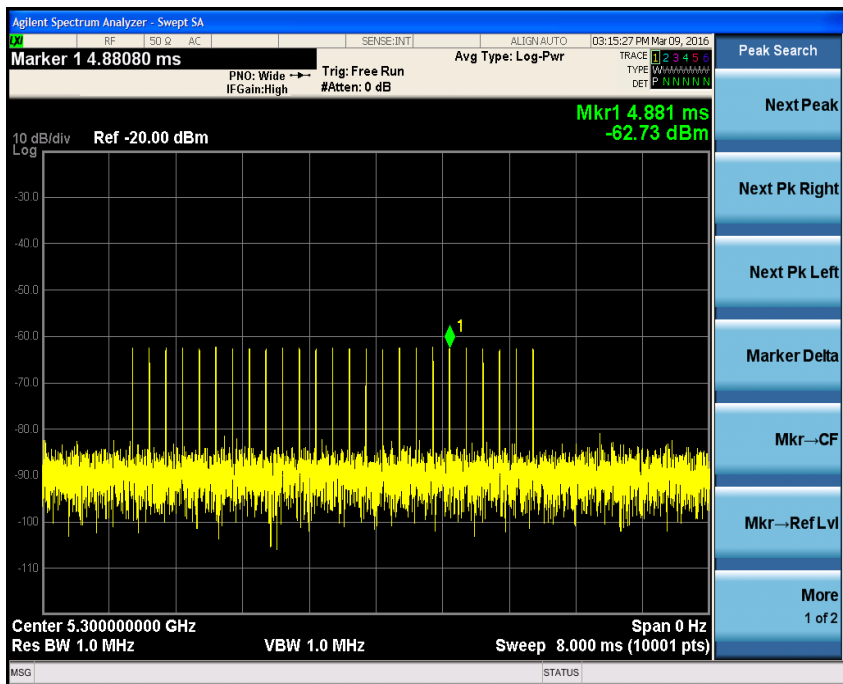
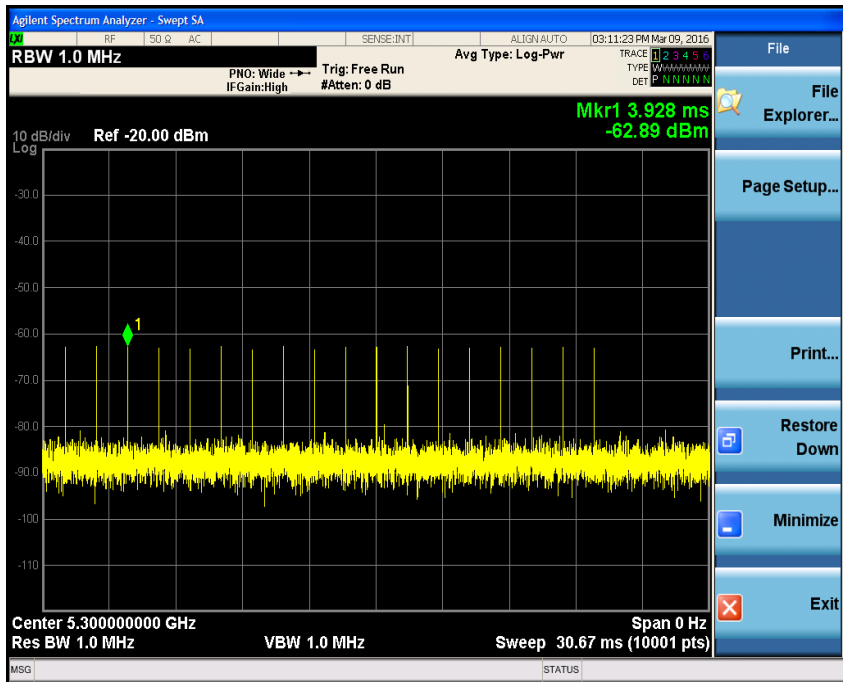

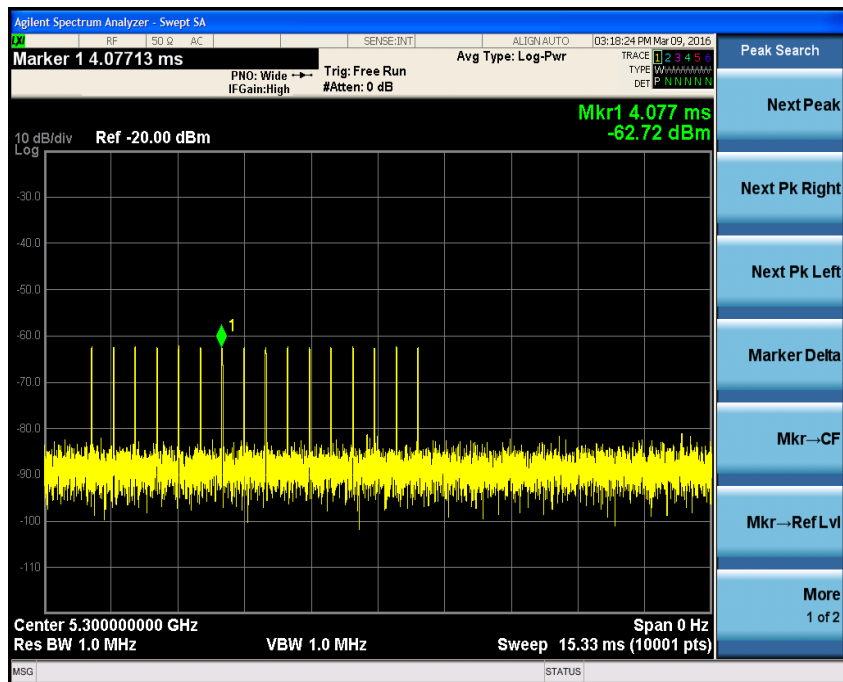
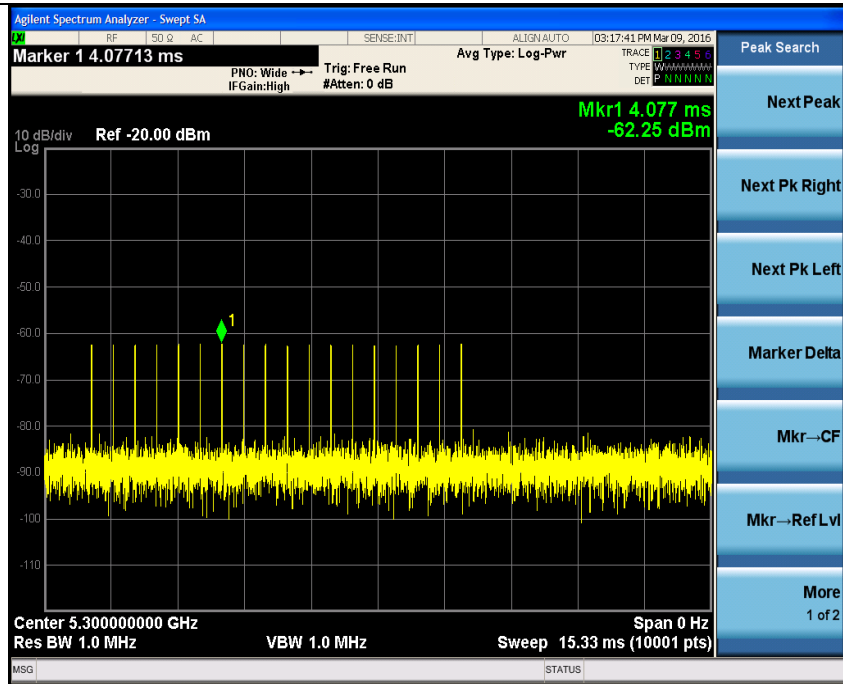

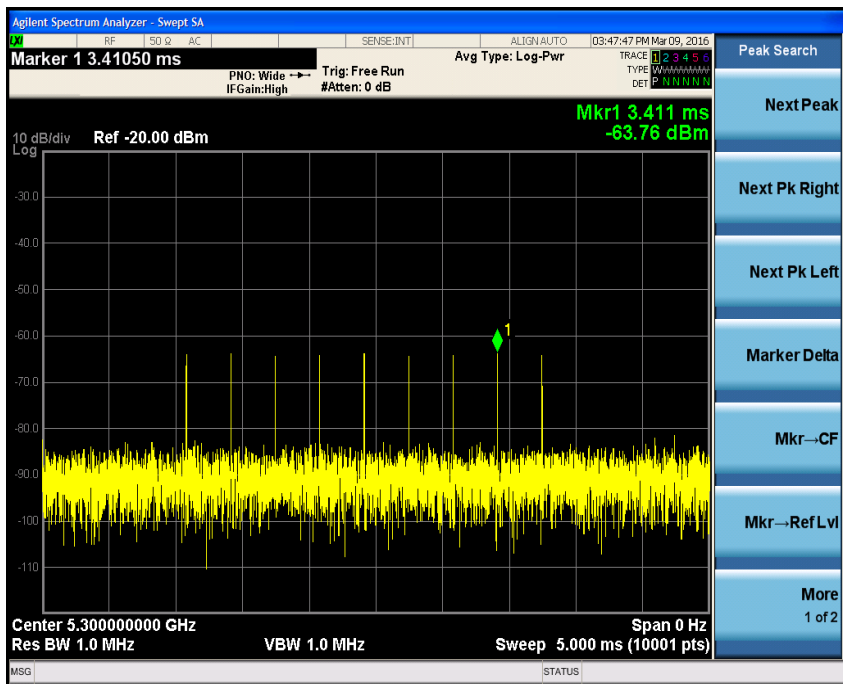
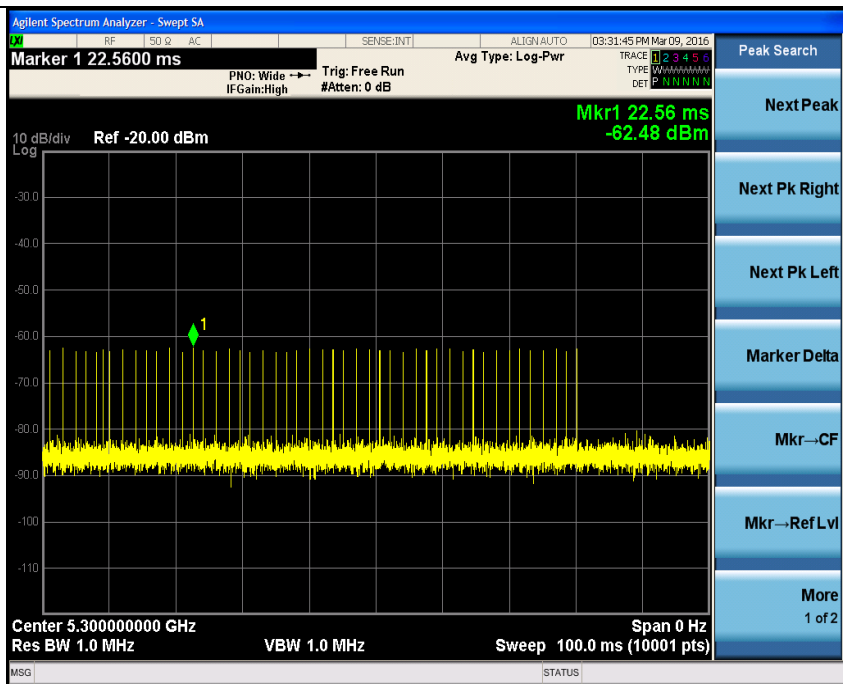

6.8.7 Test result

The test results are shown in Appendix A.

Note: The EUT only operates in the 5150-5250MHz frequency bands and does not involve the DFS frequency band, so there is no test.

7 MEASUREMENT UNCERTAINTIES

Items	Uncertainty	
Occupied Bandwidth	3kHz	
Output Power	0.67dB	
Transmitter Power Spectral Density	0.75dB	
Spurious emissions	30MHz~1GHz	2.83dB
	1GHz~12.75GHz	2.50dB
	12.75GHz~40GHz	2.75dB

8 TEST EQUIPMENTS

No.	Name/ Model	Manufacturer	S/N	Cal date	Cal Due date
1.	Spectrum Analyzer FSV	ROHDE&SCHWARZ	101065	2018.08.20	2019.08.19
2.	Signal Analyzer N9020A	Agilent	MY48010771	2018.08.20	2019.08.19
3.	Chamber SH-241	ESPEC	92013758	2018.08.20	2019.08.19
4.	DC Power Apply E3645A	Agilent	MY40000741	2019.03.01	2020.02.28
5.	Power Meter E4416A	Agilent	MY52370013	2019.03.01	2020.02.28
6.	Power Sensor E9327A	Agilent	MY52420006	2019.03.01	2020.02.28
7.	12.65m×8.03m×7.50m Fully-Anechoic Chamber	FRANKONIA	----	----	----
8.	23.18m×16.88m×9.60m Semi-Anechoic Chamber	FRANKONIA	---	----	----
9.	Turn table Diameter:1m	HD	----	----	----
10.	Turn table Diameter:5m	HD	----	----	----
11.	Antenna master FAC(MA4.0)	MATURO	----	----	----
12.	Antenna master SAC(MA4.0)	MATURO	----	----	----
13.	9.080m×5.255m×3.525m Shielding room	FRANKONIA	----	----	----
14.	HF 906 Double-Ridged Waveguide Horn Antenna	R&S	100030	2018.08.20	2019.08.19
15.	HF 906 Double-Ridged Waveguide Horn Antenna	R&S	100029	2018.08.20	2019.08.19
16.	HL562 Ultra log antenna	R&S	100016	2018.08.20	2019.08.19
17.	3160-09 Receive antenna	SCHWARZ-BECK	002058-002	2018.08.20	2019.08.19
18.	ESI 40 EMI test receiver	R&S	100015	2018.08.20	2019.08.19
19.	Radio tester	CMU 200	114667	2018.08.20	2019.08.19
20.	ESCS30 EMI test receiver	R&S	100029	2018.08.20	2019.08.19
21.	HL562 Receive antenna	R&S	100167	2018.08.20	2019.08.19
22.	ESH3-Z5 LISN	R&S	100020	2018.08.20	2019.08.19

APPENDIX A – TEST DATA OF CONDUCTED EMISSION

Please refer to the attachment.

APPENDIX B – TEST DATA OF RADIATED EMISSION

Please refer to the attachment.

APPENDIX A – TEST DATA OF CONDUCTED EMISSION

Output Power Result

In order to find the worst case condition, Pre-tests are needed at the presence of different data rate. Data rate below means worst-case rate of each test item.

Worst-case data rates are shown as following table.

Test Mode	Data Rate
802.11a	6Mbps
802.11n HT20	MCS0(6.5 Mbps)
802.11n HT40	MCS0(13.5 Mbps)
802.11ac HT20	MCS0(6.5 Mbps)
802.11ac HT40	MCS0(13.5 Mbps)
802.11ac HT80	MCS0(29.3 Mbps)

Directional Antenna Gain

The TX chains are correlated and the antenna gain is unequal among the chains. The directional gain is:

Chain1 Antenna Gain(dBi)	Chain2 Antenna Gain(dBi)	Correlated Chains Directional Gain(dBi)
1.25	1.35	4.31

Antenna Gain and Limits

Frequency (MHz)	Correlated Chains Directional Gain (dBi)	Power Limit (dBm)	PSD Limit (dBm)
5180	4.31	30.0	17.0
5200	4.31	30.0	17.0
5240	4.31	30.0	17.0
5190	4.31	30.0	17.0
5230	4.31	30.0	17.0
5210	4.31	30.0	17.0

Output Power

Test Mode	Ant	Average Power(dBm)			Limit(dBm)
		5180 MHz	5200 MHz	5240MHz	
802.11a	Ant1	10.11	10.13	10.09	30.0
802.11a	Ant2	10.51	10.48	10.54	30.0
802.11n HT20	Ant1	10.61	10.55	10.71	30.0
802.11n HT20	Ant2	11.18	11.03	11.12	30.0
802.11n HT20	MIMO	13.91	13.81	13.93	30.0
802.11ac VHT20	Ant1	10.33	10.37	10.35	30.0
802.11ac VHT20	Ant2	10.58	10.62	10.64	30.0
802.11ac VHT20	MIMO	13.47	13.51	13.51	30.0
Test Mode	Ant	Average Power(dBm)		Limit(dBm)	
		5190 MHz	5230 MHz		
802.11n HT40	Ant1	10.52	10.61	30.0	
802.11n HT40	Ant2	10.73	10.81	30.0	
802.11n HT40	MIMO	13.64	13.72	30.0	
802.11ac VHT40	Ant1	10.21	10.37	30.0	
802.11ac VHT40	Ant2	10.49	10.55	30.0	
802.11ac VHT40	MIMO	13.36	13.47	30.0	
Test Mode	Ant	Average Power(dBm)		Limit(dBm)	
		5210 MHz			
802.11ac VHT80	Ant1	9.28		30.0	
802.11ac VHT80	Ant2	9.62		30.0	
802.11ac VHT80	MIMO	12.46		30.0	

We chose the Worst-modes are shown as following table:

Test Mode	Ant	Note
802.11a	SISO Ant2	---
802.11n HT20	SISO Ant2	Cover 802.11ac VHT20
802.11n HT40	SISO Ant2	Cover 802.11ac VHT40
802.11ac VHT80	SISO Ant2	---
802.11n HT20	MIMO Ant1+Ant2	Cover 802.11ac VHT20
802.11n HT40	MIMO Ant1+Ant2	Cover 802.11ac VHT40
802.11ac VHT80	MIMO Ant1+Ant2	---

Occupied Bandwidth

Offset 11.5dB = Attenuator 10dB+ Temporary antenna connector loss 0.2dB+ Cable loss 1.3dB

U-NII-1

Test Mode: 802.11a (SISO Ant2)

Carrier frequency (MHz)	99% Bandwidth(MHz)	Minimum 26dB Bandwidth(MHz)	Conclusion
5180	16.309	22.12	pass
5200	16.279	19.82	pass
5240	16.274	19.08	pass

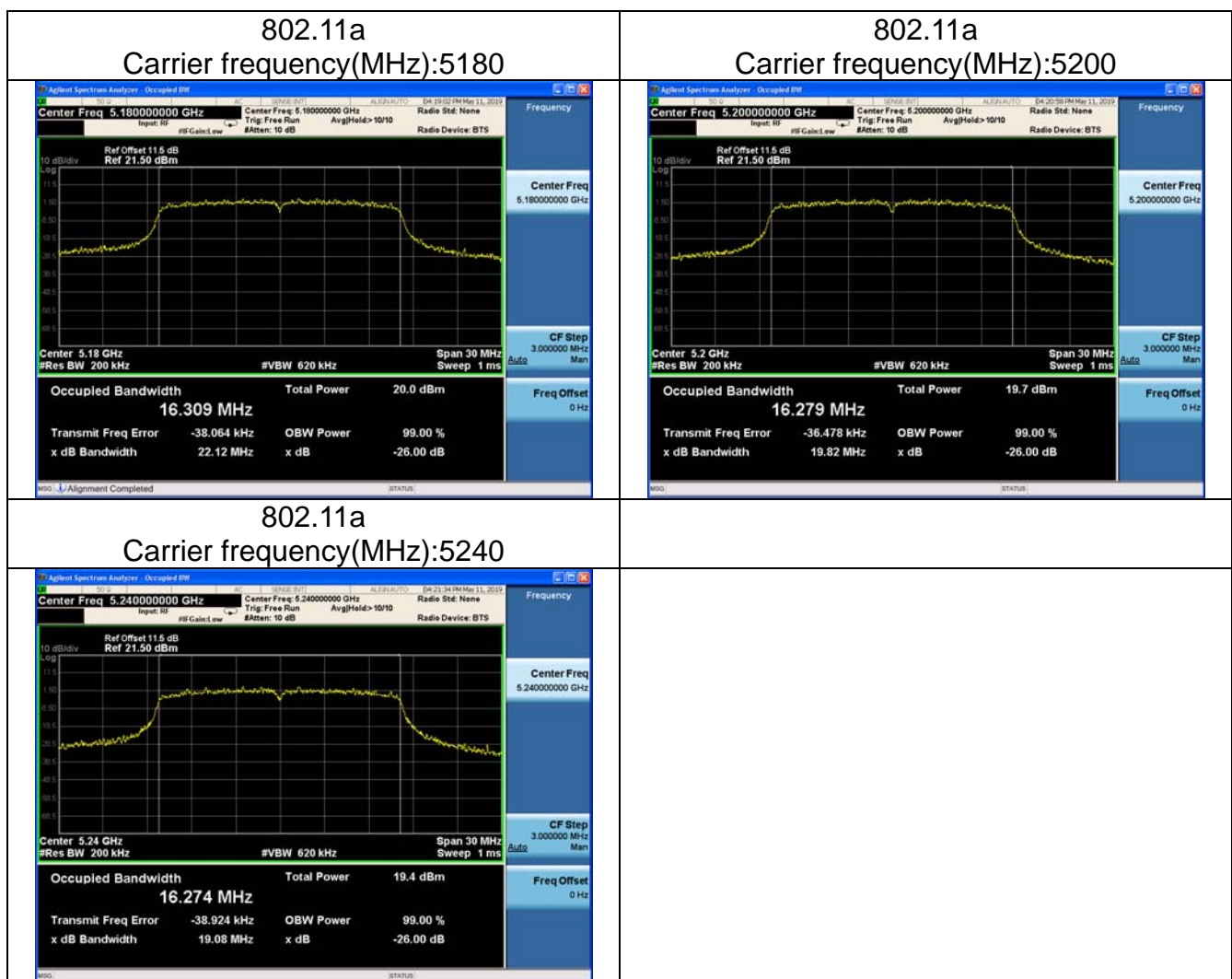

Test Mode: 802.11n HT20 (SISO Ant2)

Carrier frequency (MHz)	99% Bandwidth(MHz)	Minimum 26dB Bandwidth(MHz)	Conclusion
5180	17.419	20.80	Pass
5200	17.421	19.95	Pass
5240	17.407	21.01	Pass

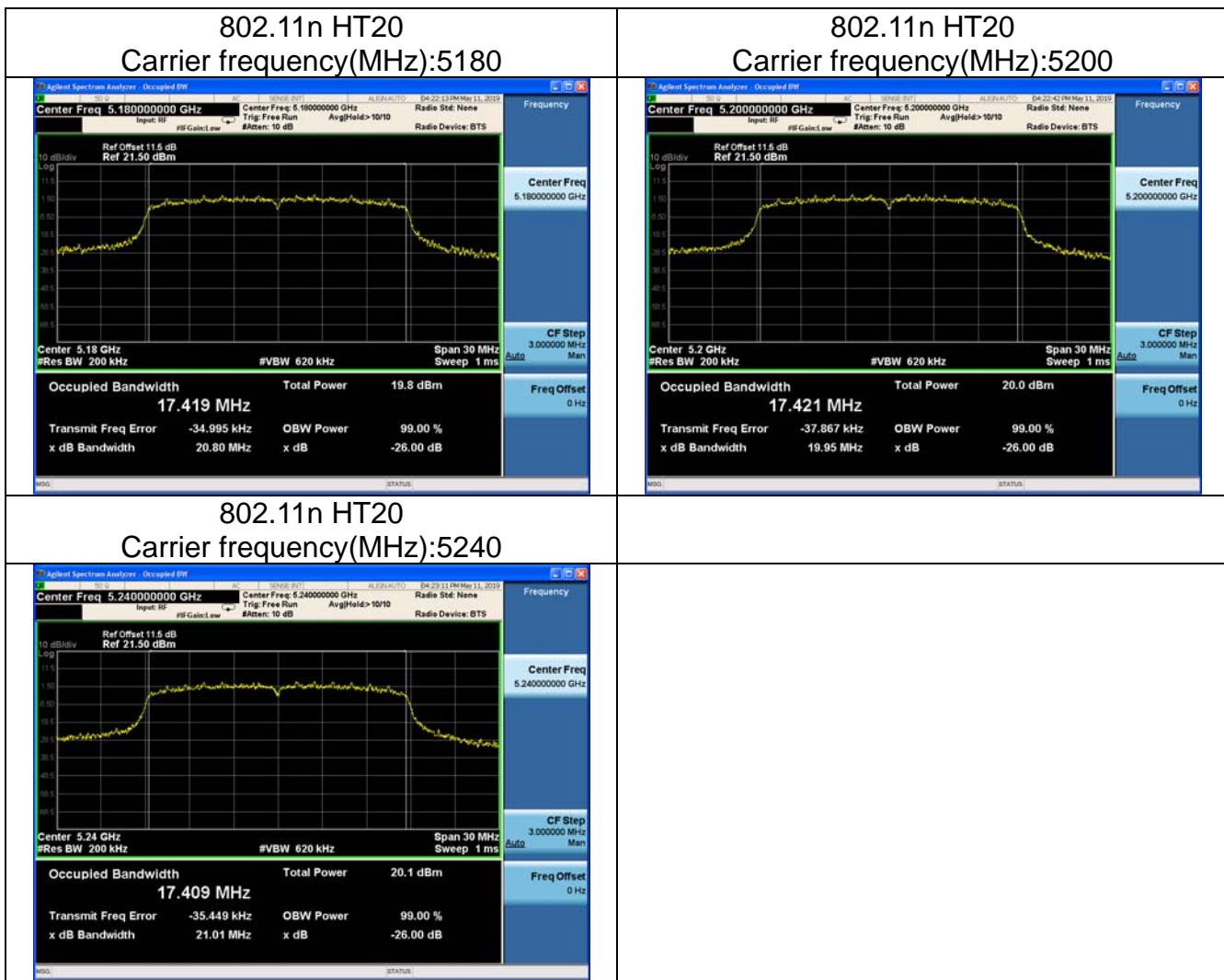

Test Mode: 802.11n HT40 (SISO Ant2)

Carrier frequency (MHz)	99% Bandwidth(MHz)	Minimum 26dB Bandwidth(MHz)	Conclusion
5190	36.131	53.58	pass
5230	36.183	52.68	pass

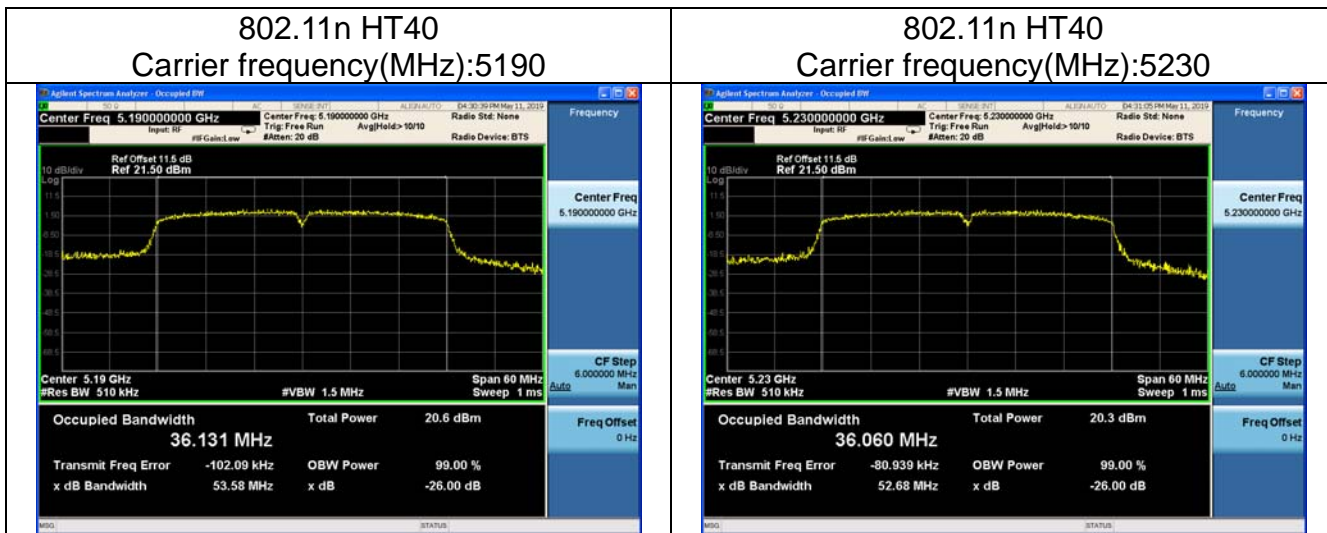

Test Mode: 802.11ac HT80 (SISO Ant2)

Carrier frequency (MHz)	99% Bandwidth(MHz)	Minimum 26dB Bandwidth(MHz)	Conclusion
5210	75.025	83.00	pass

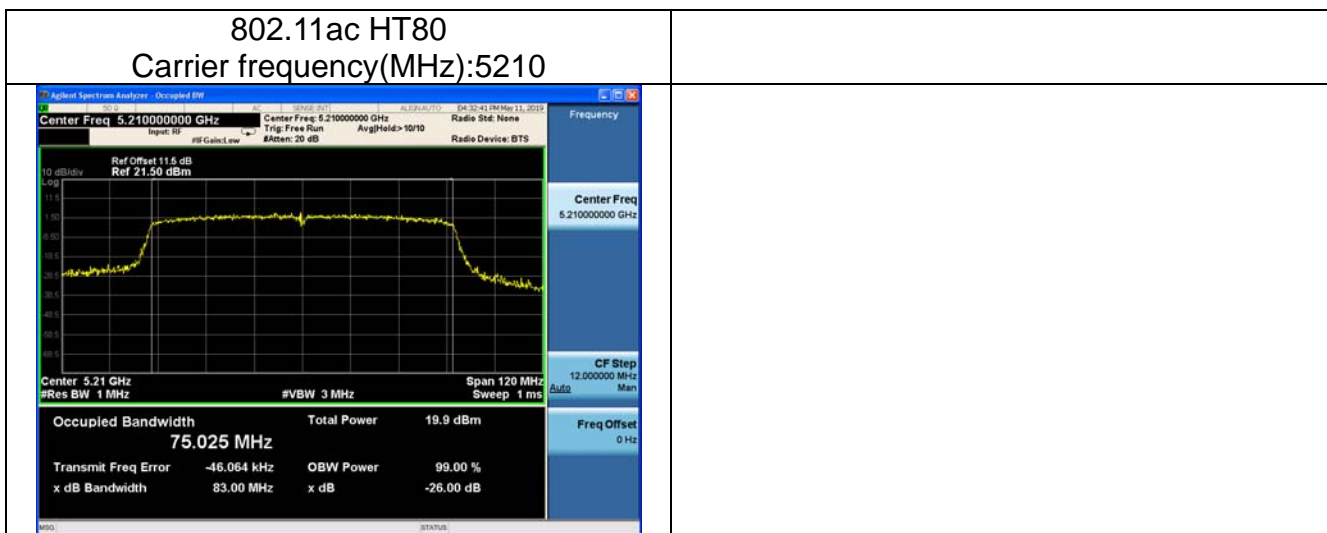

Test Mode: 802.11n HT20 (MIMO Ant1)

Carrier frequency (MHz)	99% Bandwidth(MHz)	Minimum 26dB Bandwidth(MHz)	Conclusion
5180	17.405	19.82	pass
5200	17.386	19.85	pass
5240	17.403	19.78	pass

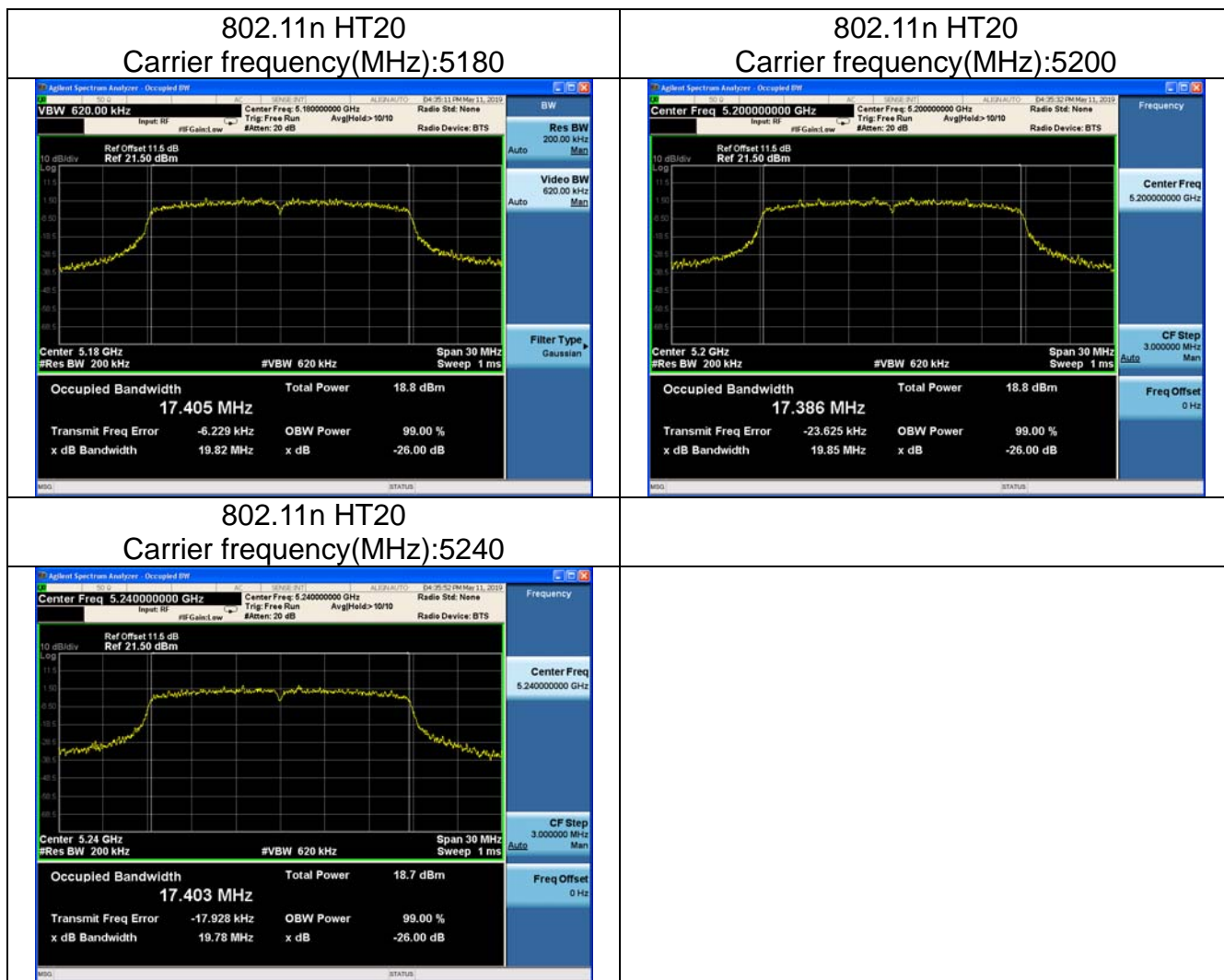

Test Mode: 802.11n HT20 (MIMO Ant2)

Carrier frequency (MHz)	99% Bandwidth(MHz)	Minimum 26dB Bandwidth(MHz)	Conclusion
5180	17.508	25.50	pass
5200	17.471	23.72	pass
5240	17.460	23.54	pass

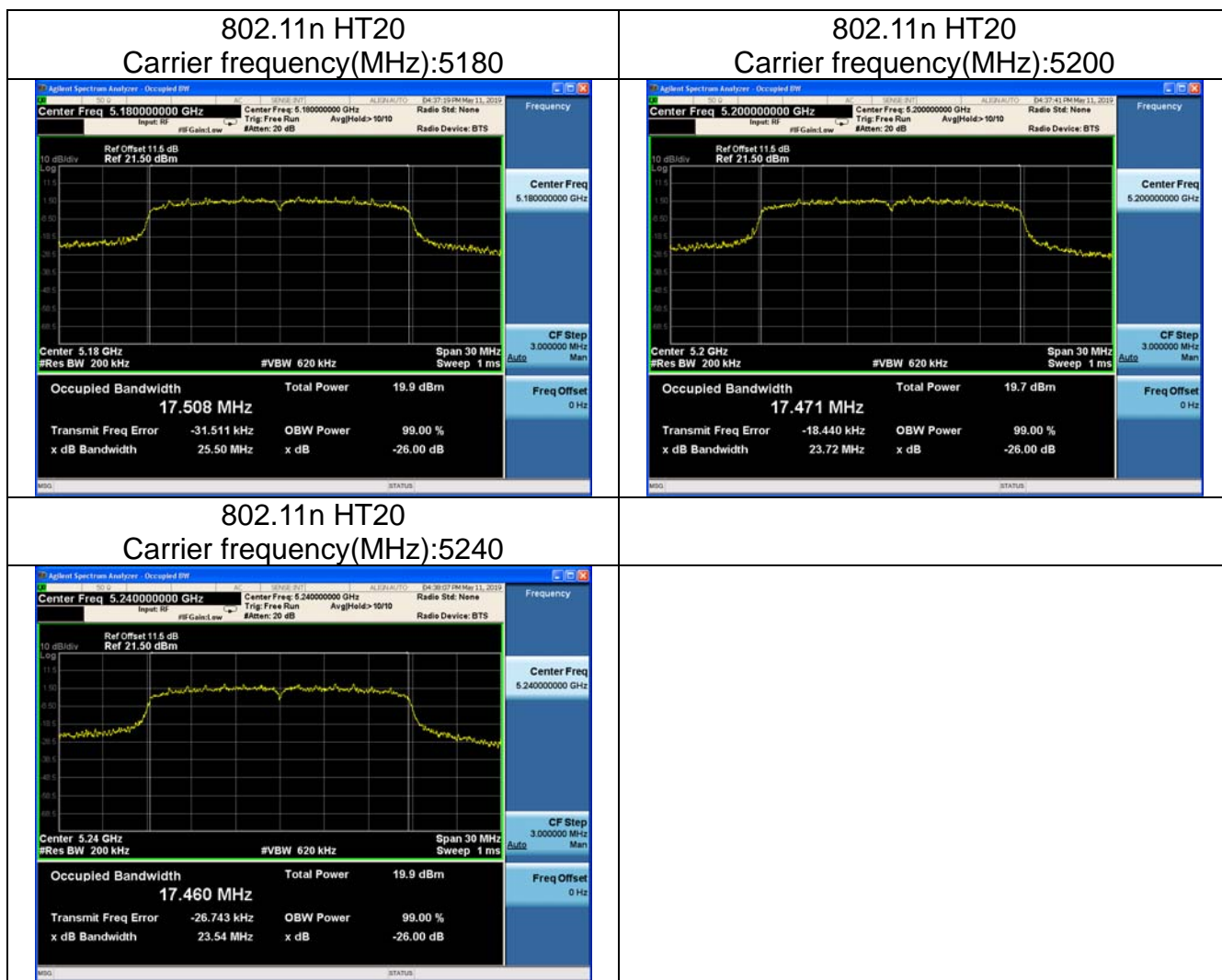

Test Mode: 802.11n HT40 (MIMO Ant1)

Carrier frequency (MHz)	99% Bandwidth(MHz)	Minimum 26dB Bandwidth(MHz)	Conclusion
5190	36.125	53.60	pass
5230	36.104	52.76	pass

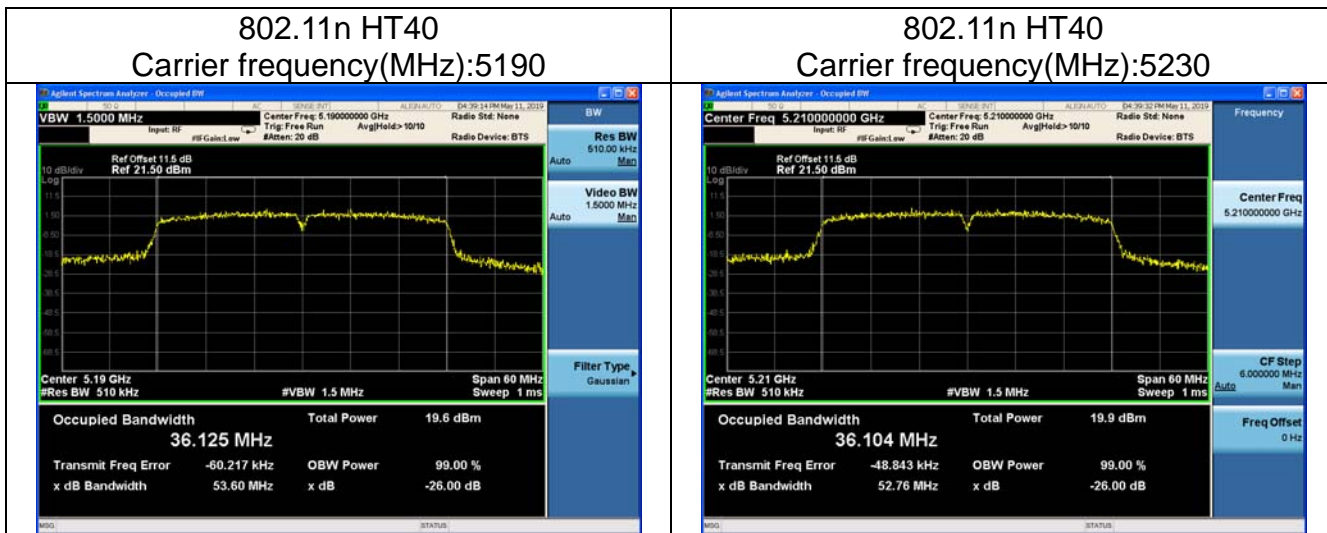

Test Mode: 802.11n HT40 (MIMO Ant2)

Carrier frequency (MHz)	99% Bandwidth(MHz)	Minimum 26dB Bandwidth(MHz)	Conclusion
5190	39.322	57.00	pass
5230	36.241	59.37	pass

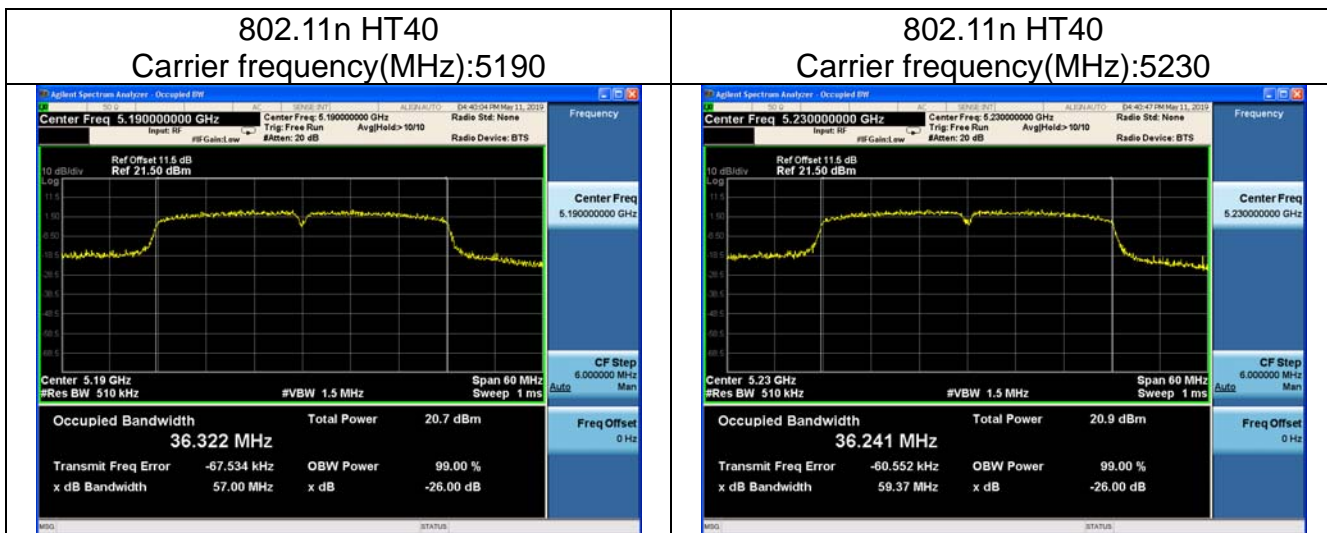

Test Mode: 802.11ac HT80 (MIMO Ant1)

Carrier frequency (MHz)	99% Bandwidth(MHz)	Minimum 26dB Bandwidth(MHz)	Conclusion
5210	75.231	81.27	pass

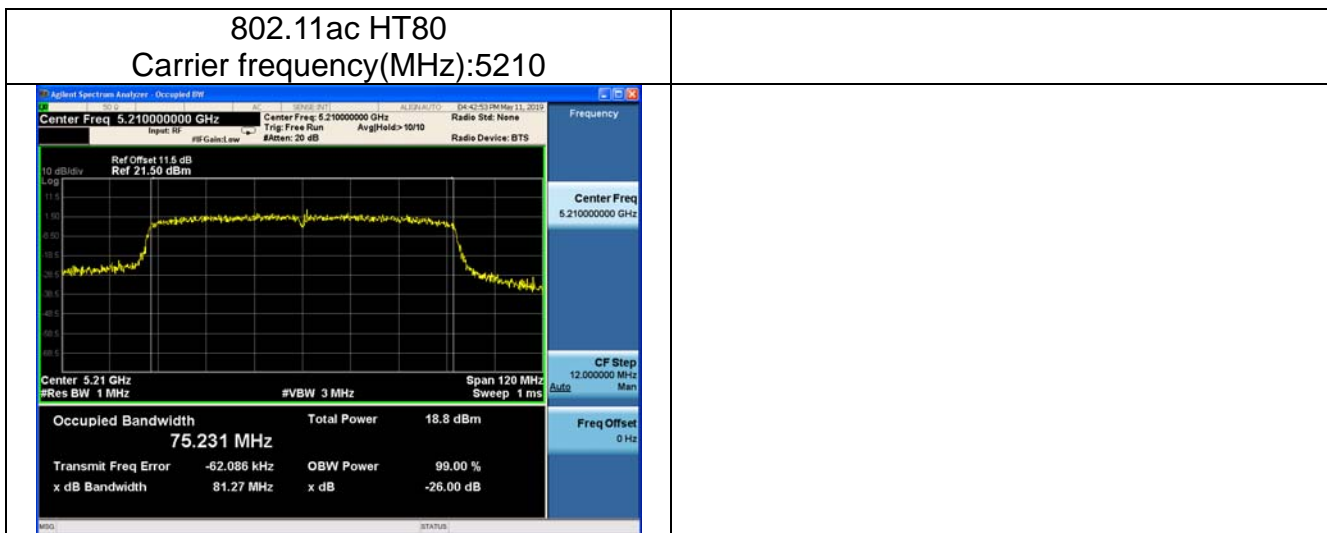

Test Mode: 802.11ac HT80 (MIMO Ant2)

Carrier frequency (MHz)	99% Bandwidth(MHz)	Minimum 26dB Bandwidth(MHz)	Conclusion
5210	75.149	80.64	pass

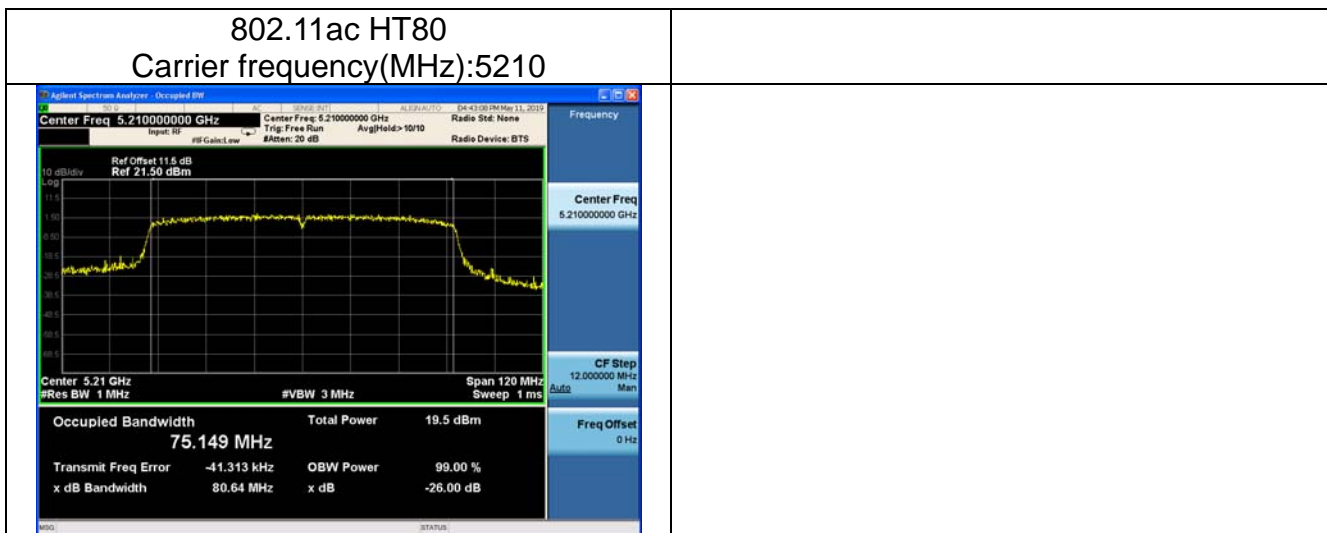

Transmitter Power Spectral Density

Offset 11.5dB = Attenuator 10dB+ Temporary antenna connector loss 0.2dB+ Cable loss 1.3dB

U-NII-1

Test Mode: 802.11a (SISO Ant2)

Carrier frequency (MHz)	Duty Cycle Correction Factor(dB)	Power Spectral Density (dBm/MHz)	Limit (dBm/MHz)	Conclusion
5180	0.190	2.381	17.0	pass
5200	0.190	2.394	17.0	pass
5240	0.190	2.504	17.0	pass

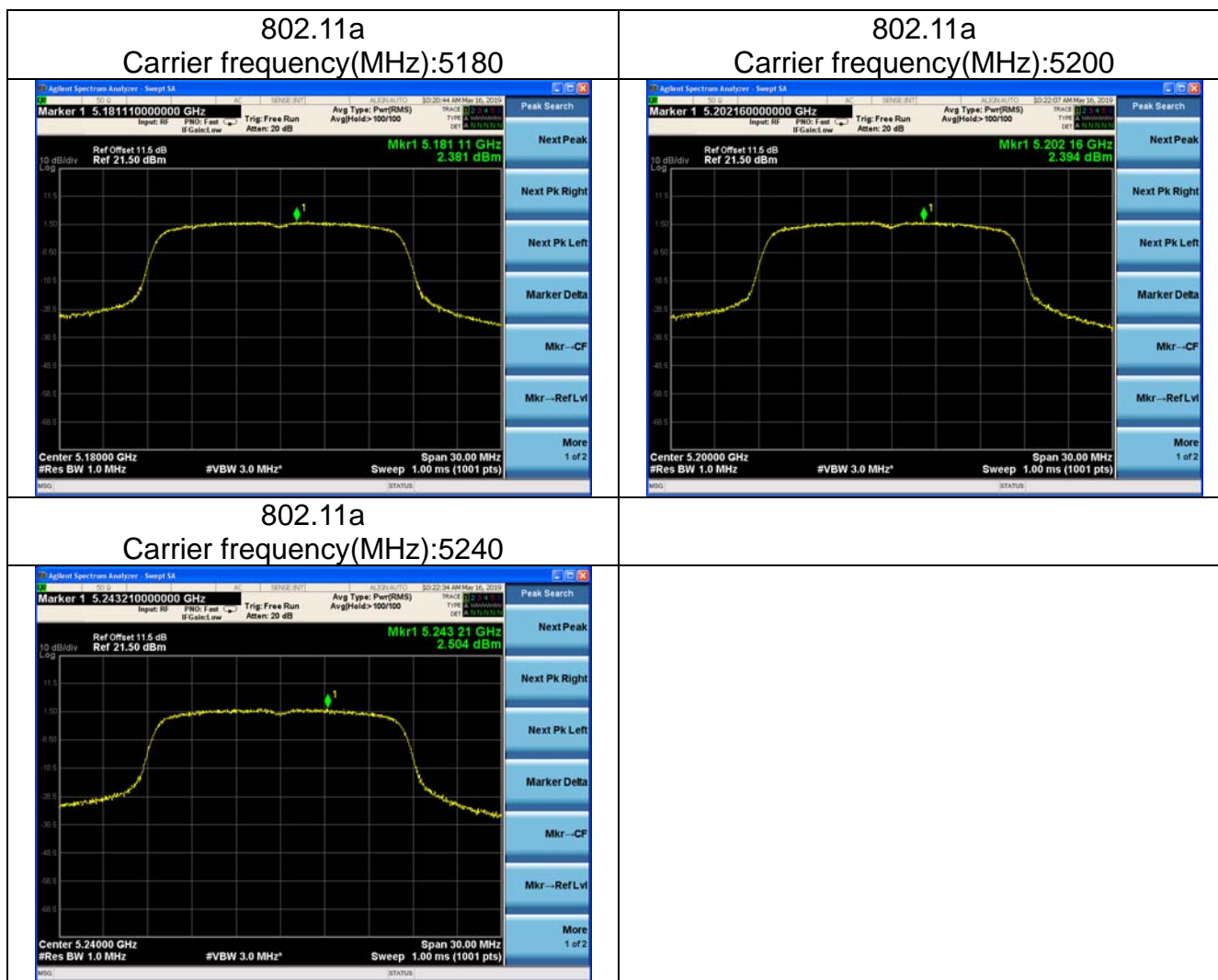

Test Mode: 802.11n HT20 (SISO Ant2)

Carrier frequency (MHz)	Duty Cycle Correction Factor(dB)	Power Spectral Density (dBm/MHz)	Limit (dBm/MHz)	Conclusion
5180	0.200	2.439	17.0	pass
5200	0.200	3.089	17.0	pass
5240	0.200	2.581	17.0	pass

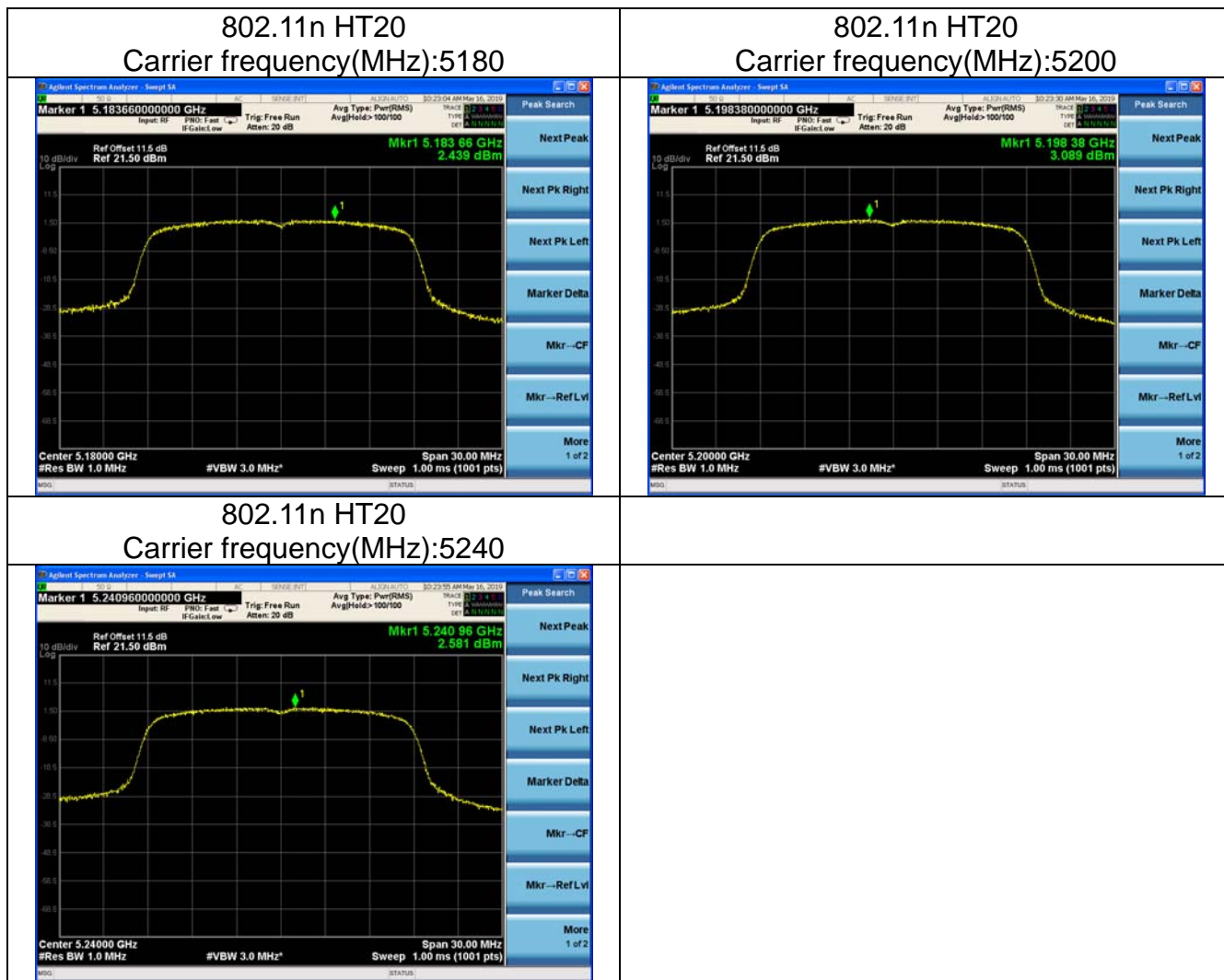

Test Mode: 802.11n HT40 (SISO Ant2)

Carrier frequency (MHz)	Duty Cycle Correction Factor(dB)	Power Spectral Density (dBm/MHz)	Limit (dBm/MHz)	Conclusion
5190	0.360	0.434	17.0	pass
5230	0.360	0.446	17.0	pass

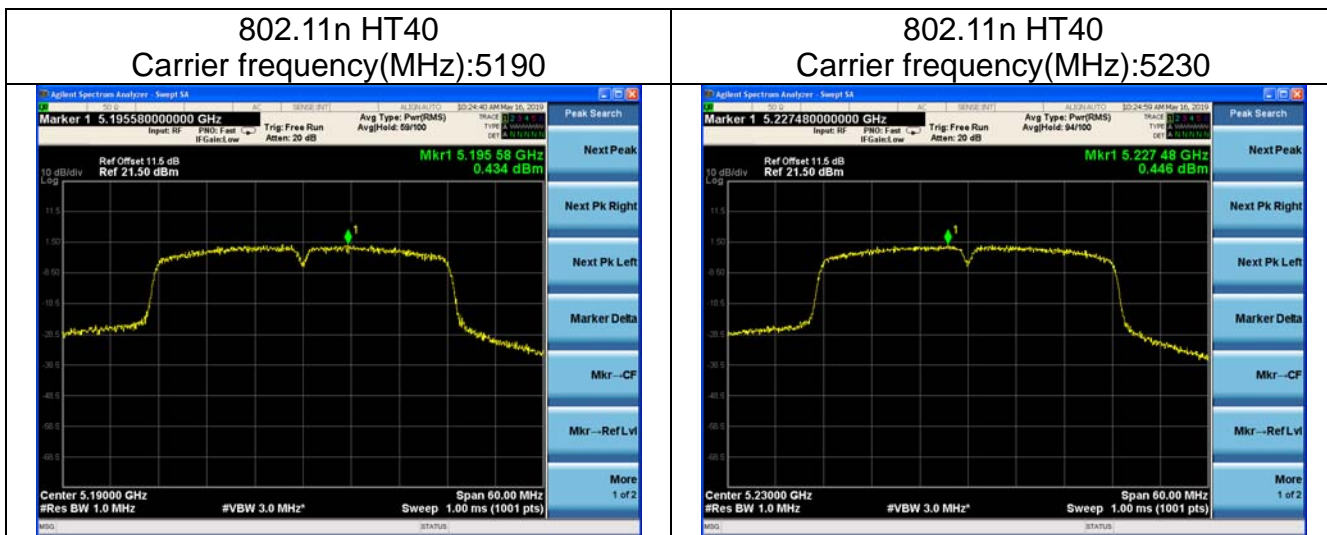

Test Mode: 802.11ac HT80 (SISO Ant2)

Carrier frequency (MHz)	Duty Cycle Correction Factor(dB)	Power Spectral Density (dBm/MHz)	Limit (dBm/MHz)	Conclusion
5210	1.190	-5.216	17.0	pass



Test Mode: 802.11n HT20 (MIMO Ant1+Ant2)

Carrier frequency (MHz)	Duty Cycle Correction Factor(dB)	Ant1 Meas PSD (dBm/MHz)	Ant2 Meas PSD (dBm/MHz)	Total Corr'd PSD (dBm/MHz)	Limit (dBm/MHz)	Conclusion
5180	0.190	2.179	2.939	5.59	17.0	pass
5200	0.190	2.206	2.397	5.31	17.0	pass
5240	0.190	1.834	2.564	5.22	17.0	pass

802.11n HT20 (MIMO Ant1)

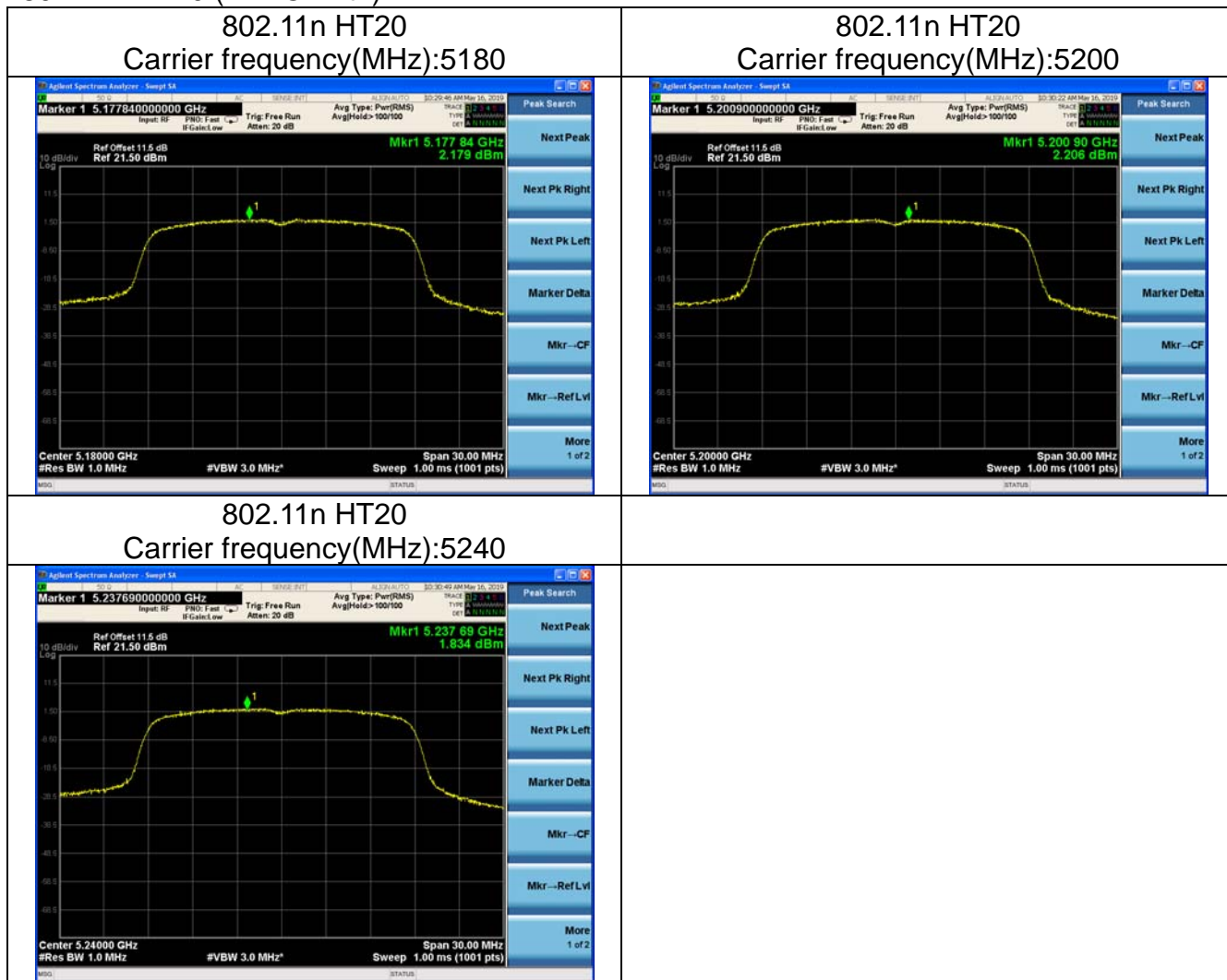

802.11n HT20 (MIMO Ant2)

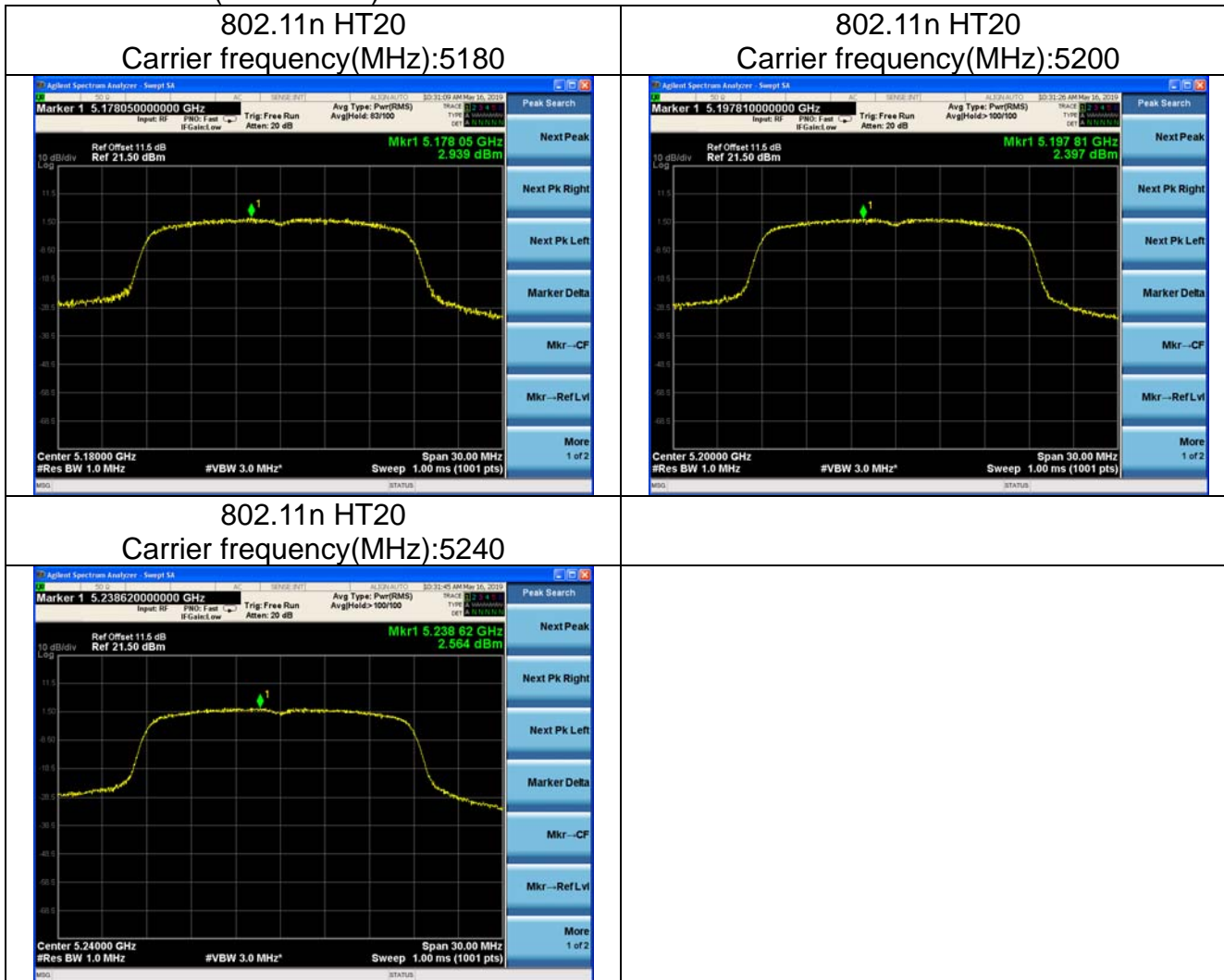

Test Mode: 802.11n HT40 (MIMO Ant1+Ant2)

Carrier frequency (MHz)	Duty Cycle Correction Factor(dB)	Ant1 Meas PSD (dBm/MHz)	Ant2 Meas PSD (dBm/MHz)	Total Corr'd PSD (dBm/MHz)	Limit (dBm/MHz)	Conclusion
5190	0.200	0.504	0.610	3.57	11.0	pass
5230	0.200	0.347	0.488	3.43	11.0	pass

802.11n HT40 (MIMO Ant1)

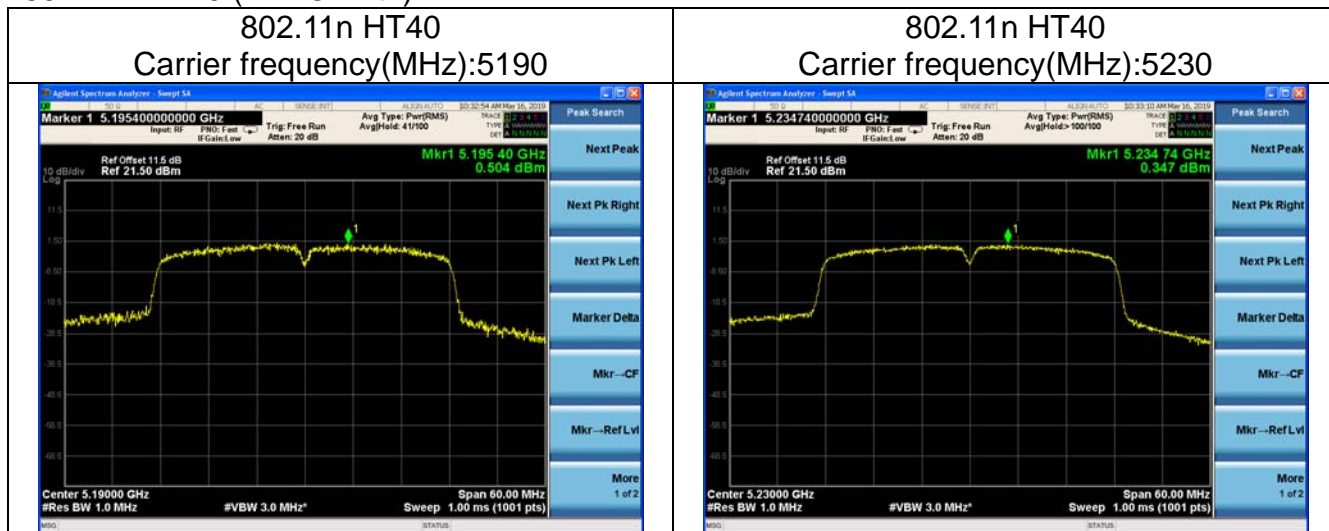

802.11n HT40 (MIMO Ant2)

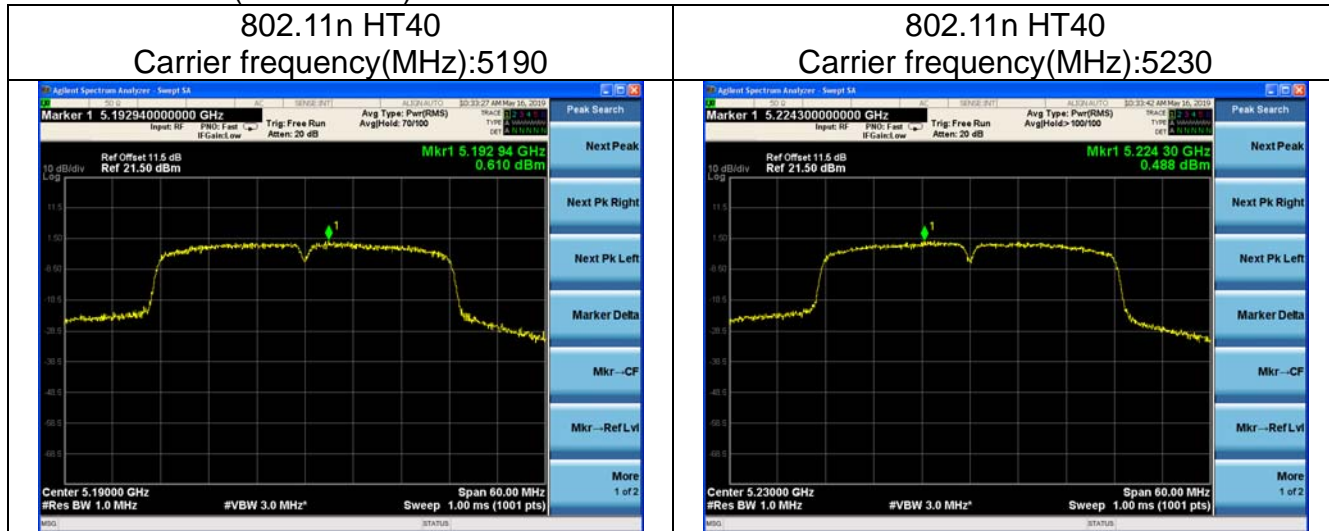

Test Mode: 802.11ac HT80 (MIMO Ant1+Ant2)

Carrier frequency (MHz)	Duty Cycle Correction Factor(dB)	Ant1 Meas PSD (dBm/MHz)	Ant2 Meas PSD (dBm/MHz)	Total Corr'd PSD (dBm/MHz)	Limit (dBm/MHz)	Conclusion
5210	1.190	-5.806	-5.123	-2.44	11.0	pass

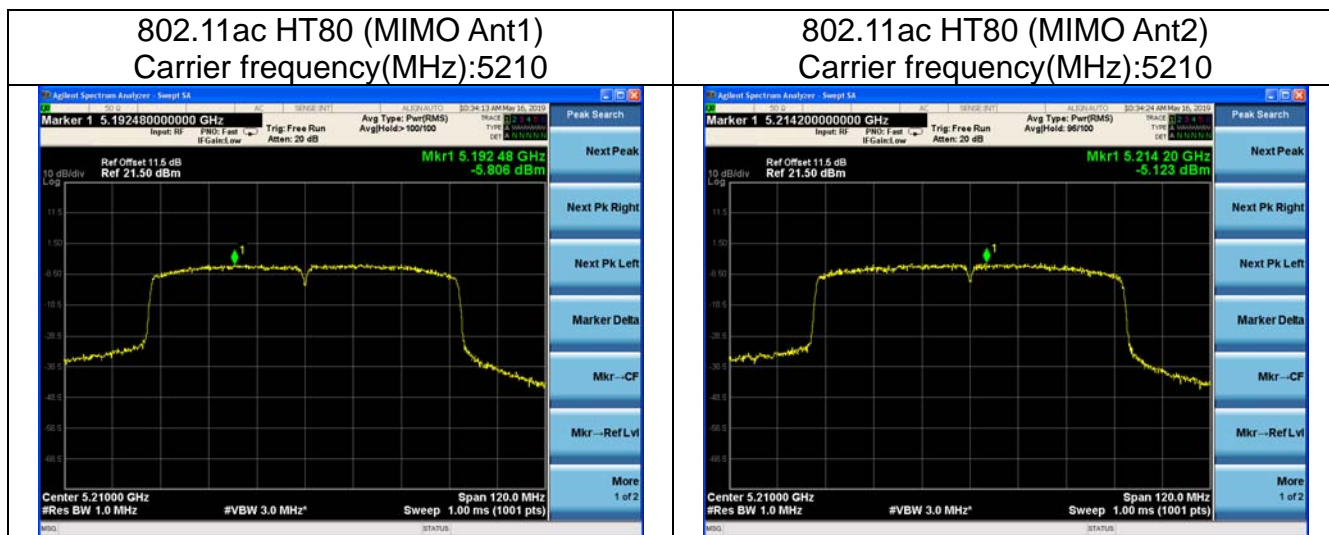

Unwanted Conducted Emission Measurement
U-NII-1

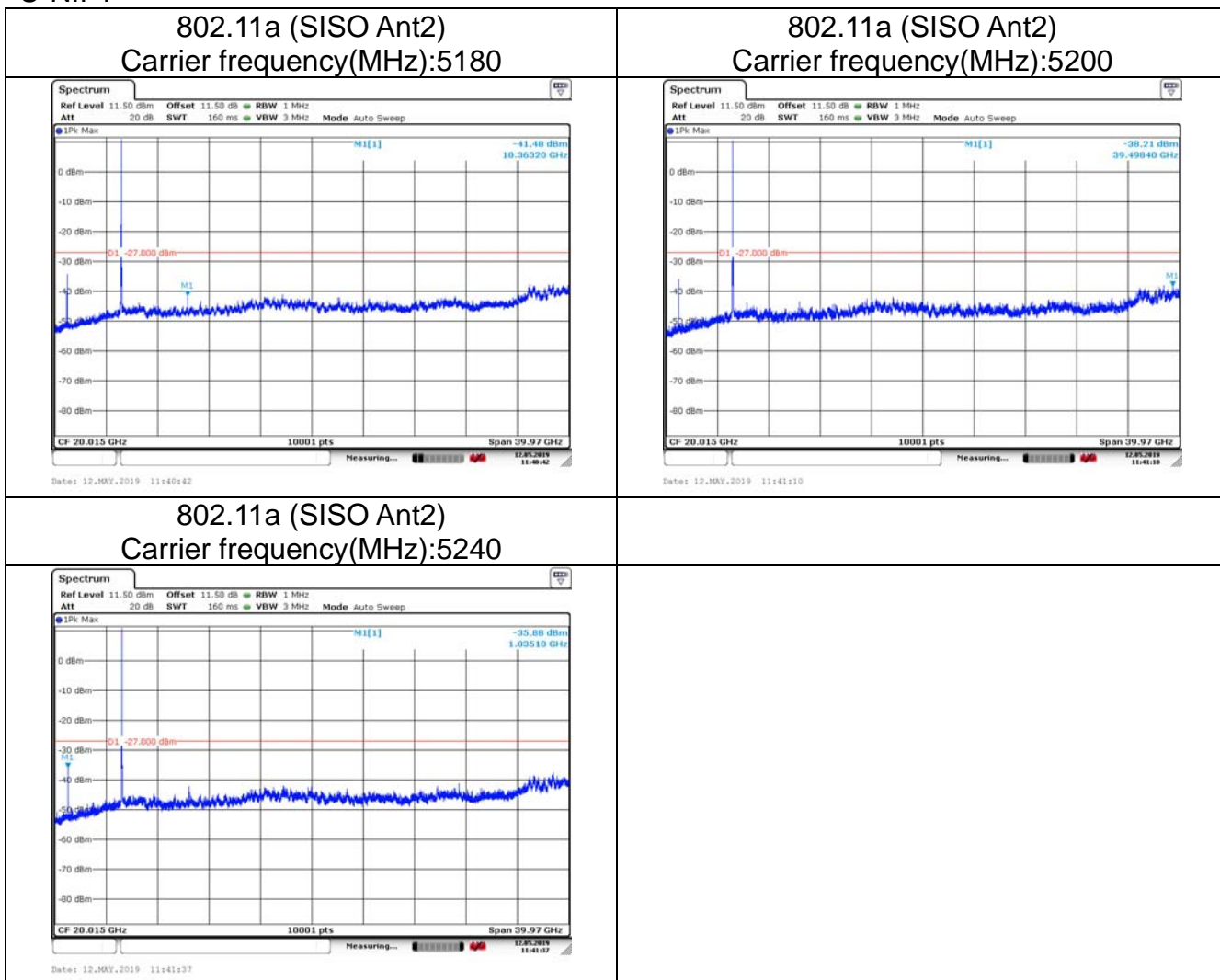

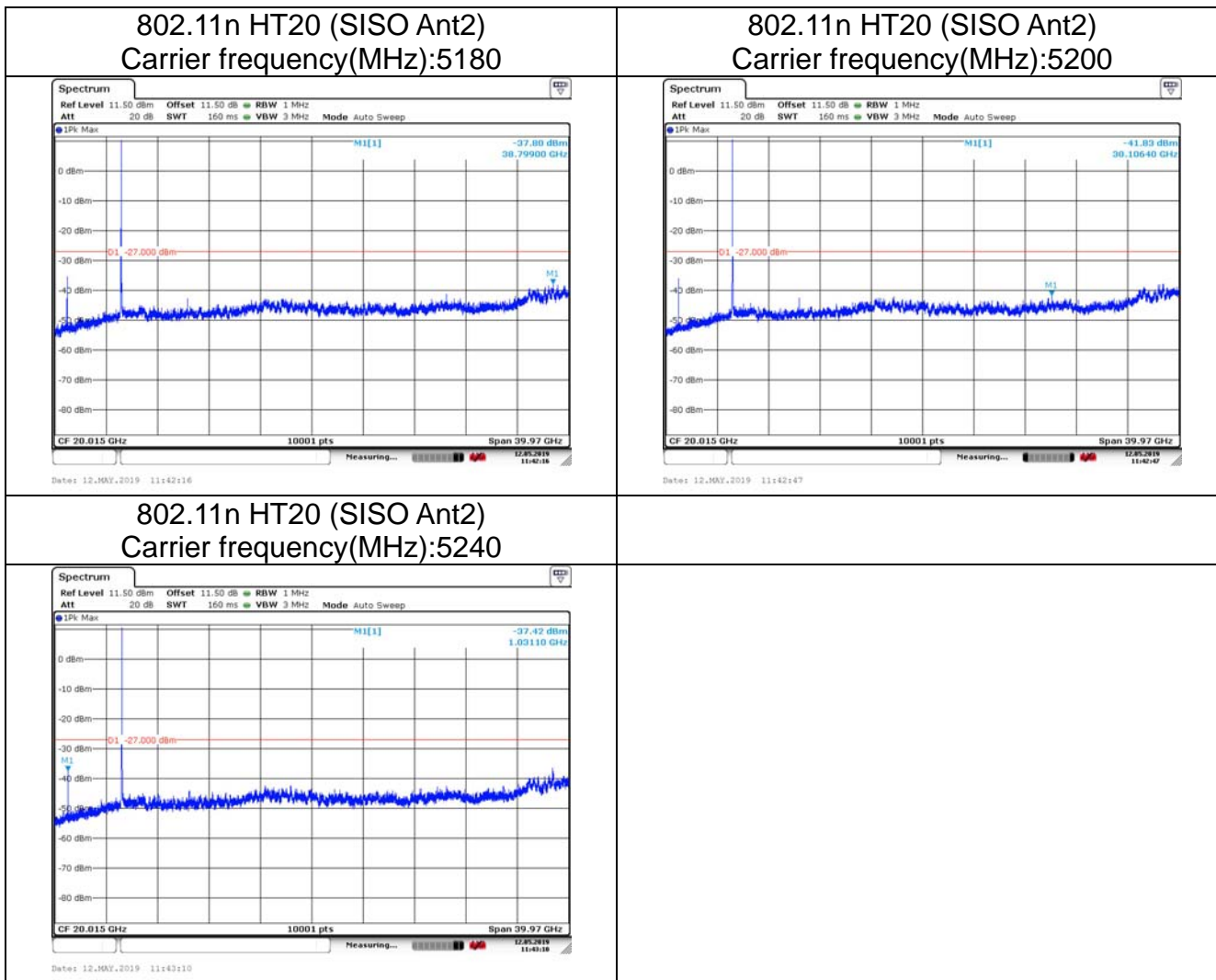

802.11n HT40 (SISO Ant2)
Carrier frequency(MHz):5190

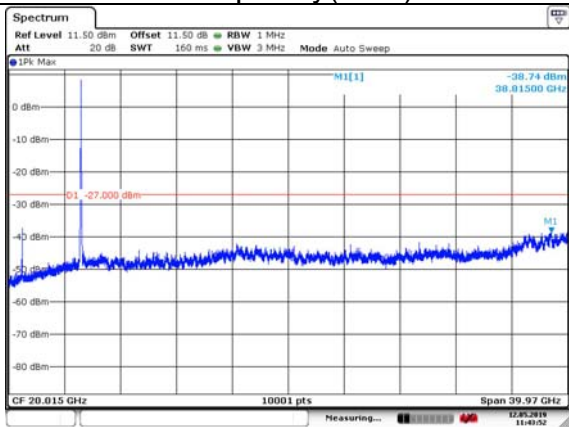

Date: 12.MAY.2019 11:43:52

802.11n HT40 (SISO Ant2)
Carrier frequency(MHz):5230

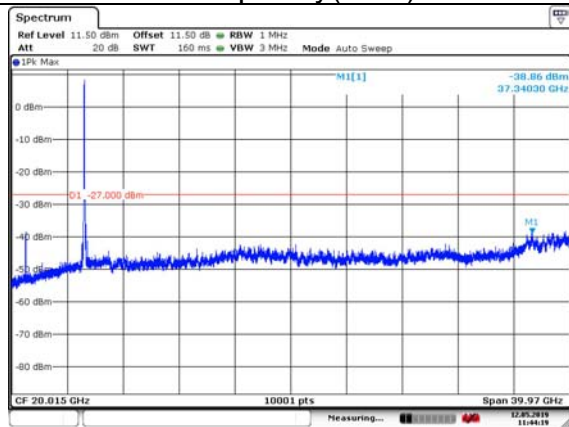

Date: 12.MAY.2019 11:44:18

802.11ac HT80 (SISO Ant2)
Carrier frequency(MHz):5210

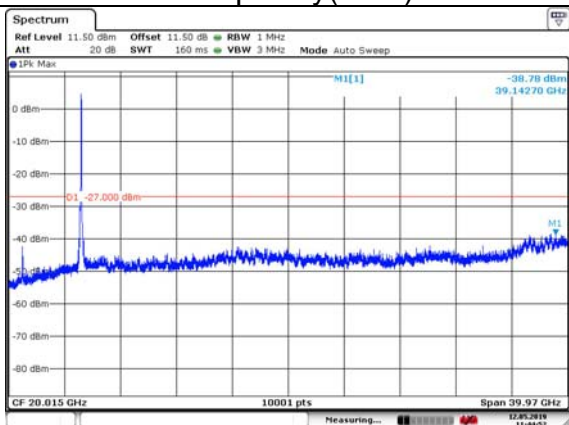

Date: 12.MAY.2019 11:44:52

802.11n HT20 (MIMO Ant1)
Carrier frequency(MHz):5180

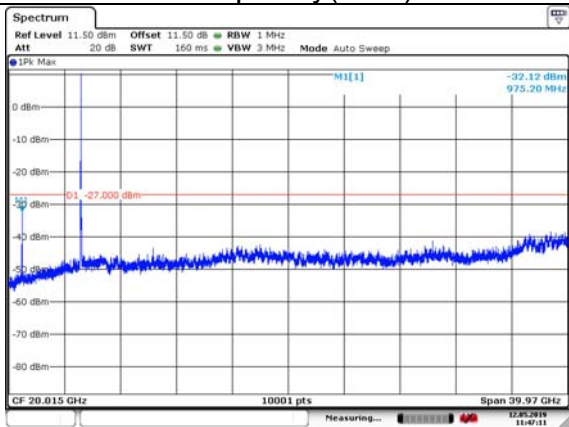

Date: 12.MAY.2019 11:47:11

802.11n HT20 (MIMO Ant1)
Carrier frequency(MHz):5200

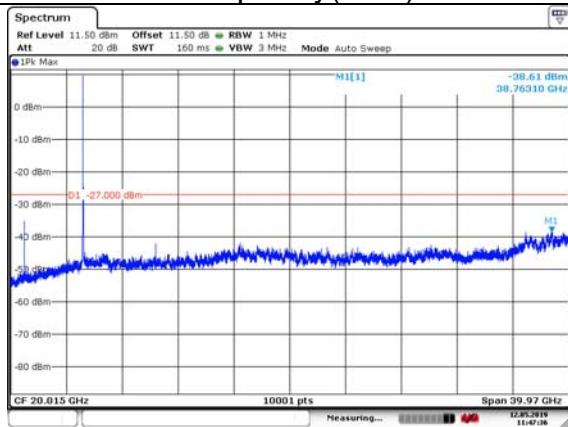

Date: 12.MAY.2019 11:47:16

802.11n HT20 (MIMO Ant1)
Carrier frequency(MHz):5240

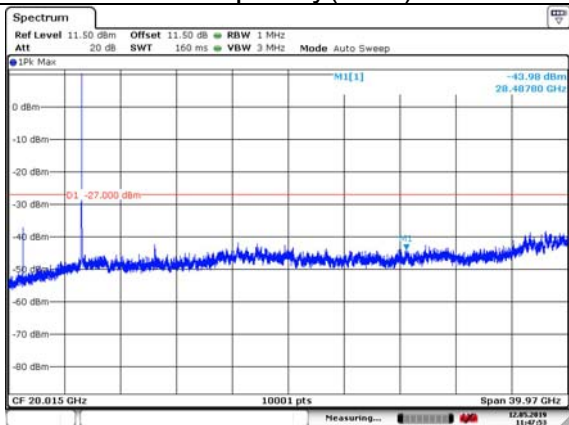

Date: 12.MAY.2019 11:47:52

802.11n HT20 (MIMO Ant2)
 Carrier frequency(MHz):5180

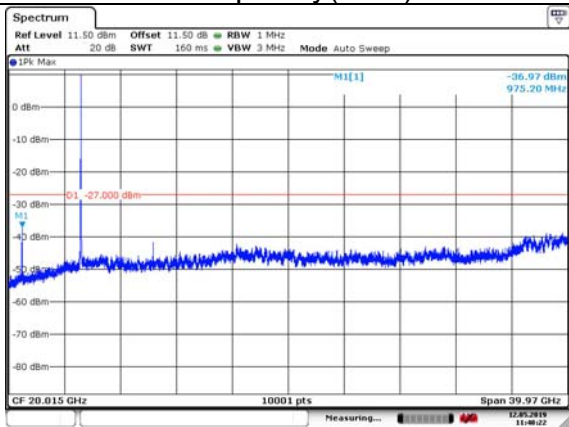

Date: 12.MAY.2019 11:48:21

802.11n HT20 (MIMO Ant2)
 Carrier frequency(MHz):5200

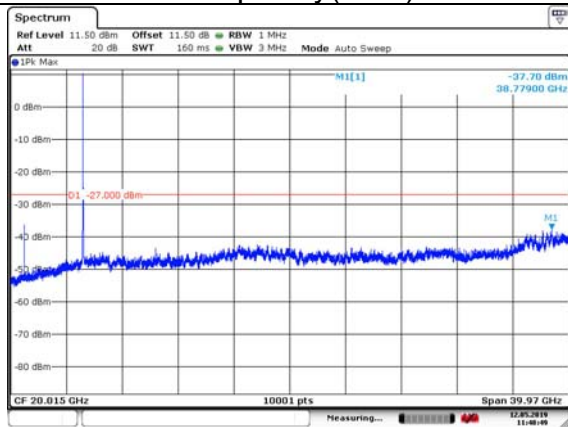

Date: 12.MAY.2019 11:48:48

802.11n HT20 (MIMO Ant2)
 Carrier frequency(MHz):5240

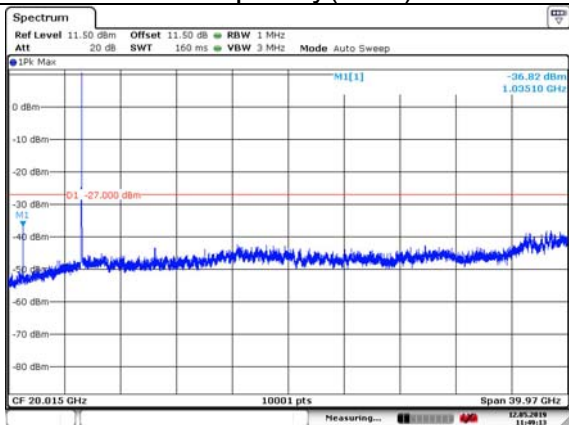

Date: 12.MAY.2019 11:49:12

802.11n HT40 (MIMO Ant1)
Carrier frequency(MHz):5190

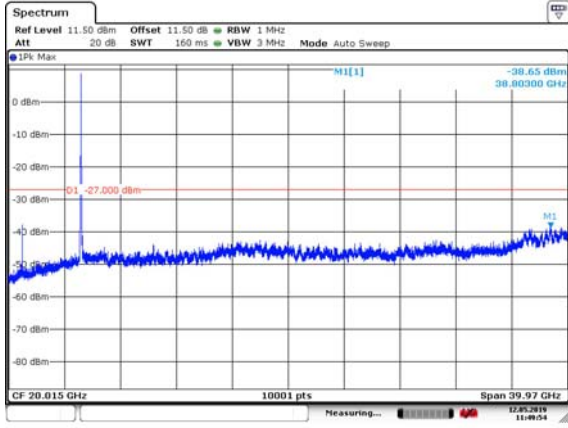

Date: 12.MAY.2019 11:49:54

802.11n HT40 (MIMO Ant1)
Carrier frequency(MHz):5230

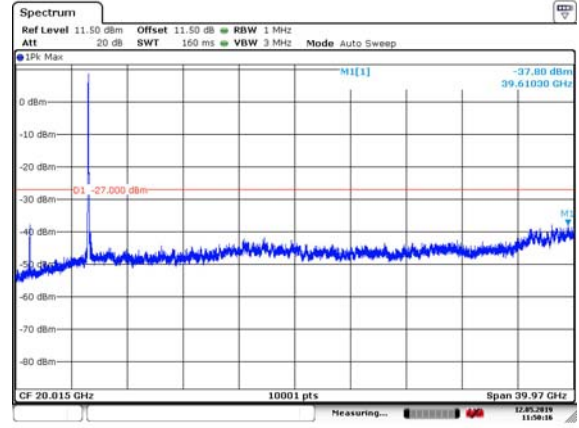

Date: 12.MAY.2019 11:50:16

802.11n HT40 (MIMO Ant2)
Carrier frequency(MHz):5190

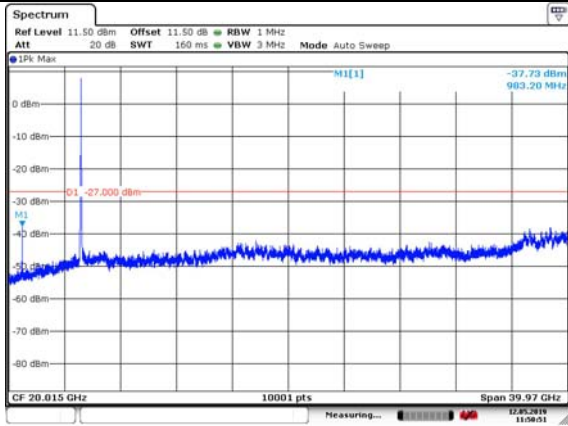

Date: 12.MAY.2019 11:50:50

802.11n HT40 (MIMO Ant2)
Carrier frequency(MHz):5230

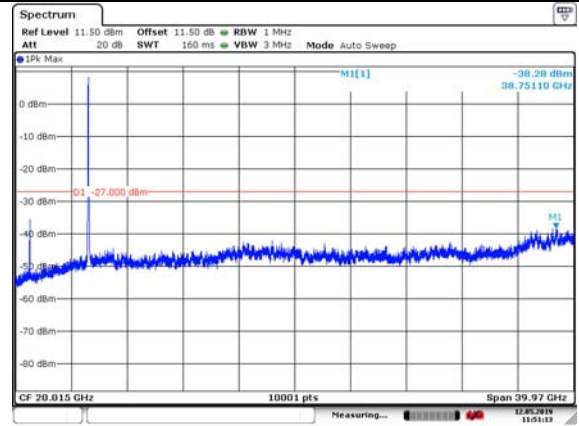

Date: 12.MAY.2019 11:51:13

802.11ac HT80 (MIMO Ant1)
Carrier frequency(MHz):5210

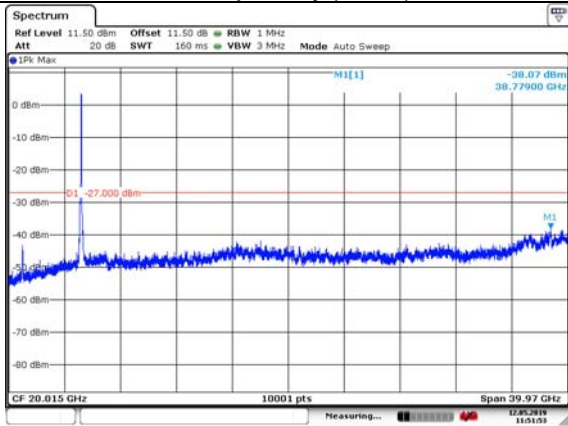

Date: 12.MAY.2019 11:51:52

802.11ac HT80 (MIMO Ant2)
Carrier frequency(MHz):5210

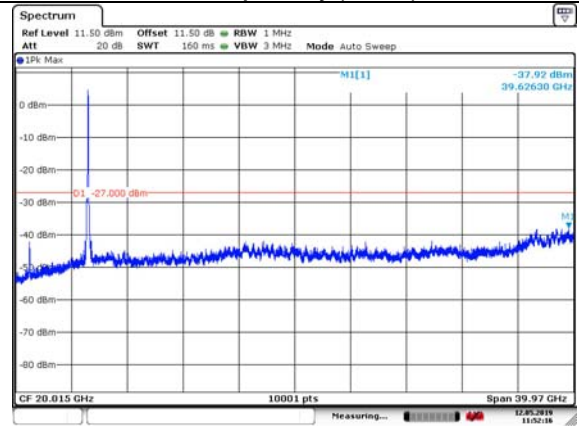

Date: 12.MAY.2019 11:52:15

Frequency Stability

U-NII-1

Mod.	Data Rate	Frequency (MHz)	Frequency Stability(ppm)	Voltage(V)	Temperature(°C)
11a	6Mbps	5180	3.12	NV	-10
11a	6Mbps	5180	0.24	NV	0
11a	6Mbps	5180	-1.34	NV	+10
11a	6Mbps	5180	2.32	HV	+20
11a	6Mbps	5180	-1.78	LV	+20
11a	6Mbps	5180	2.23	NV	+20
11a	6Mbps	5180	3.55	NV	+30
11a	6Mbps	5180	2.39	NV	+40
11a	6Mbps	5180	-1.26	NV	+50
11a	6Mbps	5180	1.67	NV	+55

APPENDIX B – TEST DATA OF RADIATED EMISSION

Radiated Emission Band Edge

The worst case attitude: The mobile lay down. MIMO Ant1+Ant2

The measurement results are obtained as described below:

Measure Level = Reading Level + cable loss + antenna factor

Sample calculation: (99.32 dBuV/m) = (52.42 dB μ V) + (12.4 dB) + (34.5 dB), the corresponding frequency is 5180MHz.

Carrier frequency (MHz): 5180 MHz

Channel No.:36

Test Mode: 802.11a

Polarity:Vertical

Detector: Peak

No	Frequency (MHz)	Measure Level (dBuV/m)	Reading Level (dBuV)	Over Limit (dB)	Limit (dBuV/m)	cable loss (dB)	antenna factor (dB)
1	5180	99.32	52.42	N/A	N/A	12.4	34.5
2	5150	54.39	7.49	-19.61	74	12.4	34.5

Carrier frequency (MHz): 5180

Channel No.:36

Test Mode: 802.11a

Polarity:Horizontal

Detector: Peak

No	Frequency (MHz)	Measure Level (dBuV/m)	Reading Level (dBuV)	Over Limit (dB)	Limit (dBuV/m)	cable loss (dB)	antenna factor (dB)
1	5180	103.50	56.60	N/A	N/A	12.4	34.5
2	5150	54.40	7.50	-19.60	74	12.4	34.5

Carrier frequency (MHz): 5180 MHz

Channel No.: 36

Test Mode: 802.11a

Polarity:Vertical

Detector: Average

No	Frequency (MHz)	Measure Level (dBuV/m)	Reading Level (dBuV)	Over Limit (dB)	Limit (dBuV/m)	cable loss (dB)	antenna factor (dB)
1	5180	92.95	46.05	N/A	N/A	12.4	34.5
2	5150	39.43	-7.47	-14.57	54	12.4	34.5

Carrier frequency (MHz): 5180 MHz
Channel No.: 36
Test Mode: 802.11a
Polarity:Horizontal
Detector: Average

No	Frequency (MHz)	Measure Level (dBuV/m)	Reading Level (dBuV)	Over Limit (dB)	Limit (dBuV/m)	cable loss (dB)	antenna factor (dB)
1	5180	97.63	50.73	N/A	N/A	12.4	34.5
2	5150	40.24	-6.66	-13.76	54	12.4	34.5

Carrier frequency (MHz): 5240 MHz
Channel No.:48
Test Mode: 802.11a
Polarity:Vertical
Detector: Peak

No	Frequency (MHz)	Measure Level (dBuV/m)	Reading Level (dBuV)	Over Limit (dB)	Limit (dBuV/m)	cable loss (dB)	antenna factor (dB)
1	5240	98.51	51.61	N/A	N/A	12.4	34.5
2	5250	53.68	6.78	-20.32	74	12.4	34.5

Carrier frequency (MHz): 5240 MHz
Channel No.:48
Test Mode: 802.11a
Polarity:Horizontal
Detector: Peak

No	Frequency (MHz)	Measure Level (dBuV/m)	Reading Level (dBuV)	Over Limit (dB)	Limit (dBuV/m)	cable loss (dB)	antenna factor (dB)
1	5240	103.17	56.27	N/A	N/A	12.4	34.5
2	5250	53.89	6.99	-20.11	74	12.4	34.5

Carrier frequency (MHz): 5240 MHz
Channel No.:48
Test Mode: 802.11a
Polarity:Vertical
Detector: Average

No	Frequency (MHz)	Measure Level (dBuV/m)	Reading Level (dBuV)	Over Limit (dB)	Limit (dBuV/m)	cable loss (dB)	antenna factor (dB)
1	5240	92.55	45.65	N/A	N/A	12.4	34.5
2	5250	45.77	-1.13	-8.23	54	12.4	34.5

Carrier frequency (MHz): 5240 MHz
Channel No.:48
Test Mode: 802.11a
Polarity:Horizontal
Detector: Average

No	Frequency (MHz)	Measure Level (dBuV/m)	Reading Level (dBuV)	Over Limit (dB)	Limit (dBuV/m)	cable loss (dB)	antenna factor (dB)
1	5240	97.53	50.63	N/A	N/A	12.4	34.5
2	5250	46.70	-0.20	-7.30	54	12.4	34.5

Carrier frequency (MHz): 5180 MHz
Channel No.:36
Test Mode: 802.11n (HT20)
Polarity:Vertical
Detector: Peak

No	Frequency (MHz)	Measure Level (dBuV/m)	Reading Level (dBuV)	Over Limit (dB)	Limit (dBuV/m)	cable loss (dB)	antenna factor (dB)
1	5180	98.49	51.59	N/A	N/A	12.4	34.5
2	5150	53.90	7.00	-20.10	74	12.4	34.5

Carrier frequency (MHz): 5180
Channel No.:36
Test Mode: 802.11n (HT20 MIMO)
Polarity:Horizontal
Detector: Peak

No	Frequency (MHz)	Measure Level (dBuV/m)	Reading Level (dBuV)	Over Limit (dB)	Limit (dBuV/m)	cable loss (dB)	antenna factor (dB)
1	5180	103.15	56.25	N/A	N/A	12.4	34.5
2	5150	54.23	7.33	-19.77	74	12.4	34.5

Carrier frequency (MHz): 5180 MHz
Channel No.: 36
Test Mode: 802.11n (HT20 MIMO)
Polarity:Vertical
Detector: Average

No	Frequency (MHz)	Measure Level (dBuV/m)	Reading Level (dBuV)	Over Limit (dB)	Limit (dBuV/m)	cable loss (dB)	antenna factor (dB)
1	5180	92.81	45.91	N/A	N/A	12.4	34.5
2	5150	39.61	-7.29	-14.39	54	12.4	34.5

Carrier frequency (MHz): 5180 MHz
Channel No.: 36
Test Mode: 802.11n (HT20 MIMO)
Polarity:Horizontal
Detector: Average

No	Frequency (MHz)	Measure Level (dBuV/m)	Reading Level (dBuV)	Over Limit (dB)	Limit (dBuV/m)	cable loss (dB)	antenna factor (dB)
1	5180	97.74	50.84	N/A	N/A	12.4	34.5
2	5150	40.47	-6.43	-13.53	54	12.4	34.5

Carrier frequency (MHz): 5240 MHz
Channel No.:48
Test Mode: 802.11n (HT20 MIMO)
Polarity:Vertical
Detector: Peak

No	Frequency (MHz)	Measure Level (dBuV/m)	Reading Level (dBuV)	Over Limit (dB)	Limit (dBuV/m)	cable loss (dB)	antenna factor (dB)
1	5240	99.02	52.12	N/A	N/A	12.4	34.5
2	5250	53.99	7.09	-20.01	74	12.4	34.5

Carrier frequency (MHz): 5240 MHz
Channel No.:48
Test Mode: 802.11n (HT20 MIMO)
Polarity:Horizontal
Detector: Peak

No	Frequency (MHz)	Measure Level (dBuV/m)	Reading Level (dBuV)	Over Limit (dB)	Limit (dBuV/m)	cable loss (dB)	antenna factor (dB)
1	5240	103.89	56.99	N/A	N/A	12.4	34.5
2	5250	54.89	7.99	-19.11	74	12.4	34.5

Carrier frequency (MHz): 5240 MHz
Channel No.:48
Test Mode: 802.11n (HT20 MIMO)
Polarity:Vertical
Detector: Average

No	Frequency (MHz)	Measure Level (dBuV/m)	Reading Level (dBuV)	Over Limit (dB)	Limit (dBuV/m)	cable loss (dB)	antenna factor (dB)
1	5240	93.80	46.90	N/A	N/A	12.4	34.5
2	5250	45.42	-1.48	-8.58	54	12.4	34.5

Carrier frequency (MHz): 5240 MHz
Channel No.:48
Test Mode: 802.11n (HT20 MIMO)
Polarity:Horizontal
Detector: Average

No	Frequency (MHz)	Measure Level (dBuV/m)	Reading Level (dBuV)	Over Limit (dB)	Limit (dBuV/m)	cable loss (dB)	antenna factor (dB)
1	5240	97.96	51.06	N/A	N/A	12.4	34.5
2	5250	46.27	-0.63	-7.73	54	12.4	34.5

Carrier frequency (MHz): 5190 MHz
Channel No.:38
Test Mode: 802.11n (HT40 MIMO)
Polarity:Vertical
Detector: Peak

No	Frequency (MHz)	Measure Level (dBuV/m)	Reading Level (dBuV)	Over Limit (dB)	Limit (dBuV/m)	cable loss (dB)	antenna factor (dB)
1	5190	99.13	52.23	N/A	N/A	12.4	34.5
2	5150	53.76	6.86	-20.24	74	12.4	34.5

Carrier frequency (MHz): 5190 MHz
Channel No.:38
Test Mode: 802.11n (HT40 MIMO)
Polarity:Horizontal
Detector: Peak

No	Frequency (MHz)	Measure Level (dBuV/m)	Reading Level (dBuV)	Over Limit (dB)	Limit (dBuV/m)	cable loss (dB)	antenna factor (dB)
1	5190	103.65	56.75	N/A	N/A	12.4	34.5
2	5150	54.05	7.15	-19.95	74	12.4	34.5

Carrier frequency (MHz): 5190 MHz
Channel No.:38
Test Mode: 802.11n (HT40 MIMO)
Polarity:Vertical
Detector: Average

No	Frequency (MHz)	Measure Level (dBuV/m)	Reading Level (dBuV)	Over Limit (dB)	Limit (dBuV/m)	cable loss (dB)	antenna factor (dB)
1	5190	92.77	45.87	N/A	N/A	12.4	34.5
2	5150	40.12	-6.78	-13.88	54	12.4	34.5

Carrier frequency (MHz): 5190 MHz
Channel No.:38
Test Mode: 802.11n (HT40 MIMO)
Polarity:Horizontal
Detector: Average

No	Frequency (MHz)	Measure Level (dBuV/m)	Reading Level (dBuV)	Over Limit (dB)	Limit (dBuV/m)	cable loss (dB)	antenna factor (dB)
1	5190	97.41	50.51	N/A	N/A	12.4	34.5
2	5150	40.77	-6.13	-13.23	54	12.4	34.5

Carrier frequency (MHz): 5230 MHz
Channel No.:46
Test Mode: 802.11n (HT40 MIMO)
Polarity:Vertical
Detector: Peak

No	Frequency (MHz)	Measure Level (dBuV/m)	Reading Level (dBuV)	Over Limit (dB)	Limit (dBuV/m)	cable loss (dB)	antenna factor (dB)
1	5230	99.07	52.17	N/A	N/A	12.4	34.5
2	5250	53.89	6.99	-20.11	74	12.4	34.5

Carrier frequency (MHz): 5230 MHz
Channel No.:46
Test Mode: 802.11n (HT40 MIMO)
Polarity:Horizontal
Detector: Peak

No	Frequency (MHz)	Measure Level (dBuV/m)	Reading Level (dBuV)	Over Limit (dB)	Limit (dBuV/m)	cable loss (dB)	antenna factor (dB)
1	5230	103.59	56.69	N/A	N/A	12.4	34.5
2	5250	53.92	7.02	-20.08	74	12.4	34.5

Carrier frequency (MHz): 5230 MHz
Channel No.:46
Test Mode: 802.11n (HT40 MIMO)
Polarity:Vertical
Detector: Average

No	Frequency (MHz)	Measure Level (dBuV/m)	Reading Level (dBuV)	Over Limit (dB)	Limit (dBuV/m)	cable loss (dB)	antenna factor (dB)
1	5230	92.84	45.94	N/A	N/A	12.4	34.5
2	5250	45.62	-1.28	-8.38	54	12.4	34.5

Carrier frequency (MHz): 5230 MHz
Channel No.:46
Test Mode: 802.11n (HT40 MIMO)
Polarity:Horizontal
Detector: Average

No	Frequency (MHz)	Measure Level (dBuV/m)	Reading Level (dBuV)	Over Limit (dB)	Limit (dBuV/m)	cable loss (dB)	antenna factor (dB)
1	5230	97.13	50.23	N/A	N/A	12.4	34.5
2	5250	46.51	-0.39	-7.49	54	12.4	34.5

Carrier frequency (MHz): 5180 MHz
Channel No.:36
Test Mode: 802.11ac (VHT20 MIMO)
Polarity:Vertical
Detector: Peak

No	Frequency (MHz)	Measure Level (dBuV/m)	Reading Level (dBuV)	Over Limit (dB)	Limit (dBuV/m)	cable loss (dB)	antenna factor (dB)
1	5180	98.31	51.41	N/A	N/A	12.4	34.5
2	5150	53.83	6.93	-20.17	74	12.4	34.5

Carrier frequency (MHz): 5180 MHz
Channel No.:36
Test Mode: 802.11ac (VHT20 MIMO)
Polarity:Horizontal
Detector: Peak

No	Frequency (MHz)	Measure Level (dBuV/m)	Reading Level (dBuV)	Over Limit (dB)	Limit (dBuV/m)	cable loss (dB)	antenna factor (dB)
1	5180	103.26	56.36	N/A	N/A	12.4	34.5
2	5150	54.31	7.41	-19.69	74	12.4	34.5

Carrier frequency (MHz): 5180 MHz
Channel No.: 36
Test Mode: 802.11ac (VHT20 MIMO)
Polarity:Vertical
Detector: Average

No	Frequency (MHz)	Measure Level (dBuV/m)	Reading Level (dBuV)	Over Limit (dB)	Limit (dBuV/m)	cable loss (dB)	antenna factor (dB)
1	5180	93.50	46.60	N/A	N/A	12.4	34.5
2	5150	39.91	-6.99	-14.09	54	12.4	34.5

Carrier frequency (MHz): 5180 MHz
Channel No.: 36
Test Mode: 802.11ac (VHT20 MIMO)
Polarity:Horizontal
Detector: Average

No	Frequency (MHz)	Measure Level (dBuV/m)	Reading Level (dBuV)	Over Limit (dB)	Limit (dBuV/m)	cable loss (dB)	antenna factor (dB)
1	5180	97.67	50.77	N/A	N/A	12.4	34.5
2	5150	40.78	-6.12	-13.22	54	12.4	34.5

Carrier frequency (MHz): 5240 MHz
Channel No.:48
Test Mode: 802.11ac (VHT20 MIMO)
Polarity:Vertical
Detector: Peak

No	Frequency (MHz)	Measure Level (dBuV/m)	Reading Level (dBuV)	Over Limit (dB)	Limit (dBuV/m)	cable loss (dB)	antenna factor (dB)
1	5240	98.81	51.91	N/A	N/A	12.4	34.5
2	5250	53.57	6.67	-20.43	74	12.4	34.5

Carrier frequency (MHz): 5240 MHz
Channel No.:48
Test Mode: 802.11ac (VHT20 MIMO)
Polarity:Horizontal
Detector: Peak

No	Frequency (MHz)	Measure Level (dBuV/m)	Reading Level (dBuV)	Over Limit (dB)	Limit (dBuV/m)	cable loss (dB)	antenna factor (dB)
1	5240	103.31	56.41	N/A	N/A	12.4	34.5
2	5250	53.53	6.63	-20.47	74	12.4	34.5

Carrier frequency (MHz): 5240 MHz
Channel No.:48
Test Mode: 802.11ac (VHT20 MIMO)
Polarity:Vertical
Detector: Average

No	Frequency (MHz)	Measure Level (dBuV/m)	Reading Level (dBuV)	Over Limit (dB)	Limit (dBuV/m)	cable loss (dB)	antenna factor (dB)
1	5240	93.11	46.21	N/A	N/A	12.4	34.5
2	5250	45.33	-1.57	-8.67	54	12.4	34.5

Carrier frequency (MHz): 5240 MHz
Channel No.:48
Test Mode: 802.11ac (VHT20 MIMO)
Polarity:Horizontal
Detector: Average

No	Frequency (MHz)	Measure Level (dBuV/m)	Reading Level (dBuV)	Over Limit (dB)	Limit (dBuV/m)	cable loss (dB)	antenna factor (dB)
1	5240	97.41	50.51	N/A	N/A	12.4	34.5
2	5250	46.18	-0.72	-7.82	54	12.4	34.5

Carrier frequency (MHz): 5190 MHz
Channel No.:38
Test Mode: 802.11ac (VHT40 MIMO)
Polarity:Vertical
Detector: Peak

No	Frequency (MHz)	Measure Level (dBuV/m)	Reading Level (dBuV)	Over Limit (dB)	Limit (dBuV/m)	cable loss (dB)	antenna factor (dB)
1	5190	99.26	52.36	N/A	N/A	12.4	34.5
2	5150	53.51	6.61	-20.49	74	12.4	34.5

Carrier frequency (MHz): 5190 MHz
Channel No.:38
Test Mode: 802.11ac (VHT40 MIMO)
Polarity:Horizontal
Detector: Peak

No	Frequency (MHz)	Measure Level (dBuV/m)	Reading Level (dBuV)	Over Limit (dB)	Limit (dBuV/m)	cable loss (dB)	antenna factor (dB)
1	5190	103.47	56.57	N/A	N/A	12.4	34.5
2	5150	53.57	6.67	-20.43	74	12.4	34.5

Carrier frequency (MHz): 5190 MHz
Channel No.:38
Test Mode: 802.11ac (VHT40 MIMO)
Polarity:Vertical
Detector: Average

No	Frequency (MHz)	Measure Level (dBuV/m)	Reading Level (dBuV)	Over Limit (dB)	Limit (dBuV/m)	cable loss (dB)	antenna factor (dB)
1	5190	92.94	46.04	N/A	N/A	12.4	34.5
2	5150	46.61	-0.29	-7.39	54	12.4	34.5

Carrier frequency (MHz): 5190 MHz
Channel No.:38
Test Mode: 802.11ac (VHT40 MIMO)
Polarity:Horizontal
Detector: Average

No	Frequency (MHz)	Measure Level (dBuV/m)	Reading Level (dBuV)	Over Limit (dB)	Limit (dBuV/m)	cable loss (dB)	antenna factor (dB)
1	5190	97.93	51.03	N/A	N/A	12.4	34.5
2	5150	46.09	-0.81	-7.91	54	12.4	34.5

Carrier frequency (MHz): 5230 MHz
Channel No.:46
Test Mode: 802.11ac (VHT40 MIMO)
Polarity:Vertical
Detector: Peak

No	Frequency (MHz)	Measure Level (dBuV/m)	Reading Level (dBuV)	Over Limit (dB)	Limit (dBuV/m)	cable loss (dB)	antenna factor (dB)
1	5230	99.37	52.47	N/A	N/A	12.4	34.5
2	5250	54.09	7.19	-19.91	74	12.4	34.5

Carrier frequency (MHz): 5230 MHz
Channel No.:46
Test Mode: 802.11ac (VHT40 MIMO)
Polarity:Horizontal
Detector: Peak

No	Frequency (MHz)	Measure Level (dBuV/m)	Reading Level (dBuV)	Over Limit (dB)	Limit (dBuV/m)	cable loss (dB)	antenna factor (dB)
1	5230	103.47	56.57	N/A	N/A	12.4	34.5
2	5250	53.64	6.74	-20.36	74	12.4	34.5

Carrier frequency (MHz): 5230 MHz
Channel No.:46
Test Mode: 802.11ac (VHT40 MIMO)
Polarity:Vertical
Detector: Average

No	Frequency (MHz)	Measure Level (dBuV/m)	Reading Level (dBuV)	Over Limit (dB)	Limit (dBuV/m)	cable loss (dB)	antenna factor (dB)
1	5230	93.20	46.30	N/A	N/A	12.4	34.5
2	5250	45.80	-1.10	-8.20	54	12.4	34.5

Carrier frequency (MHz): 5230 MHz
Channel No.:46
Test Mode: 802.11ac (VHT40 MIMO)
Polarity:Horizontal
Detector: Average

No	Frequency (MHz)	Measure Level (dBuV/m)	Reading Level (dBuV)	Over Limit (dB)	Limit (dBuV/m)	cable loss (dB)	antenna factor (dB)
1	5230	97.30	50.40	N/A	N/A	12.4	34.5
2	5250	46.42	-0.48	-7.58	54	12.4	34.5

Carrier frequency (MHz): 5210 MHz
Channel No.:42
Test Mode: 802.11ac (VHT80 MIMO)
Polarity:Vertical
Detector: Peak

No	Frequency (MHz)	Measure Level (dBuV/m)	Reading Level (dBuV)	Over Limit (dB)	Limit (dBuV/m)	cable loss (dB)	antenna factor (dB)
1	5210	99.21	52.31	N/A	N/A	12.4	34.5
2	5150	54.29	7.39	-19.71	74	12.4	34.5
3	5250	54.48	7.58	-19.52	74	12.4	34.5

Carrier frequency (MHz): 5210 MHz
Channel No.:42
Test Mode: 802.11ac (VHT80 MIMO)
Polarity:Horizontal
Detector: Peak

No	Frequency (MHz)	Measure Level (dBuV/m)	Reading Level (dBuV)	Over Limit (dB)	Limit (dBuV/m)	cable loss (dB)	antenna factor (dB)
1	5210	102.27	55.37	N/A	N/A	12.4	34.5
2	5150	54.49	7.59	-19.51	74	12.4	34.5
3	5250	53.68	6.78	-20.32	74	12.4	34.5

Carrier frequency (MHz): 5210 MHz
 Channel No.:42
 Test Mode: 802.11ac (VHT80 MIMO)
 Polarity:Vertical
 Detector: Average

No	Frequency (MHz)	Measure Level (dBuV/m)	Reading Level (dBuV)	Over Limit (dB)	Limit (dBuV/m)	cable loss (dB)	antenna factor (dB)
1	5210	92.90	46.00	N/A	N/A	12.4	34.5
2	5150	40.16	-6.74	-13.84	54	12.4	34.5
3	5250	46.40	-0.50	-7.60	54	12.4	34.5

Carrier frequency (MHz): 5210 MHz
 Channel No.:42
 Test Mode: 802.11ac (VHT80 MIMO)
 Polarity:Horizontal
 Detector: Average

No	Frequency (MHz)	Measure Level (dBuV/m)	Reading Level (dBuV)	Over Limit (dB)	Limit (dBuV/m)	cable loss (dB)	antenna factor (dB)
1	5210	97.58	50.68	N/A	N/A	12.4	34.5
2	5150	41.02	-5.88	-12.98	54	12.4	34.5
3	5250	45.03	-1.87	-8.97	54	12.4	34.5

Sample Calculations

Determining Spurious Emissions Levels

A “reference path loss” is established and the A_{Rpl} is the attenuation of “reference path loss”, and including the gain of receive antenna, the gain of the preamplifier, the cable loss.

The measurement results are obtained as described below:

$$\text{Result} = P_{\text{mea}} + A_{Rpl}$$

Sample calculation: $(33.83 \text{ dB}\mu\text{V/m}) = (56.43 \text{ dB}\mu\text{V}) + (-22.6 \text{ dB/m})$, the corresponding frequency is 86.435833MHz.

The worst case attitude: The EUT lay down.

For 802.11a Channel No.:36

Frequency(MHz)	Result(dBuV/m)	ARpl (dB)	Pmea (dBuV/m)	Polarity	Limit (dBuV/m)
86.435833	33.83	-22.6	56.43	Vertical	40.00
87.350833	34.27	-22.3	56.57	Vertical	40.00
98.118333	28.80	-19.6	48.4	Vertical	43.50
113.338750	30.41	-20.5	50.91	Vertical	43.50
124.007500	32.37	-22.1	54.47	Vertical	43.50
140.802083	25.30	-23.0	48.3	Vertical	43.50

For 802.11n(HT20 MIMO) Channel No.:36

Frequency(MHz)	Result(dBuV/m)	ARpl (dB)	Pmea (dBuV/m)	Polarity	Limit (dBuV/m)
86.415833	33.81	-22.6	56.41	Vertical	40.00
87.457083	34.32	-22.3	56.62	Vertical	40.00
99.718333	29.92	-19.4	49.32	Vertical	43.50
114.921667	29.99	-20.7	50.69	Vertical	43.50
124.499583	32.30	-22.2	54.5	Vertical	43.50
142.260417	25.12	-23.0	48.12	Vertical	43.50

For 802.11ac(HT20 MIMO) Channel No.:36

Frequency(MHz)	Result(dBuV/m)	ARpl (dB)	Pmea (dBuV/m)	Polarity	Limit (dBuV/m)
84.587917	33.14	-23.3	56.44	Vertical	40.00
87.305000	34.27	-22.3	56.57	Vertical	40.00
98.606667	29.18	-19.6	48.78	Vertical	43.50
113.434167	30.88	-20.5	51.38	Vertical	43.50
122.641250	32.52	-21.9	54.42	Vertical	43.50
140.797500	25.25	-23.0	48.25	Vertical	43.50

For 802.11a Channel No.:40

Frequency(MHz)	Result(dBuV/m)	ARpl (dB)	Pmea (dBuV/m)	Polarity	Limit (dBuV/m)
86.415417	33.79	-22.6	56.39	Vertical	40.00
87.411250	34.29	-22.3	56.59	Vertical	40.00
98.320000	29.38	-19.6	48.98	Vertical	43.50
113.442500	30.02	-20.5	50.52	Vertical	43.50
124.289167	32.33	-22.1	54.43	Vertical	43.50
141.364167	25.26	-23.0	48.26	Vertical	43.50

For 802.11n(HT20 MIMO) Channel No.:40

Frequency(MHz)	Result(dBuV/m)	ARpl (dB)	Pmea (dBuV/m)	Polarity	Limit (dBuV/m)
84.301250	33.10	-23.4	56.5	Vertical	40.00
87.514167	34.33	-22.2	56.53	Vertical	40.00
101.077500	28.06	-19.4	47.46	Vertical	43.50
110.650000	32.12	-20.1	52.22	Vertical	43.50
121.782083	32.44	-21.8	54.24	Vertical	43.50
122.176250	32.50	-21.9	54.4	Vertical	43.50

For 802.11ac(HT20 MIMO) Channel No.:40

Frequency(MHz)	Result(dBuV/m)	ARpl (dB)	Pmea (dBuV/m)	Polarity	Limit (dBuV/m)
86.476250	33.84	-22.6	56.44	Vertical	40.00
87.477083	34.32	-22.2	56.52	Vertical	40.00
99.784167	29.57	-19.4	48.97	Vertical	43.50
115.910833	29.73	-20.9	50.63	Vertical	43.50
124.681250	32.34	-22.2	54.54	Vertical	43.50
143.811667	24.63	-23.0	47.63	Vertical	43.50

For 802.11a Channel No.:48

Frequency(MHz)	Result(dBuV/m)	ARpl (dB)	Pmea (dBuV/m)	Polarity	Limit (dBuV/m)
85.255417	33.40	-23.1	56.5	Vertical	40.00
86.577083	33.99	-22.6	56.59	Vertical	40.00
108.059167	30.15	-19.8	49.95	Vertical	43.50
115.929583	29.82	-20.9	50.72	Vertical	43.50
117.405833	29.48	-21.2	50.68	Vertical	43.50
124.520417	32.30	-22.2	54.5	Vertical	43.50

For 802.11n(HT20 MIMO) Channel No.:48

Frequency(MHz)	Result(dBuV/m)	ARpl (dB)	Pmea (dBuV/m)	Polarity	Limit (dBuV/m)
84.442500	33.09	-23.3	56.39	Vertical	40.00
87.517083	34.31	-22.2	56.51	Vertical	40.00
100.917083	28.41	-19.4	47.81	Vertical	43.50
110.549583	32.15	-20.1	52.25	Vertical	43.50
121.882083	32.49	-21.8	54.29	Vertical	43.50
123.962917	32.40	-22.1	54.5	Vertical	43.50

For 802.11ac(HT20 MIMO) Channel No.:48

Frequency(MHz)	Result(dBuV/m)	ARpl (dB)	Pmea (dBuV/m)	Polarity	Limit (dBuV/m)
85.013333	33.31	-23.2	56.51	Vertical	40.00
86.536667	33.89	-22.6	56.49	Vertical	40.00
98.561250	29.10	-19.6	48.7	Vertical	43.50
111.323750	31.95	-20.2	52.15	Vertical	43.50
121.892500	32.50	-21.8	54.3	Vertical	43.50
139.205417	24.88	-23.0	47.88	Vertical	43.50

Carrier frequency (MHz): 5180
Channel No.:36

Full Spectrum

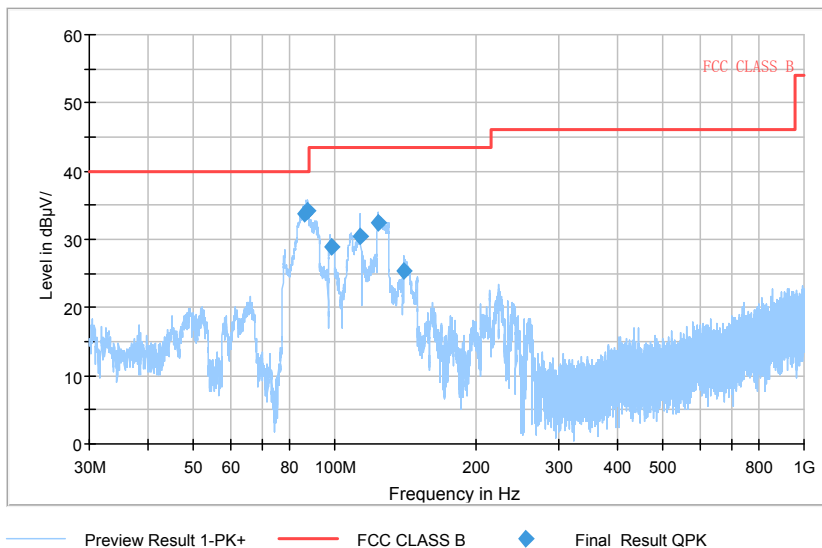

Comment

Frequency Range: 30MHz -1GHz
Detector: QP mode
Test Mode: 802.11a

Full Spectrum

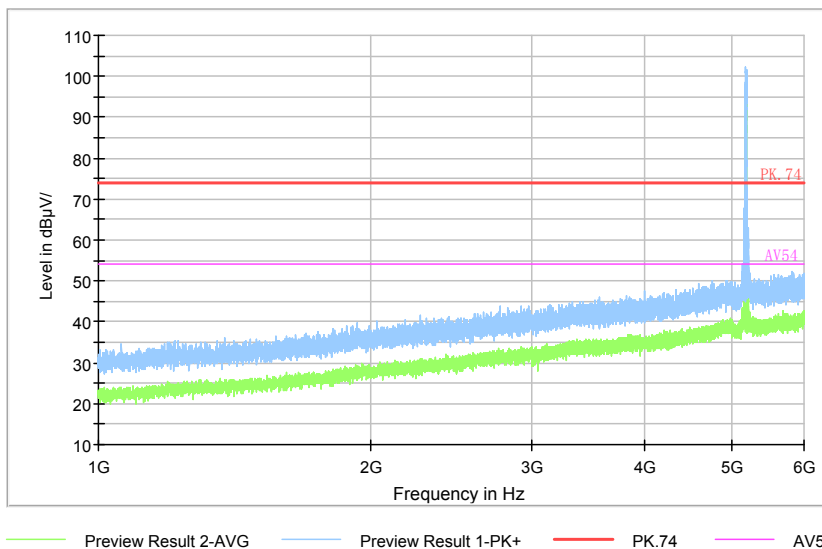

Comment

Frequency Range: 1GHz -6GHz
Detector: Av mode and PK mode
Modulation type: 802.11a

Full Spectrum

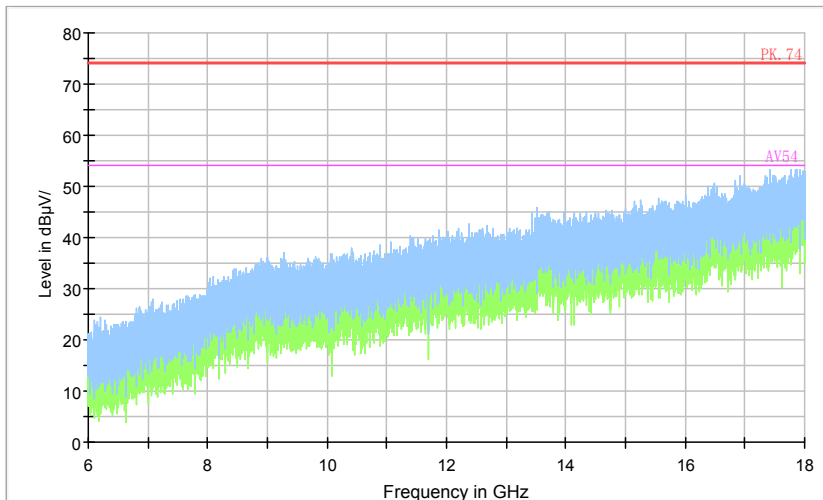

Preview Result 2-AVG Preview Result 1-PK+ PK.74 AV54

Comment

Frequency Range: 6GHz -18GHz
Detector: Av mode and PK mode
Modulation type: 802.11a

Full Spectrum

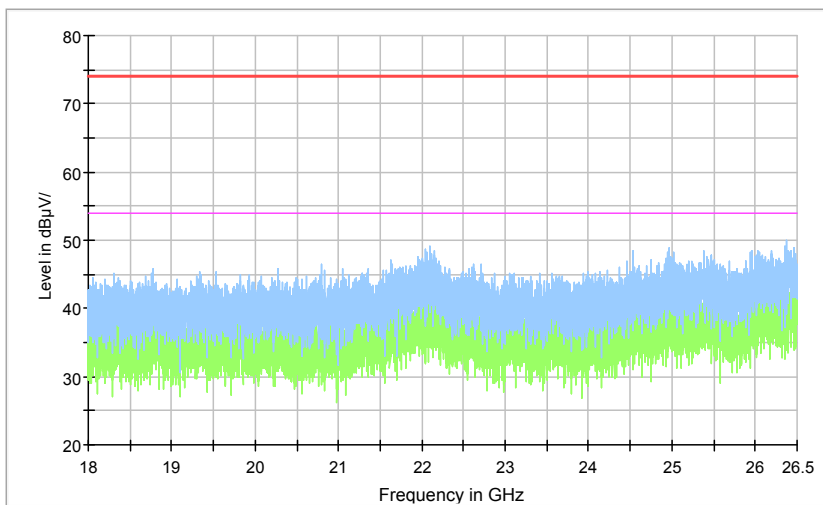

Preview Result 2-AVG Preview Result 1-PK+ PK70-74 AV50-54

Comment

Frequency Range: 18GHz -26.5GHz
Detector: Av mode and PK mode
Modulation type: 802.11a

Full Spectrum

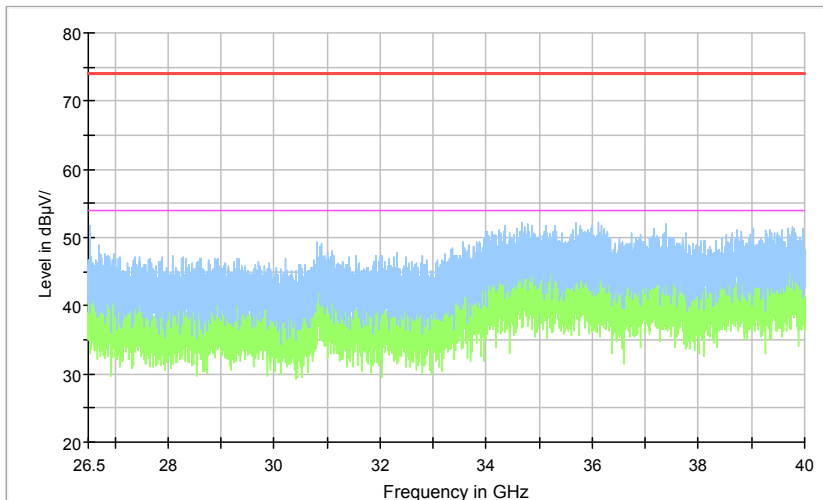

Preview Result 2-AVG Preview Result 1-PK+ PK70-74 AV50-54

Comment

Frequency Range: 26.5GHz -40GHz
Detector: Av mode and PK mode
Modulation type: 802.11a

Full Spectrum

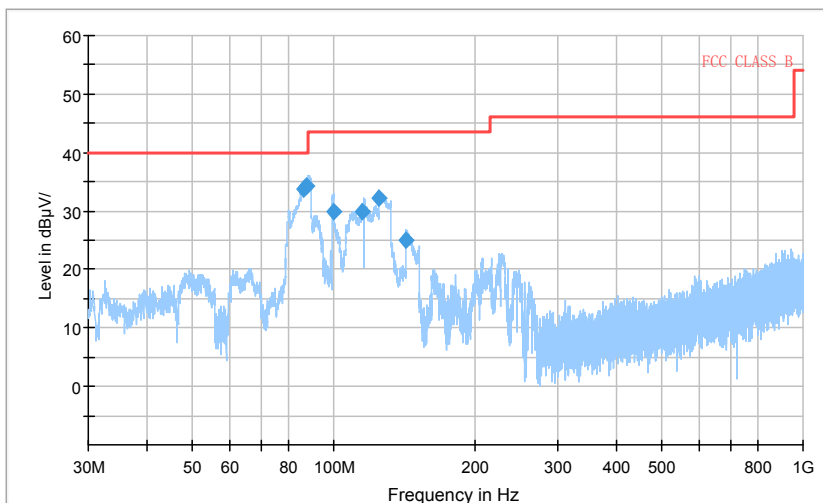

Preview Result 1-PK+ FCC CLASS B Final_Result QPK

Comment

Frequency Range: 30MHz -1GHz
Detector: QP mode
Test Mode: 802.11n (HT20 MIMO)

Full Spectrum

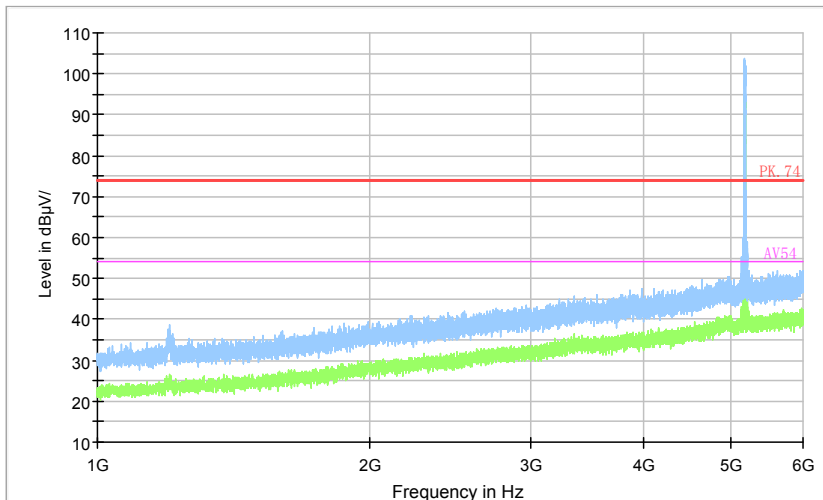

Preview Result 2-AVG Preview Result 1-PK+ PK.74 AV54

Comment

Frequency Range: 1GHz -6GHz
Detector: Av mode and PK mode
Modulation type: 802.11n (HT20 MIMO)

Full Spectrum

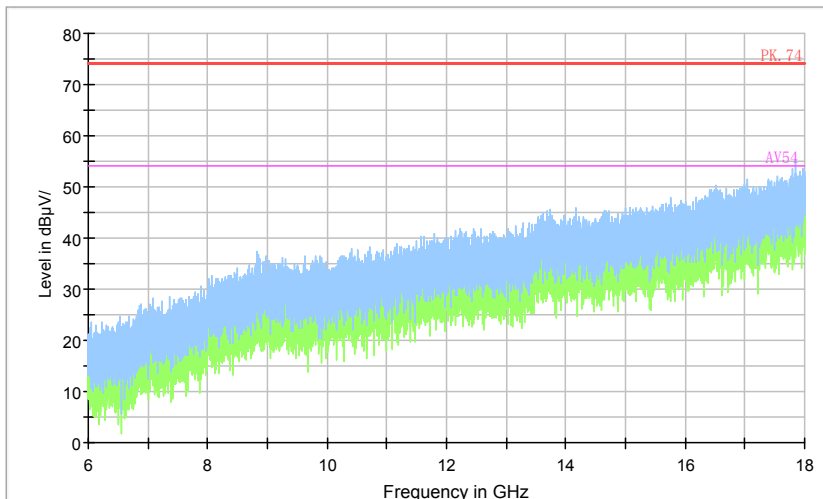

Preview Result 2-AVG Preview Result 1-PK+ PK.74 AV54

Comment

Frequency Range: 6GHz -18GHz
Detector: Av mode and PK mode
Modulation type: 802.11n (HT20 MIMO)

Full Spectrum

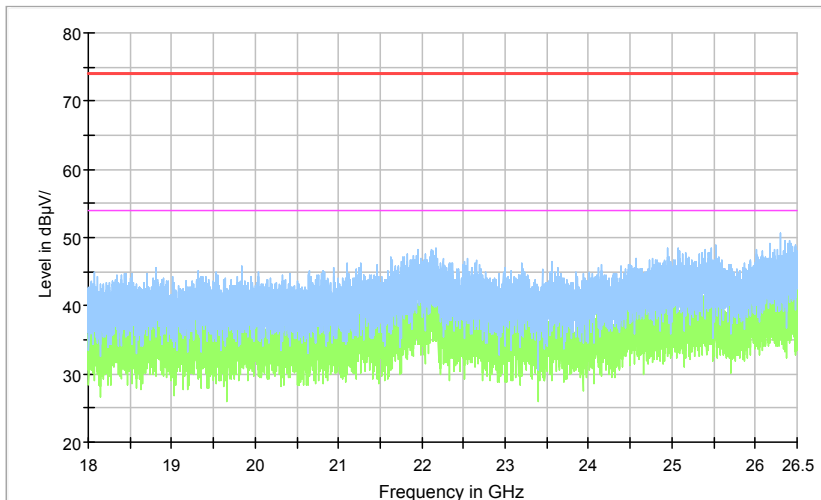

Preview Result 2-AVG Preview Result 1-PK+ PK70-74 AV50-54

Comment

Frequency Range: 18GHz -26.5GHz
Detector: Av mode and PK mode
Modulation type: 802.11n (HT20 MIMO)

Full Spectrum

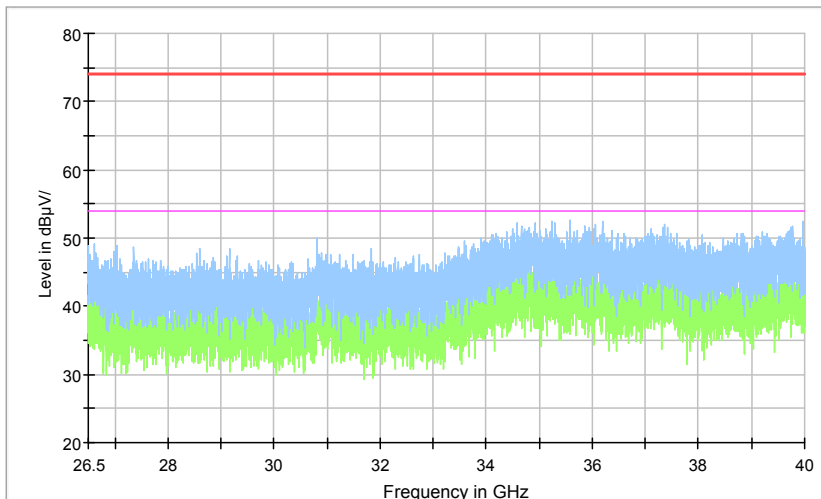

Preview Result 2-AVG Preview Result 1-PK+ PK70-74 AV50-54

Comment

Frequency Range: 26.5GHz -40GHz
Detector: Av mode and PK mode
Modulation type: 802.11n (HT20 MIMO)

Full Spectrum

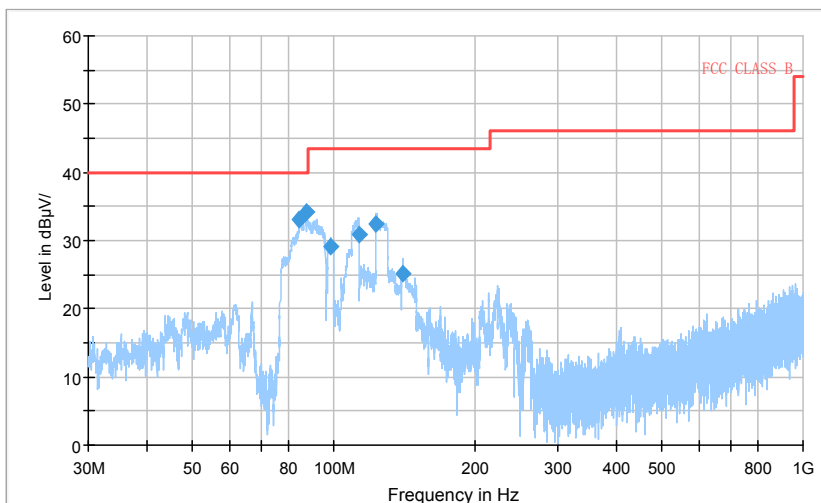

Preview Result 1-PK+ FCC CLASS B Final_Result QPK

Comment

Frequency Range: 30MHz -1GHz
Detector: QP mode
Test Mode: 802.11ac(VHT20 MIMO)

Full Spectrum

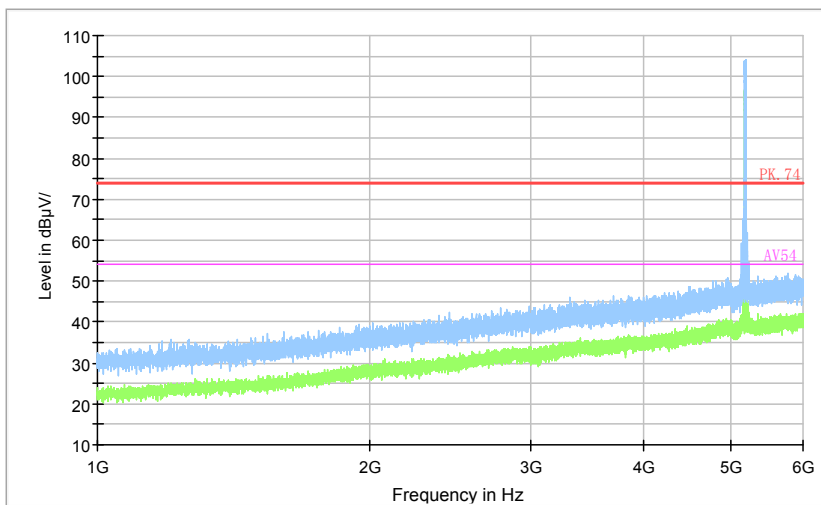

Preview Result 2-AVG Preview Result 1-PK+ PK.74 AV54

Comment

Frequency Range: 1GHz -6GHz
Detector: Av mode and PK mode
Modulation type: 802.11ac(VHT20 MIMO)

Full Spectrum

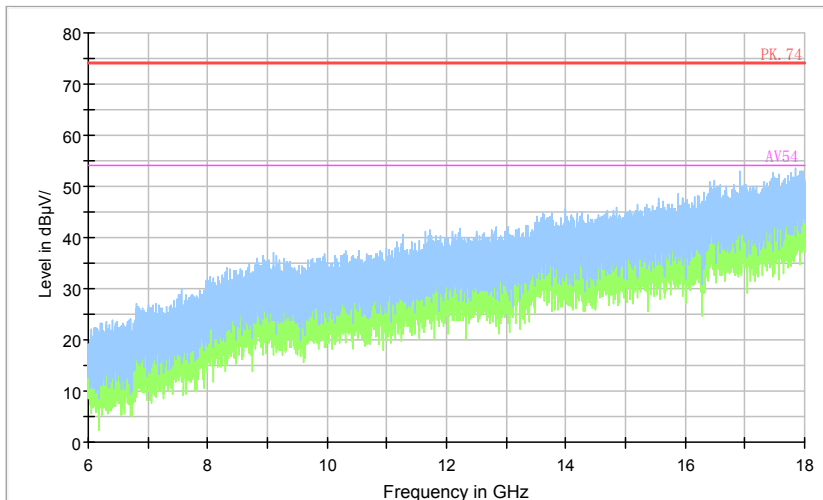

Preview Result 2-AVG Preview Result 1-PK+ PK.74 AV54

Comment

Frequency Range: 6GHz -18GHz
Detector: Av mode and PK mode
Modulation type: 802.11ac(VHT20 MIMO)

Full Spectrum

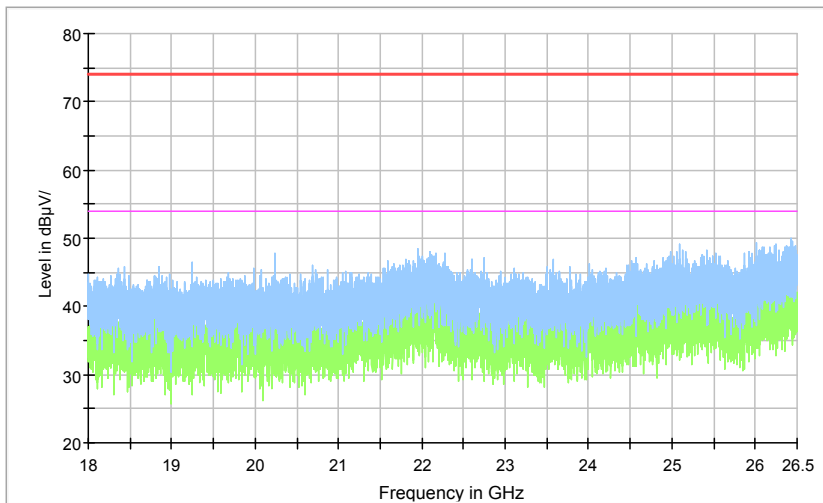

Preview Result 2-AVG Preview Result 1-PK+ PK70-74 AV50-54

Comment

Frequency Range: 18GHz -26.5GHz
Detector: Av mode and PK mode
Modulation type: 802.11ac(VHT20 MIMO)

Full Spectrum

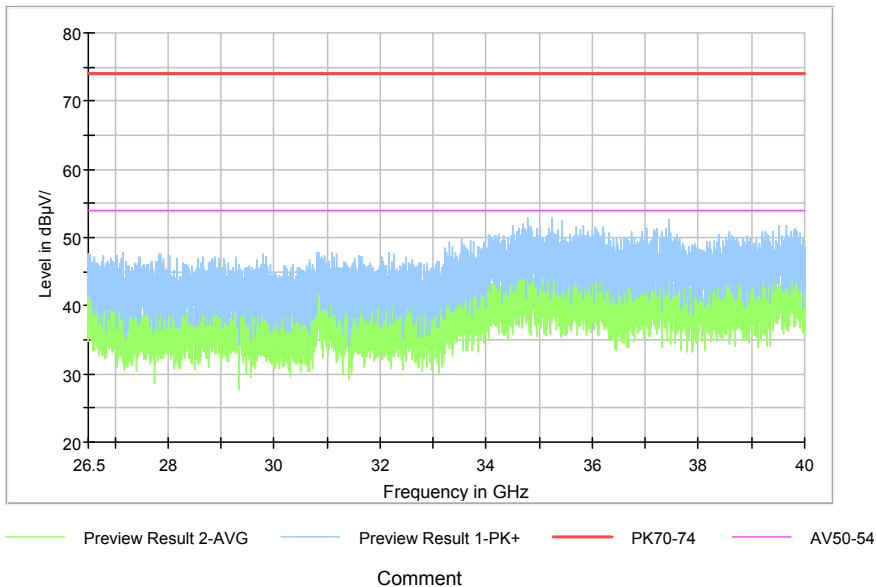

Frequency Range: 26.5GHz -40GHz
 Detector: Av mode and PK mode
 Modulation type: 802.11ac(VHT20 MIMO)

Carrier frequency (MHz): 5200
 Channel No.:40

Full Spectrum

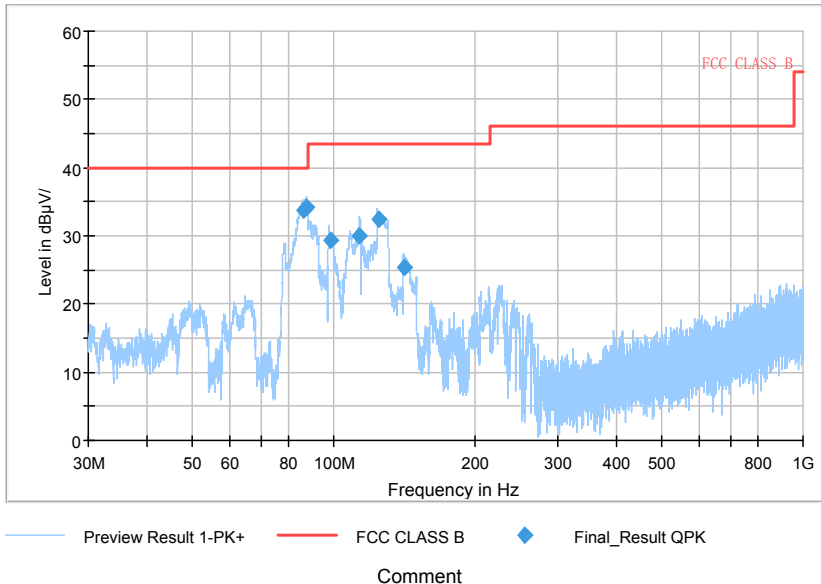

Frequency Range: 30MHz -1GHz
 Detector: QP mode
 Test Mode: 802.11a

Full Spectrum

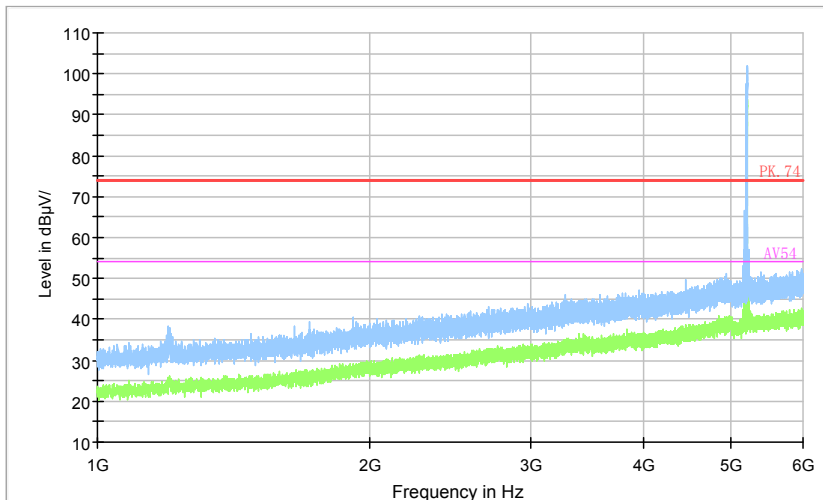

Preview Result 2-AVG Preview Result 1-PK+ PK.74 AV54

Comment

Frequency Range: 1GHz -6GHz
Detector: Av mode and PK mode
Modulation type: 802.11a

Full Spectrum

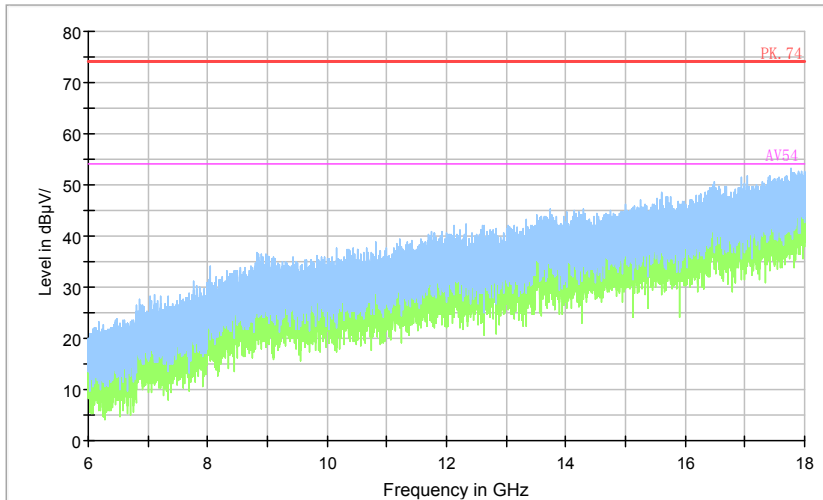

Preview Result 2-AVG Preview Result 1-PK+ PK.74 AV54

Comment

Frequency Range: 6GHz -18GHz
Detector: Av mode and PK mode
Modulation type: 802.11a

Full Spectrum

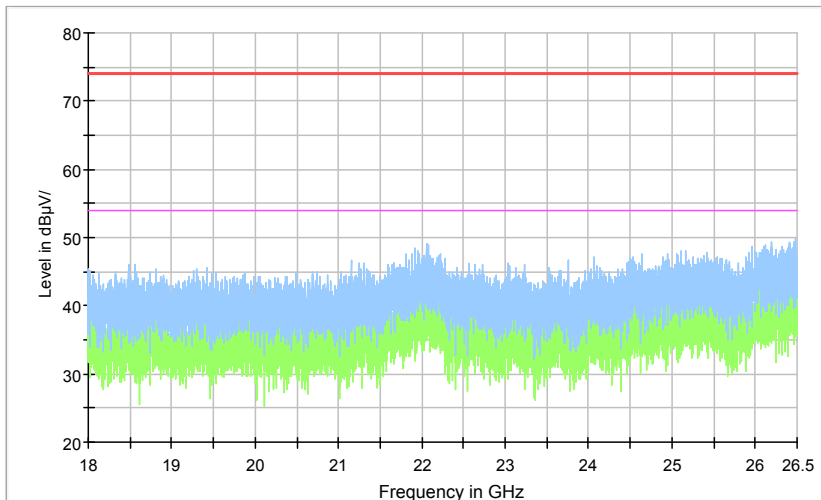

Preview Result 2-AVG Preview Result 1-PK+ PK70-74 AV50-54

Comment

Frequency Range: 18GHz -26.5GHz
Detector: Av mode and PK mode
Modulation type: 802.11a

Full Spectrum

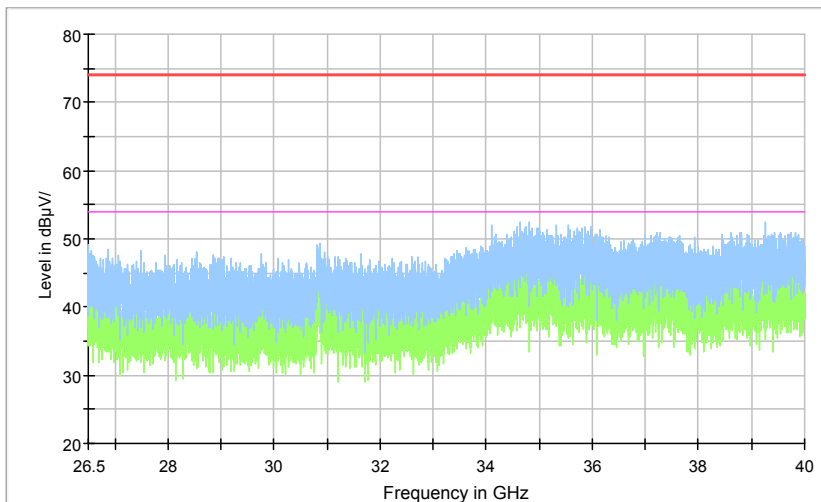

Preview Result 2-AVG Preview Result 1-PK+ PK70-74 AV50-54

Comment

Frequency Range: 26.5GHz -40GHz
Detector: Av mode and PK mode
Modulation type: 802.11a

Full Spectrum

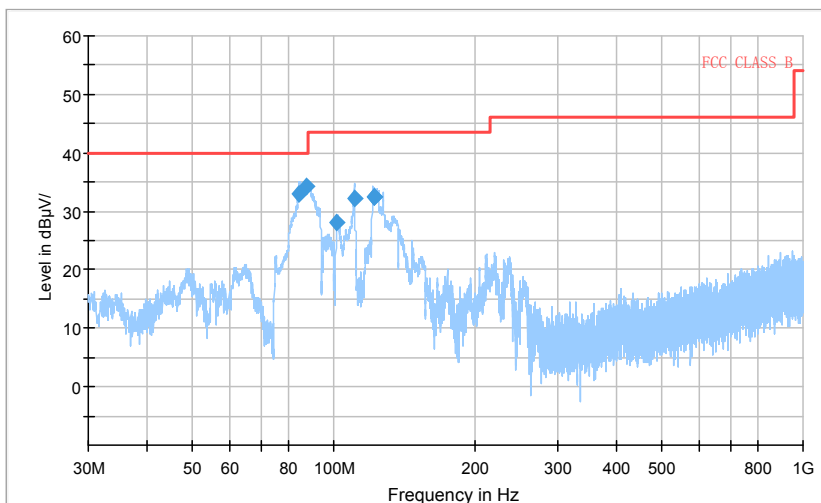

Preview Result 1-PK+ FCC CLASS B Final_Result QPK

Comment

Frequency Range: 30MHz -1GHz
Detector: QP mode
Test Mode: 802.11n (HT20 MIMO)

Full Spectrum

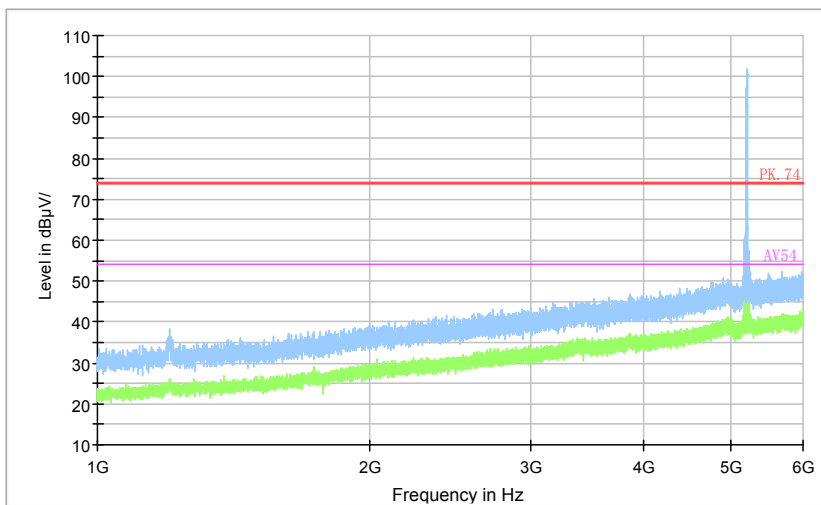

Preview Result 2-AVG Preview Result 1-PK+ PK.74 AV54

Comment

Frequency Range: 1GHz -6GHz
Detector: Av mode and PK mode
Modulation type: 802.11n(HT20 MIMO)

Full Spectrum

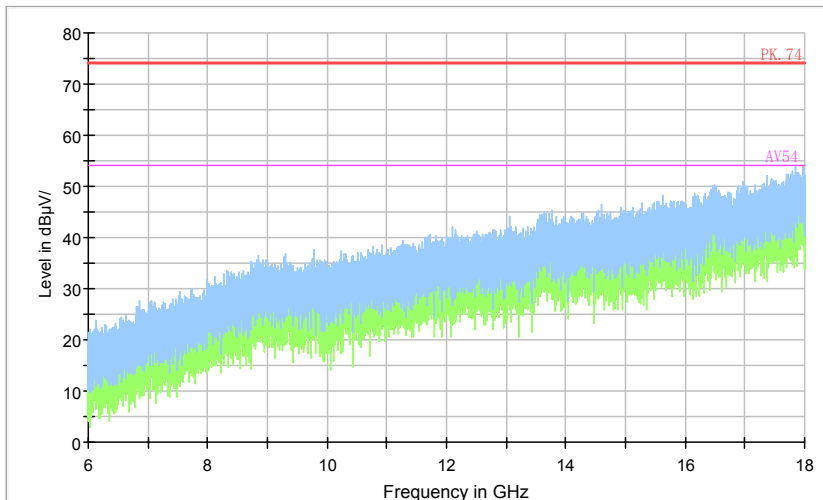

Preview Result 2-AVG Preview Result 1-PK+ PK.74 AV54

Comment

Frequency Range: 6GHz -18GHz
Detector: Av mode and PK mode
Modulation type: 802.11n(HT20 MIMO)

Full Spectrum

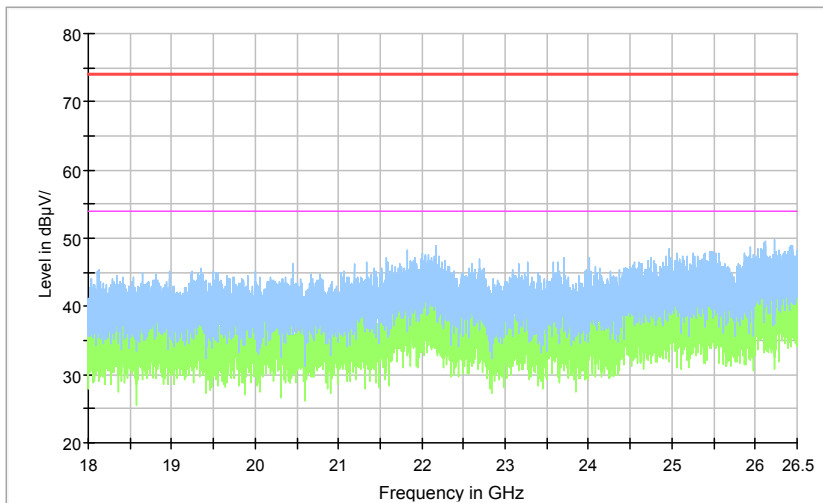

Preview Result 2-AVG Preview Result 1-PK+ PK70-74 AV50-54

Comment

Frequency Range: 18GHz -26.5GHz
Detector: Av mode and PK mode
Modulation type: 802.11n(HT20 MIMO)

Full Spectrum

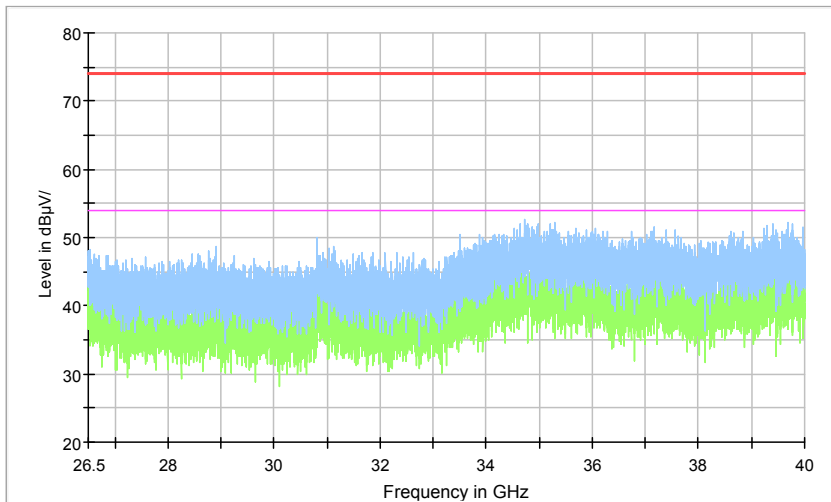

Preview Result 2-AVG Preview Result 1-PK+ PK70-74 AV50-54

Comment

Frequency Range: 26.5GHz -40GHz
Detector: Av mode and PK mode
Modulation type: 802.11n(HT20 MIMO)

Full Spectrum

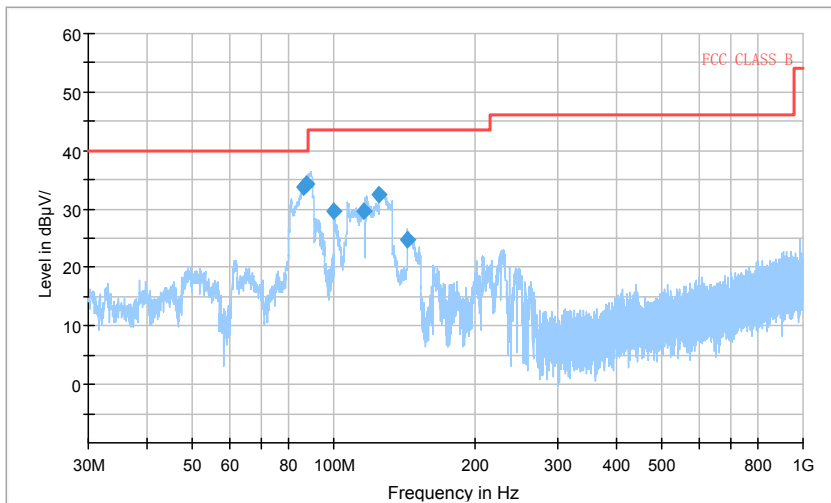

Preview Result 1-PK+ FCC CLASS B Final_Result QPK

Comment

Frequency Range: 30MHz -1GHz
Detector: QP mode
Test Mode: 802.11ac(VHT20 MIMO)

Full Spectrum

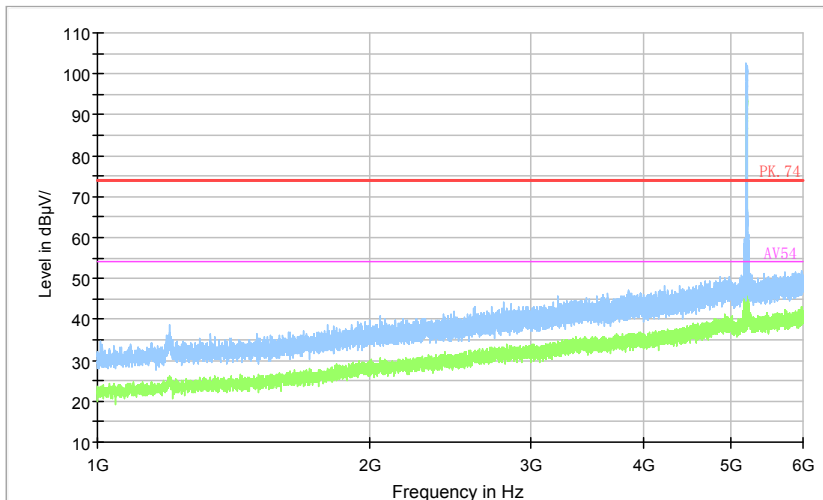

Preview Result 2-AVG Preview Result 1-PK+ PK.74 AV54

Comment

Frequency Range: 1GHz -6GHz
 Detector: Av mode and PK mode
 Modulation type: 802.11ac(VHT20 MIMO)

Full Spectrum

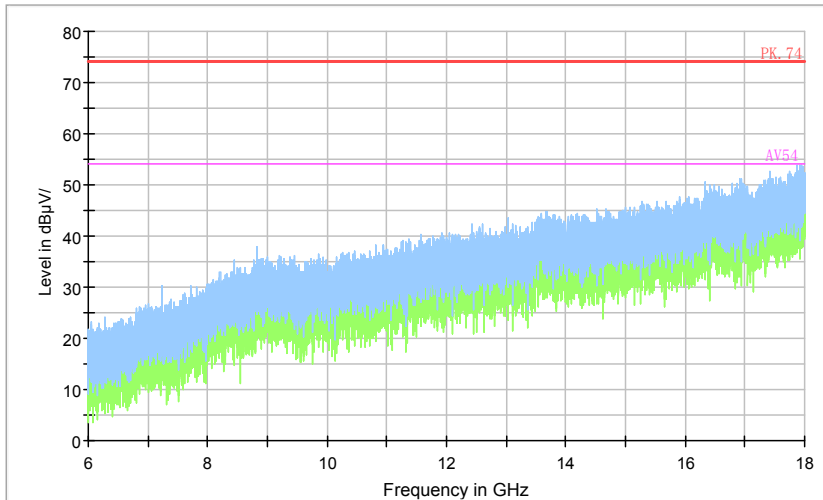

Preview Result 2-AVG Preview Result 1-PK+ PK.74 AV54

Comment

Frequency Range: 6GHz -18GHz
 Detector: Av mode and PK mode
 Modulation type: 802.11ac(VHT20 MIMO)

Full Spectrum

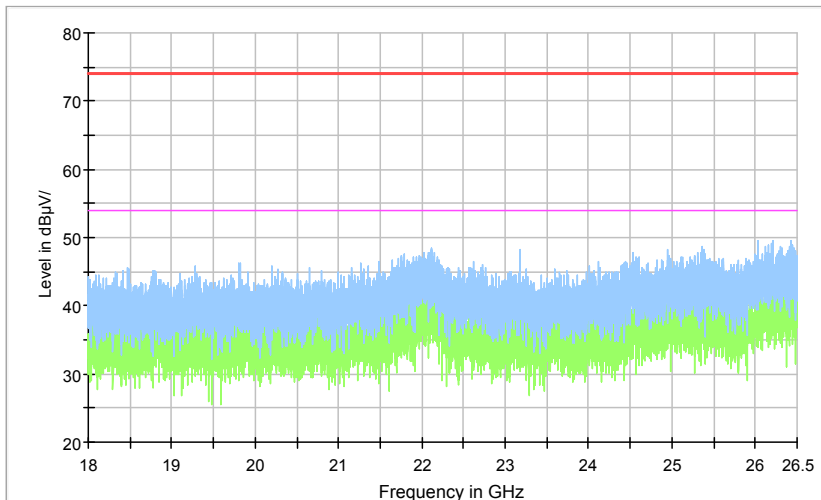

Preview Result 2-AVG Preview Result 1-PK+ PK70-74 AV50-54

Comment

Frequency Range: 18GHz -26.5GHz
Detector: Av mode and PK mode
Modulation type: 802.11ac(VHT20 MIMO)

Full Spectrum

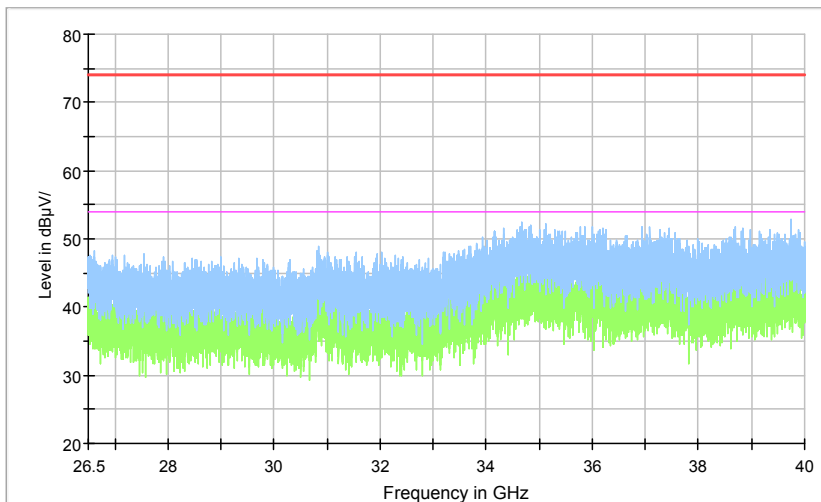

Preview Result 2-AVG Preview Result 1-PK+ PK70-74 AV50-54

Comment

Frequency Range: 26.5GHz -40GHz
Detector: Av mode and PK mode
Modulation type: 802.11ac(VHT20 MIMO)

Carrier frequency (MHz): 5240
 Channel No.:48

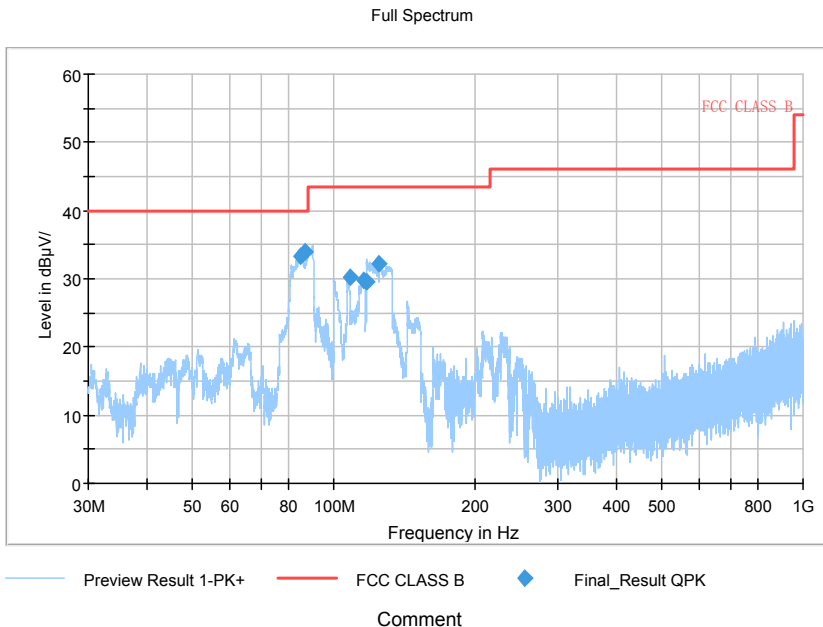

Frequency Range: 30MHz -1GHz
 Detector: QP mode
 Test Mode: 802.11a

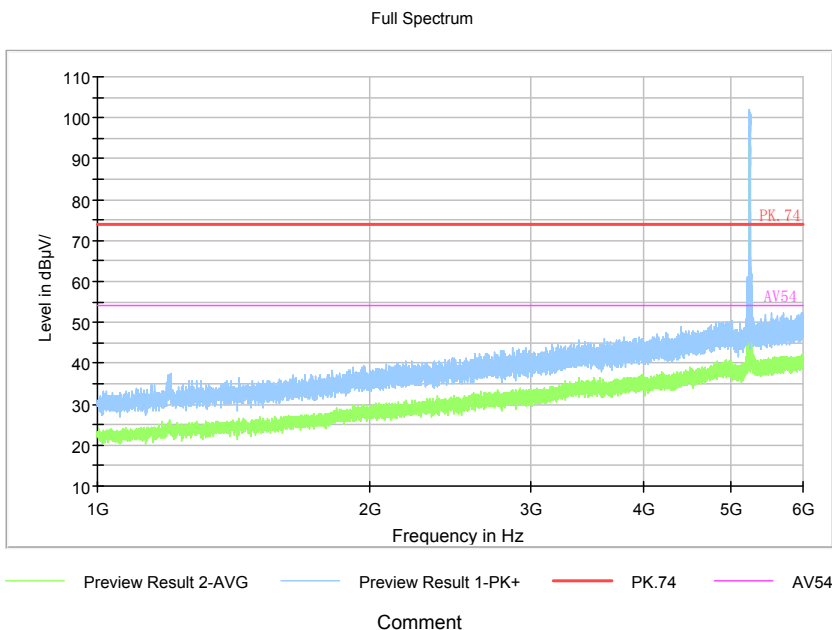

Frequency Range: 1GHz -6GHz
 Detector: Av mode and PK mode
 Modulation type: 802.11a

Full Spectrum

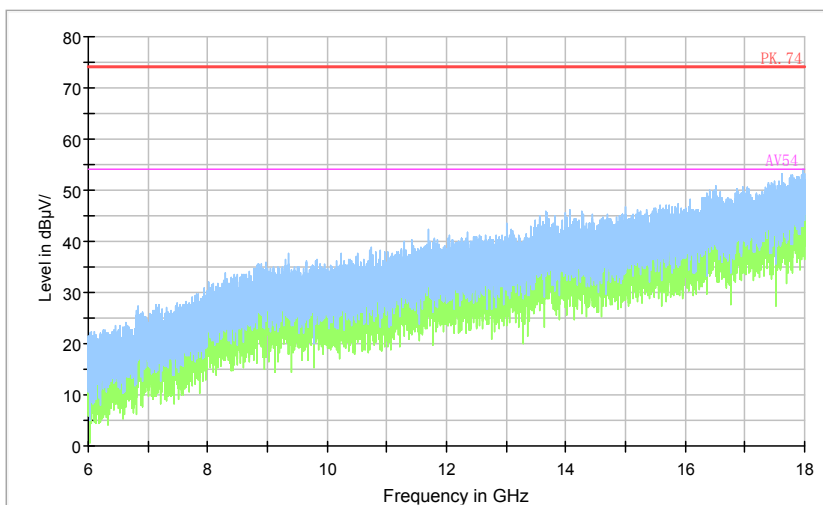

Preview Result 2-AVG Preview Result 1-PK+ PK.74 AV54

Comment

Frequency Range: 6GHz -18GHz
Detector: Av mode and PK mode
Modulation type: 802.11a

Full Spectrum

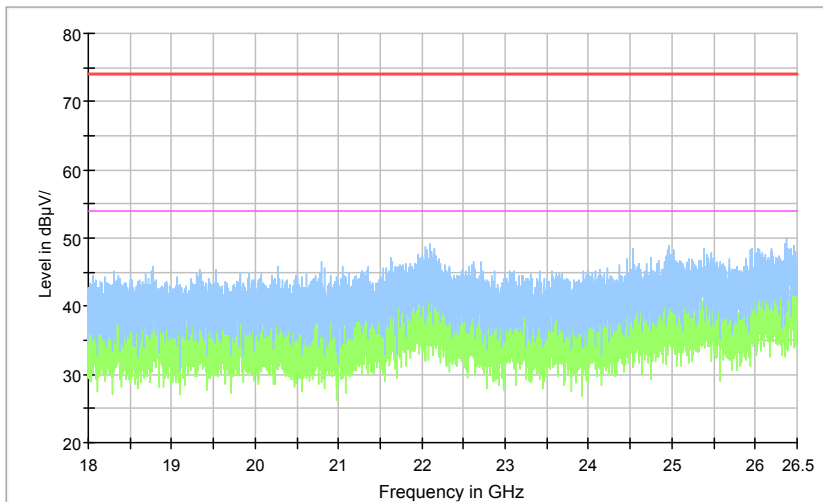

Preview Result 2-AVG Preview Result 1-PK+ PK70-74 AV50-54

Comment

Frequency Range: 18GHz -26.5GHz
Detector: Av mode and PK mode
Modulation type: 802.11a

Full Spectrum

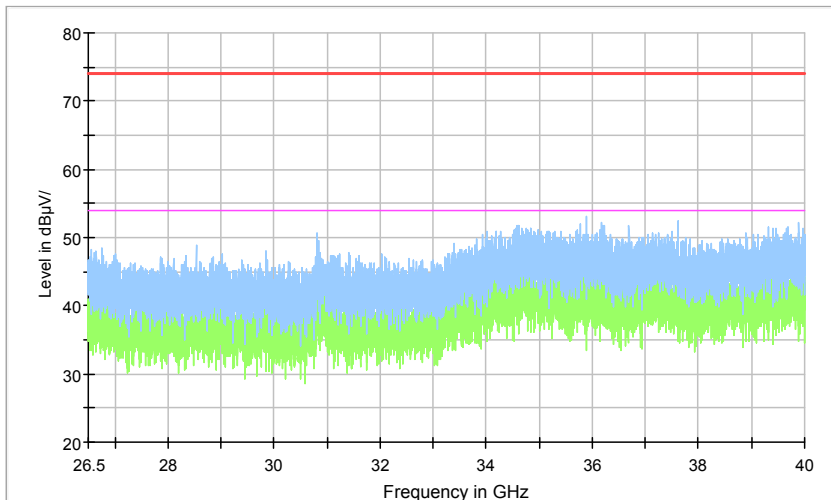

Preview Result 2-AVG Preview Result 1-PK+ PK70-74 AV50-54

Comment

Frequency Range: 26.5GHz -40GHz
Detector: Av mode and PK mode
Modulation type: 802.11a

Full Spectrum

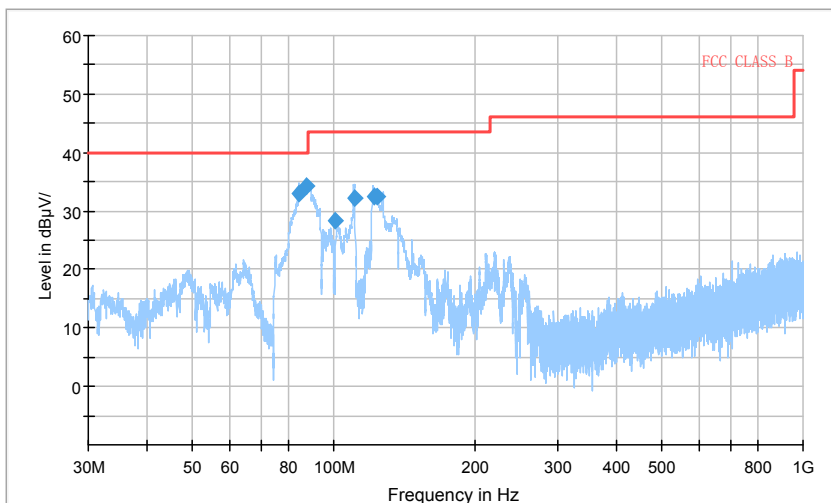

Preview Result 1-PK+ FCC CLASS B Final_Result QPK

Comment

Frequency Range: 30MHz -1GHz
Detector: QP mode
Test Mode: 802.11n(HT20 MIMO)

Full Spectrum

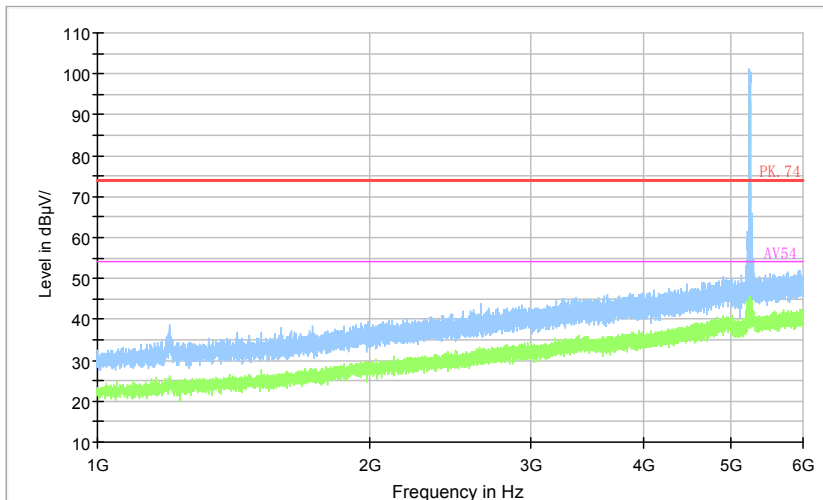

Preview Result 2-AVG Preview Result 1-PK+ PK.74 AV54

Comment

Frequency Range: 1GHz -6GHz
Detector: Av mode and PK mode
Modulation type: 802.11n(HT20 MIMO)

Full Spectrum

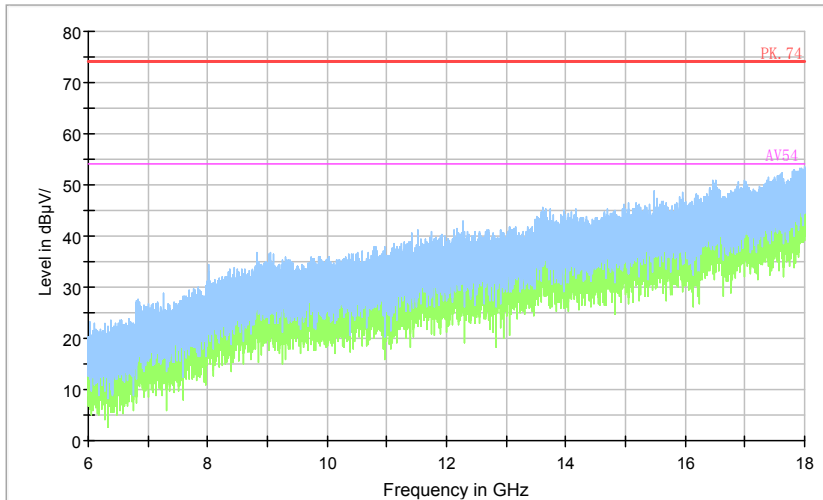

Preview Result 2-AVG Preview Result 1-PK+ PK.74 AV54

Comment

Frequency Range: 6GHz -18GHz
Detector: Av mode and PK mode
Modulation type: 802.11n(HT20 MIMO)

Full Spectrum

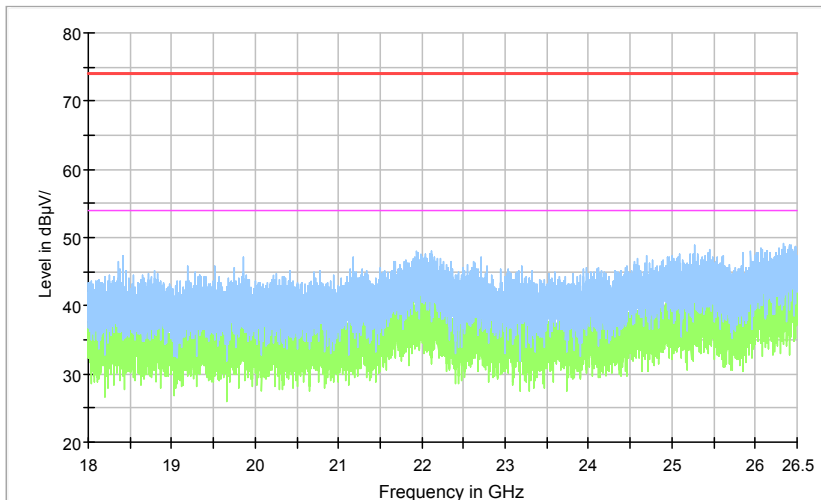

Preview Result 2-AVG Preview Result 1-PK+ PK70-74 AV50-54

Comment

Frequency Range: 18GHz -26.5GHz
Detector: Av mode and PK mode
Modulation type: 802.11n(HT20 MIMO)

Full Spectrum

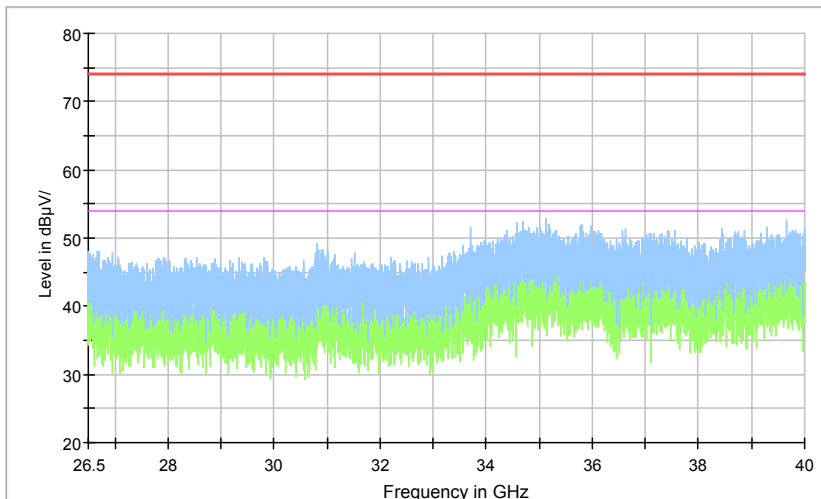

Preview Result 2-AVG Preview Result 1-PK+ PK70-74 AV50-54

Comment

Frequency Range: 26.5GHz -40GHz
Detector: Av mode and PK mode
Modulation type: 802.11n(HT20 MIMO)

Full Spectrum

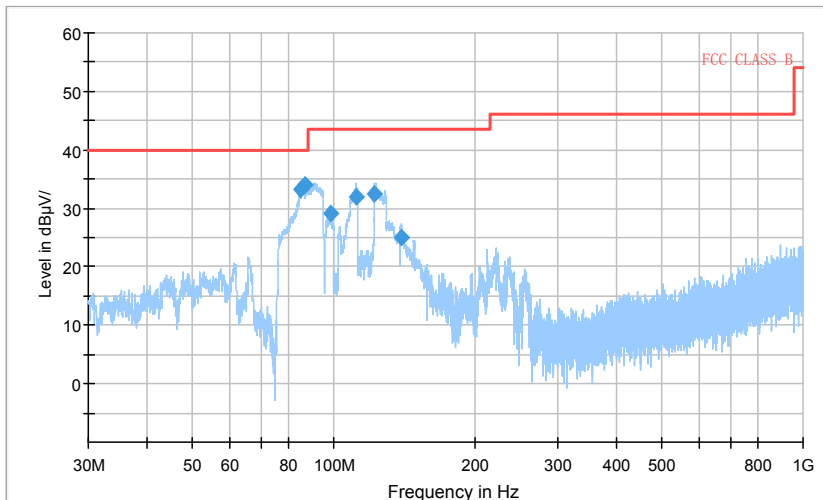

Preview Result 1-PK+ FCC CLASS B Final_Result QPK

Comment

Frequency Range: 30MHz -1GHz
Detector: QP mode
Test Mode: 802.11ac(VHT20 MIMO)

Full Spectrum

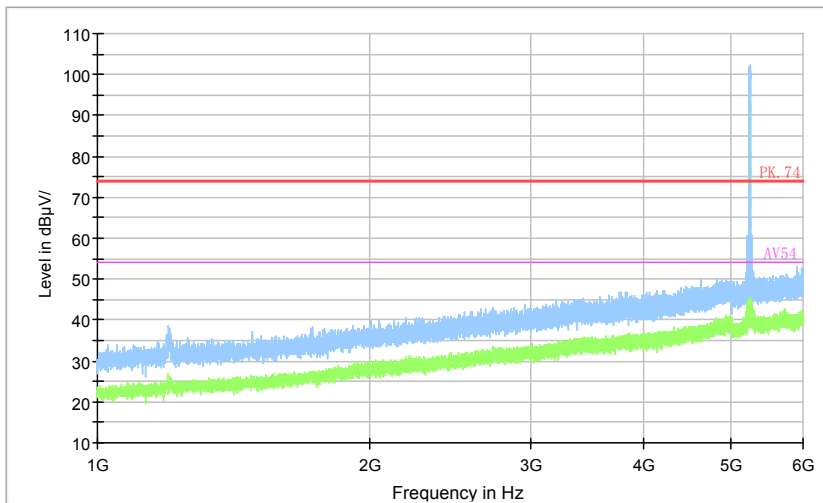

Preview Result 2-AVG Preview Result 1-PK+ PK.74 AV54

Comment

Frequency Range: 1GHz -6GHz
Detector: Av mode and PK mode
Modulation type: 802.11ac(VHT20 MIMO)

Full Spectrum

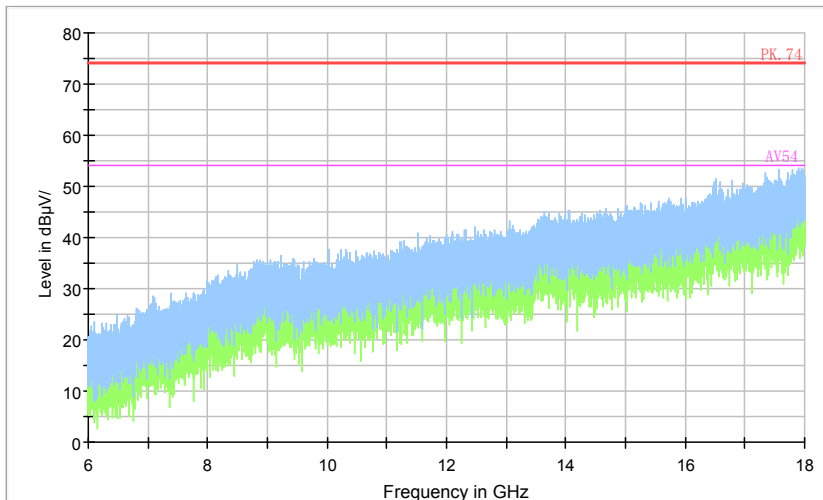

Preview Result 2-AVG Preview Result 1-PK+ PK.74 AV54

Comment

Frequency Range: 6GHz -18GHz
Detector: Av mode and PK mode
Modulation type: 802.11ac(VHT20 MIMO)

Full Spectrum

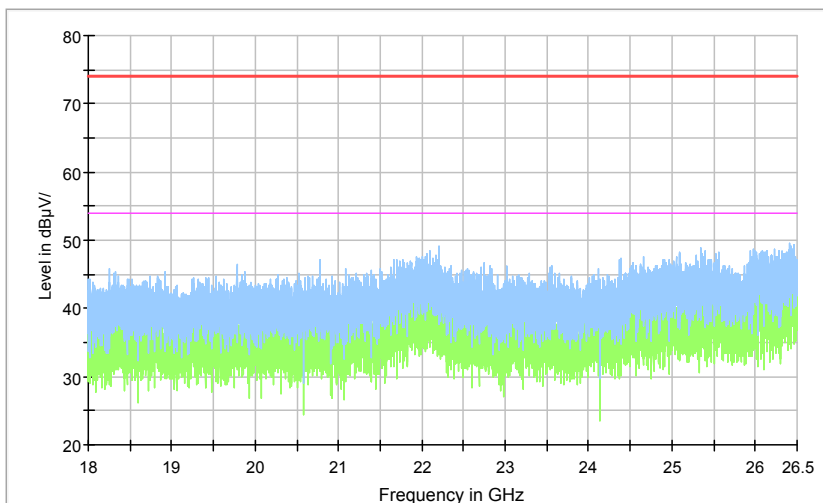

Preview Result 2-AVG Preview Result 1-PK+ PK70-74 AV50-54

Comment

Frequency Range: 18GHz -26.5GHz
Detector: Av mode and PK mode
Modulation type: 802.11ac(VHT20 MIMO)

Full Spectrum

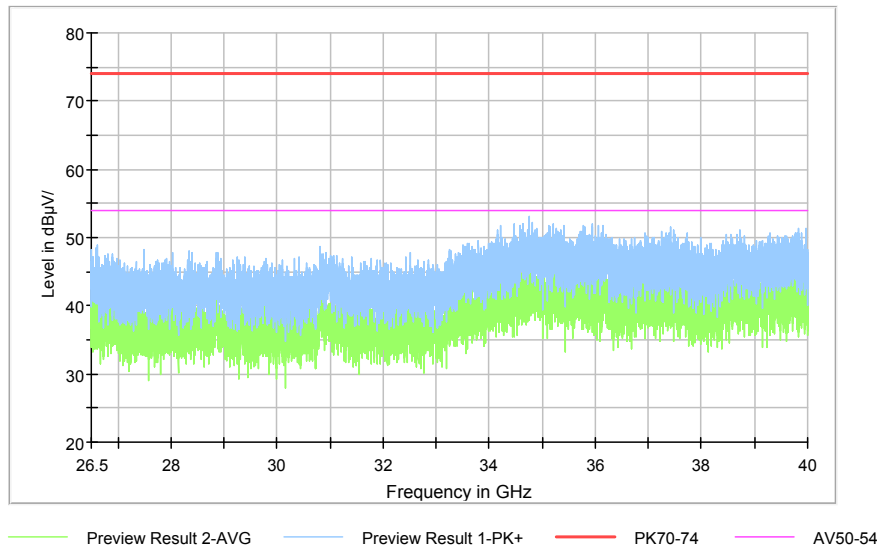

Comment

Frequency Range: 26.5GHz -40GHz
Detector: Av mode and PK mode
Modulation type: 802.11ac(VHT20 MIMO)

AC Power line Conducted Emission(EUT on (11a) + Charging)

A "reference path loss" Corr.(dB) is established and the $L_{cable}+ATT+VDF$ is the attenuation of "reference path loss", and including the cable loss, the attenuation of the attenuator, the voltage division factor of AMN.

The measurement results are obtained as described below:

$$P_{result}=P_{mea}+ Corr.(dB)$$

Sample calculation: $(36.73 \text{ dB}\mu\text{V}) = (6.73 \text{ dB}\mu\text{V}) + (30.0 \text{ dB})$, the corresponding frequency is 0.358045MHz.

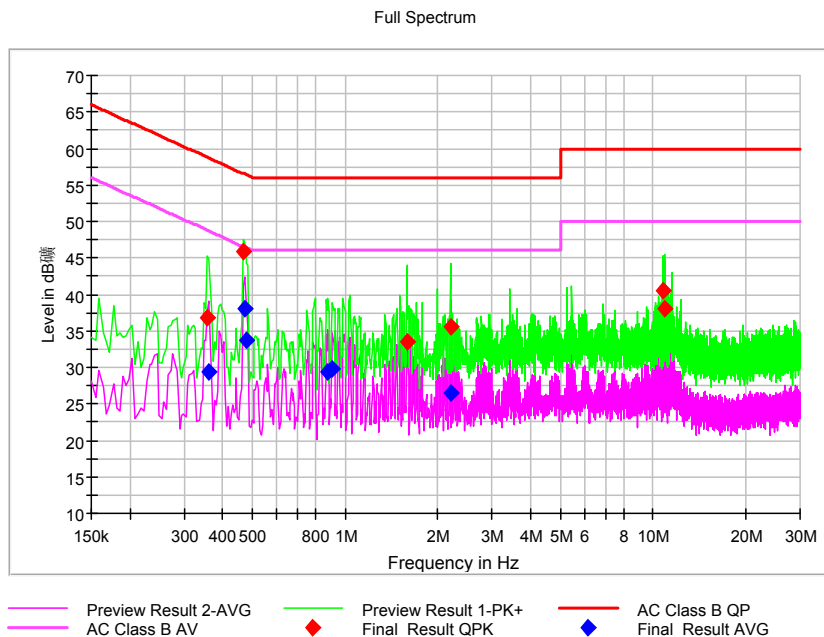

MEASUREMENT RESULT:

Frequency (MHz)	QuasiPeak (dBμV)	Average (dBμV)	Limit (dBμV)	Marg in (dB)	Line	Corr. (dB)	Pmea QuasiPeak (dBμV)	Pmea Average (dBμV)
0.358045	36.73	---	58.77	22.04	L	30.0	6.73	---
0.362568	---	29.34	48.67	19.33	L	30.0	---	-0.66
0.466591	45.88	---	56.57	10.69	L	30.0	15.88	---
0.471114	---	38.04	46.49	8.45	L	30.0	---	8.04
0.480159	---	33.74	46.34	12.60	L	30.0	---	3.74
0.878159	---	29.39	46.00	16.61	L	29.9	---	-0.51
0.909818	---	29.82	46.00	16.18	L	29.9	---	-0.08
1.583705	33.51	---	56.00	22.49	N	29.9	3.61	---
2.194273	35.54	---	56.00	20.46	L	29.9	5.64	---
2.194273	---	26.56	46.00	19.44	L	29.9	---	-3.34
10.755795	40.42	---	60.00	19.58	L	29.9	10.52	---
10.954795	38.02	---	60.00	21.98	L	29.9	8.12	---

---End of Test Report---