



RF TEST REPORT

Report No.: SET2020-05445

Product Name: WCDMA/GSM(GPRS) Multi-Mode Digital Mobile Phone

FCC ID: SRQ-ZTEL210

Model No. : ZTE Blade L210

Marketing Name: ZTE BLADE L210, ZTE Blade L210, ZTE blade L210

Applicant: ZTE Corporation.

Address: ZTE Plaza, Keji Road South, Shenzhen, China.

Dates of Testing: 05/10/2020 — 05/28/2020

Issued by: CCIC Southern Testing Co., Ltd.

Lab Location: Electronic Testing Building, No. 43 Shahe Road, Xili Street, Nanshan District, Shenzhen, Guangdong, China.

Tel: 86 755 26627338 **Fax:** 86 755 26627238

This test report consists of 74 pages in total. It may be duplicated completely for legal use with the approval of the applicant. It should not be reproduced except in full, without the written approval of our laboratory. The client should not use it to claim product endorsement by CCIC-SET. The test results in the report only apply to the tested sample. The test report shall be invalid without all the signatures of testing engineers, reviewer and approver. Any objections must be raised to CCIC-SET within 15 days since the date when the report is received. It will not be taken into consideration beyond this limit.



Test Report

Product.....: WCDMA/GSM(GPRS) Multi-Mode Digital Mobile Phone

Brand Name.....: ZTE

Trade Name.....: ZTE

Applicant.....: ZTE Corporation.

Applicant Address.....: ZTE Plaza, Keji Road South, Shenzhen, China

Manufacturer.....: ZTE Corporation.

Manufacturer Address....: ZTE Plaza, Keji Road South, Shenzhen, China

Test Standards.....: 47 CFR FCC Part 2/22/24/27

Test Result.....: PASS

Tested by.....: Vincent 2020.05.28
Vincent, Test Engineer

Reviewed by.....: Chris You 2020.05.28
Chris You, Senior Engineer

Approved by.....: Shuangwen Zhang 2020.05.28
Shuangwen Zhang, Manager



Table of Contents

1.	GENERAL INFORMATION	5
1.1	EUT Description	5
1.2	Maximum ERP/EIRP Power, Frequency Tolerance, and Emission Designator	6
1.3	Test Standards and Results	7
1.4	Test Configuration of Equipment under Test.....	8
1.5	Measurement Results Explanation Example	8
1.6	Facilities and Accreditations	9
2.	47 CFR PART 2, PART 22H & 24E 27L REQUIREMENTS.....	10
2.1	Conducted RF Output Power	10
2.2	Peak to Average Ratio.....	13
2.3	99% Occupied Bandwidth and 26dB Bandwidth Measurement	15
2.4	Frequency Stability	24
2.5	Conducted Out of Band Emissions	28
2.6	Bandedge	51
2.7	Transmitter Radiated Power (EIRP/ERP)	59
2.8	Radiated Spurious Emissions	64
3.	LIST OF MEASURING EQUIPMENT	73
4.	UNCERTAINTY OF EVALUATION	74



Change History		
Issue	Date	Reason for change
1.0	2020.05.28	First edition



1. GENERAL INFORMATION

1.1 EUT Description

EUT Type	WCDMA/GSM(GPRS) Multi-Mode Digital Mobile Phone
Hardware Version	urvA
Software Version	TEL_MX_ZTE_Blade_L210V1.0
EUT supports Radios application	GPRS/EDGE/WCDMA/HSPA
Multi Slot Class	GPRS: Multi slot Class12, EGPRS: Multi slot Class12
Frequency Range	<p>GSM 850MHz: Tx: 824.2 - 848.8MHz (at intervals of 200kHz); Rx: 869.2 - 893.8MHz (at intervals of 200kHz)</p> <p>GSM 1900MHz: Tx: 1850.2 - 1909.8MHz (at intervals of 200kHz); Rx: 1930.2 - 1989.8MHz (at intervals of 200kHz)</p> <p>WCDMA 850MHz Tx: 826.4 - 846.6MHz (at intervals of 200kHz); Rx: 871.4 - 891.6MHz (at intervals of 200kHz)</p> <p>WCDMA 1900MHz Tx: 1852.4 - 1907.6MHz (at intervals of 200kHz); Rx: 1932.4 - 1987.6MHz (at intervals of 200kHz)</p> <p>WCDMA 1700MHz Tx: 1712.4 - 1752.6MHz (at intervals of 200kHz); Rx: 2112.4 - 2152.6MHz (at intervals of 200kHz)</p>
Maximum Output Power to Antenna	<p>GSM 850: 32.53dBm GSM 1900: 30.42dBm EDGE 850: 26.51dBm EDGE 1900: 25.82dBm WCDMA 850: 22.76dBm WCDMA 1900: 23.25dBm WCDMA 1700: 23.58dBm</p>
Type of Modulation	<p>GSM / GPRS:GMSK EDGE:GMSK / 8PSK WCDMA: QPSK(Uplink) HSDPA:QPSK(Downlink) HSUPA:QPSK(Uplink)</p>
Antenna Type	Internal Antenna

**1.2 Maximum ERP/EIRP Power, Frequency Tolerance, and Emission Designator**

System	Type of Modulation	Emission Designator	Frequency Tolerance (ppm)	Maximum ERP/EIRP(W)
GSM 850	GMSK	247KGXW	0.0042	1.618
GSM 1900	GMSK	246KGXW	0.0035	0.920
EDGE 850	8PSK	239KG7W	0.0046	0.542
EDGE 1900	8PSK	246KG7W	0.0037	0.342
WCDMA 850 RMC 12.2Kbps	QPSK	4M16F9W	0.0052	0.171
WCDMA 1900 RMC 12.2Kbps	QPSK	4M16F9W	0.0058	0.167
WCDMA 1700 RMC 12.2Kbps	QPSK	4M16F9W	0.0063	0.194



1.3 Test Standards and Results

1. 47 CFR Part 2, 22(H), 24(E), 27(L)
2. ANSI / TIA / EIA-603-D-2010
3. FCC KDB 971168 D01 Power Meas. License Digital Systems v03r01

Remark:

1. All test items were verified and recorded according to the standards and without any deviation during the test.
2. This EUT has also been tested and complied with the requirements of FCC Part 15, Subpart B, recorded in a separate test report.

Test detailed items/section required by FCC rules and results are as below:

No.	Section	Description	Limit	Result
	FCC			
1	2.1046	Conducted Output Power	Reporting Only	PASS
2	24.232(d) 27.50(d)	Peak to Average Ratio	< 13dBm	PASS
3	2.1049 22.917(b) 24.238(b) 27.53(g)	Occupied Bandwidth	Reporting Only	PASS
4	2.1055 22.355 24.235 27.54	Frequency Stability	$\leq \pm 2.5\text{ppm}$	PASS
5	2.1051 22.917 24.238 27.53	Conducted Out of Band Emissions	$< 43+10\log_{10}$ (P[Watts])	PASS
6	2.1051 22.917 24.238 27.53	Band Edge	$< 43+10\log_{10}$ (P[Watts])	PASS
7	22.913	Effective Radiated Power	< 7Watts	PASS
	24.232	Equivalent Isotropic Radiated Power	< 2Watts	PASS
	27.50(d)	Effective Radiated Power	< 1Watts	PASS
8	2.1053 22.917 24.238 27.53	Radiated Spurious Emissions	$< 43+10\log_{10}$ (P[Watts])	PASS

1.4 Test Configuration of Equipment under Test

Antenna port conducted and radiated test items were performed according to KDB 971168 D01 Power Meas. License Digital Systems v03r01 with maximum output power.

Radiated measurements were performed with rotating EUT in different three orthogonal test planes to find the maximum emission.

Radiated emissions were investigated as following frequency range:

1. 30 MHz to 9000 MHz for GSM850 and WCDMA Band V.
2. 30 MHz to 20000 MHz for GSM1900 and WCDMA Band II.
3. 30 MHz to 18000 MHz for WCDMA Band IV.

All modes and data rates and positions were investigated.

Test modes are chosen to be reported as the worst case configuration below:

Test Modes		
Band	Radiated TCs	Conducted TCs
GSM 850	GPRS Link	GPRS Link
	GPRS Link	GPRS Link
GSM 1900	GPRS Link	GPRS Link
	GPRS Link	GPRS Link
WCDMA Band V	RMC 12.2Kbps Link	RMC 12.2Kbps Link
WCDMA Band II	RMC 12.2Kbps Link	RMC 12.2Kbps Link
WCDMA Band IV	RMC 12.2Kbps Link	RMC 12.2Kbps Link

Note: The maximum power levels are chosen to test as the worst case configuration as follows:

GPRS mode for GMSK modulation,

EDGE multi-slot class 8 mode for 8PSK modulation,

RMC 12.2Kbps mode for WCDMA band V,

RMC 12.2Kbps mode for WCDMA band II,

RMC 12.2Kbps mode for WCDMA band IV, only these modes were used for all tests.

1.5 Measurement Results Explanation Example

For all conducted test items:

The offset level is set in the spectrum analyzer to compensate the RF cable loss and attenuator factor between EUT conducted output port and spectrum analyzer. With the offset compensation, the spectrum analyzer reading level is exactly the EUT RF output level.

The spectrum analyzer offset is derived from RF cable loss and attenuator factor.

Offset = RF cable loss + attenuator factor.

Following shows an offset computation example with cable loss 6B and 10dB attenuator.



Example:

$$\begin{aligned} \text{Offset (dB)} &= \text{RF cable loss(dB)} + \text{attenuator factor(dB)} \\ &= 7.5 + 10 = 17.5(\text{dB}) \end{aligned}$$

1.6 Facilities and Accreditations

1.6.1 Test Facilities

NVLAP Lab Code: 201008-0

CCIC-SET is a third party testing organization accredited by NVLAP according to ISO/IEC 17025. The accreditation certificate number is 201008-0.

FCC- Designation Number: CN5031

CCIC Southern Electronic Product Testing (Shenzhen) Co., Ltd. EMC Laboratory has been registered and fully described in a report filed with the FCC (Federal Communications Commission). The acceptance letter from the FCC is maintained in our files. Designation Number: CN5031, valid time is until December 31, 2020.

ISED Registration: 11185A-1

CAB identifier: CN0064

CCIC Southern Testing Co., Ltd. EMC Laboratory has been registered by Certification and Engineering Bureau of Industry Canada for the performance of radiated measurements with Registration No. 11185A-1 on Aug. 04, 2016, valid time is until Dec. 03, 2020

1.6.2 Test Environment Conditions

During the measurement, the environmental conditions were within the listed ranges:

Temperature (°C):	15°C - 35°C
Relative Humidity (%):	30% -60%
Atmospheric Pressure (kPa):	86KPa-106KPa

2. 47 CFR PART 2, PART 22H & 24E 27L REQUIREMENTS

2.1 Conducted RF Output Power

2.1.1 Definition

A system simulator was used to establish communication with the EUT. Its parameters were set to enforce EUT transmitting at the maximum power. The measured power in the radio frequency on the transmitter output terminals shall be reported.

2.1.2 Measuring Instruments

The measuring equipment is listed in the section 3 of this test report.

2.1.3 Test Procedures

1. The transmitter output port was connected to the system simulator.
2. Set EUT at maximum power through system simulator.
3. Select lowest, middle, and highest channels for each band and different modulation.
4. Measure and record the power level from the system simulator.

2.1.4 Test Setup

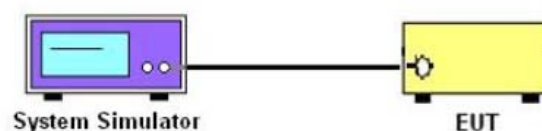



2.1.5 Test Results of Conducted Output Power

1. Test Verdict:

GSM850		Burst-Averaged output Power (dBm)		
		128CH	190CH	251CH
GSM (CS)		32.50	32.53	32.52
GPRS (GMSK)	1 Tx Slot	32.41	32.46	32.50
	2 Tx Slots	29.53	29.56	29.45
	3 Tx Slots	28.12	28.08	28.20
	4 Tx Slots	27.27	27.39	27.32
EDGE (8PSK)	1 Tx Slot	26.51	26.18	26.35
	2 Tx Slots	23.70	23.73	23.53
	3 Tx Slots	22.22	22.16	22.27
	4 Tx Slots	21.48	21.59	21.53
GSM1900		Burst-Averaged output Power (dBm)		
		512CH	661CH	810CH
GSM (CS)		30.27	30.15	30.42
GPRS (GMSK)	1 Tx Slot	30.32	30.13	30.41
	2 Tx Slots	27.61	27.63	27.52
	3 Tx Slots	26.25	26.18	26.28
	4 Tx Slots	25.15	25.12	25.11
EDGE (8PSK)	1 Tx Slot	25.82	25.67	25.74
	2 Tx Slots	23.05	23.07	22.90
	3 Tx Slots	21.57	21.46	21.57
	4 Tx Slots	20.71	20.77	20.76

Note 1: For the GPRS model, all the slots were tested and just the worst data was record in this report.



2. WCDMA Model Test Verdict:

UMTS1900 (Band II)		Average Power (dBm)		
		9262CH	9400CH	9538cH
WCDMA	12.2kbps RMC	23.24	23.25	22.79
HSDPA	Subtest 1	23.22	23.25	22.57
	Subtest 2	23.11	23.17	22.56
	Subtest 3	23.03	23.06	22.45
	Subtest 4	22.92	22.97	22.47
HSUPA	Subtest 1	22.83	22.86	22.75
	Subtest 2	22.70	22.75	22.66
	Subtest 3	22.61	22.66	22.57
	Subtest 4	22.54	22.58	22.45
	Subtest 5	22.43	22.49	22.34
UMTS1700 (Band IV)		Average Power (dBm)		
		1313CH	1413CH	1513CH
WCDMA	12.2kbps RMC	23.38	22.63	23.58
HSDPA	Subtest 1	23.06	23.17	23.11
	Subtest 2	22.95	23.09	22.98
	Subtest 3	22.86	22.98	22.89
	Subtest 4	22.74	22.86	22.8
HSUPA	Subtest 1	22.66	22.77	22.71
	Subtest 2	22.55	22.68	22.59
	Subtest 3	22.46	22.6	22.5
	Subtest 4	22.35	22.49	22.41
	Subtest 5	22.23	22.37	22.29
UMTS850 (Band V)		Average Power (dBm)		
		4132CH	4183CH	4233CH
WCDMA	12.2kbps RMC	22.76	22.46	22.27
HSDPA	Subtest 1	22.65	22.34	22.23
	Subtest 2	22.48	22.35	22.18
	Subtest 3	22.46	22.28	22.20
	Subtest 4	22.39	22.30	22.19
HSUPA	Subtest 1	21.97	21.66	21.55
	Subtest 2	21.8	21.67	21.5
	Subtest 3	21.78	21.6	21.52
	Subtest 4	21.71	21.62	21.51
	Subtest 5	21.73	21.58	21.47

2.2 Peak to Average Ratio

2.2.1 Definition

Power Complementary Cumulative Distribution Function (CCDF) curves provide a means for characterizing the power peaks of a digitally modulated signal on a statistical basis. A CCDF curve depicts the probability of the peak signal amplitude exceeding the average power level. Most contemporary measurement instrumentation include the capability to produce CCDF curves for an input signal provided that the instrument's resolution bandwidth can be set wide enough to accommodate the entire input signal bandwidth. In measuring transmissions in this band using an average power technique, the peak-to-average ratio (PAR) of the transmission may not exceed 13 dB.

2.2.2 Measuring Instruments

The measuring equipment is listed in the section 3 of this test report.

2.2.3 Test Procedures

1. The testing follows FCC KDB 971168 D01 v03r01 Section 5.7.1.
2. The EUT was connected to the spectrum analyzer and system simulator via a power divider.
3. For GSM/EGPRS operating modes:
 - a. Set EUT in maximum power output.
 - b. Set the RBW = 1MHz, VBW = 3MHz, Peak detector on spectrum analyzer for first trace.
 - c. Set the RBW = 1MHz, VBW = 3MHz, RMS detector on spectrum analyzer for second trace.
 - d. The wanted burst signal is triggered by spectrum analyzer, and measured respectively the peak level and Mean level without burst-off time, after system simulator has synchronized with the spectrum analyzer.
4. For UMTS operating modes:
 - a. Set the CCDF (Complementary Cumulative Distribution Function) option on the spectrum analyzer.
 - b. The highest RF powers were measured and recorded the maximum PAPR level associated with a probability of 0.1 %.
5. Record the deviation as Peak to Average Ratio.

2.2.4 Test Setup

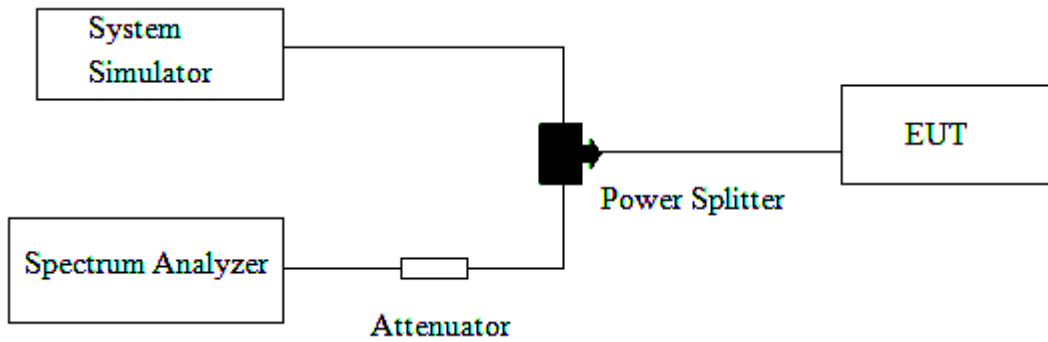

2.2.5 Test Results of Peak-to-Average Ratio

Band	Channel	Frequency (MHz)	Peak to Average ratio	Limit	Verdict
			dB	dB	
GSM 1900MHz	512	1850.2	0.4	13	PASS
	661	1880.0	0.3		PASS
	810	1909.8	0.3		PASS
EDGE 1900MHz	512	1850.2	3.3	13	PASS
	661	1880.0	3.5		PASS
	810	1909.8	3.6		PASS
WCDMA 1900MHz	9262	1852.4	2.94	13	PASS
	9400	1880.0	3.13		PASS
	9538	1907.6	3.03		PASS
WCDMA 1700MHz	1312	1712.4	2.88	13	PASS
	1412	1732.4	3.00		PASS
	1513	1752.6	3.21		PASS

2.3 99% Occupied Bandwidth and 26dB Bandwidth Measurement

2.3.1 Definition

The 99% occupied bandwidth is the width of a frequency band such that, below the lower and above the upper frequency limits, the mean powers emitted are each equal to a specified percentage 0.5% of the total mean transmitted power.

The emission bandwidth is defined as the width of the signal between two points, located at the 2 sides of the carrier frequency, outside of which all emissions are attenuated at least 26 dB below the transmitter power.

2.3.2 Measuring Instruments

The measuring equipment is listed in the section 3 of this test report.

2.3.3 Test Procedures

1. The testing follows FCC KDB 971168 D01 v03r01 Section 4.2.
2. The EUT was connected to the spectrum analyzer and system simulator via a power divider.
3. The RF output of the EUT was connected to the spectrum analyzer by RF cable and attenuator.

The path loss was compensated to the results for each measurement.

4. The 99% occupied bandwidth were measured, set RBW= 1% of span, VBW= 3*RBW, sample detector, trace maximum hold.
5. The 26dB bandwidth were measured, set RBW= 1% of EBW, VBW= 3*RBW, peak detector, trace maximum hold.

2.3.4 Test Setup

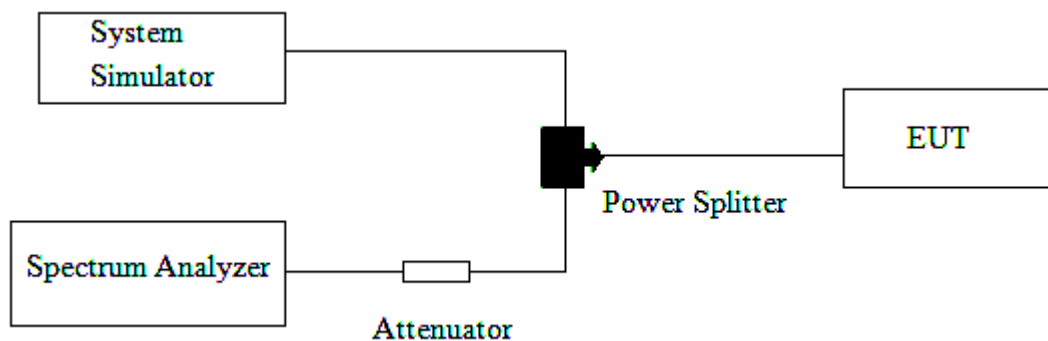

**2.3.5 Test Results of 99% Occupied Bandwidth and 26dB Bandwidth**

Band	Channel	Frequency (MHz)	26dB bandwidth (KHz)	99% Occupied Bandwidth (KHz)	Refer to Plot
GSM 850MHz	128	824.2	311.2	244.47	Plot A1
	190	836.6	312	246.65	Plot A2
	251	848.8	307.4	240.38	Plot A3
GSM 1900MHz	512	1850.2	305.6	243.44	Plot B1
	661	1880.0	314	246.06	Plot B2
	810	1909.8	304.5	244.51	Plot B3
EDGE 850MHz	128	824.2	295.1	239.32	Plot C1
	190	836.6	284.3	232.99	Plot C2
	251	848.8	300.9	238.83	Plot C3
EDGE 1900MHz	512	1850.2	292.5	239.49	Plot D1
	661	1880.0	312.5	245.72	Plot D2
	810	1909.8	304.3	244.66	Plot D3
WCDMA 850MHz	4132	826.4	4665	4157.4	Plot E1
	4183	836.6	4683	4153.5	Plot E2
	4233	846.6	4674	4148.3	Plot E3
WCDMA 1900MHz	9262	1852.4	4680	4145.1	Plot F1
	9400	1880	4671	4161.2	Plot F2
	9538	1907.6	4681	4160.3	Plot F3
WCDMA 1700MHz	1312	1712.4	4649	4147.8	Plot G1
	1412	1732.4	4683	4158.8	Plot G2
	1513	1752.6	4683	4153.6	Plot G3

2.3.6 Test Results (Plots) of 99% Occupied Bandwidth and 26dB Bandwidth



(Plot A1: GSM 850MHz Channel = 128 Occupied bandwidth)



(Plot A2: GSM 850MHz Channel = 190 Occupied bandwidth)

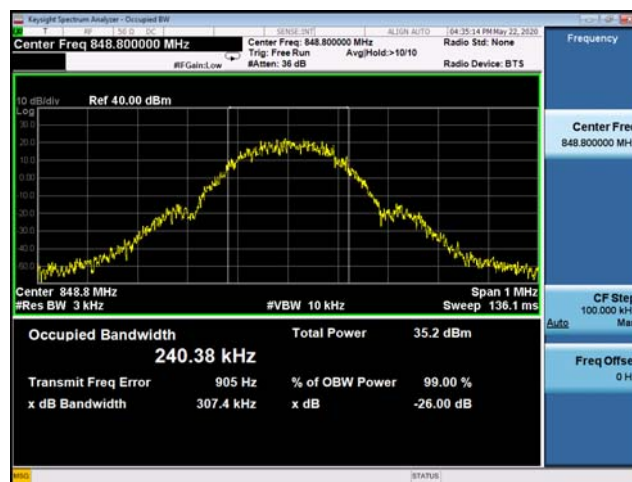

(Plot A3: GSM 850MHz Channel = 251 Occupied bandwidth)



(Plot B1: GSM 1900MHz Channel = 512 Occupied bandwidth)



(Plot B2: GSM 1900MHz Channel = 661 Occupied bandwidth)



(Plot B3: GSM 1900MHz Channel = 810 Occupied bandwidth)



(Plot C1: EDGE 850MHz Channel = 128 Occupied bandwidth)



(Plot C2: EDGE 850MHz Channel = 190 Occupied bandwidth)

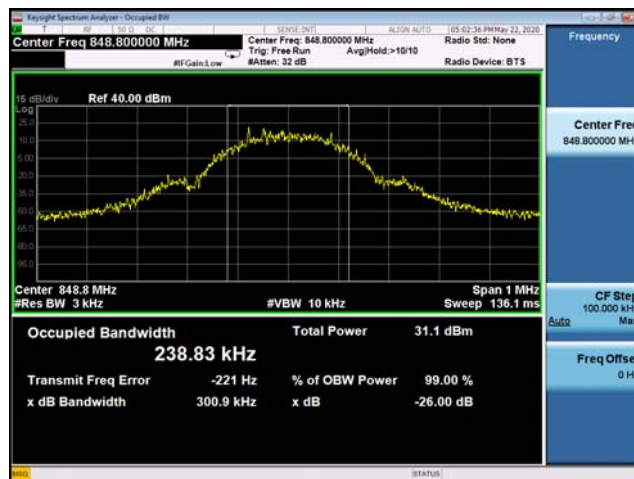

(Plot C3: EDGE 850MHz Channel = 251 Occupied bandwidth)



(Plot D1: EDGE 1900MHz Channel = 512 Occupied bandwidth)



(Plot D2: EDGE 1900MHz Channel = 661 Occupied bandwidth)



(Plot D3: EDGE 1900MHz Channel = 810 Occupied bandwidth)

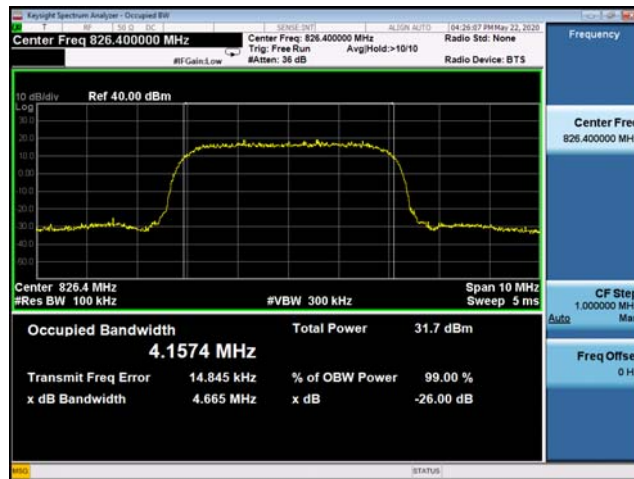

(Plot E1: WCDMA 850MHz Channel = 4132 Occupied bandwidth)



(Plot E2: WCDMA 850MHz Channel = 4183 Occupied bandwidth)



(Plot E3: WCDMA 850MHz Channel = 4233 Occupied bandwidth)

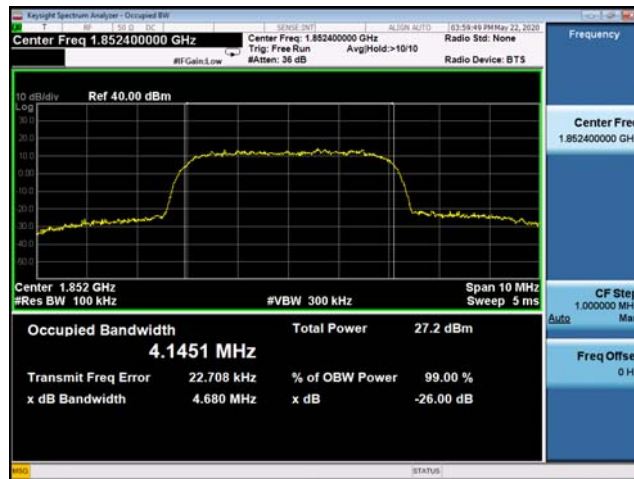

(Plot F1: WCDMA 1900MHz Channel = 9262 Occupied bandwidth)



(Plot F2: WCDMA 1900MHz Channel = 9400 Occupied bandwidth)



(Plot F3: WCDMA 1900MHz Channel = 9538 Occupied bandwidth)



(Plot G1: WCDMA 1700MHz Channel = 1312 bandwidth)



(Plot G2: WCDMA 1700 MHz Channel = 1412 bandwidth)

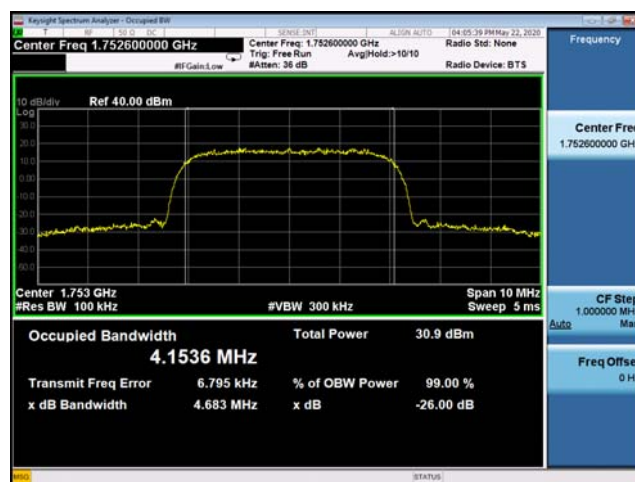

(Plot G2: WCDMA 1700 MHz Channel = 1513 bandwidth)

2.4 Frequency Stability

2.4.1 Requirement

The frequency stability shall be measured by variation of ambient temperature and variation of primary supply voltage to ensure that the fundamental emission stays within the authorized frequency block. The frequency stability of the transmitter shall be maintained within $\pm 0.00025\%$ ($\pm 2.5\text{ppm}$) of the center frequency.

2.4.2 Measuring Instruments

The measuring equipment is listed in the section 3 of this test report.

2.4.3 Test Procedures for Temperature Variation

1. The testing follows FCC KDB 971168 D01 v03r01 Section 9.0.
2. The EUT was set up in the thermal chamber and connected with the system simulator.
3. With power OFF, the temperature was decreased to -30°C and the EUT was stabilized before testing. Power was applied and the maximum change in frequency was recorded within one minute.
4. With power OFF, the temperature was raised in 10°C steps up to 50°C . The EUT was stabilized at each step for at least half an hour. Power was applied and the maximum frequency change was recorded within one minute.

2.4.4 Test Procedures for Voltage Variation

1. The testing follows FCC KDB 971168 D01 v03r01 Section 9.0.
2. The EUT was placed in a temperature chamber at $25\pm 5^{\circ}\text{C}$ and connected with the system simulator.
3. The power supply voltage to the EUT was varied from BEP to 115% of the nominal value measured at the input to the EUT.
4. The variation in frequency was measured for the worst case.

2.4.5 Test Setup

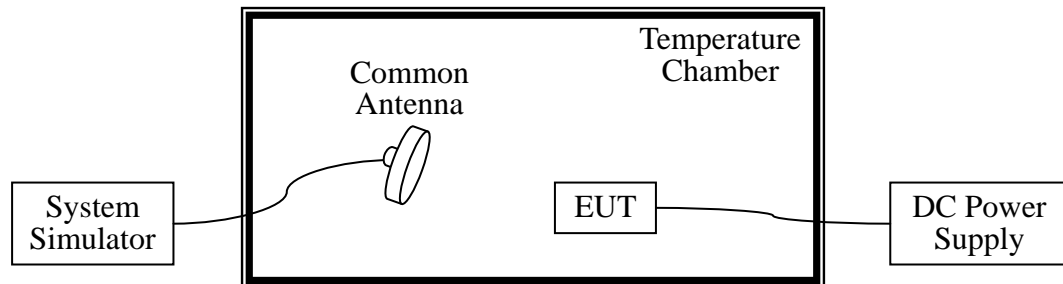

2.4.6 Test Results of Frequency Stability

GSM 850MHz Band

Band:	GSM 850	Channel:	190
Limit(ppm):	2.5	Frequency:	836.6MHz

Power (VDC)	Temperature (°C)	GSM	EDGE	Result
		Deviation (ppm)	Deviation (ppm)	
3.8	-30	0.0021	0.0046	PASS
	-20	0.0021	0.0043	
	-10	0.0024	0.0016	
	0	0.0022	0.0044	
	+10	0.0031	0.0023	
	+20	0.0042	0.0029	
	+30	0.0021	0.0045	
	+40	0.0026	0.0027	
4.35	+50	0.0023	0.0031	
3.6	+25	0.0041	0.0029	
		0.0021	0.0032	



GSM 1900MHz Band

Band:	GSM 1900	Channel:	661
Limit(ppm):	2.5	Frequency:	1880.0MHz

Power (VDC)	Temperature (°C)	GSM	EDGE	Result
		Deviation (ppm)	Deviation (ppm)	
3.8	-30	0.0029	0.0015	PASS
	-20	0.0013	0.0026	
	-10	0.0014	0.0024	
	0	0.0015	0.0037	
	+10	0.0034	0.0034	
	+20	0.0035	0.0022	
	+30	0.0026	0.0037	
	+40	0.0023	0.0027	
	+50	0.0021	0.0036	
4.35	+25	0.0022	0.0028	
3.6	+25	0.0016	0.0025	

WCDMA 850MHz Band

Band:	WCDMA Band V	Channel:	4183
Limit(ppm):	2.5	Frequency:	836.6MHz

Power (VDC)	Temperature (°C)	RMC 12.2Kbps	Result
		Deviation (ppm)	
3.8	-30	0.0046	PASS
	-20	0.0051	
	-10	0.0052	
	0	0.0049	
	+10	0.0047	
	+20	0.0050	
	+30	0.0044	
	+40	0.0052	
	+50	0.0052	
4.35	+25	0.0050	
3.6	+25	0.0050	



WCDMA 1900MHz Band

Band:	WCDMA Band II	Channel:	9400
Limit(ppm):	2.5	Frequency:	1880.0MHz

Power (VDC)	Temperature (°C)	RMC 12.2Kbps	Result
		Deviation (ppm)	
3.8	-30	0.0044	PASS
	-20	0.0041	
	-10	0.0043	
	0	0.0046	
	+10	0.0058	
	+20	0.0071	
	+30	0.0047	
	+40	0.0041	
+50	0.0049		
4.35	+25	0.0047	
3.6	+25	0.0046	

WCDMA 1700MHz Band

Band:	WCDMA Band IV	Channel:	1412
Limit(ppm):	2.5	Frequency:	1732.4MHz

Power (VDC)	Temperature (°C)	RMC 12.2Kbps	Result
		Deviation (ppm)	
3.8	-30	0.0042	PASS
	-20	0.0052	
	-10	0.0050	
	0	0.0044	
	+10	0.0043	
	+20	0.0042	
	+30	0.0063	
	+40	0.0062	
+50	0.0032		
4.35	+25	0.0047	
3.6	+25	0.0043	

2.5 Conducted Out of Band Emissions

2.5.1 Requirement

The power of any emission outside of the authorized operating frequency ranges must be lower than the transmitter power (P) by a factor of at least $43 + 10 \log (P)$ dB.

It is measured by means of a calibrated spectrum analyzer and scanned from 30 MHz up to a frequency including its 10th harmonic.

2.5.2 Measuring Instruments

The measuring equipment is listed in the section 3 of this test report.

2.5.3 Test Procedures

1. The testing follows FCC KDB 971168 D01 v03r01 Section 6.0.
2. The EUT was connected to the spectrum analyzer and system simulator via a power divider.
3. The RF output of EUT was connected to the spectrum analyzer by an RF cable and attenuator. The path loss was compensated to the results for each measurement.
4. The middle channel for the highest RF power within the transmitting frequency was measured.
5. The conducted spurious emission for the whole frequency range was taken.
6. The RF fundamental frequency should be excluded against the limit line in the operating frequency band.
7. The limit line is derived from $43 + 10\log(P)$ dB below the transmitter power P(Watts)
 $= P(W) - [43 + 10\log(P)]$ (dB)
 $= [30 + 10\log(P)]$ (dBm) - $[43 + 10\log(P)]$ (dB)
 $= -13\text{dBm}$.
8. For 9KHz to 30MHz: the amplitude of spurious emissions are attenuated by more than 20dB below the permissible value has no need to be reported.

2.5.4 Test Setup

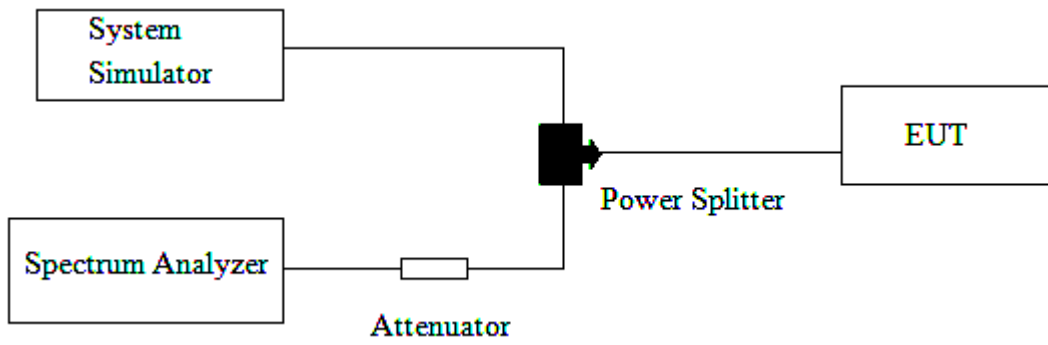

2.5.5 Test Result (Plots) of Conducted Spurious Emission

Note: For 9 KHz to 30MHz: the amplitude of spurious emissions is attenuated by more than 20dB below the permissible value, so we not provide the test result here.

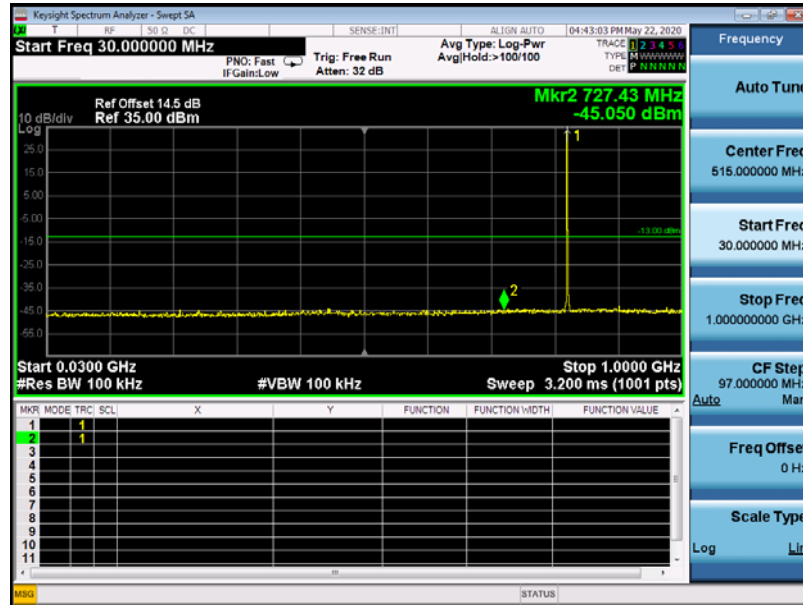

GSM 850MHz Channel = 128, 30MHz to 1GHz

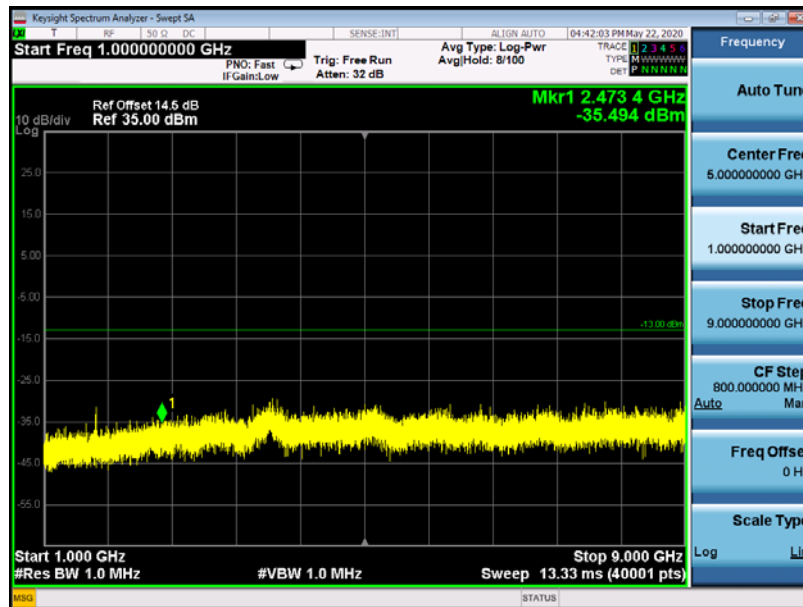

GSM 850MHz Channel = 128, 1GHz to 9GHz

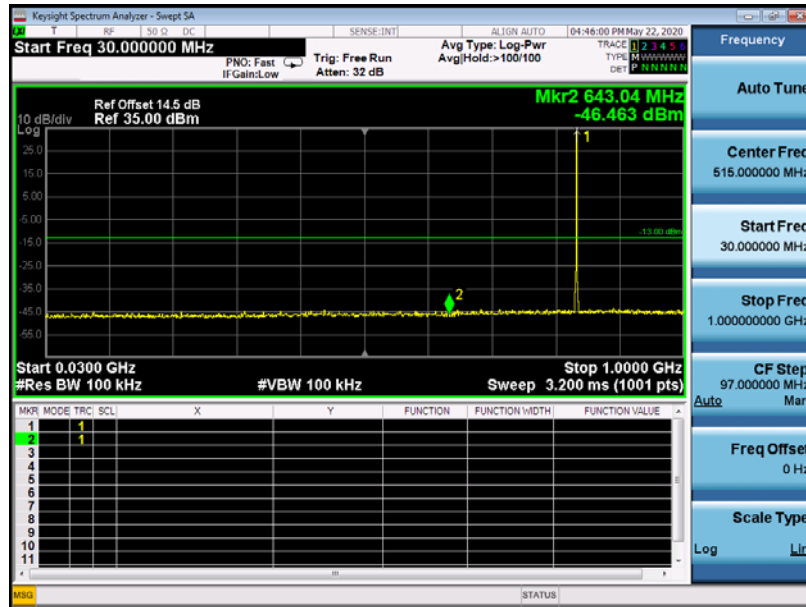

GSM 850MHz Channel = 190, 30MHz to 1GHz

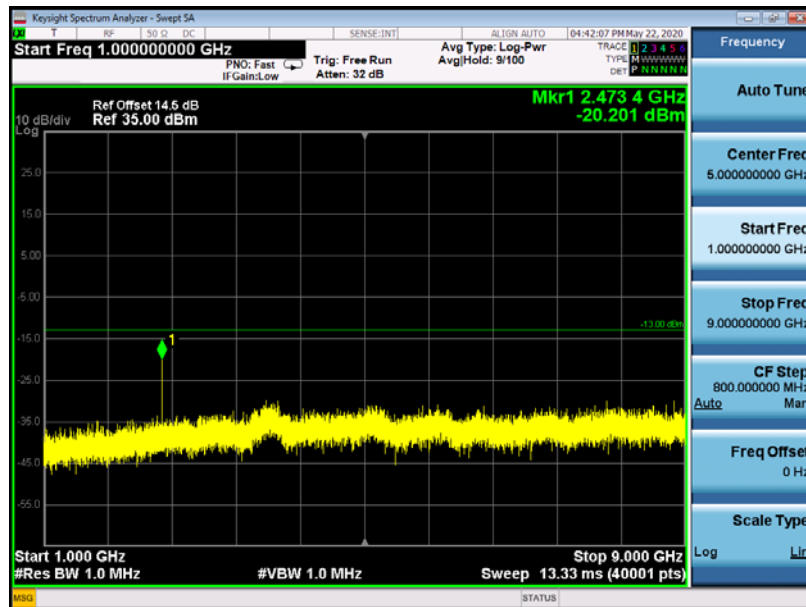

GSM 850MHz Channel = 190, 1GHz to 9GHz

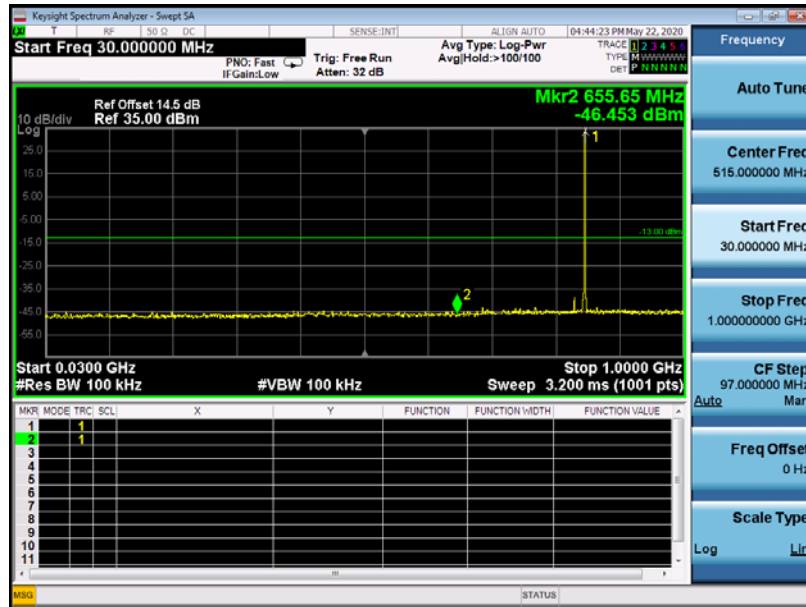

GSM 850MHz Channel = 251, 30MHz to 1GHz

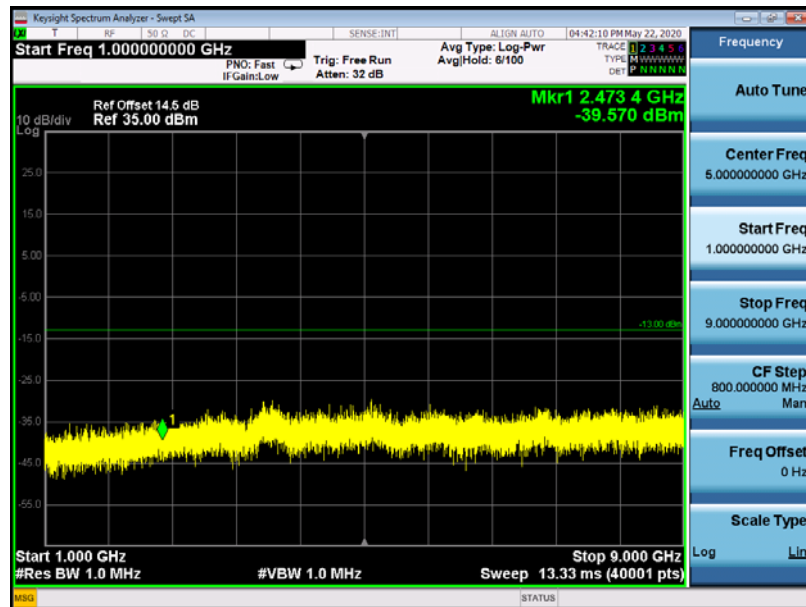

GSM 850MHz Channel = 251, 1GHz to 9GHz

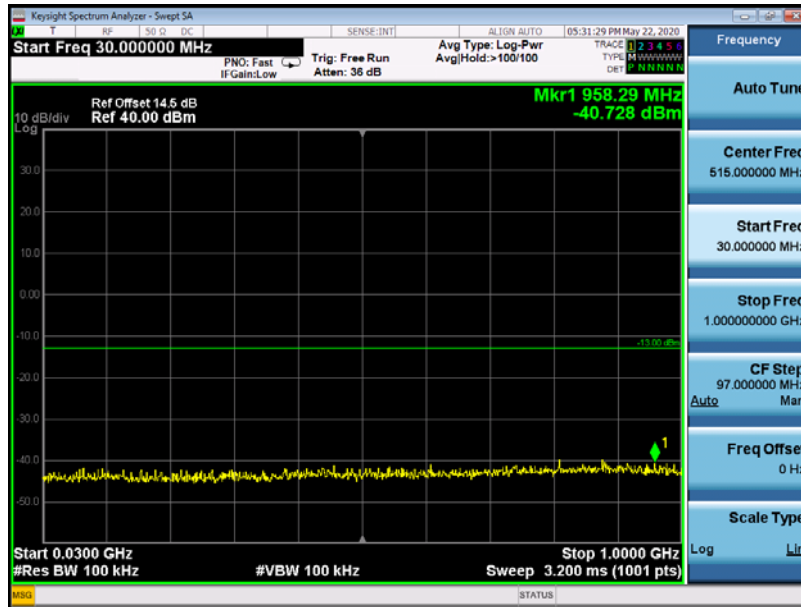

GSM 1900MHz Channel = 512, 30MHz to 1GHz

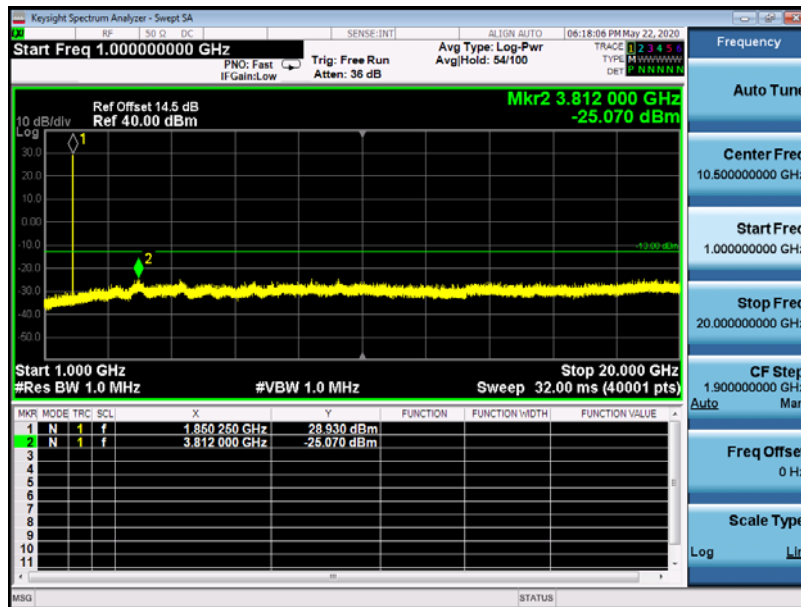

GSM 1900MHz Channel = 512, 1GHz to 20GHz

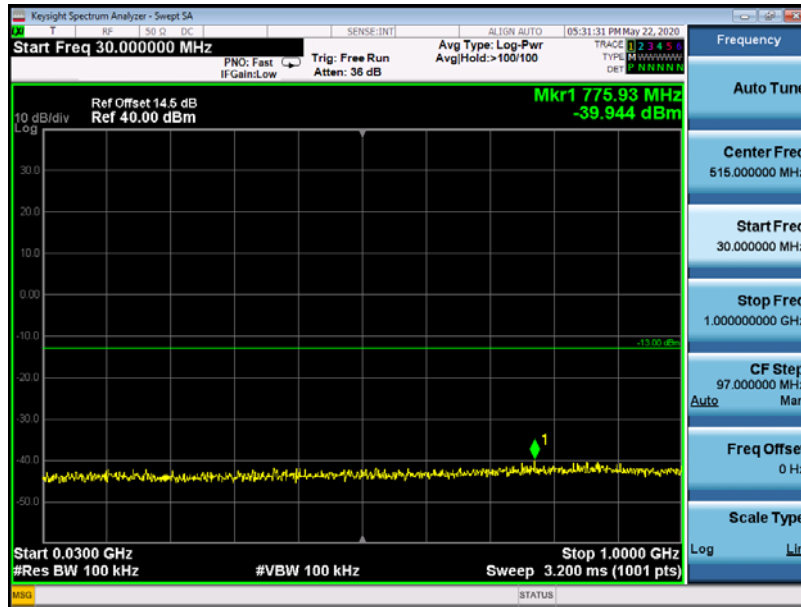

GSM 1900MHz Channel = 661, 30MHz to 1GHz

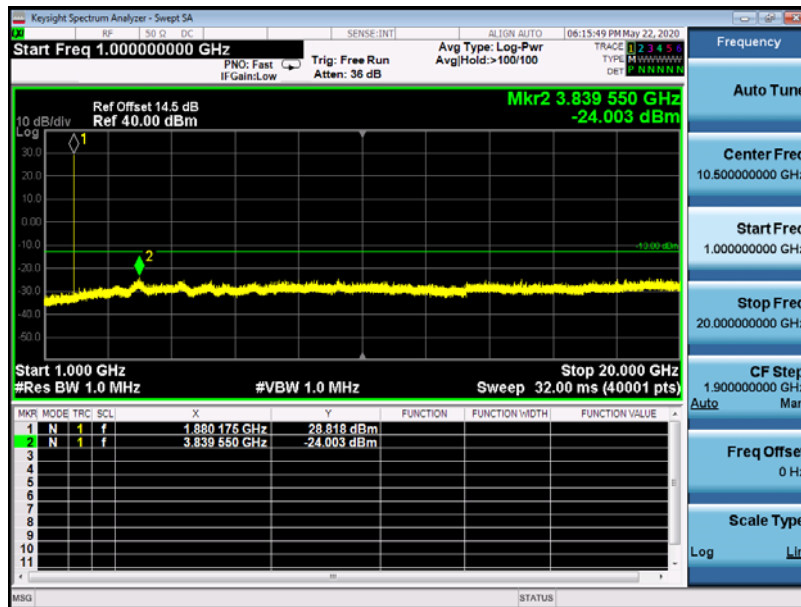

GSM 1900MHz Channel = 661, 1GHz to 20GHz

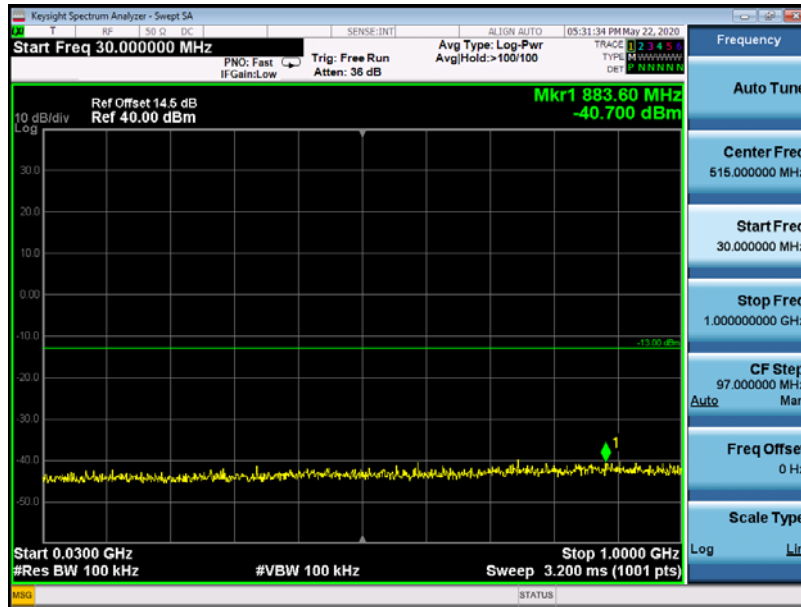

GSM 1900MHz Channel = 810, 30MHz to 1GHz

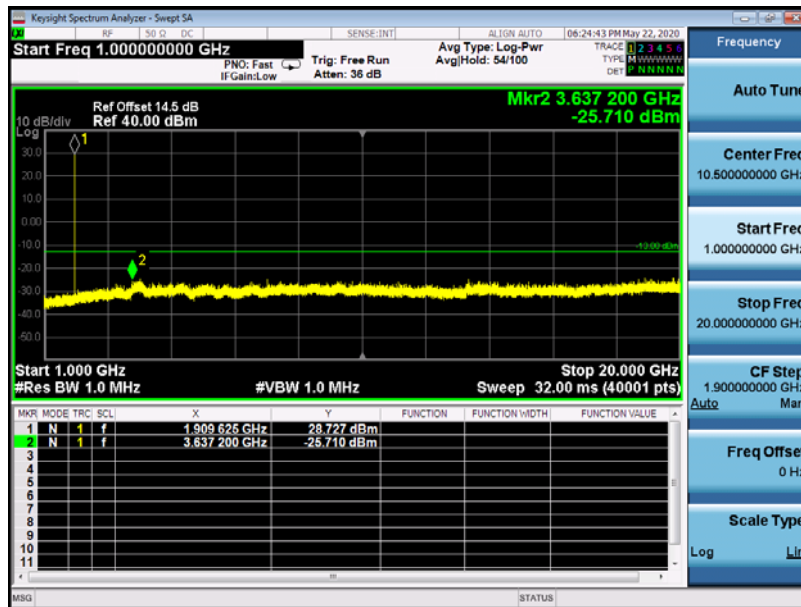

GSM 1900MHz Channel = 810, 1GHz to 20GHz

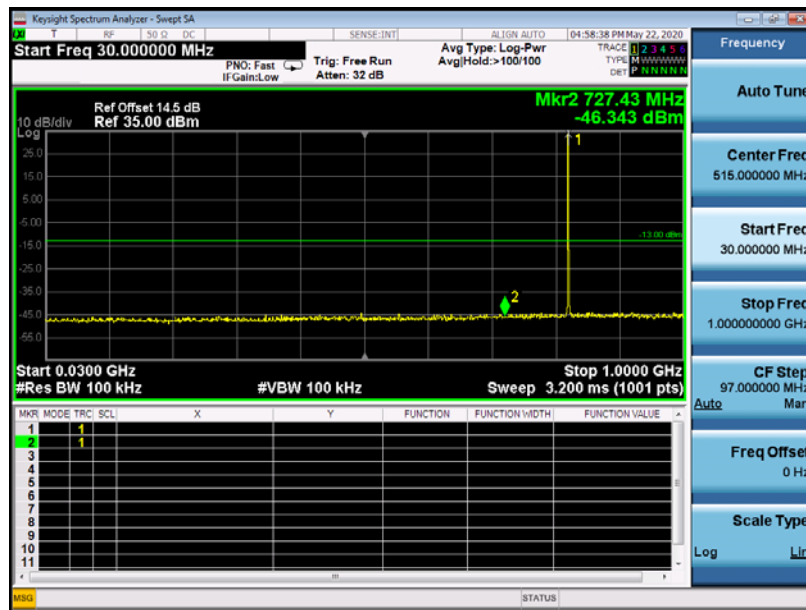

EDGE 850MHz Channel = 128, 30MHz to 1GHz

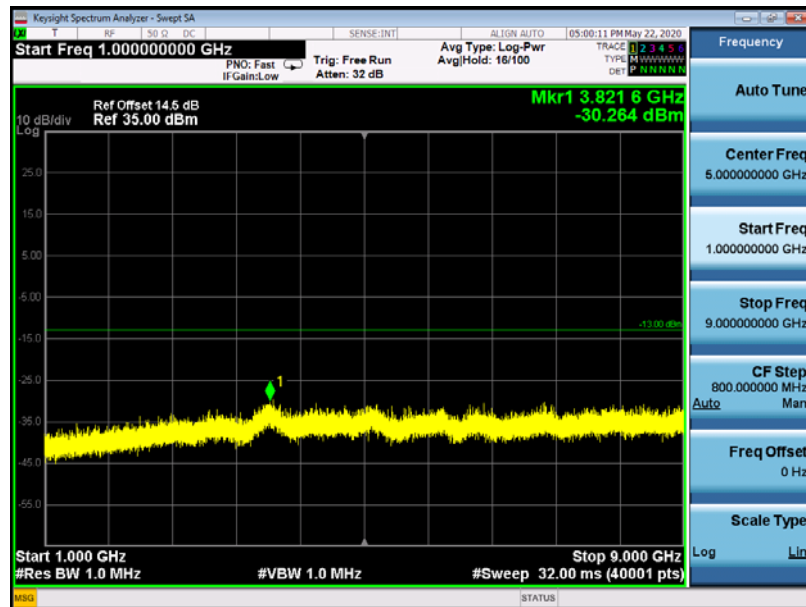

EDGE 850MHz Channel = 128, 1GHz to 9GHz

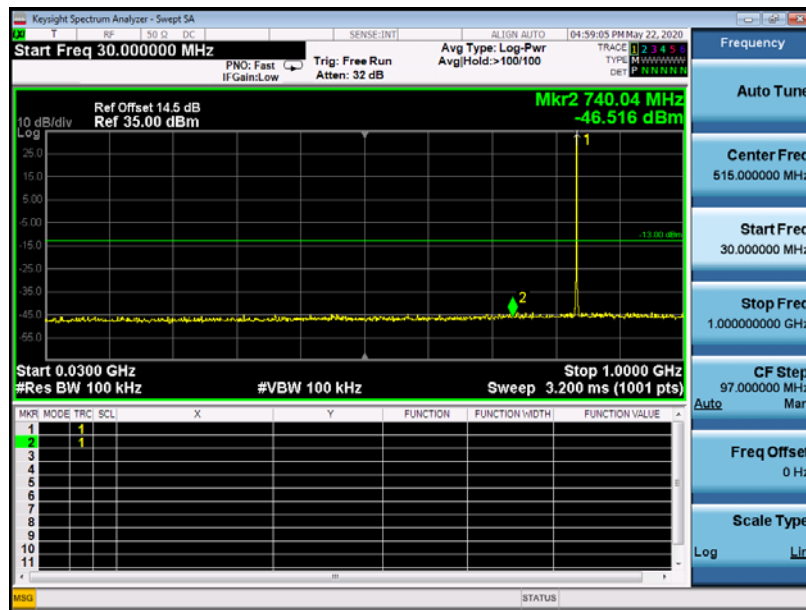

EDGE 850MHz Channel = 190, 30MHz to 1GHz

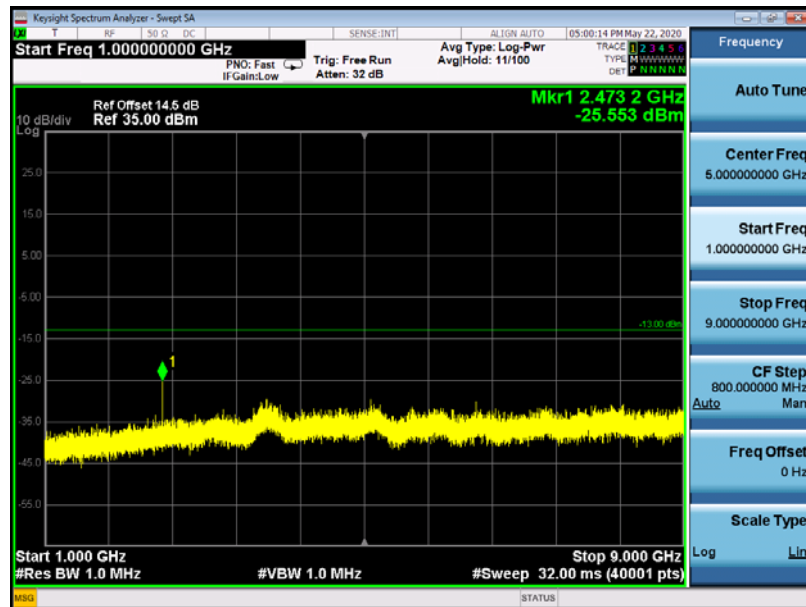

EDGE 850MHz Channel = 190, 1GHz to 9GHz

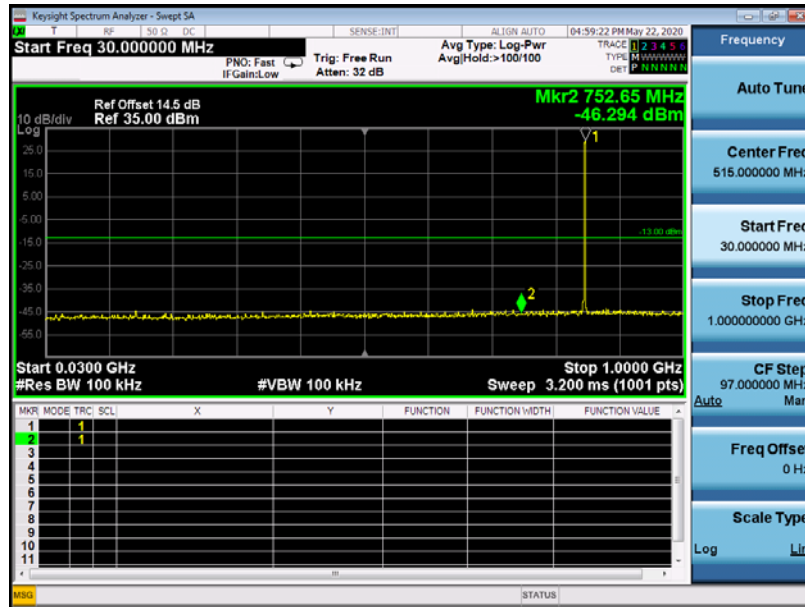

EDGE 850MHz Channel = 251, 30MHz to 1GHz

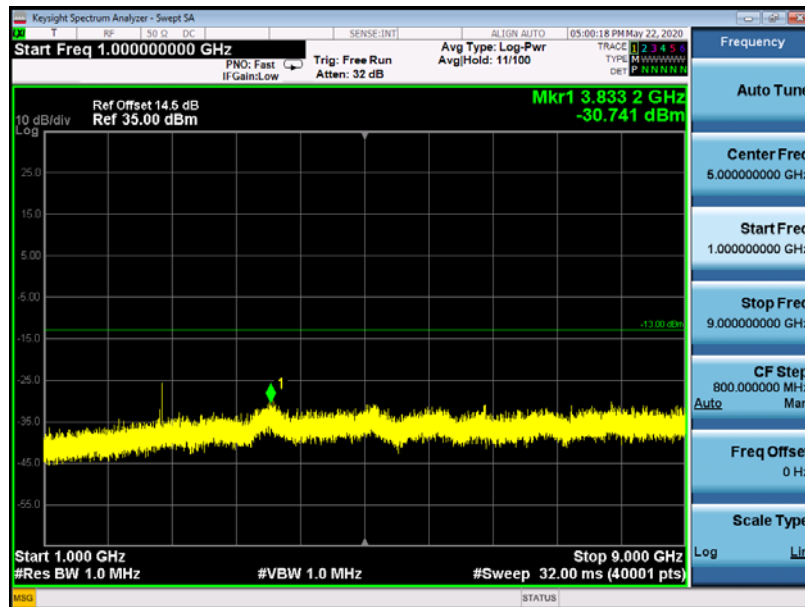

EDGE 850MHz Channel = 251, 1GHz to 9GHz

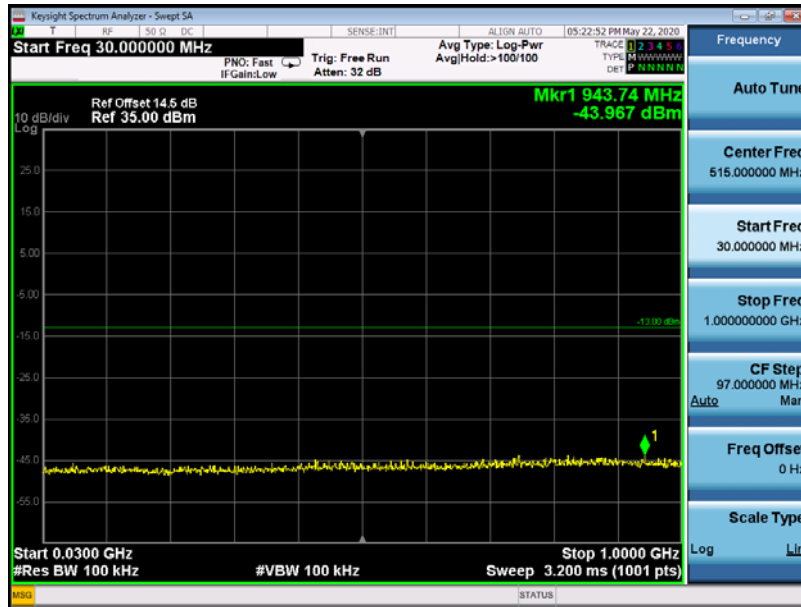

EDGE 1900MHz Channel = 512, 30MHz to 1GHz

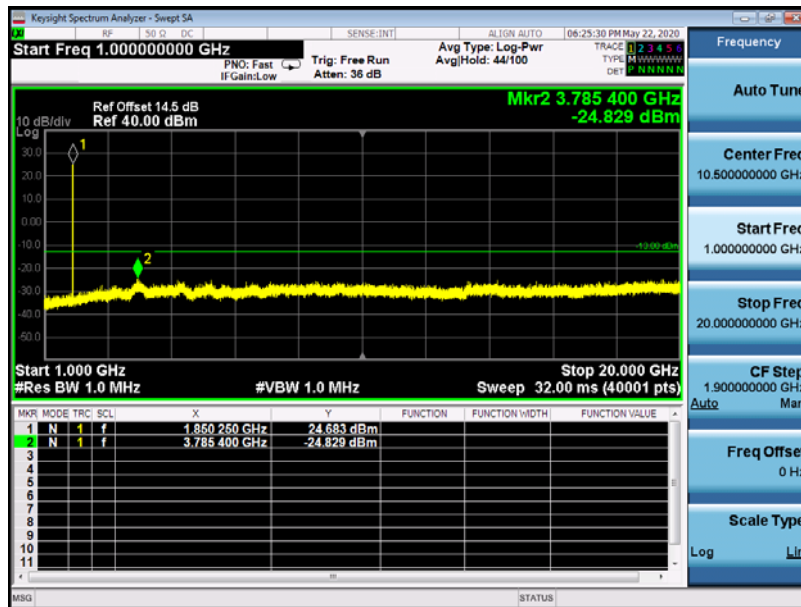

EDGE 1900MHz Channel = 512, 1GHz to 20GHz

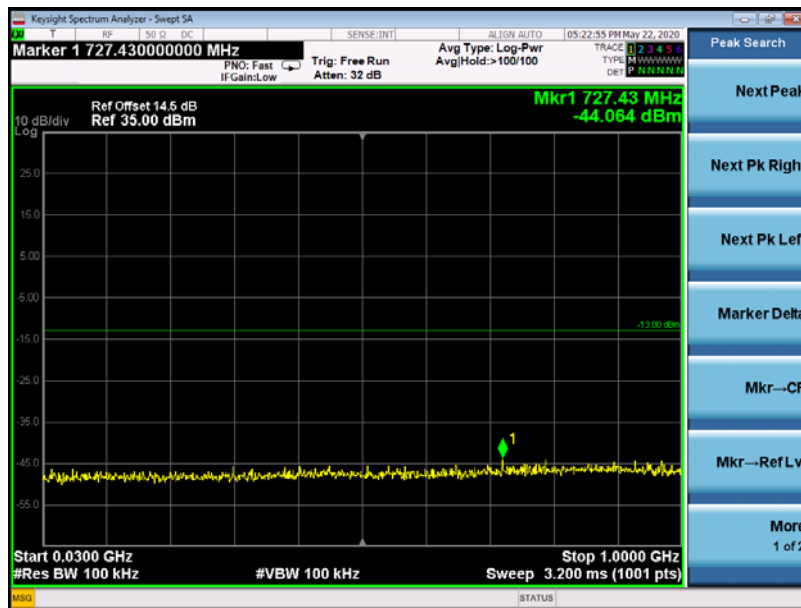

EDGE 1900MHz Channel = 661, 30MHz to 1GHz

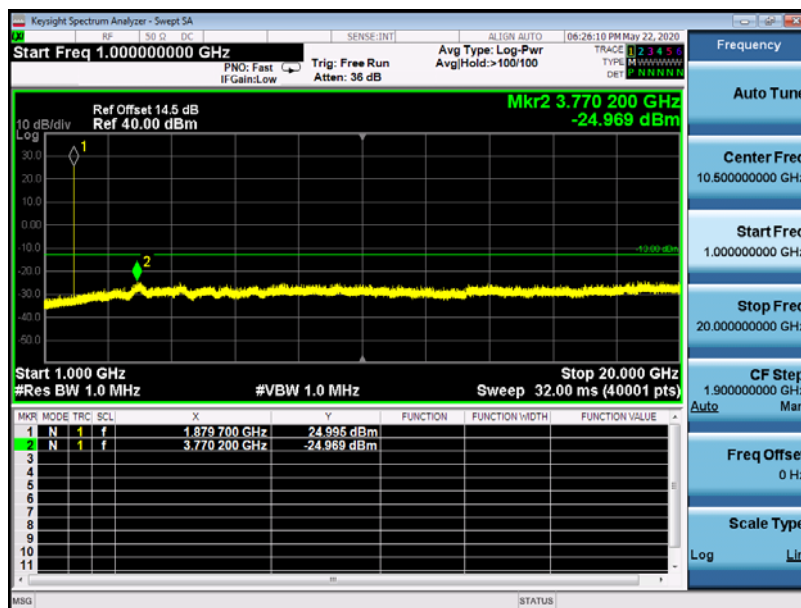

EDGE 1900MHz Channel = 661, 1GHz to 20GHz

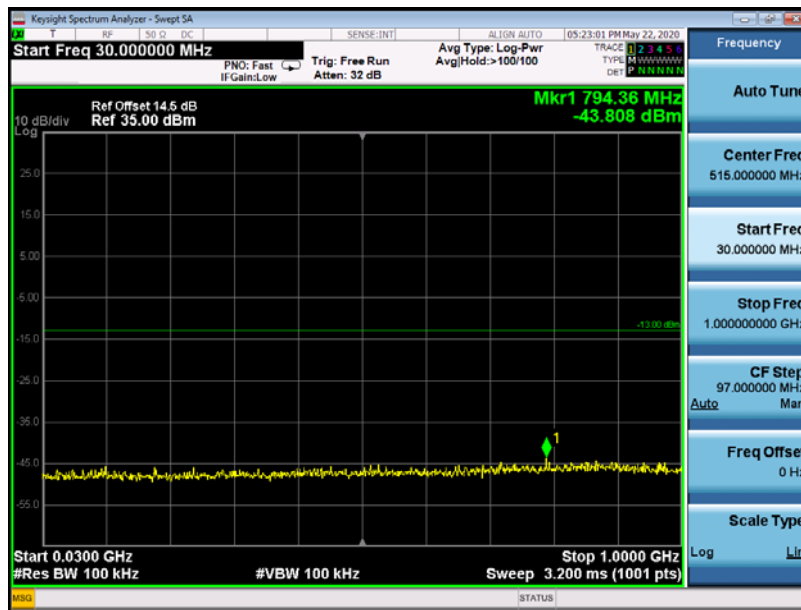

EDGE 1900MHz Channel = 810, 30MHz to 1GHz

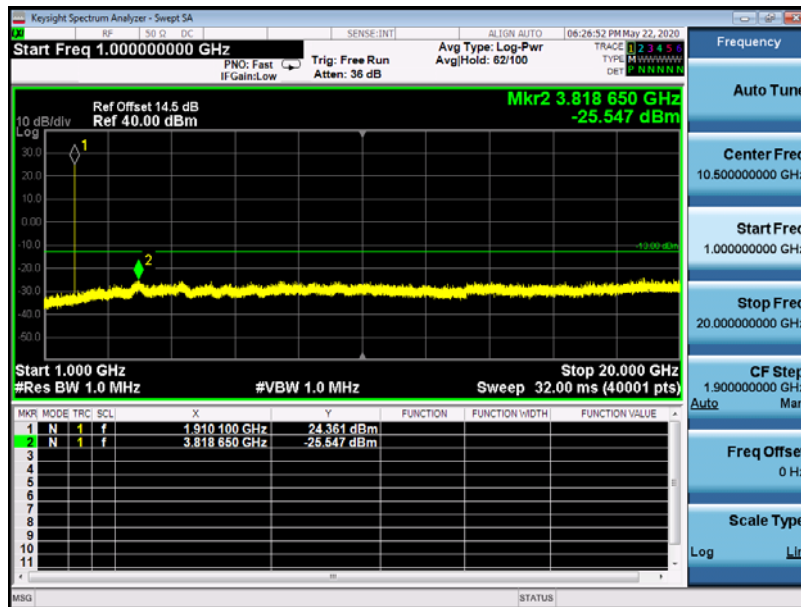

EDGE 1900MHz Channel = 810, 1GHz to 20GHz

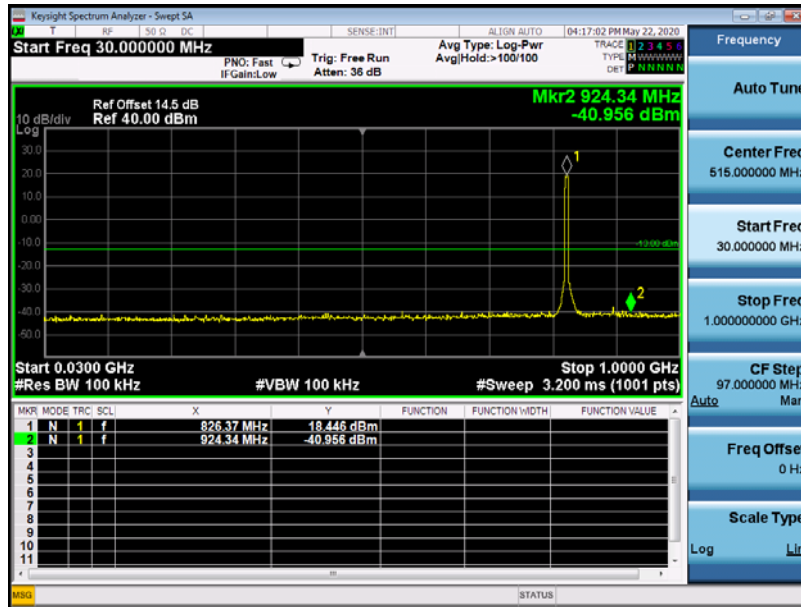

WCDMA850MHz Channel = 4132, 30MHz to 1GHz

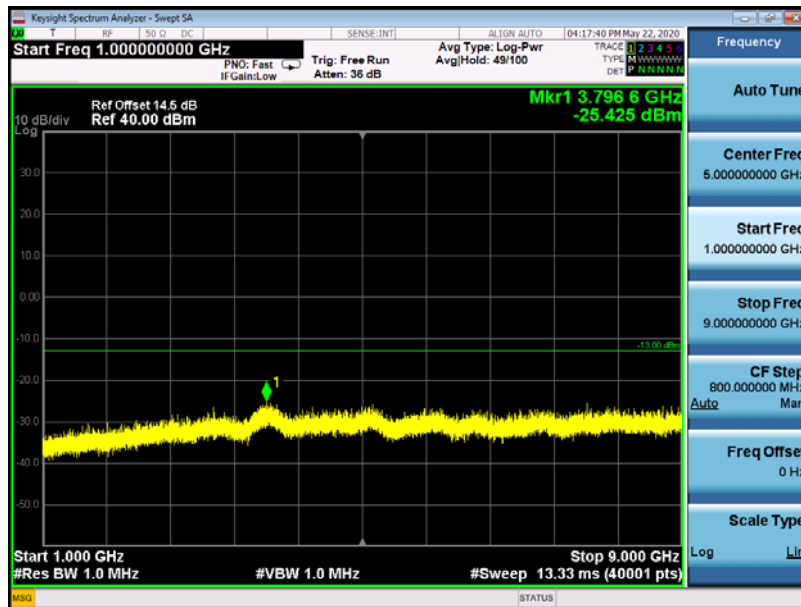

WCDMA850MHz Channel = 4132, 1GHz to 9GHz

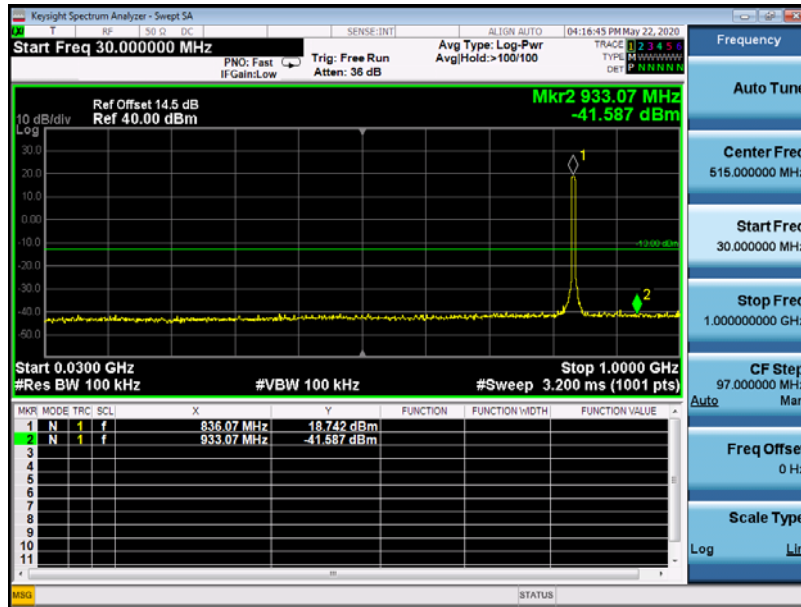

WCDMA850MHz Channel = 4183, 30MHz to 1GHz

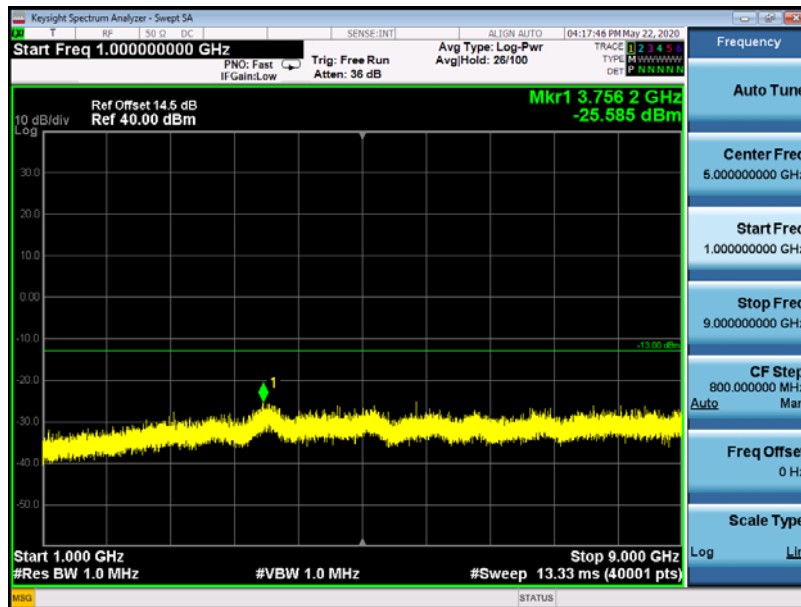

WCDMA850MHz Channel = 4183, 1GHz to 9GHz