



# RF TEST REPORT

**Applicant** ZTE Corporation

**FCC ID** SQR-ZTEBLADEA0621

**Product** LTE/WCDMA/GSM (GPRS) Multi-Mode Digital  
Mobile Phone

**Model** ZTE BLADE A0621, ZTE Blade A0621, ZTE  
blade A0621, BLADE A0621, Blade A6, blade A0621  
ZTE BLADE A6, ZTE Blade A6, ZTE blade A6,  
BLADE A6, Blade A6, blade A6

**Report No.** RXA1706-0195RF05

**Issue Date** July 26, 2017

TA Technology (Shanghai) Co., Ltd. tested the above equipment in accordance with the requirements in **FCC CFR47 Part 15C (2017)**. The test results show that the equipment tested is capable of demonstrating compliance with the requirements as documented in this report.

Performed by: Xianqing Li

Approved by: Kai Xu

---

**TA Technology (Shanghai) Co., Ltd.**

No.145, Jintang Rd, Tangzhen Industry Park, Pudong Shanghai, China

TEL: +86-021-50791141/2/3

FAX: +86-021-50791141/2/3-8000



## TABLE OF CONTENT

1. Test Laboratory .....	4
1.1. Notes of the test report.....	4
1.2. Test facility .....	4
1.3. Testing Location.....	5
2. General Description of Equipment under Test.....	6
3. Applied Standards .....	8
4. Test Configuration .....	9
5. Test Case Results .....	10
5.1. Average Power Output –Conducted.....	10
5.2. 6dB Bandwidth .....	14
5.3. Band Edge .....	18
5.4. Power Spectral Density .....	21
5.5. Spurious RF Conducted Emissions.....	25
5.6. Radiated Emissions in the Restricted Band .....	31
5.7. Radiates Emission .....	36
5.8. Conducted Emission .....	64
6. Main Test Instruments.....	71
ANNEX A: EUT Appearance and Test Setup .....	72
A.1 EUT Appearance .....	72
A.2 Test Setup .....	75



## Summary of measurement results

Number	Summary of measurements of results	Clause in FCC rules	Verdict
1	Maximum Average conducted output power	15.247(b)(3)	PASS
2	6 dB bandwidth	15.247(a)(2)	PASS
3	Power spectral density	15.247(e)	PASS
4	Band Edge	15.247(d)	PASS
5	Spurious RF Conducted Emissions	15.247(d)	PASS
6	Radiated Emissions in restricted frequency bands	15.247(d),15.205,15.209	PASS
7	Radiated Emissions	15.247(d),15.205,15.209	PASS
8	Conducted Emissions	15.207	PASS
Date of Testing: June 21, 2017 ~ July 6, 2017			

## 1. Test Laboratory

### 1.1. Notes of the test report

This report shall not be reproduced in full or partial, without the written approval of **TA technology (shanghai) co., Ltd.** The results documented in this report apply only to the tested sample, under the conditions and modes of operation as described herein .Measurement Uncertainties were not taken into account and are published for informational purposes only. This report is written to support regulatory compliance of the applicable standards stated above. This report must not be used by the client to claim product certification, approval, or endorsement by any government agencies.

### 1.2. Test facility

#### **CNAS (accreditation number: L2264)**

TA Technology (Shanghai) Co., Ltd. has obtained the accreditation of China National Accreditation Service for Conformity Assessment (CNAS).

#### **FCC (recognition number is 428261)**

TA Technology (Shanghai) Co., Ltd. has been listed on the US Federal Communications Commission list of test facilities recognized to perform electromagnetic emissions measurements.

#### **IC (recognition number is 8510A)**

TA Technology (Shanghai) Co., Ltd. has been listed by industry Canada to perform electromagnetic emission measurement.

#### **VCCI (recognition number is C-4595, T-2154, R-4113, G-10766)**

TA Technology (Shanghai) Co., Ltd. has been listed by industry Japan to perform electromagnetic emission measurement.

#### **A2LA (Certificate Number: 3857.01)**

TA Technology (Shanghai) Co., Ltd. has been listed by American Association for Laboratory Accreditation to perform electromagnetic emission measurement.



### 1.3. Testing Location

Company: TA Technology (Shanghai) Co., Ltd.  
Address: No.145, Jintang Rd, Tangzhen Industry Park, Pudong  
City: Shanghai  
Post code: 201201  
Country: P. R. China  
Contact: Xu Kai  
Telephone: +86-021-50791141/2/3  
Fax: +86-021-50791141/2/3-8000  
Website: <http://www.ta-shanghai.com>  
E-mail: [xukai@ta-shanghai.com](mailto:xukai@ta-shanghai.com)

## 2. General Description of Equipment under Test

### Client Information

Applicant	ZTE Corporation
Applicant address	ZTE Plaza, Keji Road South, Hi-Tech, Industrial Park, Nanshan District, Shenzhen, Guangdong, 518057, P.R.China
Manufacturer	ZTE Corporation
Manufacturer address	ZTE Plaza, Keji Road South, Hi-Tech, Industrial Park, Nanshan District, Shenzhen, Guangdong, 518057, P.R.China

### General information

EUT Description	
Model:	ZTE BLADE A0621, ZTE Blade A0621, ZTE blade A0621, BLADE A0621, Blade A6, blade A0621 ZTE BLADE A6, ZTE Blade A6, ZTE blade A6, BLADE A6, Blade A6, blade A6
IMEI:	865529030009429
Hardware Version:	u6jA
Software Version:	GEN_ES_A0621_V1.0
Power Supply:	Battery/AC adapter
Antenna Type:	Internal Antenna
Antenna Connector:	A permanently attached antenna (meet with the standard FCC Part 15.203 requirement)
Antenna Gain:	-6.67 dBi for 2412MHz/2402MHz
	-7.02 dBi for 2437MHz/2441MHz
	-7.02 dBi for 2462MHz/2480MHz
additional beamforming gain:	0 dB
Test Mode:	Bluetooth(Low Energy) ; 802.11b, 802.11g, 802.11n(HT20);
Modulation Type:	BLE :GFSK; 802.11b: DSSS; 802.11g/n(HT20): OFDM;
Max. Conducted Power	Wi-Fi 2.4G : 17.15dBm BLE : -0.27 dBm
Operating Frequency Range(s)	802.11b/g/n(HT20): 2412 ~ 2462 MHz BLE: 2402 ~2480 MHz

<b>EUT Accessory</b>	
Adapter 1	Manufacturer: RUIJING Model: STC-A521A-Z Input power: 100-240V AC 50/60Hz 0.4A Output power: 5V DC 2.1A
Adapter 2	Manufacturer: SALCOMP Model: STC-A521A-Z Input power: 100-240V AC 50/60Hz 0.4A Output power: 5V DC 2.1A
Battery	Manufacturer: SCUD (Fujian) Electronics Co., LTD Model: Li3849T44P8h906450 Power Rating: DC 3.85V, 4870mAh, Li-ion
Earphone 1	Manufacturer: FDC Model: 500002757304
Earphone 2	Manufacturer: SANGFAI ELECTRICAL MANUFACTURE LIMITED Model: SF-880KM-53
USB Cable 1	Manufacturer: LUXSHARE-ICT 100cm Cable, Shielded
USB Cable 2	Manufacturer: Yi Hu Xing Electronic Co., Ltd 98cm Cable, Shielded
Remark: 1. The information of the EUT is declared by the manufacturer. 2. There is more than one Adapter, each one should be applied throughout the compliance test respectively, however, only the worst case (Adapter 1) will be recorded in this report.	



### 3. Applied Standards

According to the specifications of the manufacturer, it must comply with the requirements of the following standards:

#### Test standards

- **FCC CFR47 Part 15C (2017) Radio Frequency Devices**
- **ANSI C63.10 (2013)**
- **KDB 558074 D01 DTS Meas Guidance v04**



## 4. Test Configuration

### Test Mode

The EUT was programmed to be in continuously transmitting mode and the transmit duty cycle is not less than 98%.

The EUT has been associated with peripherals and configuration operated in a manner tended to maximize its emission characteristics in a typical application.

The radiated emission was measured in the following position: EUT stand-up position (Z axis), lie-down position (X, Y axis). The worst emission was found in stand-up position (Z axis) and the worst case was recorded.

In order to find the worst case condition, Pre-tests are needed at the presence of different data rate. Preliminary tests have been done on all the configuration for confirming worst case. Data rate below means worst-case rate of each test item.

Worst-case data rates are shown as following table.

Band	Data Rate
Bluetooth(Low Energy)	1Mbps
802.11b	1 Mbps
802.11g	6 Mbps
802.11n HT20	MCS0

## 5. Test Case Results

### 5.1. Average Power Output –Conducted

#### Ambient condition

Temperature	Relative humidity	Pressure
23°C ~25°C	45%~50%	101.5kPa

#### Methods of Measurement

During the process of the testing, The EUT was connected to Spectrum Analyzer with a known loss. The EUT is max power transmission with proper modulation. The Average detector is used. We use Maximum Average Conducted Output Power Level Method in KDB 558074 D01 for this test.

#### Test Setup

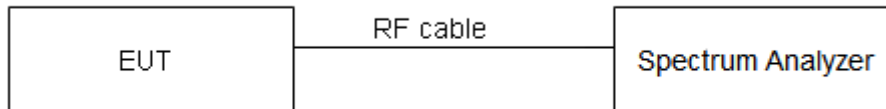

#### Limits

Rule Part 15.247 (b) (3) specifies that " For systems using digital modulation in the 902–928 MHz, 2400–2483.5 MHz: 1 Watt."

Average Output Power	$\leq 1W$ (30dBm)
----------------------	-------------------

#### Measurement Uncertainty

The assessed measurement uncertainty to ensure 95% confidence level for the normal distribution is with the coverage factor  $k = 2$ ,  $U = 0.44$  dB.

**Test Results**

Packet Type	Power Index		
	CH1	CH6	CH11
802.11b	16	16	16
802.11g	13	13	13
802.11n HT20	12	12	12

Network Standards	Carrier frequency (MHz)	Average Output Power (dBm)	Limit (dBm)	Conclusion
802.11b	2412	16.08	30	PASS
	2437	17.15	30	PASS
	2462	16.04	30	PASS
802.11g	2412	12.32	30	PASS
	2437	14.55	30	PASS
	2462	12.63	30	PASS
802.11n HT20	2412	11.33	30	PASS
	2437	13.26	30	PASS
	2462	11.22	30	PASS
Bluetooth (Low Energy)	2402	-0.60	30	PASS
	2440	-0.27	30	PASS
	2480	-0.33	30	PASS



802.11b, Carrier frequency (MHz): 2412



802.11g, Carrier frequency (MHz): 2412

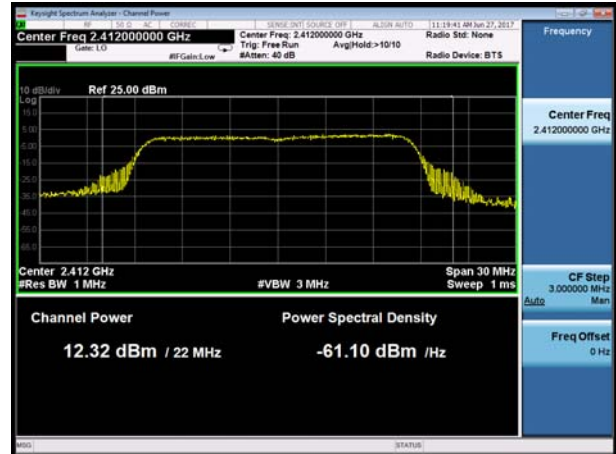

802.11b, Carrier frequency (MHz): 2437

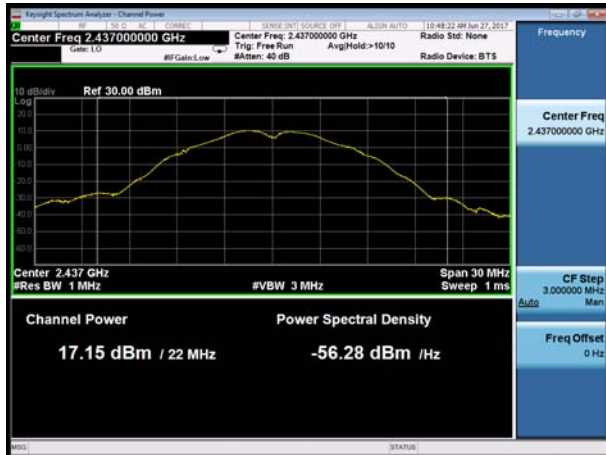

802.11g, Carrier frequency (MHz): 2437

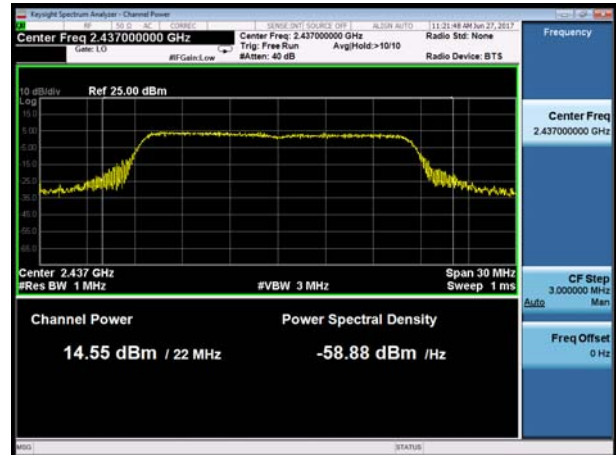

802.11b, Carrier frequency (MHz): 2462



802.11g, Carrier frequency (MHz): 2462

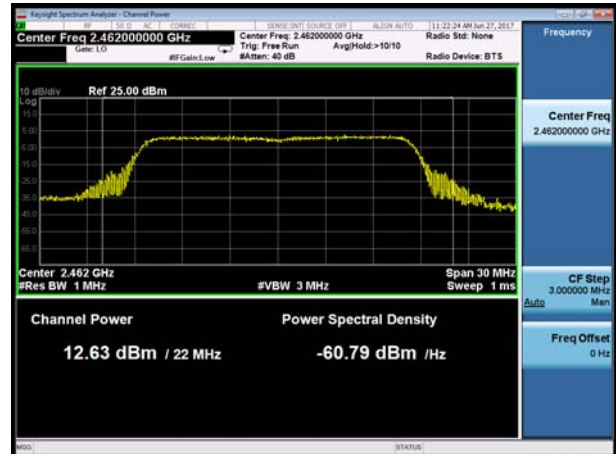

802.11n(HT20), Carrier frequency (MHz): 2412

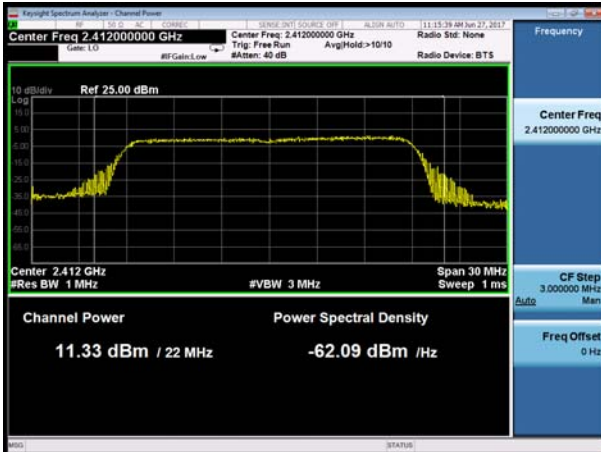

BLE Carrier frequency (MHz): 2402

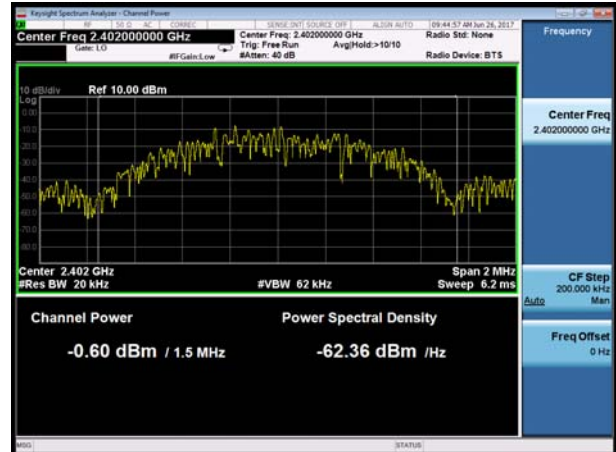

802.11n(HT20), Carrier frequency (MHz): 2437

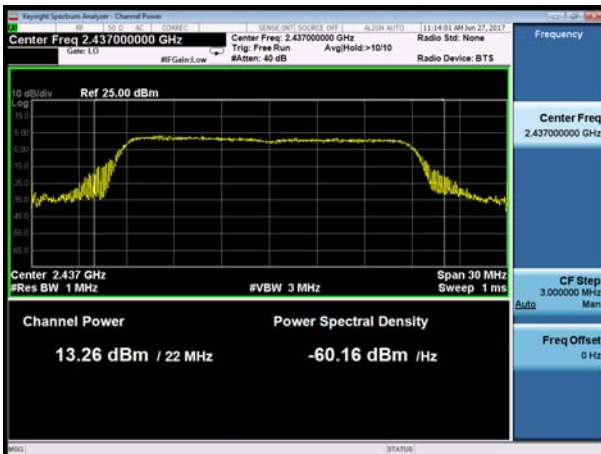

BLE Carrier frequency (MHz): 2440

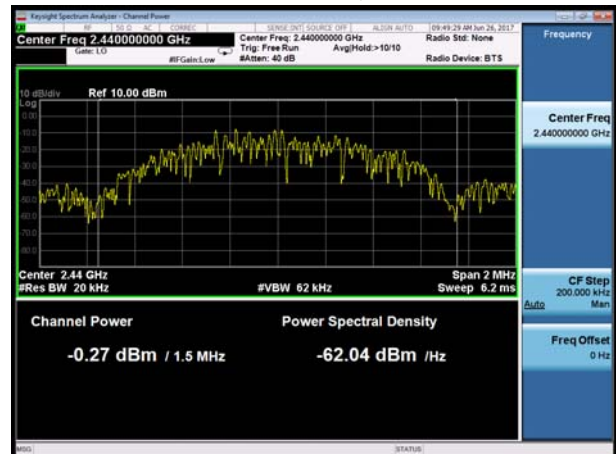

802.11n(HT20), Carrier frequency (MHz): 2462

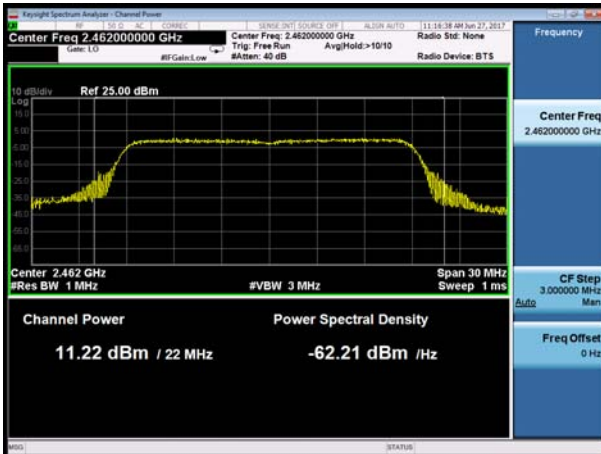

BLE Carrier frequency (MHz): 2480



## 5.2. 6dB Bandwidth

### Ambient condition

Temperature	Relative humidity	Pressure
23°C ~25°C	45%~50%	101.5kPa

### Method of Measurement

The EUT was connected to the spectrum analyzer through an external attenuator (20dB) and a known loss cable. RBW is set to 100 kHz; VBW is set to 300 kHz on spectrum analyzer.

### Test Setup

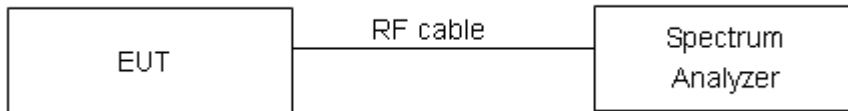

### Limits

Rule Part 15.247 (a) (2) specifies that “Systems using digital modulation techniques may operate in the 902–928 MHz, 2400–2483.5 MHz bands. The minimum 6 dB bandwidth shall be at least 500 kHz.”

minimum 6 dB bandwidth	≥ 500 kHz
------------------------	-----------

### Measurement Uncertainty

The assessed measurement uncertainty to ensure 95% confidence level for the normal distribution is with the coverage factor  $k = 2$ ,  $U = 936$  Hz.

**Test Results:**

Network Standards	Carrier frequency (MHz)	99% bandwidth (MHz)	Minimum 6 dB bandwidth (MHz)	Limit (kHz)	Conclusion
802.11b	2412	11.205	7.124	500	PASS
	2437	12.555	7.584	500	PASS
	2462	11.428	7.571	500	PASS
802.11g	2412	16.585	16.35	500	PASS
	2437	16.636	16.12	500	PASS
	2462	16.552	16.37	500	PASS
802.11n HT20	2412	17.698	17.33	500	PASS
	2437	17.719	17.32	500	PASS
	2462	17.687	17.61	500	PASS
Bluetooth (Low Energy)	2402	1.0856	0.6742	500	PASS
	2440	1.0858	0.6742	500	PASS
	2480	1.0857	0.6772	500	PASS



802.11b, Carrier frequency (MHz): 2412

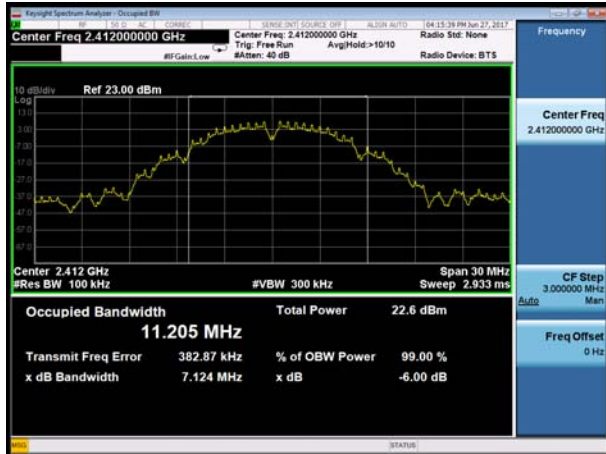

802.11g, Carrier frequency (MHz): 2412



802.11b, Carrier frequency (MHz): 2437



802.11g, Carrier frequency (MHz): 2437



802.11b, Carrier frequency (MHz): 2462



802.11g, Carrier frequency (MHz): 2462







802.11n(HT20), Carrier frequency (MHz): 2412



BLE Carrier frequency (MHz): 2402



802.11n(HT20), Carrier frequency (MHz): 2437



BLE Carrier frequency (MHz): 2440



802.11n(HT20), Carrier frequency (MHz):2462



BLE Carrier frequency (MHz): 2480



### 5.3. Band Edge

#### Ambient condition

Temperature	Relative humidity	Pressure
23°C ~25°C	45%~50%	101.5kPa

#### Method of Measurement

The EUT was connected to the spectrum analyzer through an external attenuator (20dB) and a known loss cable the band edge of the lowest and highest channels were measured. The peak detector is used and RBW is set to 100 kHz and VBW is set to 300 kHz on spectrum analyzer. Spectrum analyzer plots are included on the following pages.

#### Test Setup

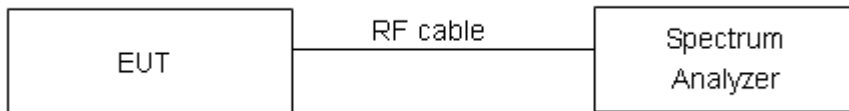

#### Limits

Rule Part 15.247(d) specifies that “In any 100 kHz bandwidth outside the frequency band in which the spread spectrum or digitally modulated intentional radiator is operating, the radio frequency power that is produced by the intentional radiator shall be at least 20 dB below that in the 100 kHz bandwidth within the band that contains the highest level of the desired power, based on either an RF conducted or a radiated measurement, provided the transmitter demonstrates compliance with the peak conducted power limits.”

#### Measurement Uncertainty

The assessed measurement uncertainty to ensure 95% confidence level for the normal distribution is with the coverage factor  $k = 1.96$ .

Frequency	Uncertainty
2GHz-3GHz	1.407 dB



Test Results: PASS

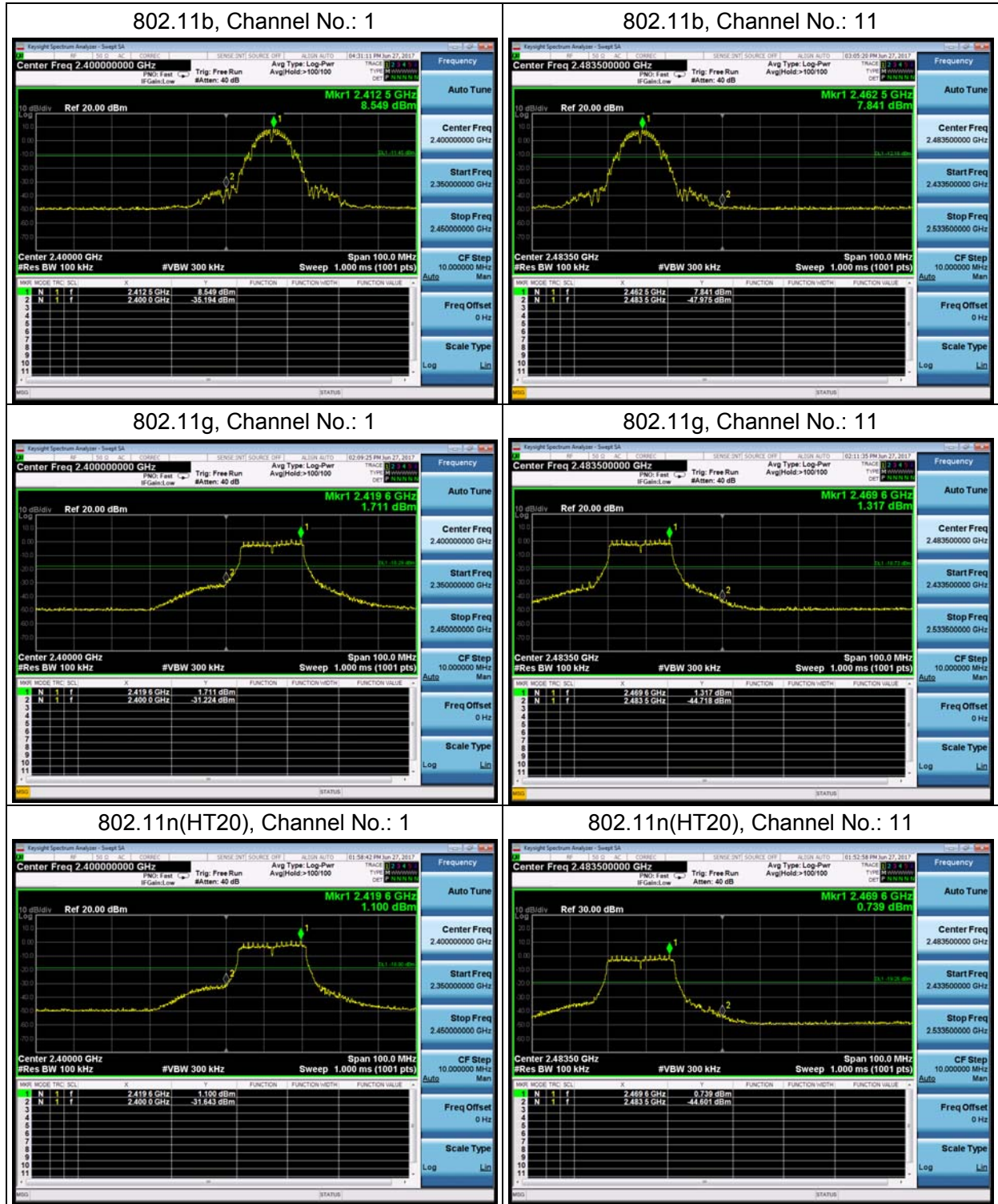

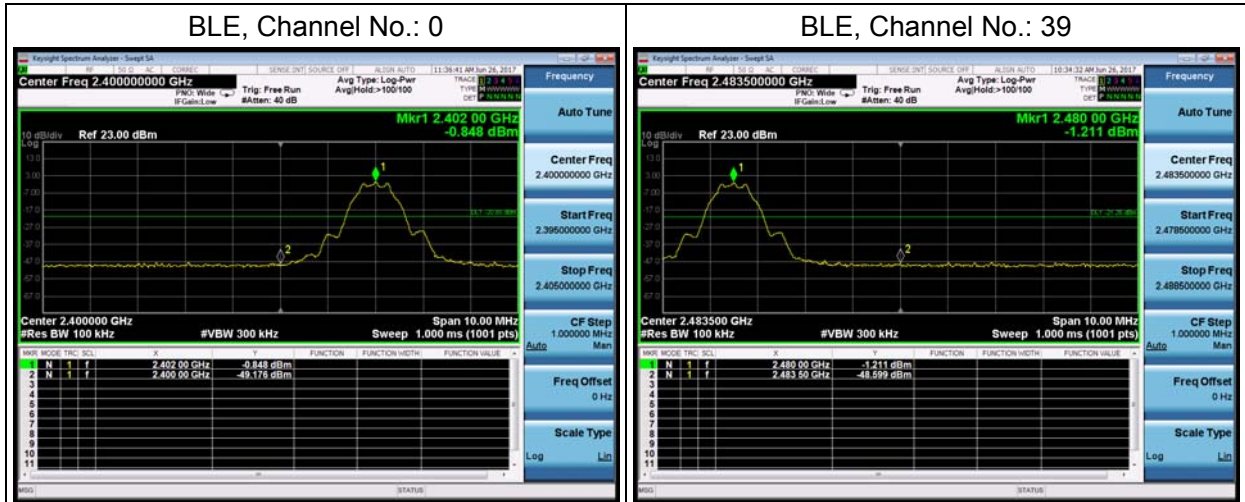

### 5.4. Power Spectral Density

#### Ambient condition

Temperature	Relative humidity	Pressure
23°C ~25°C	45%~50%	101.5kPa

#### Method of Measurement

The EUT was connected to the spectrum analyzer through an external attenuator (20dB) and a known loss cable.

RBW is set to 3 kHz and VBW is set to 10 kHz for BLE/ Wi-Fi 2.4G on spectrum analyzer.

Set the span to 1.5 times the DTS channel bandwidth. Sweep time = auto couple. Trace mode = max hold. The Average power spectral density is recorded.

#### Test setup

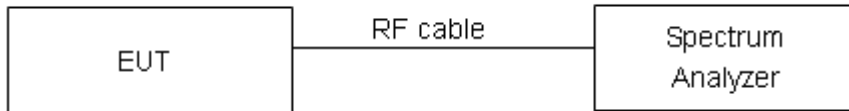

#### Limits

Rule Part 15.247(e) specifies that” For digitally modulated systems, the power spectral density conducted from the intentional radiator to the antenna shall not be greater than 8 dBm in any 3 kHz band during any time interval of continuous transmission. ”

Limits	≤ 8 dBm / 3kHz
--------	----------------

#### Measurement Uncertainty

The assessed measurement uncertainty to ensure 95% confidence level for the normal distribution is with the coverage factor  $k = 2$ ,  $U = 0.75\text{dB}$ .

**Test Results:**

Network Standards	Channel Number	Power Spectral Density (dBm / 3kHz)	Limit (dBm / 3kHz)	Conclusion
802.11b	1	-16.409	8	PASS
	6	-14.833	8	PASS
	11	-15.954	8	PASS
802.11g	1	-22.497	8	PASS
	6	-20.281	8	PASS
	11	-22.798	8	PASS
802.11n HT20	1	-23.619	8	PASS
	6	-21.259	8	PASS
	11	-23.499	8	PASS
Bluetooth (Low Energy)	0	-20.025	8	PASS
	19	-20.252	8	PASS
	39	-20.510	8	PASS



802.11b, Channel No.: 1



802.11g, Channel No.: 1

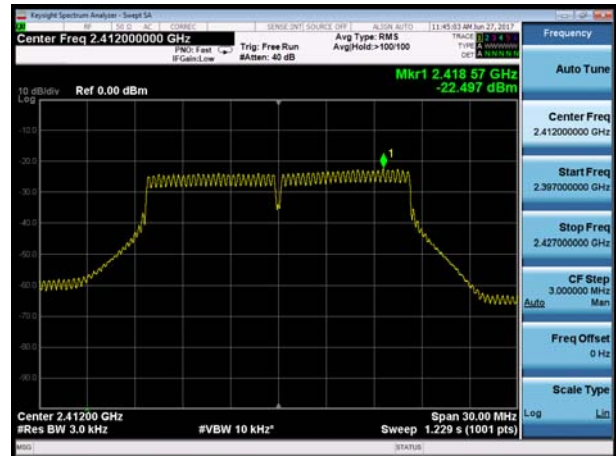

802.11b, Channel No.: 6



802.11g, Channel No.: 6



802.11b, Channel No.: 11



802.11g, Channel No.: 11





802.11n(HT20), Channel No. 1

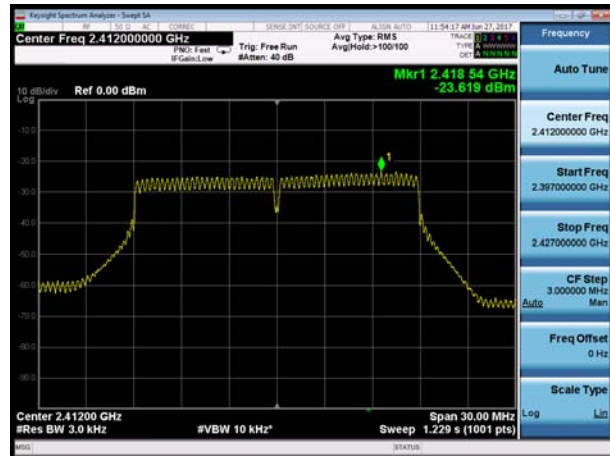

BLE, Channel No.: 0



802.11n(HT20), Channel No. 6

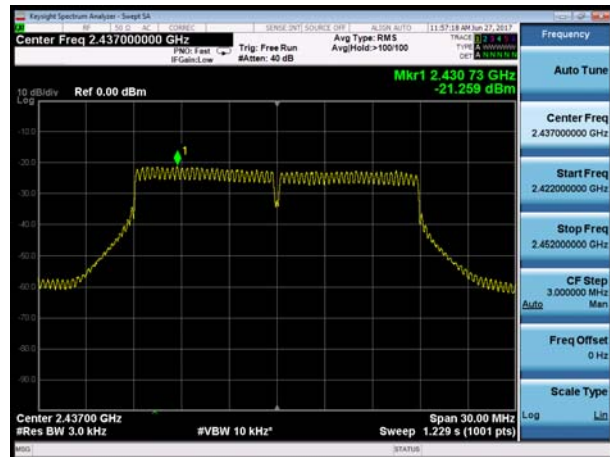

BLE, Channel No.: 19

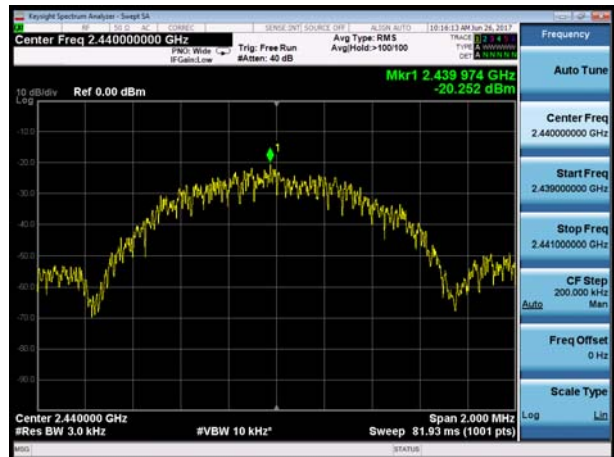

802.11n(HT20), Channel No. 11

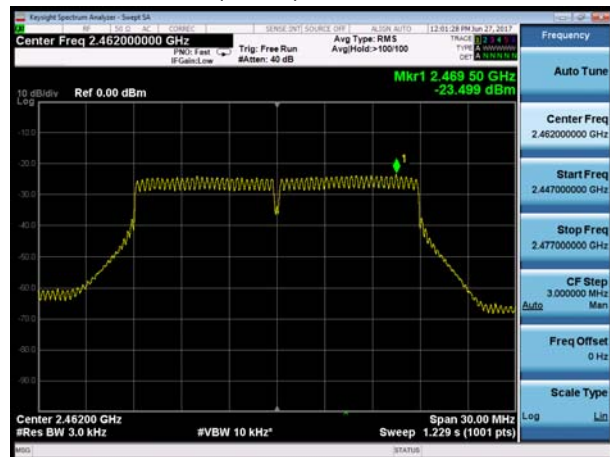

BLE, Channel No.: 39





### 5.5. Spurious RF Conducted Emissions

#### Ambient condition

Temperature	Relative humidity	Pressure
23°C ~25°C	45%~50%	101.5kPa

#### Method of Measurement

The EUT was connected to the spectrum analyzer with a known loss. The spectrum analyzer scans from 30MHz to the 10th harmonic of the carrier. The peak detector is used. Set RBW to100kHz and VBW to 300 kHz, Sweep is set to ATUO.

The test is in transmitting mode.

#### Test setup



#### Limits

Rule Part 15.247(d) pacifies that “In any 100 kHz bandwidth outside the frequency band in which the spread spectrum intentional radiator is operating, the radio frequency power that is produced by the intentional radiator shall be at least 20 dB below that in the 100 kHz bandwidth within the band that contains the highest level of the desired power.”

Network Standards	Carrier frequency (MHz)	Reference value (dBm)	Limit
802.11b	2412	5.559	-14.441
	2437	7.318	-12.682
	2462	5.063	-14.937
802.11g	2412	0.287	-19.713
	2437	1.005	-18.995
	2462	0.435	-19.565
802.11n HT20	2412	-1.791	-21.791
	2437	-0.090	-20.090
	2462	-3.941	-23.941
Bluetooth (Low Energy)	2402	-4.005	-24.005
	2440	-3.532	-23.532
	2480	-3.947	-23.947

### Measurement Uncertainty

The assessed measurement uncertainty to ensure 95% confidence level for the normal distribution is with the coverage factor  $k = 1.96$ .

Frequency	Uncertainty
100kHz-2GHz	0.684 dB
2GHz-26GHz	1.407 dB



**Test Results:**

If disturbances were found more than 20dB below limit line, the mark is not required for the EUT.  
The signal beyond the limit is carrier.

802.11b CH1 30MHz to 18GHz

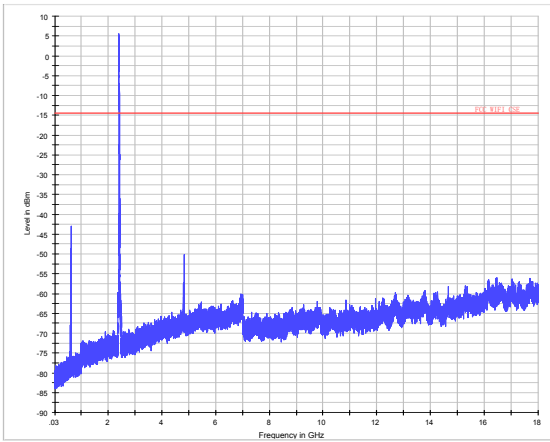

802.11b CH1 18GHz to 26.5GHz

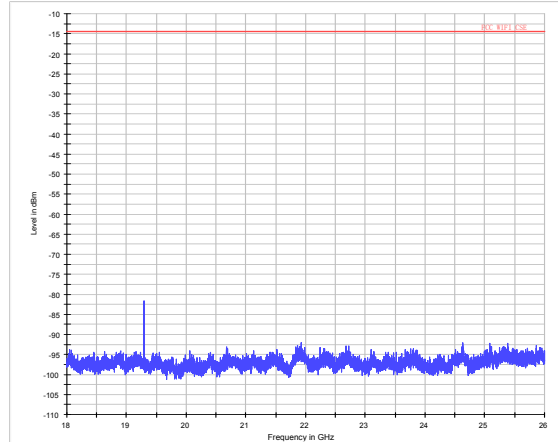

802.11b CH6 30MHz to 18GHz

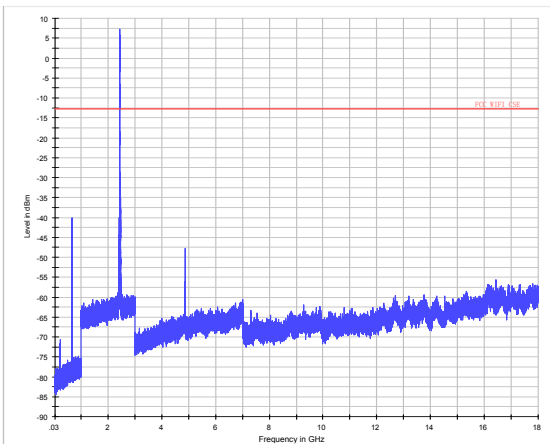

802.11b CH6 18GHz to 26.5GHz

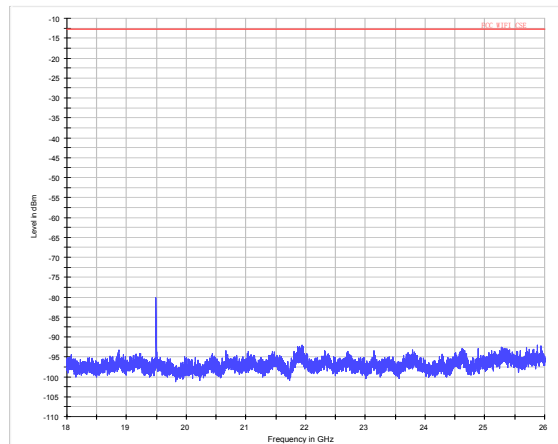

802.11b CH11 30MHz to 18GHz

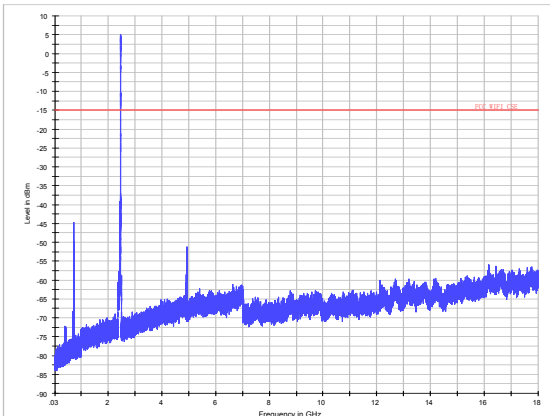

802.11b CH11 18GHz to 26.5GHz

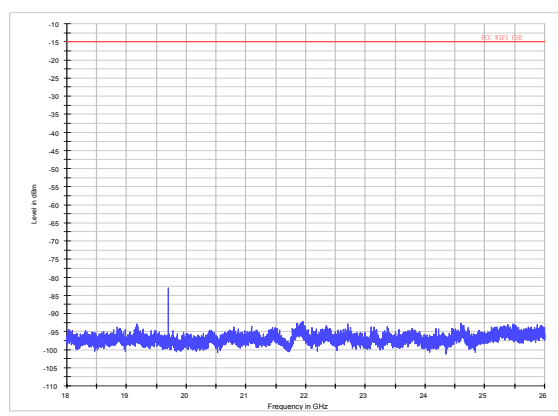



802.11g CH1 30MHz to 18GHz

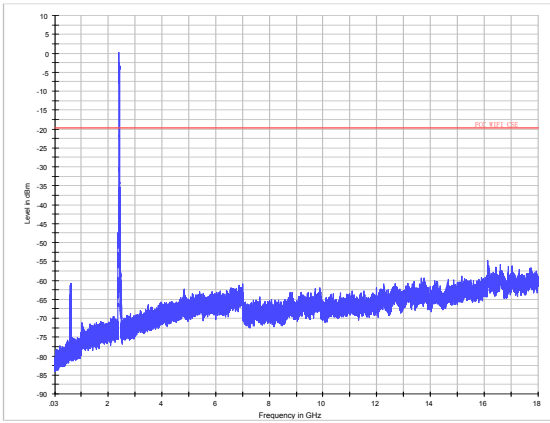

802.11g CH1 18GHz to 26.5GHz

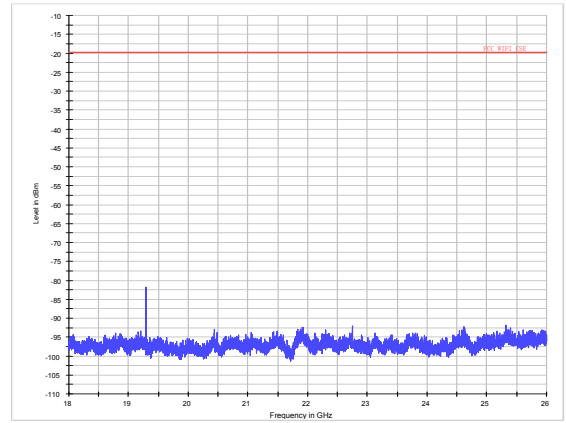

802.11g CH6 30MHz to 18GHz

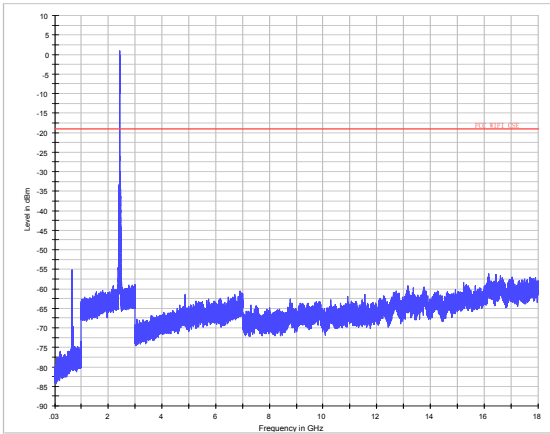

802.11g CH6 18GHz to 26.5GHz

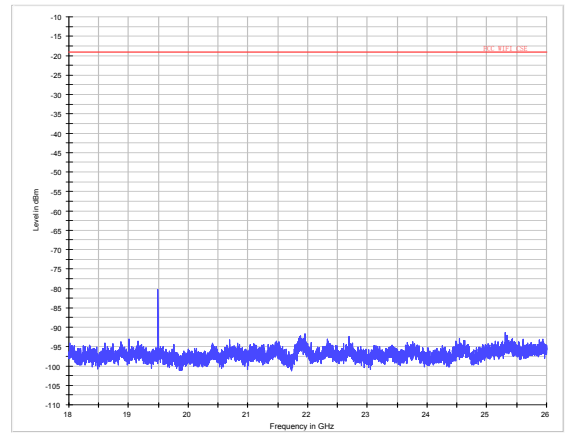

802.11g CH11 30MHz to 18GHz

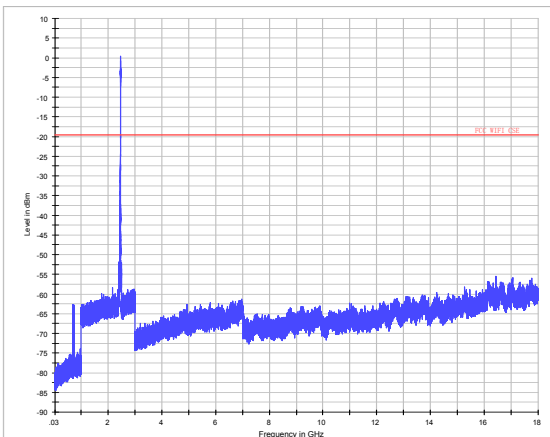

802.11g CH11 18GHz to 26.5GHz

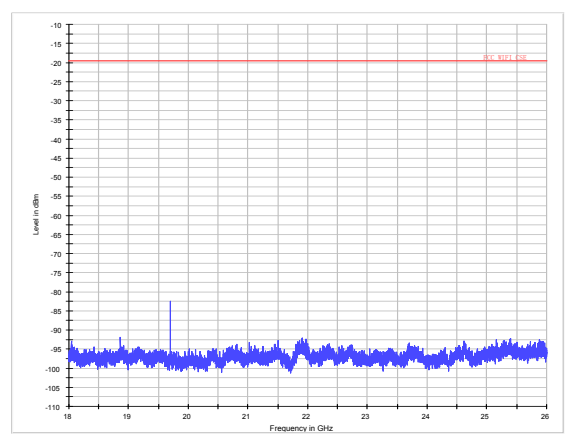



802.11n (HT20) CH1 30MHz to 18GHz

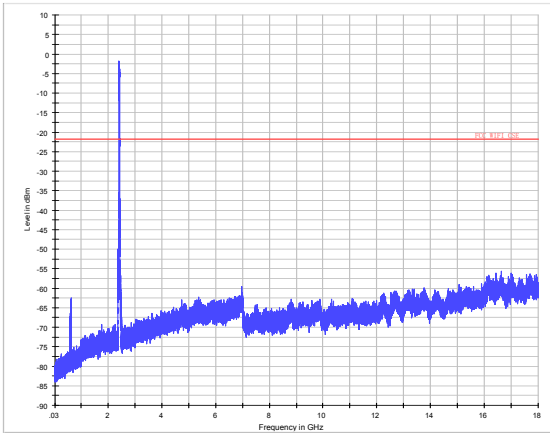

802.11n (HT20) CH1 18GHz to 26.5GHz

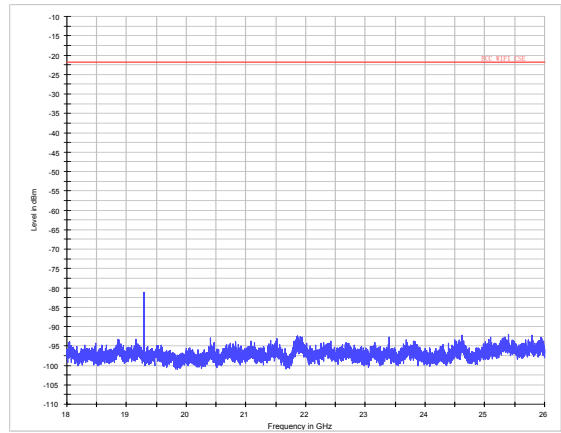

802.11n (HT20) CH6 30MHz to 18GHz

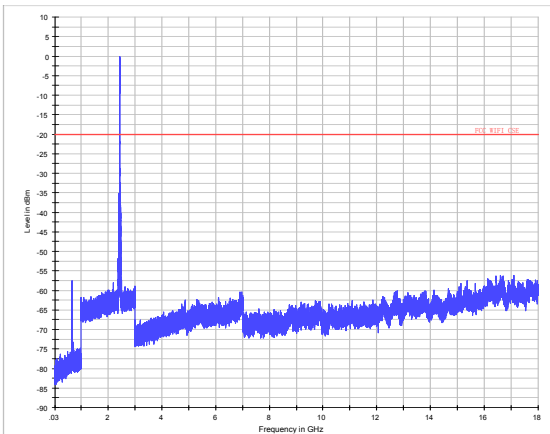

802.11n (HT20) CH6 18GHz to 26.5GHz

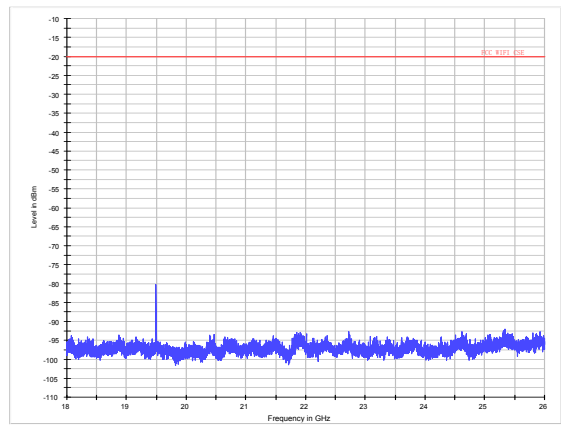

802.11n (HT20) CH11 30MHz to 18GHz

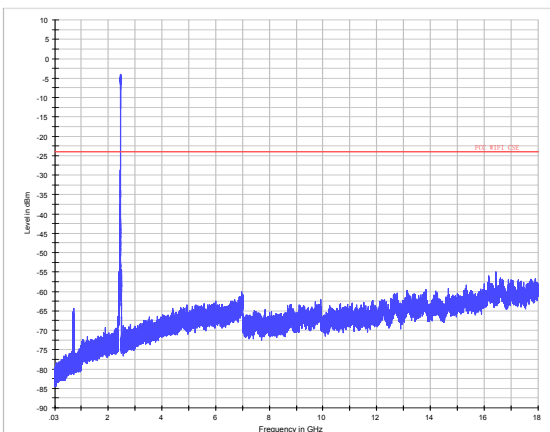

802.11n (HT20) CH11 18GHz to 26.5GHz

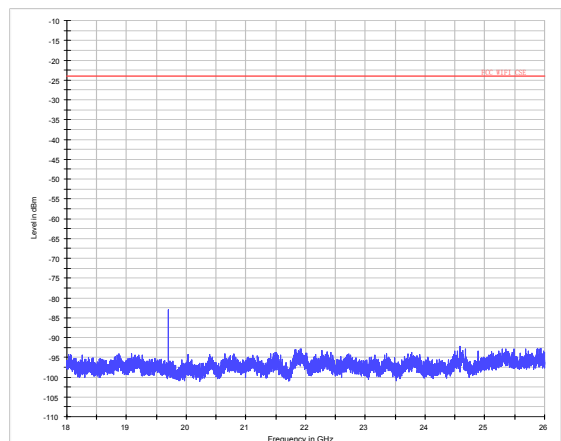



BLE CH0 30MHz to 18GHz

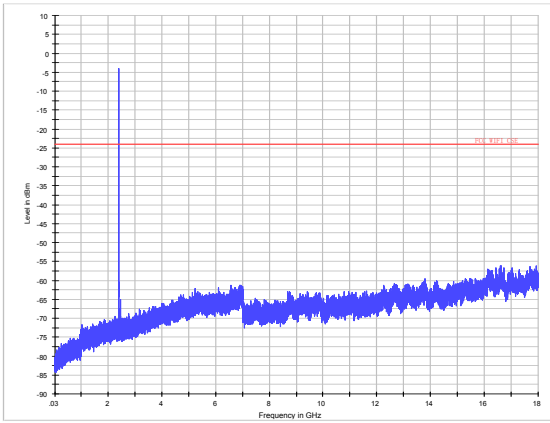

BLE CH0 18GHz to 26.5GHz

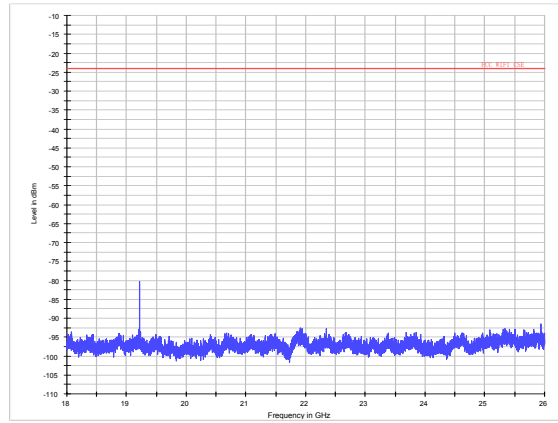

BLE CH19 30MHz to 18GHz

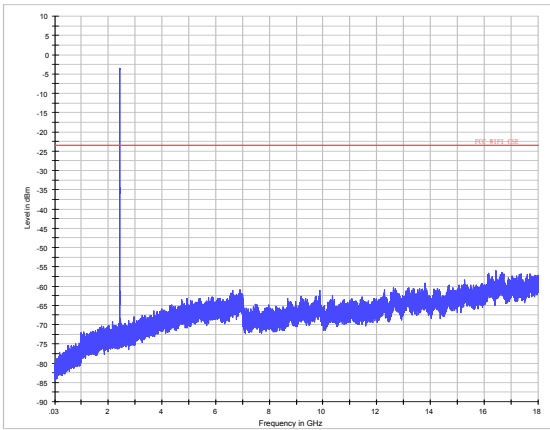

BLE CH19 18GHz to 26.5GHz

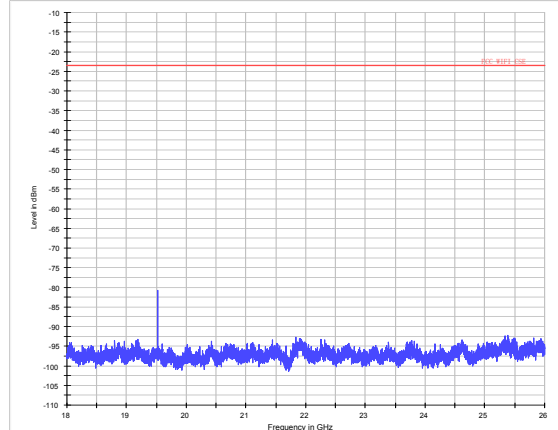

BLE CH39 30MHz to 18GHz

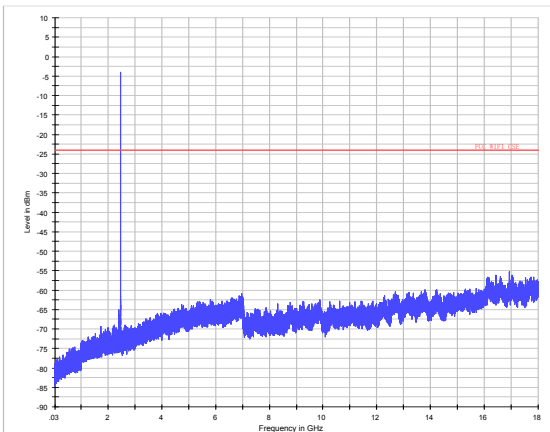

BLE CH39 18GHz to 18GHz

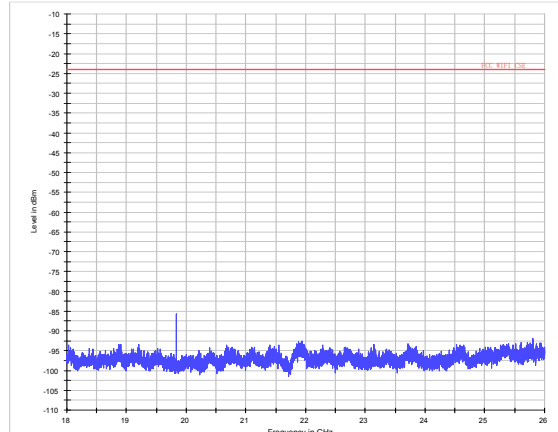

## 5.6. Radiated Emissions in the Restricted Band

### Ambient condition

Temperature	Relative humidity	Pressure
23°C ~25°C	45%~50%	101.5kPa

### Method of Measurement

The Equipment Under Test (EUT) was set up on a non-conductive table in the semi-anechoic chamber. The test was performed at the distance of 3 m between the EUT and the receiving antenna. The turntable shall be rotated from 0 to 360 degrees for detecting the maximum of radiated spurious signal level. The measurements shall be repeated with orthogonal polarization of the test antenna. RBW is set to 100kHz. The data of cable loss and antenna factor has been calibrated in full testing frequency range before the testing. Sweep the whole frequency band through the range from 9kHz to the 10th harmonic of the carrier, and the emissions less than 20 dB below the permissible value are reported.

Set the spectrum analyzer in the following:

- (a) PEAK: RBW=1MHz /VBW=3MHz / Sweep=AUTO
- (b) AVERAGE: RBW=1MHz /VBW=3MHz / Sweep=AUTO

This setting method can refer to **KDB 558074**.

The field strength of spurious emission was measured in the following position: EUT stand-up position (Z axis), lie-down position (X, Y axis). The worst emission was found in stand-up position (Y axis) and the antenna is vertical.

The test is in transmitting mode.

### Test setup

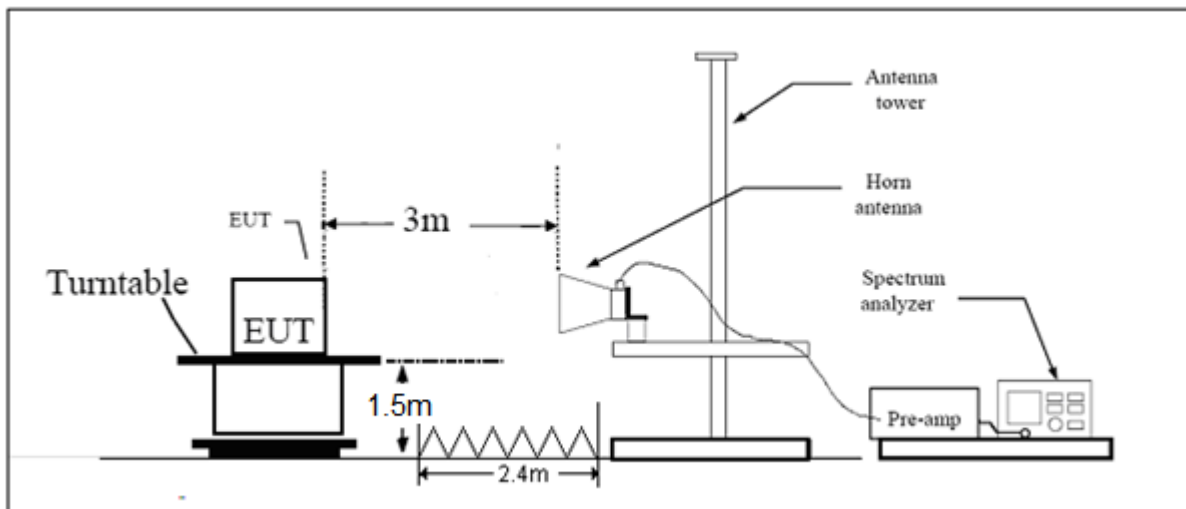

Note: Area side: 2.4mX3.6m

**Limits**

Spurious Radiated Emissions are permitted in any of the frequency bands listed below:

MHz	MHz	MHz	GHz
0.090 - 0.110	16.42 - 16.423	399.9 - 410	4.5 - 5.15
<sup>1</sup> 0.495 - 0.505	16.69475 - 16.69525	608 - 614	5.35 - 5.46
2.1735 - 2.1905	16.80425 - 16.80475	960 - 1240	7.25 - 7.75
4.125 - 4.128	25.5 - 25.67	1300 - 1427	8.025 - 8.5
4.17725 - 4.17775	37.5 - 38.25	1435 - 1626.5	9.0 - 9.2
4.20725 - 4.20775	73 - 74.6	1645.5 - 1646.5	9.3 - 9.5
6.215 - 6.218	74.8 - 75.2	1660 - 1710	10.6 - 12.7
6.26775 - 6.26825	108 - 121.94	1718.8 - 1722.2	13.25 - 13.4
6.31175 - 6.31225	123 - 138	2200 - 2300	14.47 - 14.5
8.291 - 8.294	149.9 - 150.05	2310 - 2390	15.35 - 16.2
8.362 - 8.366	156.52475 - 156.52525	2483.5 - 2500	17.7 - 21.4
8.37625 - 8.38675	156.7 - 156.9	2690 - 2900	22.01 - 23.12
8.41425 - 8.41475	162.0125 - 167.17	3260 - 3267	23.6 - 24.0
12.29 - 12.293	167.72 - 173.2	3332 - 3339	31.2 - 31.8
12.51975 - 12.52025	240 - 285	3345.8 - 3358	36.43 - 36.5
12.57675 - 12.57725	322 - 335.4	3600 - 4400	( <sup>2</sup> )
13.36 - 13.41			

Limit in restricted band

Frequency of emission (MHz)	Field strength(uV/m)	Field strength(dBuV/m)
30-88	100	40
88-216	150	43.5
216-960	200	46
Above960	500	54

§15.35(b)

There is also a limit on the radio frequency emissions, as measured using instrumentation with a peak detector function, corresponding to 20 dB above the maximum permitted average limit.

Peak Limit=74 dBuV/m

Average Limit=54 dBuV/m

**Measurement Uncertainty**

The assessed measurement uncertainty to ensure 95% confidence level for the normal distribution is with the coverage factor  $k = 1.96$ ,  $U = 3.55$  dB.





**Test Results:**

**PASS**

The signal beyond the limit is carrier.

**802.11b-Channel 1: Peak**

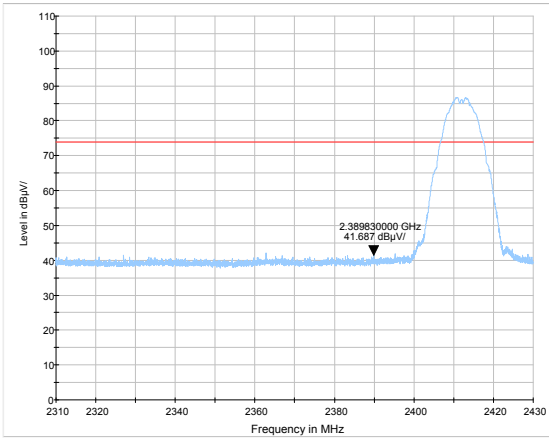

**802.11b-Channel 11: Peak**

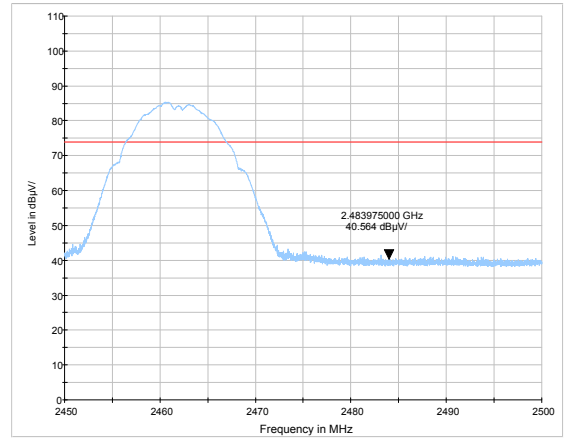

**802.11b-Channel 1: Average**

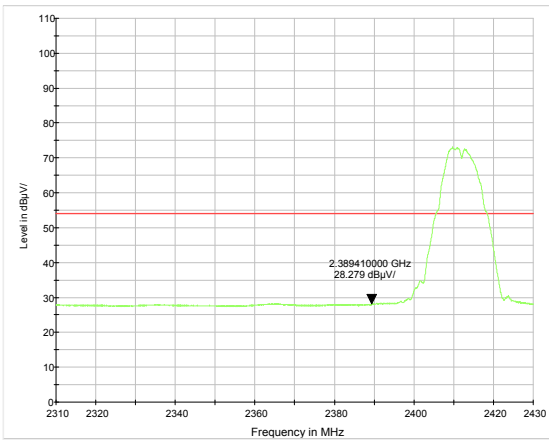

**802.11b-Channel 11: Average**

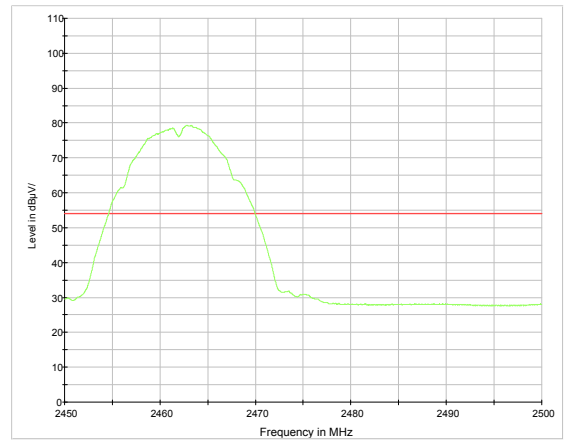

**802.11g-Channel 1: Peak**

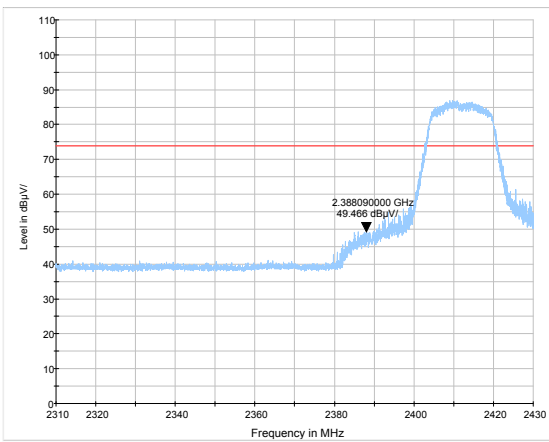

**802.11g-Channel 11: Peak**

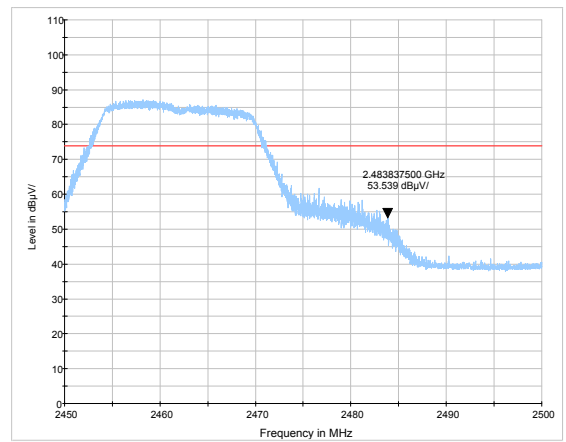



802.11g-Channel 1: Average

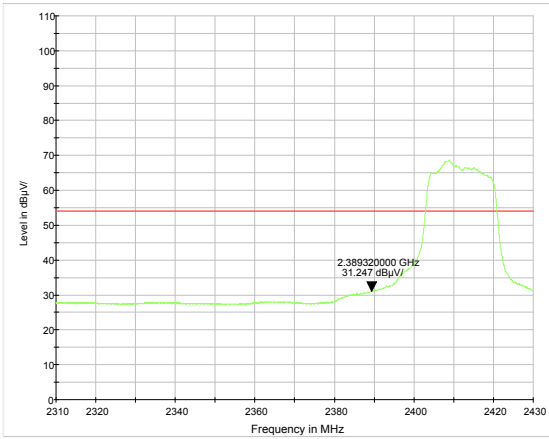

802.11g-Channel 11: Average

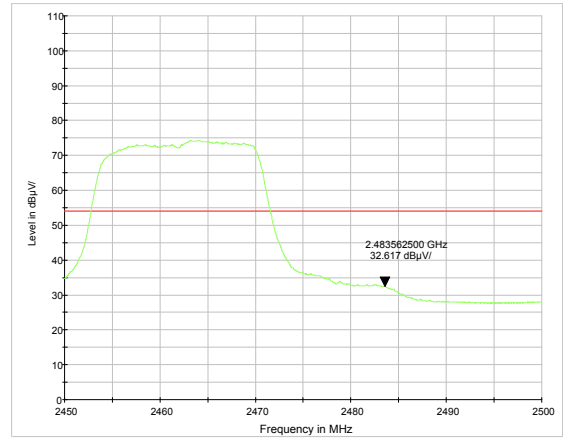

802.11n HT20 -Channel 1: Peak

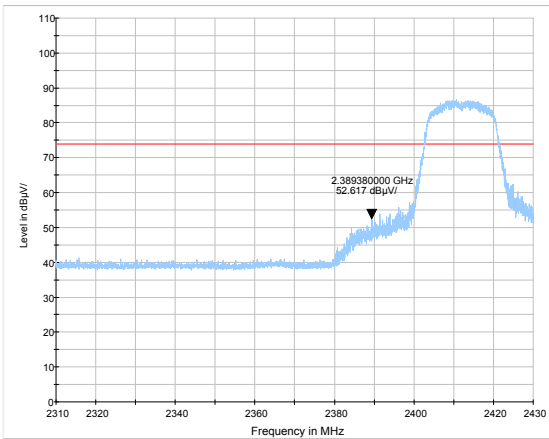

802.11n HT20-Channel 11: Peak

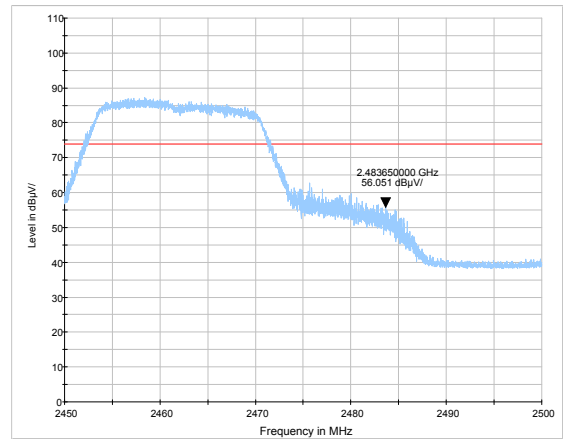

802.11n HT20-Channel 1: Average

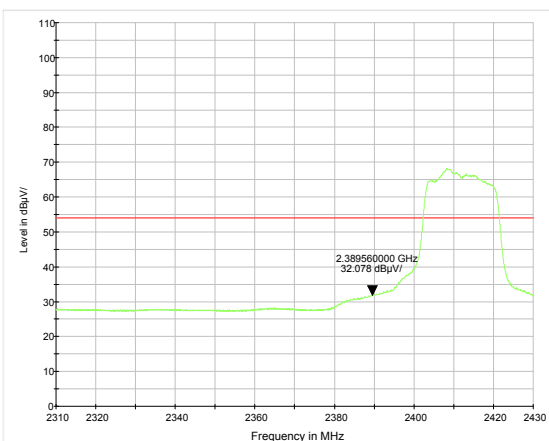

802.11n HT20-Channel 11: Average

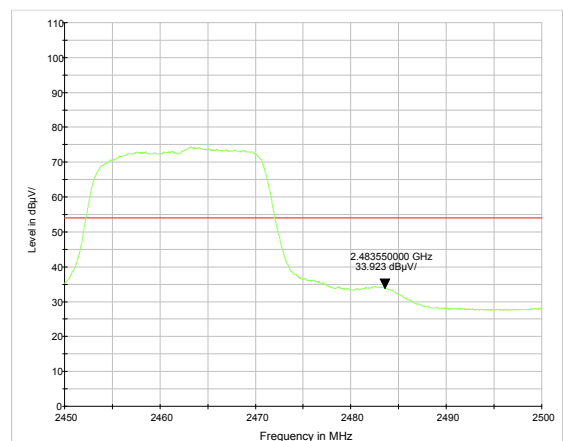



**BLE -Channel 0: Peak**

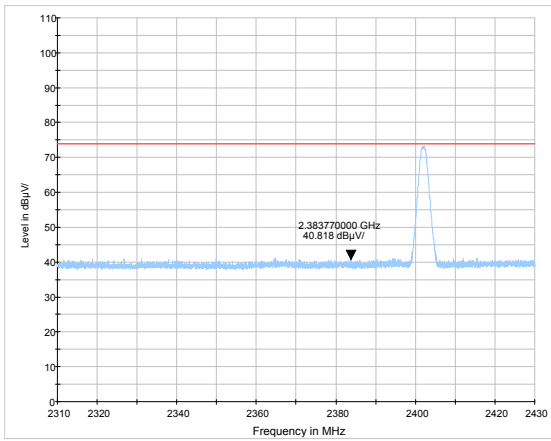

**BLE -Channel 39: Peak**

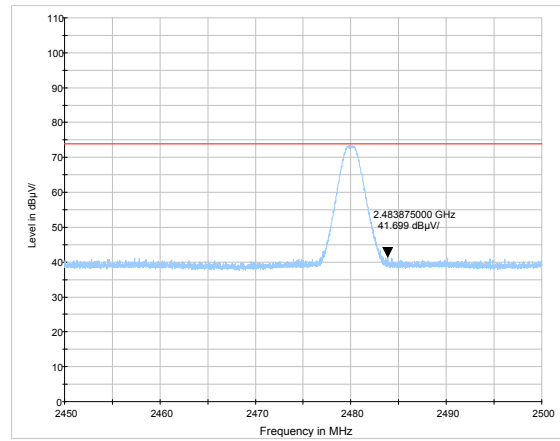

**BLE -Channel 0: Average**

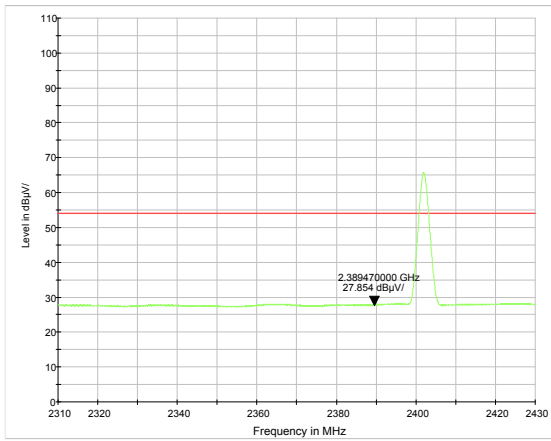

**BLE -Channel 39: Average**

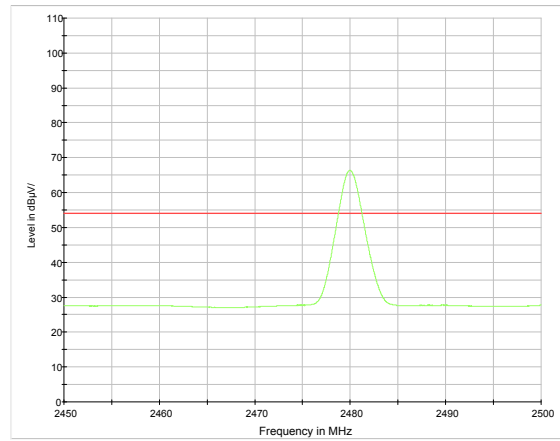

## 5.7. Radiates Emission

### Ambient condition

Temperature	Relative humidity	Pressure
23°C ~25°C	45%~50%	102.5kPa

### Method of Measurement

The test set-up was made in accordance to the general provisions of ANSI C63.10-2013. The Equipment Under Test (EUT) was set up on a non-conductive table in the semi-anechoic chamber. The test was performed at the distance of 3 m between the EUT and the receiving antenna. The radiated emissions measurements were made in a typical installation configuration.

Sweep the whole frequency band through the range from 9 kHz to the 10th harmonic of the carrier, and the emissions less than 20 dB below the permissible value are reported.

During the test, below 30MHz, the center of the loop shall be 1 meters; above 30MHz, the height of receive antenna shall be moved from 1 to 4 meters, and the antenna shall be performed under horizontal and vertical polarization. The turntable shall be rotated from 0 to 360 degrees for detecting the maximum of radiated spurious signal level. The measurements shall be repeated with orthogonal polarization of the test antenna. The data of cable loss and antenna factor has been calibrated in full testing frequency range before the testing.

Set the spectrum analyzer in the following:

Below 1GHz (detector: Peak and Quasi-Peak)

RBW=100 kHz / VBW=300 kHz / Sweep=AUTO

Above 1GHz (detector: Peak):

(a) PEAK: RBW=1MHz / VBW=3MHz/ Sweep=AUTO

(b) AVERAGE: RBW=1MHz / VBW=3MHz / Sweep=AUTO

The radiated emission was measured in the following position: EUT stand-up position (Z axis), lie-down position (X, Y axis). The worst emission was found in stand-up position (Z axis) and the worst case was recorded.

The test is in transmitting mode.

**Test setup**

**9KHz ~ 30MHz**

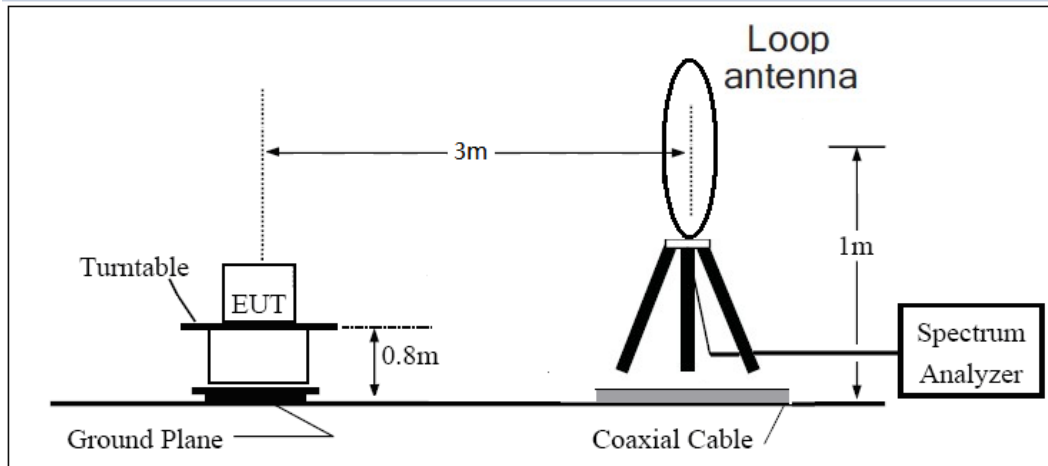

**30MHz ~ 1GHz**

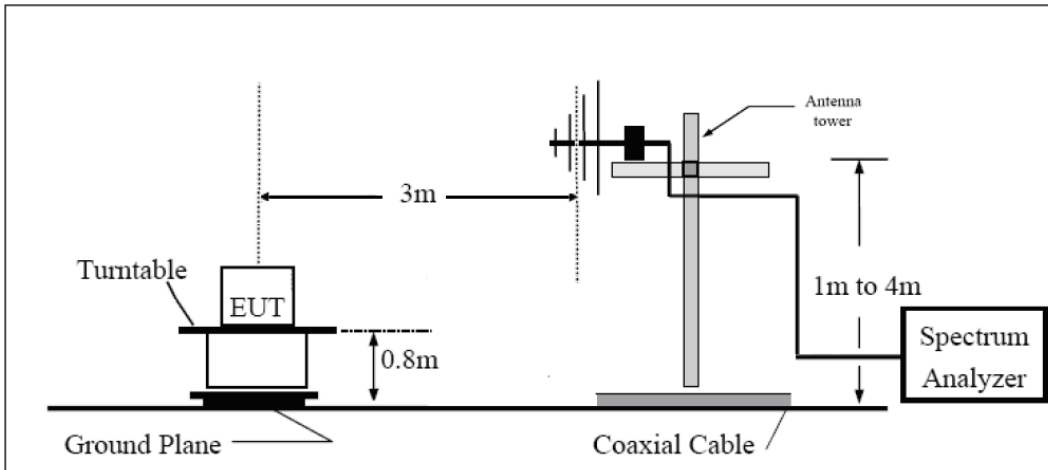

**Above 1GHz**

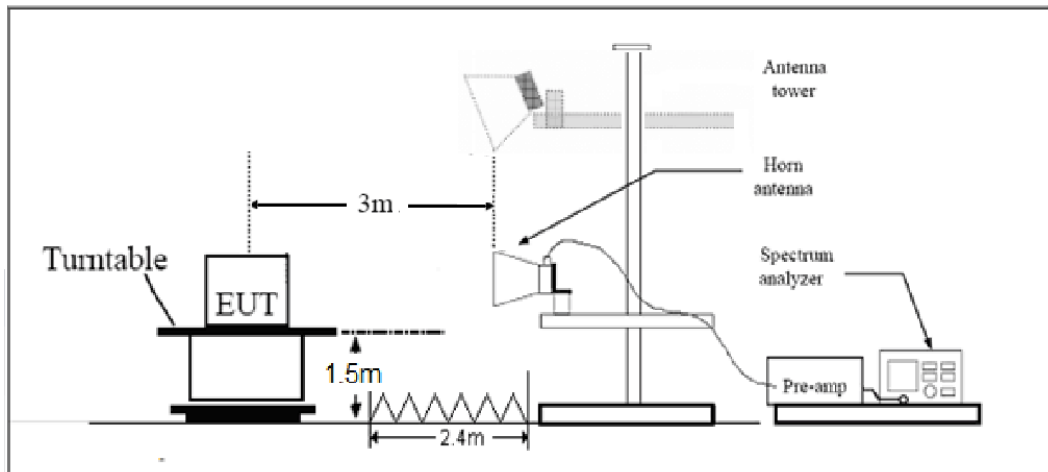

Note: Area side:2.4mX3.6m

**Limits**

Rule Part 15.247(d) specifies that “In addition, radiated emissions which fall in the restricted bands, as defined in § 15.205(a), must also comply with the radiated emission limits specified in § 15.209(a) (see § 15.205(c)).”

Limit in restricted band

Frequency of emission (MHz)	Field strength(uV/m)	Field strength(dBuV/m)
0.009–0.490	2400/F(kHz)	/
0.490–1.705	24000/F(kHz)	/
1.705–30.0	30	/
30-88	100	40
88-216	150	43.5
216-960	200	46
Above960	500	54

## §15.35(b)

There is also a limit on the radio frequency emissions, as measured using instrumentation with a peak detector function, corresponding to 20 dB above the maximum permitted average limit.

**Measurement Uncertainty**

The assessed measurement uncertainty to ensure 95% confidence level for the normal distribution is with the coverage factor  $k = 1.96$ .

Frequency	Uncertainty
9KHz-30MHz	3.55 dB
30MHz-200MHz	4.19 dB
200MHz-1GHz	3.63 dB
Above 1GHz	3.68 dB



**Test result**

Sweep from 9 kHz to 30MHz, and the emissions more than 20 dB below the permissible value are not reported.

The following graphs display the maximum values of horizontal and vertical by software.

For above 1GHz, Blue trace uses the peak detection, Green trace uses the average detection.

**Continuous TX mode:**

FCC RE 0.03-1GHz QP Class B

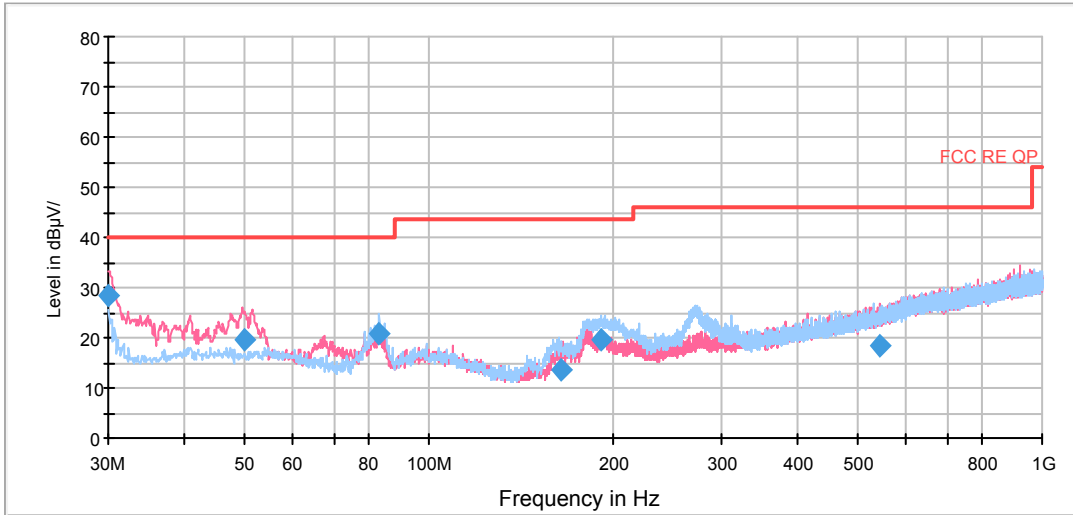

Radiates Emission from 30MHz to 1GHz



802.11b CH1

Frequency (MHz)	Peak (dBuV/m)	Height (cm)	Polarization	Azimuth (deg)	Reading value (dBuV/m)	Correct Factor (dB)	Margin (dB)	Limit (dBuV/m)
1076.500000	44.2	100.0	H	128.0	52.1	-7.9	29.8	74
1342.500000	38.5	100.0	V	312.0	45.6	-7.1	35.5	74
1576.000000	43.5	100.0	V	300.0	49.8	-6.3	30.5	74
1793.000000	44.4	100.0	V	221.0	49.9	-5.5	29.6	74
2245.500000	40.3	100.0	V	140.0	44.1	-3.8	33.7	74
2881.500000	42.1	100.0	H	5.0	44.6	-2.5	31.9	74

Remark: 1. Correction Factor = Antenna factor+ Insertion loss (cable loss + amplifier gain)

Frequency (MHz)	Average (dBuV/m)	Height (cm)	Polarization	Azimuth (deg)	Reading value (dBuV/m)	Correct Factor (dB)	Margin (dB)	Limit (dBuV/m)
1199.500000	27.5	100.0	V	352.0	35.1	-7.6	26.5	54
1437.500000	27.6	100.0	H	8.0	34.4	-6.8	26.4	54
1576.000000	28.5	100.0	V	300.0	34.8	-6.3	25.5	54
2053.000000	29.7	100.0	H	185.0	34.3	-4.6	24.3	54
2487.000000	29.6	100.0	V	267.0	32.5	-2.9	24.4	54
2766.000000	30.6	100.0	V	210.0	33.2	-2.6	23.4	54

Remark: 1. Correction Factor = Antenna factor+ Insertion loss (cable loss + amplifier gain)

FCC RE 1G-3GHz PK+AV Class B

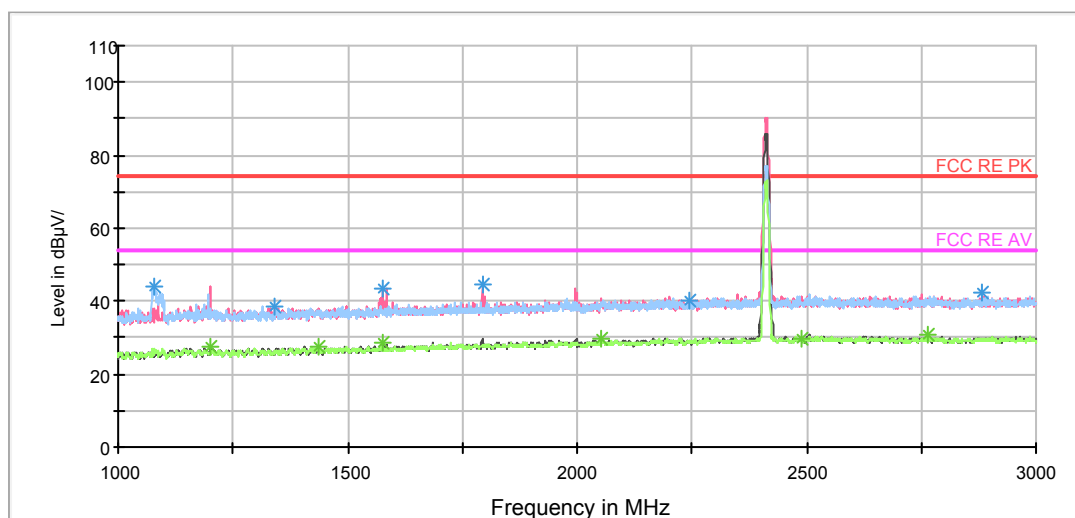

Note: The signal beyond the limit is carrier.

Radiates Emission from 1GHz to 3GHz



RE 1G-18GHz PK+AV Class B

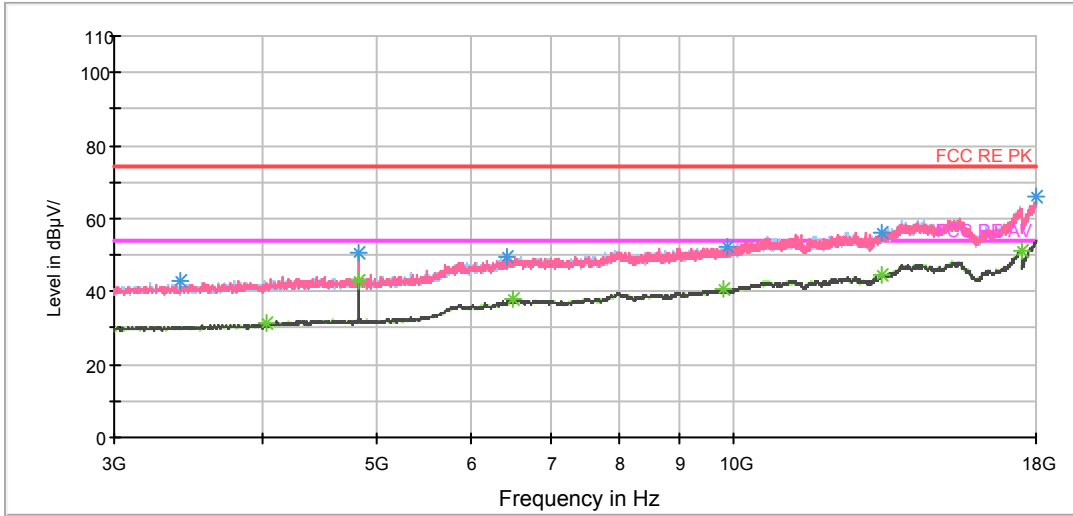

Radiates Emission from 3GHz to 18GHz

RE 18-26.5GHz PK+AV

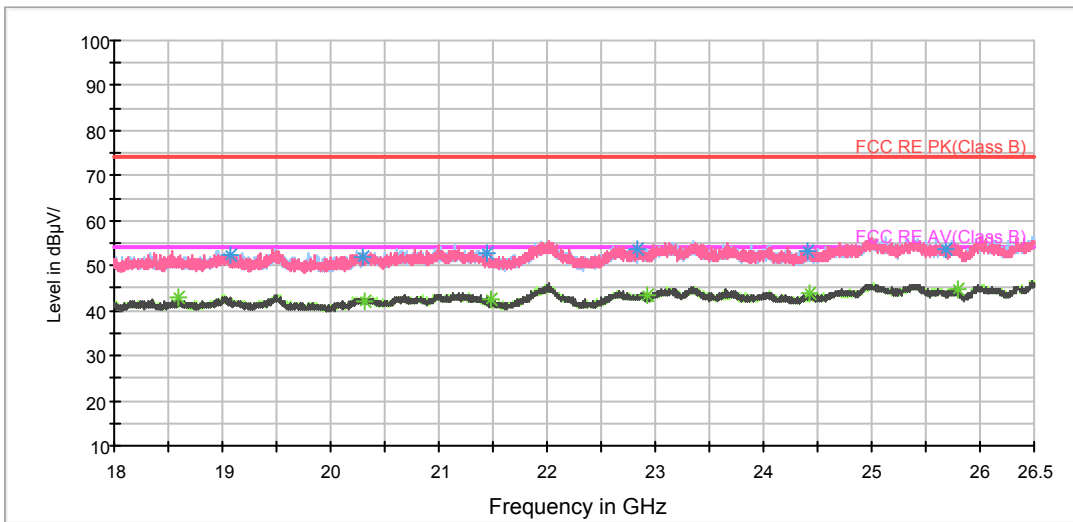

Radiates Emission from 18GHz to 26.5GHz



802.11b CH6

Frequency (MHz)	Peak (dBuV/m)	Height (cm)	Polarization	Azimuth (deg)	Reading value (dBuV/m)	Correct Factor (dB)	Margin (dB)	Limit (dBuV/m)
1199.500000	43.2	100.0	V	0.0	50.8	-7.6	30.8	74
1418.500000	37.8	100.0	H	48.0	44.7	-6.9	36.2	74
1678.000000	39.0	100.0	H	327.0	45.0	-6.0	35.0	74
1997.000000	43.6	100.0	V	356.0	48.4	-4.8	30.4	74
2534.000000	41.1	100.0	V	266.0	43.9	-2.8	32.9	74
2811.000000	40.2	100.0	H	139.0	42.8	-2.6	33.8	74

Remark: 1. Correction Factor = Antenna factor+ Insertion loss (cable loss + amplifier gain)

Frequency (MHz)	Average (dBuV/m)	Height (cm)	Polarization	Azimuth (deg)	Reading value (dBuV/m)	Correct Factor (dB)	Margin (dB)	Limit (dBuV/m)
1143.500000	26.5	100.0	H	12.0	34.2	-7.7	27.5	54
1421.000000	26.7	100.0	H	0.0	33.6	-6.9	27.3	54
1672.000000	27.7	100.0	V	341.0	33.7	-6.0	26.3	54
2058.500000	29.3	100.0	V	128.0	33.9	-4.6	24.7	54
2508.000000	30.2	100.0	H	12.0	33.0	-2.8	23.8	54
2844.500000	29.4	100.0	H	0.0	32.0	-2.6	24.6	54

Remark: 1. Correction Factor = Antenna factor+ Insertion loss (cable loss + amplifier gain)

FCC RE 1G-3GHz PK+AV Class B

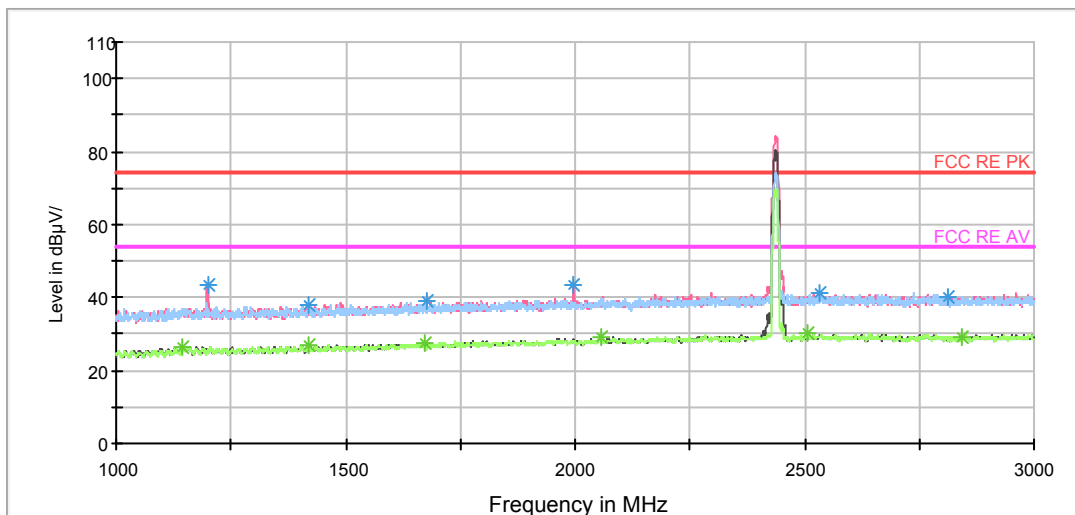

Note: The signal beyond the limit is carrier.  
Radiates Emission from 1GHz to 3GHz

RE 1G-18GHz PK+AV Class B

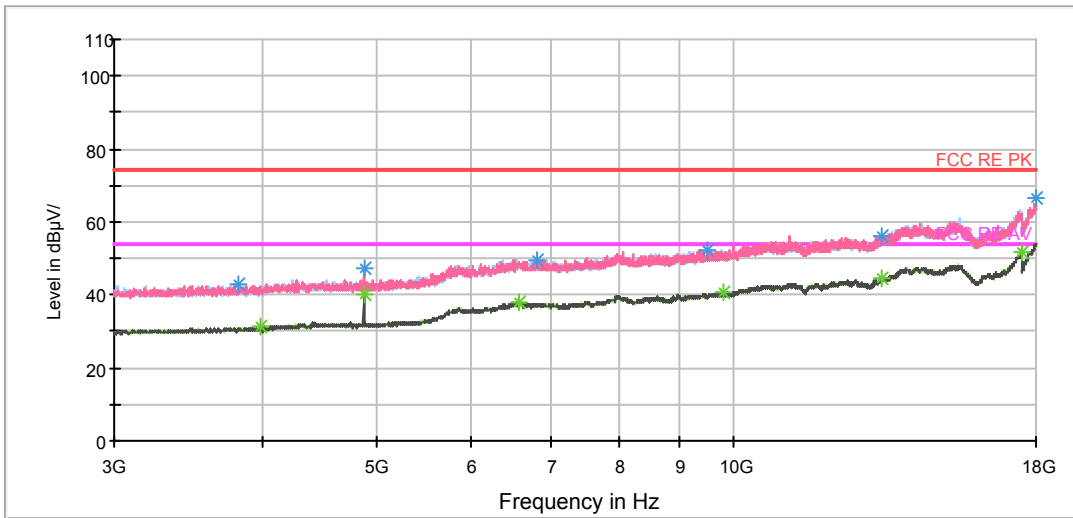

Radiates Emission from 3GHz to 18GHz

RE 18-26.5GHz PK+AV

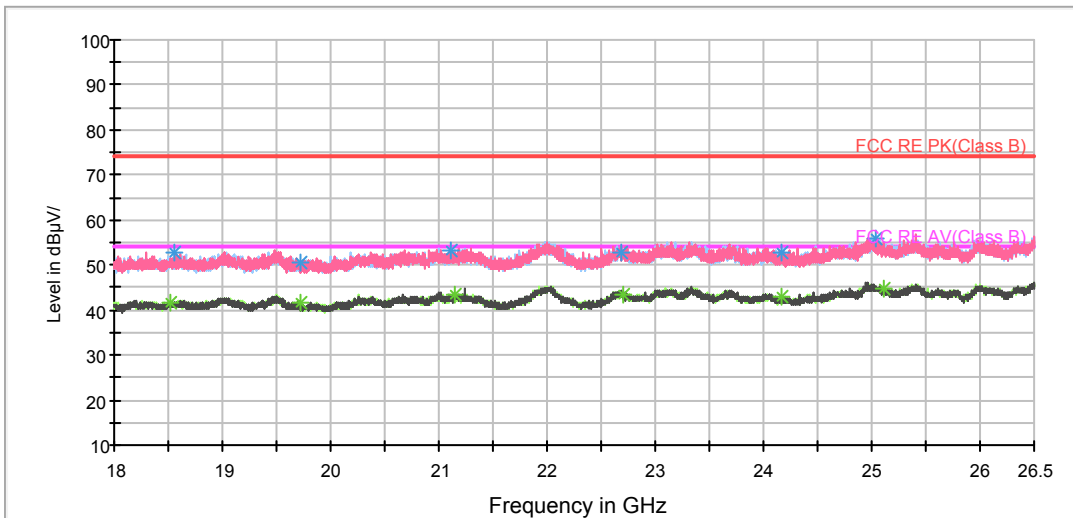

Radiates Emission from 18GHz to 26.5GHz



802.11b CH11

Frequency (MHz)	Peak (dBuV/m)	Height (cm)	Polarization	Azimuth (deg)	Reading value (dBuV/m)	Correct Factor (dB)	Margin (dB)	Limit (dBuV/m)
1198.000000	42.4	100.0	V	355.0	50.0	-7.6	31.6	74
1360.500000	38.3	100.0	H	50.0	45.4	-7.1	35.7	74
1671.000000	38.5	100.0	H	61.0	44.5	-6.0	35.5	74
1997.000000	41.2	100.0	V	256.0	46.0	-4.8	32.8	74
2366.500000	39.7	100.0	H	107.0	43.0	-3.3	34.3	74
2767.500000	41.4	100.0	V	355.0	44.0	-2.6	32.6	74

Remark: 1. Correction Factor = Antenna factor+ Insertion loss (cable loss + amplifier gain)

Frequency (MHz)	Average (dBuV/m)	Height (cm)	Polarization	Azimuth (deg)	Reading value (dBuV/m)	Correct Factor (dB)	Margin (dB)	Limit (dBuV/m)
1142.000000	26.5	100.0	H	50.0	34.2	-7.7	27.5	54
1205.000000	27.3	100.0	V	0.0	34.8	-7.5	26.7	54
1719.000000	27.5	100.0	H	220.0	33.3	-5.8	26.5	54
1980.000000	28.9	100.0	V	268.0	33.8	-4.9	25.1	54
2364.000000	29.3	100.0	H	20.0	32.6	-3.3	24.7	54
2641.000000	30.0	100.0	V	292.0	32.7	-2.7	24.0	54

Remark: 1. Correction Factor = Antenna factor+ Insertion loss (cable loss + amplifier gain)

FCC RE 1G-3GHz PK+AV Class B

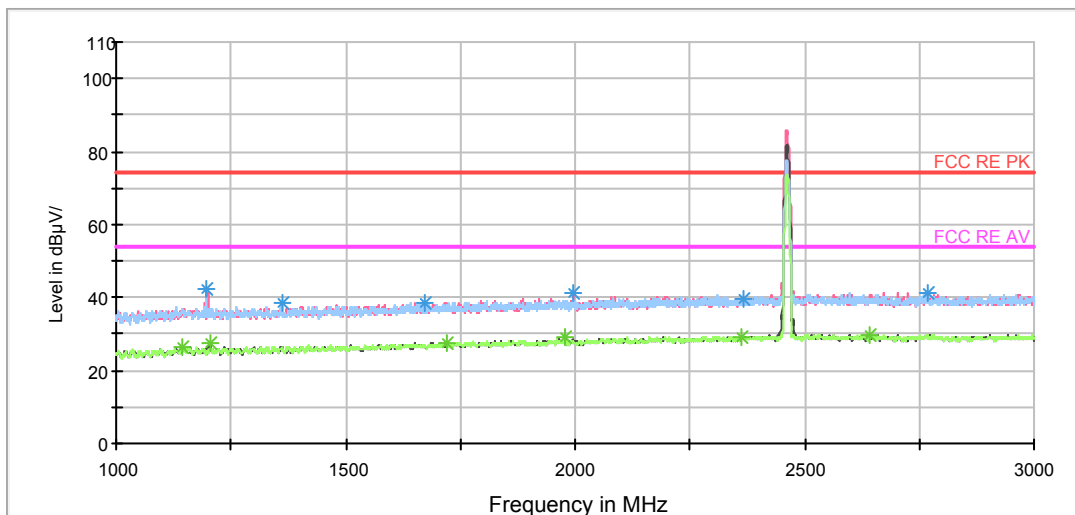

Note: The signal beyond the limit is carrier.  
Radiates Emission from 1GHz to 3GHz

RE 1G-18GHz PK+AV Class B

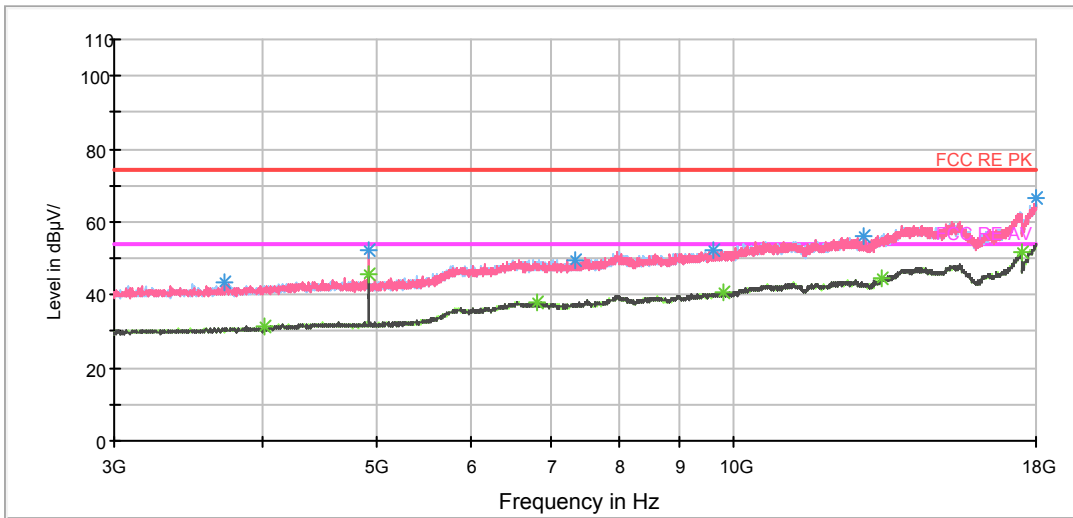

Radiates Emission from 3GHz to 18GHz

RE 18-26.5GHz PK+AV

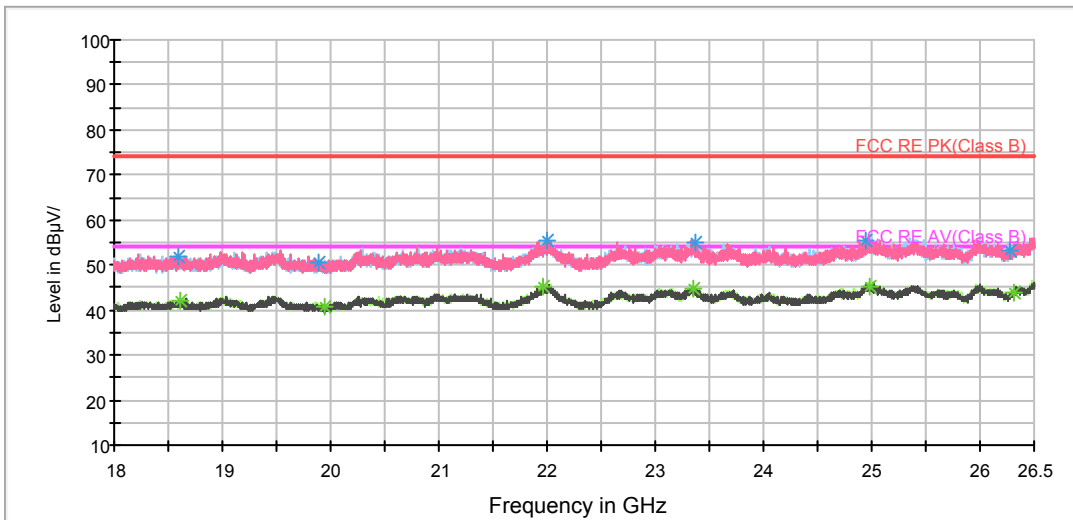

Radiates Emission from 18GHz to 26.5GHz



802.11g CH1

Frequency (MHz)	Peak (dBuV/m)	Height (cm)	Polarization	Azimuth (deg)	Reading value (dBuV/m)	Correct Factor (dB)	Margin (dB)	Limit (dBuV/m)
1196.000000	42.4	100.0	V	336.0	50.0	-7.6	31.6	74
1359.500000	38.2	100.0	V	177.0	45.3	-7.1	35.8	74
1712.000000	39.1	100.0	H	37.0	44.9	-5.8	34.9	74
2054.000000	39.9	100.0	V	280.0	44.5	-4.6	34.1	74
2504.000000	41.9	100.0	V	201.0	44.7	-2.8	32.1	74
2808.500000	40.2	100.0	V	336.0	42.8	-2.6	33.8	74

Remark: 1. Correction Factor = Antenna factor+ Insertion loss (cable loss + amplifier gain)

Frequency (MHz)	Average (dBuV/m)	Height (cm)	Polarization	Azimuth (deg)	Reading value (dBuV/m)	Correct Factor (dB)	Margin (dB)	Limit (dBuV/m)
1143.000000	26.5	100.0	H	0.0	34.2	-7.7	27.5	54
1436.000000	26.8	100.0	V	356.0	33.6	-6.8	27.2	54
1717.000000	27.5	100.0	H	8.0	33.3	-5.8	26.5	54
2055.000000	29.1	100.0	V	359.0	33.7	-4.6	24.9	54
2521.000000	29.7	100.0	V	270.0	32.5	-2.8	24.3	54
2768.000000	30.1	100.0	V	0.0	32.7	-2.6	23.9	54

Remark: 1. Correction Factor = Antenna factor+ Insertion loss (cable loss + amplifier gain)

FCC RE 1G-3GHz PK+AV Class B

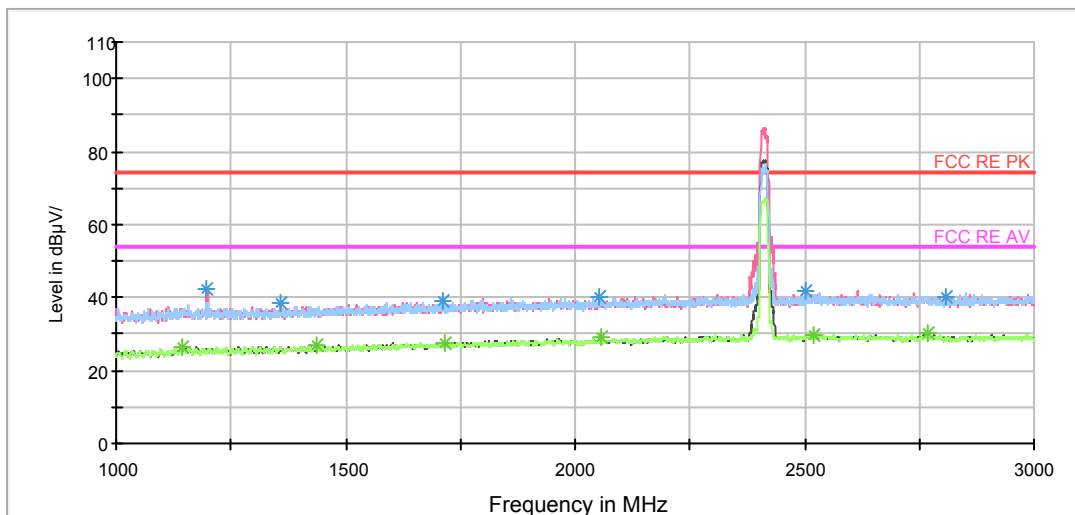

Note: The signal beyond the limit is carrier.  
Radiates Emission from 1GHz to 3GHz

RE 1G-18GHz PK+AV Class B

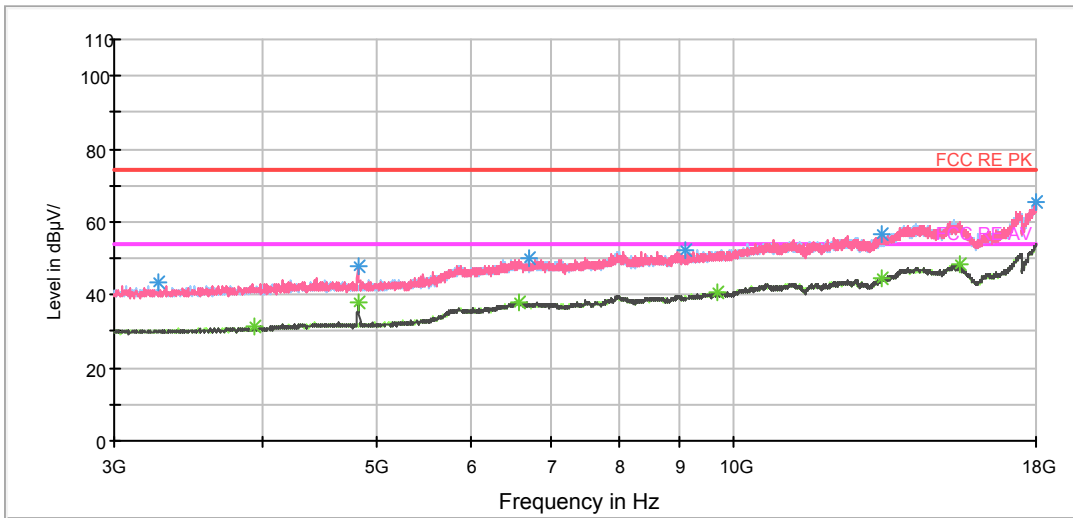

Radiates Emission from 3GHz to 18GHz

RE 18-26.5GHz PK+AV

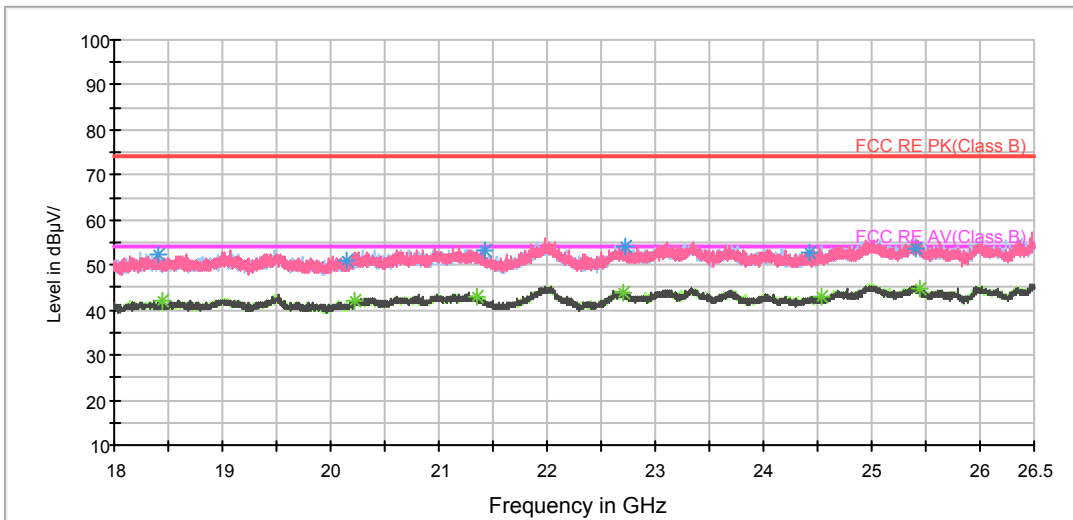

Radiates Emission from 18GHz to 26.5GHz



802.11g CH6

Frequency (MHz)	Peak (dBuV/m)	Height (cm)	Polarization	Azimuth (deg)	Reading value (dBuV/m)	Correct Factor (dB)	Margin (dB)	Limit (dBuV/m)
1200.000000	43.3	100.0	H	233.0	50.9	-7.6	30.7	74
1422.000000	38.3	100.0	H	61.0	45.2	-6.9	35.7	74
1716.500000	38.7	100.0	V	164.0	44.5	-5.8	35.3	74
1991.000000	41.7	100.0	V	0.0	46.5	-4.8	32.3	74
2614.500000	41.8	100.0	H	8.0	44.5	-2.7	32.2	74
2822.000000	39.9	100.0	H	0.0	42.5	-2.6	34.1	74

Remark: 1. Correction Factor = Antenna factor+ Insertion loss (cable loss + amplifier gain)

Frequency (MHz)	Average (dBuV/m)	Height (cm)	Polarization	Azimuth (deg)	Reading value (dBuV/m)	Correct Factor (dB)	Margin (dB)	Limit (dBuV/m)
1200.000000	26.4	100.0	H	233.0	34.0	-7.6	27.6	54
1437.000000	26.8	100.0	H	153.0	33.6	-6.8	27.2	54
1719.000000	27.4	100.0	H	208.0	33.2	-5.8	26.6	54
2057.500000	28.6	100.0	V	323.0	33.2	-4.6	25.4	54
2507.000000	30.0	100.0	H	8.0	32.8	-2.8	24.0	54
2793.500000	29.3	100.0	V	244.0	31.9	-2.6	24.7	54

Remark: 1. Correction Factor = Antenna factor+ Insertion loss (cable loss + amplifier gain)

FCC RE 1G-3GHz PK+AV Class B

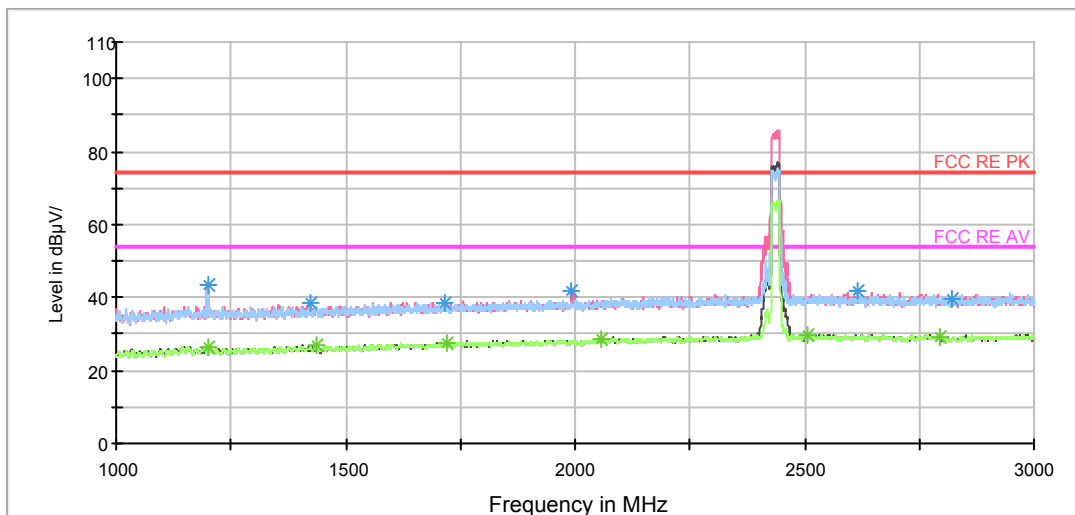

Note: The signal beyond the limit is carrier.  
Radiates Emission from 1GHz to 3GHz



RE 1G-18GHz PK+AV Class B

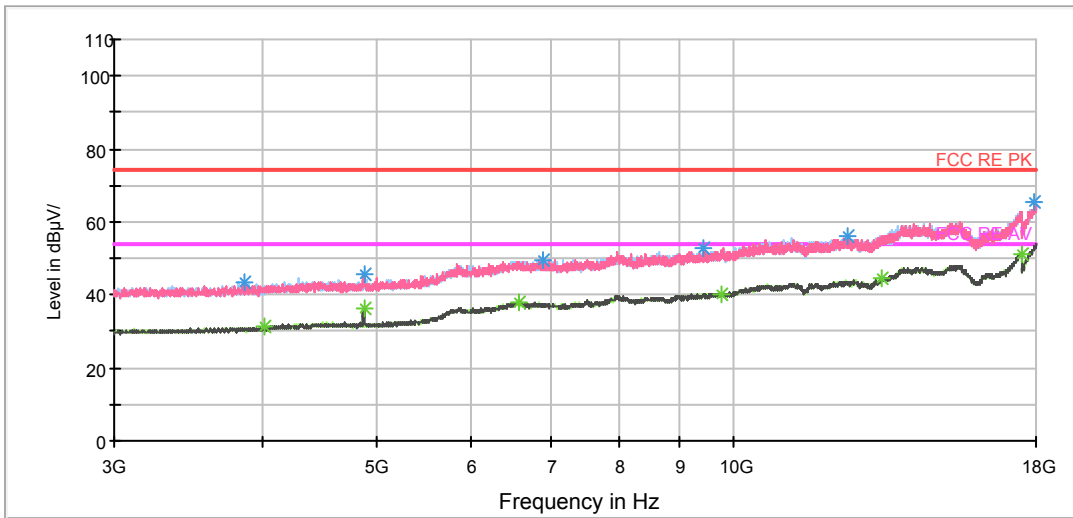

Radiates Emission from 3GHz to 18GHz

RE 18-26.5GHz PK+AV

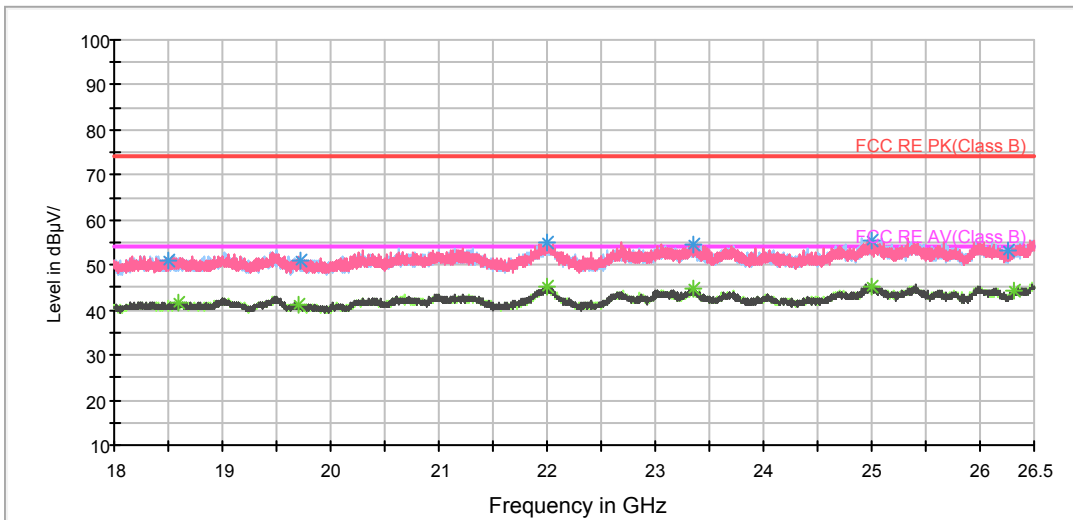

Radiates Emission from 18GHz to 26.5GHz



802.11g CH11

Frequency (MHz)	Peak (dBuV/m)	Height (cm)	Polarization	Azimuth (deg)	Reading value (dBuV/m)	Correct Factor (dB)	Margin (dB)	Limit (dBuV/m)
1199.500000	40.8	100.0	V	348.0	48.4	-7.6	33.2	74
1238.000000	37.9	100.0	H	207.0	45.3	-7.4	36.1	74
1569.000000	39.0	100.0	H	0.0	45.4	-6.4	35.0	74
1903.500000	40.0	100.0	V	187.0	45.2	-5.2	34.0	74
2687.000000	41.0	100.0	H	0.0	43.7	-2.7	33.0	74
2880.500000	42.0	100.0	V	267.0	44.5	-2.5	32.0	74

Remark: 1. Correction Factor = Antenna factor+ Insertion loss (cable loss + amplifier gain)

Frequency (MHz)	Average (dBuV/m)	Height (cm)	Polarization	Azimuth (deg)	Reading value (dBuV/m)	Correct Factor (dB)	Margin (dB)	Limit (dBuV/m)
1190.000000	26.4	100.0	V	334.0	34.0	-7.6	27.6	54
1436.000000	26.8	100.0	H	81.0	33.6	-6.8	27.2	54
1722.000000	27.6	100.0	V	302.0	33.4	-5.8	26.4	54
2058.000000	28.8	100.0	V	221.0	33.4	-4.6	25.2	54
2549.000000	29.8	100.0	V	312.0	32.6	-2.8	24.2	54
2927.500000	28.5	100.0	H	104.0	31.0	-2.5	25.5	54

Remark: 1. Correction Factor = Antenna factor+ Insertion loss (cable loss + amplifier gain)

FCC RE 1G-3GHz PK+AV Class B

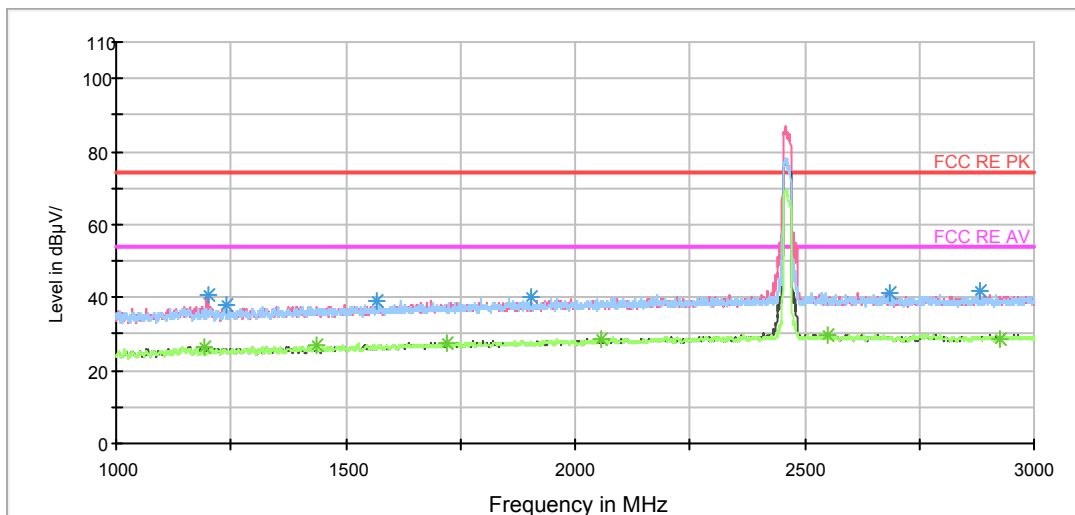

Note: The signal beyond the limit is carrier.  
Radiates Emission from 1GHz to 3GHz

RE 1G-18GHz PK+AV Class B

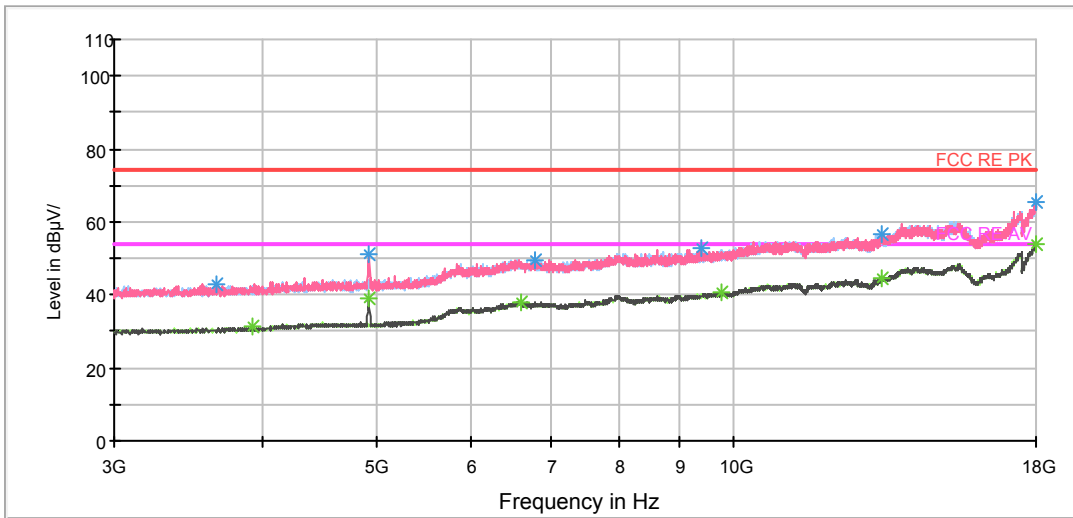

Radiates Emission from 3GHz to 18GHz

RE 18-26.5GHz PK+AV

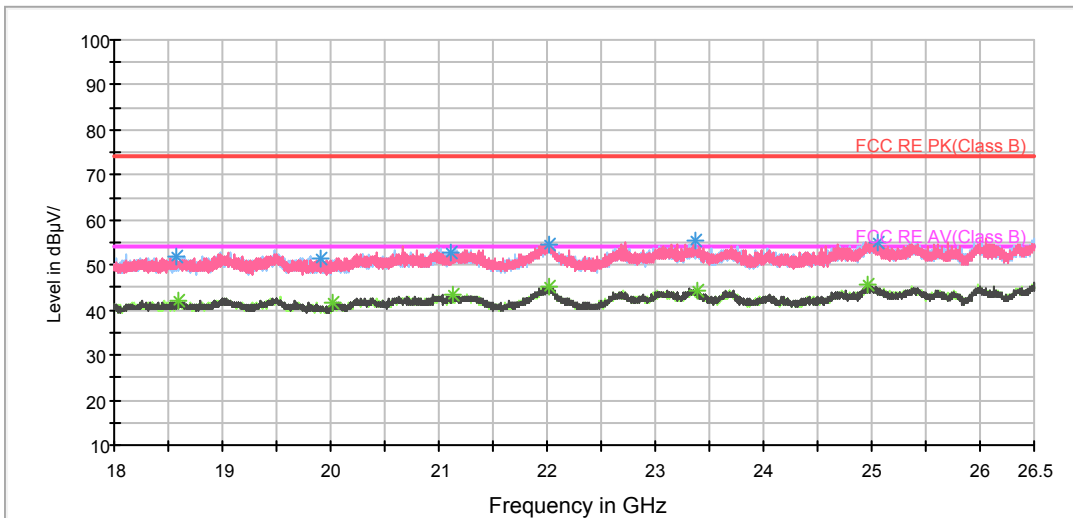

Radiates Emission from 18GHz to 26.5GHz



802.11n (HT20) CH1

Frequency (MHz)	Peak (dBuV/m)	Height (cm)	Polarization	Azimuth (deg)	Reading value (dBuV/m)	Correct Factor (dB)	Margin (dB)	Limit (dBuV/m)
1196.500000	40.7	100.0	V	354.0	48.3	-7.6	33.3	74
1374.000000	38.3	100.0	V	337.0	45.3	-7.0	35.7	74
1710.000000	39.0	100.0	V	199.0	44.9	-5.9	35.0	74
2080.000000	40.3	100.0	V	359.0	44.8	-4.5	33.7	74
2669.500000	39.8	100.0	V	359.0	42.5	-2.7	34.2	74
2958.000000	42.3	100.0	V	359.0	44.8	-2.5	31.7	74

Remark: 1. Correction Factor = Antenna factor+ Insertion loss (cable loss + amplifier gain)

Frequency (MHz)	Average (dBuV/m)	Height (cm)	Polarization	Azimuth (deg)	Reading value (dBuV/m)	Correct Factor (dB)	Margin (dB)	Limit (dBuV/m)
1156.500000	26.4	100.0	V	176.0	34.1	-7.7	27.6	54
1421.500000	26.8	100.0	V	317.0	33.7	-6.9	27.2	54
1700.000000	27.4	100.0	V	0.0	33.3	-5.9	26.6	54
2060.500000	28.6	100.0	H	168.0	33.1	-4.5	25.4	54
2485.000000	28.9	100.0	V	344.0	31.8	-2.9	25.1	54
2766.000000	30.0	100.0	H	99.0	32.6	-2.6	24.0	54

Remark: 1. Correction Factor = Antenna factor+ Insertion loss (cable loss + amplifier gain)

FCC RE 1G-3GHz PK+AV Class B

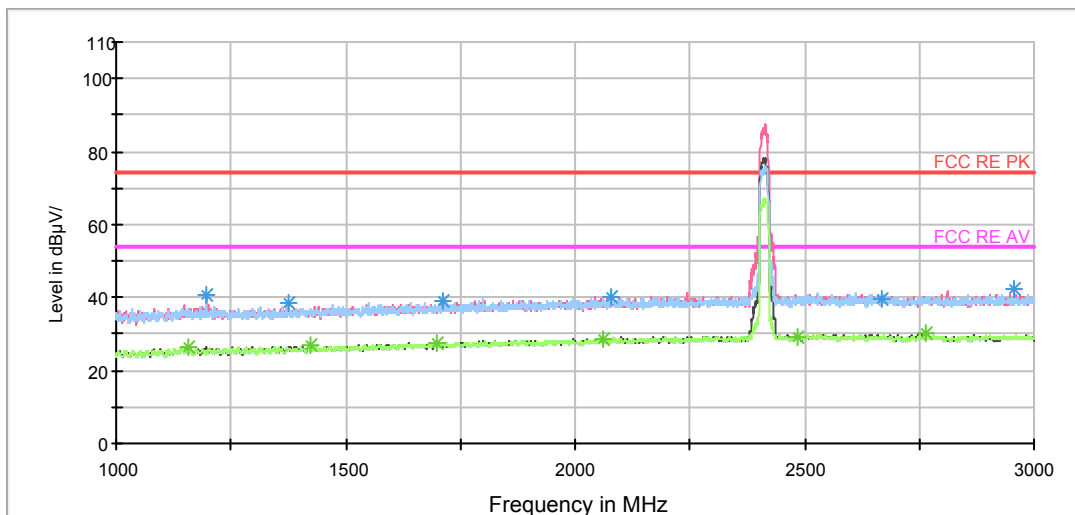

Note: The signal beyond the limit is carrier.  
Radiates Emission from 1GHz to 3GHz

RE 1G-18GHz PK+AV Class B

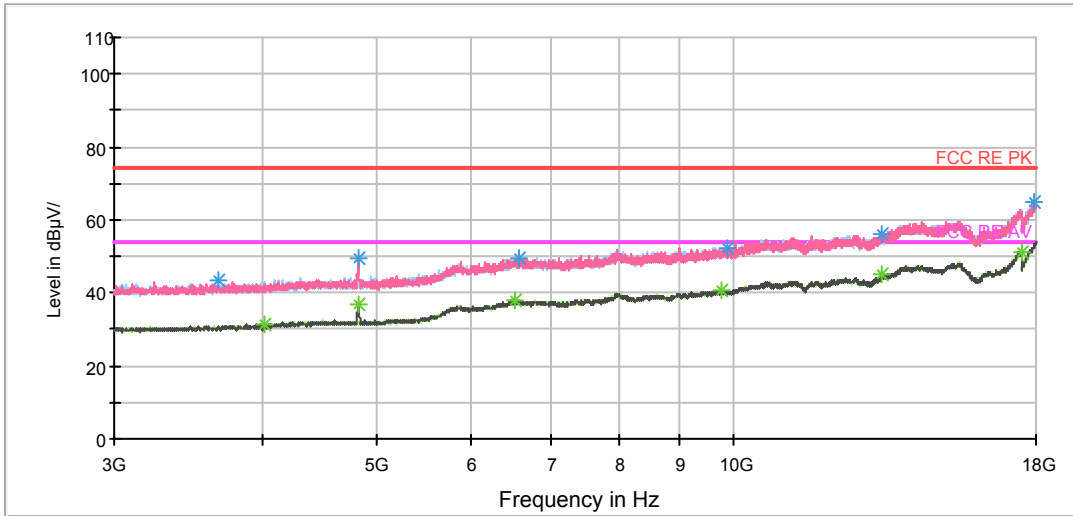

Radiates Emission from 3GHz to 18GHz

RE 18-26.5GHz PK+AV

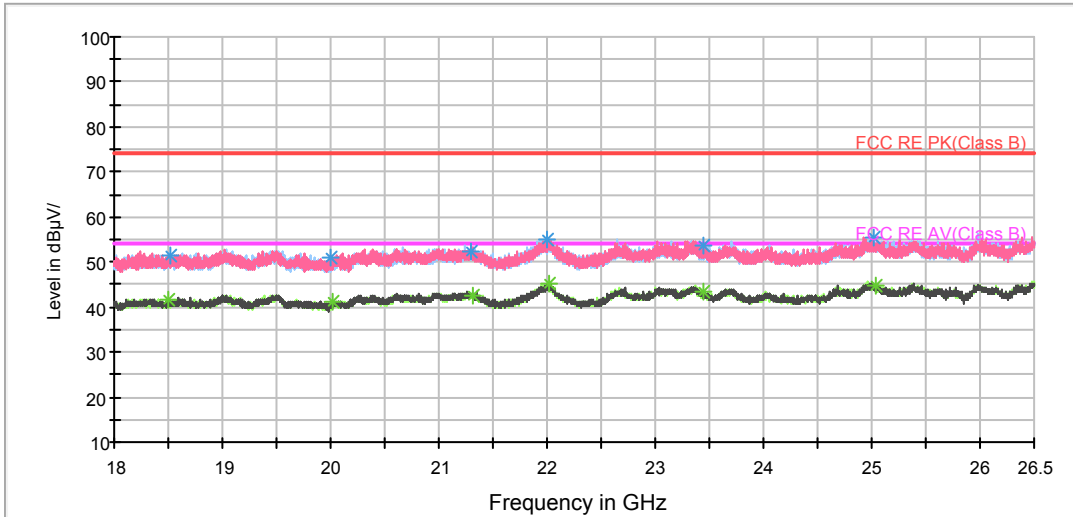

Radiates Emission from 18GHz to 26.5GHz



802.11n (HT20) CH6

Frequency (MHz)	Peak (dBuV/m)	Height (cm)	Polarization	Azimuth (deg)	Reading value (dBuV/m)	Correct Factor (dB)	Margin (dB)	Limit (dBuV/m)
1197.500000	42.6	100.0	V	0.0	50.2	-7.6	31.4	74
1207.500000	37.9	100.0	V	349.0	45.4	-7.5	36.1	74
1715.000000	38.9	100.0	H	12.0	44.7	-5.8	35.1	74
1993.500000	43.2	100.0	V	357.0	48.0	-4.8	30.8	74
2502.500000	41.4	100.0	V	129.0	44.2	-2.8	32.6	74
2830.500000	40.2	100.0	H	106.0	42.8	-2.6	33.8	74

Remark: 1. Correction Factor = Antenna factor+ Insertion loss (cable loss + amplifier gain)

Frequency (MHz)	Average (dBuV/m)	Height (cm)	Polarization	Azimuth (deg)	Reading value (dBuV/m)	Correct Factor (dB)	Margin (dB)	Limit (dBuV/m)
1160.500000	26.3	100.0	H	106.0	34.0	-7.7	27.7	54
1435.000000	27.0	100.0	H	0.0	33.8	-6.8	27.0	54
1617.000000	27.4	100.0	H	198.0	33.6	-6.2	26.6	54
1971.500000	28.8	100.0	V	282.0	33.7	-4.9	25.2	54
2503.000000	30.0	100.0	V	214.0	32.8	-2.8	24.0	54
2819.500000	29.3	100.0	H	268.0	31.9	-2.6	24.7	54

Remark: 1. Correction Factor = Antenna factor+ Insertion loss (cable loss + amplifier gain)

FCC RE 1G-3GHz PK+AV Class B

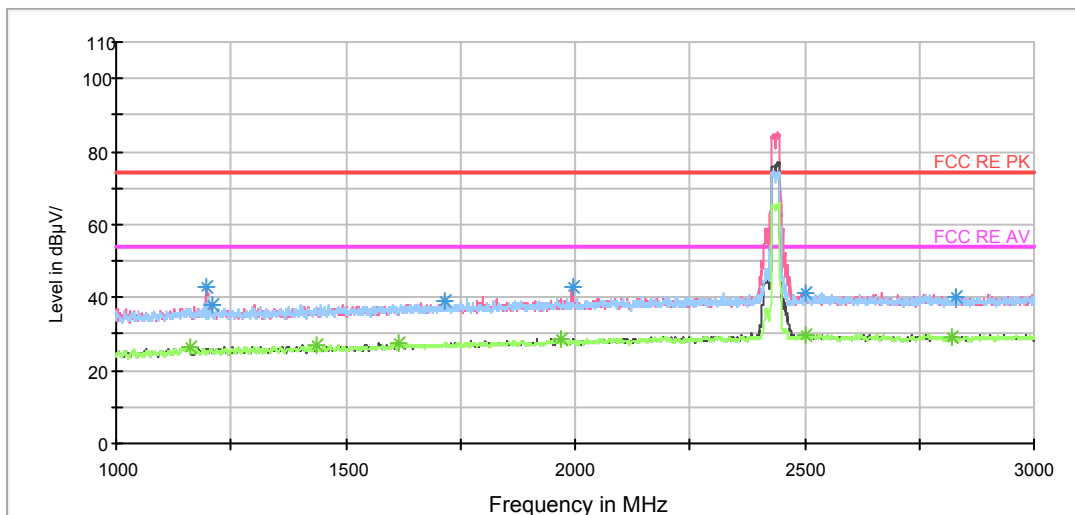

Note: The signal beyond the limit is carrier.  
Radiates Emission from 1GHz to 3GHz

RE 1G-18GHz PK+AV Class B

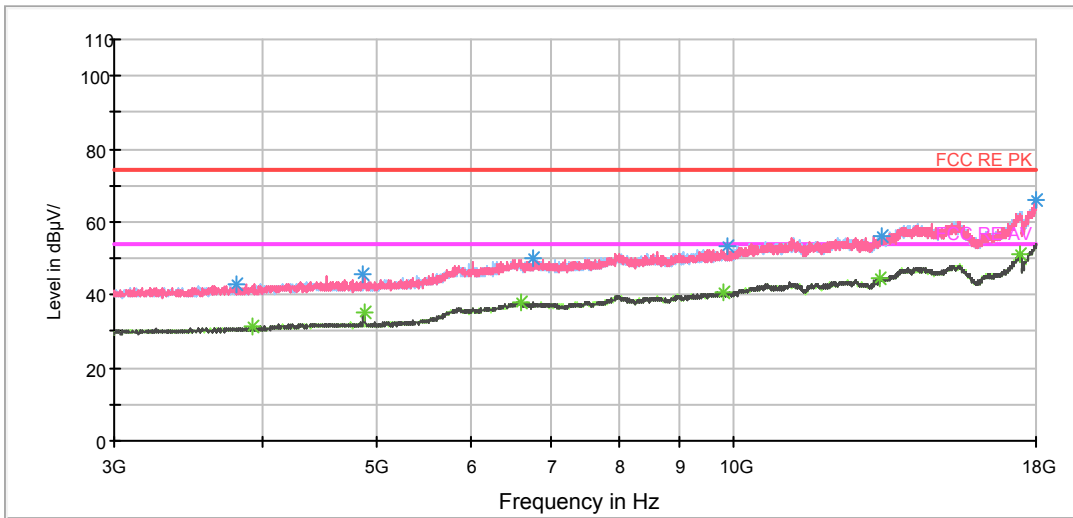

Radiates Emission from 3GHz to 18GHz

RE 18-26.5GHz PK+AV

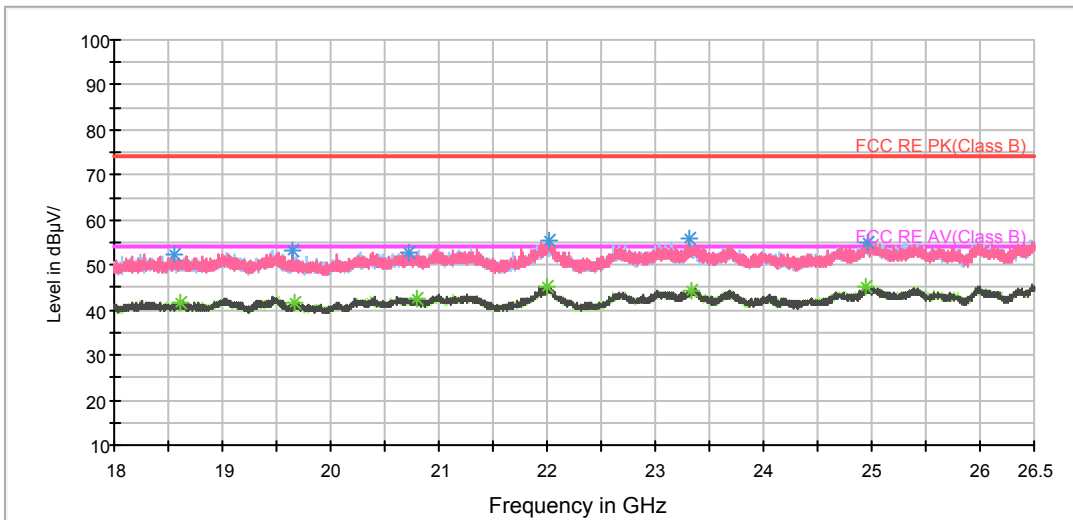

Radiates Emission from 18GHz to 26.5GHz



802.11n (HT20) CH11

Frequency (MHz)	Peak (dBuV/m)	Height (cm)	Polarization	Azimuth (deg)	Reading value (dBuV/m)	Correct Factor (dB)	Margin (dB)	Limit (dBuV/m)
1198.500000	44.1	100.0	V	341.0	51.7	-7.6	29.9	74
1435.500000	37.7	100.0	V	244.0	44.5	-6.8	36.3	74
1620.500000	38.5	100.0	V	333.0	44.7	-6.2	35.5	74
1992.000000	40.5	100.0	V	355.0	45.3	-4.8	33.5	74
2531.500000	41.0	100.0	H	98.0	43.8	-2.8	33.0	74
2851.000000	39.9	100.0	V	34.0	42.5	-2.6	34.1	74

Remark: 1. Correction Factor = Antenna factor+ Insertion loss (cable loss + amplifier gain)

Frequency (MHz)	Average (dBuV/m)	Height (cm)	Polarization	Azimuth (deg)	Reading value (dBuV/m)	Correct Factor (dB)	Margin (dB)	Limit (dBuV/m)
1198.500000	27.3	100.0	V	341.0	34.9	-7.6	26.7	54
1405.500000	26.6	100.0	V	266.0	33.5	-6.9	27.4	54
1635.500000	27.4	100.0	H	273.0	33.5	-6.1	26.6	54
1997.000000	28.8	100.0	H	145.0	33.6	-4.8	25.2	54
2674.000000	30.1	100.0	H	1.0	32.8	-2.7	23.9	54
2883.500000	29.3	100.0	V	289.0	31.8	-2.5	24.7	54

Remark: 1. Correction Factor = Antenna factor+ Insertion loss (cable loss + amplifier gain)

FCC RE 1G-3GHz PK+AV Class B

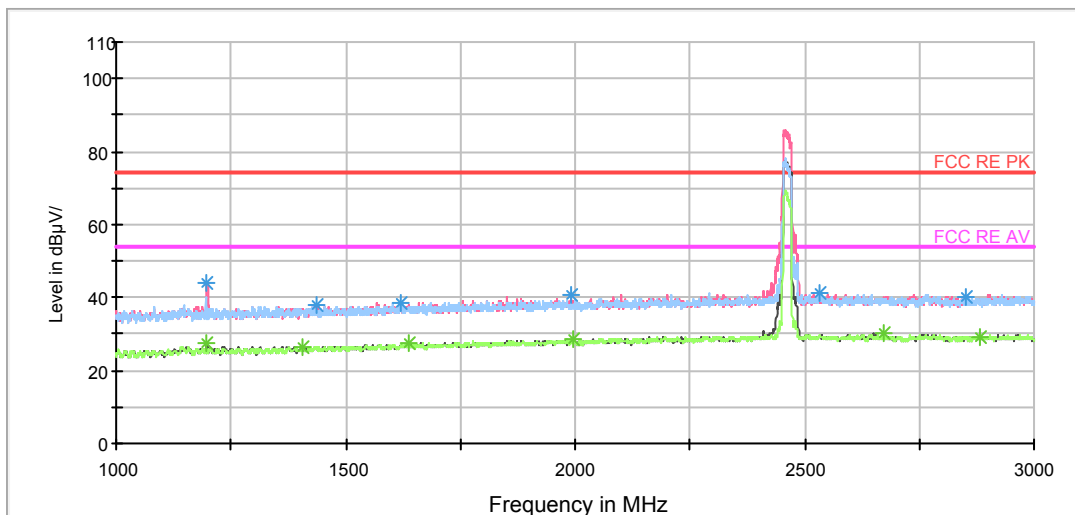

Note: The signal beyond the limit is carrier.  
Radiates Emission from 1GHz to 3GHz



RE 1G-18GHz PK+AV Class B

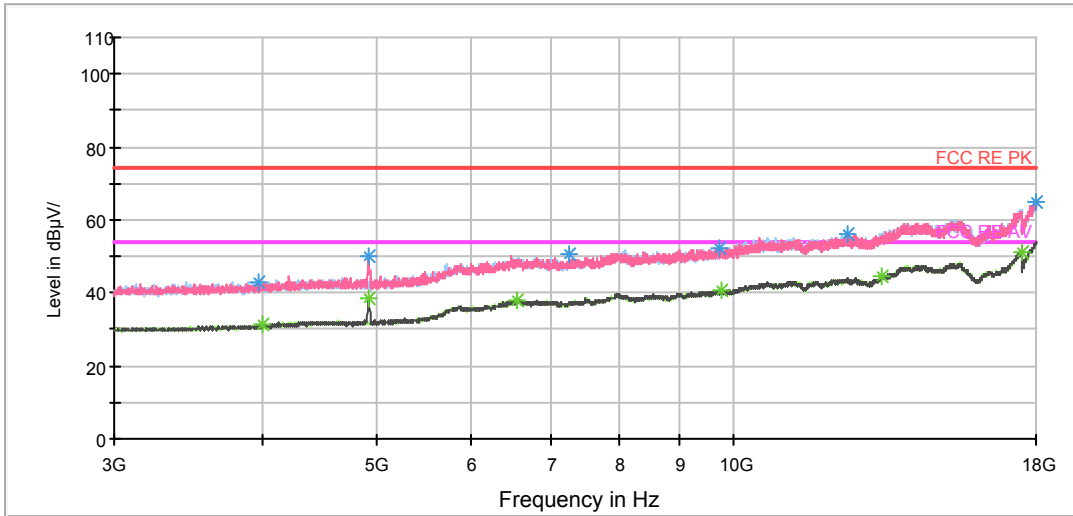

Radiates Emission from 3GHz to 18GHz

RE 18-26.5GHz PK+AV

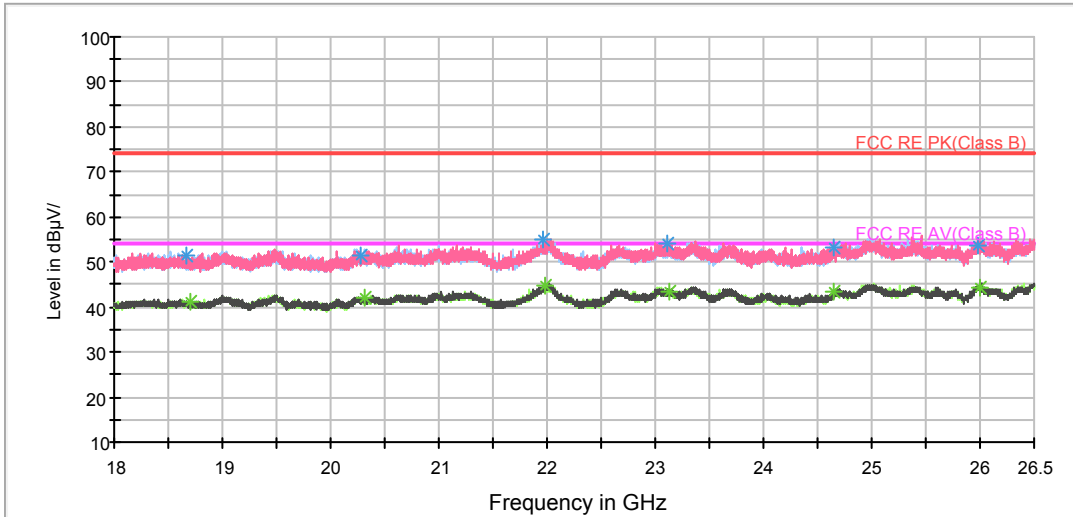

Radiates Emission from 18GHz to 26.5GHz



BLE-Channel 0

Frequency (MHz)	Peak (dBuV/m)	Height (cm)	Polarization	Azimuth (deg)	Reading value (dBuV/m)	Correct Factor (dB)	Margin (dB)	Limit (dBuV/m)
1196.500000	39.9	100.0	H	227.0	47.5	-7.6	34.1	74
1434.500000	38.2	100.0	H	0.0	45.0	-6.8	35.8	74
1663.500000	38.7	100.0	V	270.0	44.7	-6.0	35.3	74
1991.500000	43.1	100.0	V	336.0	47.9	-4.8	30.9	74
2284.500000	40.2	100.0	V	178.0	43.8	-3.6	33.8	74
2713.000000	41.3	100.0	V	343.0	44.0	-2.7	32.7	74

Remark: 1. Correction Factor = Antenna factor+ Insertion loss (cable loss + amplifier gain)

Frequency (MHz)	Average (dBuV/m)	Height (cm)	Polarization	Azimuth (deg)	Reading value (dBuV/m)	Correct Factor (dB)	Margin (dB)	Limit (dBuV/m)
1200.500000	27.8	100.0	V	0.0	35.4	-7.6	26.2	54
1201.000000	26.7	100.0	V	0.0	34.3	-7.6	27.3	54
1641.000000	27.4	100.0	H	0.0	33.5	-6.1	26.6	54
2058.500000	29.0	100.0	H	101.0	33.6	-4.6	25.0	54
2521.000000	29.9	100.0	H	16.0	32.7	-2.8	24.1	54
2849.500000	28.9	100.0	V	0.0	31.5	-2.6	25.1	54

Remark: 1. Correction Factor = Antenna factor+ Insertion loss (cable loss + amplifier gain)

FCC RE 1G-3GHz PK+AV Class B

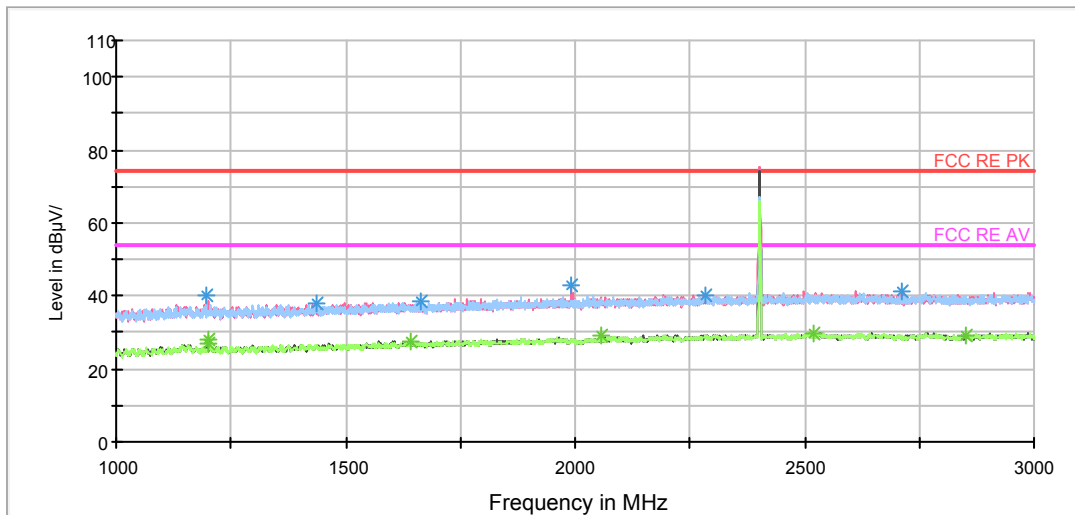

Note: The signal beyond the limit is carrier.  
Radiates Emission from 1GHz to 3GHz

RE 1G-18GHz PK+AV Class B

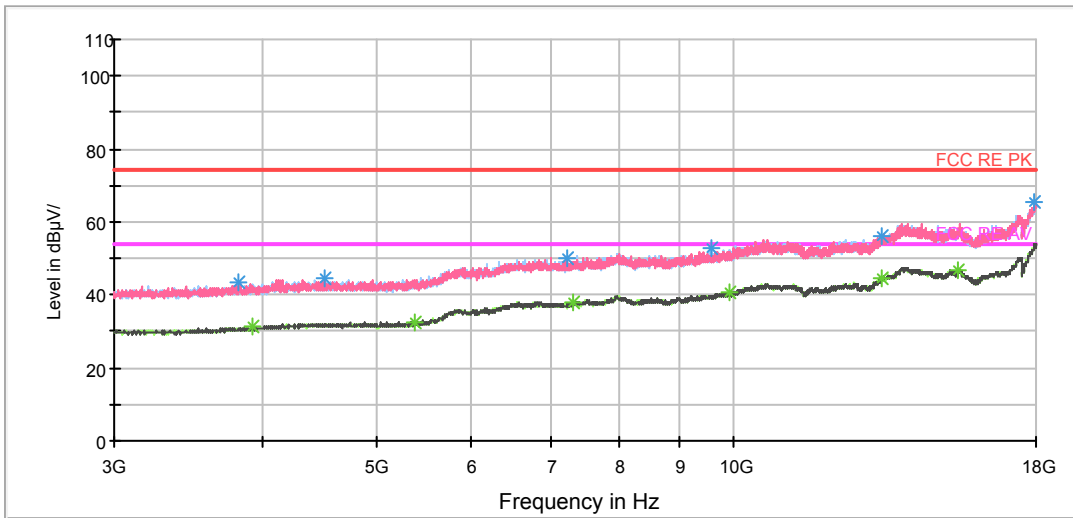

Radiates Emission from 3GHz to 18GHz

RE 18-26.5GHz PK+AV

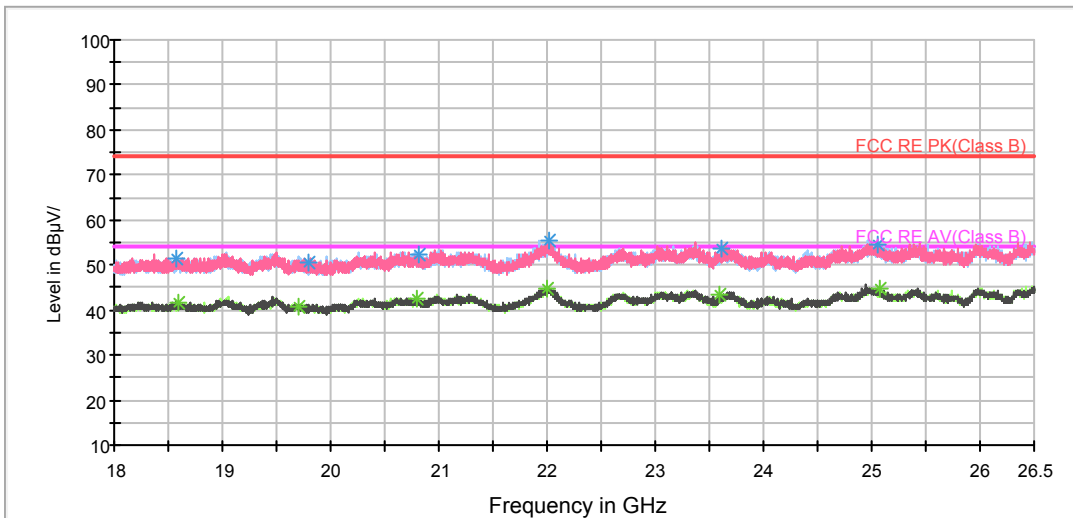

Radiates Emission from 18GHz to 26.5GHz



BLE-Channel 19

Frequency (MHz)	Peak (dBuV/m)	Height (cm)	Polarization	Azimuth (deg)	Reading value (dBuV/m)	Correct Factor (dB)	Margin (dB)	Limit (dBuV/m)
1196.500000	39.7	100.0	V	165.0	47.3	-7.6	34.3	74
1311.500000	38.1	100.0	V	351.0	45.3	-7.2	35.9	74
1600.500000	38.8	100.0	V	0.0	45.1	-6.3	35.2	74
1992.000000	42.1	100.0	V	347.0	46.9	-4.8	31.9	74
2323.500000	40.3	100.0	H	2.0	43.8	-3.5	33.7	74
2757.000000	41.4	100.0	V	351.0	44.0	-2.6	32.6	74

Remark: 1. Correction Factor = Antenna factor+ Insertion loss (cable loss + amplifier gain)

Frequency (MHz)	Average (dBuV/m)	Height (cm)	Polarization	Azimuth (deg)	Reading value (dBuV/m)	Correct Factor (dB)	Margin (dB)	Limit (dBuV/m)
1143.500000	26.2	100.0	H	50.0	33.9	-7.7	27.8	54
1282.500000	26.7	100.0	H	220.0	34.0	-7.3	27.3	54
1716.000000	27.3	100.0	H	185.0	33.1	-5.8	26.7	54
1967.500000	29.0	100.0	V	351.0	33.9	-4.9	25.0	54
2505.000000	30.1	100.0	H	129.0	32.9	-2.8	23.9	54
2895.500000	29.1	100.0	H	84.0	31.6	-2.5	24.9	54

Remark: 1. Correction Factor = Antenna factor+ Insertion loss (cable loss + amplifier gain)

FCC RE 1G-3GHz PK+AV Class B

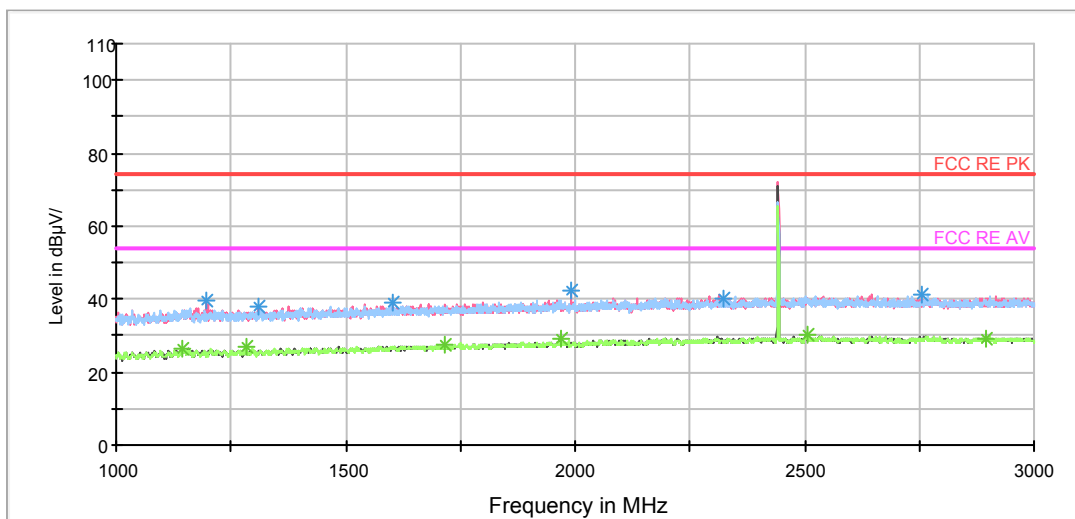

Note: The signal beyond the limit is carrier.

Radiates Emission from 1GHz to 3GHz

RE 1G-18GHz PK+AV Class B

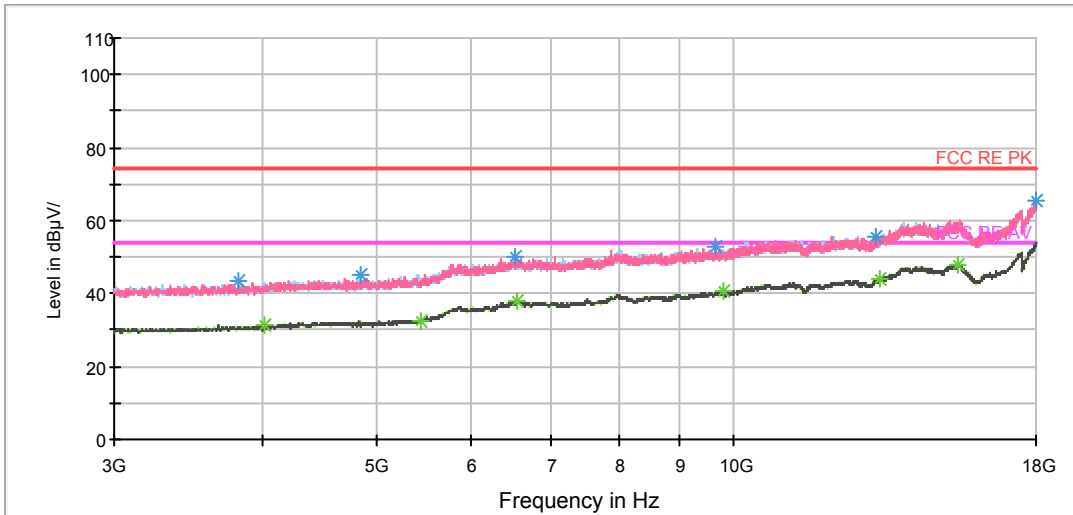

Radiates Emission from 3GHz to 18GHz

RE 18-26.5GHz PK+AV

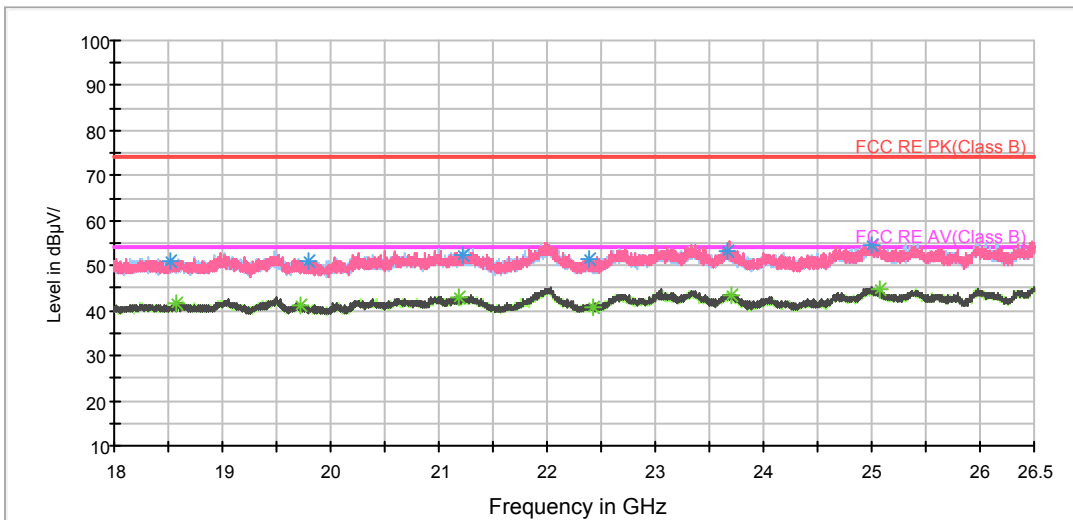

Radiates Emission from 18GHz to 26.5GHz



BLE-Channel 39

Frequency (MHz)	Peak (dBuV/m)	Height (cm)	Polarization	Azimuth (deg)	Reading value (dBuV/m)	Correct Factor (dB)	Margin (dB)	Limit (dBuV/m)
1194.500000	38.8	100.0	V	34.0	46.4	-7.6	35.2	74
1405.500000	39.3	100.0	H	3.0	46.2	-6.9	34.7	74
1712.500000	39.1	100.0	V	330.0	44.9	-5.8	34.9	74
2040.500000	40.4	100.0	V	298.0	45.0	-4.6	33.6	74
2587.000000	39.5	100.0	H	12.0	42.3	-2.8	34.5	74
2991.000000	41.0	100.0	V	358.0	43.4	-2.4	33.0	74

Remark: 1. Correction Factor = Antenna factor+ Insertion loss (cable loss + amplifier gain)

Frequency (MHz)	Average (dBuV/m)	Height (cm)	Polarization	Azimuth (deg)	Reading value (dBuV/m)	Correct Factor (dB)	Margin (dB)	Limit (dBuV/m)
1144.000000	26.3	100.0	H	108.0	34.0	-7.7	27.7	54
1420.500000	26.4	100.0	V	231.0	33.3	-6.9	27.6	54
1635.000000	27.1	100.0	H	210.0	33.2	-6.1	26.9	54
2071.000000	28.5	100.0	V	140.0	33.0	-4.5	25.5	54
2396.000000	29.3	100.0	H	19.0	32.5	-3.2	24.7	54
2765.500000	30.1	100.0	V	309.0	32.7	-2.6	23.9	54

Remark: 1. Correction Factor = Antenna factor+ Insertion loss (cable loss + amplifier gain)

FCC RE 1G-3GHz PK+AV Class B

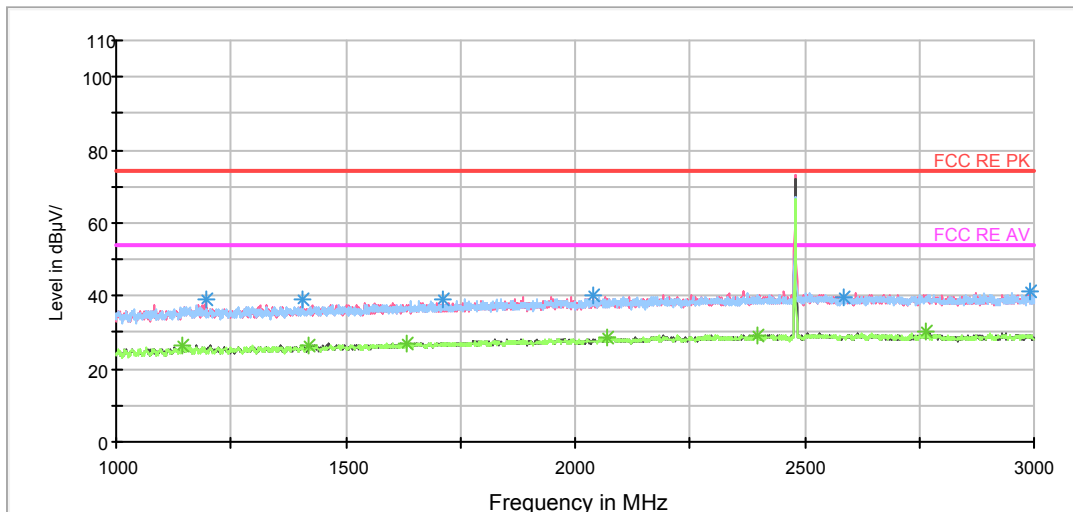

Note: The signal beyond the limit is carrier.  
Radiates Emission from 1GHz to 3GHz

RE 1G-18GHz PK+AV Class B

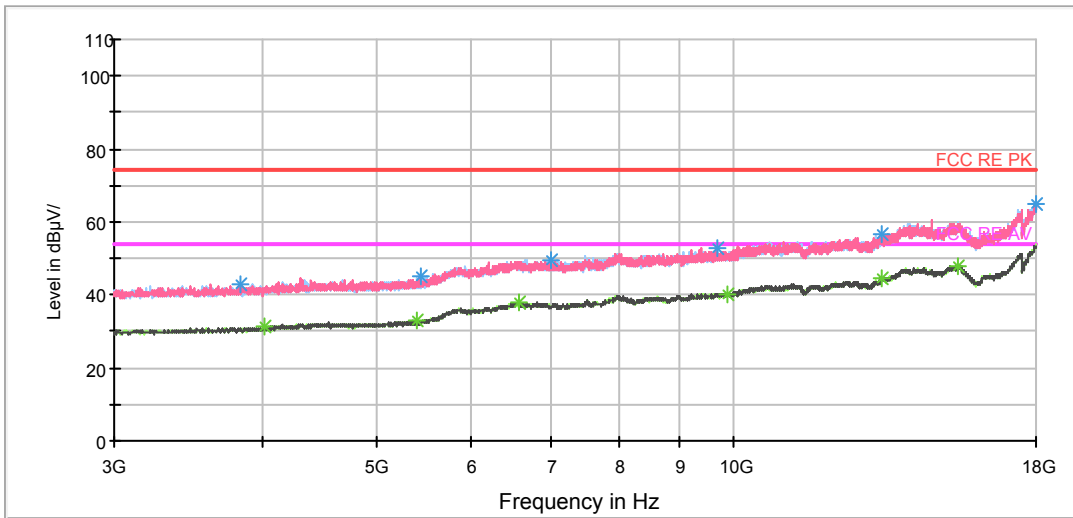

Radiates Emission from 3GHz to 18GHz

RE 18-26.5GHz PK+AV

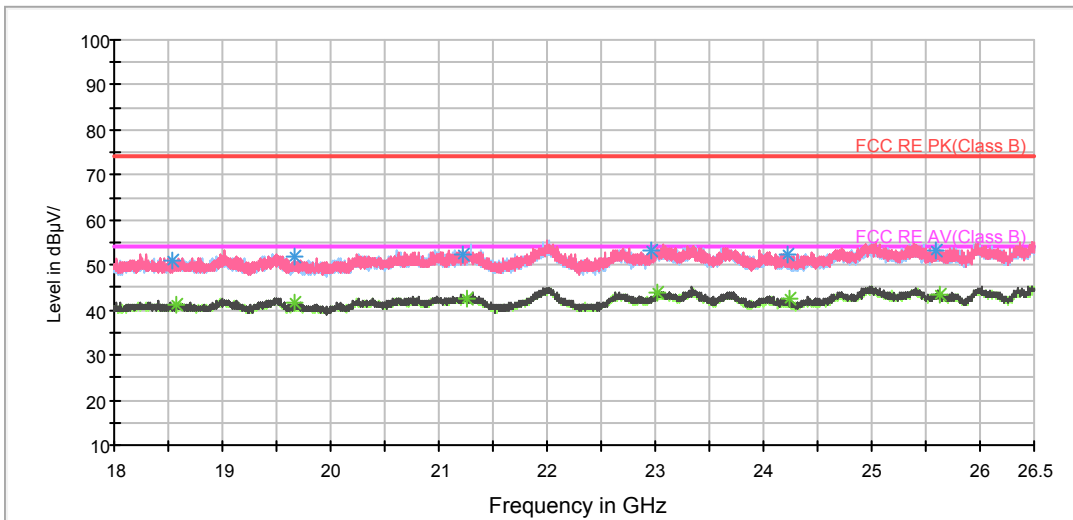

Radiates Emission from 18GHz to 26.5GHz

### 5.8. Conducted Emission

#### Ambient condition

Temperature	Relative humidity	Pressure
23°C ~25°C	45%~50%	101.5kPa

#### Methods of Measurement

The EUT is placed on a non-metallic table of 80cm height above the horizontal metal reference ground plane. During the test, the EUT was operating in its typical mode. The test method is according to ANSI C63.10-2013. Connect the AC power line of the EUT to the L.I.S.N. Use EMI receiver to detect the average and Quasi-peak value. RBW is set to 9 kHz, VBW is set to 30kHz. The measurement result should include both L line and N line.

The test is in transmitting mode.

#### Test Setup

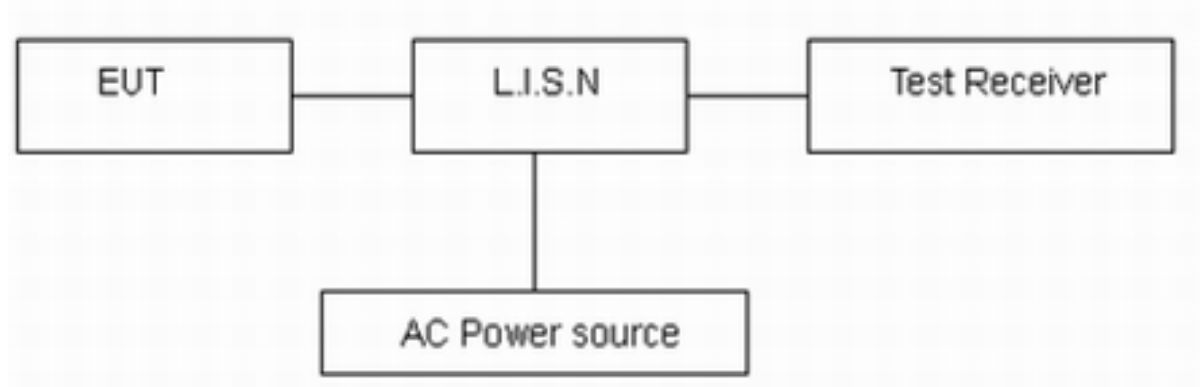

Note: AC Power source is used to change the voltage 110V/60Hz.

#### Limits

Frequency (MHz)	Conducted Limits(dBμV)	
	Quasi-peak	Average
0.15 - 0.5	66 to 56 *	56 to 46*
0.5 - 5	56	46
5 - 30	60	50

\*: Decreases with the logarithm of the frequency.

#### Measurement Uncertainty

The assessed measurement uncertainty to ensure 95% confidence level for the normal distribution is with the coverage factor  $k = 1.96$ ,  $U = 2.69$  dB.





Test Results:

Following plots, Blue trace uses the peak detection and Green trace uses the average detection.

802.11b, Channel No.: 1

L Line

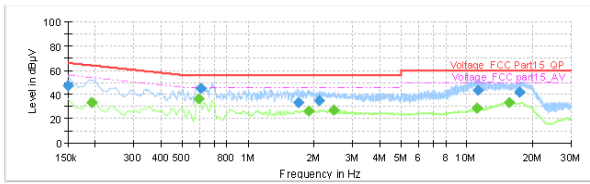

Final Result

Table with 10 columns: Frequency (MHz), QuasiPeak (dBµV), Average (dBµV), Limit (dBµV), Margin (dB), Meas. Time (ms), Bandwidth (kHz), Line, Filter, Corr. (dB). Contains 15 rows of test data for L Line.

N Line

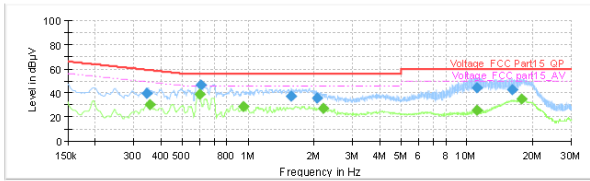

Final Result

Table with 10 columns: Frequency (MHz), QuasiPeak (dBµV), Average (dBµV), Limit (dBµV), Margin (dB), Meas. Time (ms), Bandwidth (kHz), Line, Filter, Corr. (dB). Contains 15 rows of test data for N Line.

802.11b, Channel No.: 6

L Line

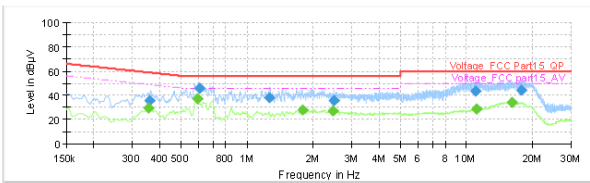

Final Result

Table with 10 columns: Frequency (MHz), QuasiPeak (dBµV), Average (dBµV), Limit (dBµV), Margin (dB), Meas. Time (ms), Bandwidth (kHz), Line, Filter, Corr. (dB). Contains 15 rows of test data for L Line.

N Line

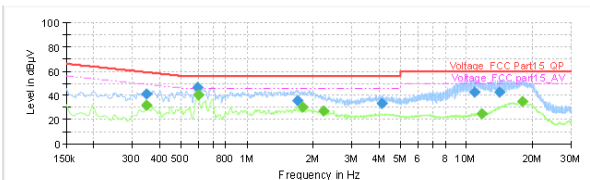

Final Result

Table with 10 columns: Frequency (MHz), QuasiPeak (dBµV), Average (dBµV), Limit (dBµV), Margin (dB), Meas. Time (ms), Bandwidth (kHz), Line, Filter, Corr. (dB). Contains 15 rows of test data for N Line.



802.11b, Channel No.: 11

L Line

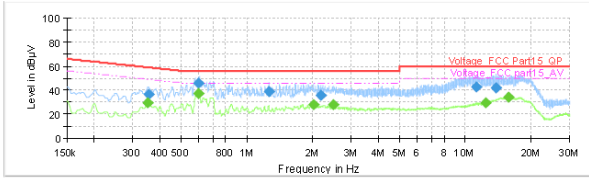

Final Result

Table with 10 columns: Frequency (MHz), QuasiPeak (dBµV), Average (dBµV), Limit (dBµV), Margin (dB), Meas. Time (ms), Bandwidth (kHz), Line, Filter, Corr. (dB). Contains 15 rows of test data.

N Line

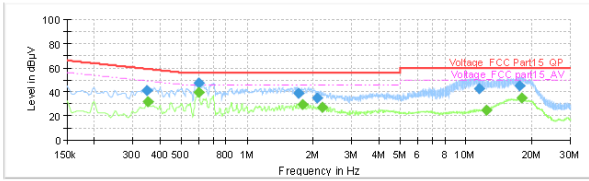

Final Result

Table with 10 columns: Frequency (MHz), QuasiPeak (dBµV), Average (dBµV), Limit (dBµV), Margin (dB), Meas. Time (ms), Bandwidth (kHz), Line, Filter, Corr. (dB). Contains 15 rows of test data.

802.11g, Channel No.: 1

L Line

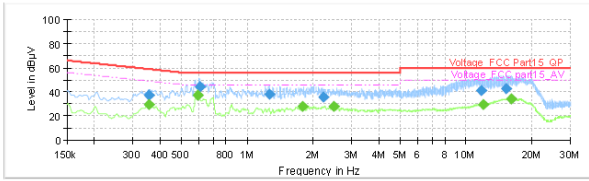

Final Result

Table with 10 columns: Frequency (MHz), QuasiPeak (dBµV), Average (dBµV), Limit (dBµV), Margin (dB), Meas. Time (ms), Bandwidth (kHz), Line, Filter, Corr. (dB). Contains 15 rows of test data.

N Line

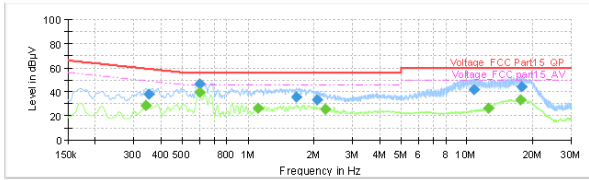

Final Result

Table with 10 columns: Frequency (MHz), QuasiPeak (dBµV), Average (dBµV), Limit (dBµV), Margin (dB), Meas. Time (ms), Bandwidth (kHz), Line, Filter, Corr. (dB). Contains 15 rows of test data.



802.11g, Channel No.: 6

L Line

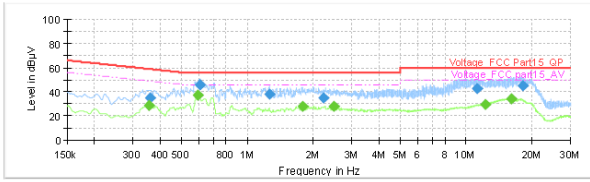

Final Result

Table with 10 columns: Frequency (MHz), QuasiPeak (dBµV), Average (dBµV), Limit (dBµV), Margin (dB), Meas. Time (ms), Bandwidth (kHz), Line, Filter, Corr. (dB). Contains 15 rows of test data for L Line.

N Line

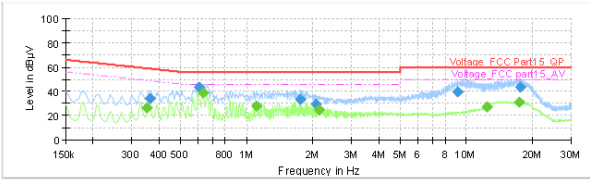

Final Result

Table with 10 columns: Frequency (MHz), QuasiPeak (dBµV), Average (dBµV), Limit (dBµV), Margin (dB), Meas. Time (ms), Bandwidth (kHz), Line, Filter, Corr. (dB). Contains 15 rows of test data for N Line.

802.11g, Channel No.: 11

L Line

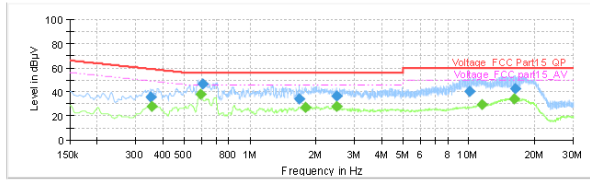

Final Result

Table with 10 columns: Frequency (MHz), QuasiPeak (dBµV), Average (dBµV), Limit (dBµV), Margin (dB), Meas. Time (ms), Bandwidth (kHz), Line, Filter, Corr. (dB). Contains 15 rows of test data for L Line.

N Line

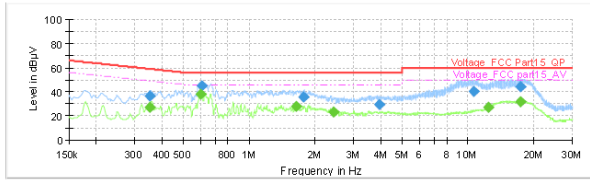

Final Result

Table with 10 columns: Frequency (MHz), QuasiPeak (dBµV), Average (dBµV), Limit (dBµV), Margin (dB), Meas. Time (ms), Bandwidth (kHz), Line, Filter, Corr. (dB). Contains 15 rows of test data for N Line.



802.11n(HT20), Channel No.: 1

L Line

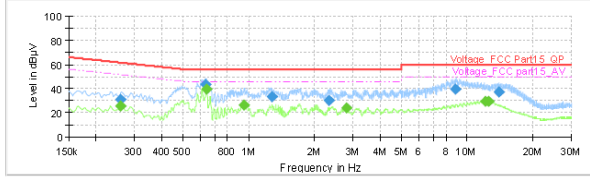

Final Result

Table with 10 columns: Frequency (MHz), QuasiPeak (dBuV), Average (dBuV), Limit (dBuV), Margin (dB), Meas. Time (ms), Bandwidth (kHz), Line, Filter, Corr. (dB). Contains 14 rows of test data for L Line.

N Line

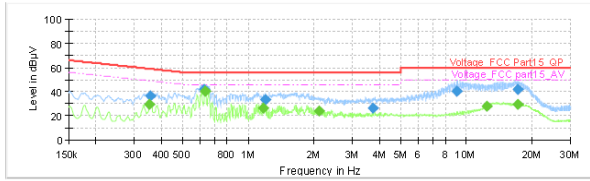

Final Result

Table with 10 columns: Frequency (MHz), QuasiPeak (dBuV), Average (dBuV), Limit (dBuV), Margin (dB), Meas. Time (ms), Bandwidth (kHz), Line, Filter, Corr. (dB). Contains 14 rows of test data for N Line.

802.11n(HT20), Channel No.: 6

L Line

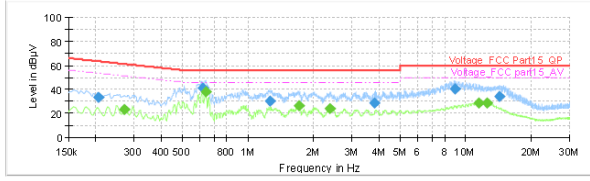

Final Result

Table with 10 columns: Frequency (MHz), QuasiPeak (dBuV), Average (dBuV), Limit (dBuV), Margin (dB), Meas. Time (ms), Bandwidth (kHz), Line, Filter, Corr. (dB). Contains 14 rows of test data for L Line.

N Line

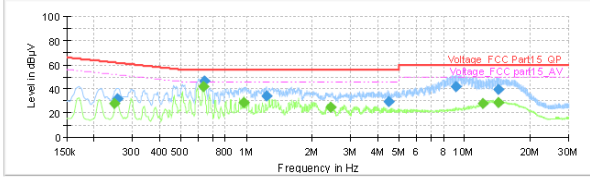

Final Result

Table with 10 columns: Frequency (MHz), QuasiPeak (dBuV), Average (dBuV), Limit (dBuV), Margin (dB), Meas. Time (ms), Bandwidth (kHz), Line, Filter, Corr. (dB). Contains 14 rows of test data for N Line.



802.11n(HT20), Channel No.: 11

L Line

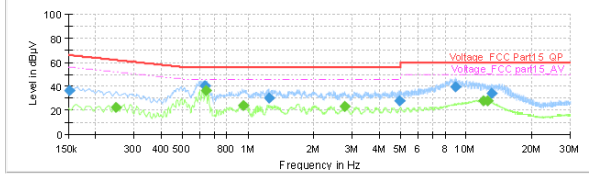

Final Result

Table with 10 columns: Frequency (MHz), QuasiPeak (dBuV), Average (dBuV), Limit (dBuV), Margin (dB), Meas. Time (ms), Bandwidth (kHz), Line, Filter, Corr. (dB). Contains 14 rows of test data for L Line.

N Line

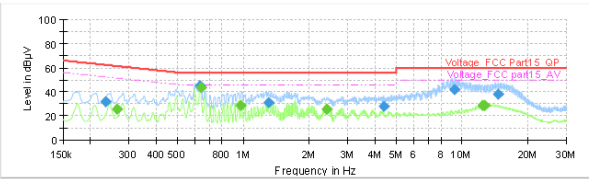

Final Result

Table with 10 columns: Frequency (MHz), QuasiPeak (dBuV), Average (dBuV), Limit (dBuV), Margin (dB), Meas. Time (ms), Bandwidth (kHz), Line, Filter, Corr. (dB). Contains 14 rows of test data for N Line.

BLE, Channel No.: 0

L Line

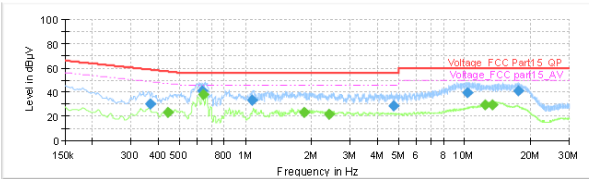

Final Result

Table with 10 columns: Frequency (MHz), QuasiPeak (dBuV), Average (dBuV), Limit (dBuV), Margin (dB), Meas. Time (ms), Bandwidth (kHz), Line, Filter, Corr. (dB). Contains 14 rows of test data for BLE L Line.

N Line

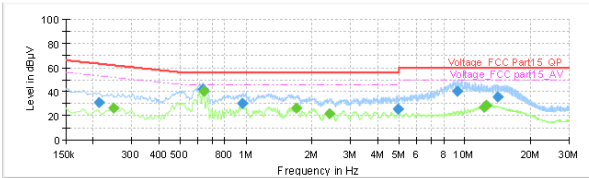

Final Result

Table with 10 columns: Frequency (MHz), QuasiPeak (dBuV), Average (dBuV), Limit (dBuV), Margin (dB), Meas. Time (ms), Bandwidth (kHz), Line, Filter, Corr. (dB). Contains 14 rows of test data for BLE N Line.



BLE, Channel No.: 19

L Line

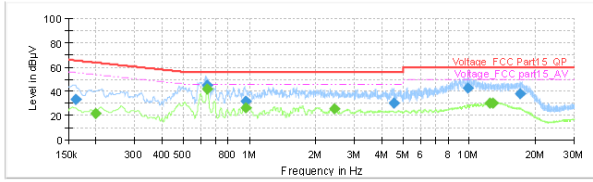

Final Result

Table with 10 columns: Frequency (MHz), QuasiPeak (dBµV), Average (dBµV), Limit (dBµV), Margin (dB), Meas. Time (ms), Bandwidth (kHz), Line, Filter, Corr. (dB). Contains 15 rows of test data.

N Line

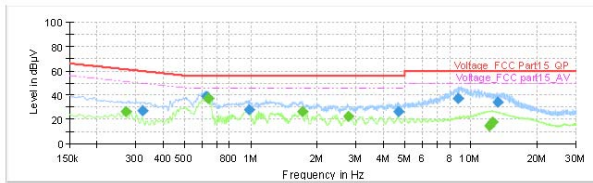

Final Result

Table with 10 columns: Frequency (MHz), QuasiPeak (dBµV), Average (dBµV), Limit (dBµV), Margin (dB), Meas. Time (ms), Bandwidth (kHz), Line, Filter, Corr. (dB). Contains 15 rows of test data.

BLE, Channel No.: 39

L Line

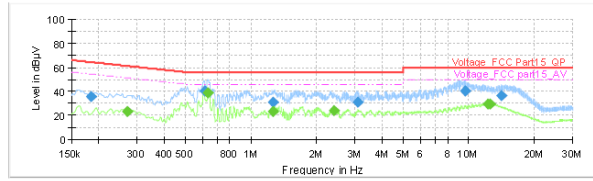

Final Result

Table with 10 columns: Frequency (MHz), QuasiPeak (dBµV), Average (dBµV), Limit (dBµV), Margin (dB), Meas. Time (ms), Bandwidth (kHz), Line, Filter, Corr. (dB). Contains 15 rows of test data.

N Line

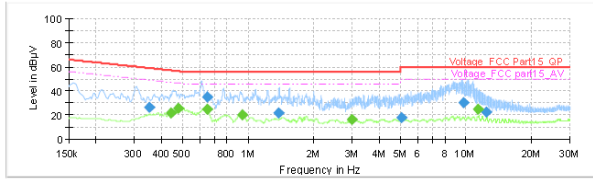

Final Result

Table with 10 columns: Frequency (MHz), QuasiPeak (dBµV), Average (dBµV), Limit (dBµV), Margin (dB), Meas. Time (ms), Bandwidth (kHz), Line, Filter, Corr. (dB). Contains 15 rows of test data.



## 6. Main Test Instruments

Name	Manufacturer	Type	Serial Number	Calibration Date	Expiration Time
Spectrum Analyzer	R&S	FSV30	100815	2016-12-16	2017-12-15
EMI Test Receiver	R&S	ESCI	100948	2017-05-20	2018-05-19
TRILOG Broadband Antenna	Schwarzbeck	VULB 9163	9163-201	2014-12-06	2017-12-05
Double Ridged Waveguide Horn Antenna	R&S	HF907	100126	2014-12-06	2017-12-05
Loop Antenna	SCHWARZBECK	FMZB1519	1519-047	2017-02-18	2020-02-17
Standard Gain Horn	ETS-Lindgren	3160-09	00102644	2015-01-30	2018-01-29
EMI Test Receiver	R&S	ESCS30	100138	2016-12-16	2017-12-15
LISN	R&S	ENV216	101171	2016-12-16	2019-12-15
Spectrum Analyzer	Agilent	N9010A	MY47191109	2017-05-20	2018-05-19
RF Cable	Agilent	SMA 15cm	0001	2017-02-06	2017-08-05

\*\*\*\*\*END OF REPORT \*\*\*\*\*

## ANNEX A: EUT Appearance and Test Setup

### A.1 EUT Appearance



Front Side



Back Side

a: EUT



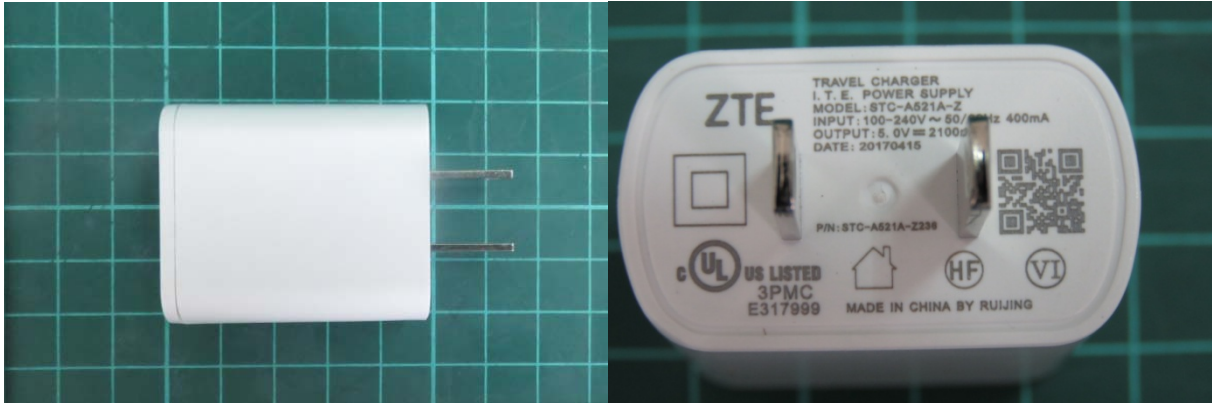

Adapter 1

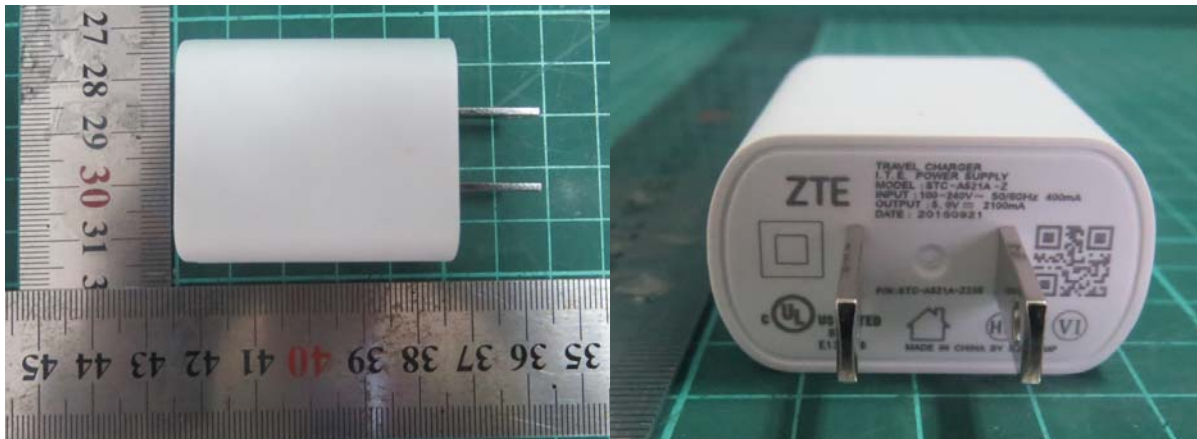

Adapter 2  
b : Adapter

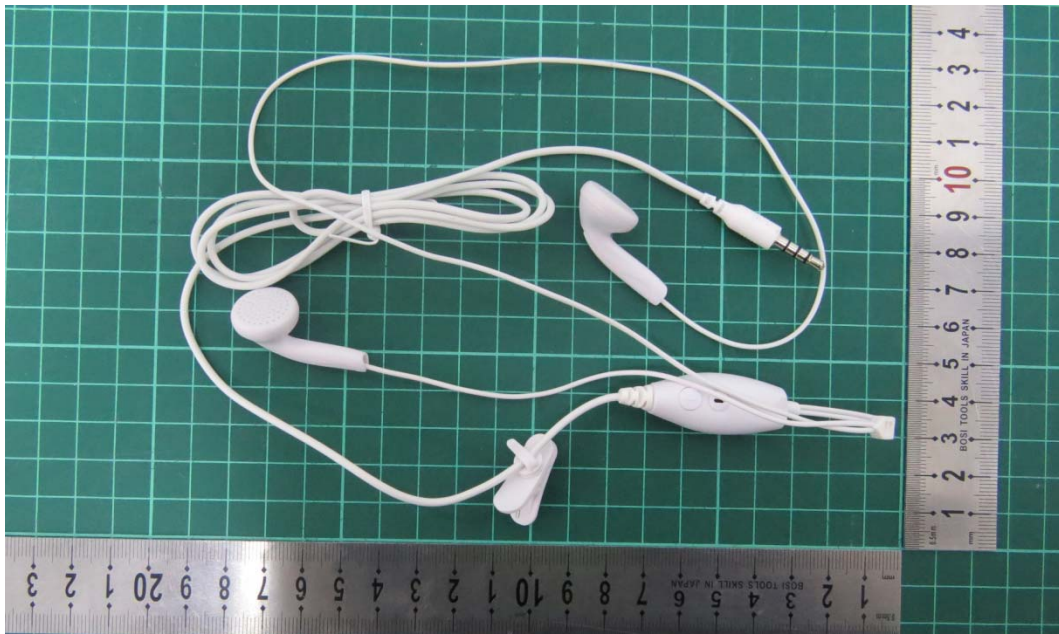

Earphone 1

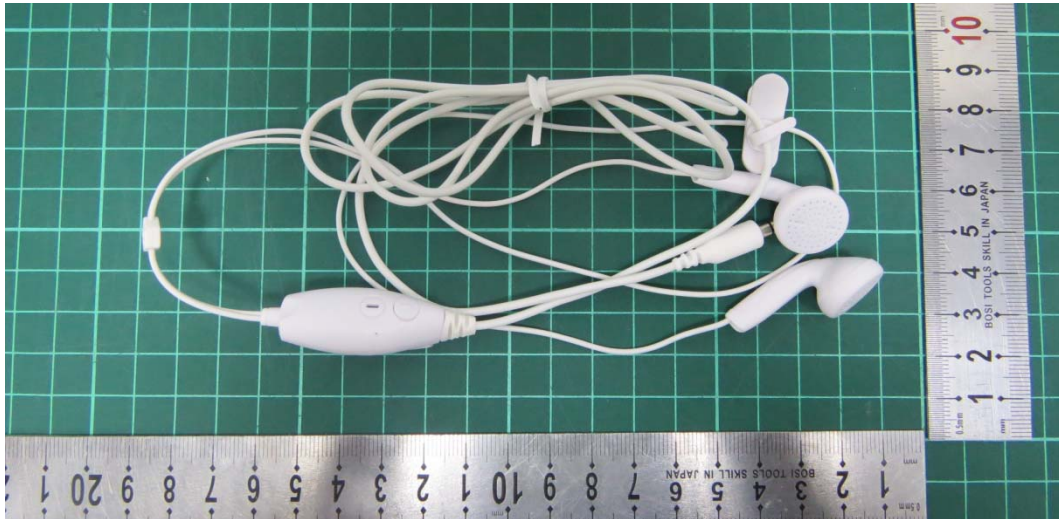

Earphone 2  
c : Earphone



USB Cable 1



USB Cable 2  
d : USB Cable

**Picture 1 EUT and Accessory**

## A.2 Test Setup

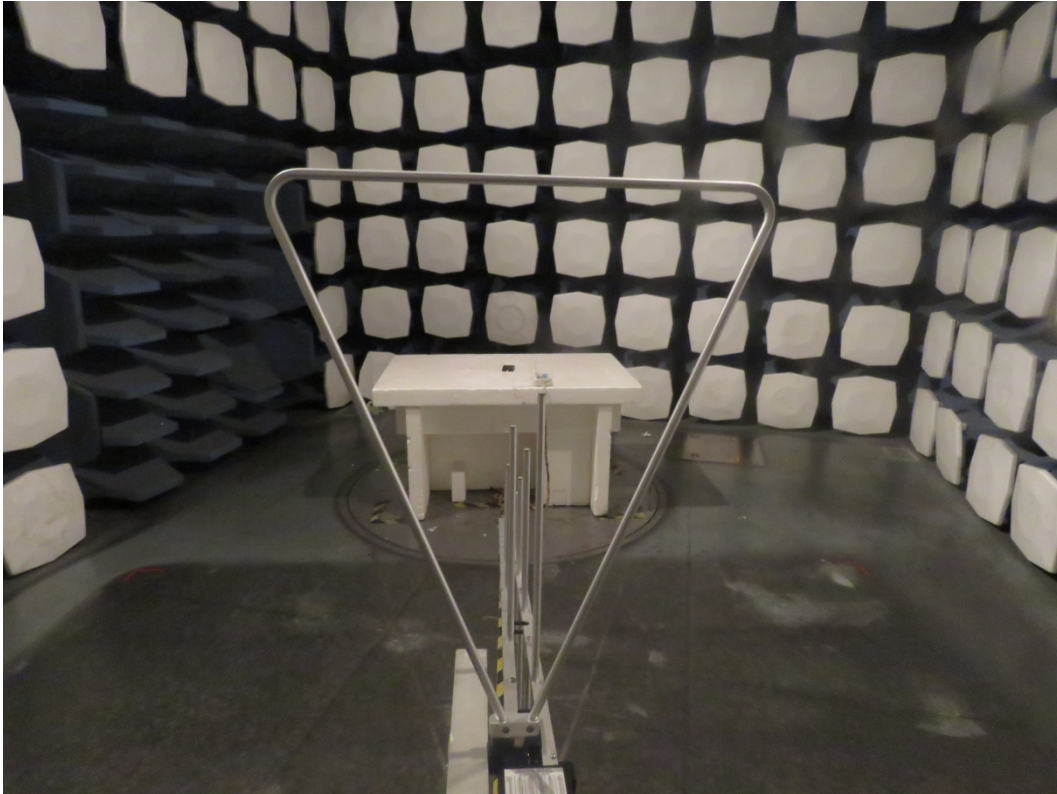

30M Hz-1GHz

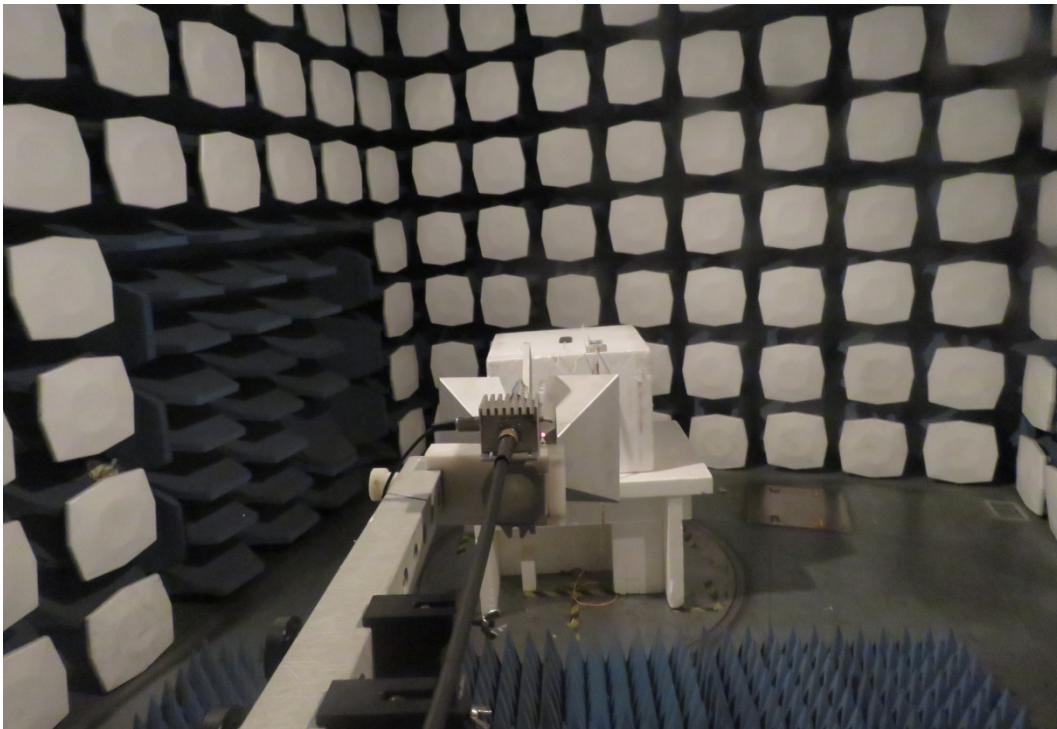

Above 1GHz

**Picture 2 Radiated Emission Test Setup**

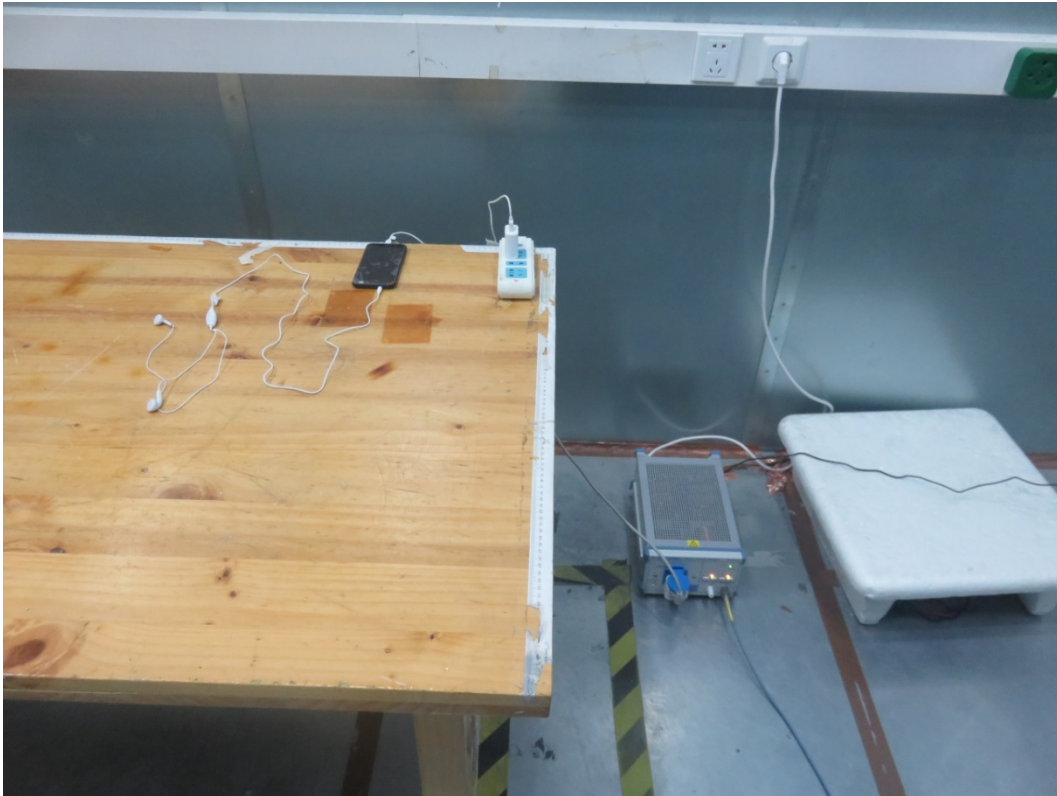

**Picture 3 Conducted Emission Test Setup**