



RF TEST REPORT

Applicant ZTE Corporation

FCC ID SRQ-ZTEBLADEA321

Product LTE/WCDMA/GSM (GPRS)
Multi-Mode Digital Mobile Phone

Model ZTE BLADE A321
/ ZTE BLADE A320SE

Report No. RXA1706-0187RF01

Issue Date July 13, 2017

TA Technology (Shanghai) Co., Ltd. tested the above equipment in accordance with the requirements in **FCC CFR47 Part 2 (2017)/ FCC CFR 47 Part 22H (2017)**. The test results show that the equipment tested is capable of demonstrating compliance with the requirements as documented in this report.

Performed by: Jiangpeng Lan

Approved by: Kai Xu

TA Technology (Shanghai) Co., Ltd.

No.145, Jintang Rd, Tangzhen Industry Park, Pudong Shanghai, China

TEL: +86-021-50791141/2/3

FAX: +86-021-50791141/2/3-8000



TABLE OF CONTENT

1. Test Laboratory	4
1.1. Notes of the Test Report	4
1.2. Test facility	4
1.3. Testing Location	5
2. General Description of Equipment under Test.....	6
3. Applied Standards.....	8
4. Test Configuration.....	9
5. Test Case Results.....	11
5.1. RF Power Output.....	11
5.2. Effective Radiated Power	15
5.3. Occupied Bandwidth	20
5.4. Band Edge Compliance.....	29
5.5. Peak-to-Average Power Ratio (PAPR)	37
5.6. Frequency Stability	40
5.7. Spurious Emissions at Antenna Terminals	44
5.8. Radiates Spurious Emission	50
6. Main Test Instruments	62
ANNEX A: EUT Appearance and Test Setup.....	63
A.1 EUT Appearance	63
A.2 Test Setup.....	65

Summary of measurement results

No.	Test Type	Clause in FCC rules	Verdict
1	RF power output	2.1046	PASS
2	Effective Radiated Power	22.913(a)(2)	PASS
3	Occupied Bandwidth	2.1049	PASS
4	Band Edge Compliance	2.1051 / 22.917(a)	PASS
5	Peak-to-Average Power Ratio	22.913(d)/ KDB 971168 D01(5.7)	PASS
6	Frequency Stability	2.1055 / 22.355	PASS
7	Spurious Emissions at Antenna Terminals	2.1051 / 22.917(a)	PASS
8	Radiates Spurious Emission	2.1053 / 22.917 (a)	PASS
Date of Testing: June 16, 2017~ July 7, 2017			
Note: PASS: The EUT complies with the essential requirements in the standard. FAIL: The EUT does not comply with the essential requirements in the standard.			



1. Test Laboratory

1.1. Notes of the Test Report

This report shall not be reproduced in full or partial, without the written approval of **TA technology (shanghai) co., Ltd.** The results documented in this report apply only to the tested sample, under the conditions and modes of operation as described herein .Measurement Uncertainties were not taken into account and are published for informational purposes only. This report is written to support regulatory compliance of the applicable standards stated above. This report must not be used by the client to claim product certification, approval, or endorsement by any government agencies.

1.2. Test facility

CNAS (accreditation number: L2264)

TA Technology (Shanghai) Co., Ltd. has obtained the accreditation of China National Accreditation Service for Conformity Assessment (CNAS).

FCC (recognition number is 428261)

TA Technology (Shanghai) Co., Ltd. has been listed on the US Federal Communications Commission list of test facilities recognized to perform electromagnetic emissions measurements.

IC (recognition number is 8510A)

TA Technology (Shanghai) Co., Ltd. has been listed by industry Canada to perform electromagnetic emission measurement.

VCCI (recognition number is C-4595, T-2154, R-4113, G-10766)

TA Technology (Shanghai) Co., Ltd. has been listed by industry Japan to perform electromagnetic emission measurement.

A2LA (Certificate Number: 3857.01)

TA Technology (Shanghai) Co., Ltd. has been listed by American Association for Laboratory Accreditation to perform electromagnetic emission measurement.



1.3. Testing Location

Company: TA Technology (Shanghai) Co., Ltd.
Address: No.145, Jintang Rd, Tangzhen Industry Park, Pudong
City: Shanghai
Post code: 201201
Country: P. R. China
Contact: Xu Kai
Telephone: +86-021-50791141/2/3
Fax: +86-021-50791141/2/3-8000
Website: <http://www.ta-shanghai.com>
E-mail: xukai@ta-shanghai.com

2. General Description of Equipment under Test

Client Information

Applicant	ZTE Corporation
Applicant address	ZTE Plaza, Keji Road South, Hi-Tech, Industrial Park, Nanshan District, Shenzhen, Guangdong, 518057, P.R.China
Manufacturer	ZTE Corporation
Manufacturer address	ZTE Plaza, Keji Road South, Hi-Tech, Industrial Park, Nanshan District, Shenzhen, Guangdong, 518057, P.R.China

General Information

EUT Description			
Model	ZTE BLADE A321 / ZTE BLADE A320SE		
IMEI	865984030000177		
HW Version	ucuA		
SW Version	GEN_LA_A321_V1.0		
Power Supply	Battery/AC adapter		
Antenna Type	Internal Antenna		
Test Mode(s)	GSM 850: WCDMA Band V;LTE Band 5		
Test Modulation	(GSM)GMSK,8PSK; (WCDMA)QPSK; (LTE)QPSK 16QAM;		
GPRS Multislot Class	12		
EGPRS Multislot Class	33		
HSDPA UE Category	24		
HSUPA UE Category	6		
LTE Category	4		
Maximum E.R.P.	GSM 850:	26.87 dBm	
	WCDMA Band V:	18.15 dBm	
	LTE Band 5:	18.50 dBm	
Rated Power Supply Voltage	3.8V		
Extreme Voltage	Minimum: 3.6V Maximum: 4.35V		
Extreme Temperature	Lowest: -10°C Highest: +55°C		
Operating Frequency Range(s)	Band	Tx (MHz)	Rx (MHz)
	GSM850	824 ~ 849	869 ~ 894
	WCDMA Band V	824 ~ 849	869 ~ 894
	LTE Band 5	824 ~ 849	869 ~ 894



EUT Accessory	
Battery	Manufacturer: BYD Model: Li3822T43P4h736040 Power Rating: DC 3.8V, 2200mAh, Li-ion
Adapter	Manufacturer: DOCOKOM Model: STC-A508A-Z
USB Cable	99cm Cable, Shielded
Note: The information of the EUT is declared by the manufacturer.	



3. Applied Standards

According to the specifications of the manufacturer, it must comply with the requirements of the following standards:

FCC CFR47 Part 2 (2017)

FCC CFR 47 Part 22H (2017)

ANSI C63.26 (2015)

KDB 971168 D01 Power Meas License Digital Systems v02r02

4. Test Configuration

Radiated measurements are performed by rotating the EUT in three different orthogonal test planes. EUT stand-up position (Z axis), lie-down position (X, Y axis). Receiver antenna polarization (horizontal and vertical), the worst emission was found in position (Z axis, vertical polarization) and the worst case was recorded.

All mode and data rates and positions were investigated. Subsequently, only the worst case emissions are reported.

The following testing in GSMWCDMA/LTE is set based on the maximum RF Output Power.

Test modes are chosen to be reported as the worst case configuration below:

	Test items	Modes/Modulation	
		GSM 850	WCDMA Band V
Conducted Test cases	RF power output	GSM GPRS(1Tx slot) EGPRS(1Tx slot)	RMC HSDPA/HSUPA DC-HSDPA
	Occupied Bandwidth	GSM GPRS(1Tx slot) EGPRS(1Tx slot)	RMC
	Band Edge Compliance	GSM GPRS(1Tx slot) EGPRS(1Tx slot)	RMC
	Peak-to-Average Power Ratio	GSM GPRS(1Tx slot) EGPRS(1Tx slot)	RMC
	Frequency Stability	GSM GPRS(1Tx slot) EGPRS(1Tx slot)	RMC
	Spurious Emissions at Antenna Terminals	GSM	RMC
Radiated Test cases	Effective Radiated Power	GSM GPRS(1Tx slot) EGPRS(1Tx slot)	RMC
	Radiates Spurious Emission	GSM	RMC



Test modes are chosen as the worst case configuration below for LTE Band 5.

Test items	Bandwidth (MHz)				Modulation		RB			Test Channel		
	1.4	3	5	10	QPSK	16QAM	1	50%	100%	L	M	H
RF power output	○	○	○	○	○	○	○	○	○	○	○	○
Effective Isotropic Radiated power	○	○	○	○	○	○	-	-	○	○	○	○
Occupied Bandwidth	○	○	○	○	○	○	-	-	○	○	○	○
Band Edge Compliance	○	○	○	○	○	○	○	-	○	○	-	○
Peak-to-Average Power Ratio	○	○	○	○	○	○	-	-	○	○	○	○
Frequency Stability	○	○	○	○	○	○	-	-	○	-	○	-
Spurious Emissions at Antenna Terminals	○	○	○	○	○	-	○	-	-	○	○	○
Radiates Spurious Emission	○	○	○	○	○	-	○	-	-	○	○	○
Note	1. The mark "○" means that this configuration is chosen for testing. 2. The mark "-" means that this configuration is not testing.											

5. Test Case Results

5.1. RF Power Output

Ambient condition

Temperature	Relative humidity	Pressure
23°C ~25°C	45%~50%	101.5kPa

Methods of Measurement

During the process of the testing, The EUT is controlled by the Base Station Simulator to ensure max power transmission and proper modulation.

Test Setup

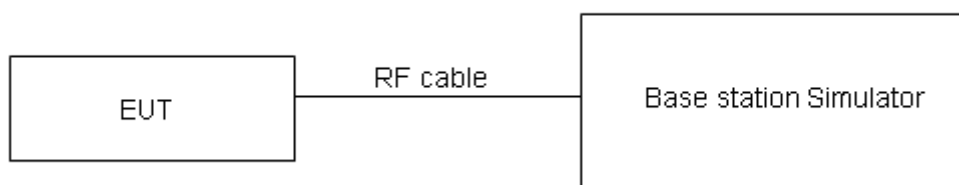

The loss between RF output port of the EUT and the input port of the tester has been taken into consideration.

Limits

No specific RF power output requirements in part 2.1046.

Measurement Uncertainty

The assessed measurement uncertainty to ensure 95% confidence level for the normal distribution is with the coverage factor $k = 2$, $U = 0.4$ dB.

Test Results

GSM 850		Conducted Power(dBm)		
		Channel 128	Channel 190	Channel 251
		824.2 (MHz)	836.6 (MHz)	848.8 (MHz)
GSM	Results	32.33	32.19	32.22
GPRS (GMSK)	1TXslot	32.33	32.10	32.25
	2TXslots	30.00	29.96	30.11
	3TXslots	28.01	27.86	27.82
	4TXslots	26.53	26.49	26.51
EGPRS (8PSK)	1TXslot	26.64	26.25	26.28
	2TXslots	24.04	24.03	24.28
	3TXslots	22.07	22.08	22.26
	4TXslots	21.05	21.09	21.46

WCDMA Band V		Conducted Power(dBm)		
		Channel 4132	Channel 4183	Channel 4233
		826.4(MHz)	836.6(MHz)	846.6(MHz)
RMC		22.56	22.50	22.65
HSDPA	Sub - Test 1	22.46	22.33	22.49
	Sub - Test 2	22.40	22.34	22.48
	Sub - Test 3	21.89	21.94	22.06
	Sub - Test 4	21.90	21.93	22.08
HSUPA	Sub - Test 1	22.39	22.42	22.57
	Sub - Test 2	20.64	20.58	20.73
	Sub - Test 3	21.46	21.40	21.55
	Sub - Test 4	20.65	20.59	20.74
	Sub - Test 5	22.44	22.38	22.53
DC-HSDPA	Sub - Test 1	22.43	22.37	22.52
	Sub - Test 2	22.52	22.35	22.51
	Sub - Test 3	22.01	21.84	22.00
	Sub - Test 4	22.00	21.83	21.99

LTE Band 5				Conducted Power(dBm)		
BW	Modulation	RB size	RB offset	Channel/Frequency(MHz)		
				20407/824.7	20525/836.5	20643/848.3
1.4MHz	QPSK	1	0	23.44	23.71	23.57
		1	2	23.37	23.48	23.67
		1	5	23.38	23.52	23.73
		3	0	23.28	23.26	23.29
		3	2	23.23	23.17	23.28
		3	3	23.14	23.18	23.28
		6	0	22.20	22.34	22.38
	16QAM	1	0	22.18	22.27	22.40
		1	2	22.24	22.15	22.29
		1	5	22.23	22.19	22.18
		3	0	22.21	22.24	22.19
		3	2	22.13	22.29	22.24
		3	3	22.22	22.21	22.17
		6	0	21.14	21.35	21.32
BW	Modulation	RB size	RB offset	Channel/Frequency(MHz)		
				20415/825.5	20525/836.5	20635/847.5
3MHz	QPSK	1	0	23.45	23.74	23.59
		1	7	23.41	23.54	23.72
		1	14	23.40	23.56	23.76
		8	0	22.38	22.38	22.42
		8	4	22.36	22.28	22.39
		8	7	22.24	22.31	22.39
		15	0	22.29	22.39	22.43
	16QAM	1	0	22.20	22.28	22.42
		1	7	22.27	22.22	22.33
		1	14	22.25	22.23	22.20
		8	0	21.33	21.38	21.32
		8	4	21.23	21.41	21.35
		8	7	21.32	21.33	21.30
		15	0	21.18	21.40	21.34
BW	Modulation	RB size	RB offset	Channel/Frequency(MHz)		
				20425/826.5	20525/836.5	20625/846.5
5MHz	QPSK	1	0	23.44	23.70	23.57



		1	13	23.39	23.53	23.69	
		1	24	23.37	23.51	23.72	
		12	0	22.36	22.34	22.39	
		12	6	22.33	22.23	22.35	
		12	13	22.21	22.28	22.35	
		25	0	22.27	22.35	22.38	
	16QAM	1	0	22.15	22.26	22.40	
		1	13	22.25	22.19	22.31	
		1	24	22.22	22.19	22.17	
		12	0	21.30	21.36	21.29	
		12	6	21.20	21.36	21.31	
		12	13	21.30	21.29	21.27	
			25	0	21.15	21.35	21.30
	BW	Modulation	RB size	RB offset	Channel/Frequency(MHz)		
20450/829					20525/836.5	20600/844	
10MHz	QPSK	1	0	23.41	23.66	23.54	
		1	25	23.38	23.49	23.67	
		1	49	23.35	23.50	23.69	
		25	0	22.33	22.29	22.35	
		25	13	22.31	22.19	22.32	
		25	25	22.18	22.23	22.31	
	16QAM	50	0	22.24	22.30	22.34	
		1	0	22.13	22.22	22.35	
		1	25	22.21	22.17	22.27	
		1	49	22.20	22.16	22.15	
		25	0	21.27	21.32	21.26	
		25	13	21.17	21.34	21.28	
		25	25	21.27	21.24	21.23	
			50	0	21.13	21.31	21.27

5.2. Effective Radiated Power

Ambient condition

Temperature	Relative humidity	Pressure
23°C ~25°C	45%~50%	101.5kPa

Methods of Measurement

1. The testing follows ANSI C63.26 (2015) Section 5.5.2.3.
2. EUT was placed on a 0.8 meter high non-conductive stand at a 3 meter test distance from the receive antenna. A receiving antenna was placed on the antenna mast 3 meters from the EUT for emission measurements. The height of receiving antenna between 1.0m and 4.0m. Detected emissions were maximized at each frequency by rotating the EUT through 360° and adjusting the receiving antenna polarization. The radiated emission measurements of all transmit frequencies in three channels (High, Middle, Low) were measured with peak detector.
3. A log-periodic antenna or double-ridged waveguide horn antenna shall be substituted in place of the EUT. The log-periodic antenna will be driven by a signal generator and the level will be adjusted till the same power value on the spectrum analyzer or receiver. The level of the spurious emissions can be calculated through the level of the signal generator, cable loss, the gain of the substitution antenna and the reading of the spectrum analyzer or receiver.
4. The EUT is then put into continuously transmitting mode at its maximum power level during the test. Set Test Receiver or Spectrum RBW=1MHz, VBW=3MHz for above 1GHz and RBW=100kHz, VBW=300kHz for 30MHz to 1GHz, And the maximum value of the receiver should be recorded as (Pr).
5. The EUT shall be replaced by a substitution antenna. In the chamber, an substitution antenna for the frequency band of interest is placed at the reference point of the chamber. An RF Signal source for the frequency band of interest is connected to the substitution antenna with a cable that has been constructed to not interfere with the radiation pattern of the antenna. A power (PMea) is applied to the input of the substitution antenna, and adjust the level of the signal generator output until the value of the receiver reach the previously recorded (Pr). The power of signal source (PMea) is recorded. The test should be performed by rotating the test item and adjusting the receiving antenna polarization.
6. A amplifier should be connected to the Signal Source output port. And the cable should be connect between the Amplifier and the Substitution Antenna. The cable loss (Pcl), the Substitution Antenna Gain (Ga) and the Amplifier Gain (PAg) should be recorded after test.
7. The measurement results are obtained as described below:
Power(EIRP)=PMea- PAg - Pcl + Ga
The measurement results are amend as described below:
Power(EIRP)=PMea- Pcl + Ga
8. This value is EIRP since the measurement is calibrated using an antenna of known gain (2.15 dBi) and known input power. ERP can be calculated from EIRP by subtracting the gain of the dipole, ERP = EIRP-2.15dBi.

Test configuration

Below 1GHz:

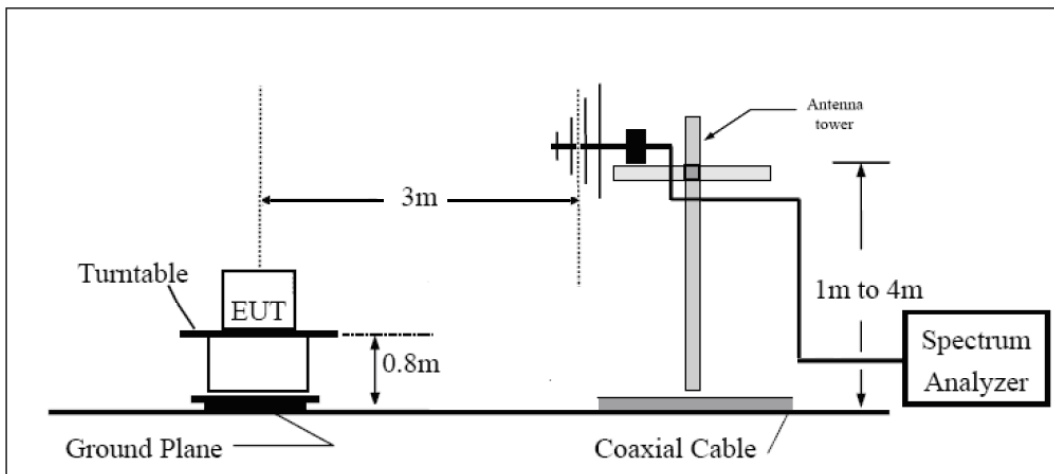

Above 1GHz:

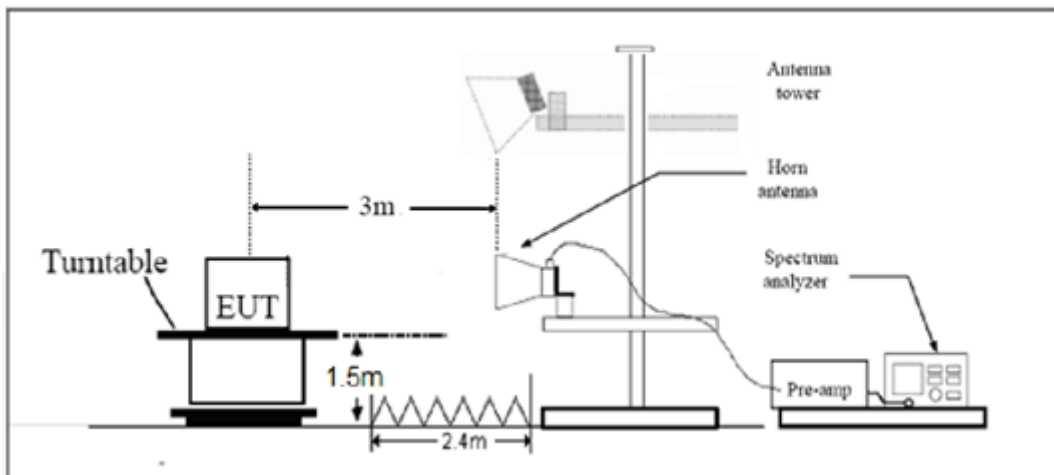

Limits

Rule Part 22.913(a) specifies that "Mobile/portable stations are limited to 7 watts ERP".

Limit	$\leq 7\text{ W}$ (38.45 dBm)
-------	-------------------------------

Measurement Uncertainty

The assessed measurement uncertainty to ensure 95% confidence level for the normal distribution is with the coverage factor $k = 2$, $U = 1.19\text{ dB}$



Test Results:

Mode	Polarization	Frequency (MHz)	Rt (dBm)	Rs (dBm)	Ps (dBm)	Gs (dBd)	ERP (dBm)	Limit (dBm)	Conclusion
GSM 850	H	824.2	-20.28	-45.53	0.00	1.06	26.31	38.45	Pass
	H	836.6	-19.95	-45.38	0.00	1.24	26.67	38.45	Pass
	H	848.8	-19.88	-45.37	0.00	1.38	26.87	38.45	Pass
	V	824.2	-34.54	-45.65	0.00	1.06	12.17	38.45	Pass
	V	836.6	-34.31	-45.46	0.00	1.24	12.39	38.45	Pass
	V	848.8	-34.20	-45.49	0.00	1.38	12.67	38.45	Pass
GPRS 850	H	824.2	-20.23	-45.53	0.00	1.06	26.36	38.45	Pass
	H	836.6	-20.04	-45.38	0.00	1.24	26.58	38.45	Pass
	H	848.8	-19.92	-45.37	0.00	1.38	26.83	38.45	Pass
	V	824.2	-34.52	-45.65	0.00	1.06	12.19	38.45	Pass
	V	836.6	-34.35	-45.46	0.00	1.24	12.35	38.45	Pass
	V	848.8	-34.17	-45.49	0.00	1.38	12.70	38.45	Pass
EGPRS 850	H	824.2	-20.60	-45.53	0.00	1.06	25.99	38.45	Pass
	H	836.6	-20.41	-45.38	0.00	1.24	26.21	38.45	Pass
	H	848.8	-20.29	-45.37	0.00	1.38	26.46	38.45	Pass
	V	824.2	-34.88	-45.65	0.00	1.06	11.82	38.45	Pass
	V	836.6	-34.71	-45.46	0.00	1.24	11.98	38.45	Pass
	V	848.8	-34.54	-45.49	0.00	1.38	12.33	38.45	Pass
WCDMA Band V	H	826.4	-29.90	-45.44	0.00	1.13	16.66	38.45	Pass
	H	836.6	-30.01	-45.38	0.00	1.24	16.61	38.45	Pass
	H	846.6	-29.81	-45.38	0.00	1.35	16.91	38.45	Pass
	V	826.4	-28.76	-45.54	0.00	1.13	17.90	38.45	Pass
	V	836.6	-28.65	-45.46	0.00	1.24	18.04	38.45	Pass
	V	846.6	-28.68	-45.49	0.00	1.35	18.15	38.45	Pass



LTE Band 5									
bandwidth	Polarization	Frequency (MHz)	Rt (dBm)	Rs (dBm)	Ps (dBm)	Gs (dBd)	ERP (dBm)	Limit (dBm)	Conclusion
1.4 MHz (QPSK)	H	824.7	-30.17	-47.61	0.00	1.06	18.50	38.45	Pass
	H	836.5	-30.76	-47.75	0.00	1.24	18.23	38.45	Pass
	H	848.3	-31.31	-48.23	0.00	1.38	18.30	38.45	Pass
	V	824.7	-45.62	-47.29	0.00	1.06	2.74	38.45	Pass
	V	836.5	-45.81	-47.15	0.00	1.24	2.58	38.45	Pass
	V	848.3	-46.33	-47.48	0.00	1.38	2.53	38.45	Pass
1.4 MHz (16QAM)	H	824.7	-30.30	-47.61	0.00	1.06	18.37	38.45	Pass
	H	836.5	-30.89	-47.75	0.00	1.24	18.10	38.45	Pass
	H	848.3	-31.44	-48.23	0.00	1.38	18.17	38.45	Pass
	V	824.7	-45.75	-47.29	0.00	1.06	2.61	38.45	Pass
	V	836.5	-45.94	-47.15	0.00	1.24	2.45	38.45	Pass
	V	848.3	-46.46	-47.48	0.00	1.38	2.41	38.45	Pass
3 MHz (QPSK)	H	825.5	-30.46	-47.59	0.00	1.06	18.20	38.45	Pass
	H	836.5	-30.85	-47.75	0.00	1.24	18.14	38.45	Pass
	H	847.5	-31.27	-48.18	0.00	1.38	18.29	38.45	Pass
	V	825.5	-45.79	-47.26	0.00	1.06	2.53	38.45	Pass
	V	836.5	-45.88	-47.15	0.00	1.24	2.51	38.45	Pass
	V	847.5	-46.09	-47.44	0.00	1.38	2.73	38.45	Pass
3 MHz (16QAM)	H	825.5	-30.58	-47.59	0.00	1.06	18.08	38.45	Pass
	H	836.5	-30.97	-47.75	0.00	1.24	18.02	38.45	Pass
	H	847.5	-31.39	-48.18	0.00	1.38	18.17	38.45	Pass
	V	825.5	-45.92	-47.26	0.00	1.06	2.41	38.45	Pass
	V	836.5	-46.00	-47.15	0.00	1.24	2.39	38.45	Pass
	V	847.5	-46.22	-47.44	0.00	1.38	2.61	38.45	Pass
5 MHz (QPSK)	H	826.5	-30.34	-47.60	0.00	1.13	18.38	38.45	Pass
	H	836.5	-30.91	-47.75	0.00	1.24	18.08	38.45	Pass
	H	846.5	-31.21	-48.12	0.00	1.38	18.29	38.45	Pass
	V	826.5	-46.16	-47.24	0.00	1.13	2.20	38.45	Pass
	V	836.5	-46.35	-47.15	0.00	1.24	2.04	38.45	Pass
	V	846.5	-46.25	-47.40	0.00	1.38	2.53	38.45	Pass
5 MHz (16QAM)	H	826.5	-30.71	-47.60	0.00	1.13	18.02	38.45	Pass
	H	836.5	-31.27	-47.75	0.00	1.24	17.72	38.45	Pass
	H	846.5	-31.58	-48.12	0.00	1.38	17.93	38.45	Pass
	V	826.5	-46.53	-47.24	0.00	1.13	1.84	38.45	Pass
	V	836.5	-46.71	-47.15	0.00	1.24	1.68	38.45	Pass
	V	846.5	-46.62	-47.40	0.00	1.38	2.17	38.45	Pass



LTE Band 5									
bandwidth	Polarization	Frequency (MHz)	Rt (dBm)	Rs (dBm)	Ps (dBm)	Gs (dBd)	ERP (dBm)	Limit (dBm)	Conclusion
10 MHz (QPSK)	H	829	-30.32	-47.61	0.00	1.13	18.41	38.45	Pass
	H	836.5	-30.60	-47.75	0.00	1.24	18.39	38.45	Pass
	H	844	-31.04	-48.01	0.00	1.33	18.29	38.45	Pass
	V	829	-45.79	-47.19	0.00	1.13	2.52	38.45	Pass
	V	836.5	-45.97	-47.15	0.00	1.24	2.42	38.45	Pass
	V	844	-46.18	-47.29	0.00	1.33	2.43	38.45	Pass
10 MHz (16QAM)	H	829	-30.56	-47.61	0.00	1.13	18.18	38.45	Pass
	H	836.5	-30.83	-47.75	0.00	1.24	18.16	38.45	Pass
	H	844	-31.27	-48.01	0.00	1.33	18.06	38.45	Pass
	V	829	-46.03	-47.19	0.00	1.13	2.29	38.45	Pass
	V	836.5	-46.20	-47.15	0.00	1.24	2.19	38.45	Pass
	V	844	-46.41	-47.29	0.00	1.33	2.20	38.45	Pass

5.3. Occupied Bandwidth

Ambient condition

Temperature	Relative humidity	Pressure
23°C ~25°C	45%~50%	101.5kPa

Method of Measurement

The EUT was connected to Spectrum Analyzer and Base Station Simulator via power Splitter. The occupied bandwidth is measured using spectrum analyzer.

RBW is set to 3 kHz, VBW is set to 10kHz for GSM 850,

RBW is set to 51 kHz, VBW is set to 160kHz for WCDMA Band V,

RBW is set to 51 kHz, VBW is set to 160 kHz for LTE Band 5 (1.4MHz),

RBW is set to 100 kHz, VBW is set to 300 kHz for LTE Band 5 (3MHz/5MHz),

RBW is set to 300 kHz, VBW is set to 1MHz for LTE Band 5 (10MHz),

99% power and -26dBc occupied bandwidths are recorded. Spectrum analyzer plots are included on the following pages.

Test Setup

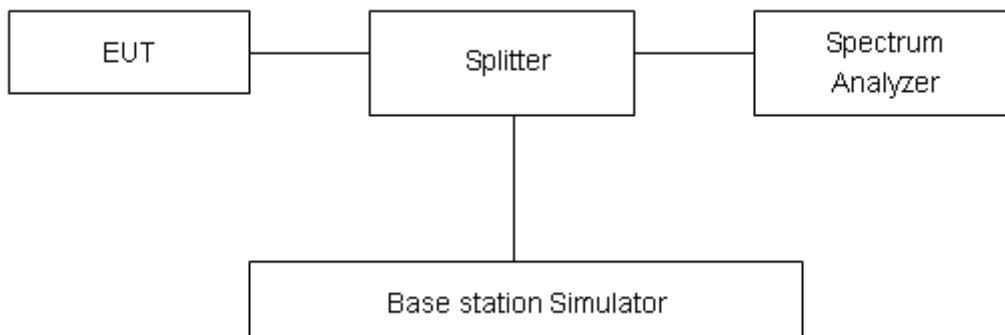

Limits

No specific occupied bandwidth requirements in part 2.1049.

Measurement Uncertainty

The assessed measurement uncertainty to ensure 95% confidence level for the normal distribution is with the coverage factor $k = 2$, $U = 624\text{Hz}$.

Test Result

Mode	Channel	Frequency (MHz)	99% Power Bandwidth (MHz)	-26dBc Bandwidth(MHz)
GSM 850 (GSM)	128	824.2	0.24582	0.3081
	190	836.6	0.24782	0.3114
	251	848.8	0.24443	0.3133
GPRS 850 (GMSK)	128	824.2	0.24508	0.3123
	190	836.6	0.24401	0.3141
	251	848.8	0.24521	0.3156
EGPRS 850 (8-PSK)	128	824.2	0.24655	0.3069
	190	836.6	0.2440	0.3136
	251	848.8	0.24637	0.3153
WCDMA Band V (RMC)	4357	871.4	4.1400	4.6990
	4408	881.6	4.1292	4.7010
	4458	891.6	4.1349	4.6990



LTE Band 5						
RB	Modulation	Bandwidth (MHz)	Channel	Frequency (MHz)	99% Power Bandwidth(MHz)	-26dBc Bandwidth(MHz)
100%	QPSK	1.4	20407	824.7	1.1248	1.346
			20525	836.5	1.1266	1.349
			20643	848.3	1.1303	1.334
		3	20415	825.5	2.7533	3.057
			20525	836.5	2.7467	3.073
			20635	847.5	2.7417	3.057
		5	20425	826.5	4.5323	5.054
			20525	836.5	4.5186	5.005
			20625	846.5	4.5062	5.012
		10	20450	829	8.9934	10.03
			20525	836.5	9.089	10.10
			20600	844	9.0239	10.00
	16QAM	1.4	20407	824.7	1.1266	1.341
			20525	836.5	1.1185	1.327
			20643	848.3	1.1204	1.349
		3	20415	825.5	2.7394	3.071
			20525	836.5	2.7545	3.073
			20635	847.5	2.7247	3.070
		5	20425	826.5	4.5205	5.046
			20525	836.5	4.5432	5.017
			20625	846.5	4.5342	5.032
		10	20450	829	8.9945	9.975
			20525	836.5	9.068	10.02
			20600	844	9.052	10.06



GSM 850 CH-Low



GSM 850 GPRS CH-Low

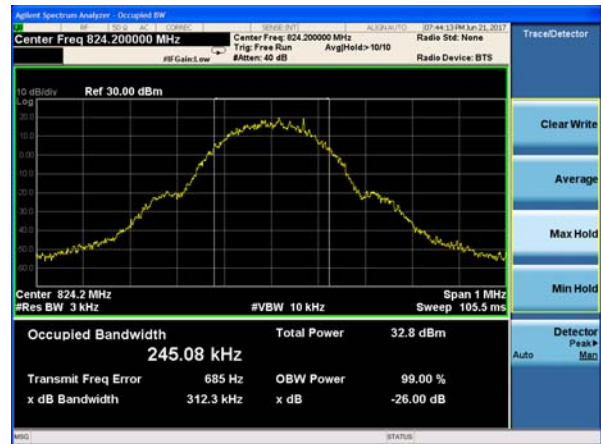

GSM 850 CH-Middle

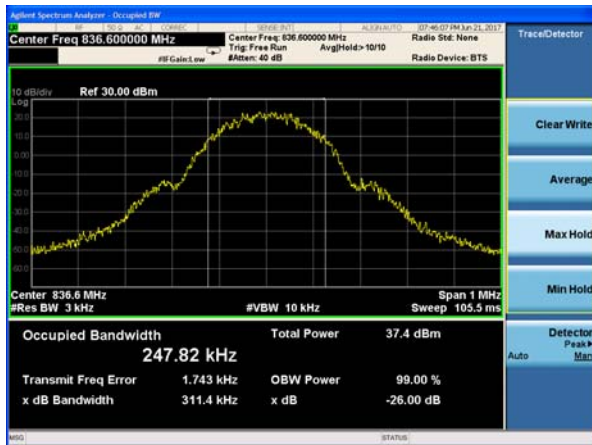

GSM 850 GPRS CH-Middle



GSM 850 CH-High



GSM 850 GPRS CH-High





GSM 850 EGPRS CH-Low

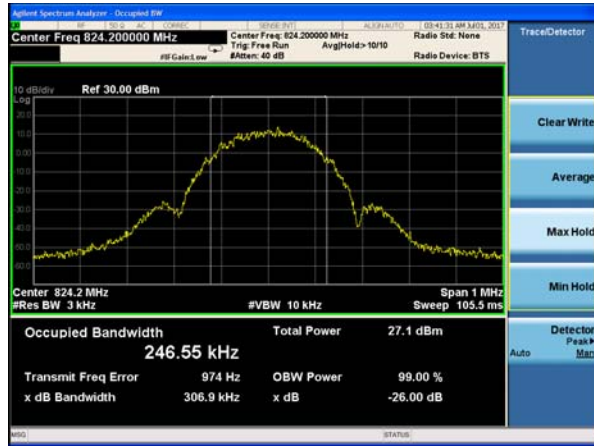

WCDMA Band V CH-Low

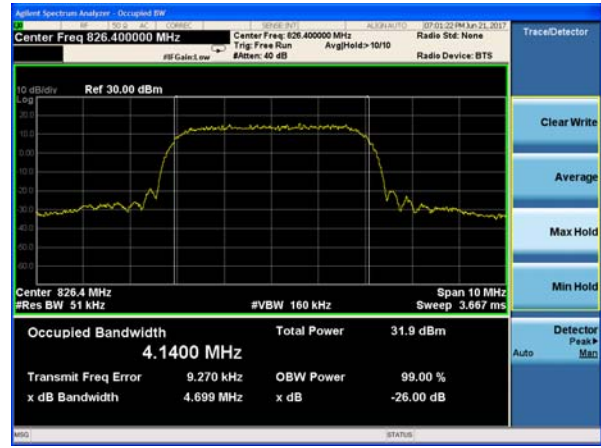

GSM 850 EGPRS CH-Middle

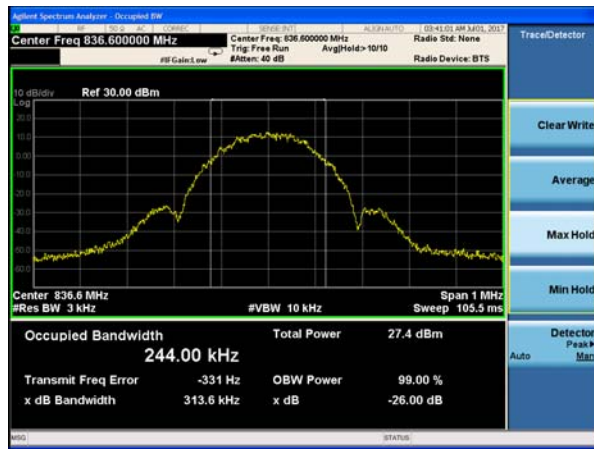

WCDMA Band V CH-Middle

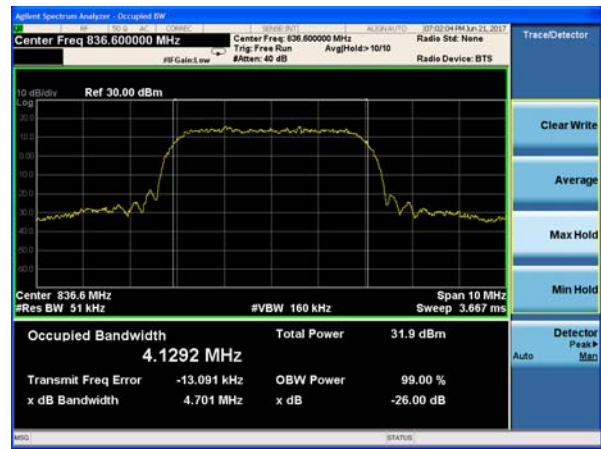

GSM 850 EGPRS CH-High

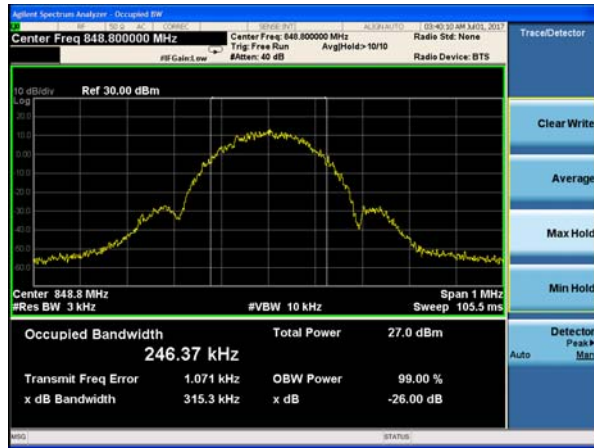

WCDMA Band V CH-High

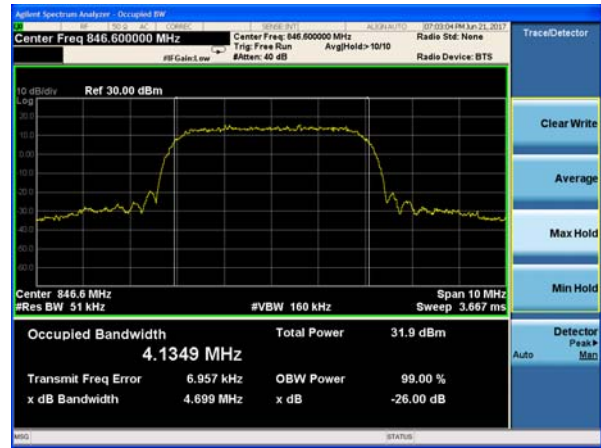



LTE Band 5 QPSK 1.4MHz CH-Low

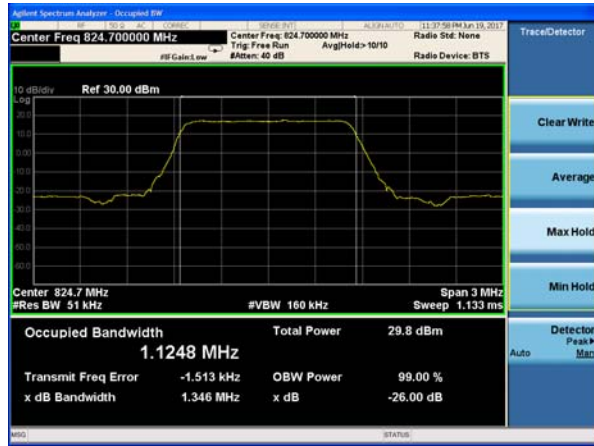

LTE Band 5 QPSK 3MHz CH-Low

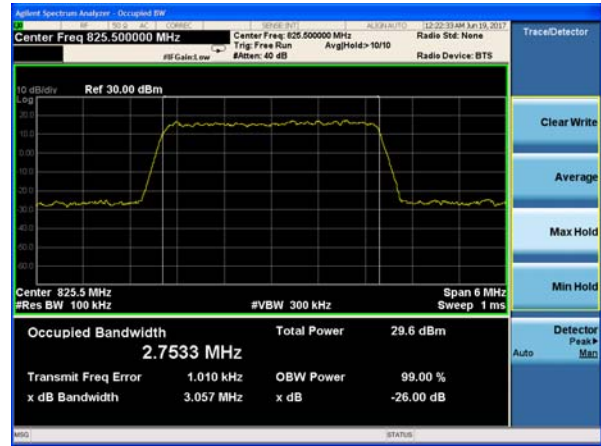

LTE Band 5 QPSK 1.4MHz CH-Middle

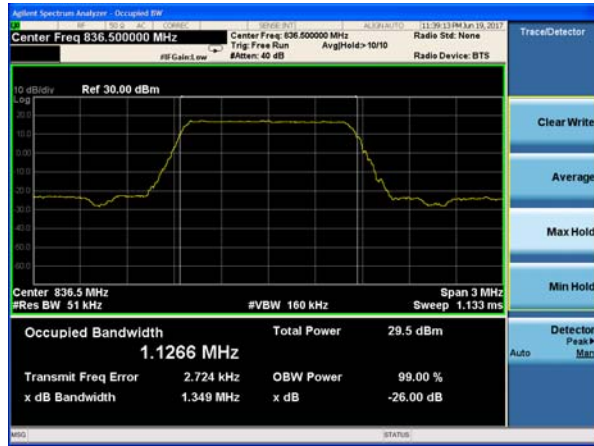

LTE Band 5 QPSK 3MHz CH-Middle

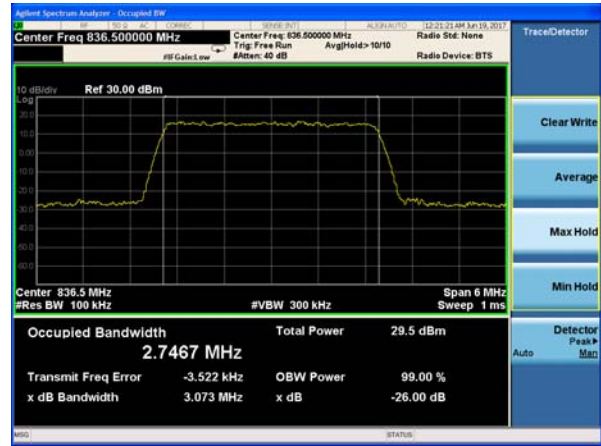

LTE Band 5 QPSK 1.4MHz CH-High

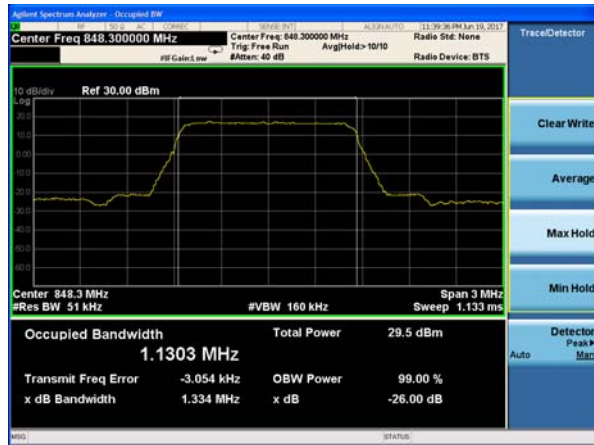

LTE Band 5 QPSK 3MHz CH-High

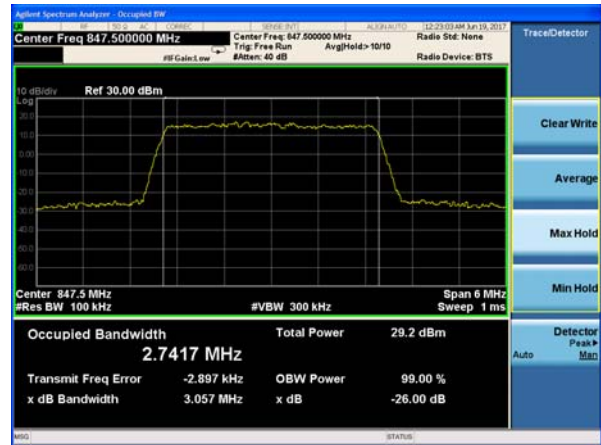



LTE Band 5 QPSK 5MHz CH-Low

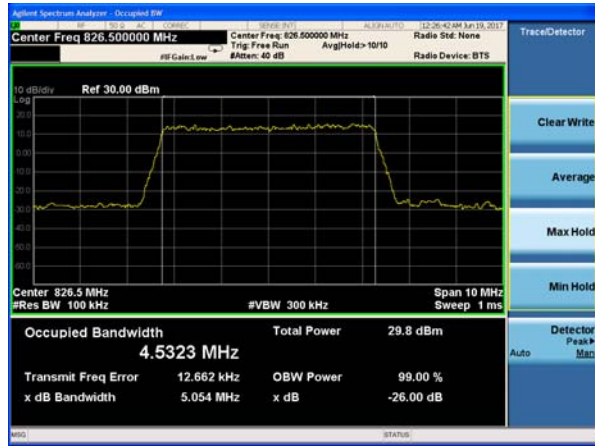

LTE Band 5 QPSK 10MHz CH-Low



LTE Band 5 QPSK 5MHz CH-Middle

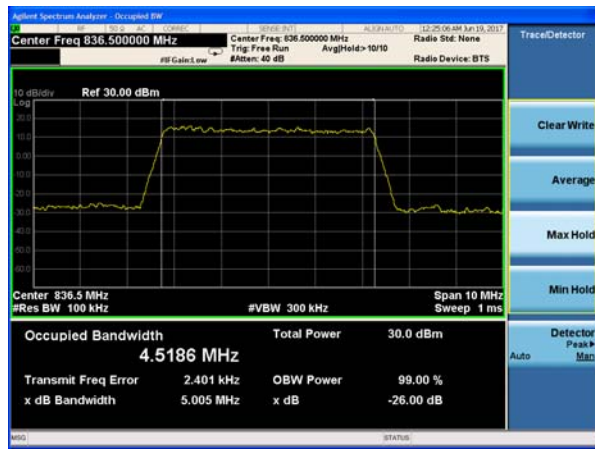

LTE Band 5 QPSK 10MHz CH-Middle



LTE Band 5 QPSK 5MHz CH-High

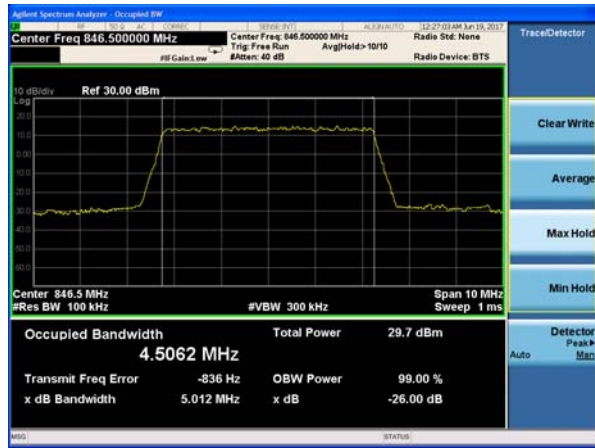

LTE Band 5 QPSK 10MHz CH-High





LTE Band 5 16QAM 1.4MHz CH-Low

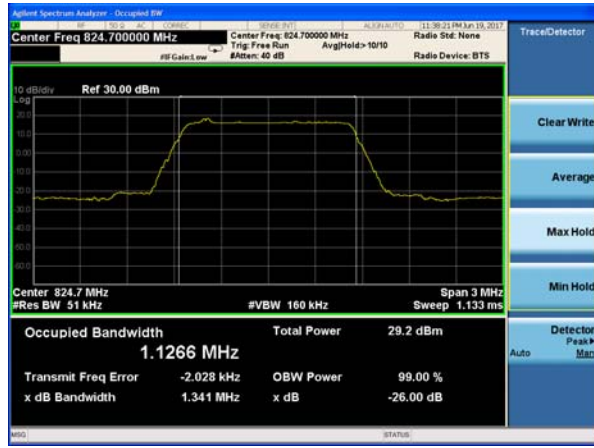

LTE Band 5 16QAM 3MHz CH-Low

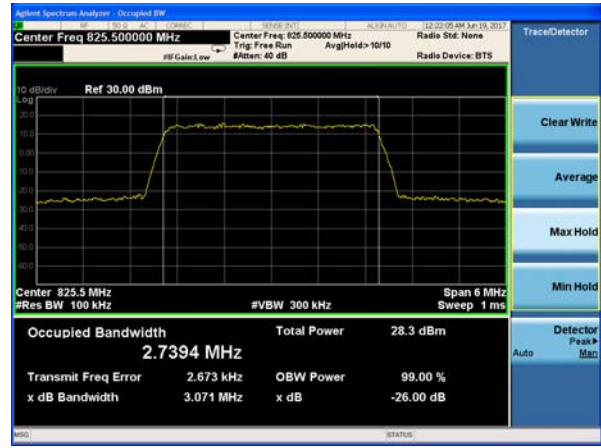

LTE Band 5 16QAM 1.4MHz CH-Middle

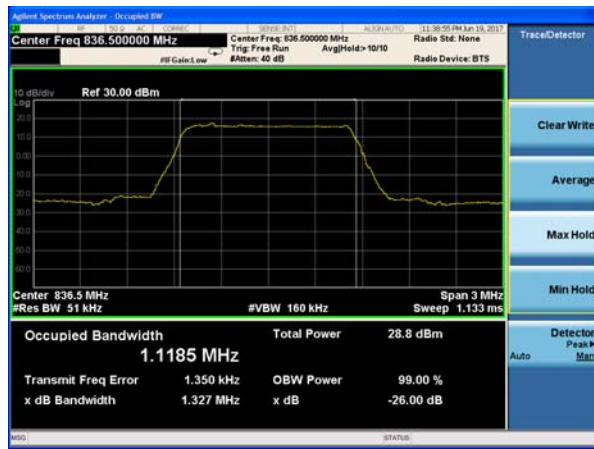

LTE Band 5 16QAM 3MHz CH-Middle

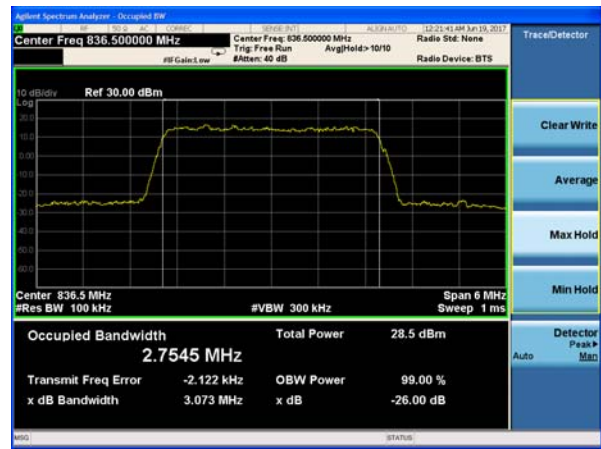

LTE Band 5 16QAM 1.4MHz CH-High

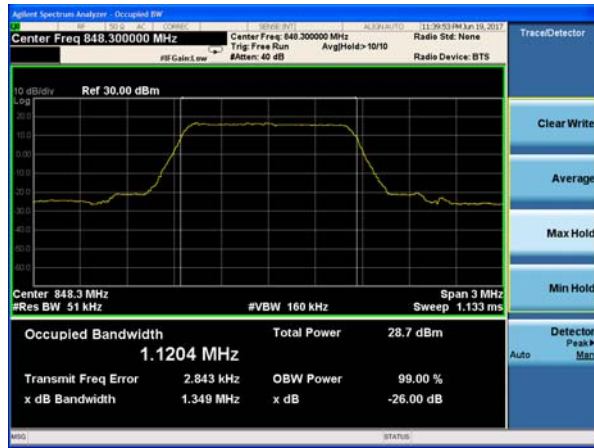

LTE Band 5 16QAM 3MHz CH-High



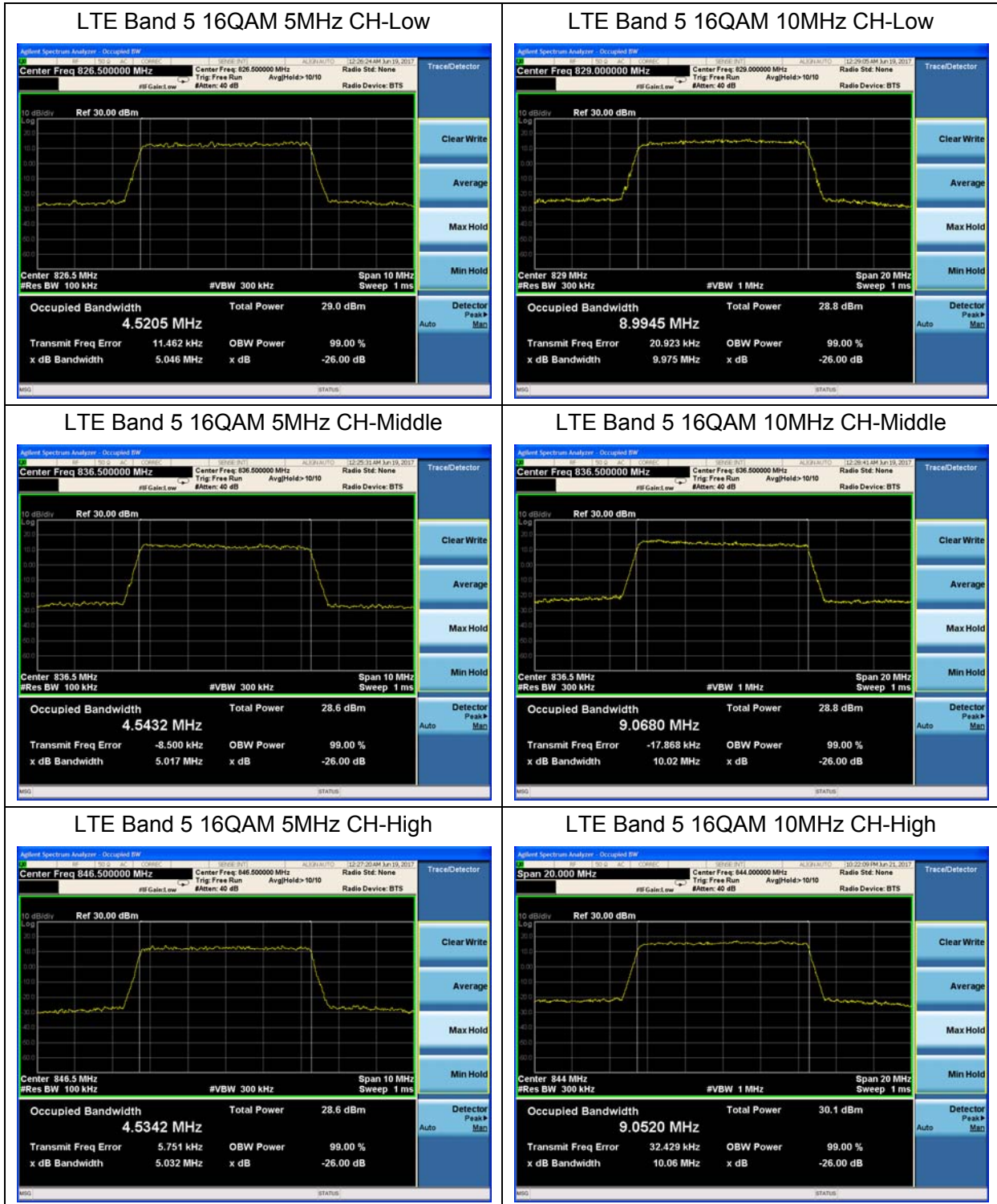

5.4. Band Edge Compliance

Ambient condition

Temperature	Relative humidity	Pressure
23°C ~25°C	45%~50%	101.5kPa

Method of Measurement

The EUT was connected to Spectrum Analyzer and Base Station Simulator via power Splitter. The band edge of the lowest and highest channels were measured. The average detector is used.

RBW is set to 3kHz,VBW is set to 10kHz for GSM 850.

RBW is set to 51kHz,VBW is set to 160kHz for WCDMA Band V,

RBW is set to 15 kHz, VBW is set to 51 kHz for LTE Band 5 (1.4MHz),

RBW is set to 30 kHz, VBW is set to 100 kHz for LTE Band 5(3MHz),

RBW is set to 51 kHz, VBW is set to 160 kHz for LTE Band 5 (5MHz),

RBW is set to 100 kHz, VBW is set to 300 kHz for LTE Band 5 (10MHz),

Spectrum analyzer plots are included on the following pages.

Test Setup

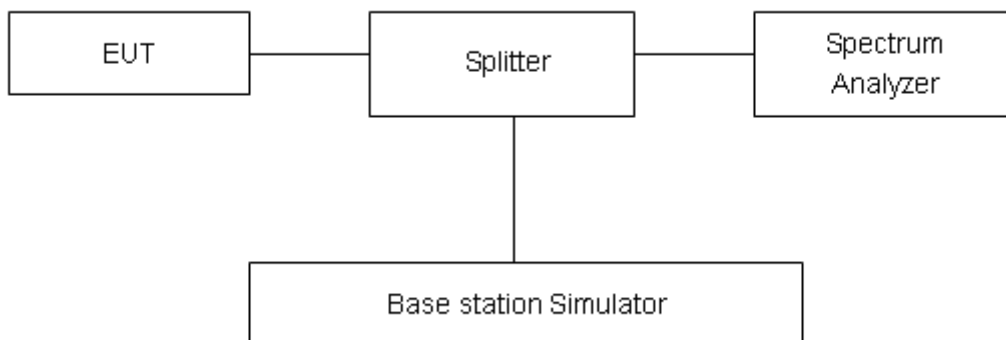

Limits

Rule Part 22.917(a) specifies that “The power of any emission outside of the authorized operating frequency ranges must be attenuated below the transmitting power (P) by a factor of at least 43 + 10 log(P) dB.”

Limit	-13 dBm
-------	---------

Measurement Uncertainty

The assessed measurement uncertainty to ensure 95% confidence level for the normal distribution is with the coverage factor $k = 1.96$, $U=0.684$ dB.



Test Result:

GSM 850 CH-Low



GSM 850 CH-High



GSM 850 GPRS CH-Low



GSM 850 GPRS CH-High



GSM 850 EGPRS CH-Low

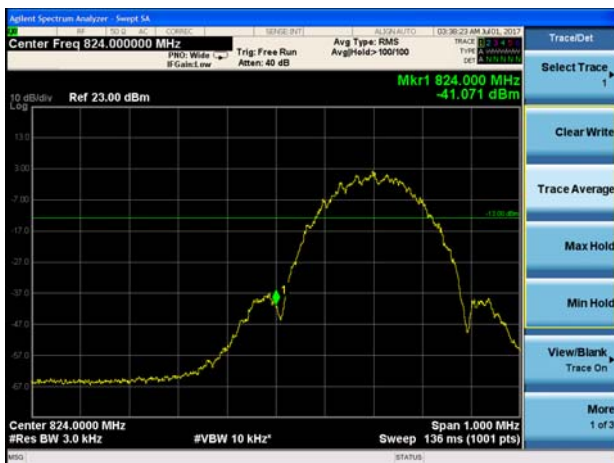

GSM 850 EGPRS CH-High

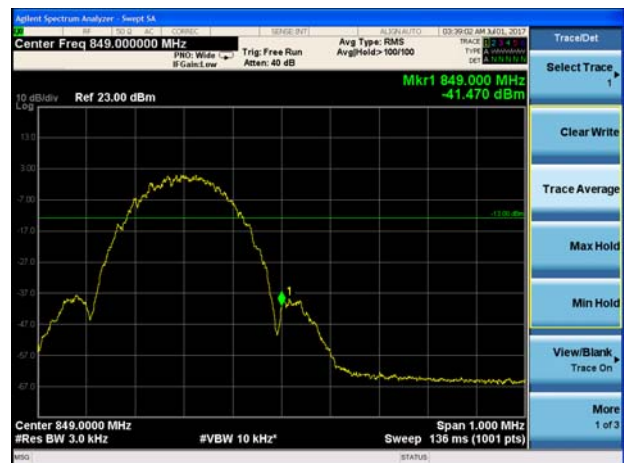



WCDMA Band V CH-Low



WCDMA Band V CH-High



LTE Band 5 QPSK 1.4MHz CH-Low 1RB

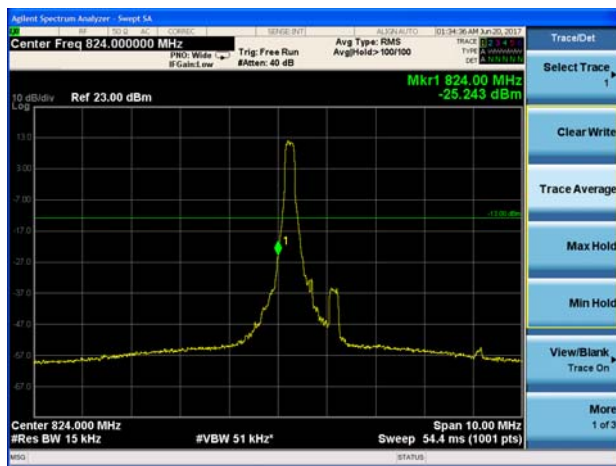

LTE Band 5 QPSK 1.4MHz CH-High 1RB

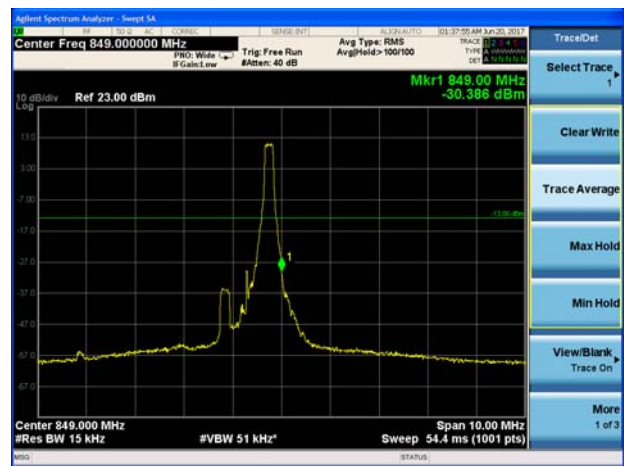

LTE Band 5 QPSK 1.4MHz CH-Low 100%RB



LTE Band 5 QPSK 1.4MHz CH-High 100%RB



LTE Band 5 QPSK 3MHz CH-Low 1RB

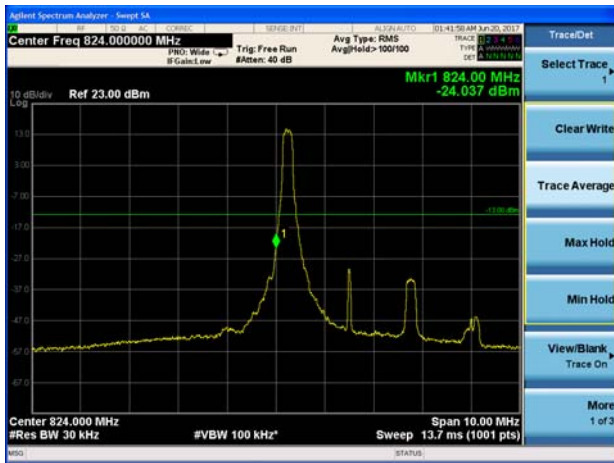

LTE Band 5 QPSK 3MHz CH-High 1RB

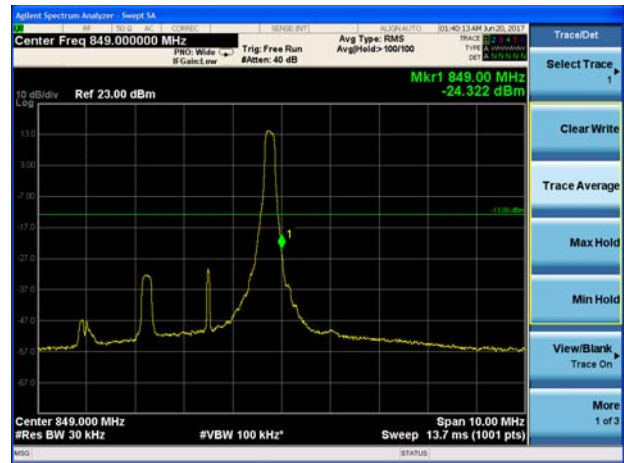

LTE Band 5 QPSK 3MHz CH-Low 100%RB



LTE Band 5 QPSK 3MHz CH-High 100%RB

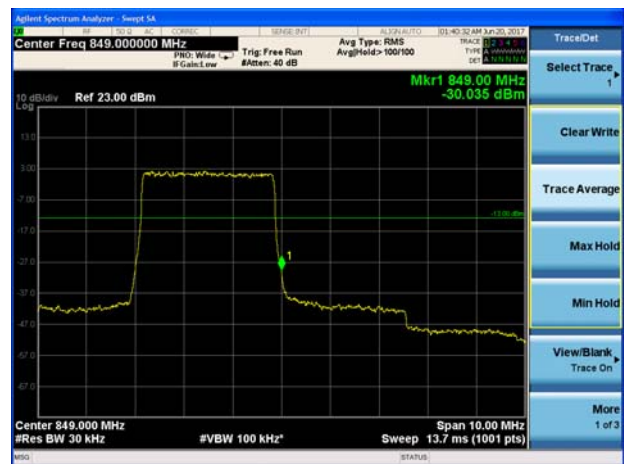

LTE Band 5 QPSK 5MHz CH-Low 1RB

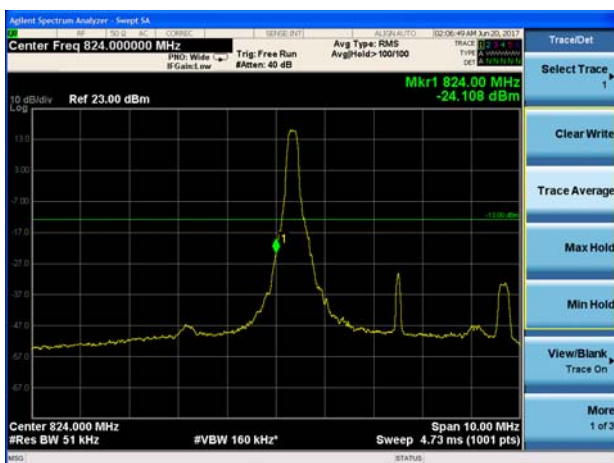

LTE Band 5 QPSK 5MHz CH-High 1RB

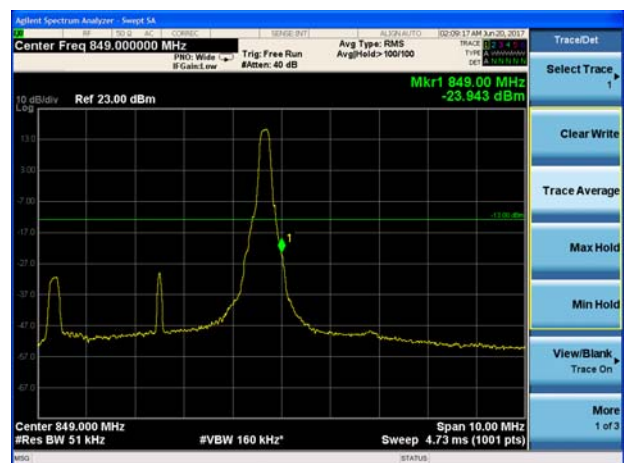



LTE Band 5 QPSK 5MHz CH-Low 100%RB

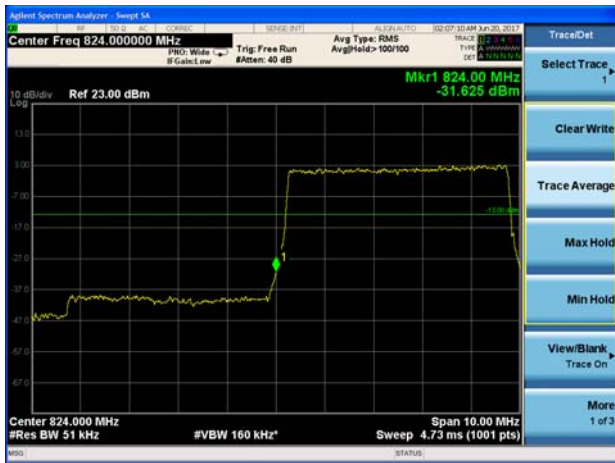

LTE Band 5 QPSK 5MHz CH-High 100%RB



LTE Band 5 QPSK 10MHz CH-Low 1RB

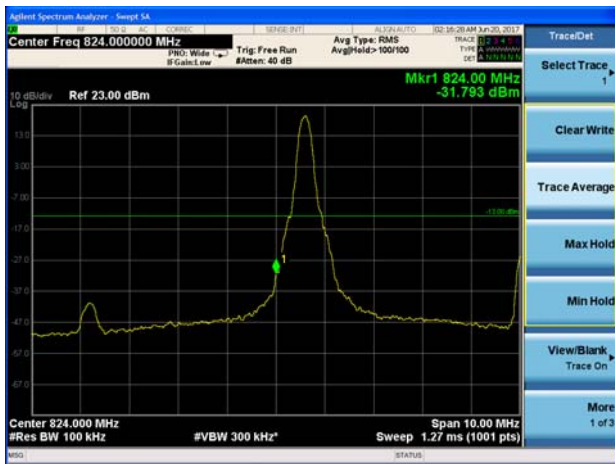

LTE Band 5 QPSK 10MHz CH-High 1RB

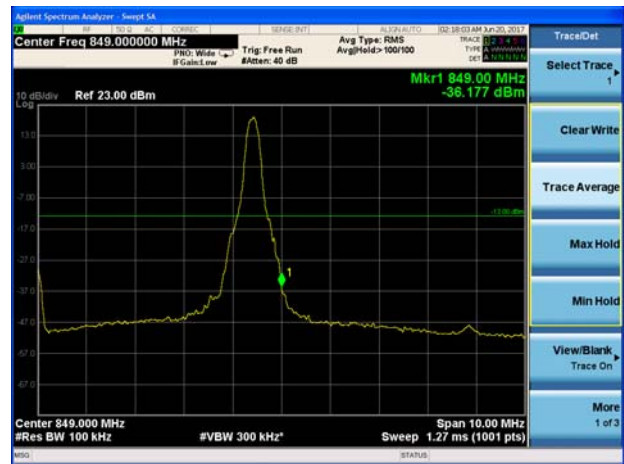

LTE Band 5 QPSK 10MHz CH-Low 100%RB

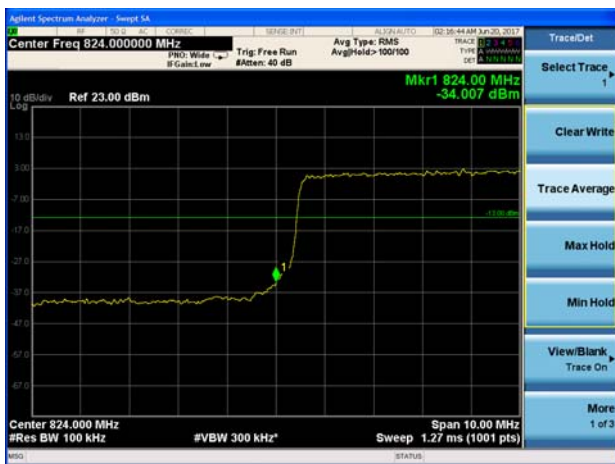

LTE Band 5 QPSK 10MHz CH-High 100%RB





LTE Band 5 16QAM 1.4MHz CH-Low 100%RB

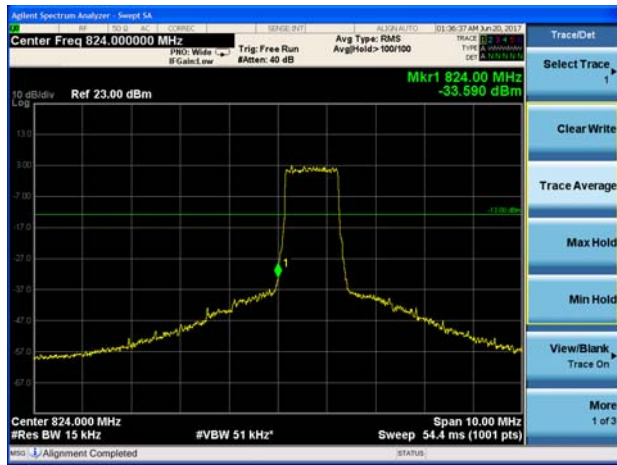

LTE Band 5 16QAM 1.4MHz CH-High 100%RB



LTE Band 5 16QAM 3MHz CH-Low 1RB

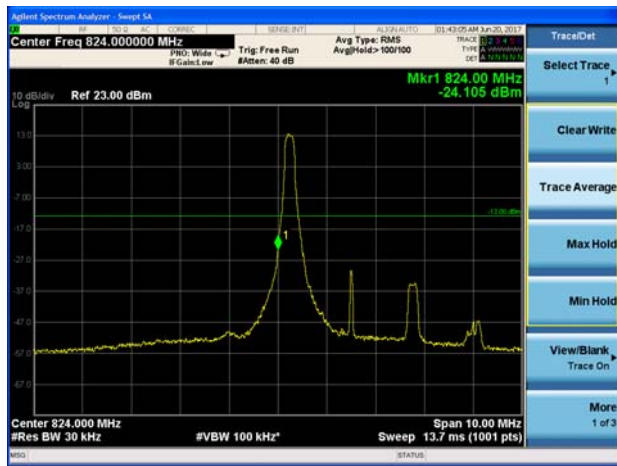

LTE Band 5 16QAM 3MHz CH-High 1RB

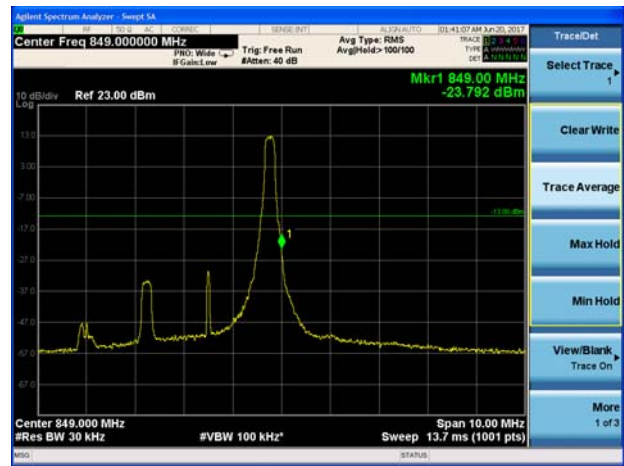

LTE Band 5 16QAM 3MHz CH-Low 100%RB

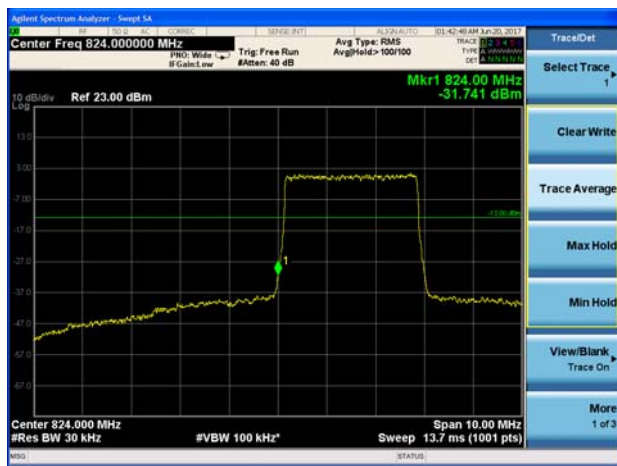

LTE Band 5 16QAM 3MHz CH-High 100%RB





LTE Band 5 16QAM 5MHz CH-Low 1RB

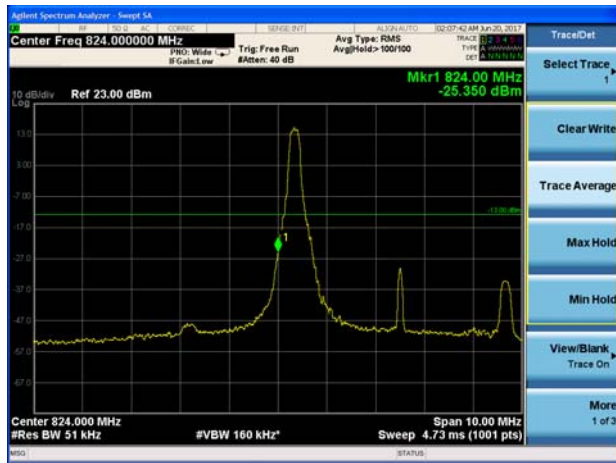

LTE Band 5 16QAM 5MHz CH-High 1RB

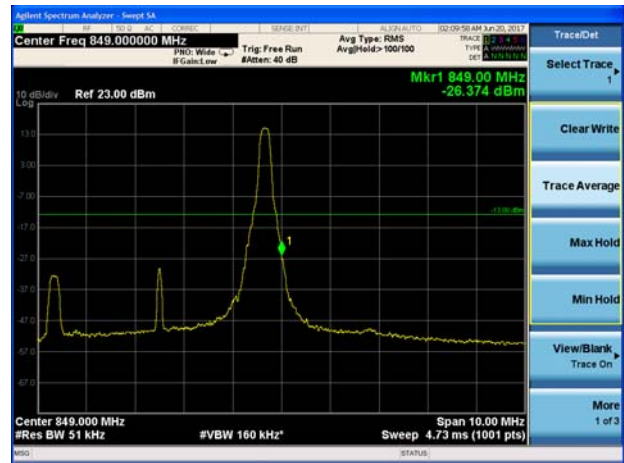

LTE Band 5 16QAM 5MHz CH-Low 100%RB

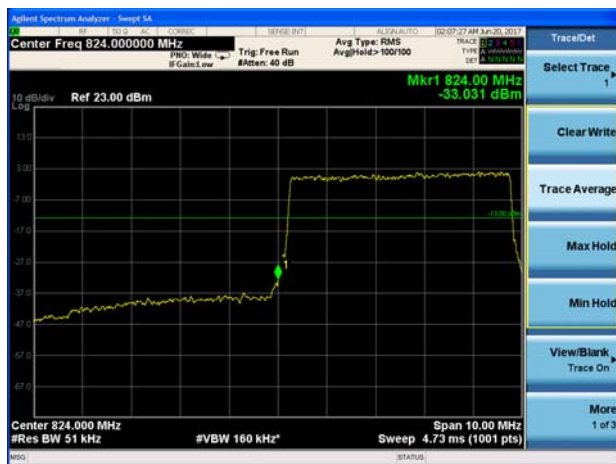

LTE Band 5 16QAM 5MHz CH-High 100%RB



LTE Band 5 16QAM 10MHz CH-Low 1RB

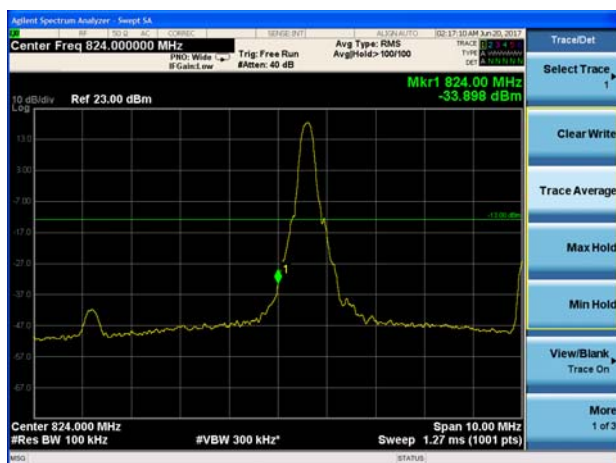

LTE Band 5 16QAM 10MHz CH-High 1RB

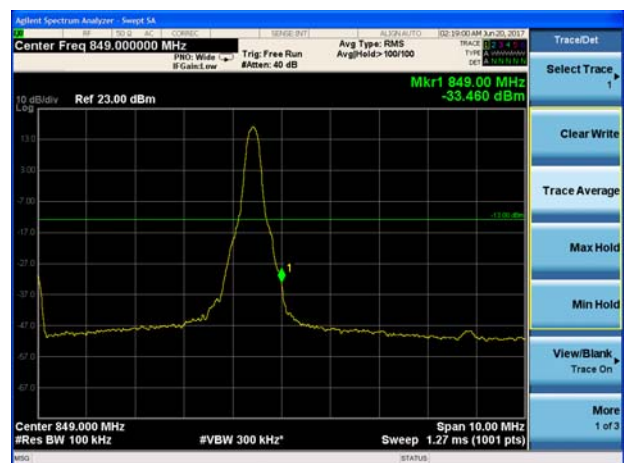



LTE Band 5 16QAM 10MHz CH-Low 100%RB



LTE Band 5 16QAM 10MHz CH-High 100%RB



5.5. Peak-to-Average Power Ratio (PAPR)

Ambient condition

Temperature	Relative humidity	Pressure
23°C ~25°C	45%~50%	101.5kPa

Methods of Measurement

Measure the total peak power and record as P_{Pk} . And measure the total average power and record as P_{Avg} . Both the peak and average power levels must be expressed in the same logarithmic units (e.g., dBm). Determine the PAPR from:

$$PAPR (dB) = P_{Pk} (dBm) - P_{Avg} (dBm).$$

Test Setup

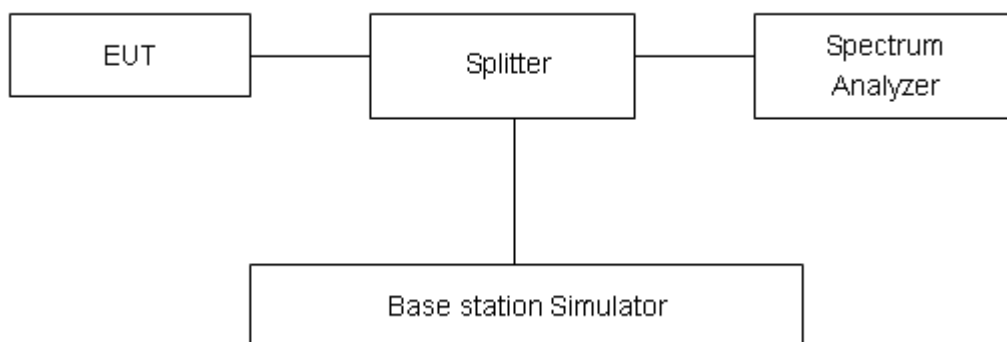

Limits

According to the Sec. 22.913(d), The peak-to-average ratio (PAR) of the transmission must not exceed 13 dB.

Measurement Uncertainty

The assessed measurement uncertainty to ensure 95% confidence level for the normal distribution is with the coverage factor $k = 2$, $U = 0.4$ dB.

Test Results

Mode	Channel	Frequency (MHz)	Peak (dBm)	Avg (dBm)	PAPR (dB)	Limit (dB)	Conclusion
GSM 850 (GSM)	128	824.2	33.22	32.33	0.89	≤13	PASS
	190	836.6	33.12	32.19	0.93	≤13	PASS
	251	848.8	33.21	32.22	0.99	≤13	PASS
GPRS 850 (GMSK)	128	824.2	27.50	26.53	0.97	≤13	PASS
	190	836.6	27.50	26.49	1.01	≤13	PASS
	251	848.8	27.53	26.51	1.02	≤13	PASS
EGPRS 850 (8-PSK)	128	824.2	22.10	21.05	1.05	≤13	PASS
	190	836.6	22.11	21.09	1.02	≤13	PASS
	251	848.8	22.49	21.46	1.03	≤13	PASS
WCDMA Band V (RMC)	4132	826.4	25.64	22.56	3.08	≤13	PASS
	4183	836.6	25.57	22.50	3.07	≤13	PASS
	4233	846.6	25.68	22.65	3.03	≤13	PASS

LTE Band 5								
Modulation	Bandwidth (MHz)	Channel	Frequency (MHz)	Peak (dBm)	Avg (dBm)	PAPR (dB)	Limit (dB)	Conclusion
QPSK	1.4	20407	824.7	27.36	22.20	5.16	≤13	PASS
		20525	836.5	27.44	22.34	5.10	≤13	PASS
		20643	848.3	27.46	22.38	5.08	≤13	PASS
	3	20415	825.5	27.58	22.29	5.29	≤13	PASS
		20525	836.5	27.61	22.39	5.22	≤13	PASS
		20635	847.5	27.56	22.43	5.13	≤13	PASS
	5	20425	826.5	27.61	22.27	5.34	≤13	PASS
		20525	836.5	27.71	22.35	5.36	≤13	PASS
		20625	846.5	27.47	22.38	5.09	≤13	PASS
	10	20450	829	27.35	22.24	5.11	≤13	PASS
		20525	836.5	27.68	22.30	5.38	≤13	PASS
		20600	844	27.47	22.34	5.13	≤13	PASS
16QAM	1.4	20407	824.7	27.10	21.14	5.96	≤13	PASS
		20525	836.5	27.29	21.35	5.94	≤13	PASS
		20643	848.3	27.23	21.32	5.91	≤13	PASS
	3	20415	825.5	27.30	21.18	6.12	≤13	PASS
		20525	836.5	27.43	21.40	6.03	≤13	PASS
		20635	847.5	26.47	21.34	5.13	≤13	PASS
	5	20425	826.5	27.23	21.15	6.08	≤13	PASS
		20525	836.5	27.38	21.35	6.03	≤13	PASS
		20625	846.5	27.18	21.30	5.88	≤13	PASS
	10	20450	829	26.24	21.13	5.11	≤13	PASS
		20525	836.5	27.43	21.31	6.12	≤13	PASS
		20600	844	27.25	21.27	5.98	≤13	PASS

5.6. Frequency Stability

Ambient condition

Temperature	Relative humidity	Pressure
23°C ~25°C	45%~50%	101.5kPa

Method of Measurement

1. Frequency Stability (Temperature Variation)

The temperature inside the climate chamber is varied from -30°C to +50°C in 10°C step size,

(1) With all power removed, the temperature was decreased to 0°C and permitted to stabilize for three hours.

(2) Measure the carrier frequency with the test equipment in a “call mode”. These measurements should be made within 1 minute of powering up the mobile station, to prevent significant self warming.

(3) Repeat the above measurements at 10°C increments from -30°C to +50°C. Allow at least 1.5 hours at each temperature, un-powered, before making measurements. Frequency Stability (Voltage Variation)

The frequency stability shall be measured with variation of primary supply voltage as follows:

(1) Vary primary supply voltage from 85 to 115 percent of the nominal value for other than hand carried battery equipment.

(2) For hand carried, battery powered equipment, reduce primary supply voltage to the battery-operating end point which shall be specified by the manufacturer.

This transceiver is specified to operate with an input voltage of between 3.6 V and 4.35 V, with a nominal voltage of 3.8V.

Test setup

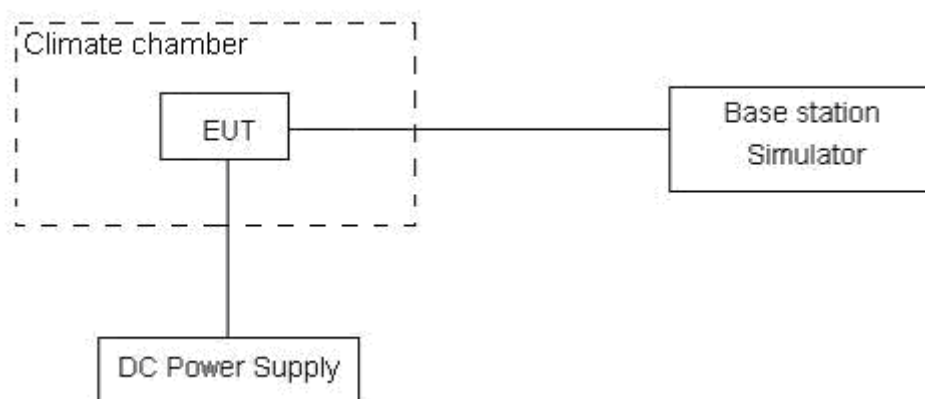

Limits

According to the Sec. 22.355, the frequency stability of the carrier shall be accurate to within 2.5 ppm of the received frequency for mobile stations.

Limits	≤ 2.5 ppm
--------	-----------

Measurement Uncertainty

The assessed measurement uncertainty to ensure 99.75% confidence level for the normal distribution is with the coverage factor $k = 3$, $U = 0.01\text{ppm}$.

Test Result

Mode	Test status	Test Results (ppm)			Limit (ppm)	Conclusion
		GSM (GMSK)	GPRS (GMSK)	EGPRS (8PSK)		
GSM 850 Middle Channel	-30°C/Normal Voltage	0.0194	0.0239	0.0195	2.5	PASS
	-20°C/Normal Voltage	0.0152	0.0287	0.0212	2.5	PASS
	-10°C/Normal Voltage	0.0179	0.0271	0.0199	2.5	PASS
	0°C/Normal Voltage	0.0145	0.0265	0.02	2.5	PASS
	10°C/Normal Voltage	0.0176	0.0181	0.0208	2.5	PASS
	20°C/Normal Voltage	0.0123	0.023	0.0209	2.5	PASS
	30°C/Normal Voltage	0.0171	0.0149	0.0241	2.5	PASS
	40°C/Normal Voltage	0.0159	0.0196	0.0214	2.5	PASS
	50°C/Normal Voltage	0.0167	0.0189	0.0185	2.5	PASS
	20°C/Minimum Voltage	0.0165	0.0195	0.0186	2.5	PASS
	20°C/Maximum Voltage	0.0161	0.0193	0.0182	2.5	PASS
/	/	RMC			/	/
WCDMA Band V Middle Channel	-30°C/Normal Voltage	0.000239			2.5	PASS
	-20°C/Normal Voltage	-0.000901			2.5	PASS
	-10°C/Normal Voltage	-0.00028			2.5	PASS
	0°C/Normal Voltage	-0.000213			2.5	PASS
	10°C/Normal Voltage	0.00007			2.5	PASS
	20°C/Normal Voltage	-0.000187			2.5	PASS
	30°C/Normal Voltage	0.000362			2.5	PASS
	40°C/Normal Voltage	-0.000179			2.5	PASS
	50°C/Normal Voltage	-0.000154			2.5	PASS
	20°C/Minimum Voltage	-0.000211			2.5	PASS
	20°C/Maximum Voltage	-0.000217			2.5	PASS



Bandwidth	Test status	LTE Band 5 Middle Channel Test Results (ppm)			
		QPSK	16QAM	Limit (ppm)	Conclusion
1.4MHz	-30°C/Normal Voltage	0.00008	0.00112	2.5	PASS
	-20°C/Normal Voltage	0.00063	0.00016	2.5	PASS
	-10°C/Normal Voltage	-0.00146	-0.00094	2.5	PASS
	0°C/Normal Voltage	-0.00056	-0.00226	2.5	PASS
	10°C/Normal Voltage	-0.00195	0.00123	2.5	PASS
	20°C/Normal Voltage	-0.00134	-0.00257	2.5	PASS
	30°C/Normal Voltage	0.00011	0.00106	2.5	PASS
	40°C/Normal Voltage	-0.00334	-0.00219	2.5	PASS
	50°C/Normal Voltage	0.00172	-0.00077	2.5	PASS
	20°C/Minimum Voltage	0.00127	-0.00182	2.5	PASS
	20°C/Maximum Voltage	-0.00207	0.00130	2.5	PASS
3MHz	-30°C/Normal Voltage	-0.00362	-0.00210	2.5	PASS
	-20°C/Normal Voltage	-0.00230	-0.00353	2.5	PASS
	-10°C/Normal Voltage	-0.00049	-0.00383	2.5	PASS
	0°C/Normal Voltage	-0.00599	-0.00518	2.5	PASS
	10°C/Normal Voltage	-0.00256	0.00049	2.5	PASS
	20°C/Normal Voltage	-0.00203	-0.00369	2.5	PASS
	30°C/Normal Voltage	0.00255	-0.00008	2.5	PASS
	40°C/Normal Voltage	-0.00053	-0.00237	2.5	PASS
	50°C/Normal Voltage	-0.00838	-0.00011	2.5	PASS
	20°C/Minimum Voltage	-0.00335	-0.00170	2.5	PASS
	20°C/Maximum Voltage	-0.00120	-0.00429	2.5	PASS
5MHz	-30°C/Normal Voltage	-0.00212	-0.00188	2.5	PASS
	-20°C/Normal Voltage	-0.00250	-0.00171	2.5	PASS
	-10°C/Normal Voltage	-0.00424	-0.00251	2.5	PASS
	0°C/Normal Voltage	0.00088	-0.00224	2.5	PASS
	10°C/Normal Voltage	-0.00175	-0.00124	2.5	PASS
	20°C/Normal Voltage	-0.00241	-0.00258	2.5	PASS
	30°C/Normal Voltage	-0.00077	-0.00068	2.5	PASS
	40°C/Normal Voltage	-0.00224	-0.00098	2.5	PASS
	50°C/Normal Voltage	-0.00154	-0.00293	2.5	PASS
	20°C/Minimum Voltage	-0.00103	-0.00072	2.5	PASS
	20°C/Maximum Voltage	-0.00479	-0.00255	2.5	PASS
10MHz	-30°C/Normal Voltage	-0.00359	-0.00136	2.5	PASS
	-20°C/Normal Voltage	-0.00071	-0.00404	2.5	PASS



	-10°C/Normal Voltage	-0.00218	-0.00053	2.5	PASS
	0°C/Normal Voltage	-0.00198	-0.00212	2.5	PASS
	10°C/Normal Voltage	-0.00115	-0.00281	2.5	PASS
	20°C/Normal Voltage	-0.00363	-0.00222	2.5	PASS
	30°C/Normal Voltage	-0.00415	-0.00005	2.5	PASS
	40°C/Normal Voltage	-0.00542	-0.00245	2.5	PASS
	50°C/Normal Voltage	-0.00283	-0.00212	2.5	PASS
	20°C/Minimum Voltage	-0.00597	0.00098	2.5	PASS
	20°C/Maximum Voltage	-0.00222	-0.00710	2.5	PASS

5.7. Spurious Emissions at Antenna Terminals

Ambient condition

Temperature	Relative humidity	Pressure
23°C ~25°C	45%~50%	101.5kPa

Method of Measurement

The EUT was connected to Spectrum Analyzer and Base Station Simulator via power Splitter. The measurement is carried out using a spectrum analyzer. The spectrum analyzer scans from 9kHz to the 10th harmonic of the carrier. The peak detector is used. RBW are set to 100 kHz and VBW are set to 300 kHz for below 1G, RBW are set to 1MHz and VBW are set to 3MHz for above 1G, Sweep is set to ATUO.

Test setup

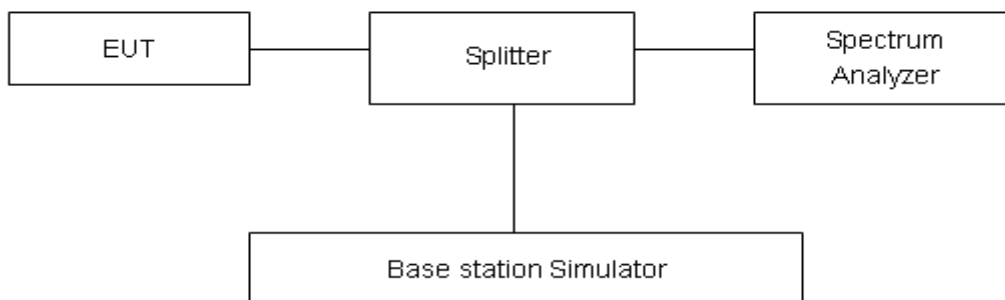

Limits

Rule Part 22.917(a) specifies that “The power of any emission outside of the authorized operating frequency ranges must be attenuated below the transmitting power (P) by a factor of at least 43 + 10 log (P) dB.”

Limit	-13 dBm
-------	---------

Measurement Uncertainty

The assessed measurement uncertainty to ensure 99.75% confidence level for the normal distribution is with the coverage factor $k = 1.96$.

Frequency	Uncertainty
100kHz-2GHz	0.684 dB
2GHz-12.75GHz	1.407 dB

Test Result

Sweep from 9 kHz to 30MHz, and the emissions more than 20 dB below the permissible value are not reported.

If disturbances were found more than 20dB below limit line, the mark is not required for the EUT. The signal beyond the limit is carrier.

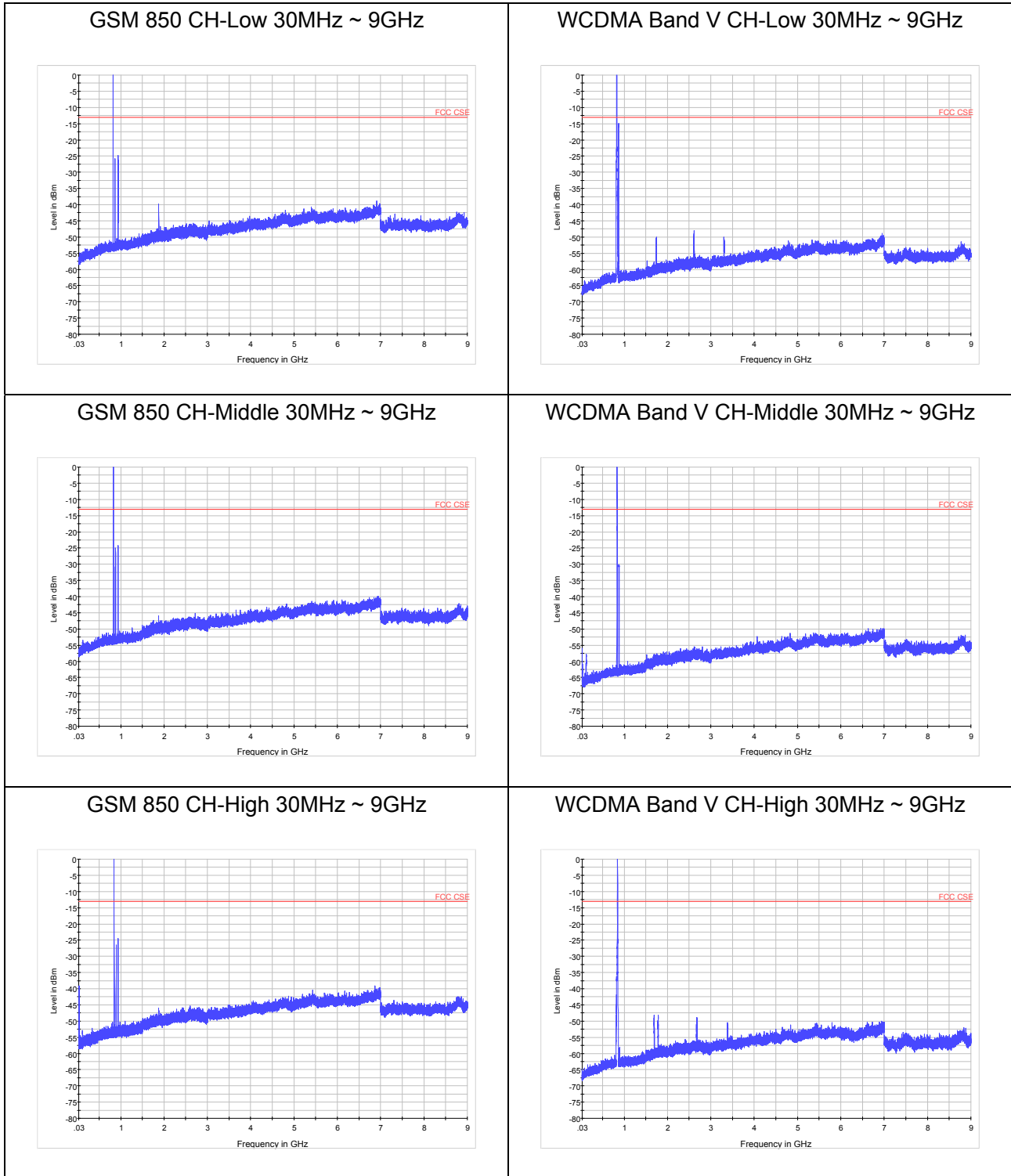



LTE Band 5 1.4MHz CH-Low 30MHz~1.5GHz

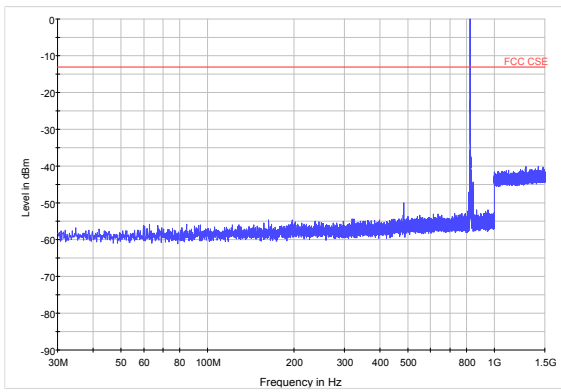

LTE Band 5 1.4MHz CH-Low 1.5GHz~9GHz

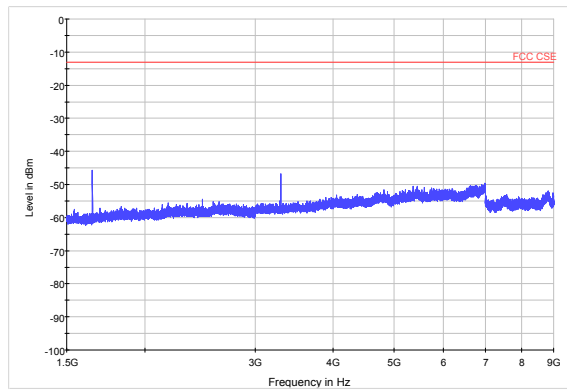

LTE Band 5 1.4MHz CH-Middle 30MHz~1.5GHz

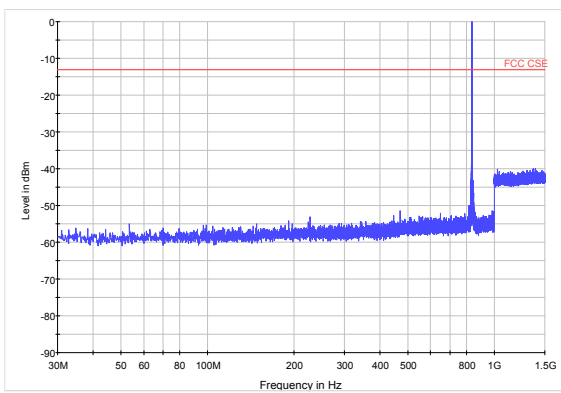

LTE Band 5 1.4MHz CH-Middle 1.5GHz~9GHz

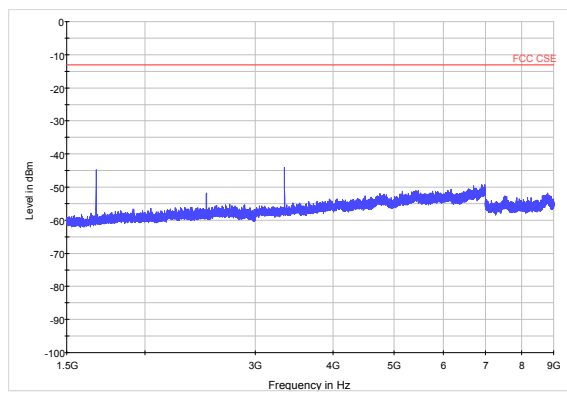

LTE Band 5 1.4MHz CH-High 30MHz~1.5GHz

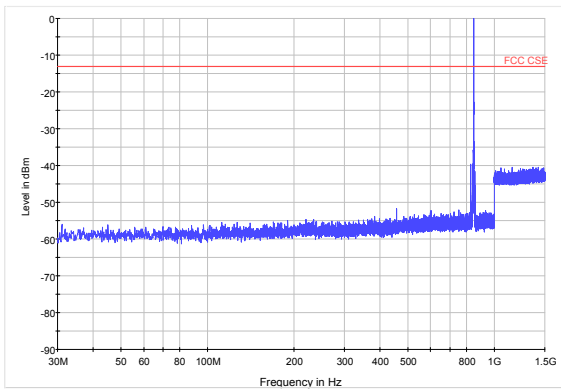

LTE Band 5 1.4MHz CH-High 1.5GHz~9GHz

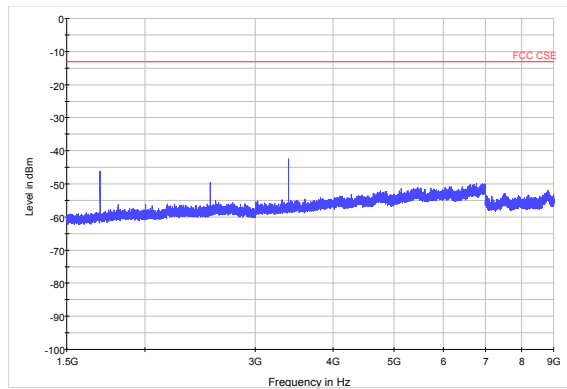



LTE Band 5 3MHz CH-Low 30MHz~1.5GHz

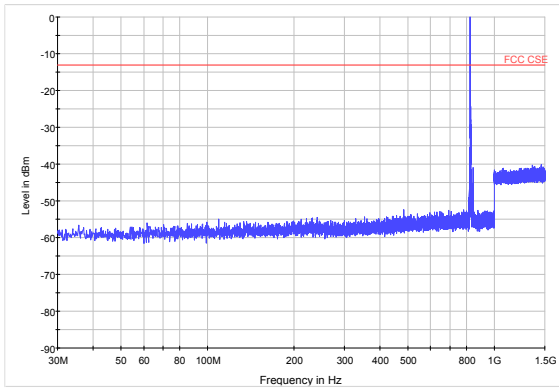

LTE Band 5 3MHz CH-Low 1.5GHz~9GHz

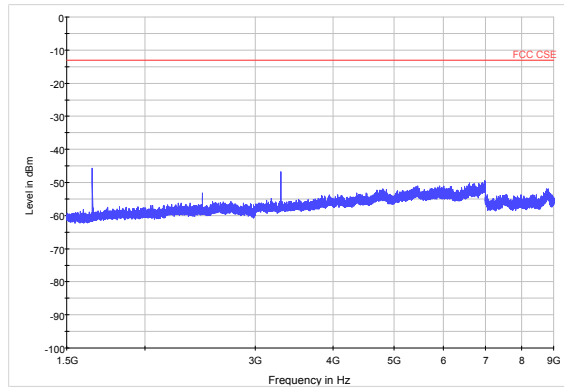

LTE Band 5 3MHz CH-Middle 30MHz~1.5GHz

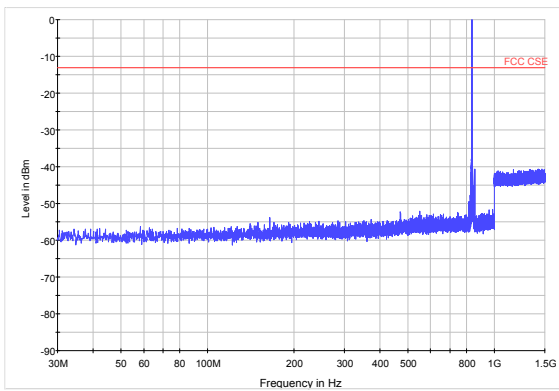

LTE Band 5 3MHz CH-Middle 1.5GHz~9GHz

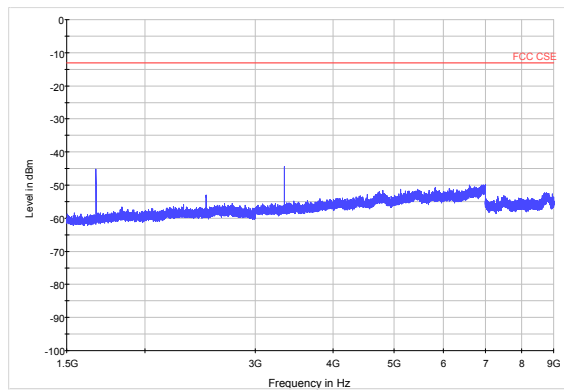

LTE Band 5 3MHz CH-High 30MHz~1.5GHz

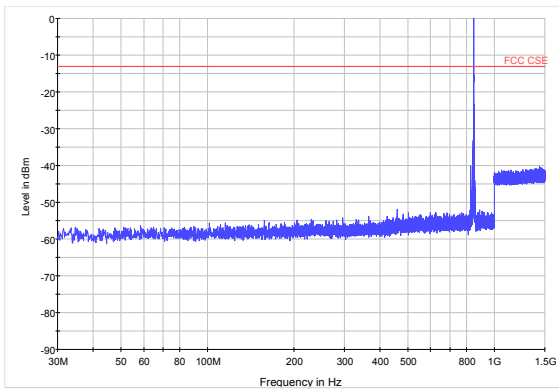

LTE Band 5 3MHz CH-High 1.5GHz~9GHz

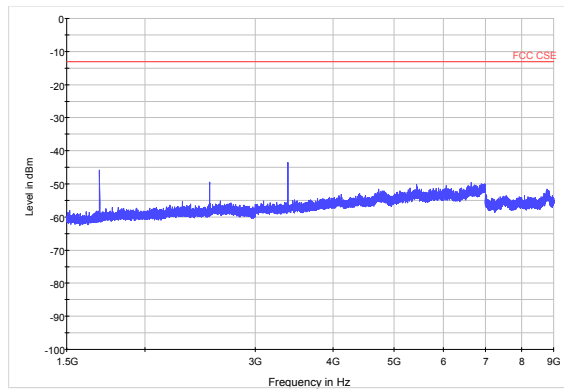



LTE Band 5 5MHz CH-Low 30MHz~1.5GHz

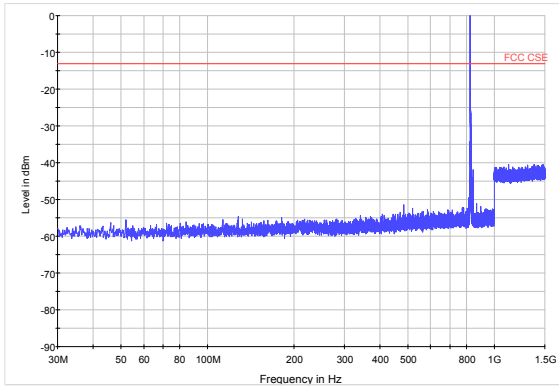

LTE Band 5 5MHz CH-Low 1.5GHz~9GHz

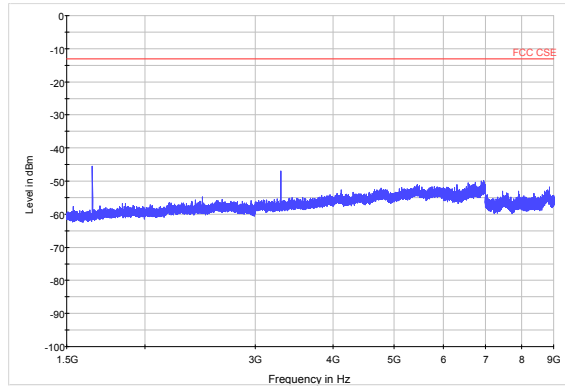

LTE Band 5 5MHz CH-Middle 30MHz~1.5GHz

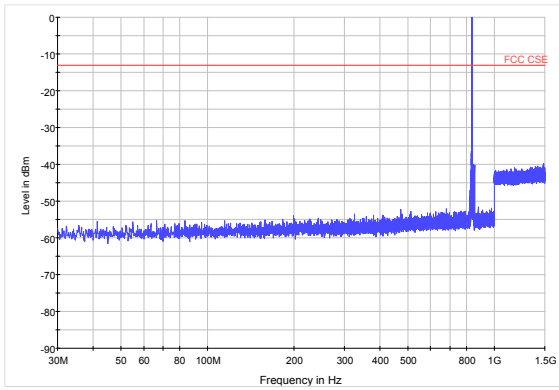

LTE Band 5 5MHz CH-Middle 1.5GHz~9GHz

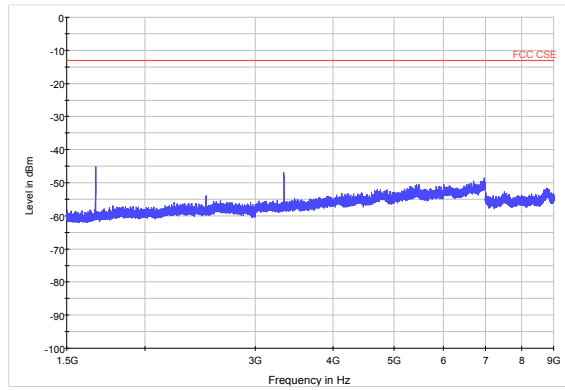

LTE Band 5 5MHz CH-High 30MHz~1.5GHz

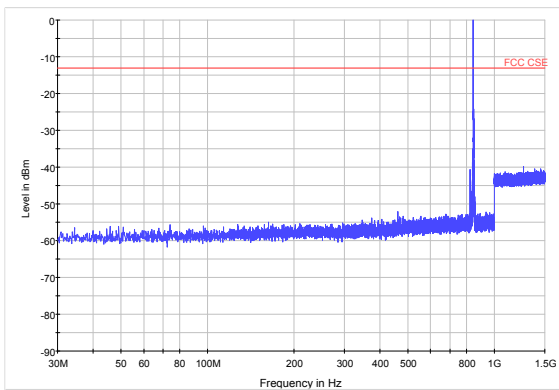

LTE Band 5 5MHz CH-High 1.5GHz~9GHz

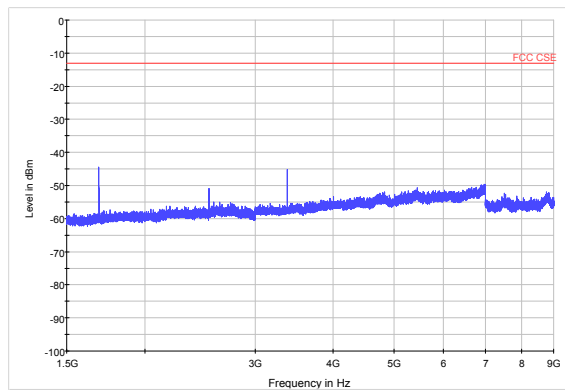



LTE Band 5 10MHz CH-Low 30MHz~1.5GHz

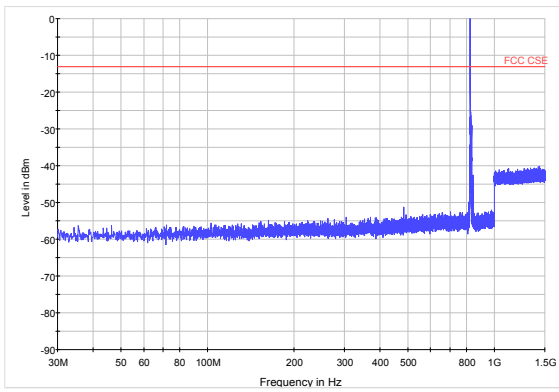

LTE Band 5 10MHz CH-Low 1.5GHz~9GHz

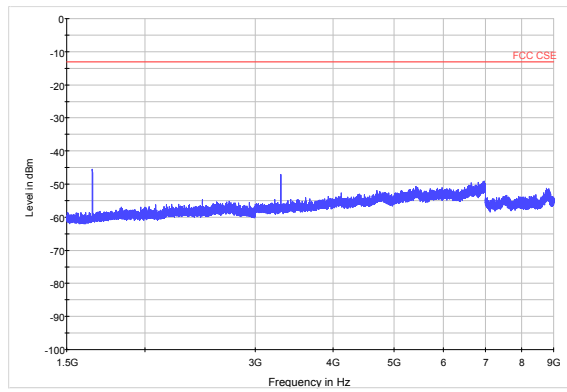

LTE Band 5 10MHz CH-Middle 30MHz~1.5GHz

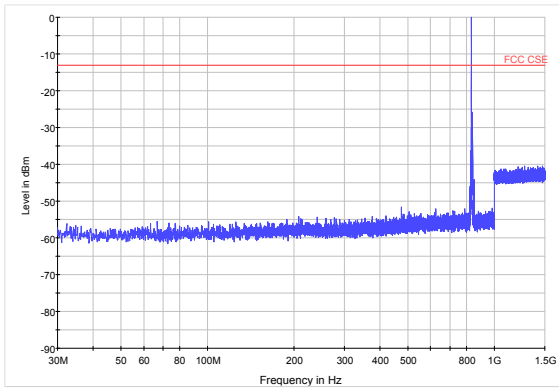

LTE Band 5 10MHz CH-Middle 1.5GHz~9GHz

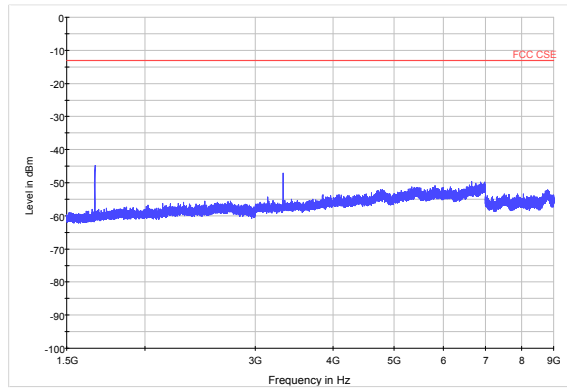

LTE Band 5 10MHz CH-High 30MHz~1.5GHz

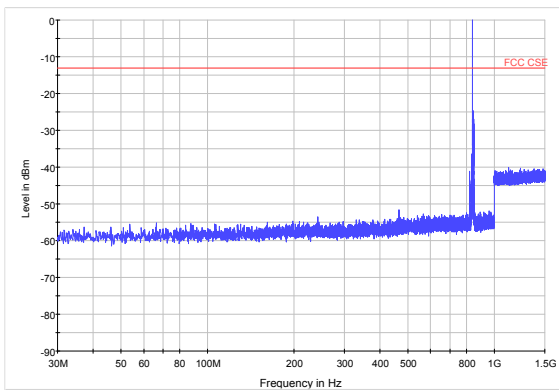

LTE Band 5 10MHz CH-High 1.5GHz~9GHz

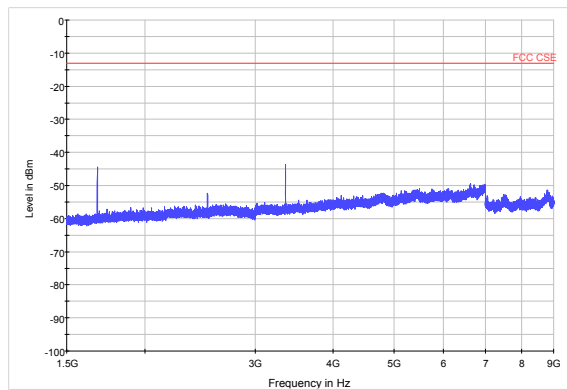

5.8. Radiates Spurious Emission

Ambient condition

Temperature	Relative humidity	Pressure
23°C ~25°C	45%~50%	101.5kPa

Method of Measurement

1. The testing follows ANSI C63.26 (2015) Section 5.5.2.3.
2. Above 30MHz: The EUT is placed on a turntable 0.8 meters above the ground in the chamber, 3 meter away from the antenna. The maximal emission value is acquired by adjusting the antenna height, polarisation and turntable azimuth. Normally, the height range of antenna is 1 m to 4 m, the azimuth range of turntable is 0° to 360°, and the receive antenna has two polarizations Vertical (V) and Horizontal (H). Above 1GHz: (Note: the FCC's permission to use 1.5m as an alternative per TCBC Conf call of Dec. 2, 2014.) The EUT is placed on a turntable 1.5 meters above the ground in the chamber, 3 meter away from the antenna. The maximal emission value is acquired by adjusting the antenna height, polarisation and turntable azimuth. Normally, the height range of antenna is 1 m to 4 m, the azimuth range of turntable is 0° to 360°, and the receive antenna has two polarizations Vertical (V) and Horizontal (H).
3. A log-periodic antenna or double-ridged waveguide horn antenna shall be substituted in place of the EUT. The log-periodic antenna will be driven by a signal generator and the level will be adjusted till the same power value on the spectrum analyzer or receiver. The level of the spurious emissions can be calculated through the level of the signal generator, cable loss, the gain of the substitution antenna and the reading of the spectrum analyzer or receiver.
4. The EUT is then put into continuously transmitting mode at its maximum power level during the test. Set Test Receiver or Spectrum RBW=1MHz, VBW=3MHz for above 1GHz and RBW=100kHz, VBW=300kHz for 30MHz to 1GHz, And the maximum value of the receiver should be recorded as (Pr).
5. The EUT shall be replaced by a substitution antenna. In the chamber, an substitution antenna for the frequency band of interest is placed at the reference point of the chamber. An RF Signal source for the frequency band of interest is connected to the substitution antenna with a cable that has been constructed to not interfere with the radiation pattern of the antenna. A power (PMea) is applied to the input of the substitution antenna, and adjust the level of the signal generator output until the value of the receiver reach the previously recorded (Pr). The power of signal source (PMea) is recorded. The test should be performed by rotating the test item and adjusting the receiving antenna polarization.
6. A amplifier should be connected to the Signal Source output port. And the cable should be connect between the Amplifier and the Substitution Antenna. The cable loss (Pcl) ,the Substitution Antenna Gain (Ga) and the Amplifier Gain (PAg) should be recorded after test.
7. The measurement results are obtained as described below:
Power(EIRP)=PMea- PAg - Pcl + Ga
The measurement results are amend as described below:
Power(EIRP)=PMea- Pcl + Ga
8. This value is EIRP since the measurement is calibrated using an antenna of known gain (2.15 dBi)

and known input power. ERP can be calculated from EIRP by subtracting the gain of the dipole, $ERP = EIRP - 2.15\text{dBi}$.

Test setup

30MHz~ 1GHz

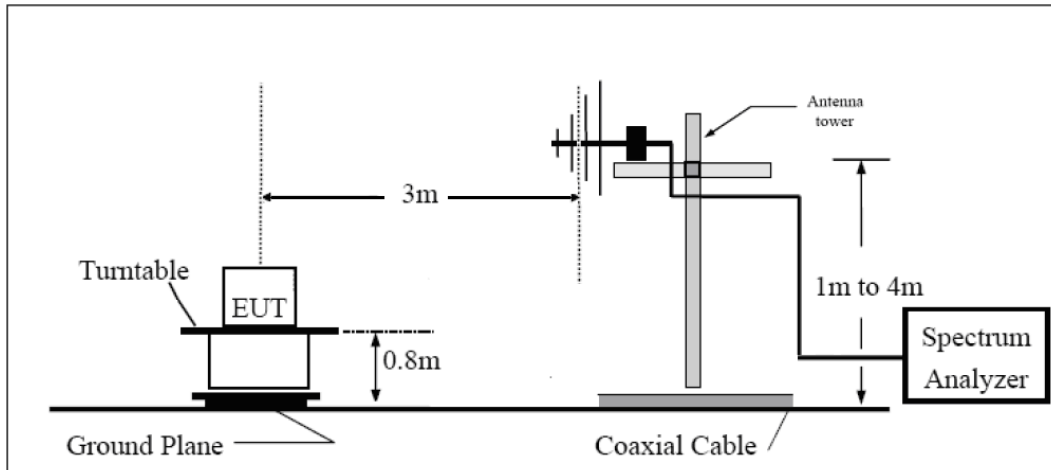

Above 1GHz

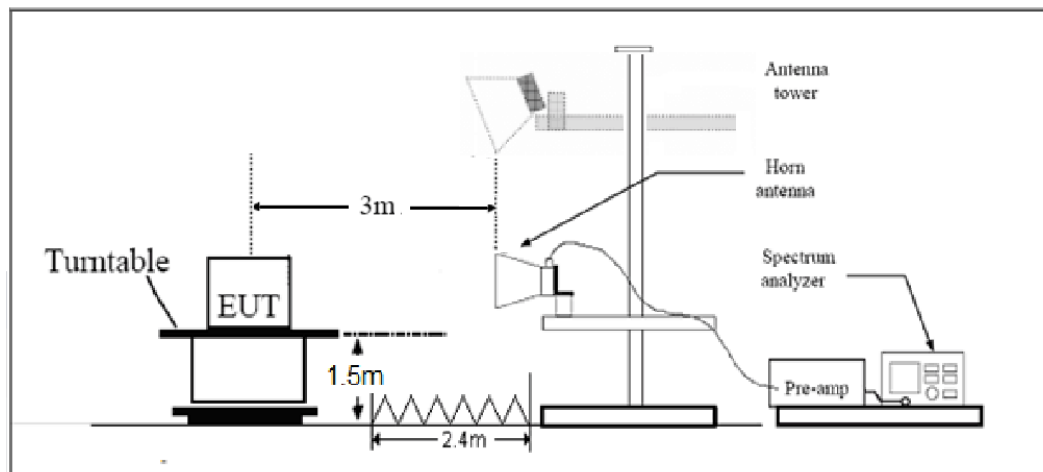

Note: Area side:2.4mX3.6m

Limits



Rule Part 22.917(a) specifies that “The power of any emission outside of the authorized operating frequency ranges must be attenuated below the transmitting power (P) by a factor of at least $43 + 10 \log (P)$ dB.”

Limit	-13 dBm
-------	---------

Measurement Uncertainty

The assessed measurement uncertainty to ensure 95% confidence level for the normal distribution is with the coverage factor $k = 1.96$, $U = 3.55$ dB.

**Test Result**

GSM 850 CH-Low

Harmonic	Frequency (MHz)	SG (dBm)	Cable Loss (dB)	Gain (dBi)	Antenna Polarization	ERP Level (dBm)	Limit (dBm)	Margin (dB)	Azimuth (deg)
2	1648	-56.90	2	10.15	Vertical	-50.9	-13.0	37.88	270
3	2473	-58.09	2.51	11.35	Vertical	-51.4	-13.0	38.43	135
4	3297	-55.80	4.2	10.85	Vertical	-51.3	-13.0	38.34	225
5	4121	-51.40	5.2	11.35	Vertical	-47.4	-13.0	34.38	180
6	4945	-52.00	5.5	11.95	Vertical	-47.7	-13.0	34.70	45
7	5769	-52.10	5.7	13.55	Vertical	-46.4	-13.0	33.43	315
8	6594	-49.00	6.3	13.75	Vertical	-43.7	-13.0	30.74	315
9	7418	-45.10	6.8	13.85	Vertical	-40.2	-13.0	27.17	270
10	8242	-45.90	6.9	14.25	Vertical	-40.7	-13.0	27.73	135

Note: 1.The other Spurious RF Radiated emissions level is no more than noise floor.
2.The worst emission was found in the antenna is vertical position.

GSM 850 CH-Middle

Harmonic	Frequency (MHz)	SG (dBm)	Cable Loss (dB)	Gain (dBi)	Antenna Polarization	ERP Level (dBm)	Limit (dBm)	Margin (dB)	Azimuth (deg)
2	1673	-56.80	2	10.75	Vertical	-50.2	-13.0	37.20	90
3	2498	-56.49	2.51	11.05	Vertical	-50.1	-13.0	37.10	225
4	3346	-55.80	4.2	11.15	Vertical	-51.0	-13.0	37.97	90
5	4183	-44.00	5.2	11.15	Vertical	-40.2	-13.0	27.21	225
6	5020	-51.30	5.5	11.95	Vertical	-47.0	-13.0	34.01	180
7	5856	-52.00	5.7	13.55	Vertical	-46.3	-13.0	33.30	45
8	6693	-49.20	6.3	13.75	Vertical	-43.9	-13.0	30.86	225
9	7529	-47.30	6.8	13.85	Vertical	-42.4	-13.0	29.36	180
10	8366	-46.60	6.9	14.25	Vertical	-41.4	-13.0	28.45	45

Note: 1.The other Spurious RF Radiated emissions level is no more than noise floor.
2.The worst emission was found in the antenna is vertical position.



GSM 850 CH-High

Harmonic	Frequency (MHz)	SG (dBm)	Cable Loss (dB)	Gain (dBi)	Antenna Polarization	ERP Level (dBm)	Limit (dBm)	Margin (dB)	Azimuth (deg)
2	1698	-59.80	2	10.15	Vertical	-53.8	-13.0	40.83	180
3	2546	-57.39	2.51	11.05	Vertical	-51.0	-13.0	38.01	45
4	3395	-55.40	4.2	11.15	Vertical	-50.6	-13.0	37.61	315
5	4244	-51.90	5.2	11.15	Vertical	-48.1	-13.0	35.10	270
6	5093	-47.80	5.5	11.95	Vertical	-43.5	-13.0	30.51	135
7	5942	-50.20	5.7	13.55	Vertical	-44.5	-13.0	31.46	315
8	6790	-48.00	6.3	13.75	Vertical	-42.7	-13.0	29.65	270
9	7639	-47.20	6.8	13.85	Vertical	-42.3	-13.0	29.31	135
10	8488	-47.10	6.9	14.25	Vertical	-41.9	-13.0	28.92	90

Note: 1.The other Spurious RF Radiated emissions level is no more than noise floor.
2.The worst emission was found in the antenna is vertical position.

WCDMA Band V CH-Low

Harmonic	Frequency (MHz)	SG (dBm)	Cable Loss (dB)	Gain (dBi)	Antenna Polarization	ERP Level (dBm)	Limit (dBm)	Margin (dB)	Azimuth (deg)
2	1653	-53.99	2	10.15	Vertical	-51.7	-13.0	38.69	45
3	2479	-55.50	2.51	11.35	Vertical	-47.3	-13.0	34.29	315
4	3306	-51.80	4.2	10.85	Vertical	-51.0	-13.0	37.95	45
5	4132	-50.00	5.2	11.35	Vertical	-47.8	-13.0	34.75	225
6	4958	-50.60	5.5	11.95	Vertical	-45.7	-13.0	32.74	180
7	5785	-49.10	5.7	13.55	Vertical	-44.9	-13.0	31.93	45
8	6611	-46.10	6.3	13.75	Vertical	-43.8	-13.0	30.82	225
9	7438	-46.18	6.8	13.85	Vertical	-41.2	-13.0	28.21	180
10	8264	-53.99	6.9	14.25	Vertical	-40.98	-13.0	27.98	45

Note: 1.The other Spurious RF Radiated emissions level is no more than noise floor.
2.The worst emission was found in the antenna is vertical position.



WCDMA Band V CH-Middle

Harmonic	Frequency (MHz)	SG (dBm)	Cable Loss (dB)	Gain (dBi)	Antenna Polarization	ERP Level (dBm)	Limit (dBm)	Margin (dB)	Azimuth (deg)
2	1673	-58.60	2	10.75	Vertical	-52.0	-13.0	38.95	270
3	2510	-57.69	2.51	11.05	Vertical	-51.3	-13.0	38.30	135
4	3346	-56.20	4.2	11.15	Vertical	-51.4	-13.0	38.44	315
5	4183	-51.50	5.2	11.15	Vertical	-47.7	-13.0	34.70	270
6	5020	-49.60	5.5	11.95	Vertical	-45.3	-13.0	32.27	135
7	5856	-50.60	5.7	13.55	Vertical	-44.9	-13.0	31.87	90
8	6693	-49.50	6.3	13.75	Vertical	-44.2	-13.0	31.16	225
9	8366	-46.80	6.8	13.85	Vertical	-41.9	-13.0	28.87	180
10	3346	-46.61	6.9	14.25	Vertical	-41.41	-13.0	28.41	45

Note: 1.The other Spurious RF Radiated emissions level is no more than noise floor.

2.The worst emission was found in the antenna is vertical position.

WCDMA Band V CH-High

Harmonic	Frequency (MHz)	SG (dBm)	Cable Loss (dB)	Gain (dBi)	Antenna Polarization	ERP Level (dBm)	Limit (dBm)	Margin (dB)	Azimuth (deg)
2	1693	-56.20	2	10.15	Vertical	-50.2	-13.0	37.19	90
3	2540	-57.89	2.51	11.05	Vertical	-51.5	-13.0	38.50	225
4	3386	-55.00	4.2	11.15	Vertical	-50.2	-13.0	37.16	225
5	4233	-52.30	5.2	11.15	Vertical	-48.5	-13.0	35.50	180
6	5080	-50.20	5.5	11.95	Vertical	-45.9	-13.0	32.91	45
7	5926	-50.20	5.7	13.55	Vertical	-44.5	-13.0	31.55	315
8	6773	-48.80	6.3	13.75	Vertical	-43.5	-13.0	30.50	270
9	7619	-46.50	6.8	13.85	Vertical	-41.6	-13.0	28.60	135
10	8466	-46.83	6.9	14.25	Vertical	-41.63	-13.0	28.63	90

Note: 1.The other Spurious RF Radiated emissions level is no more than noise floor.

2.The worst emission was found in the antenna is vertical position.



LTE Band 5 1.4MHz CH-Low

Harmonic	Frequency (MHz)	SG (dBm)	Cable Loss (dB)	Gain (dBi)	Antenna Polarization	ERP Level (dBm)	Limit (dBm)	Margin (dB)	Azimuth (deg)
2	1649.4	-58.80	2.00	10.75	vertical	-52.2	-13.0	39.2	45
3	2474.1	-55.49	2.51	11.05	vertical	-49.1	-13.0	36.1	315
4	3298.8	-50.02	4.20	11.15	vertical	-45.22	-13.0	32.22	45
5	4123.5	-52.28	5.20	11.15	vertical	-48.48	-13.0	35.48	315
6	4948.2	-51.49	5.50	11.95	vertical	-47.19	-13.0	34.19	270
7	5772.9	-53.53	5.70	13.55	vertical	-47.83	-13.0	34.83	135
8	6597.6	-49.00	6.30	13.75	vertical	-43.70	-13.0	30.70	45
9	7422.3	-45.85	6.80	13.85	vertical	-40.95	-13.0	27.95	315
10	8247.0	-46.71	6.90	14.25	vertical	-41.51	-13.0	28.51	90

Note: 1.The other Spurious RF Radiated emissions level is no more than noise floor.
2.The worst emission was found in the antenna is vertical position.

LTE Band 5 1.4MHz CH-Middle

Harmonic	Frequency (MHz)	SG (dBm)	Cable Loss (dB)	Gain (dBi)	Antenna Polarization	ERP Level (dBm)	Limit (dBm)	Margin (dB)	Azimuth (deg)
2	1673.0	-58.40	2.00	10.75	vertical	-51.8	-13.0	38.8	90
3	2509.5	-50.55	2.51	11.05	vertical	-44.16	-13.0	31.2	225
4	3346.0	-51.15	4.20	11.15	vertical	-46.35	-13.0	33.35	225
5	4182.5	-52.83	5.20	11.15	vertical	-49.03	-13.0	36.03	180
6	5019.0	-52.27	5.50	11.95	vertical	-47.97	-13.0	34.97	45
7	5855.5	-51.23	5.70	13.55	vertical	-45.53	-13.0	32.53	315
8	6692.0	-51.64	6.30	13.75	vertical	-46.34	-13.0	33.34	270
9	7528.5	-46.57	6.80	13.85	vertical	-41.67	-13.0	28.67	135
10	8365.0	-48.16	6.90	14.25	vertical	-42.96	-13.0	29.96	45

Note: 1.The other Spurious RF Radiated emissions level is no more than noise floor.
2.The worst emission was found in the antenna is vertical position.



LTE Band 5 1.4MHz CH-High

Harmonic	Frequency (MHz)	SG (dBm)	Cable Loss (dB)	Gain (dBi)	Antenna Polarization	ERP Level (dBm)	Limit (dBm)	Margin (dB)	Azimuth (deg)
2	1696.6	-57.66	2.00	10.75	vertical	-51.06	-13.0	38.1	180
3	2544.9	-48.37	2.51	11.05	vertical	-41.98	-13.0	29.0	45
4	3393.2	-44.33	4.20	11.15	vertical	-39.53	-13.0	26.53	315
5	4241.5	-51.5	5.20	11.15	vertical	-47.70	-13.0	34.70	90
6	5089.8	-49.5	5.50	11.95	vertical	-45.20	-13.0	32.20	225
7	5938.1	-51.84	5.70	13.55	vertical	-46.14	-13.0	33.14	180
8	6786.4	-49.44	6.30	13.75	vertical	-44.14	-13.0	31.14	45
9	7634.7	-47.51	6.80	13.85	vertical	-42.61	-13.0	29.61	315
10	8483.0	-47.72	6.90	14.25	vertical	-42.52	-13.0	29.52	270

Note: 1.The other Spurious RF Radiated emissions level is no more than noise floor.
2.The worst emission was found in the antenna is vertical position.

LTE Band 5 3MHz CH-Low

Harmonic	Frequency (MHz)	SG (dBm)	Cable Loss (dB)	Gain (dBi)	Antenna Polarization	ERP Level (dBm)	Limit (dBm)	Margin (dB)	Azimuth (deg)
2	1648.3	-57.90	2.00	10.75	vertical	-51.30	-13.0	38.3	315
3	2476.5	-43.58	2.51	11.05	vertical	-37.19	-13.0	24.2	270
4	3302.0	-50.10	4.20	11.15	vertical	-45.3	-13.0	32.3	135
5	4127.5	-53.00	5.20	11.15	vertical	-49.2	-13.0	36.2	270
6	4953.0	-51.50	5.50	11.95	vertical	-47.2	-13.0	34.2	45
7	5778.5	-52.60	5.70	13.55	vertical	-46.9	-13.0	33.9	315
8	6604.0	-50.70	6.30	13.75	vertical	-45.4	-13.0	32.4	90
9	7429.5	-46.50	6.80	13.85	vertical	-41.6	-13.0	28.6	225
10	8255.0	-46.70	6.90	14.25	vertical	-41.5	-13.0	28.5	180

Note: 1.The other Spurious RF Radiated emissions level is no more than noise floor.
2.The worst emission was found in the antenna is vertical position.



LTE Band 5 3MHz CH-Middle

Harmonic	Frequency (MHz)	SG (dBm)	Cable Loss (dB)	Gain (dBi)	Antenna Polarization	ERP Level (dBm)	Limit (dBm)	Margin (dB)	Azimuth (deg)
2	1670.3	-58.70	2.00	10.75	vertical	-52.1	-13.0	39.1	135
3	2509.5	-49.01	2.51	11.05	vertical	-42.62	-13.0	29.6	45
4	3346.0	-49.50	4.20	11.15	vertical	-44.7	-13.0	31.7	45
5	4182.5	-53.40	5.20	11.15	vertical	-49.6	-13.0	36.6	315
6	5019.0	-51.00	5.50	11.95	vertical	-46.7	-13.0	33.7	270
7	5855.5	-51.70	5.70	13.55	vertical	-46.0	-13.0	33.0	135
8	6692.0	-51.00	6.30	13.75	vertical	-45.7	-13.0	32.7	270
9	7528.5	-47.30	6.80	13.85	vertical	-42.4	-13.0	29.4	315
10	8365.0	-48.30	6.90	14.25	vertical	-43.1	-13.0	30.1	90

Note: 1.The other Spurious RF Radiated emissions level is no more than noise floor.
2.The worst emission was found in the antenna is vertical position.

LTE Band 5 3MHz CH-High

Harmonic	Frequency (MHz)	SG (dBm)	Cable Loss (dB)	Gain (dBi)	Antenna Polarization	ERP Level (dBm)	Limit (dBm)	Margin (dB)	Azimuth (deg)
2	1692.5	-57.90	2.00	10.75	vertical	-51.30	-13.0	38.3	315
3	2542.5	-50.91	2.51	11.05	vertical	-44.52	-13.0	31.5	90
4	3390.0	-46.10	4.20	11.15	vertical	-41.3	-13.0	28.3	135
5	4237.5	-52.50	5.20	11.15	vertical	-48.7	-13.0	35.7	90
6	5085.0	-50.20	5.50	11.95	vertical	-45.9	-13.0	32.9	225
7	5932.5	-51.90	5.70	13.55	vertical	-46.2	-13.0	33.2	180
8	6780.0	-49.70	6.30	13.75	vertical	-44.4	-13.0	31.4	45
9	7627.5	-48.90	6.80	13.85	vertical	-44.0	-13.0	31.0	315
10	8475.0	-48.00	6.90	14.25	vertical	-42.8	-13.0	29.8	270

Note: 1.The other Spurious RF Radiated emissions level is no more than noise floor.
2.The worst emission was found in the antenna is vertical position.



LTE Band 5 5MHz CH-Low

Harmonic	Frequency (MHz)	SG (dBm)	Cable Loss (dB)	Gain (dBi)	Antenna Polarization	ERP Level (dBm)	Limit (dBm)	Margin (dB)	Azimuth (deg)
2	1649.6	-58.67	2.00	10.75	vertical	-52.07	-13.0	39.1	225
3	2479.5	-48.93	2.51	11.05	vertical	-42.54	-13.0	29.5	180
4	3306.0	-52.30	4.20	11.15	vertical	-47.5	-13.0	34.5	135
5	4132.5	-53.60	5.20	11.15	vertical	-49.8	-13.0	36.8	90
6	4959.0	-52.20	5.50	11.95	vertical	-47.9	-13.0	34.9	225
7	5785.5	-51.60	5.70	13.55	vertical	-45.9	-13.0	32.9	180
8	6612.0	-49.80	6.30	13.75	vertical	-44.5	-13.0	31.5	45
9	7438.5	-45.70	6.80	13.85	vertical	-40.8	-13.0	27.8	315
10	8265.0	-48.40	6.90	14.25	vertical	-43.2	-13.0	30.2	270

Note: 1.The other Spurious RF Radiated emissions level is no more than noise floor.
2.The worst emission was found in the antenna is vertical position.

LTE Band 5 5MHz CH-Middle

Harmonic	Frequency (MHz)	SG (dBm)	Cable Loss (dB)	Gain (dBi)	Antenna Polarization	ERP Level (dBm)	Limit (dBm)	Margin (dB)	Azimuth (deg)
2	1673.0	-60.07	2.00	10.75	vertical	-53.47	-13.0	40.5	45
3	2509.5	-47.49	2.51	11.05	vertical	-41.10	-13.0	28.1	315
4	3346.0	-50.20	4.20	11.15	vertical	-45.4	-13.0	32.4	135
5	4182.5	-52.30	5.20	11.15	vertical	-48.5	-13.0	35.5	270
6	5019.0	-50.00	5.50	11.95	vertical	-45.7	-13.0	32.7	315
7	5855.5	-51.90	5.70	13.55	vertical	-46.2	-13.0	33.2	90
8	6692.0	-49.90	6.30	13.75	vertical	-44.6	-13.0	31.6	225
9	7528.5	-45.30	6.80	13.85	vertical	-40.4	-13.0	27.4	180
10	8365.0	-47.30	6.90	14.25	vertical	-42.1	-13.0	29.1	45

Note: 1.The other Spurious RF Radiated emissions level is no more than noise floor.
2.The worst emission was found in the antenna is vertical position.



LTE Band 5 5MHz CH-High

Harmonic	Frequency (MHz)	SG (dBm)	Cable Loss (dB)	Gain (dBi)	Antenna Polarization	ERP Level (dBm)	Limit (dBm)	Margin (dB)	Azimuth (deg)
2	1693.0	-56.77	2.00	10.75	vertical	-50.17	-13.0	37.2	270
3	2539.5	-51.41	2.51	11.05	vertical	-45.02	-13.0	32.0	135
4	3386.0	-48.80	4.20	11.15	vertical	-44.0	-13.0	30.99	315
5	4232.5	-53.50	5.20	11.15	vertical	-49.7	-13.0	36.70	270
6	5079.0	-49.00	5.50	11.95	vertical	-44.7	-13.0	31.66	135
7	5925.5	-52.50	5.70	13.55	vertical	-46.8	-13.0	33.84	270
8	6772.0	-50.50	6.30	13.75	vertical	-45.2	-13.0	32.23	315
9	7618.5	-45.00	6.80	13.85	vertical	-40.1	-13.0	27.05	90
10	8465.0	-47.20	6.90	14.25	vertical	-42.0	-13.0	28.96	225

Note: 1.The other Spurious RF Radiated emissions level is no more than noise floor.
2.The worst emission was found in the antenna is vertical position.

LTE Band 5 10MHz CH-Low

Harmonic	Frequency (MHz)	SG (dBm)	Cable Loss (dB)	Gain (dBi)	Antenna Polarization	ERP Level (dBm)	Limit (dBm)	Margin (dB)	Azimuth (deg)
2	1658.0	-59.70	2.00	10.75	vertical	-53.10	-13.0	40.1	270
3	2487.0	-51.04	2.51	11.05	vertical	-44.65	-13.0	31.6	45
4	3316.0	-51.70	4.20	11.15	vertical	-46.9	-13.0	33.89	180
5	4145.0	-52.70	5.20	11.15	vertical	-48.9	-13.0	35.85	45
6	4974.0	-51.90	5.50	11.95	vertical	-47.6	-13.0	34.62	315
7	5803.0	-50.20	5.70	13.55	vertical	-44.5	-13.0	31.48	270
8	6632.0	-48.90	6.30	13.75	vertical	-43.6	-13.0	30.59	135
9	7461.0	-47.30	6.80	13.85	vertical	-42.4	-13.0	29.41	270
10	8290.0	-47.80	6.90	14.25	vertical	-42.6	-13.0	29.63	315

Note: 1.The other Spurious RF Radiated emissions level is no more than noise floor.
2.The worst emission was found in the antenna is vertical position.



LTE Band 5 10MHz CH-Middle

Harmonic	Frequency (MHz)	SG (dBm)	Cable Loss (dB)	Gain (dBi)	Antenna Polarization	ERP Level (dBm)	Limit (dBm)	Margin (dB)	Azimuth (deg)
2	1673.0	-59.35	2.00	10.75	vertical	-52.75	-13.0	39.7	315
3	2509.5	-48.34	2.51	11.05	vertical	-41.95	-13.0	28.9	90
4	3346.0	-48.80	4.20	11.15	vertical	-44.0	-13.0	30.99	90
5	4182.5	-52.40	5.20	11.15	vertical	-48.6	-13.0	35.57	225
6	5019.0	-49.70	5.50	11.95	vertical	-45.4	-13.0	32.43	180
7	5855.5	-51.30	5.70	13.55	vertical	-45.6	-13.0	32.60	45
8	6692.0	-48.50	6.30	13.75	vertical	-43.2	-13.0	30.22	315
9	7528.5	-46.40	6.80	13.85	vertical	-41.5	-13.0	28.50	270
10	8365.0	-48.00	6.90	14.25	vertical	-42.8	-13.0	29.85	135

Note: 1.The other Spurious RF Radiated emissions level is no more than noise floor.
2.The worst emission was found in the antenna is vertical position.

LTE Band 5 10MHz CH-High

Harmonic	Frequency (MHz)	SG (dBm)	Cable Loss (dB)	Gain (dBi)	Antenna Polarization	ERP Level (dBm)	Limit (dBm)	Margin (dB)	Azimuth (deg)
2	1688.0	-56.88	2.00	10.75	vertical	-50.28	-13.0	37.3	225
3	2532.0	-48.70	2.51	11.05	vertical	-42.31	-13.0	29.3	180
4	3376.0	-51.40	4.20	11.15	vertical	-46.6	-13.0	33.58	270
5	4220.0	-52.10	5.20	11.15	vertical	-48.3	-13.0	35.26	315
6	5064.0	-49.90	5.50	11.95	vertical	-45.6	-13.0	32.62	90
7	5908.0	-51.50	5.70	13.55	vertical	-45.8	-13.0	32.78	225
8	6752.0	-49.20	6.30	13.75	vertical	-43.9	-13.0	30.85	180
9	7596.0	-46.90	6.80	13.85	vertical	-42.0	-13.0	28.97	45
10	8440.0	-48.20	6.90	14.25	vertical	-43.0	-13.0	29.97	315

Note: 1.The other Spurious RF Radiated emissions level is no more than noise floor.
2.The worst emission was found in the antenna is vertical position.

6. Main Test Instruments

Name	Manufacturer	Type	Serial Number	Calibration Date	Expiration Time
Base Station Simulator	R&S	CMW500	113645	2017-05-14	2018-05-13
Power Splitter	Hua Xiang	SHX-GF2-2-13	10120101	2017-05-14	2018-05-13
Spectrum Analyzer	Agilent	N9010A	MY47191109	2017-05-20	2018-05-19
Universal Radio Communication Tester	Agilent	E5515C	MY48367192	2017-05-20	2018-05-19
Signal Analyzer	R&S	FSV30	100815	2016-12-16	2017-12-15
EMI Test Receiver	R&S	ESCI	100948	2017-05-20	2018-05-19
Signal generator	R&S	SMB 100A	102594	2017-05-14	2018-05-13
Signal generator	R&S	SMR27	100365	2017-05-14	2018-05-13
Trilog Antenna	SCHWARZBECK	VUBL 9163	9163-201	2014-12-06	2017-12-05
Horn Antenna	R&S	HF907	100126	2014-12-06	2017-12-05
Horn Antenna	ETS-Lindgren	3160-09	00102644	2015-01-30	2018-01-29
Climatic Chamber	Re Ce	PT-30B	20101891	2015-07-18	2018-07-17
RF Cable	Agilent	SMA 15cm	0001	2017-02-06	2017-08-05
Preamplifier	R&S	SCU18	102327	2017-06-18	2018-06-17

*****END OF REPORT *****

ANNEX A: EUT Appearance and Test Setup

A.1 EUT Appearance



Front Side



Back Side

a: EUT



b: Battery



c: Adapter

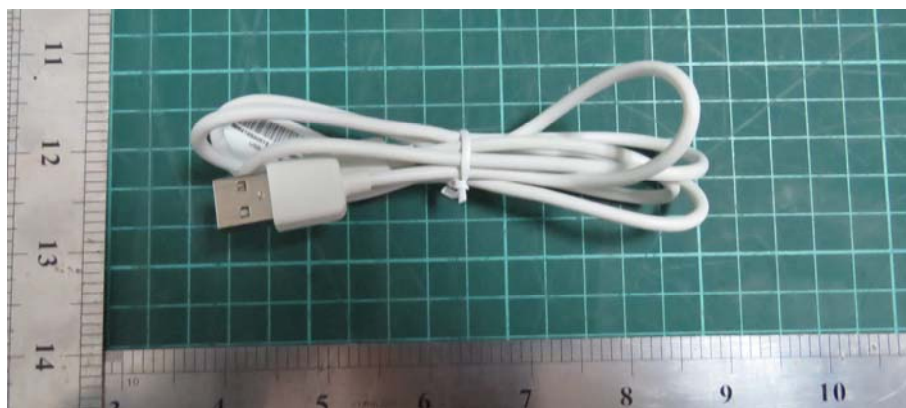

d: USB Cable

Picture 1 EUT and Accessory

A.2 Test Setup

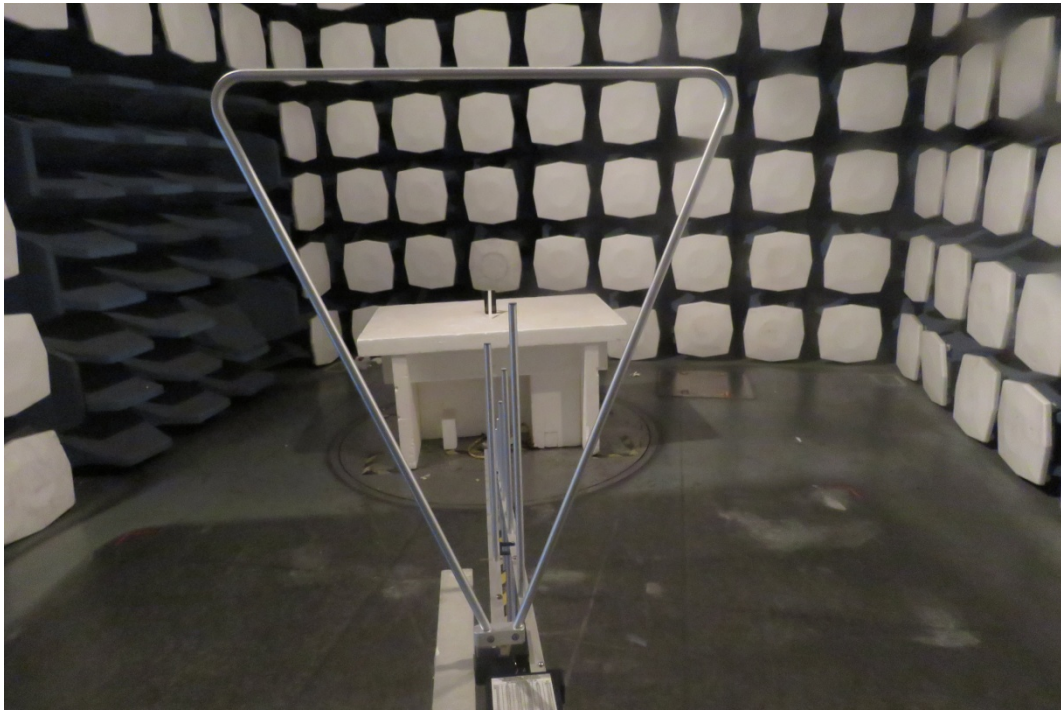

30MHz~ 1GHz

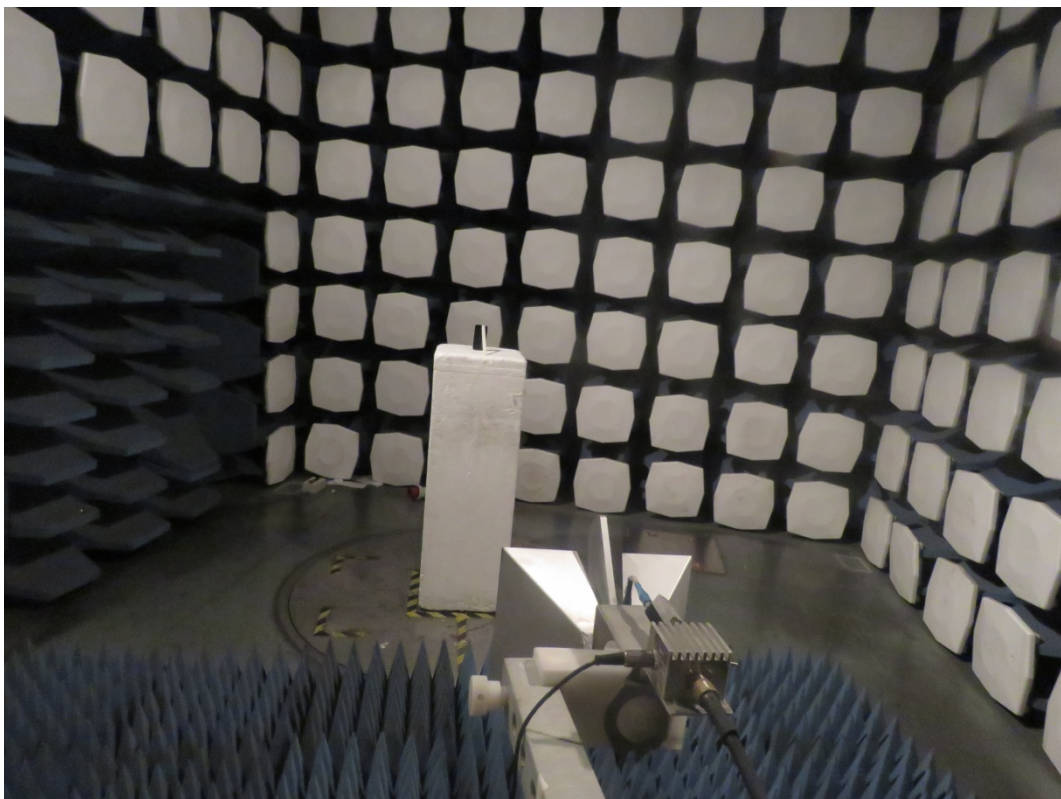

Above 1G

Picture 2: Radiated Spurious Emissions Test setup