



EMC TEST REPORT

Applicant ZTE Corporation

FCC ID SRQ-ZTEBLADEA321

Product LTE/WCDMA/GSM (GPRS)
Multi-Mode Digital Mobile Phone

Brand ZTE

Model ZTE BLADE A321
/ ZTE BLADE A320SE

Report No. RXA1706-0187EMC

Issue Date July 13, 2017

TA Technology (Shanghai) Co., Ltd. tested the above equipment in accordance with the requirements in **FCC Code CFR47 Part15B (2017)/ ANSI C63.4 (2014)**. The test results show that the equipment tested is capable of demonstrating compliance with the requirements as documented in this report.

Wei Liu

Guangchang Fan

Performed by: Wei Liu/ Manager

Approved by: Guangchang Fan/ Director

TA Technology (Shanghai) Co., Ltd.

No.145, Jintang Rd, Tangzhen Industry Park, Pudong Shanghai, China

TEL: +86-021-50791141/2/3

FAX: +86-021-50791141/2/3-8000



Table of Contents

1	Test Laboratory.....	4
1.1	Notes of the Test Report.....	4
1.2	Test facility.....	4
1.3	Testing Location.....	5
2	General Description of Equipment under Test.....	6
2.1	Client Information.....	6
2.2	General information.....	6
2.3	Applied Standards.....	7
2.4	Test Mode.....	8
3	Test Case Results.....	9
3.1	Radiated Emission.....	9
3.2	Conducted Emission.....	15
4	Main Test Instrument.....	17
	ANNEX A: The EUT Appearance and Test Configuration.....	18
	A.1 EUT Appearance.....	18
	A.2 Test Setup.....	20
	A.3 Host Product.....	22



Summary of measurement results

Number	Test Case	Clause in FCC Rules	Conclusion
1	Radiated Emission	15.109, ANSI C63.4-2014	PASS
2	Conducted Emission	15.107, ANSI C63.4-2014	PASS
Date of Testing: June 16, 2017~ July 7, 2017			

1 Test Laboratory

1.1 Notes of the Test Report

This report shall not be reproduced in full or partial, without the written approval of **TA technology (shanghai) co., Ltd.** The results documented in this report apply only to the tested sample, under the conditions and modes of operation as described herein .Measurement Uncertainties were not taken into account and are published for informational purposes only. This report is written to support regulatory compliance of the applicable standards stated above. This report must not be used by the client to claim product certification, approval, or endorsement any government agencies.

1.2 Test facility

CNAS (accreditation number: L2264)

TA Technology (Shanghai) Co., Ltd. has obtained the accreditation of China National Accreditation Service for Conformity Assessment (CNAS).

FCC (recognition number is 428261)

TA Technology (Shanghai) Co., Ltd. has been listed on the US Federal Communications Commission list of test facilities recognized to perform electromagnetic emissions measurements.

IC (recognition number is 8510A)

TA Technology (Shanghai) Co., Ltd. has been listed by industry Canada to perform electromagnetic emission measurement.

VCCI (recognition number is C-4595, T-2154, R-4113, G-10766)

TA Technology (Shanghai) Co., Ltd. has been listed by industry Japan to perform electromagnetic emission measurement.

A2LA (Certificate Number: 3857.01)

TA Technology (Shanghai) Co., Ltd. has been listed by American Association for Laboratory Accreditation to perform electromagnetic emission measurement.



1.3 Testing Location

Company: TA Technology (Shanghai) Co., Ltd.
Address: No.145, Jintang Rd, Tangzhen Industry Park, Pudong Shanghai, China
City: Shanghai
Post code: 201201
Country: P. R. China
Contact: Xu Kai
Telephone: +86-021-50791141/2/3
Fax: +86-021-50791141/2/3-8000
Website: <http://www.ta-shanghai.com>
E-mail: xukai@ta-shanghai.com

2 General Description of Equipment under Test

2.1 Client Information

Applicant	ZTE Corporation
Applicant address	ZTE Plaza, Keji Road South, Hi-Tech, Industrial Park, Nanshan District, Shenzhen, Guangdong, 518057, P.R.China
Manufacturer	ZTE Corporation
Manufacturer address	ZTE Plaza, Keji Road South, Hi-Tech, Industrial Park, Nanshan District, Shenzhen, Guangdong, 518057, P.R.China

2.2 General information

EUT Description	
Device Type:	Portable Device
Model	ZTE BLADE A321 / ZTE BLADE A320SE
IMEI	865984030000110
HW Version:	ucuA
SW Version:	GEN_ LA_A321_V1.0
Antenna Type:	Internal Antenna
Used Host Product:	PC Manufacturer: lenovo Model: Thinkpad T540p (SN : SL10E37685)
Test Mode:	Transfer Data Mode
EUT Accessory	
Battery	Manufacturer: DOCOKOM Model: STC-A508A-Z
Adapter	Manufacturer: BYD Model: Li3822T43P4h736040 Power Rating: DC 3.8V, 2200mAh, Li-ion
USB Cable	99cm Cable, Shielded
Remark: The information of the EUT is declared by the manufacturer.	



2.3 Applied Standards

According to the specifications of the manufacturer, it must comply with the requirements of the following standards:

Test standards

FCC Code CFR47 Part15B (2017)

ANSI C63.4 (2014)

2.4 Test Mode

Test Mode	
Mode 1:	Adapter + USB cable + Camera On +GPS Rx + MP3 +Idle
Mode 2:	Adapter + USB cable + MP3 +Idle
Mode 3:	Adapter + USB cable +Idle
Mode 4:	USB Copy(EUT with PC) + USB cable + Camera On + MP3+GPS Rx +Idle
Mode 5:	Camera On + GPS Rx +Idle
Mode 6:	MP3+Idle
Mode 7:	Idle

During the test, the preliminary test was performed in all modes (Camera/MP3/GPS) with all frequency bands (GSM/ WCDMA/ LTE/ BT/ Wi-Fi), mode4 (with Camera + MP3 + GPS Rx + GSM/ WCDMA/ LTE/ BT/ Wi-Fi idle) selected as the worst condition. The test data of the worst-case condition was recorded in this report.

3 Test Case Results

3.1 Radiated Emission

Ambient condition

Temperature	Relative humidity	Pressure
24°C~26°C	45%~50%	102.5kPa

Methods of Measurement

The EUT is placed on a non-metallic table 0.8m above the horizontal metal reference ground plane. The distance between EUT and receive antenna should be 3 meters. During the test, the EUT was operating in its typical mode. The test method is according to ANSI C63.4-2014. Sweep the whole frequency band through the range from 30MHz to the 5th harmonic of the carrier. During the test, the height of receive antenna shall be moved from 1 to 4 meters, and the antenna shall be performed under horizontal and vertical polarization. The turn table shall be rotated from 0 to 360 degrees for detecting the maximum of radiated signal level.

The data of cable loss and antenna factor has been calibrated in full testing frequency range before the testing. During the test, the EUT is worked at maximum output power.

Set the spectrum analyzer in the following:

Below 1GHz:

RBW=100 kHz / VBW=300 kHz / Sweep=AUTO

Above 1GHz:

(a) PEAK: RBW=1MHz / VBW=3MHz/ Sweep=AUTO

(b) AVERAGE: RBW=1MHz / VBW=3MHz / Sweep=AUTO

The radiated emission was measured in the following position: EUT stand-up position (Z axis), lie-down position (X, Y axis). The worst emission was found in stand-up position (Z axis) and the worst case was recorded.

During the test, EUT is connected to a laptop via a USB cable in the case of Transfer Data mode. The EUT is used as the peripheral equipment of the PC. The data is transferred from EUT to PC; PC is connected to server via a long LAN cable.

Test Setup

Below 1GHz

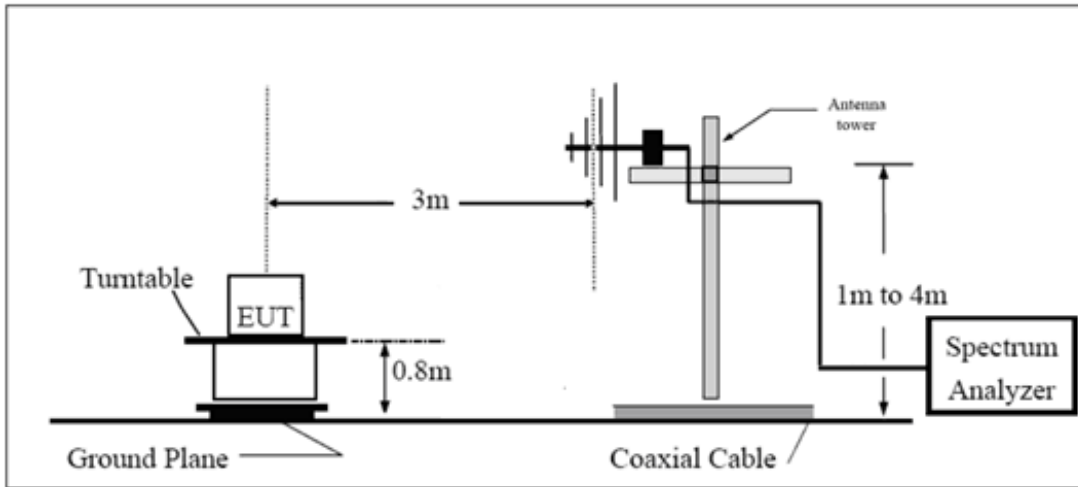

Above 1GHz

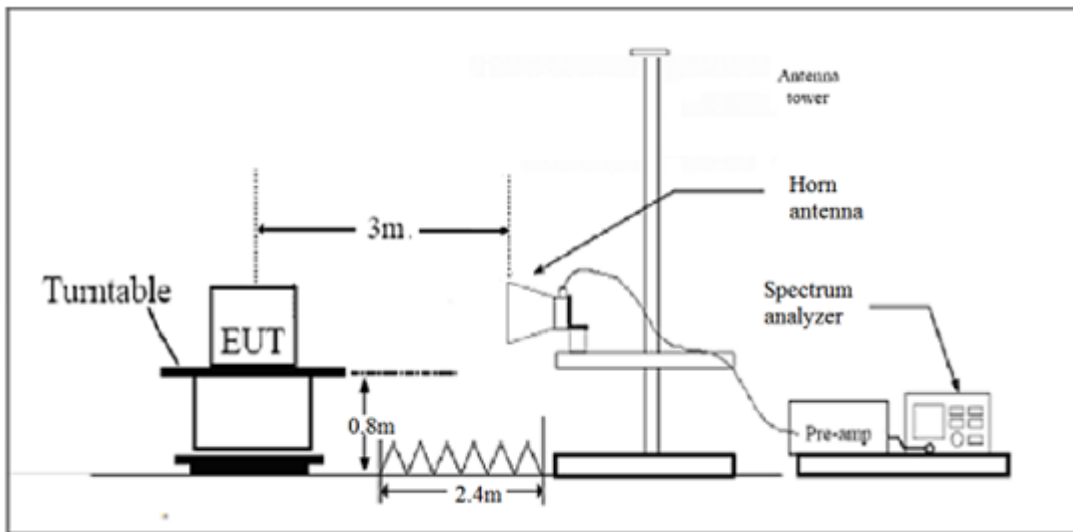

Note: Area side:2.4mX3.6m

Antenna Tower meets ANSI C63.4 requirements for measurements above 1 GHz by keeping the antenna aimed at the EUT during the antenna's ascent/ descent along the antenna mast.

Limits

Frequency (MHz)	Field Strength (dB μ V/m)	Detector
30 -88	40.0	Quasi-peak
88-216	43.5	Quasi-peak
216 – 960	46.0	Quasi-peak
960-1000	54.0	Quasi-peak
1000-5 th harmonic of the highest frequency or 40GHz, which is lower	54 74	Average Peak

Measurement Uncertainty

The assessed measurement uncertainty to ensure 95% confidence level for the normal distribution is with the coverage factor $k = 1.96$. $U = 3.92$ dB.

Test Results

The following graphs display the maximum values of horizontal and vertical by software.
 For above 1GHz, Blue trace uses the peak detection, Green trace uses the average detection.

FCC RE 0.03-1GHz QP Class B

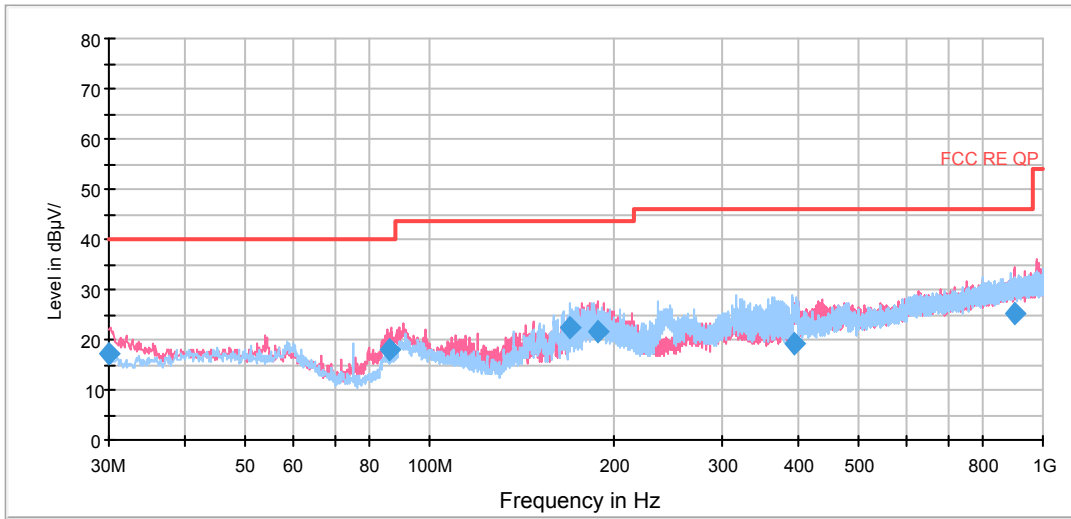

Radiated Emission from 30MHz to 1GHz

Frequency (MHz)	Quasi-Peak (dBuV/m)	Reading value (dBuV/m)	Height (cm)	Polarization	Azimuth (deg)	Correct Factor (dB)	Margin (dB)	Limit (dBuV/m)
30.080000	17.1	5.0	100.0	V	0.0	12.1	22.9	40.0
86.101250	18.1	7.5	114.0	V	85.0	10.6	21.9	40.0
169.397500	22.2	11.8	189.0	H	85.0	10.4	21.3	43.5
188.831250	21.6	10.1	100.0	V	59.0	11.5	21.9	43.5
391.967500	19.4	1.2	100.0	H	17.0	18.2	26.6	46.0
896.776250	25.1	-1.4	100.0	V	4.0	26.5	20.9	46.0

- Remark:**
1. Quasi-Peak = Reading value + Correction factor
 2. Correction Factor = Antenna factor+ Insertion loss(cable loss+amplifier gain)
 3. Margin = Limit – Quasi-Peak



FCC RE 1G-18GHz PK+AV Class B

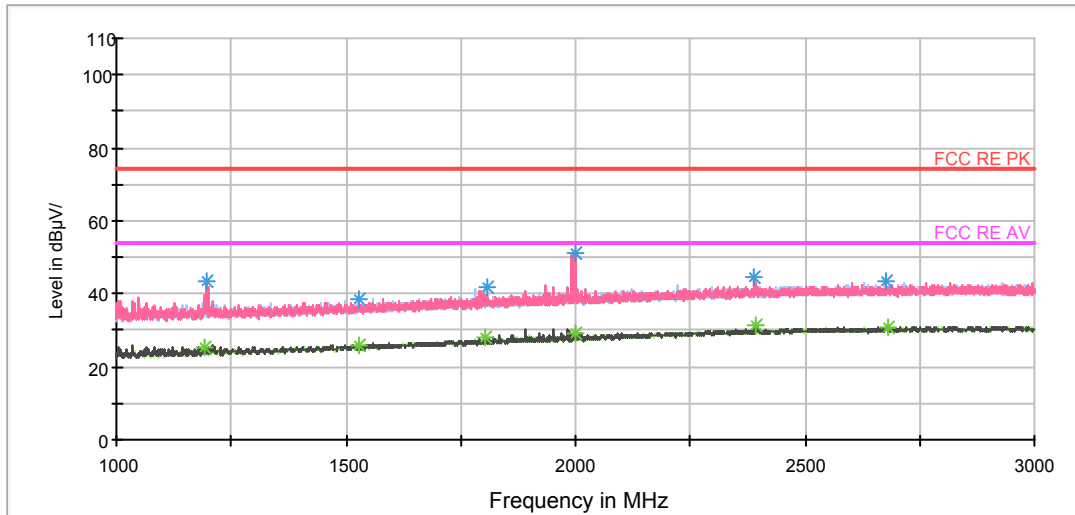

Radiated Emission from 1GHz to 3GHz

Frequency (MHz)	Peak (dBuV/m)	Reading value (dBuV/m)	Height (cm)	Polarization	Azimuth (deg)	Correct Factor (dB)	Margin (dB)	Limit (dBuV/m)
1195.250000	43.3	51.5	100.0	V	0.0	-8.2	30.7	74
1528.250000	38.3	44.6	100.0	V	0.0	-6.3	35.7	74
1805.750000	41.8	46.4	100.0	H	339.0	-4.6	32.2	74
1998.750000	51.2	54.8	100.0	V	252.0	-3.6	22.8	74
2390.750000	44.5	45.8	100.0	V	311.0	-1.3	29.5	74
2678.000000	43.3	43.9	100.0	H	98.0	-0.6	30.7	74

Frequency (MHz)	Average (dBuV/m)	Reading value (dBuV/m)	Height (cm)	Polarization	Azimuth (deg)	Correct Factor (dB)	Margin (dB)	Limit (dBuV/m)
1192.750000	25.4	33.7	100.0	V	0.0	-8.3	28.6	54
1530.250000	25.8	32.1	100.0	V	1.0	-6.3	28.2	54
1805.000000	28.3	32.9	100.0	V	266.0	-4.6	25.7	54
2000.000000	29.2	32.8	100.0	V	238.0	-3.6	24.8	54
2391.000000	31.1	32.4	100.0	V	311.0	-1.3	22.9	54
2683.000000	30.7	31.3	100.0	H	0.0	-0.6	23.3	54

FCC RE 1G-18GHz PK+AV Class B

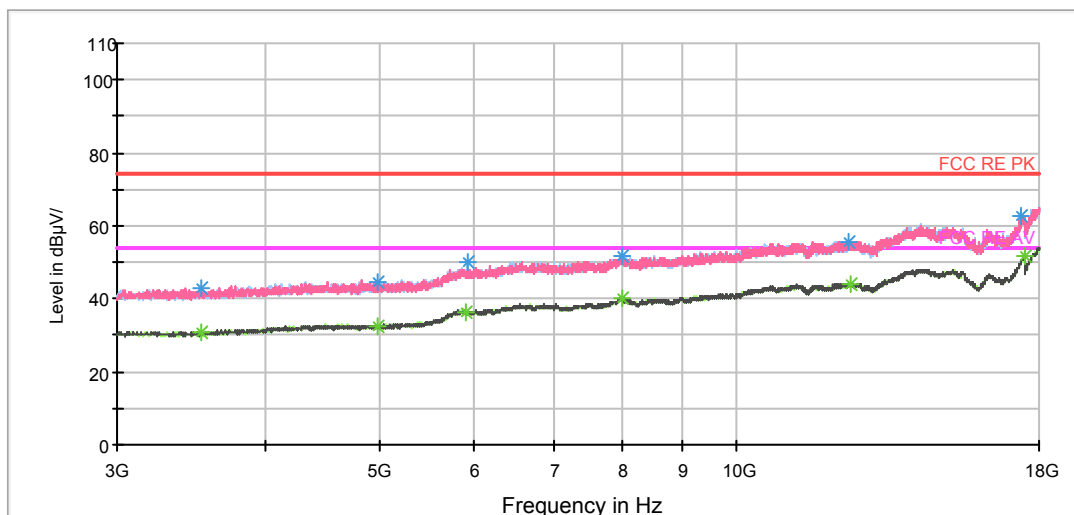

Radiated Emission from 3GHz to 18GHz

Frequency (MHz)	Peak (dBuV/m)	Reading value (dBuV/m)	Height (cm)	Polarization	Azimuth (deg)	Correct Factor (dB)	Margin (dB)	Limit (dBuV/m)
3538.125000	43.0	42.9	100.0	H	356.0	0.1	31.0	74
4970.625000	44.8	43.1	100.0	V	97.0	1.7	29.2	74
5921.250000	50.0	44.7	100.0	H	78.0	5.3	24.0	74
7995.000000	51.6	41.6	100.0	V	0.0	10.0	22.4	74
12418.125000	55.7	41.0	100.0	V	0.0	14.7	18.3	74
17401.875000	62.6	39.8	100.0	V	140.0	22.8	11.4	74

Frequency (MHz)	Average (dBuV/m)	Reading value (dBuV/m)	Height (cm)	Polarization	Azimuth (deg)	Correct Factor (dB)	Margin (dB)	Limit (dBuV/m)
3536.250000	30.5	30.4	100.0	H	0.0	0.1	23.5	54
4970.625000	32.6	30.9	100.0	H	162.0	1.7	21.4	54
5910.000000	36.5	31.1	100.0	V	0.0	5.4	17.5	54
7991.250000	40.4	30.4	100.0	V	3.0	10.0	13.6	54
12504.375000	44.2	29.4	100.0	H	78.0	14.8	9.8	54
17484.375000	51.8	28.2	100.0	V	3.0	23.6	2.2	54

3.2 Conducted Emission

Ambient condition

Temperature	Relative humidity	Pressure
24°C ~26°C	50%~55%	102.5kPa

Methods of Measurement

The EUT is placed on a non-metallic table of 80cm height above the horizontal metal reference ground plane. During the test, the EUT was operating in its typical mode. The test method is according to ANSI C63.4-2014. Connect the AC power line of the EUT to the L.I.S.N. Use EMI receiver to detect the average and Quasi-peak value. RBW is set to 9 kHz, VBW is set to 30kHz. The measurement result should include both L line and N line.

During the test, EUT is connected to a laptop via a USB cable in the case of Transfer Data mode. The EUT is used as the peripheral equipment of the PC. The data is transferred from EUT to PC; PC is connected to server via a long LAN cable.

Test Setup

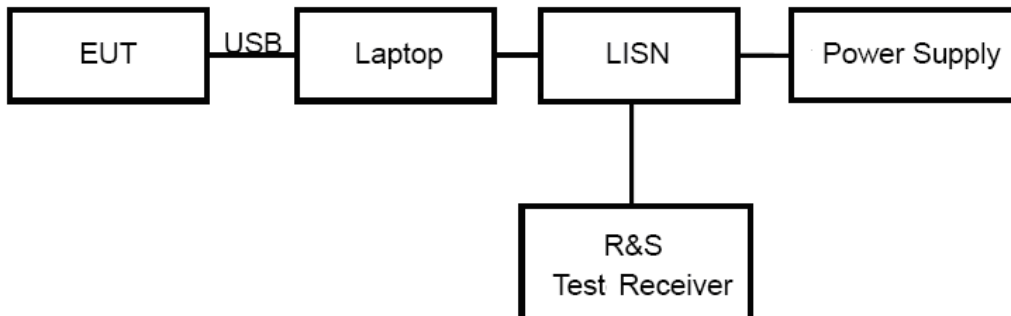

Note: Power Supply is AC Power source and it is used to change the voltage 120V/60Hz.

Limits

Frequency (MHz)	Conducted Limits(dBμV)	
	Quasi-peak	Average
0.15 - 0.5	66 to 56 *	56 to 46 *
0.5 - 5	56	46
5 - 30	60	50

*: Decreases with the logarithm of the frequency.

Measurement Uncertainty

The assessed measurement uncertainty to ensure 95% confidence level for the normal distribution is with the coverage factor $k = 1.96$. $U = 2.69$ dB.

Test Results

Following plots, Blue trace uses the peak detection; Green trace uses the average detection.

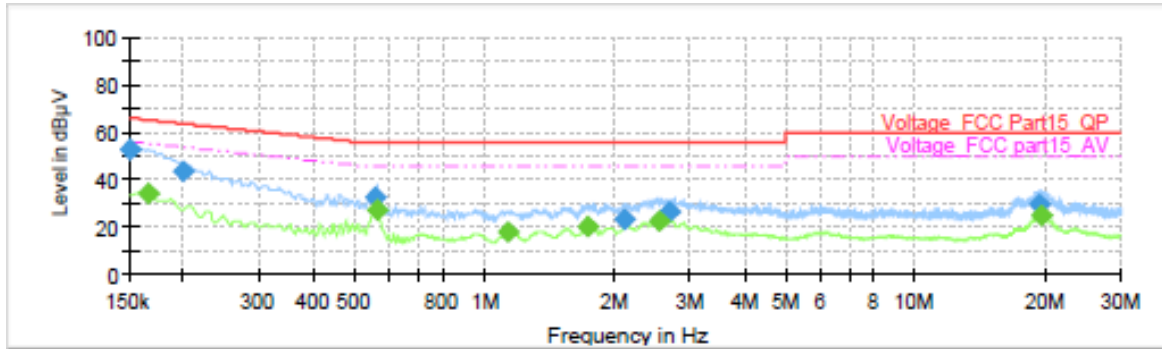

Frequency (MHz)	QuasiPeak (dBµV)	Average (dBµV)	Limit (dBµV)	Margin (dB)	Meas. Time (ms)	Bandwidth (kHz)	Line	Filter	Corr. (dB)
0.150000	53.10	---	66.00	12.90	1000.0	9.000	L1	ON	19.1
0.165750	---	34.30	55.17	20.88	1000.0	9.000	L1	ON	19.1
0.199500	43.70	---	63.63	19.93	1000.0	9.000	L1	ON	19.2
0.555000	32.24	---	56.00	23.76	1000.0	9.000	L1	ON	19.3
0.559500	---	27.08	46.00	18.92	1000.0	9.000	L1	ON	19.3
1.131000	---	17.97	46.00	28.03	1000.0	9.000	L1	ON	19.2
1.738500	---	19.82	46.00	26.18	1000.0	9.000	L1	ON	19.2
2.118750	23.51	---	56.00	32.49	1000.0	9.000	L1	ON	19.1
2.528250	---	22.84	46.00	23.16	1000.0	9.000	L1	ON	19.0
2.676750	26.61	---	56.00	29.39	1000.0	9.000	L1	ON	19.0
19.398750	29.21	---	60.00	30.79	1000.0	9.000	L1	ON	19.6
19.565250	---	24.51	50.00	25.49	1000.0	9.000	L1	ON	19.7

L line

Conducted Emission from 150 KHz to 30 MHz

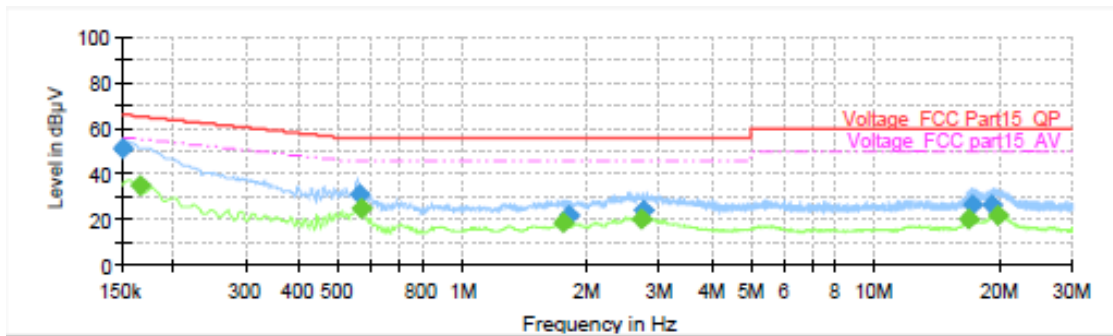

Frequency (MHz)	QuasiPeak (dBµV)	Average (dBµV)	Limit (dBµV)	Margin (dB)	Meas. Time (ms)	Bandwidth (kHz)	Line	Filter	Corr. (dB)
0.150000	51.06	---	66.00	14.94	1000.0	9.000	N	ON	19.1
0.165750	---	34.58	55.17	20.59	1000.0	9.000	N	ON	19.2
0.559500	30.77	---	56.00	25.23	1000.0	9.000	N	ON	19.3
0.568500	---	25.12	46.00	20.88	1000.0	9.000	N	ON	19.3
1.752000	---	18.22	46.00	27.78	1000.0	9.000	N	ON	19.2
1.815000	21.60	---	56.00	34.40	1000.0	9.000	N	ON	19.2
2.724000	---	20.30	46.00	25.70	1000.0	9.000	N	ON	19.0
2.730750	23.79	---	56.00	32.21	1000.0	9.000	N	ON	19.0
16.845000	---	20.29	50.00	29.71	1000.0	9.000	N	ON	19.5
17.209500	26.10	---	60.00	33.90	1000.0	9.000	N	ON	19.5
19.268250	26.14	---	60.00	33.86	1000.0	9.000	N	ON	19.5
19.785750	---	21.73	50.00	28.27	1000.0	9.000	N	ON	19.5

N line

Conducted Emission from 150 KHz to 30 MHz

4 Main Test Instrument

Name	Manufacturer	Type	Serial Number	Last Cal.	Cal. Due Date
Signal Analyzer	R&S	FSV30	100815	2016-12-16	2017-12-15
EMI Test Receiver	R&S	ESCI	100948	2017-05-20	2018-05-19
Loop Antenna	SCHWARZBECK	FMZB1519	1519-047	2017-02-18	2019-02-17
Trilog Antenna	SCHWARZBECK	VULB 9163	9163-201	2014-12-06	2017-12-05
Horn Antenna	R&S	HF907	100126	2014-12-06	2017-12-05
Horn Antenna	ETS-Lindgren	3160-09	00102643	2015-01-30	2018-01-29
EMI Test Receiver	R&S	ESCS30	100138	2016-12-16	2017-12-15
LISN	R&S	ENV216	101171	2016-12-16	2019-12-15
Bore Sight Antenna mast	ETS	2171B	00058752	NA	NA

ANNEX A: The EUT Appearance and Test Configuration

A.1 EUT Appearance



Front Side



Back Side

a: EUT



b: Battery



c: Adapter



d: USB Cable
 Picture 1 EUT

A.2 Test Setup

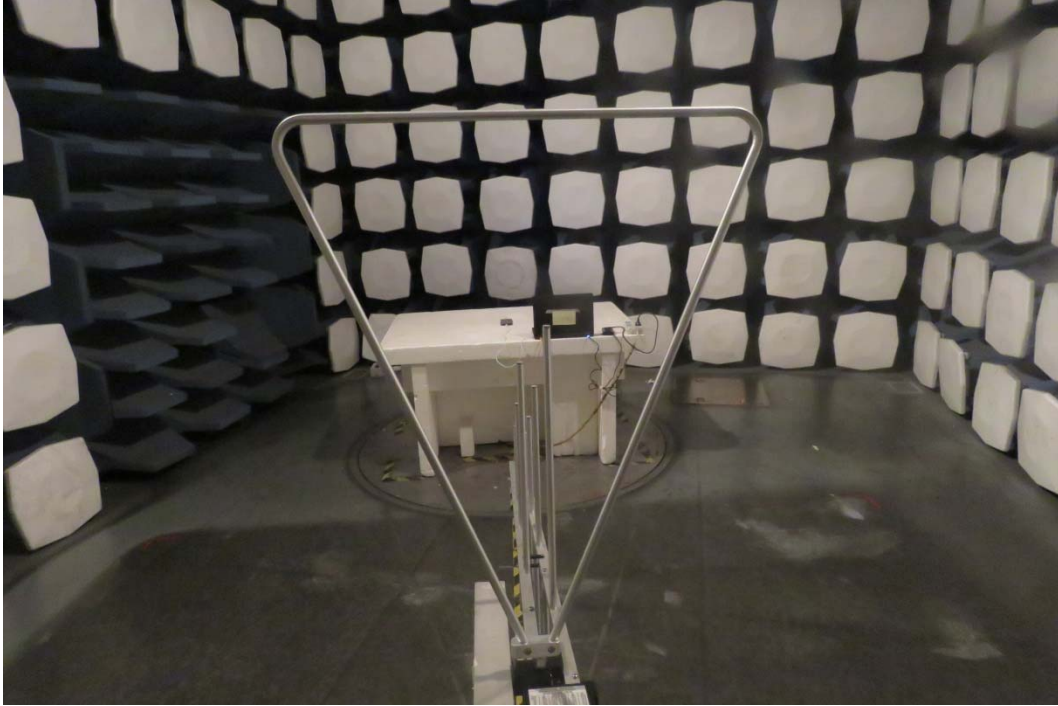

a: Below 1GHz

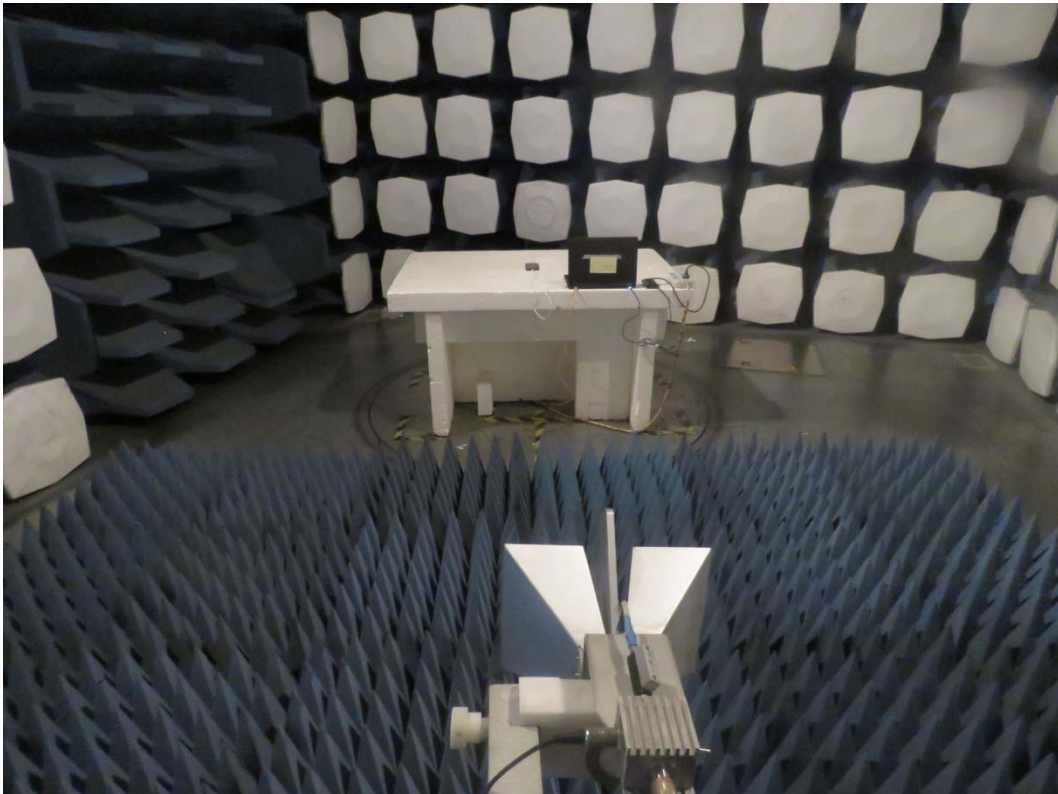

b: Above 1GHz

Picture 2 Radiated Emission Test Setup

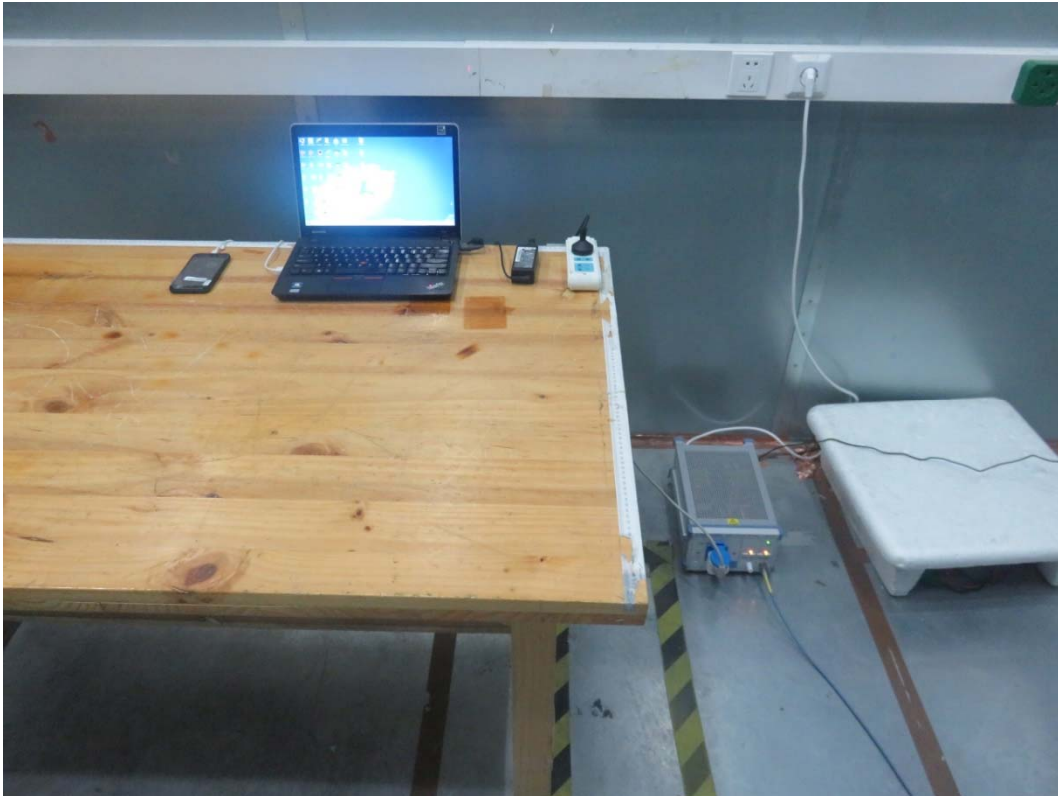

Picture 3 Conducted Emission Test Setup

A.3 Host Product

