

TEST REPORT FOR WCDMA TESTING

Report No.: SRTC2019-9004(F)-19031203(B)

Product Name: LTE/WCDMA/GSM (GPRS) Multi-Mode Digital Mobile
Phone

Product Model: ZTE Blade A7 2019

Applicant: ZTE Corporation

Manufacturer: ZTE Corporation

Specification: FCC Part 24E, Part 22H, Part 2, Part 27 (2019)

FCC ID: SRQ-ZTEA72019

The State Radio_monitoring_center Testing Center (SRTC)
15th Building, No.30 Shixing Street, Shijingshan District,
Beijing, P.R.China

Tel: 86-10-57996183 Fax: 86-10-57996388

CONTENTS

1. GENERAL INFORMATION	2
1.1 NOTES OF THE TEST REPORT	2
1.2 INFORMATION ABOUT THE TESTING LABORATORY	2
1.3 APPLICANT’S DETAILS	2
1.4 MANUFACTURER’S DETAILS	2
1.5 TEST ENVIRONMENT	3
2 DESCRIPTION OF THE DEVICE UNDER TEST	4
2.1 FINAL EQUIPMENT BUILD STATUS.....	4
2.2 SUPPORT EQUIPMENT.....	5
2.3 CONDUCTED MEASUREMENT PATH LOSS	7
2.4 SUMMARY TABLE	7
3 REFERENCE SPECIFICATION	8
4 KEY TO NOTES AND RESULT CODES.....	9
5 RESULT SUMMARY	10
6 TEST RESULT	11
6.1 RF Power Output-FCC Part 22.913(a)/Part24.232(b)	11
6.2 Effective Isotropic Radiated Power-FCC 22.913(a)/24.232(b) /27.50(d)(4)	12
6.3 Occupied Bandwidth-FCC 2.1049/ 27.53(h)(1)	14
6.4 Emission Bandwidth-FCC 22.917(b)/24.238(b).....	15
6.5 Spurious Emissions at antenna terminal-FCC 2.1051/ 22.917(a)/24.238(a)/ 27.53(h)	17
6.6 Band Edges Compliance-FCC 22.917(b)/24.238(b)/ 27.53(h).....	19
6.7 Frequency Stability-FCC 2.1055/22.355/24.235/27.54	21
6.8 Radiated Spurious Emissions-FCC 2.1053/22.917(a)/24.238(a)/ 27.53(h), 27.53(g).....	23
6.9 Peak-Average Ratio -FCC 24.232(d)/ 27.50(d)(5)	28
7 MEASUREMENT UNCERTAINTIES	29
8 TEST EQUIPMENTS	30
APPENDIX A – TEST DATA OF CONDUCTED EMISSION	30
APPENDIX B – TEST DATA OF RADIATED EMISSION	30

1. GENERAL INFORMATION

1.1 Notes of the test report

The test report may only be reproduced or published in full. Reproduction or publication of extracts from the report requires the prior written permission of The State Radio_monitoring_center Testing Center (SRTC).

The test results relate only to individual items of the samples which have been tested.

The certification and accreditation identifiers used in this report shall not be applicable to the tested or calibrated samples thereof. The manufacturer shall not mark the tested samples or items (or a separate part of the item) with the identifiers of certification and accreditation to mislead relevant parties about the tested samples or items.

1.2 Information about the testing laboratory

Company:	The State Radio_monitoring_center Testing Center (SRTC)
Address:	15th Building, No.30 Shixing Street, Shijingshan District, P.R.China
City:	Beijing
Country or Region:	P.R.China
Contacted person:	Liu Jia
Tel:	+86 10 57996183
Fax:	+86 10 57996388
Email:	liujiat@srtc.org.cn

1.3 Applicant's details

Company:	ZTE Corporation
Address:	ZTE Plaza, #55 Keji Road South, Hi-Tech, Industrial Park, Nanshan District,Guangdong
City:	Shenzhen
Country or Region:	China
Contacted person:	Yang Zhao
Tel:	029-83600770
Fax:	---
Email:	zhao.yangxa@zte.com.cn

1.4 Manufacturer's details

Company:	ZTE Corporation
Address:	ZTE Plaza, #55 Keji Road South, Hi-Tech, Industrial Park, Nanshan District,Guangdong
City:	Shenzhen
Country or Region:	China
Contacted person:	Yang Zhao
Tel:	029-83600770
Fax:	---
Email:	zhao.yangxa@zte.com.cn

1.5 Test Environment

Date of Receipt of test sample at SRTC:	2019-03-12
Testing Start Date:	2019-03-18
Testing End Date:	2019-04-01

Environmental Data:	Temperature (°C)	Humidity (%)
Ambient	25	30
Maximum Extreme	55	---
Minimum Extreme	-10	---

Normal Supply Voltage (V d.c.):	3.85
Maximum Extreme Supply Voltage (V d.c.):	4.40
Minimum Extreme Supply Voltage (V d.c.):	3.46

2 DESCRIPTION OF THE DEVICE UNDER TEST

2.1 Final Equipment Build Status

Frequency Range	WCDMA Band II: Tx:1852.4~1907.6MHz Rx:1932.4~1987.6MHz WCDMA Band IV: Tx:1712.4~1752.6MHz Rx:2112.4~2152.6MHz WCDMA Band V: Tx:826.4~846.6MHz Rx:871.4~891.6MHz
Mode	HSDPA/HSUPA/HSPA+
Emission Designator	4M50F9W
Duplex Mode	FDD
Duplex Spacing	WCDMA Band II:80MHz WCDMA Band IV:400MHz WCDMA Band V:45MHz
Antenna Type	IFA Antenna
Power Supply	Battery/Charger
HW Version	ukhB
SW Version	TEL_MX_ZTE_Blade_A7_2019V1.0
IMEI	864432040006454

2.2 Support Equipment

The following support equipment was used to exercise the DUT during testing:

Equipment	Battery
Manufacturer	Ningbo Veken Battery Co., Ltd.
Model Number	Li3931T44P8h806139
Serial Number	---

Equipment	Battery
Manufacturer	Zhongshan Tianmao Battery Co., Ltd.
Model Number	Li3931T44P8h806139
Serial Number	---

Equipment	Charger
Manufacturer	RUIJING
Model Number	STC-A515A-Z
Serial Number	---

Equipment	Charger
Manufacturer	CHENYANG
Model Number	STC-A515A-Z
Serial Number	---

Equipment	Charger
Manufacturer	DOKOCOM
Model Number	STC-A515A-A
Serial Number	---

Equipment	Charger
Manufacturer	RUIJING
Model Number	STC-A515A-A
Serial Number	---

Equipment	Charger
Manufacturer	CHENYANG
Model Number	STC-A515A-A
Serial Number	---

Equipment	Headset
Manufacturer	JUWEI ELECTRONICS CO.,LTD
Model Number	JWEP1036-Z01R
Serial Number	---

Equipment	Headset
Manufacturer	ShenZhen FDC Electronic Co.,Ltd
Model Number	DEM-66
Serial Number	---

Equipment	USB Cable
Manufacturer	Dongguan Guojun Plastic Electronic Co.,Ltd
Model Number	USB-MU5-W-70-M-L
Serial Number	---

Equipment	USB Cable
Manufacturer	Shen Zhen Shi Yi HUA XING Electron Co.,Ltd
Model Number	USB-MU5-W-70-M-L
Serial Number	---

2.3 Conducted measurement Path Loss

WCDMA B2 Offset 6.8dB = Power Divider 6dB+ Temporary antenna connector loss 0.2dB+ Cable loss 0.6dB

WCDMA B4 Offset 6.8dB = Power Divider 6dB+ Temporary antenna connector loss 0.2dB+ Cable loss 0.6dB

WCDMA B5 Offset 6.5dB = Power Divider 6dB+ Temporary antenna connector loss 0.2dB+ Cable loss 0.3dB

2.4 Summary table.

FCC Rule Part	Frequency Range(MHz)	Conducted Power (dBm)	ERP/ EIRP (W)	Frequency Tolerance (ppm)	Emission Designator
24E	1852.4-1907.6	23.80	0.333	0.016	4M16F9W
22H	826.4-846.6	23.62	0.064	0.019	4M17F9W
27	1712.4-1752.6	23.79	0.233	0.015	4M16F9W

3 REFERENCE SPECIFICATION

Specification	Version	Title
2.1046	2019	Measurements required: RF power output.
2.1049	2019	Measurements required: Occupied bandwidth.
2.1051	2019	Measurements required: Spurious emissions at antenna terminals.
2.1053	2019	Measurements required: Field strength of spurious radiation.
2.1055	2019	Measurements required: Frequency stability.
22.355	2019	Frequency tolerance.
22.913	2019	Effective radiated power limits.
22.917	2019	Emission limitations for cellular equipment.
24.232	2019	Power and antenna height limits.
24.235/27.54	2019	Frequency stability.
24.238	2019	Emission limitations for Broadband PCS equipment.
27.50	2019	Power limits and duty cycle.
27.53	2019	Emission limits.
ANSI C63.26	2015	American National Standard for Compliance Testing of Transmitters Used in Licensed Radio Services
KDB 971168 D01	April 9, 2018	MEASUREMENT GUIDANCE FOR CERTIFICATION OF LICENSED DIGITAL TRANSMITTERS



4 KEY TO NOTES AND RESULT CODES

The following are the definition of the test result.

Code	Meaning
PASS	Test result shows that the requirements of the relevant specification have been met.
FAIL	Test result shows that the requirements of the relevant specification have not been met.
N/T	Test case is not tested.
NTC	Nominal voltage, Normal Temperature
HV	High voltage, Normal Temperature
LV	Low voltage, Normal Temperature
HTHV	high voltage, High Temperature
LTHV	High voltage, Low Temperature
HTLV	Low voltage, High Temperature
LTLV	Low voltage, Low Temperature

5 RESULT SUMMARY

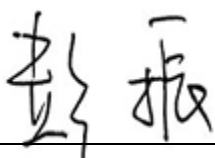
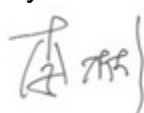
No.	Test case	FCC reference	Verdict
1	RF Power Output	22.913(a)/24.232(b)	Pass
2	Effective Radiated Power and Effective Isotropic Radiated Power	22.913(a)/24.232(b) /27.50(d)(4)	Pass
3	Occupied Bandwidth	2.1049/27.53(h)(1)	Pass
4	Emission Bandwidth	22.917(b)/24.238(b)	Pass
5	Spurious Emissions at antenna terminal	2.1051/22.917(a)/24.238(a)/ 27.53(h)	Pass
6	Band Edges Compliance	22.917(b)/24.238(b)/ 27.53(h)	Pass
7	Frequency Stability	2.1055/22.355/24.235/27.54	Pass
8	Radiated Spurious Emissions	2.1053/22.917(a)/24.238(a)/ 27.53(h), 27.53(g)	Pass
9	Peak-Average Ratio	24.232(d)/ 27.50(d)(5)	Pass

This Test Report Is Issued by: Mr. Peng Zhen 	Checked by: Mr. Li Bin 
Tested by: Tong Daocheng 	Issued date: 20190403

6 TEST RESULT

6.1 RF Power Output-FCC Part 22.913(a)/Part24.232(b)

Ambient condition:

Temperature	Relative humidity	Pressure
25°C	30%	101.9kPa

Test Setup:

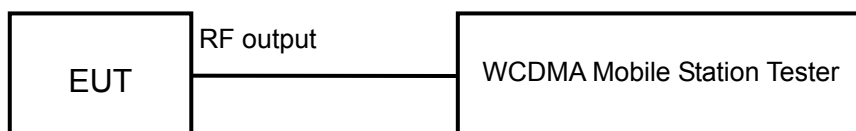

WCDMA band II

Test procedure:

After a radio link has been established between EUT and Tester, the output power of the cell signal of the testing equipment will be decreased until the output power of the EUT reach a maximum value. Then the test data can be read at the tester screen. The loss between RF output port of the EUT and the input port of the tester will be taken into consideration.

The measurement will be conducted at three channels No9262, No9400 and No9538 (Bottom, middle and top channels of WCDMA band II)

Limits	≤24dBm
--------	--------

WCDMA band V

Test procedure:

After a radio link has been established between EUT and Tester, the output power of the cell signal of the testing equipment will be decreased until the output power of the EUT reach a maximum value. Then the test data can be read at the tester screen. The loss between RF output port of the EUT and the input port of the tester will be taken into consideration.

The measurement will be conducted at three channels No4132, No4183 and No4233 (Bottom, middle and top channels of WCDMA band V)

Limits	≤24dBm
--------	--------

WCDMA band IV

Test procedure:

After a radio link has been established between EUT and Tester, the output power of the cell signal of the testing equipment will be decreased until the output power of the EUT reach a maximum value. Then the test data can be read at the tester screen. The loss between RF output port of the EUT and the input port of the tester will be taken into consideration. The measurement will be conducted at three channels No1312, No1412 and No1513 (Bottom, middle and top channels of WCDMA band IV)

Limits	≤24dBm
--------	--------

Test result:

The test results are shown in Appendix A.

6.2 Effective Isotropic Radiated Power-FCC 22.913(a)/24.232(b) /27.50(d)(4)

Ambient condition:

Temperature	Relative humidity	Pressure
25°C	30%	101.9kPa

Test Setup:

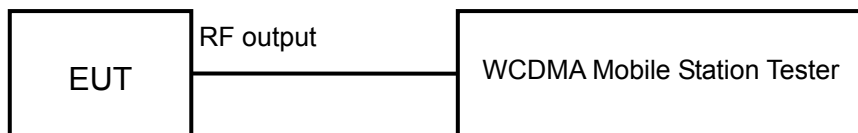

WCDMA band II

Test procedure:

After a radio link has been established between EUT and Tester, the output power of the cell signal of the testing equipment will be decreased until the output power of the EUT reach a maximum value. Then the test data can be read at the tester screen. The loss between RF output port of the EUT and the input port of the tester will be taken into consideration.

$$\text{Power (EIRP)} = P_{\text{mea}} + G_a$$

The measurement will be done at three channels No9262, No9400 and No9538 (Bottom, middle and top channels of WCDMA band II).

Limits	≤33.0dBm
--------	----------

WCDMA band V

Test procedure:

After a radio link has been established between EUT and Tester, the output power of the cell signal of the testing equipment will be decreased until the output power of the EUT reach a maximum value. Then the test data can be read at the tester screen. The loss between RF output port of the EUT and the input port of the tester will be taken into consideration.

$$\text{Power (EIRP)} = P_{\text{mea}} + G_a$$

This value is EIRP since the measurement is calibrated using an antenna of known gain (2.15dB) and known input power. ERP can be calculated from EIRP by subtracting the gain of the dipole, $\text{ERP} = \text{EIRP} - 2.15 \text{ (dB)}$.

The measurement will be done at three channels No4132, No4183 and No4233 (Bottom, middle and top channels of WCDMA band V)

Limits	$\leq 38.5\text{dBm}$
--------	-----------------------

WCDMA band IV

Test procedure:

After a radio link has been established between EUT and Tester, the output power of the cell signal of the testing equipment will be decreased until the output power of the EUT reach a maximum value. Then the test data can be read at the tester screen. The loss between RF output port of the EUT and the input port of the tester will be taken into consideration.

$$\text{Power (EIRP)} = P_{\text{mea}} + G_a$$

The measurement will be done at three channels No1312, No1412 and No1513 (Bottom, middle and top channels of WCDMA band IV).

Limits	$\leq 30.0\text{dBm}$
--------	-----------------------

Test result:

The test results are shown in Appendix A.

6.3 Occupied Bandwidth-FCC 2.1049/ 27.53(h)(1)

Ambient condition:

Temperature	Relative humidity	Pressure
25°C	30%	101.9kPa

Test Setup:

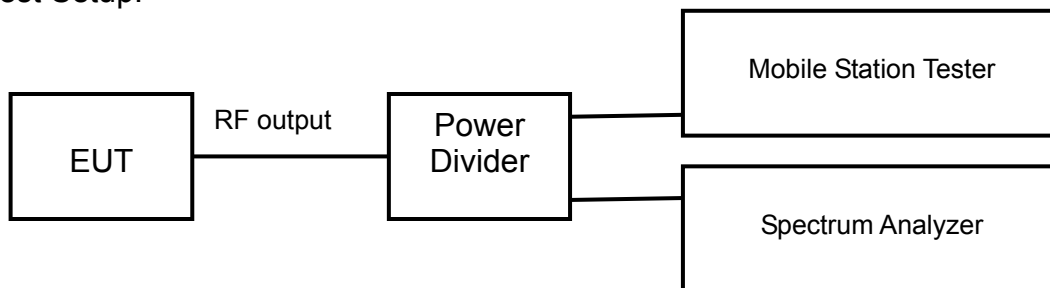

WCDMA band II

Test procedure:

After a radio link has been established between EUT and Tester, the output power of the cell signal of the testing equipment will be decreased until the output power of the EUT reach a maximum value. The occupied bandwidth is measured using spectrum analyzer. RBW is set to 51kHz on spectrum analyzer. The bandwidth of 99% power can be read on spectrum analyzer.

The measurement will be conducted at three channels No9262, No9400 and No9538 (Bottom, middle and top channels of WCDMA band II)

Limits: No specific occupied bandwidth requirements in part 2.1049

WCDMA band V

Test procedure:

After a radio link has been established between EUT and Tester, the output power of the cell signal of the testing equipment will be decreased until the output power of the EUT reach a maximum value. The occupied bandwidth is measured using spectrum analyzer. RBW is set to 30kHz on spectrum analyzer. The bandwidth of 99% power can be read on spectrum analyzer.

The measurement will be conducted at three channels No4132, No4183 and No4233 (Bottom, middle and top channels of WCDMA band V)

Limits: No specific occupied bandwidth requirements in part 2.1049

WCDMA band IV

Test procedure:

After a radio link has been established between EUT and Tester, the output power of the cell signal of the testing equipment will be decreased until the output power of the EUT reach a maximum value. The occupied bandwidth is measured using spectrum analyzer. RBW is set to 51kHz on spectrum analyzer. The bandwidth of 99% power can be read on spectrum analyzer.

The measurement will be conducted at three channels No1312, No1412 and No1513 (Bottom, middle and top channels of WCDMA band IV)

Limits: No specific occupied bandwidth requirements in part 2.1049

Test result:

The test results are shown in Appendix A.

6.4 Emission Bandwidth-FCC 22.917(b)/24.238(b)

Ambient condition:

Temperature	Relative humidity	Pressure
25°C	30%	101.9kPa

Test Setup:

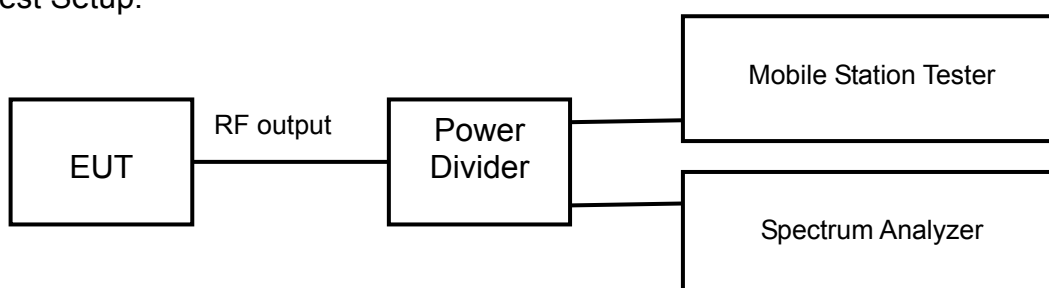

WCDMA band II

Test procedure:

After a radio link has been established between EUT and Tester, the output power of the cell signal of the testing equipment will be decreased until the output power of the EUT reach a maximum value. The emission bandwidth is measured using spectrum analyzer. RBW is set to 30kHz on spectrum analyzer. The bandwidth of -26dBc power can be read on spectrum analyzer.

The measurement will be conducted at three channels No9262, No9400 and No9538 (Bottom, middle and top channels of WCDMA band II)

Limits: No specific emission bandwidth requirements in part 24.238(b)

WCDMA band V

Test procedure:

After a radio link has been established between EUT and Tester, the output power of the cell signal of the testing equipment will be decreased until the output power of the EUT reach a maximum value. The emission bandwidth is measured using spectrum analyzer. RBW is set to 30kHz on spectrum analyzer. The bandwidth of -26dBc power can be read on spectrum analyzer.

The measurement will be conducted at three channels No9262, No9400 and No9538 (Bottom, middle and top channels of WCDMA band V)

Limits: No specific emission bandwidth requirements in part 22.917(b)

WCDMA band IV

Test procedure:

After a radio link has been established between EUT and Tester, the output power of the cell signal of the testing equipment will be decreased until the output power of the EUT reach a maximum value. The emission bandwidth is measured using spectrum analyzer. RBW is set to 30kHz on spectrum analyzer. The bandwidth of -26dBc power can be read on spectrum analyzer.

The measurement will be conducted at three channels No1312, No1412 and No1513 (Bottom, middle and top channels of WCDMA band IV)

Limits: No specific emission bandwidth requirements in part 24.238(b)

Test result:

The test results are shown in Appendix A.

6.5 Spurious Emissions at antenna terminal-FCC 2.1051/ 22.917(a)/24.238(a)/ 27.53(h)

Ambient condition:

Temperature	Relative humidity	Pressure
25°C	30%	101.9kPa

Test Setup:

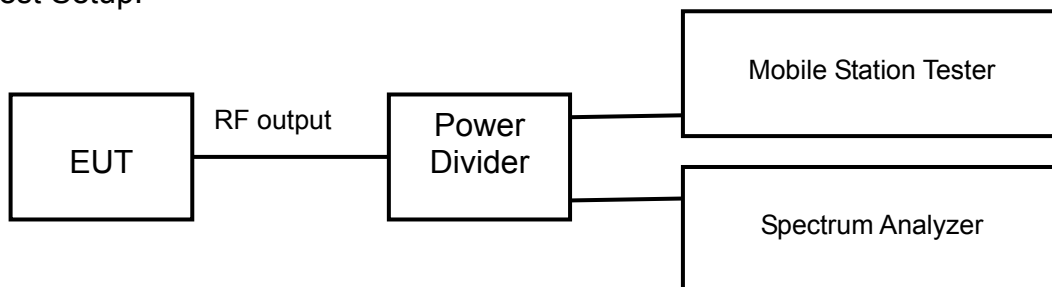

WCDMA band II

Test procedure:

After a radio link has been established between EUT and Tester, the output power of the cell signal of the testing equipment will be decreased until the output power of the EUT reach a maximum value. The measurement is carried out using a spectrum analyzer. The spectrum analyzer scans from 30MHz to 20GHz (higher than the 10th harmonic of the carrier). The peak detector is used and RBW is set to 1MHz on spectrum analyzer.

The measurement will be conducted at one channel No9400 (middle channel of WCDMA band II)

Limits	≤-13dBm
--------	---------

WCDMA band V

Test procedure:

After a radio link has been established between EUT and Tester, the output power of the cell signal of the testing equipment will be decreased until the output power of the EUT reach a maximum value. The measurement is carried out using a spectrum analyzer. The spectrum analyzer scans from 30MHz to 9GHz (higher than the 10th harmonic of the carrier). The peak detector is used and RBW is set to 1MHz on spectrum analyzer.

The measurement will be conducted at one channel No4183 (middle channel of WCDMA band V)

Limits	≤-13dBm
--------	---------

WCDMA band IV

Test procedure:

After a radio link has been established between EUT and Tester, the output power of the cell signal of the testing equipment will be decreased until the output power of the EUT reach a maximum value. The measurement is carried out using a spectrum analyzer. The spectrum analyzer scans from 30MHz to 20GHz (higher than the 10th harmonic of the carrier). The peak detector is used and RBW is set to 1MHz on spectrum analyzer.

The measurement will be conducted at one channel No1412 (middle channel of WCDMA band IV)

Limits	$\leq -13\text{dBm}$
--------	----------------------

Test result:

The test results are shown in Appendix A.

6.6 Band Edges Compliance-FCC 22.917(b)/24.238(b)/ 27.53(h)

Ambient condition:

Temperature	Relative humidity	Pressure
25°C	30%	101.9kPa

Test Setup:

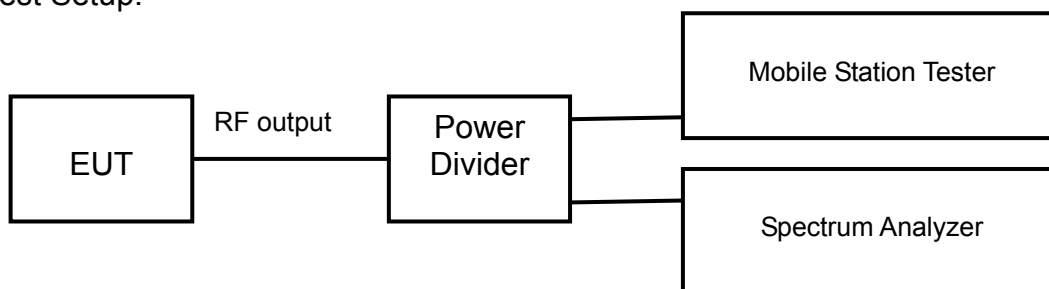

WCDMA band II

Test procedure:

After a radio link has been established between EUT and Tester, the output power of the cell signal of the testing equipment will be decreased until the output power of the EUT reach a maximum value. The measurement is carried out using a spectrum analyzer. The peak detector is used and RBW is set to at least 1% of the emission bandwidth on spectrum analyzer.

The measurement will be conducted at two channels No9262 and No9538 (Bottom and top channels of WCDMA band II)

Limits	$\leq -13\text{dBm}$
--------	----------------------

WCDMA band V

Test procedure:

After a radio link has been established between EUT and Tester, the output power of the cell signal of the testing equipment will be decreased until the output power of the EUT reach a maximum value. The measurement is carried out using a spectrum analyzer. The peak detector is used and RBW is set to at least 1% of the emission bandwidth on spectrum analyzer.

The measurement will be conducted at two channels No4132 and No4233 (Bottom and top channels of WCDMA band V)

Limits	$\leq -13\text{dBm}$
--------	----------------------

WCDMA band IV

Test procedure:

After a radio link has been established between EUT and Tester, the output power of the cell signal of the testing equipment will be decreased until the output power of the EUT reach a maximum value. The measurement is carried out using a spectrum analyzer. The peak detector is used and RBW is set to at least 1% of the emission bandwidth on spectrum analyzer.

The measurement will be conducted at two channels No1312 and No1513 (Bottom and top channels of WCDMA band IV)

Limits	$\leq -13\text{dBm}$
--------	----------------------

Test result:

The test results are shown in Appendix A.

6.7 Frequency Stability-FCC 2.1055/22.355/24.235/27.54

Ambient condition:

Temperature	Relative humidity	Pressure
25°C	30%	101.9kPa

Test setup:

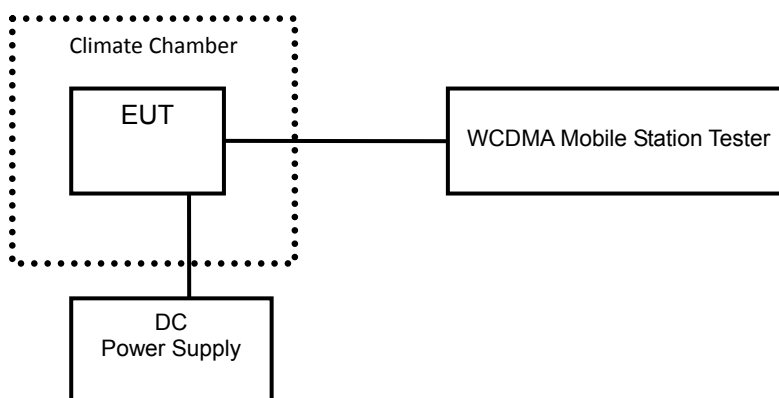

WCDMA band II

Test Procedure:

A radio link shall be established between EUT and Tester. The tester will sample the transmitter RF output signal and measure its frequency. The temperature inside the climate chamber is varied from -30 to +50°C in 10°C step size, and also the DC power supply voltage to the EUT is varied from LV to HV. The measurement will be conducted at three channels No9262, No9400 and No9538 (Bottom, middle and top channels of WCDMA band II).

Limits: No specific frequency stability requirements in part 2.1055 and part 24.235.

WCDMA band V

Test Procedure:

A radio link shall be established between EUT and Tester. The tester will sample the transmitter RF output signal and measure its frequency. The temperature inside the climate chamber is varied from -30 to +50°C in 10°C step size, and also the DC power supply voltage to the EUT is varied from LV to HV. The measurement will be conducted at three channels No4132, No4183 and No4233 (Bottom, middle and top channels of WCDMA band V).

Limits: No specific frequency stability requirements in part 2.1055 and part 22.355.

WCDMA band IV

Test Procedure:

A radio link shall be established between EUT and Tester. The tester will sample the transmitter RF output signal and measure its frequency. The temperature inside the climate chamber is varied from -30 to +50°C in 10°C step size, and also the DC power supply voltage to the EUT is varied from LV to HV. The measurement will be conducted at three channels No1312, No1412 and No1513 (Bottom, middle and top channels of WCDMA band IV).

Limits: No specific frequency stability requirements in part 2.1055 and part 24.235.

Test result:

The test results are shown in Appendix A.

6.8 Radiated Spurious Emissions-FCC 2.1053/22.917(a)/24.238(a)/ 27.53(h), 27.53(g)

Ambient condition:

Temperature	Relative humidity	Pressure
25°C	30%	101.9kPa

Test Setup:

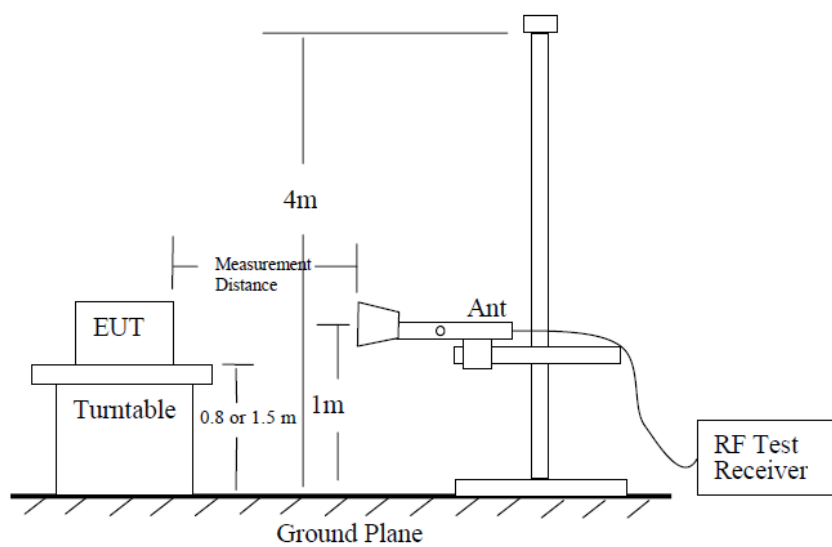

Step 1

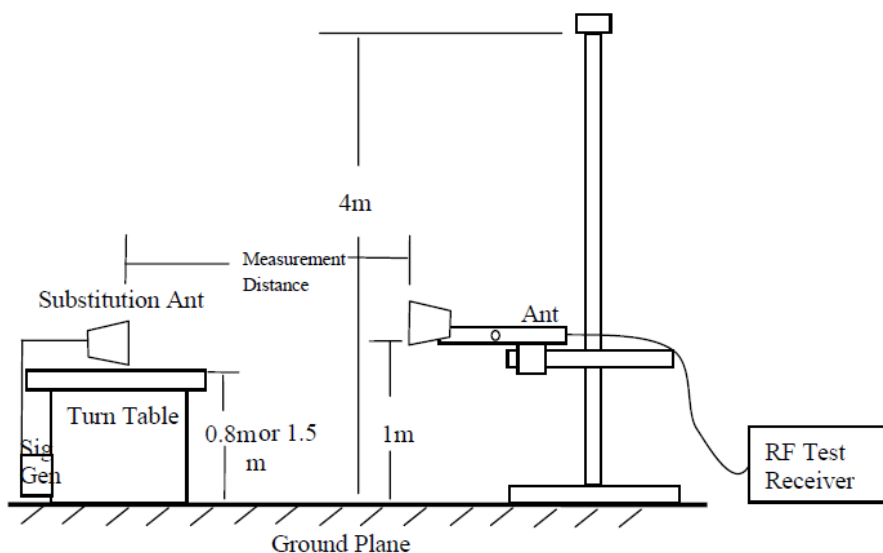

Step 2

WCDMA band II

Test procedure:

The measurements procedures in TIA-603C-2004 are used.

The spectrum was scanned from 30MHz to the 10th harmonic of the highest frequency generated within the equipment.

Step 1:

The measurement is carried out in the fully anechoic chamber. EUT was placed on a 2.4 meter high non-conductive table at a 3 meter test distance from the test receive antenna. A receiving antenna was placed on the antenna mast 3 meters from the EUT. The height of receiving antenna is 2.4m and varies in certain range to find the maximum power value. A radio link shall be established between EUT and Tester. The output power of the cell signal of the tester will be decreased until the output power of the EUT reach a maximum value. The measurement is carried out using a spectrum analyzer or receiver. The spectrum analyzer scans from 30MHz to 20GHz (higher than the 10th harmonic of the carrier). The peak detector is used and RBW is set to 1MHz on spectrum analyzer. Then the antenna height and turn table rotation is adjusted till the maximum power value is founded on spectrum analyzer or receiver. A notch filter is necessary in the band near to the carrier frequency. A high pass filter is needed to avoid the distortion of the testing equipment in the band above the carrier frequency.

Step 2:

A log-periodic antenna or double-ridged waveguide horn antenna shall be substituted in place of the EUT. The log-periodic antenna will be driven by a signal generator and the level will be adjusted till the same power value on the spectrum analyzer or receiver. The level of the spurious emissions can be calculated through the level of the signal generator, cable loss, the gain of the substitution antenna and the reading of the spectrum analyzer or receiver.

A power (P_{mea}) is applied to the input of the substitution antenna, and adjusts the level of the signal generator output until the value of the receiver reach the previously recorded (P_r). The power of signal source (P_{mea}) is recorded. The test should be performed by rotating the test item and adjusting the receiving antenna polarization.

A "reference path loss" should be calculated after test. The attenuation of "reference path loss" is the cable loss between the Signal Source with the Substitution Antenna (P_{ca}) and the Substitution Antenna Gain (G_a).

Calculation procedure:

The data of cable loss and antenna gain has been calibrated in full testing frequency range before the testing.

The power of the Radiated Spurious Emissions is calculated by adding the cable loss and antenna gain. The basic equation with a sample calculation is as followed:

$$\text{Power(EIRP)} = P_{mea} + P_{ca} + G_a$$

This value is EIRP since the measurement is calibrated using an antenna of known gain (2.15dB) and known input power. ERP can be calculated from EIRP by subtracting the gain of the dipole, $\text{ERP} = \text{EIRP} - 2.15 \text{ (dB)}$.

Assumed the power of signal source record is -20dBm. A cable loss of -30dB, and an

antenna gain of 11dB are added.

$$P=P_{\text{mea}}+P_{\text{ca}}+G_a=(-20\text{dBm})+(-30\text{dB})+(11\text{dB})= -39\text{dBm}$$

The measurement will be done at carrier frequencies that pertain to bottom (Channel 9262), middle (Channel 9400) and top (Channel 9538) channels of WCDMA band II.

WCDMA band V

Test procedure:

The measurements procedures in TIA-603C-2004 are used.

The spectrum was scanned from 30MHz to the 10th harmonic of the highest frequency generated within the equipment.

Step 1:

The measurement is carried out in the fully anechoic chamber. EUT was placed on a 2.4 meter high non-conductive table at a 3 meter test distance from the test receive antenna. A receiving antenna was placed on the antenna mast 3 meters from the EUT. The height of receiving antenna is 2.4m and varies in certain range to find the maximum power value. A radio link shall be established between EUT and Tester. The output power of the cell signal of the tester will be decreased until the output power of the EUT reach a maximum value. The measurement is carried out using a spectrum analyzer or receiver. The spectrum analyzer scans from 30MHz to 20GHz (higher than the 10th harmonic of the carrier). The peak detector is used and RBW is set to 1MHz on spectrum analyzer. Then the antenna height and turn table rotation is adjusted till the maximum power value is founded on spectrum analyzer or receiver. A notch filter is necessary in the band near to the carrier frequency. A high pass filter is needed to avoid the distortion of the testing equipment in the band above the carrier frequency.

Step 2:

A log-periodic antenna or double-ridged waveguide horn antenna shall be substituted in place of the EUT. The log-periodic antenna will be driven by a signal generator and the level will be adjusted till the same power value on the spectrum analyzer or receiver. The level of the spurious emissions can be calculated through the level of the signal generator, cable loss, the gain of the substitution antenna and the reading of the spectrum analyzer or receiver.

A power (P_{mea}) is applied to the input of the substitution antenna, and adjusts the level of the signal generator output until the value of the receiver reach the previously recorded (P_r). The power of signal source (P_{mea}) is recorded. The test should be performed by rotating the test item and adjusting the receiving antenna polarization.

A "reference path loss" should be calculated after test. The attenuation of "reference path loss" is the cable loss between the Signal Source with the Substitution Antenna (P_{ca}) and the Substitution Antenna Gain (G_a).

Calculation procedure:

The data of cable loss and antenna gain has been calibrated in full testing frequency range before the testing.

The power of the Radiated Spurious Emissions is calculated by adding the cable loss and antenna gain. The basic equation with a sample calculation is as followed:

$$\text{Power(EIRP)} = P_{\text{mea}} + P_{\text{ca}} + G_a$$

This value is EIRP since the measurement is calibrated using an antenna of known gain (2.15dB) and known input power. ERP can be calculated from EIRP by subtracting the gain of the dipole, $\text{ERP} = \text{EIRP} - 2.15 \text{ (dB)}$.

Assumed the power of signal source record is -20dBm. A cable loss of -30dB, and an antenna gain of 11dB are added.

$$P = P_{\text{mea}} + P_{\text{ca}} + G_a = (-20\text{dBm}) + (-30\text{dB}) + (11\text{dB}) = -39\text{dBm}$$

The measurement will be done at carrier frequencies that pertain to bottom (Channel 4132), middle (Channel 4183) and top (Channel 4233) channels of WCDMA band V.

WCDMA band IV

Test procedure:

The measurements procedures in TIA-603C-2004 are used.

The spectrum was scanned from 30MHz to the 10th harmonic of the highest frequency generated within the equipment.

Step 1:

The measurement is carried out in the fully anechoic chamber. EUT was placed on a 2.4 meter high non-conductive table at a 3 meter test distance from the test receive antenna. A receiving antenna was placed on the antenna mast 3 meters from the EUT. The height of receiving antenna is 2.4m and varies in certain range to find the maximum power value. A radio link shall be established between EUT and Tester. The output power of the cell signal of the tester will be decreased until the output power of the EUT reach a maximum value. The measurement is carried out using a spectrum analyzer or receiver. The spectrum analyzer scans from 30MHz to 20GHz (higher than the 10th harmonic of the carrier). The peak detector is used and RBW is set to 1MHz on spectrum analyzer. Then the antenna height and turn table rotation is adjusted till the maximum power value is founded on spectrum analyzer or receiver. A notch filter is necessary in the band near to the carrier frequency. A high pass filter is needed to avoid the distortion of the testing equipment in the band above the carrier frequency.

Step 2:

A log-periodic antenna or double-ridged waveguide horn antenna shall be substituted in place of the EUT. The log-periodic antenna will be driven by a signal generator and the level will be adjusted till the same power value on the spectrum analyzer or receiver. The level of the spurious emissions can be calculated through the level of the signal generator, cable loss, the gain of the substitution antenna and the reading of the spectrum analyzer or receiver.

A power (P_{mea}) is applied to the input of the substitution antenna, and adjusts the level of the signal generator output until the value of the receiver reach the previously recorded (P_r). The power of signal source (P_{mea}) is recorded. The test should be performed by rotating the test item and adjusting the receiving antenna polarization.

A "reference path loss" should be calculated after test. The attenuation of "reference path loss" is the cable loss between the Signal Source with the Substitution Antenna (P_{ca}) and

the Substitution Antenna Gain (G_a).

Calculation procedure:

The data of cable loss and antenna gain has been calibrated in full testing frequency range before the testing.

The power of the Radiated Spurious Emissions is calculated by adding the cable loss and antenna gain. The basic equation with a sample calculation is as followed:

$$\text{Power(EIRP)} = P_{\text{mea}} + P_{\text{ca}} + G_a$$

This value is EIRP since the measurement is calibrated using an antenna of known gain (2.15dB) and known input power. ERP can be calculated from EIRP by subtracting the gain of the dipole, $\text{ERP} = \text{EIRP} - 2.15 \text{ (dB)}$.

Assumed the power of signal source record is -20dBm. A cable loss of -30dB, and an antenna gain of 11dB are added.

$$P = P_{\text{mea}} + P_{\text{ca}} + G_a = (-20\text{dBm}) + (-30\text{dB}) + (11\text{dB}) = -39\text{dBm}$$

The measurement will be done at carrier frequencies that pertain to bottom (Channel 1312), middle (Channel 1412) and top (Channel 1513) channels of WCDMA band IV.

Test result:

The test results are shown in Appendix B.

6.9 Peak-Average Ratio -FCC 24.232(d)/ 27.50(d)(5)

Ambient condition:

Temperature	Relative humidity	Pressure
25°C	30%	101.9kPa

Test Setup:

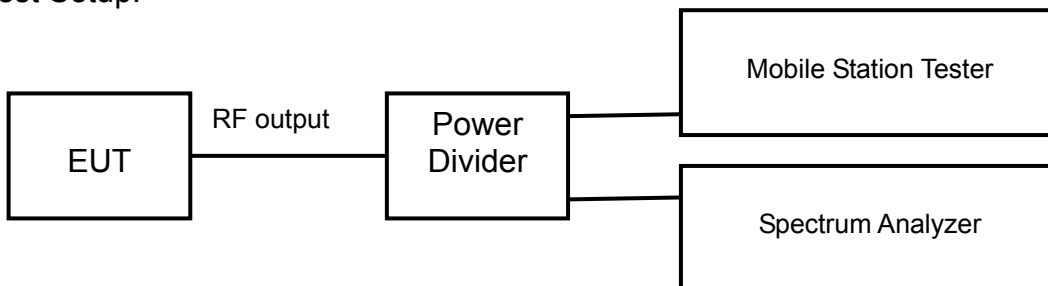

Test procedure:

After a radio link has been established between EUT and Tester, the output power of the cell signal of the testing equipment will be decreased until the output power of the EUT reach a maximum value. The Peak-Average Ratio is measured using spectrum analyzer. RBW is set to 30kHz on spectrum analyzer. The Peak-Average Ratio can be read on spectrum analyzer.

Limits: the peak-to-average ratio (PAR) of the transmission may not exceed 13 dB.

Test result:

The test results are shown in Appendix A

7 MEASUREMENT UNCERTAINTIES

Items	Uncertainty	
RF Power Output	U=0.6 dB	
Occupied Bandwidth	3kHz	
Spurious Emissions	9kHz~2GHz	U=1.2dB
	2G~3.6GHz	U=1.4dB
	3.6G~8GHz	U=2.2dB
	8G~12.75GHz	U=2.7dB
Band Edges Compliance	1.2dB	
Frequency Stability	U=48 Hz	

8 TEST EQUIPMENTS

No.	Name/Model	Manufacturer	S/N	Calibration Date	Calibration Due Date
1	E5515C(8960) Mobile Station Tester	Agilent	MY50266302	2018.08.20	2019.08.19
2	N9020A Spectrum Analyzer	Agilent	MY48010771	2018.08.20	2019.08.19
3	6007 Power Divider	Weinschel	6007-GJ-1	2018.08.20	2019.08.19
4	DC Power Supply E3645A	Agilent	MY40000741	2019.03.01	2020.02.28
5	Temperature chamber SH241	ESPEC	92013758	2018.08.20	2019.08.19
6	12.65m×8.03m×7.50m Fully-Anechoic Chamber	FRANKONIA	-----	-----	-----
7	23.18m×16.88m×9.60m Semi-Anechoic Chamber	FRANKONIA	---	-----	-----
8	Turn table Diameter:1m	FRANKONIA	-----	-----	-----
9	Turn table Diameter:5m	FRANKONIA	-----	-----	-----
10	Antenna master FAC(MA4.0)	MATURO	-----	-----	-----
11	Antenna master SAC(MA4.0)	MATURO	-----	-----	-----
12	9.080m×5.255m×3.525m Shielding room	FRANKONIA	-----	-----	-----
13	HF 907 Double-Ridged Waveguide Horn Antenna	R&S	100512	2018.08.20	2019.08.19
14	HF 907 Double-Ridged Waveguide Horn Antenna	R&S	100513	2018.08.20	2019.08.19
15	HL562 Ultra log antenna	R&S	100016	2018.08.20	2019.08.19
16	3160-09 Receive antenna	SCHWARZ-BECK	002058-002	2018.08.20	2019.08.19
17	ESI 40 EMI test receiver	R&S	100015	2018.08.20	2019.08.19
18	ESCS30 EMI test receiver	R&S	100029	2018.08.20	2019.08.19
19	HL562 Receive antenna	R&S	100167	2018.08.20	2019.08.19
20	ENV216 AMN	R&S	3560.6550.12	2018.08.20	2019.08.19

APPENDIX A – TEST DATA OF CONDUCTED EMISSION

Please refer to the attachment.

APPENDIX B – TEST DATA OF RADIATED EMISSION

Please refer to the attachment.

APPENDIX A – TEST DATA OF CONDUCTED EMISSION

RF Power Output-FCC Part 22.913(a)/Part24.232 (b)

WCDMA band II

Antenna Gain=1.42dBi

Mode		Carrier frequency (MHz)	Channel No.	RF Power Output (dBm)	EIRP (W)
Release 99	RMC,12.2kbps	1852.4	9262	23.78	0.331
		1880.0	9400	23.79	0.332
		1907.6	9538	23.80	0.333
HSDPA	Subtest 1	1852.4	9262	23.00	0.277
		1880.0	9400	22.92	0.272
		1907.6	9538	22.91	0.271
	Subtest 2	1852.4	9262	22.90	0.270
		1880.0	9400	22.89	0.270
		1907.6	9538	22.91	0.271
	Subtest 3	1852.4	9262	22.92	0.272
		1880.0	9400	22.88	0.269
		1907.6	9538	22.89	0.270
	Subtest 4	1852.4	9262	22.90	0.270
		1880.0	9400	22.88	0.269
		1907.6	9538	22.91	0.271
HSUPA	Subtest 1	1852.4	9262	22.89	0.270
		1880.0	9400	22.88	0.269
		1907.6	9538	22.89	0.270
	Subtest 2	1852.4	9262	22.87	0.269
		1880.0	9400	22.90	0.270
		1907.6	9538	22.91	0.271
	Subtest 3	1852.4	9262	22.88	0.269
		1880.0	9400	22.87	0.269
		1907.6	9538	22.89	0.270
	Subtest 4	1852.4	9262	22.90	0.270
		1880.0	9400	22.90	0.270
		1907.6	9538	22.90	0.270
	Subtest 5	1852.4	9262	22.91	0.271
		1880.0	9400	22.89	0.270
		1907.6	9538	22.88	0.269
HSPA+	Subtest 1	1852.4	9262	22.88	0.269
		1880.0	9400	22.87	0.269
		1907.6	9538	22.90	0.270

WCDMA band V
Antenna Gain=-3.42dBi

Mode		Carrier frequency (MHz)	Channel No.	RF Power Output (dBm)	ERP (W)
Release 99	RMC,12.2kbps	826.4	4132	23.62	0.064
		836.6	4183	23.57	0.063
		846.6	4233	23.55	0.063
HSDPA	Subtest 1	826.4	4132	23.29	0.059
		836.6	4183	23.24	0.058
		846.6	4233	23.23	0.058
	Subtest 2	826.4	4132	23.22	0.058
		836.6	4183	23.22	0.058
		846.6	4233	23.19	0.058
	Subtest 3	826.4	4132	23.19	0.058
		836.6	4183	23.21	0.058
		846.6	4233	23.22	0.058
	Subtest 4	826.4	4132	23.18	0.058
		836.6	4183	23.20	0.058
		846.6	4233	23.22	0.058
HSUPA	Subtest 1	826.4	4132	23.21	0.058
		836.6	4183	23.19	0.058
		846.6	4233	23.21	0.058
	Subtest 2	826.4	4132	23.23	0.058
		836.6	4183	23.19	0.058
		846.6	4233	23.18	0.058
	Subtest 3	826.4	4132	23.21	0.058
		836.6	4183	23.20	0.058
		846.6	4233	23.19	0.058
	Subtest 4	826.4	4132	23.23	0.058
		836.6	4183	23.20	0.058
		846.6	4233	23.21	0.058
	Subtest 5	826.4	4132	23.19	0.058
		836.6	4183	23.18	0.058
		846.6	4233	23.22	0.058
HSPA+	Subtest 1	826.4	4132	23.18	0.058
		836.6	4183	23.19	0.058
		846.6	4233	23.20	0.058

WCDMA band IV

Antenna Gain=-0.11dBi

Mode		Carrier frequency (MHz)	Channel No.	RF Power Output (dBm)	EIRP (W)
Release 99	RMC,12.2kbps	1712.4	1312	23.79	0.233
		1732.4	1412	23.77	0.232
		1752.6	1513	23.78	0.233
HSDPA	Subtest 1	1712.4	1312	22.90	0.190
		1732.4	1412	22.73	0.183
		1752.6	1513	22.72	0.182
	Subtest 2	1712.4	1312	22.85	0.188
		1732.4	1412	22.70	0.182
		1752.6	1513	22.71	0.182
	Subtest 3	1712.4	1312	22.84	0.187
		1732.4	1412	22.71	0.182
		1752.6	1513	22.70	0.182
	Subtest 4	1712.4	1312	22.83	0.187
		1732.4	1412	22.70	0.182
		1752.6	1513	22.70	0.182
HSUPA	Subtest 1	1712.4	1312	22.83	0.187
		1732.4	1412	22.71	0.182
		1752.6	1513	22.73	0.183
	Subtest 2	1712.4	1312	22.80	0.186
		1732.4	1412	22.72	0.182
		1752.6	1513	22.70	0.182
	Subtest 3	1712.4	1312	22.85	0.188
		1732.4	1412	22.72	0.182
		1752.6	1513	22.70	0.182
	Subtest 4	1712.4	1312	22.81	0.186
		1732.4	1412	22.70	0.182
		1752.6	1513	22.70	0.182
	Subtest 5	1712.4	1312	22.84	0.187
		1732.4	1412	22.72	0.182
		1752.6	1513	22.70	0.182
HSPA+	Subtest 1	1712.4	1312	22.88	0.189
		1732.4	1412	22.71	0.182
		1752.6	1513	22.70	0.182

Occupied Bandwidth-FCC 2.1049/ 27.53(h)(1)

WCDMA band II

REL99 Mode:

Carrier frequency (MHz)	Channel No.	Bandwidth of 99% Power (MHz)
1852.4	9262	4.1533
1880.0	9400	4.1562
1907.6	9538	4.1484

HSDPA Mode:

Carrier frequency (MHz)	Channel No.	Bandwidth of 99% Power (MHz)
1852.4	9262	4.1694
1880.0	9400	4.1572
1907.6	9538	4.1525

WCDMA band V

REL99 Mode:

Carrier frequency (MHz)	Channel No.	Bandwidth of 99% Power (MHz)
826.4	4132	4.1487
836.6	4183	4.1490
846.6	4233	4.1401

HSDPA Mode:

Carrier frequency (MHz)	Channel No.	Bandwidth of 99% Power (MHz)
826.4	4132	4.1368
836.6	4183	4.1321
846.6	4233	4.1580

WCDMA band IV

REL99 Mode:

Carrier frequency (MHz)	Channel No.	Bandwidth of 99% Power (MHz)
1712.4	1312	4.1526
1732.4	1412	4.1623
1752.6	1513	4.1605

HSDPA Mode:

Carrier frequency (MHz)	Channel No.	Bandwidth of 99% Power (MHz)
1712.4	1312	4.1457
1732.4	1412	4.1589
1752.6	1513	4.1540

Emission Bandwidth-FCC 22.917(b)/24.238(b)

WCDMA band II

REL99 Mode:

Carrier frequency (MHz)	Channel No.	Bandwidth of -26dBc Power (MHz)
1852.4	9262	4.656
1880.0	9400	4.639
1907.6	9538	4.614

HSDPA Mode:

Carrier frequency (MHz)	Channel No.	Bandwidth of -26dBc Power (MHz)
1852.4	9262	4.686
1880.0	9400	4.654
1907.6	9538	4.674

WCDMA band V

REL99 Mode:

Carrier frequency (MHz)	Channel No.	Bandwidth of -26dBc Power (MHz)
826.4	4132	4.635
836.6	4183	4.668
846.6	4233	4.641

HSDPA:

Carrier frequency (MHz)	Channel No.	Bandwidth of -26dBc Power (MHz)
826.4	4132	4.660
836.6	4183	4.608
846.6	4233	4.639

WCDMA band IV

REL99 Mode:

Carrier frequency (MHz)	Channel No.	Bandwidth of -26dBc Power (MHz)
1712.4	1312	4.656
1732.4	1412	4.649
1752.6	1513	4.647

HSDPA Mode:

Carrier frequency (MHz)	Channel No.	Bandwidth of -26dBc Power (MHz)
1712.4	1312	4.655
1732.4	1412	4.658
1752.6	1513	4.658

WCDMA band II

REL99 Mode:

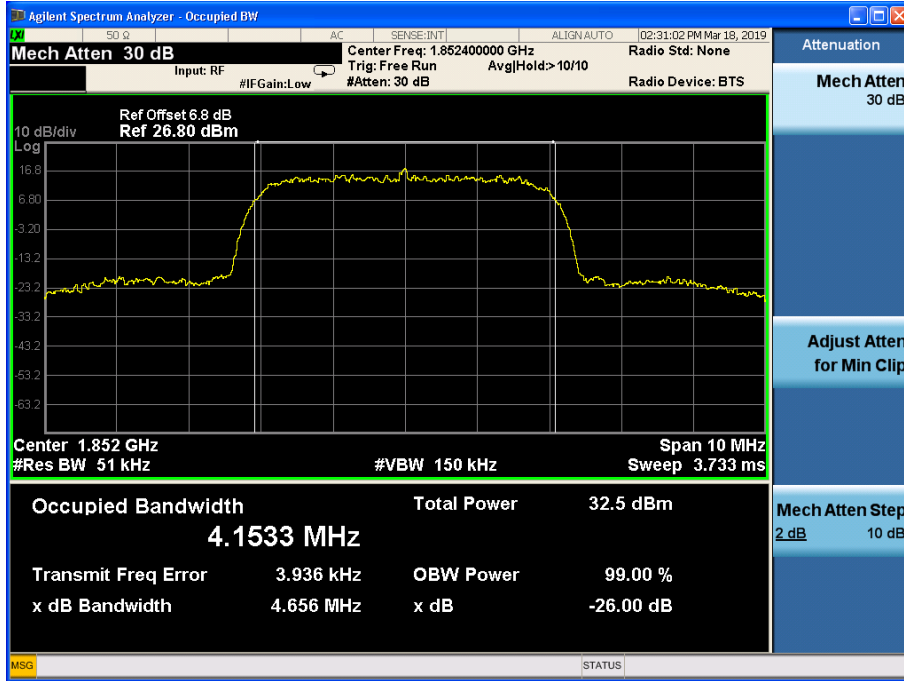

Channel 9262

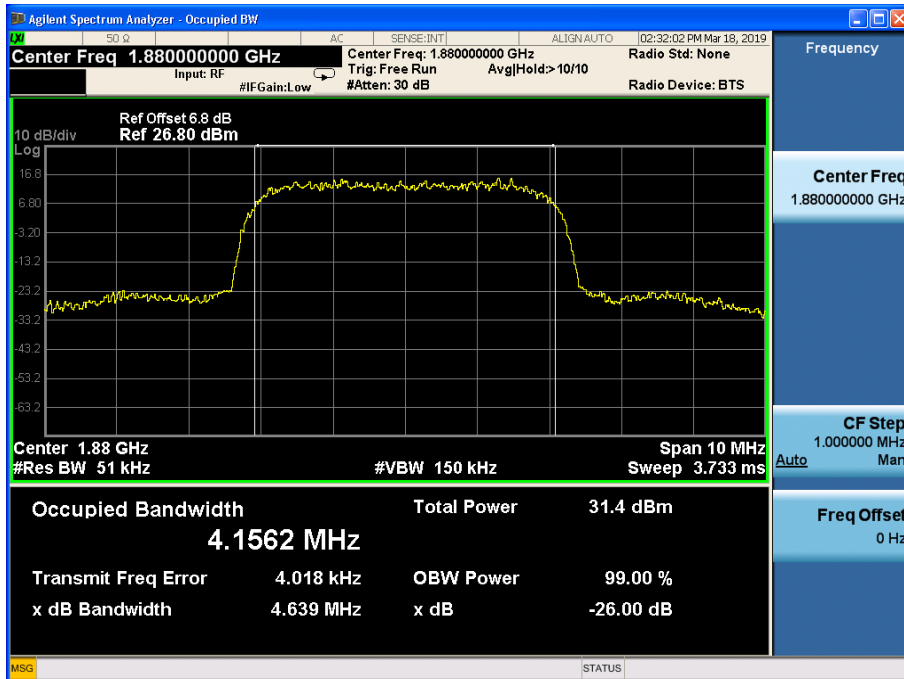

Channel 9400

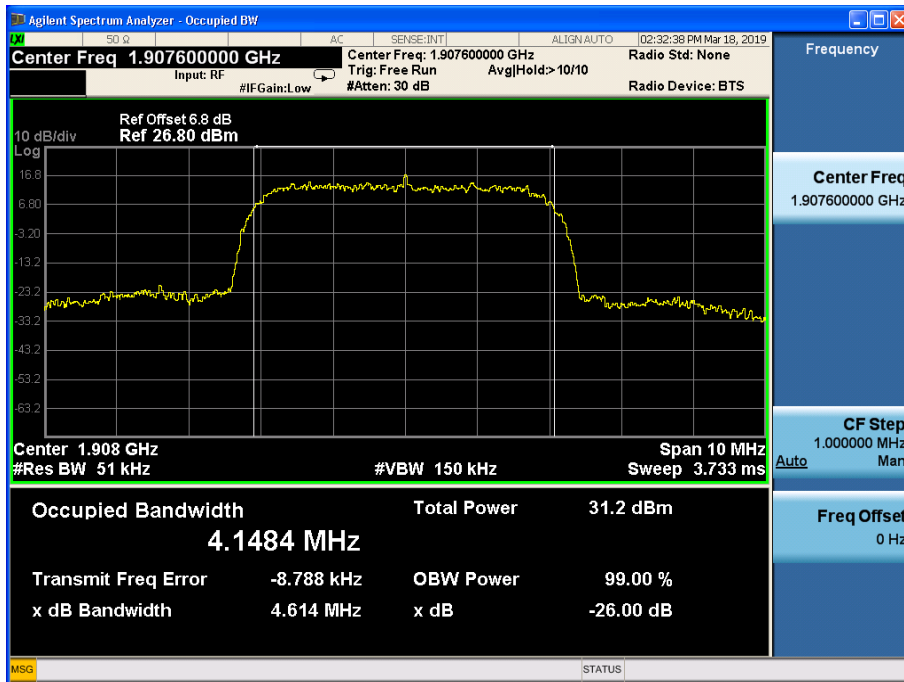

Channel 9538

HSDPA Mode:

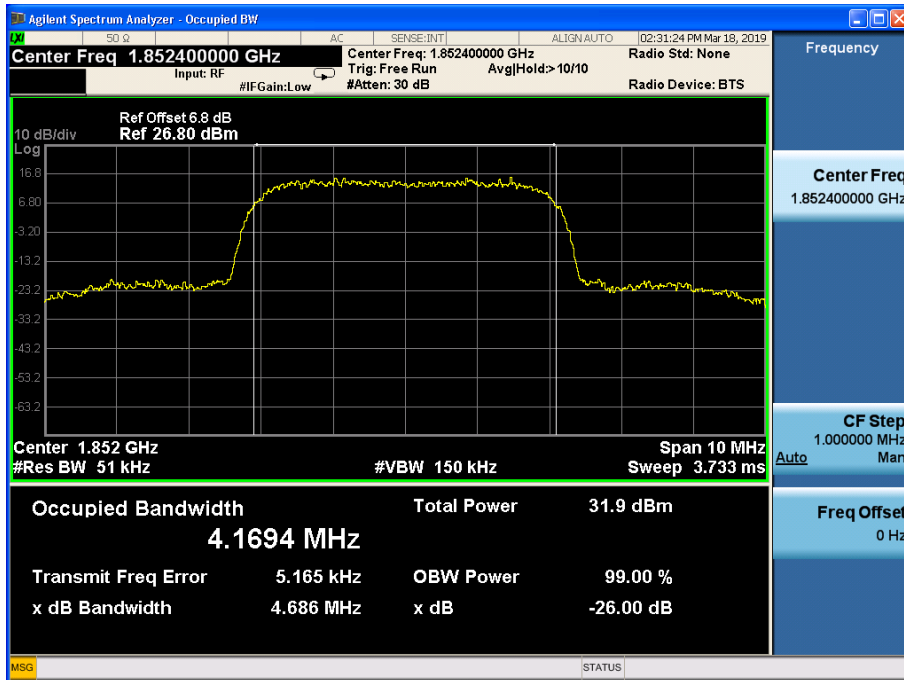

Channel 9262

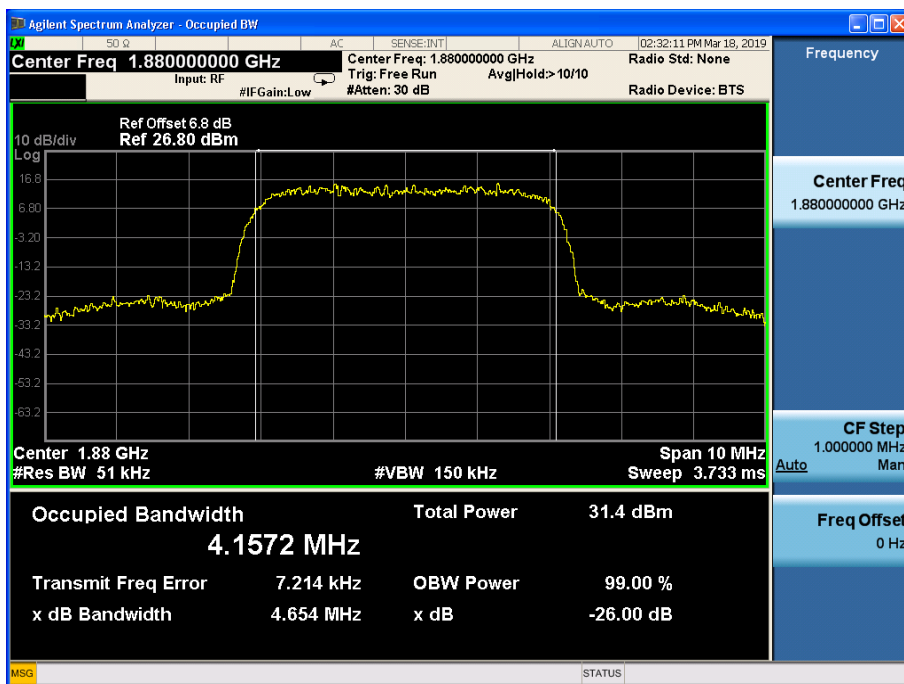

Channel 9400

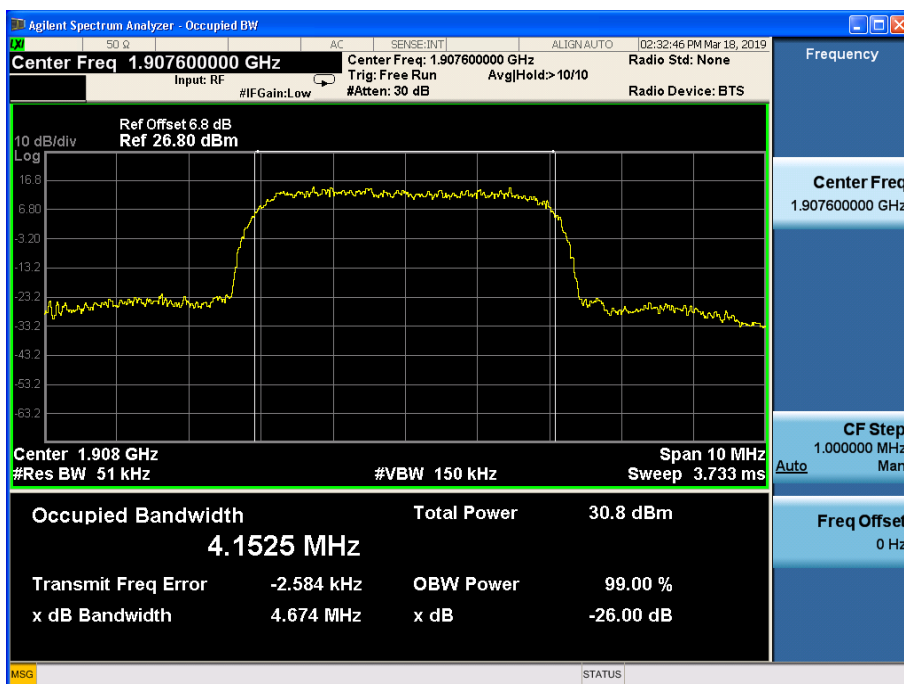

Channel 9538

WCDMA band V

REL99 Mode:

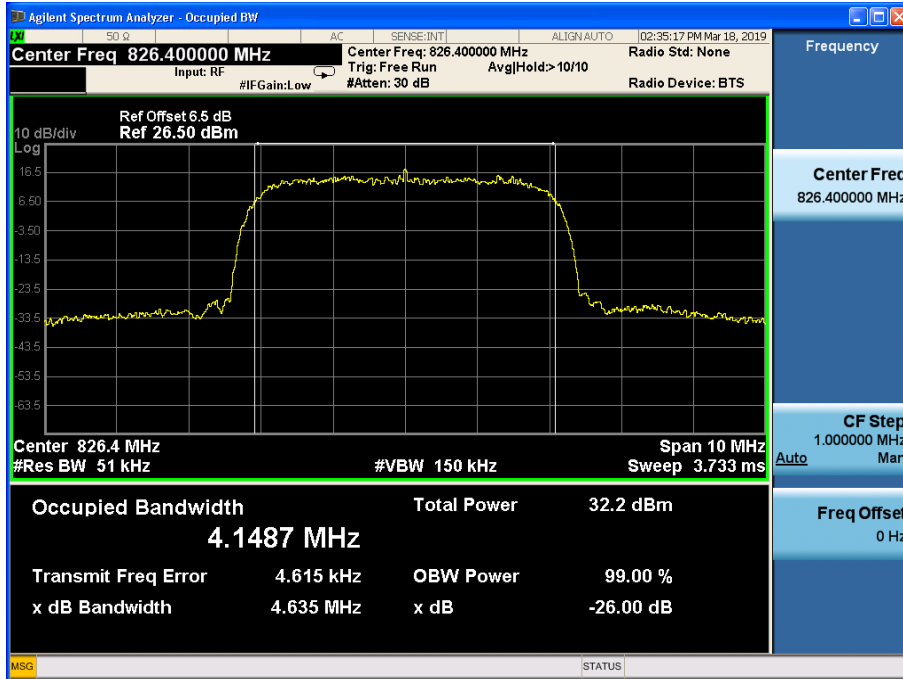

Channel 4132

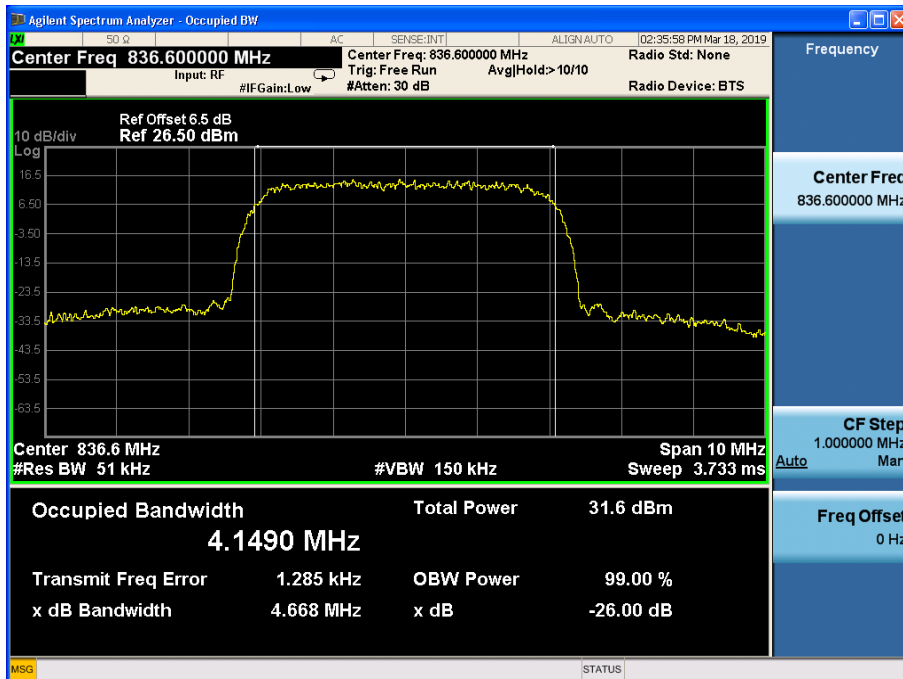

Channel 4183

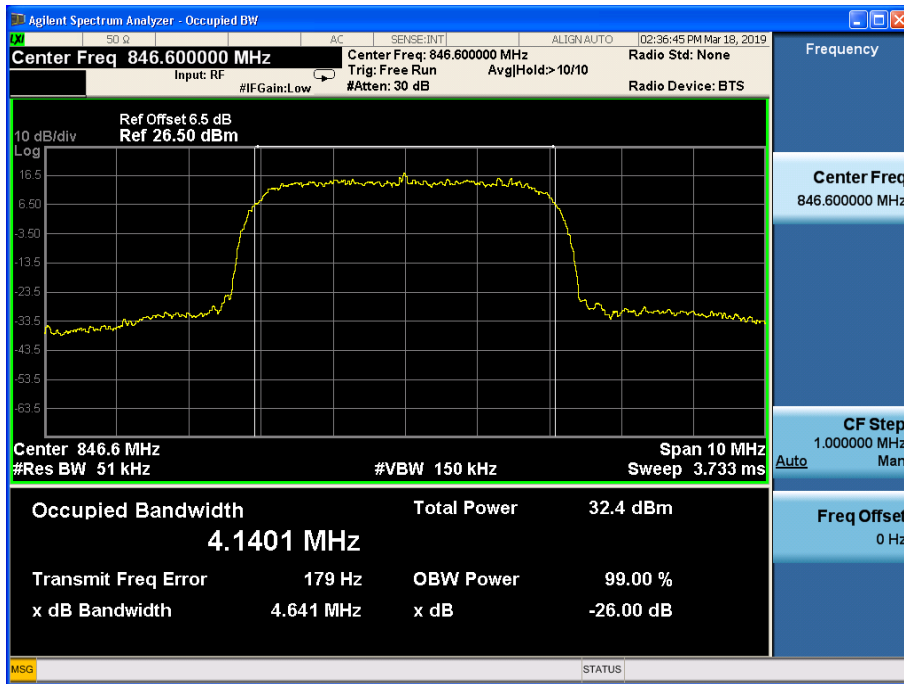

Channel 4233

HSDPA:

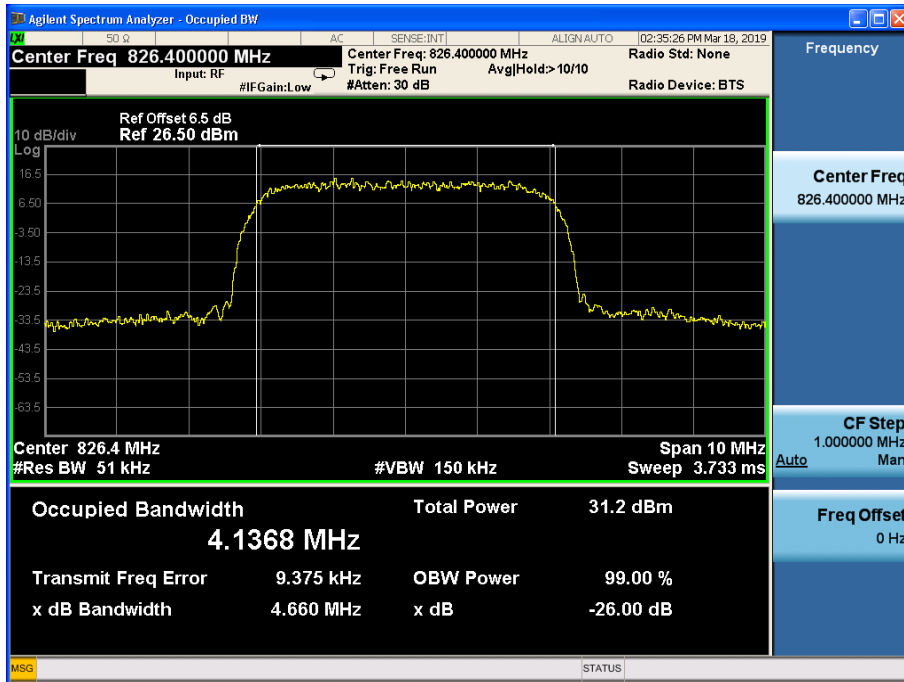

Channel 4132

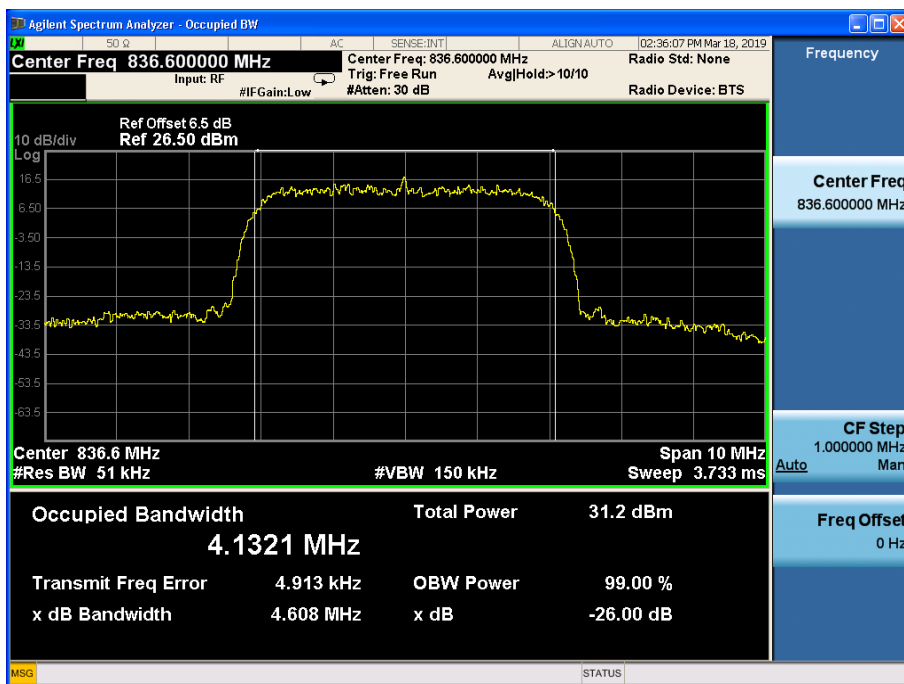

Channel 4183

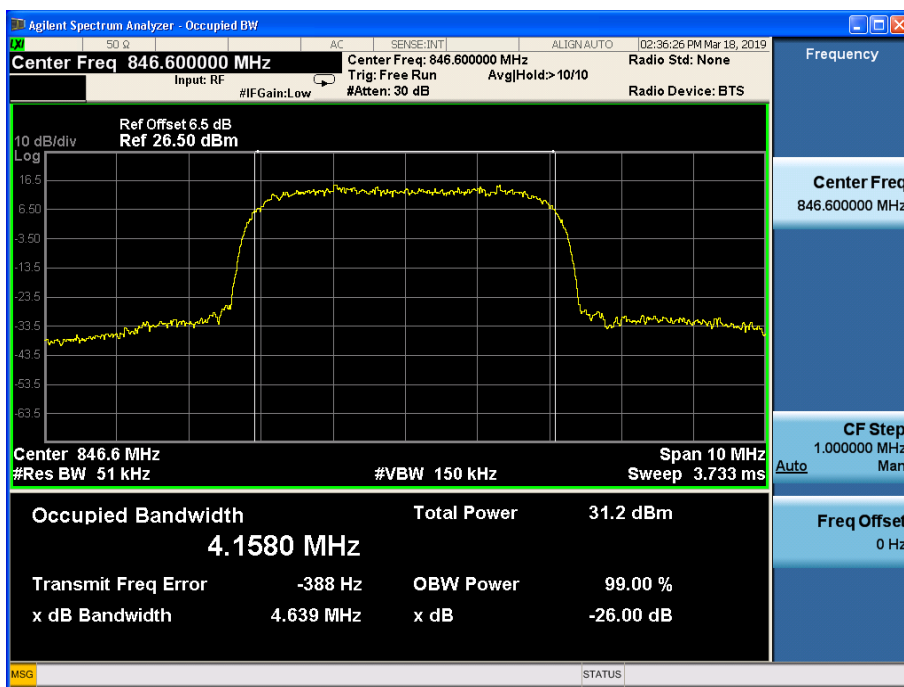

Channel 4233

WCDMA band IV

REL99 Mode:

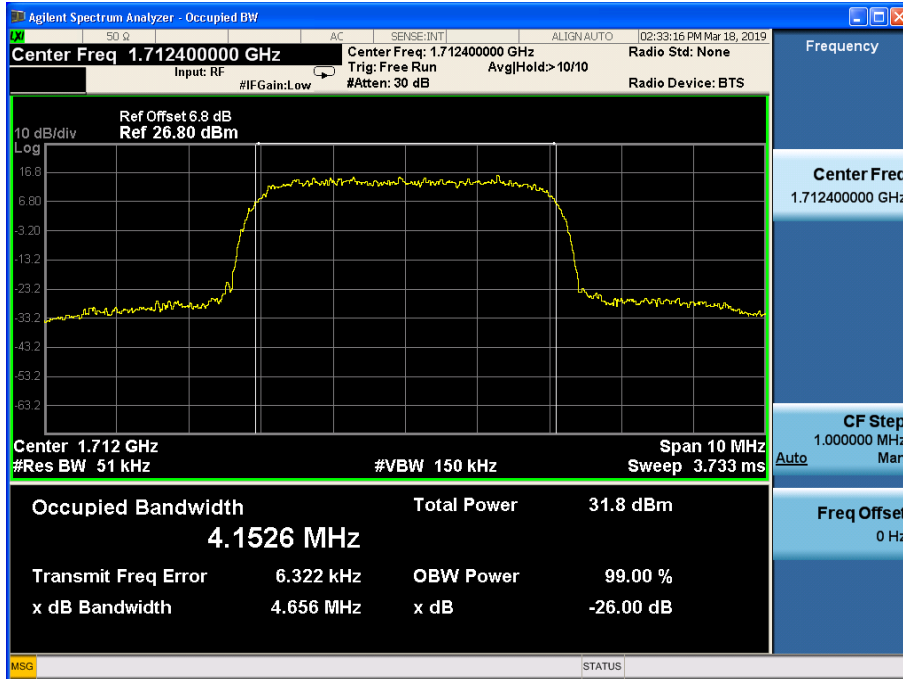

Channel 1312

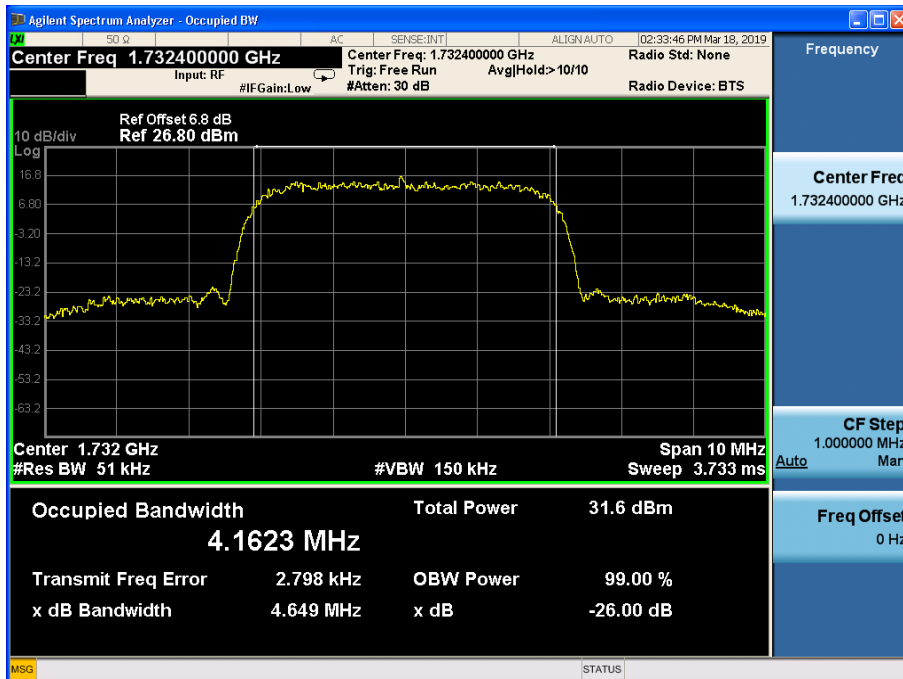

Channel 1412

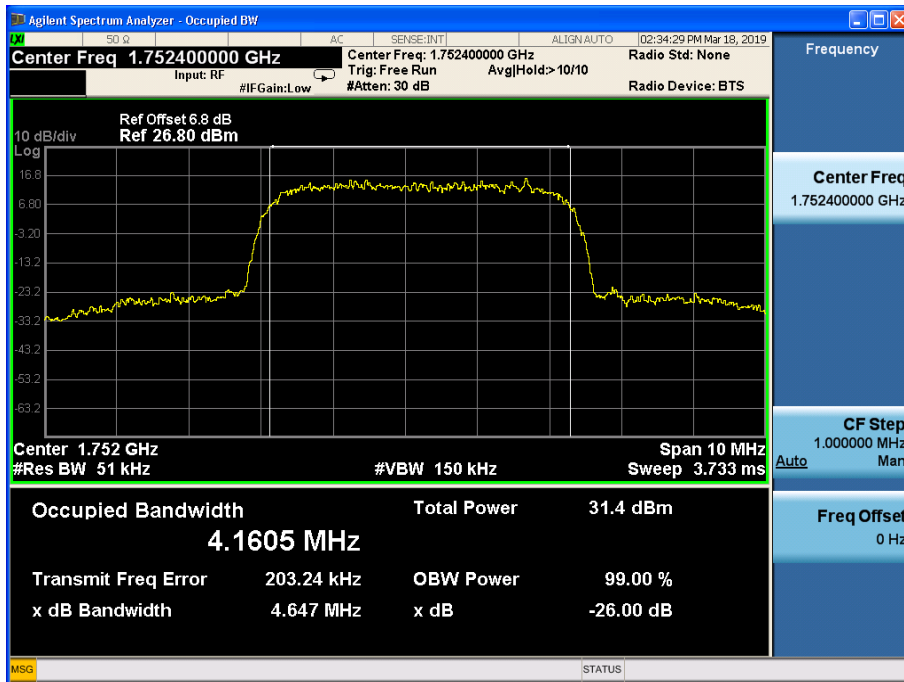

Channel 1513

HSDPA Mode:

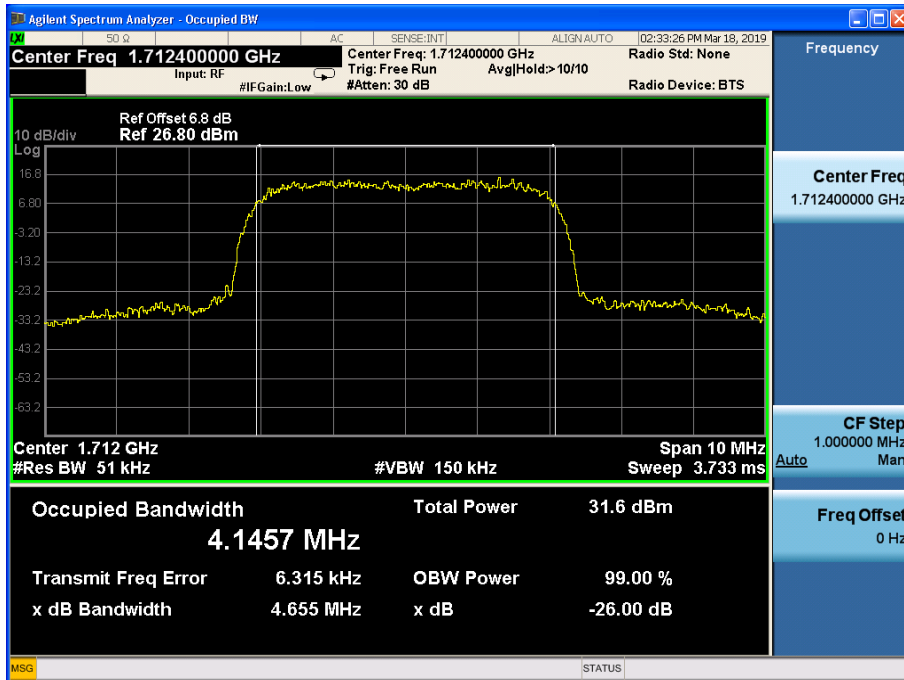

Channel 1312

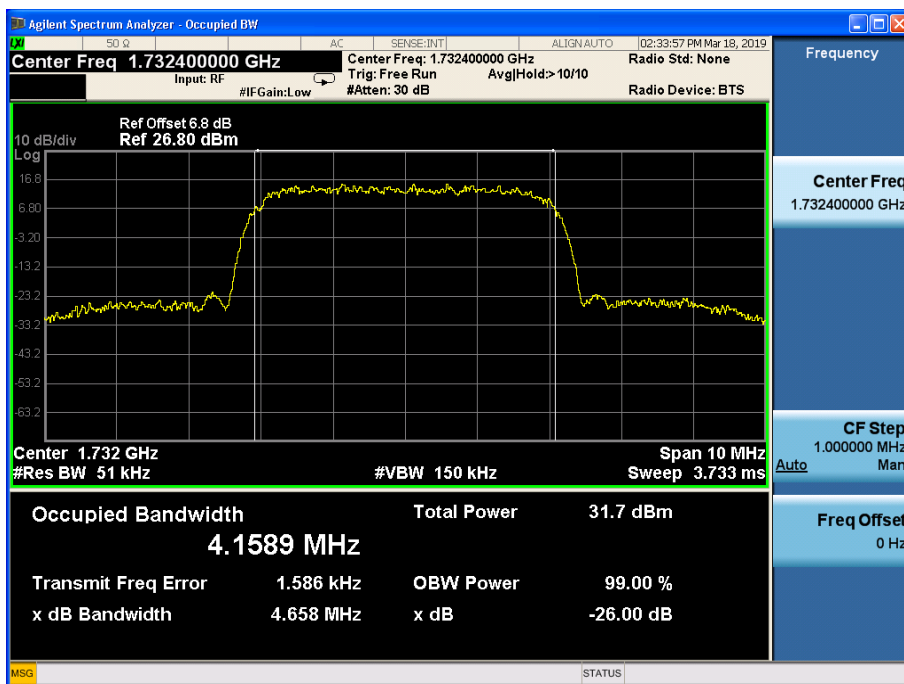

Channel 1412

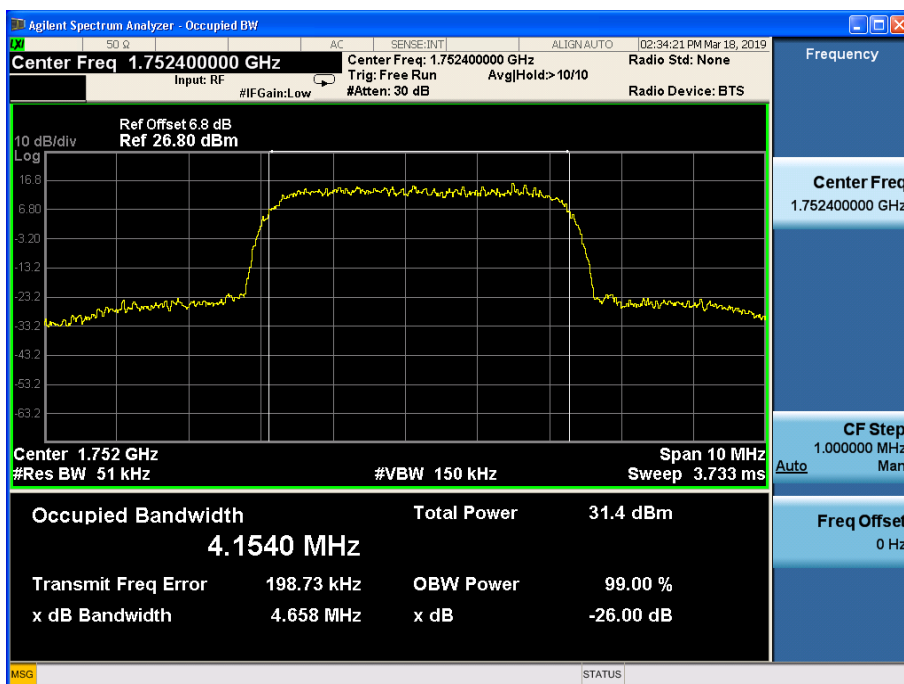

Channel 1513

Spurious Emissions at antenna terminal-FCC Part2.1051/ 22.917(a)/24.238(a)/ 27.53(h)
WCDMA band II

REL99 Mode:

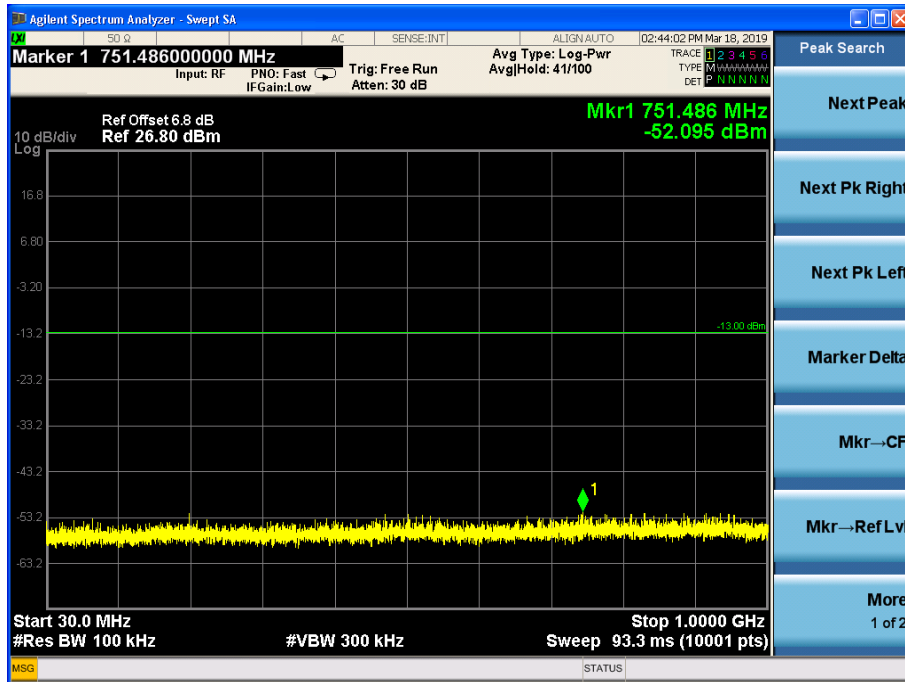

Channel 9400, 30MHz~1GHz

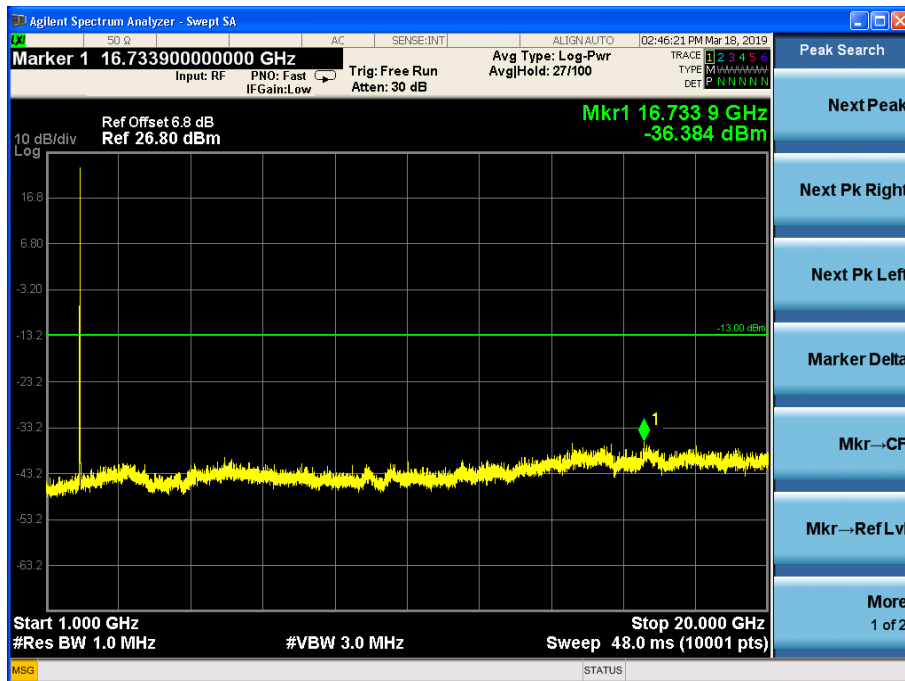

Channel 9400, 1GHz~20GHz

Note: The signal beyond the limit is the signal transmitted by EUT.

HSDPA Mode:

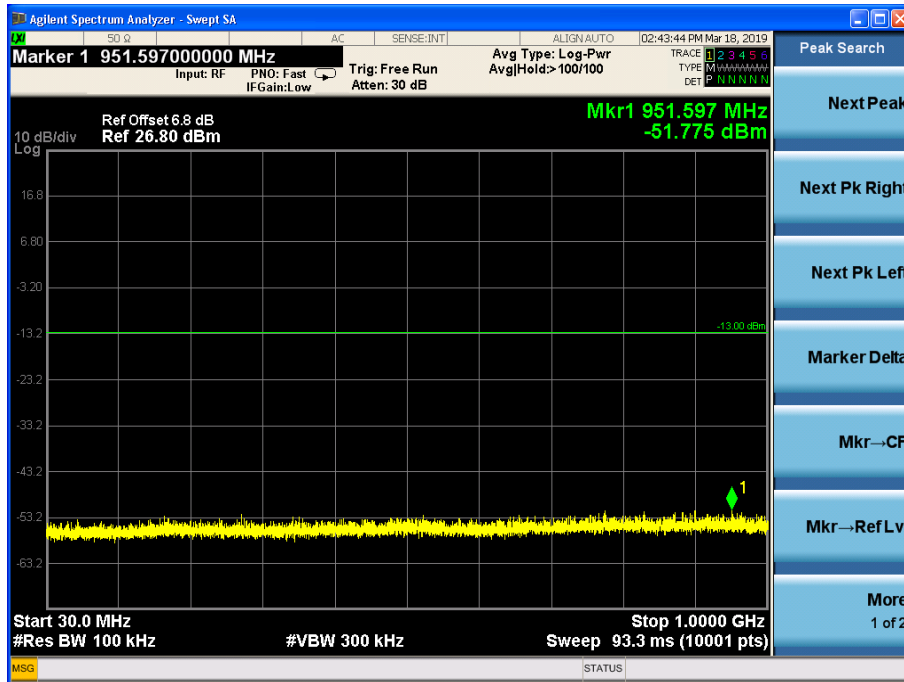

Channel 9400, 30MHz~1GHz

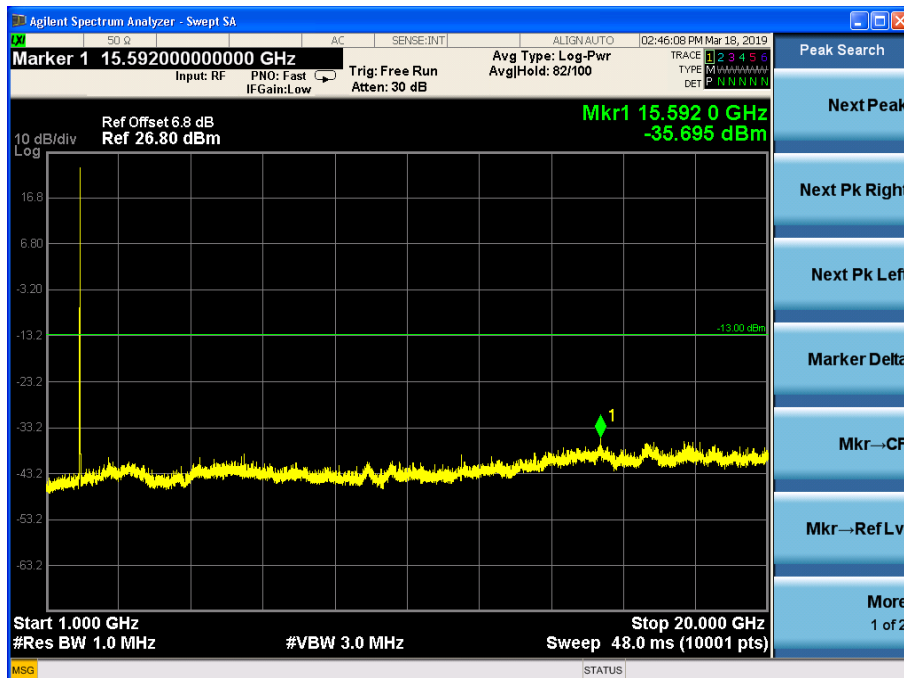

Channel 9400, 1GHz~20GHz

Note: The signal beyond the limit is the signal transmitted by EUT.

WCDMA band V

REL99 Mode:

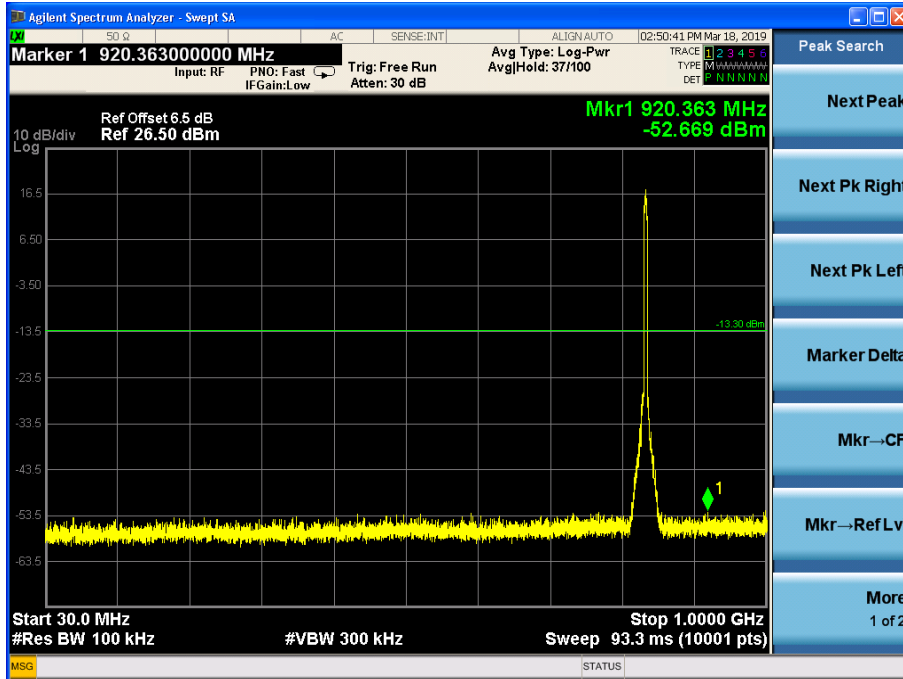

Channel 4183, 30MHz~1GHz

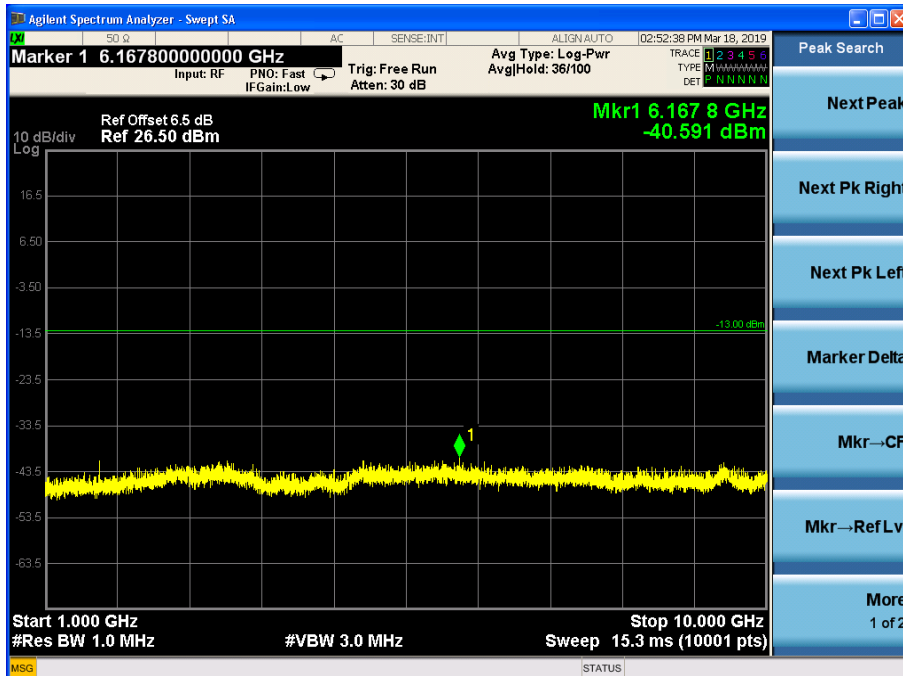

Channel 4183, 1GHz~10GHz

Note: The signal beyond the limit is the signal transmitted by EUT.

HSDPA Mode:

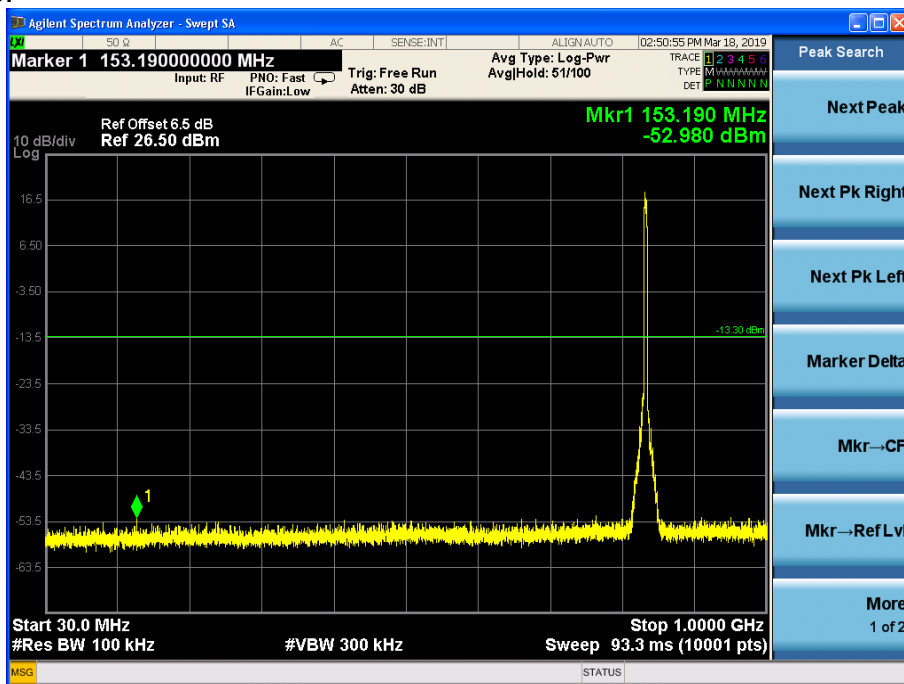

Channel 4183, 30MHz~1GHz

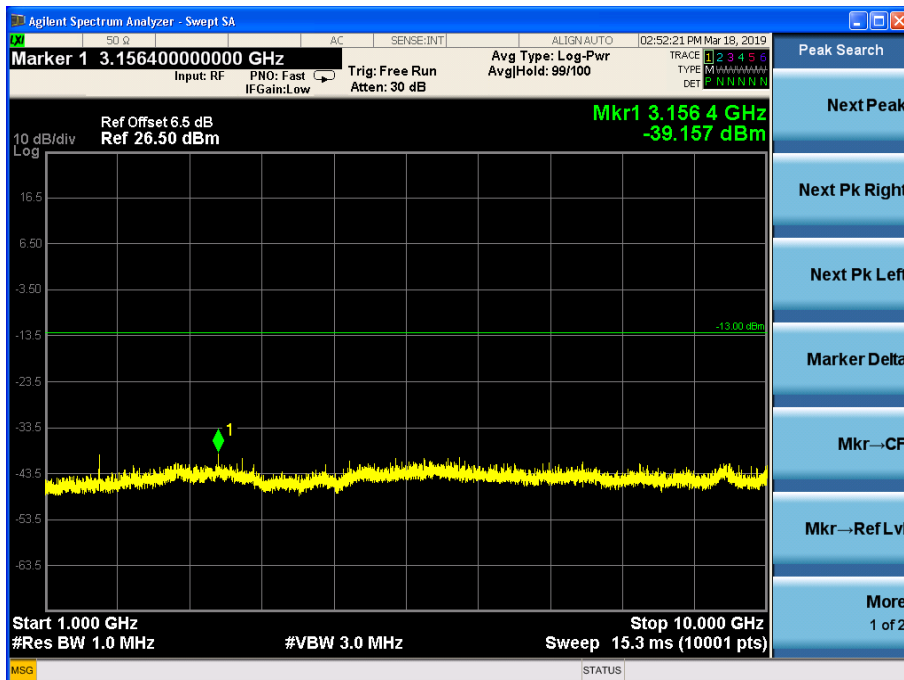

Channel 4183, 1GHz~10GHz

Note: The signal beyond the limit is the signal transmitted by EUT.

WCDMA band IV
REL99 Mode:

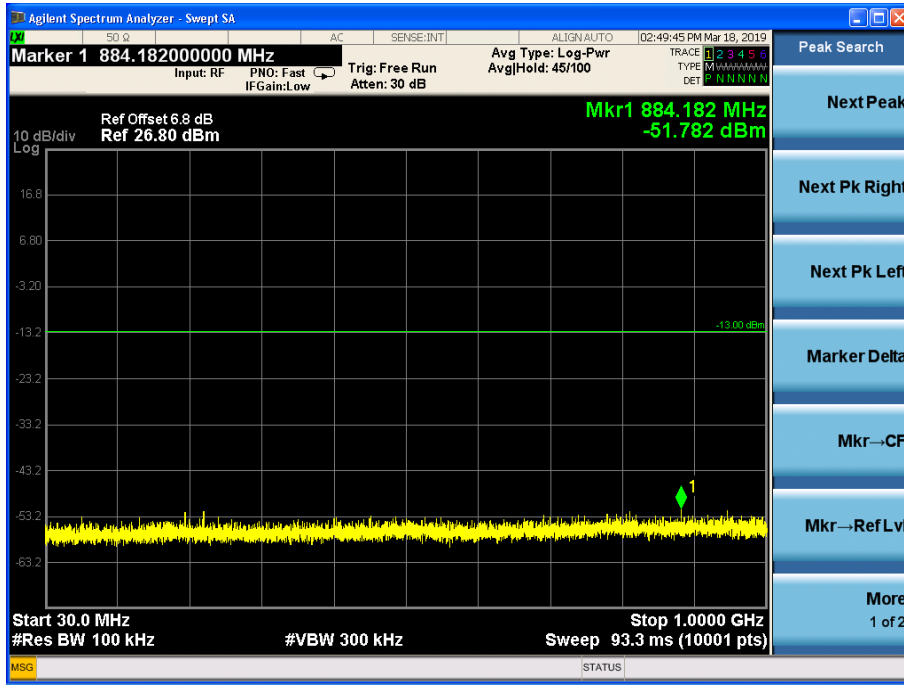

Channel 1412, 30MHz~1GHz

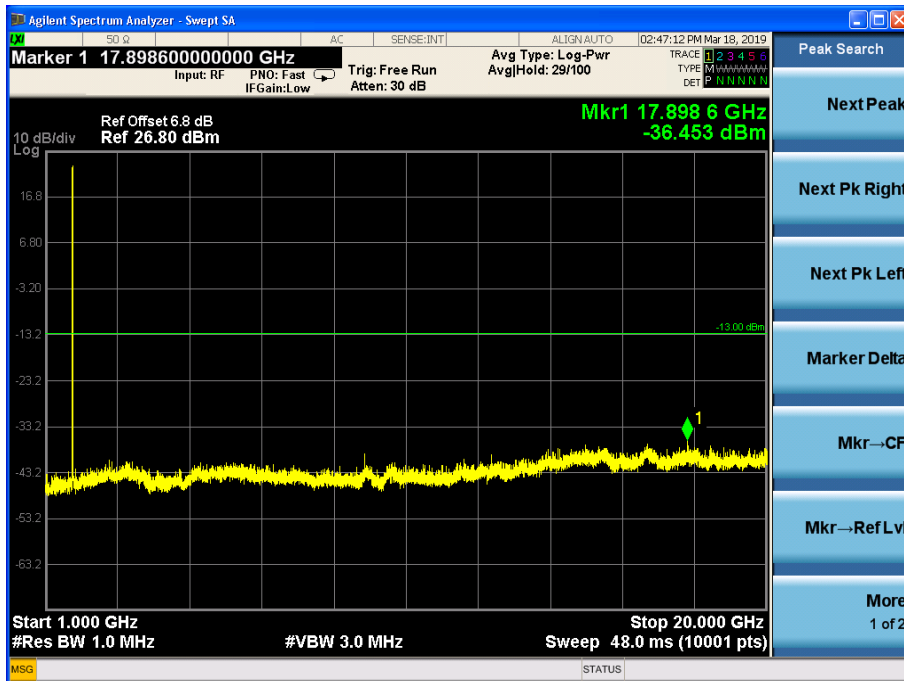

Channel 1412, 1GHz~20GHz

Note: The signal beyond the limit is the signal transmitted by EUT.

HSDPA Mode:

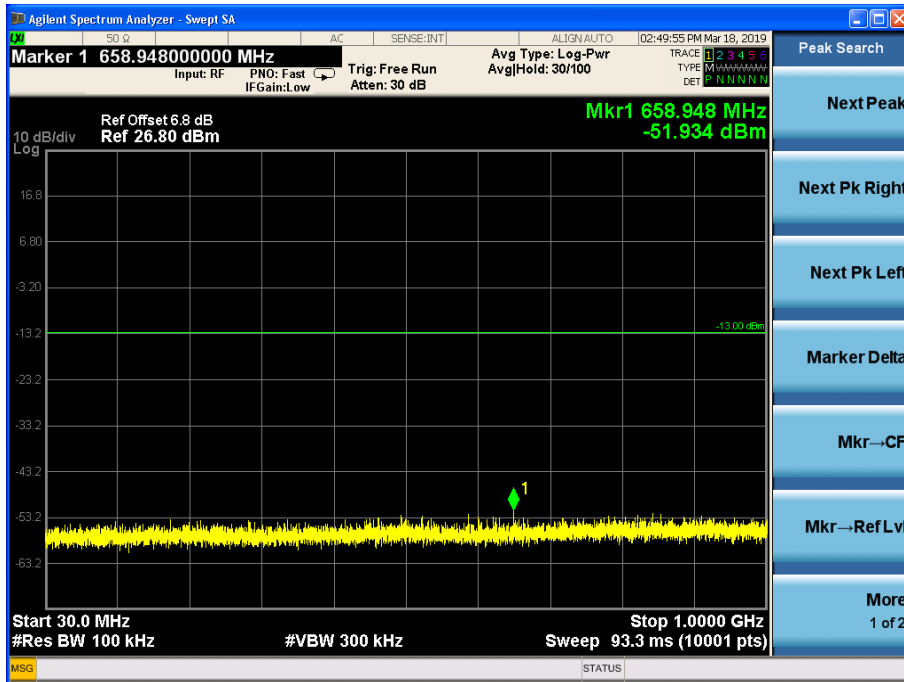

Channel 1412, 30MHz~1GHz

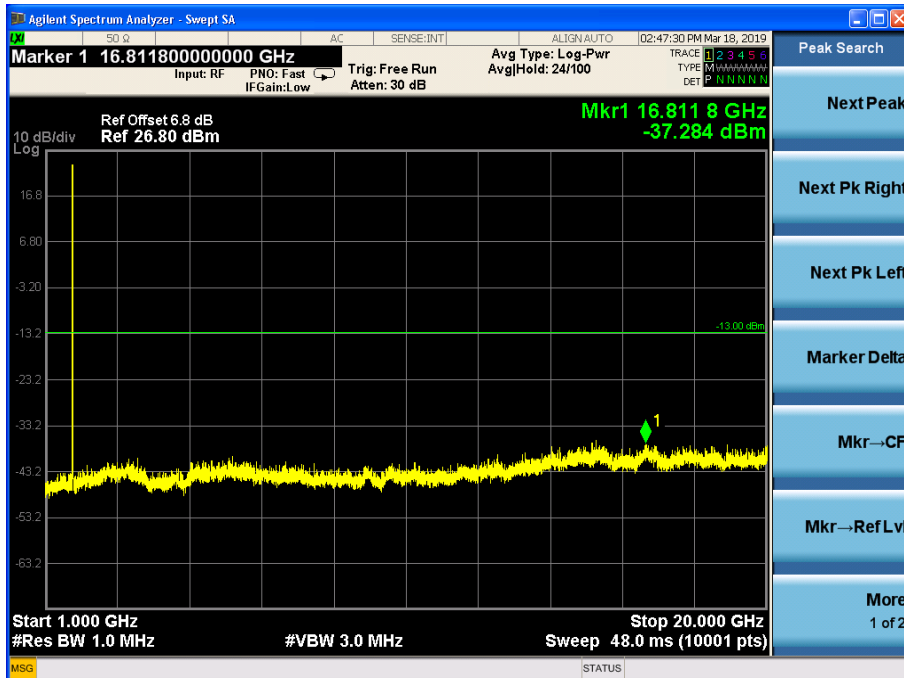

Channel 1412, 1GHz~20GHz

Note: The signal beyond the limit is the signal transmitted by EUT.

Band Edges Compliance-FCC 22.917(b)/24.238(b)/ 27.53(h)

WCDMA band II

REL99 Mode:

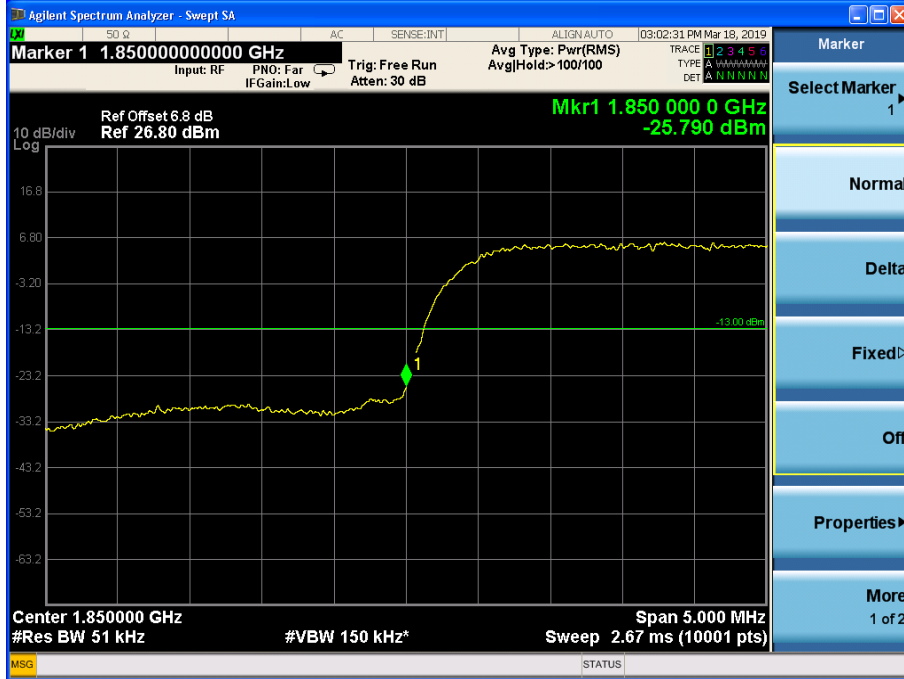

Channel 9262

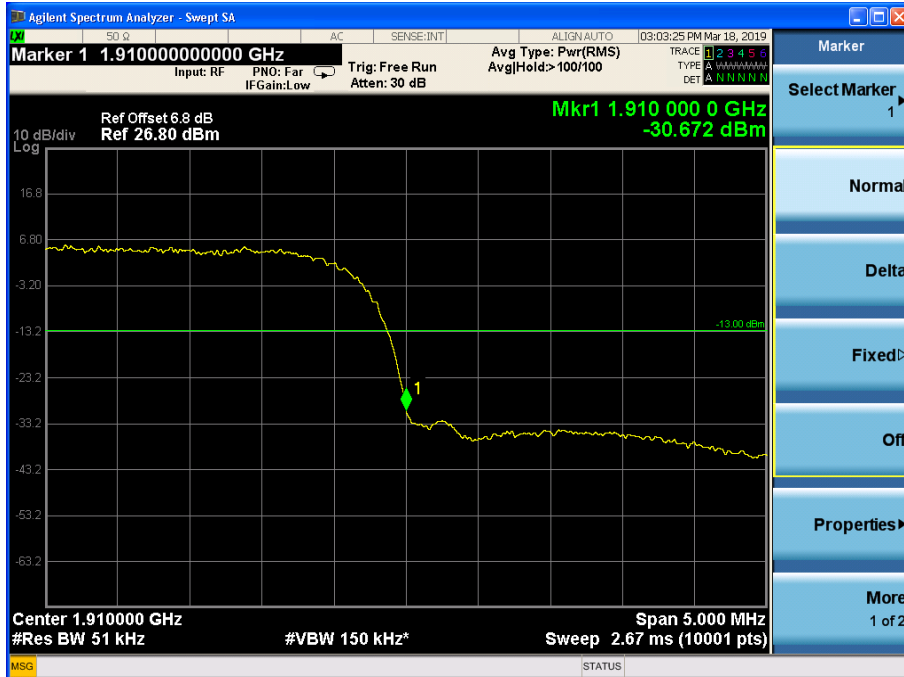

Channel 9538

HSDPA Mode:

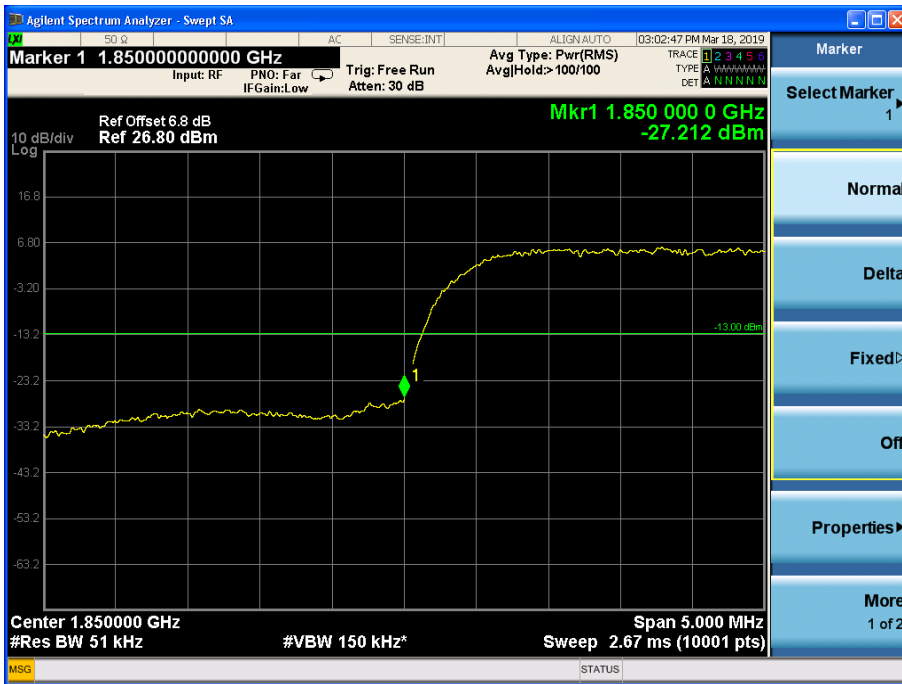

Channel 9262



Channel 9538

WCDMA band V

REL99 Mode:

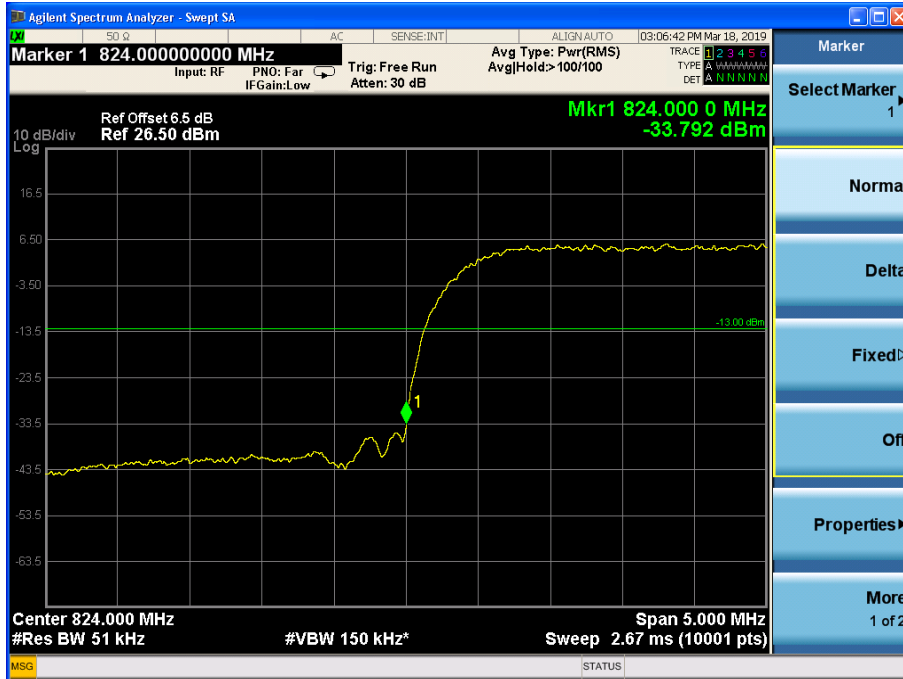

Channel 4132



Channel 4233

HSDPA Mode:

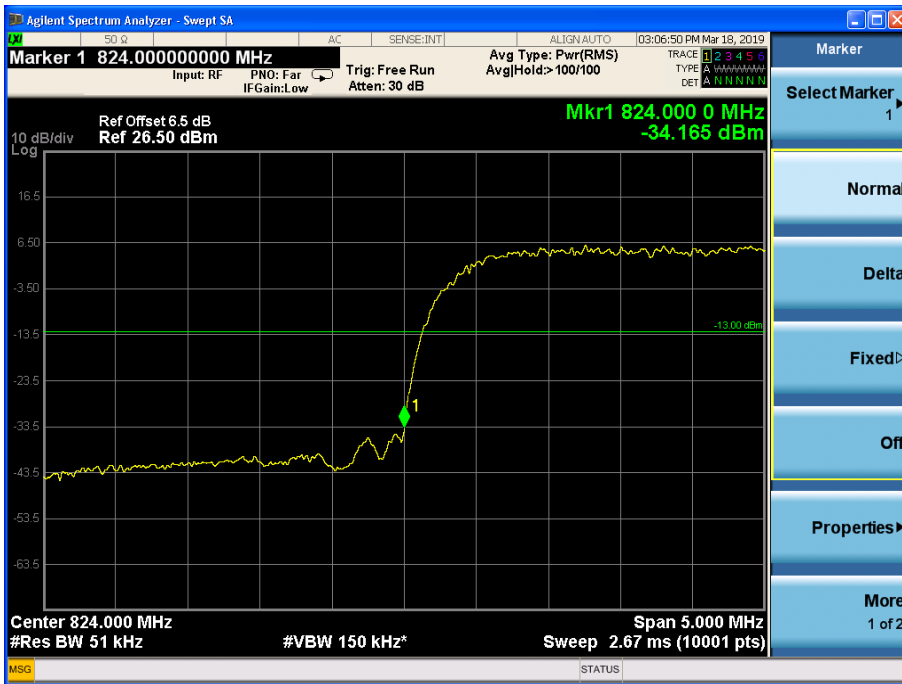

Channel 4132

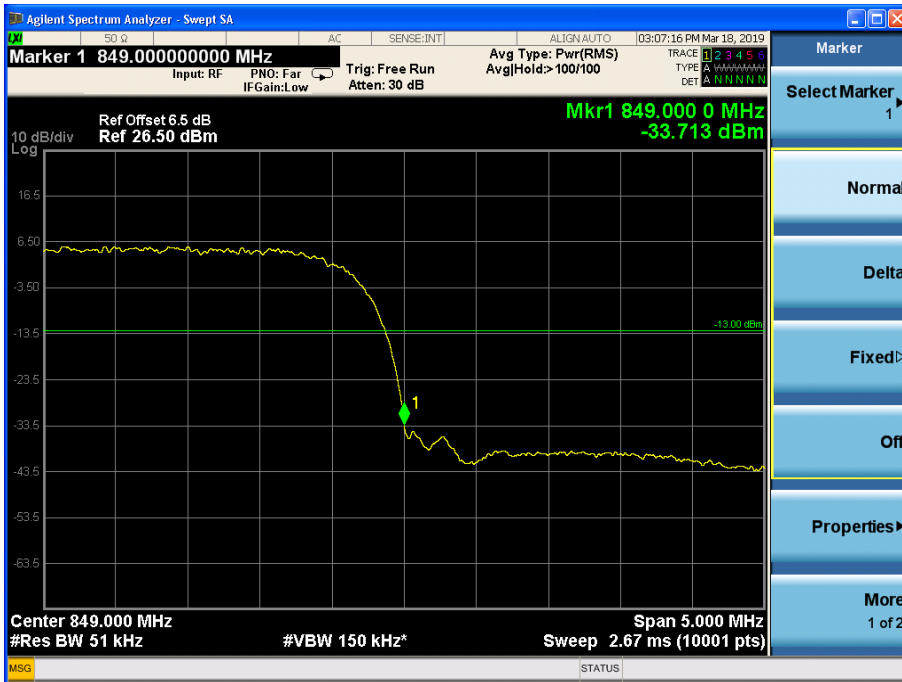

Channel 4233

WCDMA band IV

REL99 Mode:

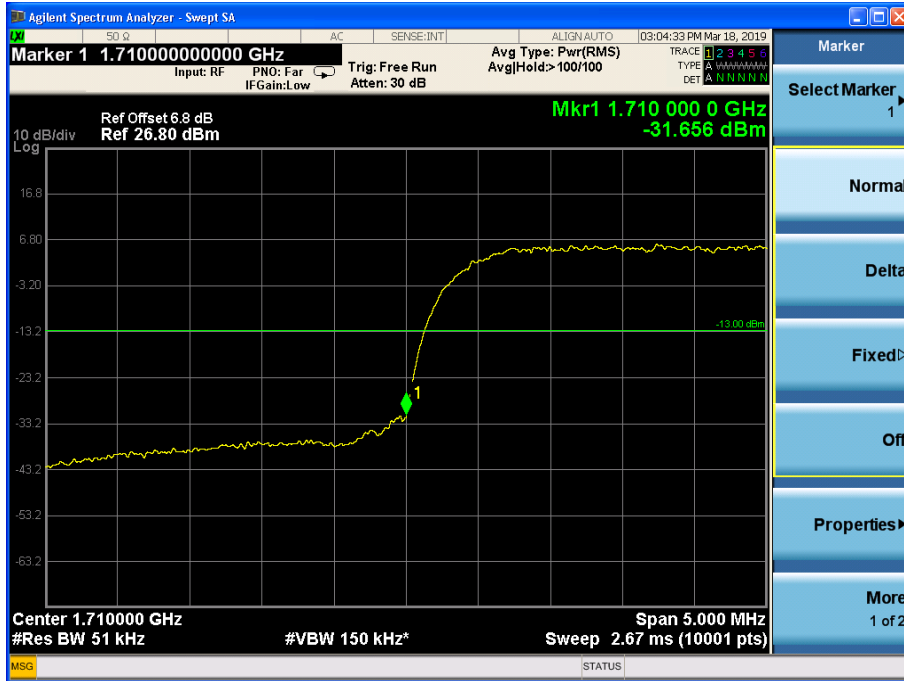

Channel 1312



Channel 1513

HSDPA Mode:

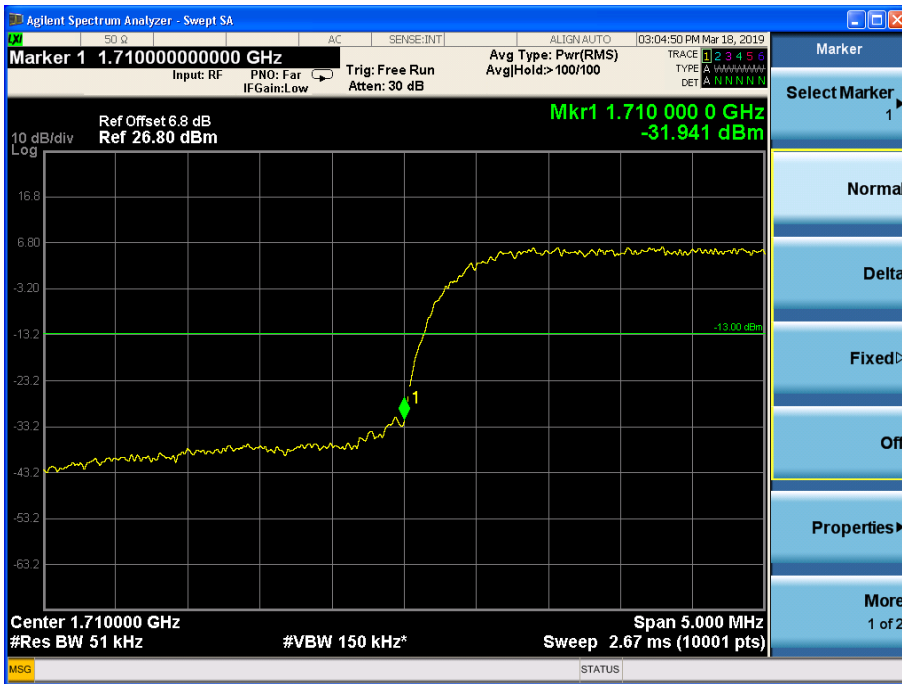

Channel 1312



Channel 1513

Frequency Stability-FCC Part2.1055/22.355/24.235/27.54

WCDMA band II

REL99 Mode:

Temperature(°C)	Test Result (ppm)@NV		
	Channel 9262	Channel 9400	Channel 9538
0	0.002	-0.009	0.007
+10	-0.007	-0.008	0.010
+20	-0.009	0.002	0.010
+30	0.006	-0.008	-0.012
+40	0.016	0.007	-0.011
+50	-0.008	-0.009	0.010
+55	0.013	-0.001	-0.003
Voltage	Test Result (ppm)@NT		
	Channel 9262	Channel 9400	Channel 9538
LV	0.002	0.003	0.004
HV	0.004	0.004	0.002

HSDPA Mode:

Temperature(°C)	Test Result (ppm)@NV		
	Channel 9262	Channel 9400	Channel 9538
0	-0.001	0.005	0.013
+10	-0.009	0.002	0.000
+20	-0.003	0.006	0.013
+30	0.008	0.014	0.013
+40	0.010	0.013	-0.004
+50	0.004	0.004	-0.010
+55	0.013	-0.014	-0.006
Voltage	Test Result (ppm)NT		
	Channel 9262	Channel 9400	Channel 9538
LV	0.008	0.001	0.005
HV	-0.005	0.015	0.015

WCDMA band V
REL99 Mode:

Temperature(°C)	Test Result (ppm)@NV		
	Channel 4132	Channel 4183	Channel 4233
0	-0.004	-0.001	-0.011
+10	-0.010	-0.010	-0.003
+20	-0.006	-0.009	-0.006
+30	0.013	0.012	0.009
+40	0.019	0.012	0.008
+50	0.008	0.008	0.004
+55	-0.007	-0.007	-0.013

Voltage	Test Result (ppm)@NT		
	Channel 4132	Channel 4183	Channel 4233
LV	-0.002	-0.006	-0.009
HV	0.006	0.010	0.001

HSDPA Mode:

Temperature(°C)	Test Result (ppm)@NV		
	Channel 4132	Channel 4183	Channel 4233
0	-0.005	-0.006	-0.004
+10	-0.012	-0.006	-0.007
+20	-0.007	-0.002	0.006
+30	0.015	0.008	0.011
+40	0.004	0.006	0.012
+50	0.000	0.001	0.014
+55	-0.008	0.007	-0.004

Voltage	Test Result (ppm)@NT		
	Channel 4132	Channel 4183	Channel 4233
LV	0.012	-0.014	-0.008
HV	0.005	-0.009	-0.005

WCDMA band IV

REL99 Mode:

Temperature(°C)	Test Result (ppm)@NV		
	Channel 1312	Channel 1412	Channel 1513
0	-0.005	-0.005	0.010
+10	-0.010	-0.001	0.009
+20	0.013	0.012	0.012
+30	-0.013	0.014	-0.007
+40	-0.003	0.010	0.003
+50	0.013	0.015	-0.011
+55	0.011	-0.012	-0.013

Voltage	Test Result (ppm)@NT		
	Channel 1312	Channel 1412	Channel 1513
LV	-0.001	0.007	-0.013
HV	-0.010	0.001	-0.003

HSDPA Mode:

Temperature(°C)	Test Result (ppm)@NV		
	Channel 1312	Channel 1412	Channel 1513
0	0.011	0.000	-0.002
+10	0.014	-0.009	-0.006
+20	0.010	-0.003	-0.014
+30	0.013	-0.003	0.008
+40	-0.010	-0.002	0.011
+50	-0.015	0.010	-0.003
+55	0.015	0.008	-0.015

Voltage	Test Result (ppm)@NT		
	Channel 1312	Channel 1412	Channel 1513
LV	0.009	-0.003	-0.007
HV	-0.005	-0.011	-0.014

Peak-Average Ratio -FCC Part 24.232(d)/ 27.50(d)(5)

WCDMA band II

REL99 Mode:

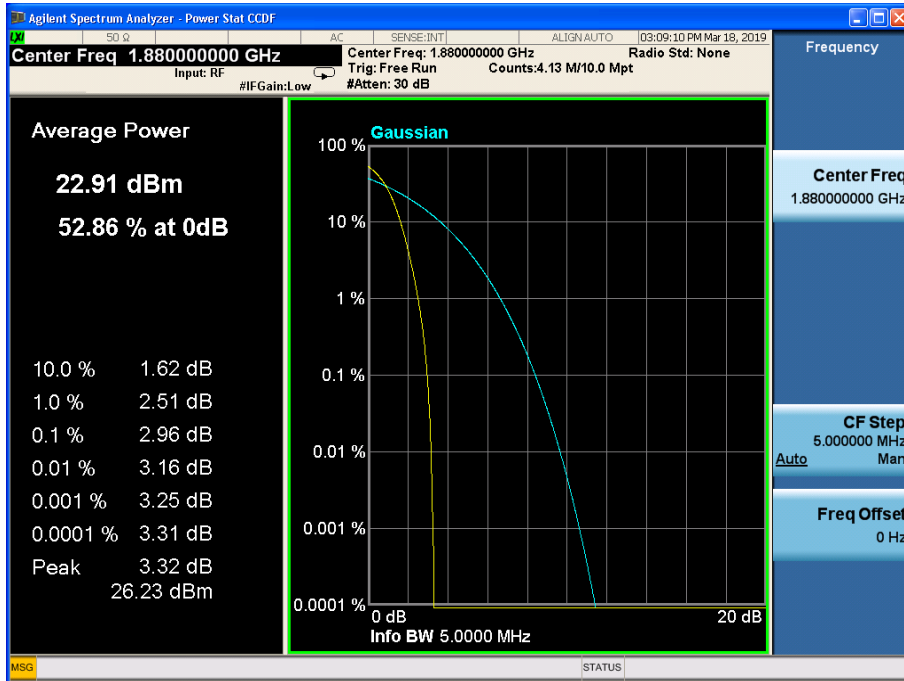

HSDPA Mode:

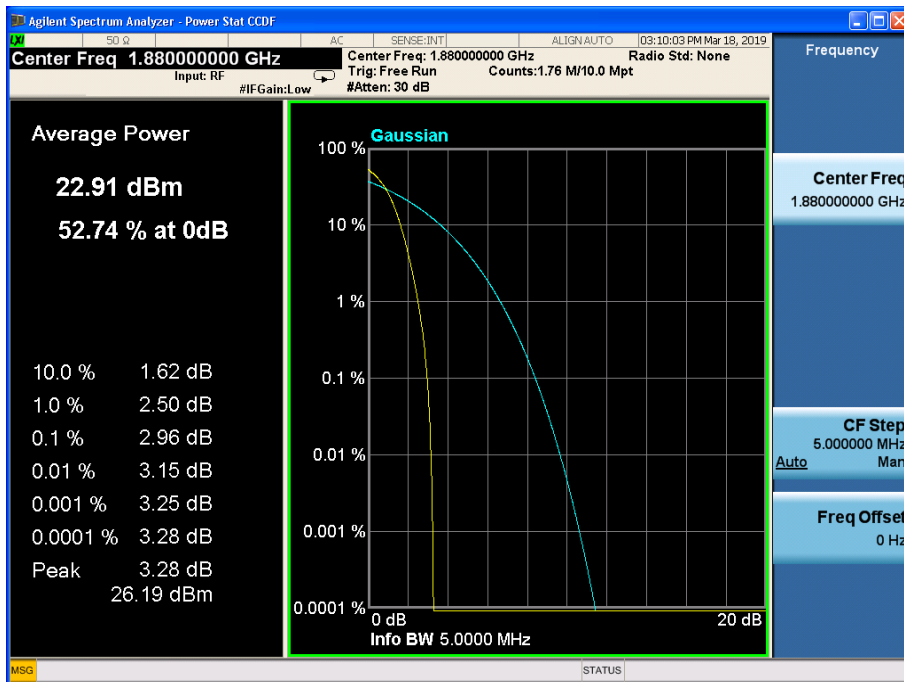

WCDMA band IV

REL99 Mode:

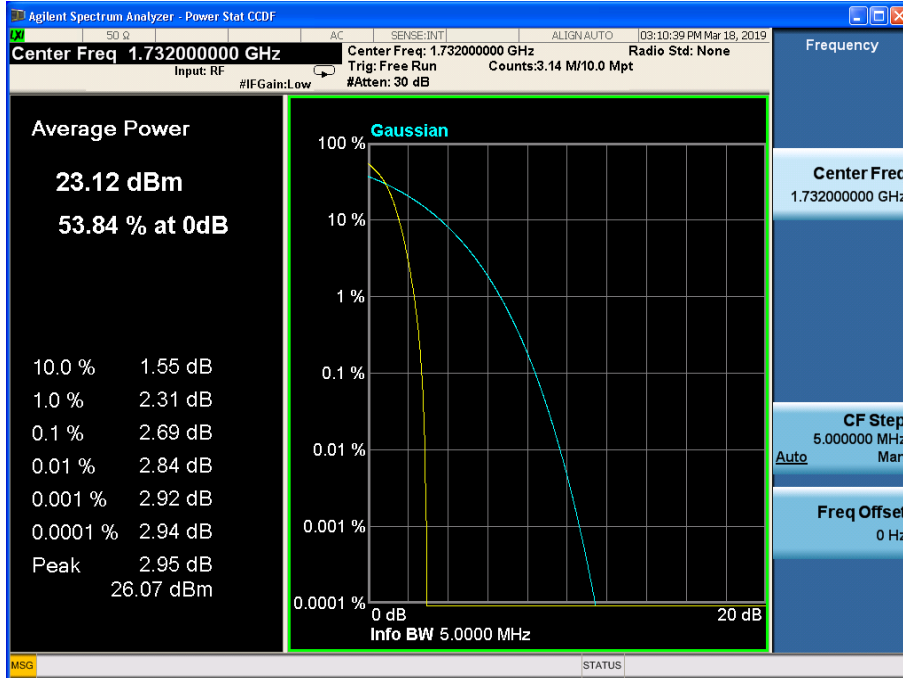

HSDPA Mode:

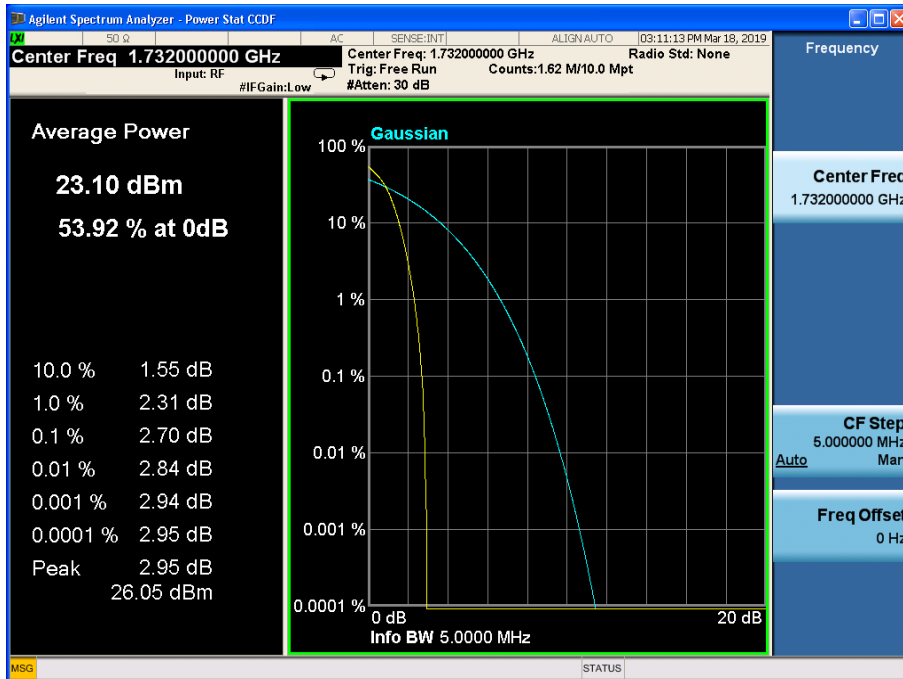

WCDMA band V

REL99 Mode:

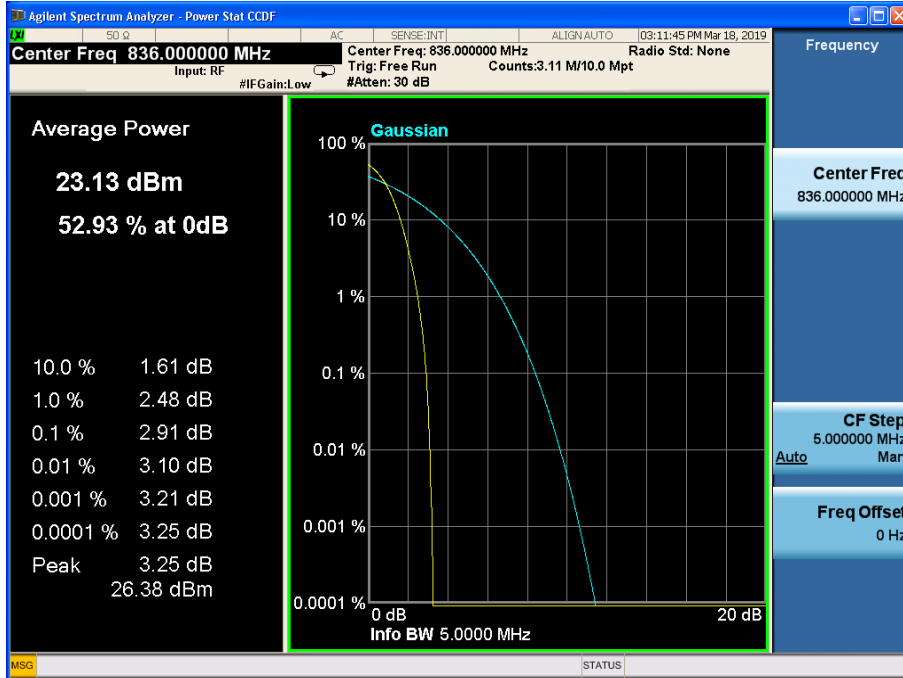

HSDPA Mode:

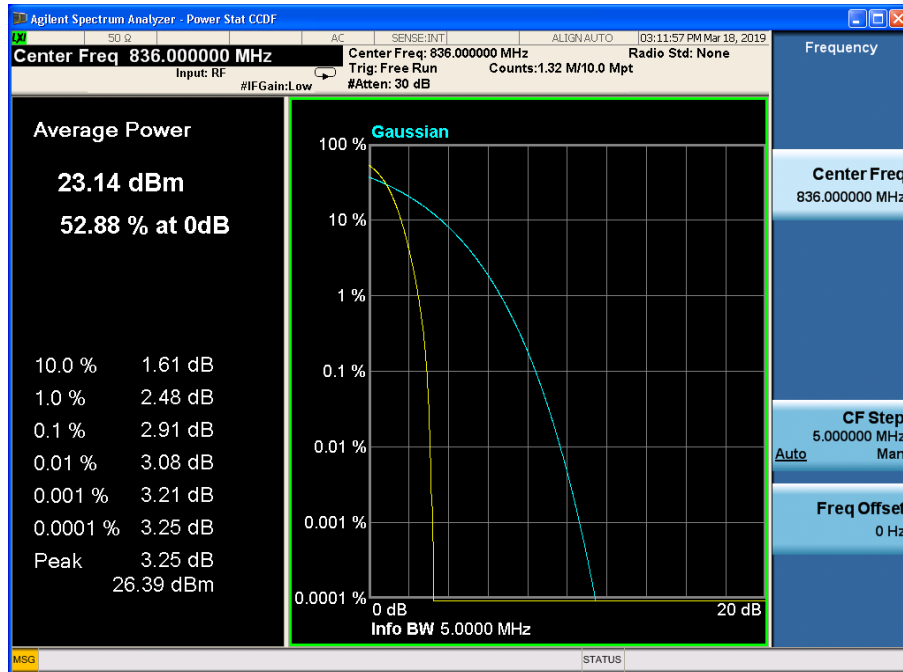

APPENDIX B – TEST DATA OF RADIATED EMISSION

WCDMA band II

Test result:

WCDMA Mode:

Channel 9262

Frequency (MHz)	Power (dBm)	Limited (dBm)	Polarization
2455.50	-53.07	-13	Vertical
2779.28	-51.99	-13	Vertical
3729.19	-43.37	-13	Vertical
6678.19	-43.80	-13	Vertical
9961.78	-39.67	-13	Vertical
17823.11	-35.80	-13	Horizontal

Channel 9400

Frequency (MHz)	Power (dBm)	Limited (dBm)	Polarization
2452.89	-52.31	-13	Vertical
2778.55	-51.91	-13	Vertical
3727.73	-44.26	-13	Vertical
6678.32	-43.87	-13	Vertical
9961.86	-39.63	-13	Vertical
17823.88	-35.94	-13	Vertical

Channel 9538

Frequency (MHz)	Power (dBm)	Limited (dBm)	Polarization
2455.13	-52.76	-13	Vertical
2778.82	-51.81	-13	Vertical
3727.38	-43.78	-13	Vertical
6676.46	-43.22	-13	Vertical
9965.01	-39.42	-13	Vertical
17823.65	-35.63	-13	Vertical

HSDPA/HSUPA Mode:
Channel 9262

Frequency (MHz)	Power (dBm)	Limited (dBm)	Polarization
2452.87	-52.81	-13	Vertical
2780.91	-51.83	-13	Vertical
3728.13	-44.20	-13	Vertical
6676.95	-43.80	-13	Vertical
9965.15	-40.01	-13	Vertical
17821.88	-35.84	-13	Vertical

Channel 9400

Frequency (MHz)	Power (dBm)	Limited (dBm)	Polarization
2454.09	-52.84	-13	Vertical
2779.02	-51.48	-13	Vertical
3729.36	-44.21	-13	Vertical
6678.09	-43.52	-13	Vertical
9962.45	-39.97	-13	Vertical
17822.95	-35.49	-13	Vertical

Channel 9538

Frequency (MHz)	Power (dBm)	Limited (dBm)	Polarization
2453.85	-52.73	-13	Vertical
2781.67	-51.64	-13	Vertical
3728.94	-44.14	-13	Vertical
6676.75	-43.19	-13	Vertical
9964.05	-39.67	-13	Vertical
17821.21	-35.81	-13	Vertical

WCDMA band IV

Test result:

WCDMA Mode:

Channel 1312

Frequency (MHz)	Power (dBm)	Limited (dBm)	Polarization
2454.45	-52.86	-13	Vertical
2781.08	-52.08	-13	Vertical
3727.46	-44.32	-13	Vertical
6677.55	-43.27	-13	Vertical
9963.67	-40.17	-13	Horizontal
17820.69	-35.32	-13	Vertical

Channel 1412

Frequency (MHz)	Power (dBm)	Limited (dBm)	Polarization
2455.13	-53.15	-13	Vertical
2779.92	-51.61	-13	Vertical
3727.67	-44.22	-13	Vertical
6678.47	-43.60	-13	Vertical
9963.54	-40.33	-13	Horizontal
17822.14	-36.18	-13	Vertical

Channel 1513

Frequency (MHz)	Power (dBm)	Limited (dBm)	Polarization
2455.69	-53.21	-13	Vertical
2778.56	-52.10	-13	Vertical
3729.14	-44.02	-13	Vertical
6676.62	-43.37	-13	Vertical
9963.68	-39.64	-13	Vertical
17822.35	-35.78	-13	Vertical

HSDPA/HSUPA Mode:
Channel 1312

Frequency (MHz)	Power (dBm)	Limited (dBm)	Polarization
2455.97	-52.73	-13	Vertical
2781.60	-51.30	-13	Vertical
3728.97	-43.99	-13	Vertical
6676.86	-43.38	-13	Vertical
9964.93	-39.92	-13	Vertical
17824.41	-35.67	-13	Vertical

Channel 1412

Frequency (MHz)	Power (dBm)	Limited (dBm)	Polarization
2456.17	-52.86	-13	Vertical
2781.52	-51.25	-13	Vertical
3727.79	-43.66	-13	Vertical
6678.37	-43.25	-13	Vertical
9962.69	-39.44	-13	Vertical
17820.72	-35.86	-13	Horizontal

Channel 1513

Frequency (MHz)	Power (dBm)	Limited (dBm)	Polarization
2453.41	-52.85	-13	Vertical
2781.43	-51.88	-13	Vertical
3728.54	-43.34	-13	Horizontal
6679.74	-43.93	-13	Vertical
9964.12	-40.00	-13	Vertical
17822.24	-35.99	-13	Vertical

WCDMA band V

Test result:

WCDMA Mode:

Channel 4132

Frequency (MHz)	Power (dBm)	Limited (dBm)	Polarization
1644.33	-52.67	-13	Vertical
1667.39	-51.63	-13	Vertical
2536.04	-43.59	-13	Vertical
2574.75	-43.82	-13	Horizontal
8965.90	-39.72	-13	Vertical
9970.24	-35.82	-13	Vertical

Channel 4183

Frequency (MHz)	Power (dBm)	Limited (dBm)	Polarization
1646.62	-52.34	-13	Vertical
1667.57	-50.71	-13	Vertical
2534.71	-44.26	-13	Vertical
2576.88	-43.62	-13	Vertical
8965.71	-40.08	-13	Vertical
9972.21	-36.34	-13	Horizontal

Channel 4233

Frequency (MHz)	Power (dBm)	Limited (dBm)	Polarization
1646.73	-52.61	-13	Vertical
1670.74	-51.08	-13	Vertical
2534.20	-43.76	-13	Vertical
2574.12	-43.30	-13	Vertical
8966.23	-39.67	-13	Horizontal
9970.92	-36.66	-13	Vertical

HSDPA/HSUPA Mode:
Channel 4132

Frequency (MHz)	Power (dBm)	Limited (dBm)	Polarization
1644.33	-53.03	-13	Vertical
1669.90	-51.24	-13	Vertical
2536.15	-43.78	-13	Vertical
2576.05	-43.76	-13	Vertical
8963.43	-40.03	-13	Vertical
9969.96	-36.31	-13	Vertical

Channel 4183

Frequency (MHz)	Power (dBm)	Limited (dBm)	Polarization
1645.71	-53.22	-13	Vertical
1668.06	-50.89	-13	Vertical
2534.36	-44.41	-13	Vertical
2573.82	-44.04	-13	Vertical
8965.86	-39.43	-13	Vertical
9972.00	-36.74	-13	Vertical

Channel 4233

Frequency (MHz)	Power (dBm)	Limited (dBm)	Polarization
1645.41	-53.03	-13	Vertical
1667.90	-51.26	-13	Vertical
2533.42	-43.73	-13	Vertical
2576.03	-43.30	-13	Vertical
8962.64	-40.11	-13	Vertical
9971.59	-35.79	-13	Vertical

---End of Test Report---