

WCDMA850MHz Channel = 4233, 30MHz to 1GHz

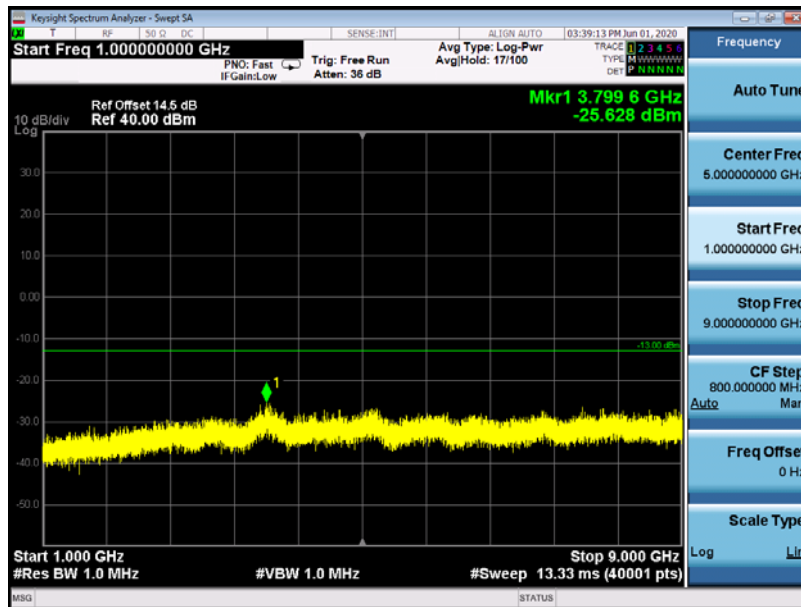

WCDMA850MHz Channel = 4233, 1GHz to 9GHz

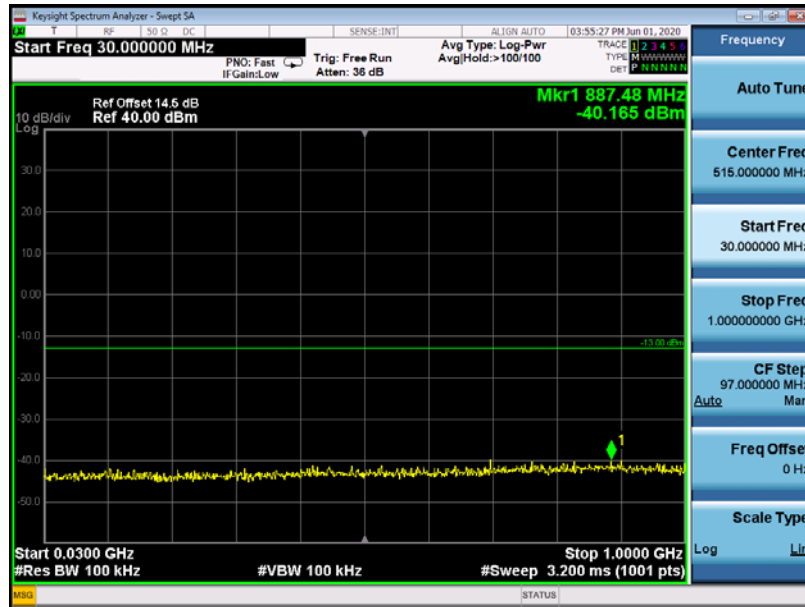

WCDMA1900MHz Channel = 9262, 30MHz to 1GHz

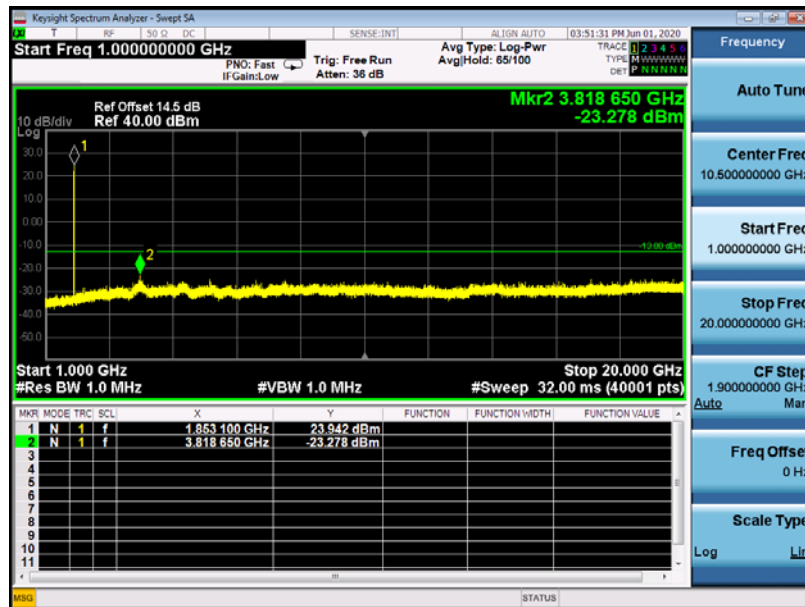

WCDMA1900MHz Channel = 9262, 1GHz to 20GHz

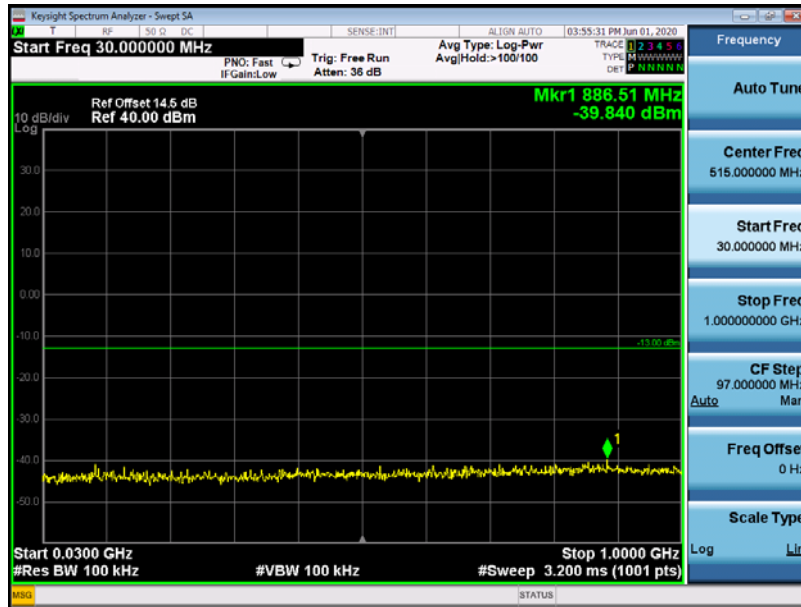

WCDMA1900MHz Channel = 9400, 30MHz to 1GHz

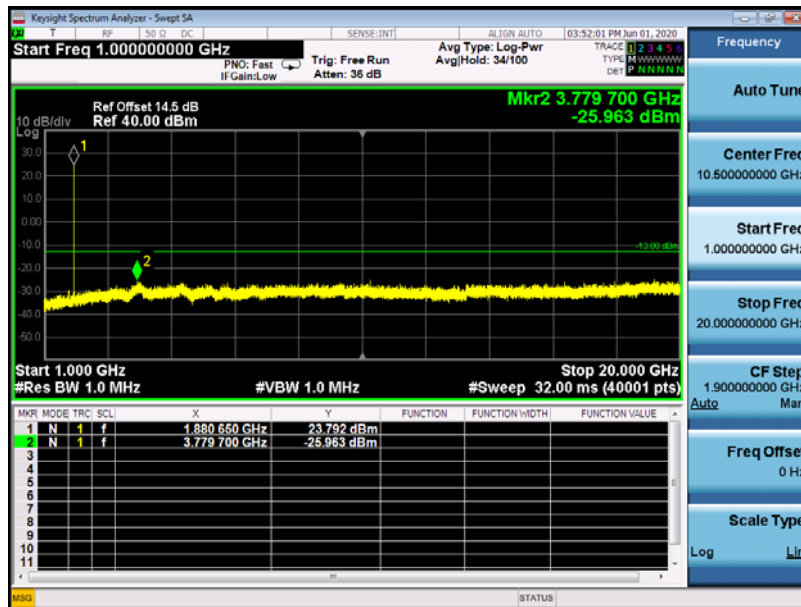

WCDMA1900MHz Channel = 9400, 1GHz to 20GHz

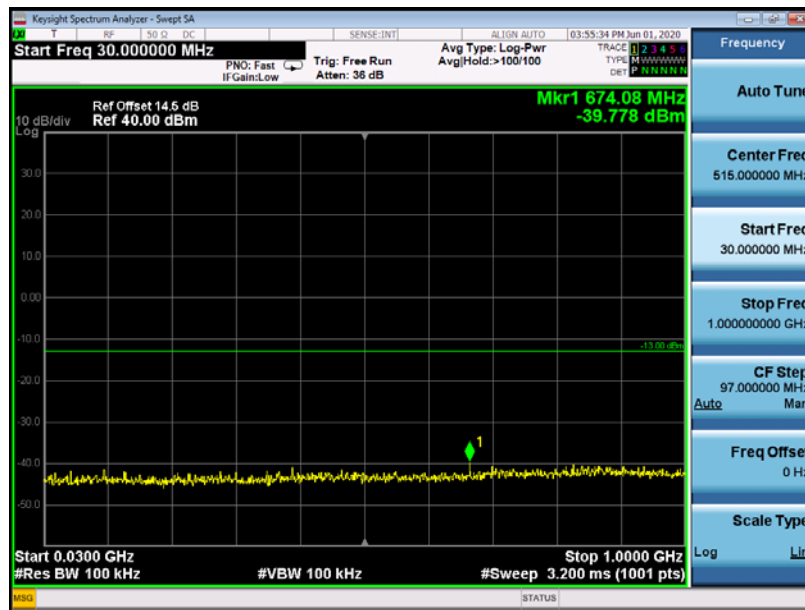

WCDMA1900MHz Channel = 9538, 30MHz to 1GHz

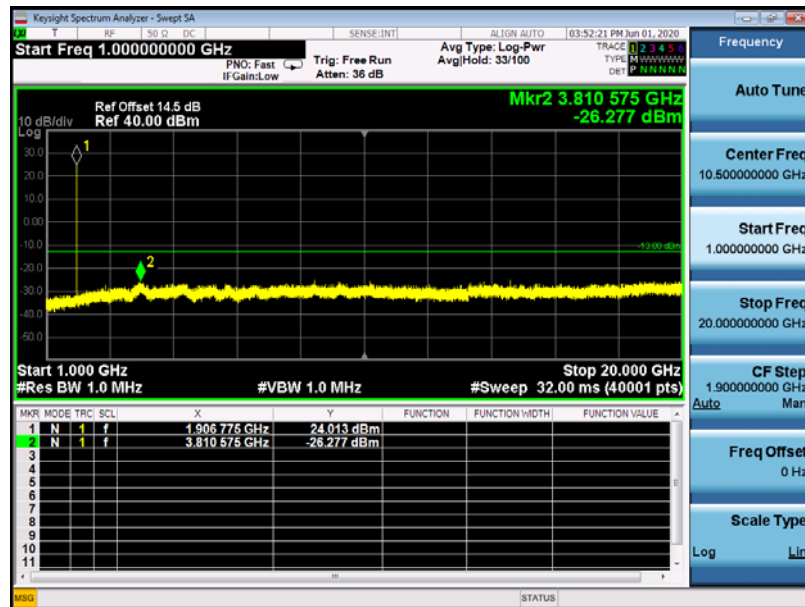

WCDMA1900MHz Channel = 9538 1GHz to 20GHz

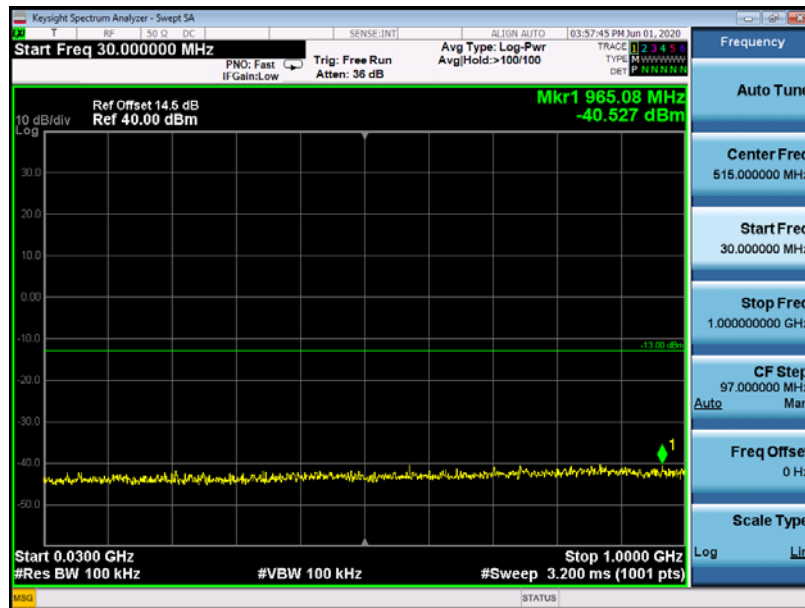

WCDMA1700MHz Channel = 1312, 30MHz to 1GHz

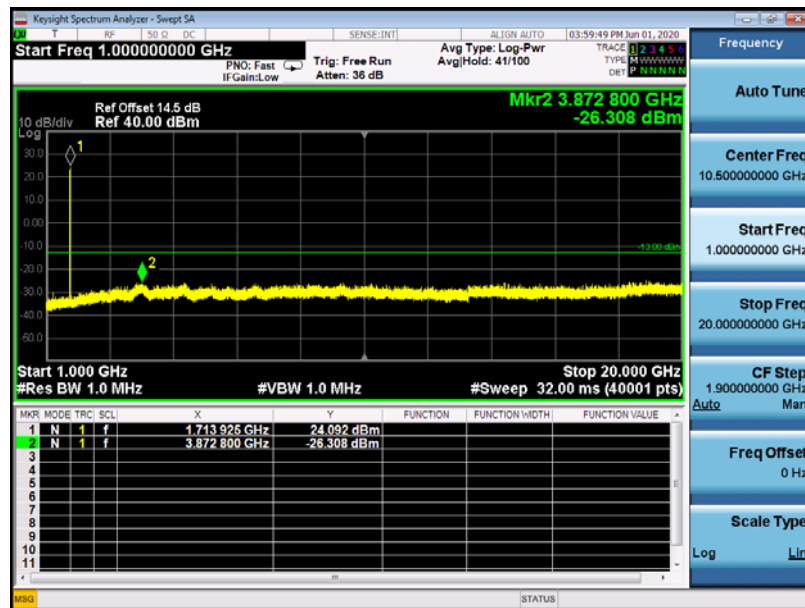

WCDMA1700MHz Channel = 1312, 1GHz to 18GHz

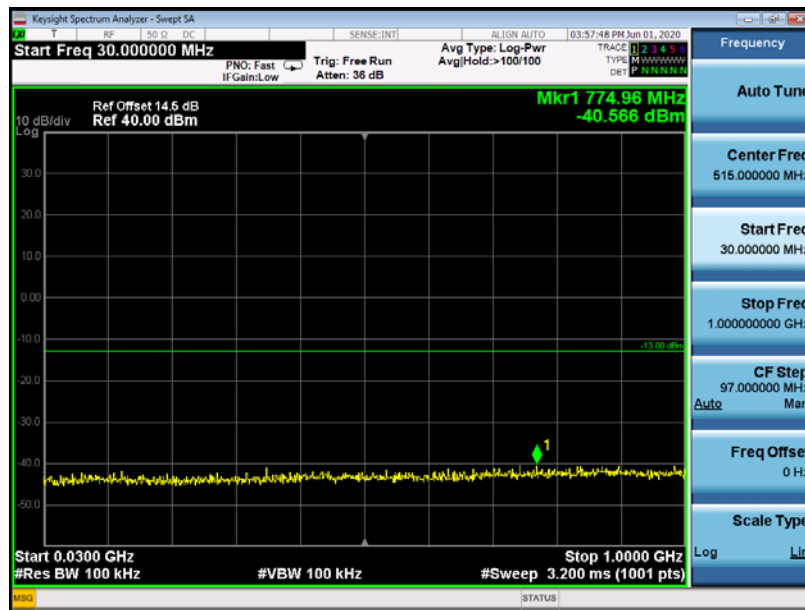

WCDMA1700MHz Channel = 1414, 30MHz to 1GHz

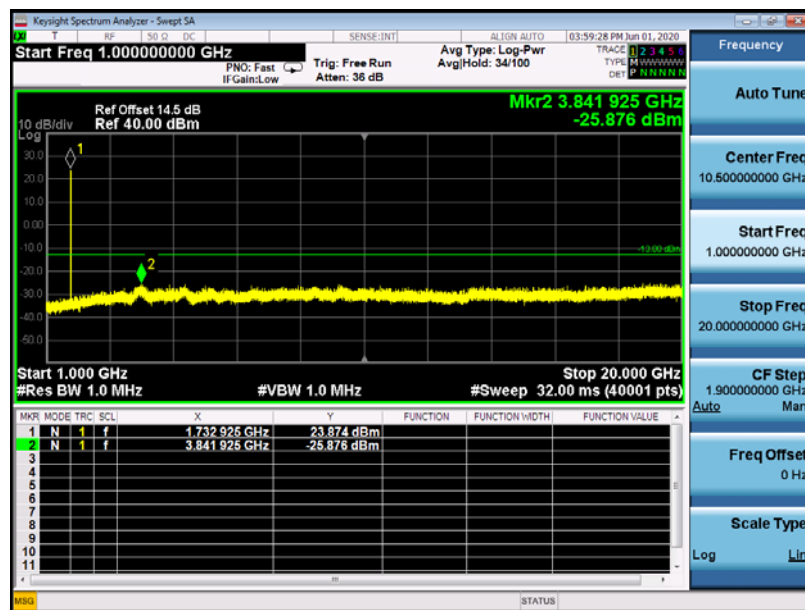

WCDMA1700MHz Channel = 1414, 1GHz to 18GHz

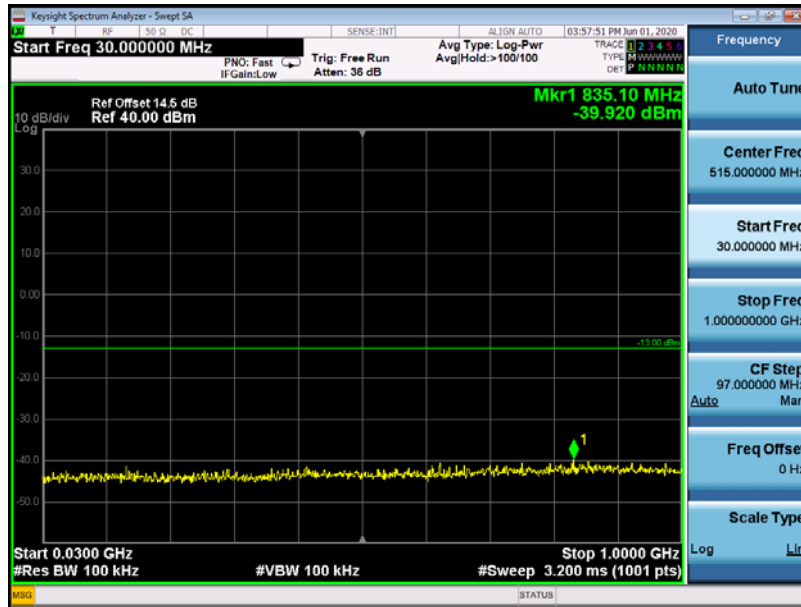

WCDMA1700MHz Channel = 1513, 30MHz to 1GHz

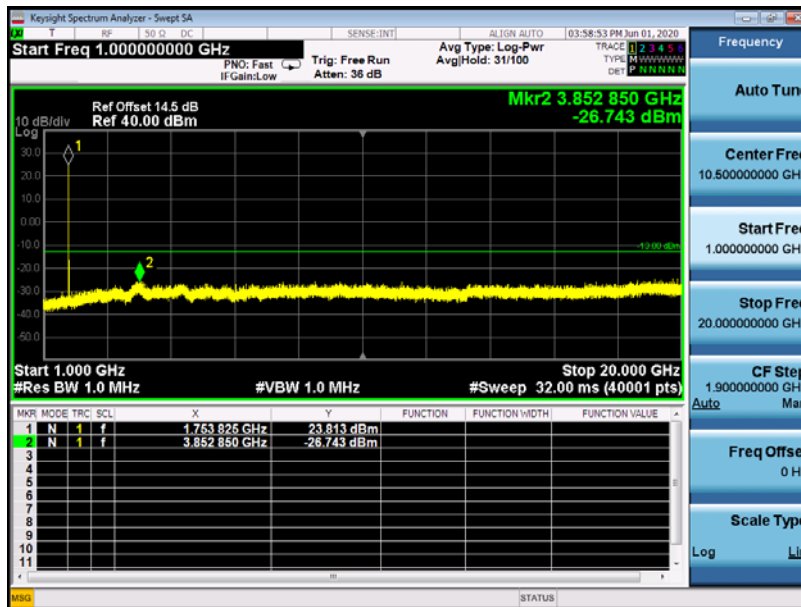

WCDMA1700MHz Channel = 1513, 1GHz to 18GHz

2.6 Bandedge

2.6.1 Requirement

The power of any emission outside of the authorized operating frequency ranges must be lower than the transmitter power (P) by a factor of at least $43 + 10 \log (P)$ dB.

2.6.2 Measuring Instruments

The measuring equipment is listed in the section 3 of this test report.

2.6.3 Test Procedures

1. The testing follows FCC KDB 971168 D01 v03r01 Section 6.0.
2. The EUT was connected to the spectrum analyzer and system simulator via a power divider.
3. The RF output of EUT was connected to the spectrum analyzer by an RF cable and attenuator. The path loss was compensated to the results for each measurement.
4. The band GPRSs of low and high channels for the highest RF powers were measured.
5. The RF fundamental frequency should be excluded against the limit line in the operating frequency band.
6. The limit line is derived from $43 + 10\log(P)$ dB below the transmitter power P(Watts)
 $= P(W) - [43 + 10\log(P)]$ (dB)
 $= [30 + 10\log(P)]$ (dBm) - $[43 + 10\log(P)]$ (dB)
 $= -13\text{dBm}$.

2.6.4 Test Setup

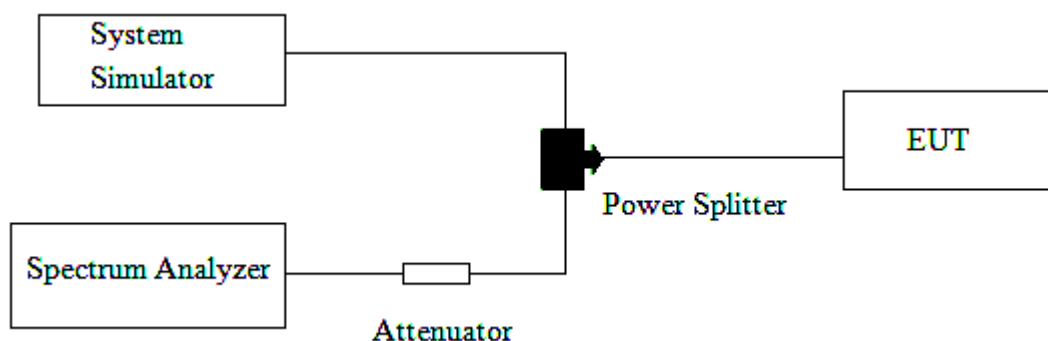

2.6.5 Test Result of Conducted Bandedge



(Plot A: GSM 850 Channel = 128)

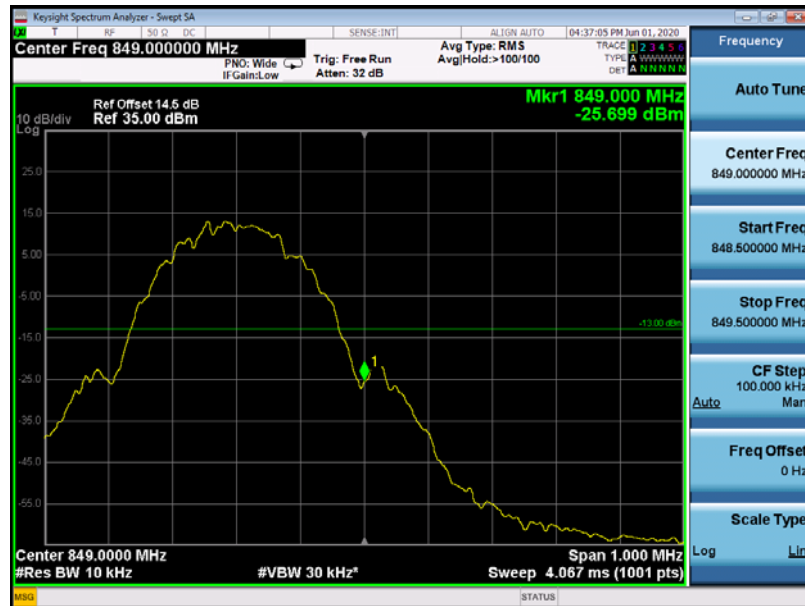

(Plot B: GSM 850 Channel = 251)



(Plot C:GSM 1900 Channel = 512)



(Plot D: GSM 1900 Channel = 810)



(Plot E: EDGE 850 Channel = 128)



(Plot F: EDGE 850 Channel = 251)



(Plot G: EDGE 1900 Channel = 512)

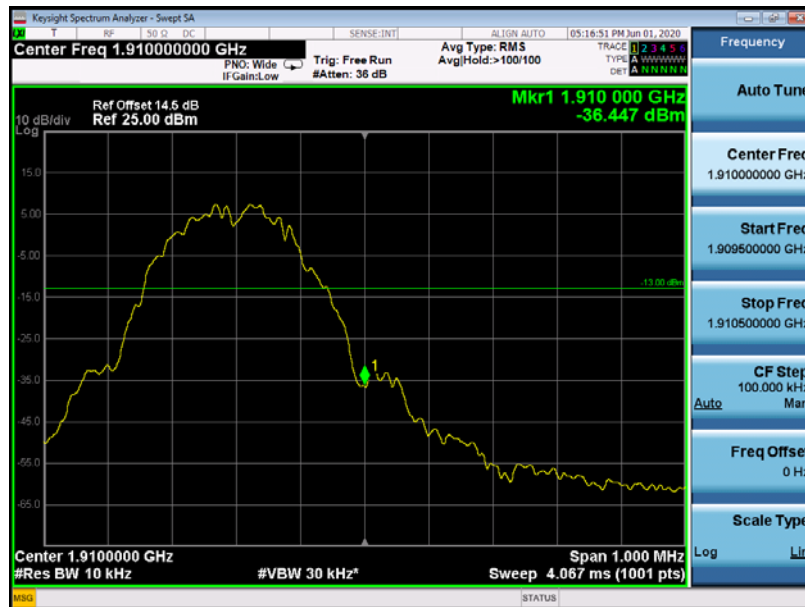

(Plot H: EDGE 1900 Channel = 810)

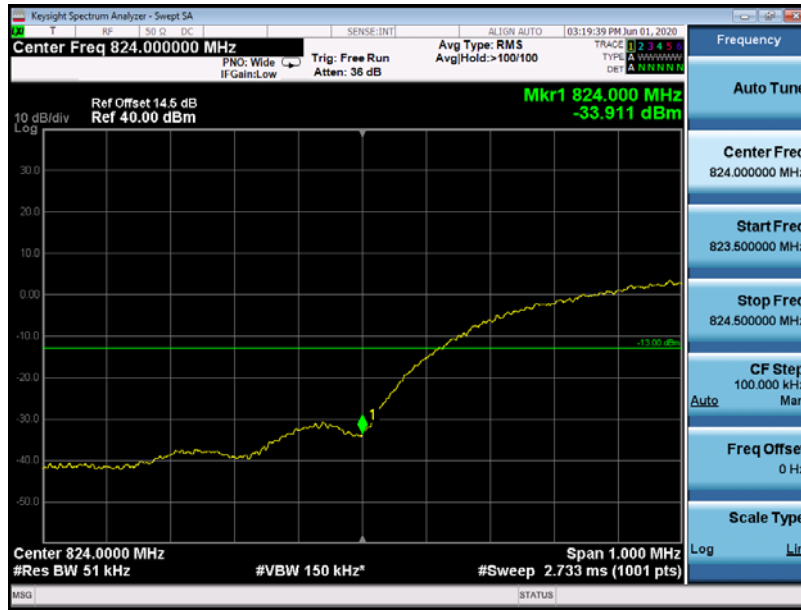

(Plot I: WCDMA 850 Channel = 4132)

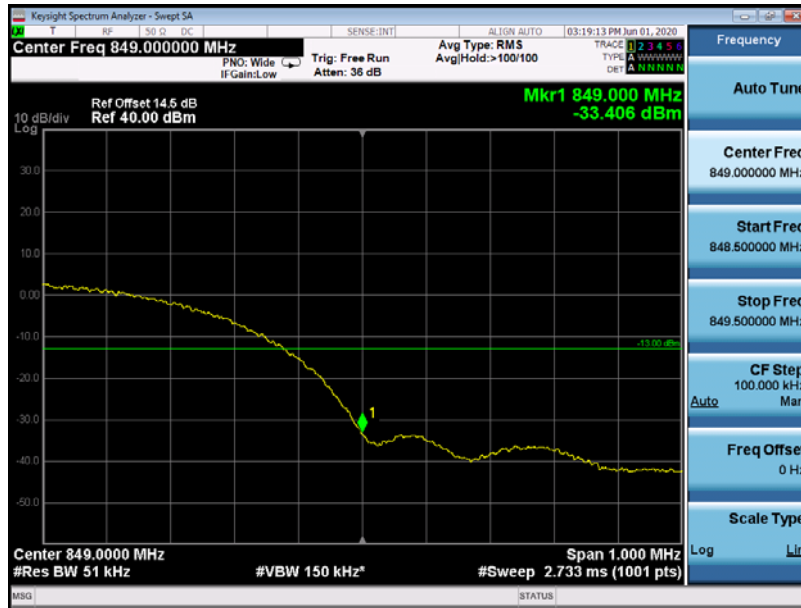

(Plot J: WCDMA 850 Channel = 4233)

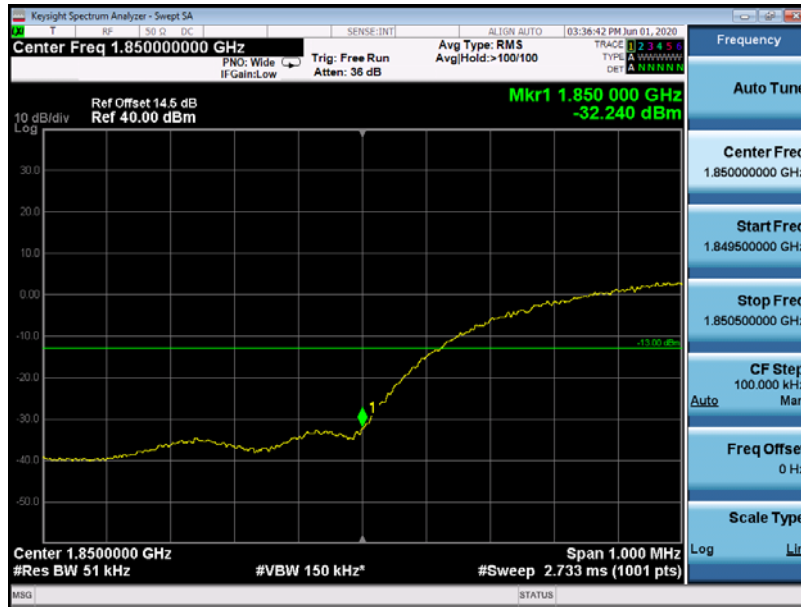

(Plot K: WCDMA 1900 Channel = 9262)



(Plot L: WCDMA 1900 Channel = 9538)

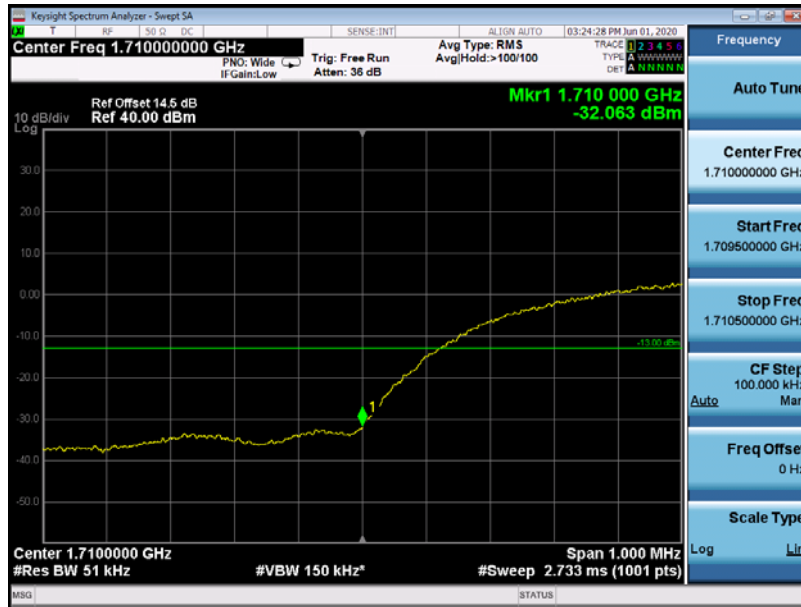

(Plot M: WCDMA 1700 Channel = 1312)



(Plot N: WCDMA 1700 Channel = 1513)

2.7 Transmitter Radiated Power (EIRP/ERP)

2.7.1 Requirement

The substitution method, in ANSI C63.26:2015, was used for ERP/EIRP measurement, and the spectrum analyzer configuration follows KDB 971168 D01 Power Meas. License Digital Systems v03r01. The ERP of mobile transmitters must not exceed 7 Watts (Cellular Band) and the EIRP of mobile transmitters are limited to 2 Watts (PCS Band) and 1 Watts (AWS Band).

2.7.2 Measuring Instruments

The measuring equipment is listed in the section 3 of this test report.

2.7.3 Test Procedures

1. The testing follows FCC KDB 971168 D01 v03r01 Section 5.2.1. (for CDMA/WCDMA), Section 5.2.2.2 (for GSM/GSM/GPRS) and ANSI / TIA-603-D-2010 Section 2.2.17.
2. The EUT was placed on a turntable 1.5 meters high in a fully anechoic chamber.
3. The EUT was placed 3 meters from the receiving antenna, which was mounted on the antenna tower.
4. GSM operating modes: Set RBW= 1MHz, VBW= 3MHz, RMS detector over burst;
UMTS operating modes: Set RBW= 100 kHz, VBW= 300 kHz, RMS detector over frame, and use channel power option with bandwidth=5MHz, per KDB 971168 D01 v03r01.
5. The table was rotated 360 degrees to determine the position of the highest radiated power.
6. The height of the receiving antenna is adjusted to look for the maximum ERP/EIRP.
7. Taking the record of maximum ERP/EIRP.
8. A dipole antenna was substituted in place of the EUT and was driven by a signal generator.
9. The conducted power at the terminal of the dipole antenna is measured.

10. Repeat step 3 to step 5 to get the maximum ERP/EIRP of the substitution antenna.

$$11. \text{ERP/EIRP} = P_s + E_t - E_s + G_s = P_s + R_t - R_s + G_s$$

P_s (dBm): Input power to substitution antenna.

G_s (dBi or dBd): Substitution antenna Gain.

$$E_t = R_t + \text{AF} \quad E_s = R_s + \text{AF}$$

AF (dB/m): Receive antenna factor

R_t : The highest received signal in spectrum analyzer for EUT.

R_s : The highest received signal in spectrum analyzer for substitution antenna.

2.7.4 Test Setup

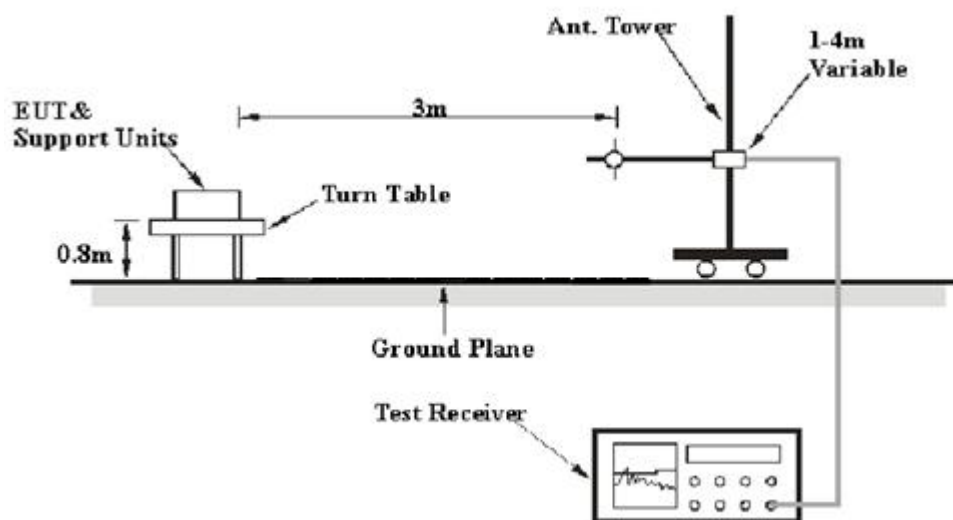



2.7.5 Test Result of Transmitter Radiated Power

Test Notes:

1. This device employs GMSK technology with GSM capabilities. All configurations were investigated and the worst case emissions were found in GSM mode.
2. This device employs UMTS technology with WCDMA (AMR/RMC), HSDPA, HSUPA capabilities. All configurations were investigated and the worst case UMTS emissions were found in RMC WCDMA mode at 12.2Kbps.
3. This unit was tested with its standard battery.
4. The worst case test configuration was found in the vertical positioning where the EUT is laying on its side. The data reported in the tables below were measured in this test setup.

| Band | Channel | Frequency (MHz) | PCL | Antenna Pol (H/V) | Measured ERP dBm | Limit dBm | Verdict |
|------------|---------|-----------------|-----|-------------------|------------------|-----------|---------|
| GSM 850MHz | 128 | 824.20 | 5 | H | 31.61 | 38.5 | PASS |
| | | | | V | 31.37 | | |
| | 190 | 836.60 | 5 | H | 31.46 | | PASS |
| | | | | V | 31.15 | | |
| | 251 | 848.80 | 5 | H | 31.74 | | PASS |
| | | | | V | 31.15 | | |

| Band | Channel | Frequency (MHz) | PCL | Antenna Pol (H/V) | Measured EIRP dBm | Limit dBm | Verdict |
|-------------|---------|-----------------|-----|-------------------|-------------------|-----------|---------|
| GSM 1900MHz | 512 | 1850.2 | 0 | H | 27.35 | 33 | PASS |
| | | | | V | 27.13 | | |
| | 661 | 1880.0 | 0 | H | 27.94 | | PASS |
| | | | | V | 27.64 | | |
| | 810 | 1909.8 | 0 | H | 27.48 | | PASS |
| | | | | V | 27.27 | | |



| Band | Channel | Frequency (MHz) | PCL | Antenna Pol (H/V) | Measured ERP dBm | Limit dBm | Verdict |
|----------------|---------|-----------------|-----|-------------------|------------------|-----------|---------|
| EDGE 850MHz | 128 | 824.20 | 5 | H | 25.35 | 38.5 | PASS |
| | | | | V | 25.71 | | |
| | 190 | 836.60 | 5 | H | 25.22 | | PASS |
| | | | | V | 25.61 | | |
| | 251 | 848.80 | 5 | H | 25.47 | | PASS |
| | | | | V | 25.13 | | |

| Band | Channel | Frequency (MHz) | PCL | Antenna Pol (H/V) | Measured EIRP dBm | Limit dBm | Verdict |
|-----------------|---------|-----------------|-----|-------------------|-------------------|-----------|---------|
| EDGE 1900MHz | 512 | 1850.2 | 0 | H | 24.91 | 33 | PASS |
| | | | | V | 25.15 | | |
| | 661 | 1880.0 | 0 | H | 25.36 | | PASS |
| | | | | V | 25.11 | | |
| | 810 | 1909.8 | 0 | H | 24.85 | | PASS |
| | | | | V | 24.93 | | |

| Band | Channel | Frequency (MHz) | Antenna Pol (H/V) | Measured ERP dBm | Limit dBm | Verdict |
|-----------------|---------|-----------------|-------------------|------------------|-----------|---------|
| WCDMA 850MHz | 4132 | 826.4 | H | 21.98 | 38.5 | PASS |
| | | | V | 22.51 | | |
| | 4175 | 835 | H | 22.25 | | PASS |
| | | | V | 22.83 | | |
| | 4233 | 846.6 | H | 21.92 | | PASS |
| | | | V | 22.42 | | |

| Band | Channel | Frequency (MHz) | Antenna Pol (H/V) | Measured EIRP dBm | Limit dBm | Verdict |
|------------------|---------|-----------------|-------------------|-------------------|-----------|---------|
| WCDMA 1900MHz | 9262 | 1852.4 | H | 21.84 | 33 | PASS |
| | | | V | 21.91 | | |
| | 9400 | 1880 | H | 21.92 | | PASS |
| | | | V | 22.06 | | |
| | 9538 | 1907.6 | H | 21.98 | | PASS |
| | | | V | 22.02 | | |



| Band | Channel | Frequency (MHz) | Antenna Pol (H/V) | Measured EIRP dBm | Limit dBm | Verdict |
|------------------|---------|-----------------|-------------------|-------------------|-----------|---------|
| WCDMA 1700MHz | 1312 | 1712.4 | H | 22.01 | 30 | PASS |
| | | | V | 21.99 | | |
| | 1413 | 1732.4 | H | 22.15 | | PASS |
| | | | V | 21.00 | | |
| | 1513 | 1752.6 | H | 21.92 | | PASS |
| | | | V | 21.62 | | |

2.8 Radiated Spurious Emissions

2.8.1 Requirement

The power of any emission outside of the authorized operating frequency ranges must be attenuated below the transmitter power (P) by a factor of at least $43 + 10 \log (P)$ dB. The spectrum is scanned from 30 MHz up to a frequency including its 10th harmonic.

2.8.2 Measuring Instruments

The measuring equipment is listed in the section 3 of this test report.

2.8.3 Test Setup

For radiated emissions from 9 kHz to 30MHz

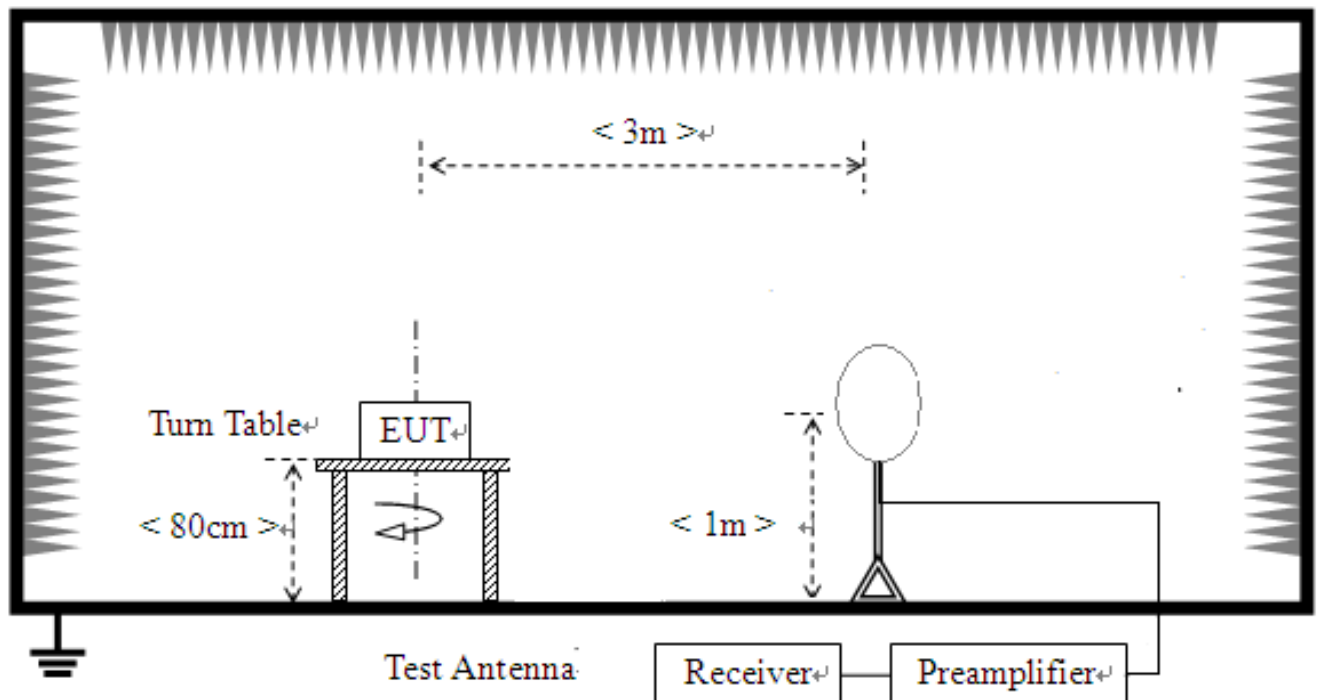

For radiated emissions from 30MHz to 1GHz

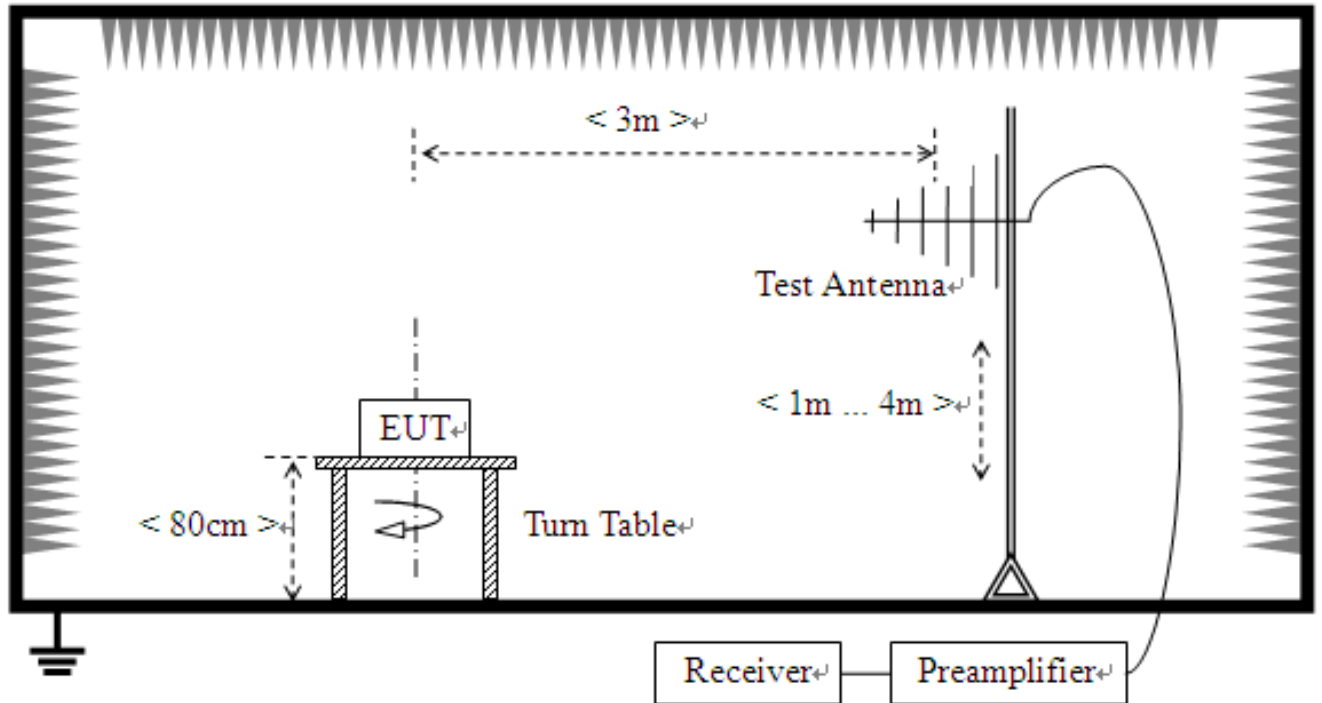

For radiated emissions above 1GHz

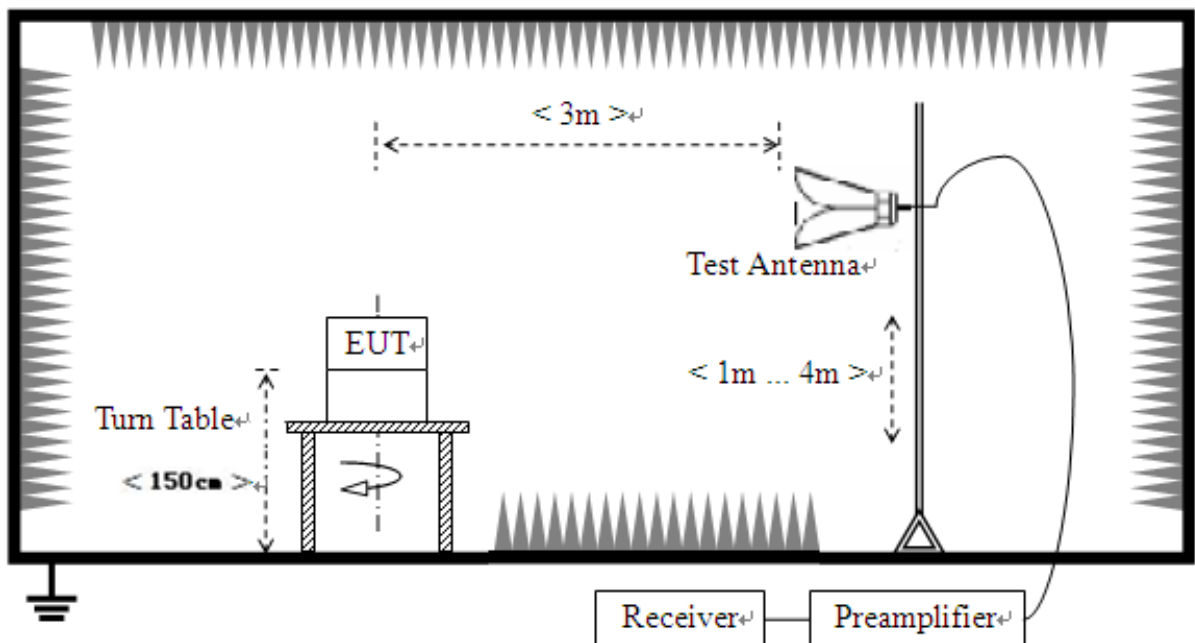

2.8.4 Test Procedures

1. The testing follows FCC KDB 971168 D01 v03r01 Section 5.8.
2. The EUT was placed on a rotatable wooden table 0.8/1.5 meters above the ground.
3. The EUT was set 3 meters from the receiving antenna, which was mounted on the antenna tower.
4. The table was rotated 360 degrees to determine the position of the highest spurious emission.
5. The height of the receiving antenna is varied between one meter and four meters to search for the maximum spurious emission for both horizontal and vertical polarizations.
6. Make the measurement with the spectrum analyzer's RBW = 1MHz, VBW = 3MHz, taking record of maximum spurious emission.
7. A horn antenna was substituted in place of the EUT and was driven by a signal generator.
8. Tune the output power of signal generator to the same emission level with EUT maximum spurious emission.
9. Taking the record of output power at antenna port.
10. Repeat step 7 to step 8 for another polarization.
11. The RF fundamental frequency should be excluded against the limit line in the operating frequency band.
12. The limit line is derived from $43 + 10\log(P)$ dB below the transmitter power P(Watts)
 $= P(W) - [43 + 10\log(P)]$ (dB)
 $= [30 + 10\log(P)]$ (dBm) - $[43 + 10\log(P)]$ (dB)
 $= -13\text{dBm}$.
13. This device employs GMSK technology with GSM and GSM capabilities. All configurations were investigated and the worst case emissions were found in GSM mode.
14. This device employs UMTS technology with WCDMA (AMR/RMC), HSDPA, HSUPA capabilities. All configurations were investigated and the worst case UMTS emissions were found in RMC WCDMA mode at 12.2Kbps.
15. This unit was tested with its standard battery.
16. All Spurious Emission tests were performed in X, Y, Z axis direction and low, middle, high channel. And only the worst axis test condition was recorded in this test report.
17. The spectrum is measured from 9 KHz to the 10th harmonic of the fundamental frequency



of the transmitter using CISPR quasi peak detector below 1GHz. The worst case emissions are reported however emissions whose levels were not within 20dB of the respective limits were not reported.

18. For 9KHz to 30MHz: the amplitude of spurious emissions are attenuated by more than 20dB below the permissible value has no need to be reported.



2.8.5 Test Results of Radiated Spurious Emissions

Note: 1. (Absolute)Level=Reading Level + Factor

Worst-Case test data provide as below:

GSM850 Middle Channel

30MHz~10GHz:

| Suspected List | | | | | | | |
|----------------|-------------|---------------|-------------|-------------|-------------|-------------|------------|
| NO. | Freq. [MHz] | Reading [dBm] | Level [dBm] | Limit [dBm] | Margin [dB] | Factor [dB] | Polarity |
| 1 | 36.7934 | -88.47 | -64.11 | -13.00 | 51.11 | 24.36 | Horizontal |
| 2 | 74.6423 | -94.49 | -73.24 | -13.00 | 60.24 | 21.25 | Horizontal |
| 3 | 175.087 | -100.71 | -76.59 | -13.00 | 63.59 | 24.12 | Horizontal |
| 4 | 326.968 | -103.23 | -74.30 | -13.00 | 61.30 | 28.93 | Horizontal |
| 5 | 1803.40 | -57.70 | -55.94 | -13.00 | 42.94 | 1.76 | Horizontal |
| 6 | 3990.49 | -58.59 | -49.76 | -13.00 | 36.76 | 8.83 | Horizontal |
| Suspected List | | | | | | | |
| NO. | Freq. [MHz] | Reading [dBm] | Level [dBm] | Limit [dBm] | Margin [dB] | Factor [dB] | Polarity |
| 1 | 36.7934 | -87.30 | -64.70 | -13.00 | 51.70 | 22.60 | Vertical |
| 2 | 66.3932 | -92.25 | -69.51 | -13.00 | 56.51 | 22.74 | Vertical |
| 3 | 272.136 | -103.77 | -77.46 | -13.00 | 64.46 | 26.31 | Vertical |
| 4 | 519.124 | -103.14 | -71.01 | -13.00 | 58.01 | 32.13 | Vertical |
| 5 | 3180.09 | -59.10 | -50.00 | -13.00 | 37.00 | 9.10 | Vertical |
| 6 | 6309.15 | -59.95 | -44.87 | -13.00 | 31.87 | 15.08 | Vertical |



Worst-Case test data provide as below:

GSM1900 Middle Channel

30MHz~20GHz:

| Suspected List | | | | | | | |
|----------------|-------------|---------------|-------------|-------------|-------------|-------------|------------|
| NO. | Freq. [MHz] | Reading [dBm] | Level [dBm] | Limit [dBm] | Margin [dB] | Factor [dB] | Polarity |
| 1 | 36.7934 | -87.38 | -65.73 | -13.00 | 52.73 | 21.65 | Horizontal |
| 2 | 74.1571 | -89.00 | -70.62 | -13.00 | 57.62 | 18.38 | Horizontal |
| 3 | 175.572 | -99.59 | -78.68 | -13.00 | 65.68 | 20.91 | Horizontal |
| 4 | 881.600 | -97.18 | -63.64 | -13.00 | 50.64 | 33.54 | Horizontal |
| 5 | 2904.95 | -58.16 | -50.10 | -13.00 | 37.10 | 8.06 | Horizontal |
| 6 | 5783.89 | -59.65 | -47.33 | -13.00 | 34.33 | 12.32 | Horizontal |
| Suspected List | | | | | | | |
| NO. | Freq. [MHz] | Reading [dBm] | Level [dBm] | Limit [dBm] | Margin [dB] | Factor [dB] | Polarity |
| 1 | 36.7934 | -86.13 | -66.24 | -13.00 | 53.24 | 19.89 | Vertical |
| 2 | 70.2751 | -92.82 | -72.52 | -13.00 | 59.52 | 20.30 | Vertical |
| 3 | 175.572 | -99.93 | -81.33 | -13.00 | 68.33 | 18.60 | Vertical |
| 4 | 519.609 | -103.96 | -75.59 | -13.00 | 62.59 | 28.37 | Vertical |
| 5 | 882.086 | -96.41 | -63.31 | -13.00 | 50.31 | 33.10 | Vertical |
| 6 | 5633.81 | -51.73 | -39.10 | -13.00 | 26.10 | 12.63 | Vertical |



Worst-Case test data provide as below:

WCDMA 850 Middle Channel

30MHz~10GHz:

| Suspected List | | | | | | | |
|----------------|-------------|---------------|-------------|-------------|-------------|-------------|------------|
| NO. | Freq. [MHz] | Reading [dBm] | Level [dBm] | Limit [dBm] | Margin [dB] | Factor [dB] | Polarity |
| 1 | 36.7934 | -88.38 | -64.02 | -13.00 | 51.02 | 24.36 | Horizontal |
| 2 | 73.6718 | -92.98 | -71.72 | -13.00 | 58.72 | 21.26 | Horizontal |
| 3 | 127.048 | -92.91 | -70.73 | -13.00 | 57.73 | 22.18 | Horizontal |
| 4 | 215.847 | -96.16 | -71.53 | -13.00 | 58.53 | 24.63 | Horizontal |
| 5 | 1799.39 | -57.62 | -55.79 | -13.00 | 42.79 | 1.83 | Horizontal |
| 6 | 4898.44 | -60.30 | -49.78 | -13.00 | 36.78 | 10.52 | Horizontal |
| Suspected List | | | | | | | |
| NO. | Freq. [MHz] | Reading [dBm] | Level [dBm] | Limit [dBm] | Margin [dB] | Factor [dB] | Polarity |
| 1 | 36.7934 | -87.92 | -65.32 | -13.00 | 52.32 | 22.60 | Vertical |
| 2 | 74.1571 | -92.96 | -69.38 | -13.00 | 56.38 | 23.58 | Vertical |
| 3 | 127.048 | -93.01 | -69.05 | -13.00 | 56.05 | 23.96 | Vertical |
| 4 | 216.333 | -95.58 | -72.33 | -13.00 | 59.33 | 23.25 | Vertical |
| 5 | 1791.39 | -57.22 | -56.36 | -13.00 | 43.36 | 0.86 | Vertical |
| 6 | 5116.05 | -58.85 | -44.95 | -13.00 | 31.95 | 13.90 | Vertical |



Worst-Case test data provide as below:

WCDMA 1900 Middle Channel

30MHz~20GHz:

| Suspected List | | | | | | | |
|----------------|-------------|---------------|-------------|-------------|-------------|-------------|------------|
| NO. | Freq. [MHz] | Reading [dBm] | Level [dBm] | Limit [dBm] | Margin [dB] | Factor [dB] | Polarity |
| 1 | 36.7934 | -86.26 | -64.61 | -13.00 | 51.61 | 21.65 | Horizontal |
| 2 | 72.7014 | -94.80 | -76.40 | -13.00 | 63.40 | 18.40 | Horizontal |
| 3 | 209.054 | -100.85 | -79.25 | -13.00 | 66.25 | 21.60 | Horizontal |
| 4 | 655.963 | -105.52 | -73.58 | -13.00 | 60.58 | 31.94 | Horizontal |
| 5 | 2739.86 | -57.47 | -50.18 | -13.00 | 37.18 | 7.29 | Horizontal |
| 6 | 6181.59 | -59.39 | -45.27 | -13.00 | 32.27 | 14.12 | Horizontal |
| Suspected List | | | | | | | |
| NO. | Freq. [MHz] | Reading [dBm] | Level [dBm] | Limit [dBm] | Margin [dB] | Factor [dB] | Polarity |
| 1 | 36.7934 | -87.47 | -67.58 | -13.00 | 54.58 | 19.89 | Vertical |
| 2 | 74.6423 | -95.30 | -74.55 | -13.00 | 61.55 | 20.75 | Vertical |
| 3 | 208.084 | -101.54 | -82.30 | -13.00 | 69.30 | 19.24 | Vertical |
| 4 | 521.550 | -104.52 | -76.11 | -13.00 | 63.11 | 28.41 | Vertical |
| 5 | 2687.84 | -58.00 | -49.77 | -13.00 | 36.77 | 8.23 | Vertical |
| 6 | 4913.45 | -58.66 | -45.78 | -13.00 | 32.78 | 12.88 | Vertical |



Worst-Case test data provide as below:

WCDMA 1700 Middle Channel

30MHz~20GHz:

| Suspected List | | | | | | | |
|----------------|-------------|---------------|-------------|-------------|-------------|-------------|------------|
| NO. | Freq. [MHz] | Reading [dBm] | Level [dBm] | Limit [dBm] | Margin [dB] | Factor [dB] | Polarity |
| 1 | 36.7934 | -87.14 | -67.25 | -13.00 | 54.25 | 19.89 | Vertical |
| 2 | 74.1571 | -88.41 | -67.71 | -13.00 | 54.71 | 20.70 | Vertical |
| 3 | 214.392 | -95.73 | -75.94 | -13.00 | 62.94 | 19.79 | Vertical |
| 4 | 555.032 | -104.38 | -75.48 | -13.00 | 62.48 | 28.90 | Vertical |
| 5 | 2725.86 | -58.43 | -50.51 | -13.00 | 37.51 | 7.92 | Vertical |
| 6 | 7172.08 | -59.98 | -43.42 | -13.00 | 30.42 | 16.56 | Vertical |
| Suspected List | | | | | | | |
| NO. | Freq. [MHz] | Reading [dBm] | Level [dBm] | Limit [dBm] | Margin [dB] | Factor [dB] | Polarity |
| 1 | 36.7934 | -86.63 | -64.98 | -13.00 | 51.98 | 21.65 | Horizontal |
| 2 | 127.533 | -92.54 | -73.50 | -13.00 | 60.50 | 19.04 | Horizontal |
| 3 | 213.421 | -95.48 | -74.05 | -13.00 | 61.05 | 21.43 | Horizontal |
| 4 | 523.977 | -104.12 | -74.47 | -13.00 | 61.47 | 29.65 | Horizontal |
| 5 | 3202.60 | -59.26 | -50.09 | -13.00 | 37.09 | 9.17 | Horizontal |
| 6 | 7202.10 | -61.07 | -44.07 | -13.00 | 31.07 | 17.00 | Horizontal |



3. LIST OF MEASURING EQUIPMENT

| Description | Manufacturer | Model | Serial No. | Cal. Date | Due Date | Remark |
|--|---------------|--------------|------------|------------|------------|-----------|
| EMI Test Receiver | R&S | ESIB7 | A0501375 | 2019.07.30 | 2020.07.29 | Radiation |
| Loop Antenna | Schwarz beck | HFH2-Z2 | 100047 | 2019.04.26 | 2022.04.25 | Radiation |
| Broadband antenna (30MHz~1GHz) | R&S | HL562 | 101341 | 2017.07.14 | 2020.07.13 | Radiation |
| Broadband antenna (30MHz~1GHz) | R&S | HL562 | 101339 | 2017.07.14 | 2020.07.13 | Radiation |
| Double ridge horn antenna (1GHz~18GHz) | R&S | HF906 | 100150 | 2019.04.27 | 2022.04.26 | Radiation |
| Double ridge horn antenna (1GHz~18GHz) | R&S | HF906 | 100149 | 2019.04.17 | 2022.04.16 | Radiation |
| Horn antenna (18GHz~26.5GHz) | AR | AT4002A | 305753 | 2017.07.12 | 2020.07.11 | Radiation |
| Horn antenna (18GHz~26.5GHz) | AR | AT4003A | 0329293 | 2018.09.17 | 2020.09.16 | Radiation |
| Amplifier 1GHz-18GHz | AR | 25S1G4AM1 | 22018 | 2018.09.17 | 2020.09.16 | Radiation |
| Amplifier 20M~3GHz | MILMEGA | 80RF1000-250 | 1064573 | 2017.10.09 | 2020.10.08 | Radiation |
| Spectrum Analyzer | KEYSIGHT | N9030A | A160702554 | 2020.05.18 | 2021.05.17 | Conducted |
| Test Receiver | R&S | ESCI | A0902601 | 2019.07.02 | 2020.07.01 | Conducted |
| Temperature chamber | welissom Inc. | SU-642 | A150802409 | 2019.07.18 | 2020.07.17 | Conducted |
| Wideband Radio Communication tester | R&S | CMW500 | A130101034 | 2019.07.30 | 2021.07.29 | Conducted |
| Power Supply | R&S | NGMO1 | 101037 | 2019.08.03 | 2020.08.02 | Conducted |



4. UNCERTAINTY OF EVALUATION

The measurement uncertainties shown below were calculated in accordance with the requirements of ANSI C63.10-2013. All the measurement uncertainty value were shown with a coverage $K=2$ to indicate 95% level of confidence . The measurement data show herein meets or exceeds the CISPR measurement uncertainty values specified in CISPR 16-4-2 and can be compared directly to specified limit to determine compliance.

Uncertainty of Conducted Emission Measurement (150KHz~30MHz)

| | |
|---|-------|
| Measuring Uncertainty for a level of confidence of 95%($U=2U_c(y)$) | 2.6dB |
|---|-------|

Uncertainty of Radiated Emission Measurement (30MHz~1GHz)

| | |
|---|-------|
| Measuring Uncertainty for a level of confidence of 95%($U=2U_c(y)$) | 2.4dB |
|---|-------|

Uncertainty of Radiated Emission Measurement (1GHz~40GHz)

| | |
|---|-------|
| Measuring Uncertainty for a level of confidence of 95%($U=2U_c(y)$) | 2.8dB |
|---|-------|

** END OF REPORT **