



Certificate Number: 5055.02

TEST REPORT

Report No.: SRTC2022-9003(F)-0057
Product Name: LTE/WCDMA/GSM(GPRS) Multi-Mode Digital
Mobile Phone
Model Name: ZTE Blade A53
Applicant: ZTE Corporation
Manufacturer: ZTE Corporation
Specification: FCC Part15B (Certification)
(2022 edition)
FCC ID: SRQ-ZTEA53-1

The State Radio_monitoring_center Testing Center (SRTC)

15th Building, No.30 Shixing Street, Shijingshan District,

Beijing, China

Tel: 86-10-57996183 Fax: 86-10-57996388

CONTENTS

1. General information	3
1.1 Notes of the test report	3
1.2 Information about the testing laboratory.....	3
1.3 Applicant's details	3
1.4 Manufacturer's details.....	3
1.5 Application details	4
1.6 Reference specification.....	4
1.7 Information of EUT.....	4
1.7.1 General information.....	4
1.7.2EUT details	5
1.7.3 Auxiliary equipment details.....	5
2. Test information	7
2.1 Summary of the test results	7
2.2 Test result.....	8
2.2.1Conducted Emissions-FCC Part15.107	8
2.2.2RadiatedEmissions-FCC Part15.109.....	14
2.3. List of test equipments	20

1. General information

1.1 Notes of the test report

The test report may only be reproduced or published in full. Reproduction or publication of extracts from the report requires the prior written permission of The State Radio_monitoring_center Testing Center (SRTC).

The test results relate only to individual items of the samples which have been tested.

1.2 Information about the testing laboratory

Company: The State Radio_monitoring_center Testing Center (SRTC)
Address: 15th Building, No.30 Shixing Street, Shijingshan District
Testing location: No.80, Zhaojiachang, BeizangCun, Daxing District, Beijing, China.
City: Beijing
Country or Region: China
Contacted person: Liu Jia
Tel: +86 10 57996183
Fax: +86 10 57996388
Email: liujiaf@srtc.org.cn

1.3 Applicant's details

Company: ZTECorporation.
Address: ZTE Plaza, #55 Keji Road South, Hi-Tech, Industrial Park, Nanshan District,Shenzhen, Guangdong, 518057, P.R.China
City: Shenzhen
Country or Region: P.R.China

1.4 Manufacturer's details

Company: ZTECorporation.
Address: ZTE Plaza, #55 Keji Road South, Hi-Tech, Industrial Park, Nanshan District,Shenzhen, Guangdong, 518057, P.R.China
City: Shenzhen
Country or Region: P.R.China

1.5 Application details

Date of reception of test sample: 10th October 2022

Date of test: 10th October 2022 to 21th October 2022

1.6 Reference specification

FCC Part 15B, 2022 (Certification)

1.7 Information of EUT

1.7.1 General information

Name of EUT	LTE/WCDMA/GSM(GPRS) Multi-Mode Digital Mobile Phone
Model Name	ZTE Blade A53
Marketing Name	N/A
FCC ID	SRQ-ZTEA53-1
Frequency Range	GSM: GSM850 / PCS1900 WCDMA: FDD II / FDD IV / FDD V LTE: FDD 2/ FDD 4/ FDD 5/ FDD 7/ FDD 12/ FDD 13/ FDD 17/FDD 28/ FDD 66/ TDD 38/ TDD 40 Bluetooth: 2.4~2.4835GHz WiFi: 2.412GHz~2.472GHz
Equipment Class	Class B
Power Supply	Battery or Charger
Extreme Temperature	Lowest: -20°C Highest: +60°C
HW Version	ZTE Blade A53HW1.0
SW Version	12.0_A53_TEL

1.7.2 EUT details

Product Name	Model Name	IMEI
LTE/WCDMA/GSM(GPRS) Multi-Mode Digital Mobile Phone	ZTE Blade A53	860081060000071/860081060000220

1.7.3 Auxiliary equipment details

AE (Auxiliary Equipment) 1#: Laptop

Manufacturer	Lenovo
Model Number	E470c
S/N	PF10VBX6
Input Voltage	100V-240V AC

AE (Auxiliary Equipment) 2#: USB Cable1

Manufacturer	Dongguan Yuwei Electronic Technology Co., Ltd.
Model Number	CH2211MK

AE (Auxiliary Equipment) 3#: USB Cable2

Manufacturer	Huizhou Juwei Electronics Co., Ltd.
Model Number	JWUB1531-H21H

AE (Auxiliary Equipment) 4#: Battery1

Type	Li-Lon battery
Manufacturer	TBM Battery Co. Ltd.
Model Number	E6539ZTE-B

AE (Auxiliary Equipment) 5#: Battery2

Type	Li-Lon battery
Manufacturer	Guangdong Fenghua New Energy Co.,Ltd.
Model Number	E6539ZTE-B

AE (Auxiliary Equipment) 6#: Charger1

Manufacturer	SHENZHEN RUIJING INDUSTRIAL CO.,LTD
Model Number	STC-A520A-Z

S/N	/
Input Voltage	100V-240V AC
Output Voltage	5VDC 2A

AE (Auxiliary Equipment) 7#: Charger2

Manufacturer	SHENZHEN RUIDE ELECTRONIC INDUSTRIAL CO.,LTD
Model Number	RD0502000-228MG
S/N	/
Input Voltage	100V-240V AC
Output Voltage	5VDC 2A

AE (Auxiliary Equipment) 8#: Headset1

Type	/
Manufacturer	Huizhou Juwei Electronics Co., Ltd.
Model Number	JWEP1036-Z01R

AE (Auxiliary Equipment) 9#: Headset2

Type	/
Manufacturer	Huizhou Juwei Electronics Co., Ltd.
Model Number	JWEP1091-Z01

Note1: As the information described in these above tables, the relevant tests have been performed in order to verify in which supply would have the worst features. When the EUT exercised with 2# USB Cable1, 4# Battery1, 7# Charger2, 8# Headset 1 is the worst feature, and record the results in the test report.

Note2: AE1# Laptop was selected by testing laboratory and was only cooperated with this test, not for sale.

2. Test information

2.1 Summary of the test results

No.	Test case	FCC reference	Verdict
1	Conducted emissions	15.107	Pass
2	Radiated emissions	15.109	Pass

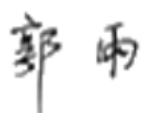
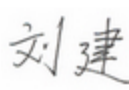
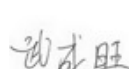
Approved By: Mr. Guo Yu Vice director of the test department 	Checked By: Mr. Liu Jian 
Tested By: Mr. Wu Chengwang 	Issued date: 2022.10.21

2.2 Test result

2.2.1 Conducted Emissions-FCC Part15.107

Ambient condition:

Temperature	Relative humidity	Pressure
21.9°C	40.2%	100.8kPa

Test Setup with laptop:

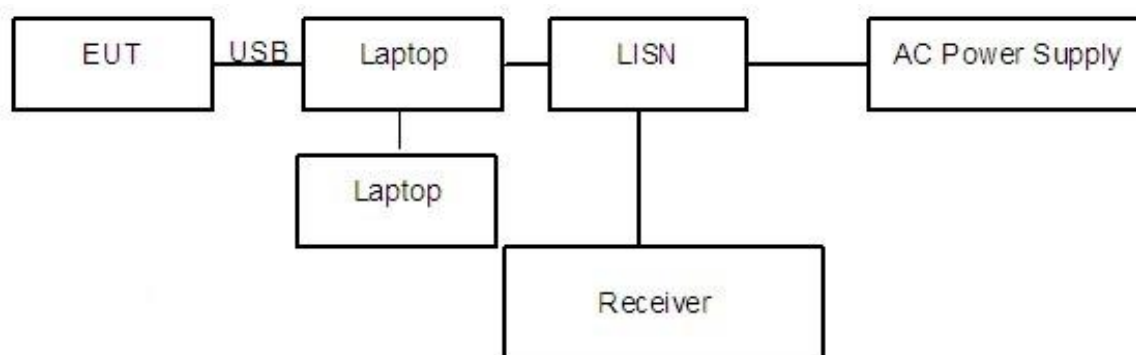

Figure 1

Test Procedure:

The EUT is placed on a non-metallic table 0.8m above the horizontal metal reference ground plane. The accessories of the EUT are connected with the EUT such as headset etc. The EUT was connected with a laptop via the USB cable and transferred the data by copying large files from laptop to the EUT. The laptop's LAN port is connected with another laptop via cable. And the data transferring between two laptops is maintained.

The AC main power supply of the laptop is connected to LISN and LISN is connected to the reference ground. The test set-up and the test methods are performed according to ANSI C63.4:2014.

Then start the test software EMC32. Sweep the whole frequency band through the range from 150 KHz to 30 MHz with RBW 9kHz, VBW 30kHz. The measurement should be done for both L line and N line. During pre-test, the receiver uses both peak detector and average detector. And the final test, the receiver uses both average detector and Quasi-peak detector.

The data of cable loss has been calibrated in full testing frequency range before the testing.

Test Setup with charger:

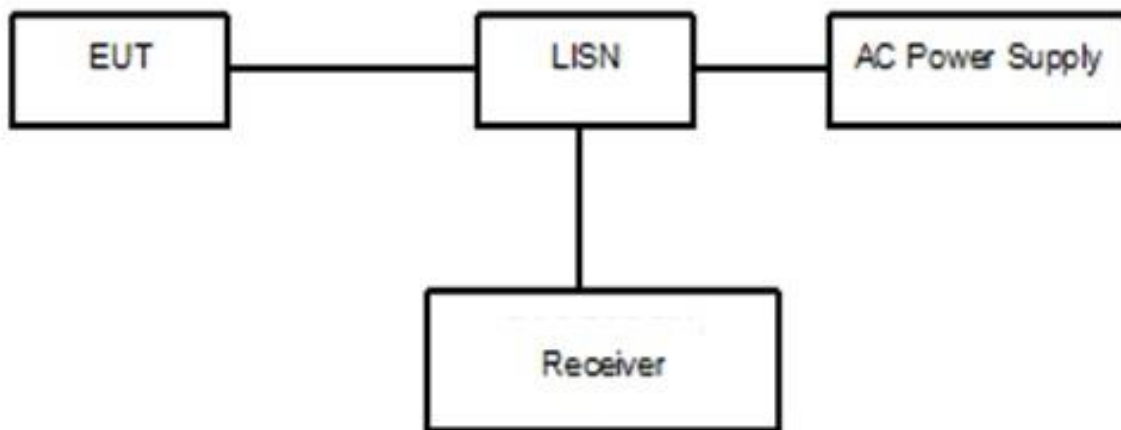

Figure 2

Test Procedure:

The EUT is placed on a non-metallic table 0.8m above the horizontal metal reference ground plane. The EUT is connected with LISN via the charger. The LISN is connected to the reference ground. The accessories of the EUT are connected with the EUT such as headset etc. Open the following functions of EUT: FM, GPS, Camera and video.

The test set-up and the test methods are performed according to ANSI C63.4:2014. Then start the test software EMC32. Sweep the whole frequency band through the range from 150 KHz to 30 MHz with RBW 9kHz, VBW 30kHz. The measurement should be done for both L line and N line. During pre-test, the receiver uses both peak detector and average detector. And the final test, the receiver uses both average detector and Quasi-peak detector.

The data of cable loss has been calibrated in full testing frequency range before the testing.

A "reference path loss" Corr.(dB) is established and the $L_{cable}+ATT+VDF$ is the attenuation of "reference path loss", and including the cable loss, the attenuation of the attenuator, the voltage division factor of AMN.

The measurement results are obtained as described below:

$$P_{result}=P_{mea}+ Corr.(dB)$$

Sample calculation: $(32.70 \text{ dB}\mu\text{V}) = (3 \text{ dB}\mu\text{V}) + (29.7 \text{ dB})$, the corresponding frequency is 0.150000MHz.

Limit:

Frequency of Emission(MHz)	Limits(dB μ V)	
	Quasi-peak	Average
0.15~0.5	66 to 56*	56 to 46*
0.5~5	56	46
5~30	60	50

Note: * Decreases with the logarithm of the frequency

Test result:

Noise Level of the Measuring Instrument

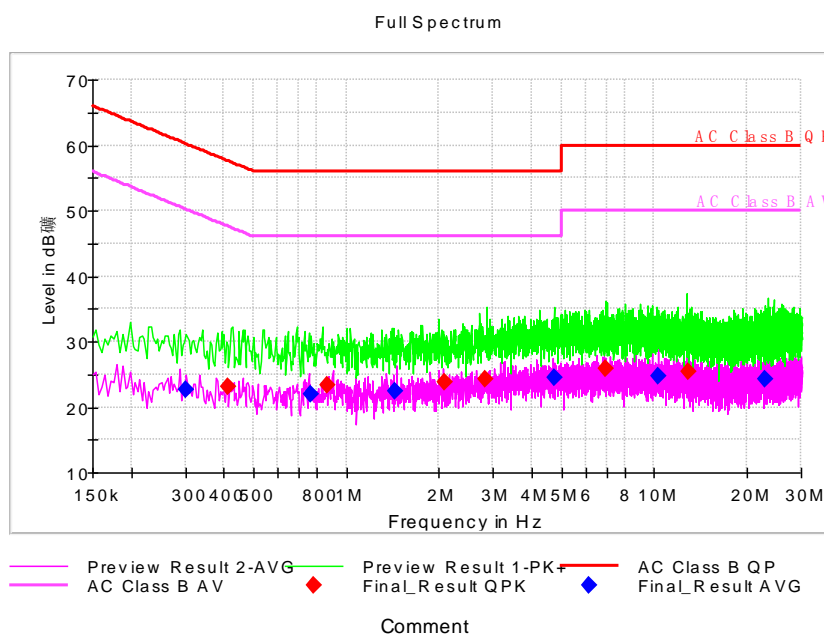

Pic1. Conducted emission L and N Line

120VAC:

EUT + 2#USB Cable1+4#Battery1+7#Charger2+8#Headset1:

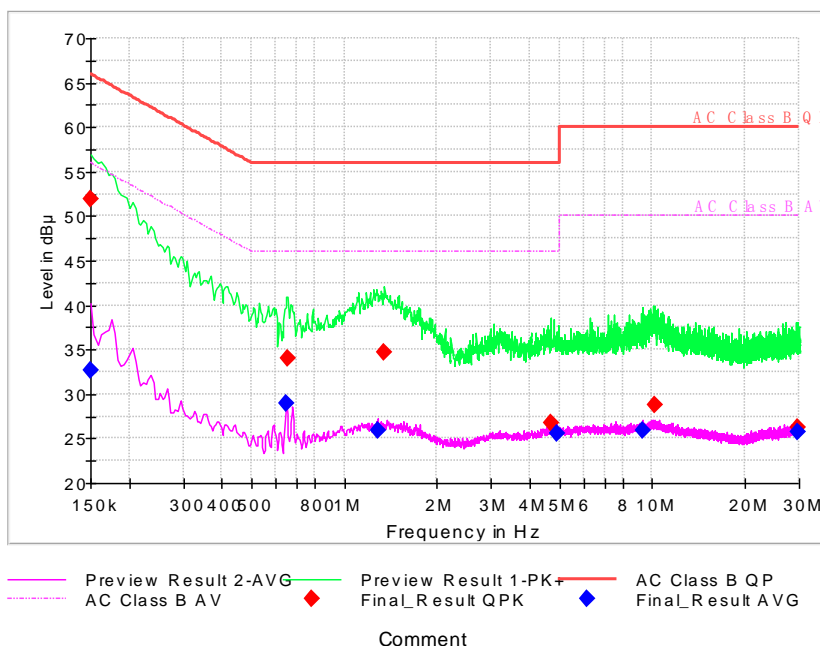

Pic2. Conducted emission L&N Line

Frequency (MHz)	QuasiPeak (dBµV)	Average (dBµV)	Limit (dBµV)	Margin (dB)	Line	Corr. (dB)	Pmea QuasiPeak (dBµV)	Pmea Average (dBµV)
0.150000	---	32.70	56.00	23.30	N	29.7	---	3
0.150000	51.98	---	66.00	14.02	N	29.7	22.28	---
0.648921	---	29.02	46.00	16.98	N	29.7	---	-0.68
0.657450	34.05	---	56.00	21.95	N	29.7	4.35	---
1.284300	---	25.99	46.00	20.01	N	29.8	---	-3.81
1.352529	34.62	---	56.00	21.38	N	29.8	4.82	---
4.678671	26.78	---	56.00	29.22	N	29.8	-3.02	---
4.891886	---	25.49	46.00	20.51	L1	29.9	---	-4.41
9.352329	---	25.93	50.00	24.07	N	29.9	---	-3.97
10.205186	28.83	---	60.00	31.17	N	29.9	-1.07	---
29.505343	---	25.81	50.00	24.19	N	30.0	---	-4.19
29.778257	26.30	---	60.00	33.70	N	30.0	-3.7	---

240VAC:

EUT + 2#USB Cable1+4#Battery1+7#Charger2+8#Headset1:

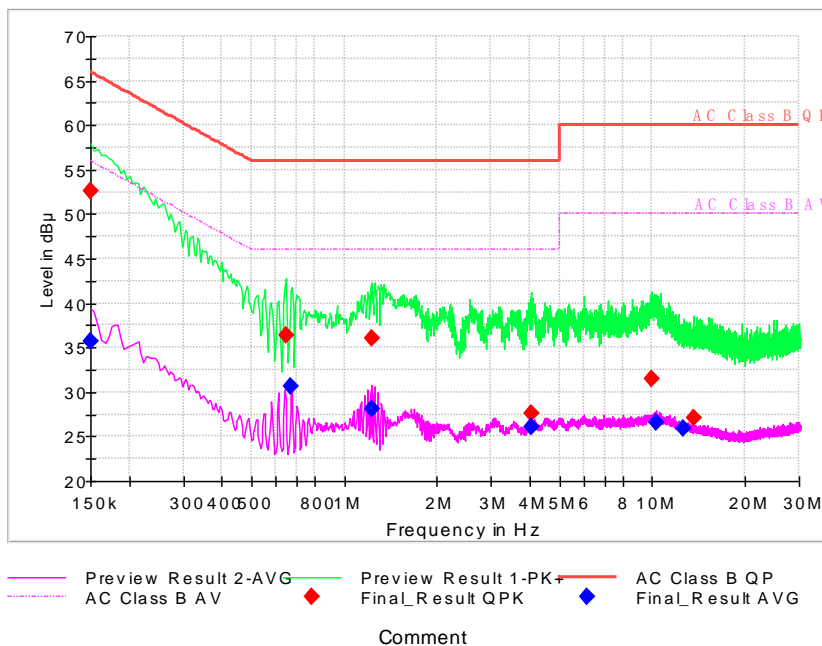

Pic3. Conducted emission L&N Line

Frequency (MHz)	QuasiPeak (dBµV)	Average (dBµV)	Limit (dBµV)	Margin (dB)	Line	Corr. (dB)	Pmea QuasiPeak (dBµV)	Pmea Average (dBµV)
0.150000	52.58	---	66.00	13.42	N	29.7	22.88	---
0.150000	---	35.69	56.00	20.31	L1	29.7	---	5.99
0.644657	36.37	---	56.00	19.63	N	29.7	6.67	---
0.670243	---	30.62	46.00	15.38	L1	29.7	---	0.92
1.224600	36.12	---	56.00	19.88	L1	29.8	6.32	---
1.224600	---	28.06	46.00	17.94	L1	29.8	---	-1.74
4.030500	---	26.04	46.00	19.96	L1	29.8	---	-3.76
4.030500	27.61	---	56.00	28.39	N	29.8	-2.19	---
9.991971	31.52	---	60.00	28.48	N	29.9	1.62	---
10.294736	---	26.54	50.00	23.46	L1	29.9	---	-3.36
12.588921	---	25.86	50.00	24.14	L1	29.9	---	-4.04
13.629407	27.09	---	60.00	32.91	L1	29.9	-2.81	---

EUT + 2#USB Cable1+4#Battery1+8#Headset1+1#Laptop:

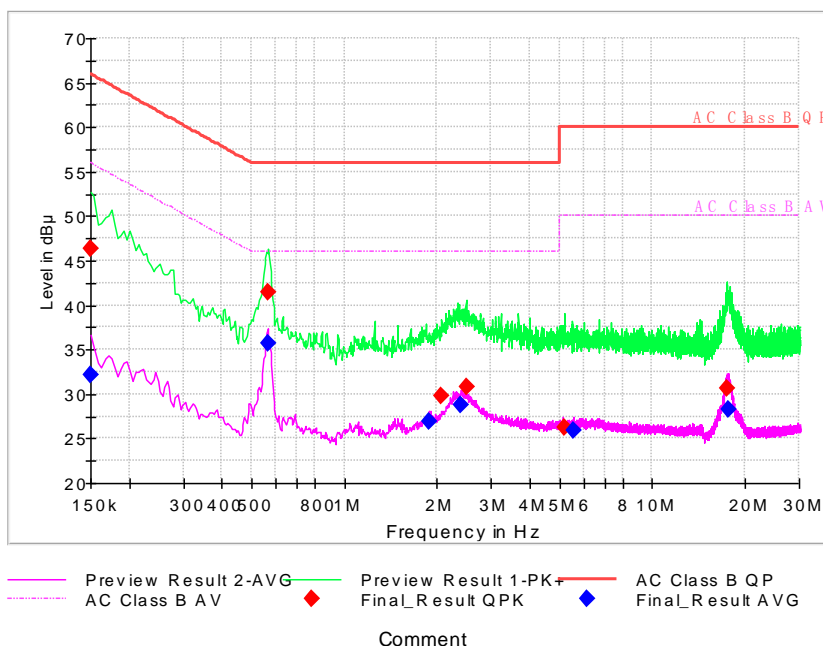

Pic4. Conducted emission L&N Line

Frequency (MHz)	QuasiPeak (dBµV)	Average (dBµV)	Limit (dBµV)	Margin (dB)	Line	Corr. (dB)	Pmea QuasiPeak (dBµV)	Pmea Average (dBµV)
0.150000	---	32.19	56.00	23.81	L1	29.7	---	2.49
0.150000	46.35	---	66.00	19.65	L1	29.7	16.65	---
0.563636	---	35.68	46.00	10.32	L1	29.7	---	5.98
0.567900	41.44	---	56.00	14.56	L1	29.7	11.74	---
1.885564	---	26.87	46.00	19.13	L1	29.8	---	-2.93
2.073193	29.74	---	56.00	26.26	N	29.8	-0.06	---
2.397279	---	28.77	46.00	17.23	N	29.8	---	-1.03
2.486829	30.88	---	56.00	25.12	N	29.8	1.08	---
5.198914	26.17	---	60.00	33.83	N	29.8	-3.63	---
5.535793	---	25.91	50.00	24.09	N	29.8	---	-3.89
17.492850	30.59	---	60.00	29.41	N	29.9	0.69	---
17.663421	---	28.21	50.00	21.79	N	29.9	---	-1.69

2.2.2 Radiated Emissions-FCC Part15.109

Ambient condition:

Temperature	Relative humidity	Pressure
21.5°C	40.3%	100.8kPa

Test Setup:

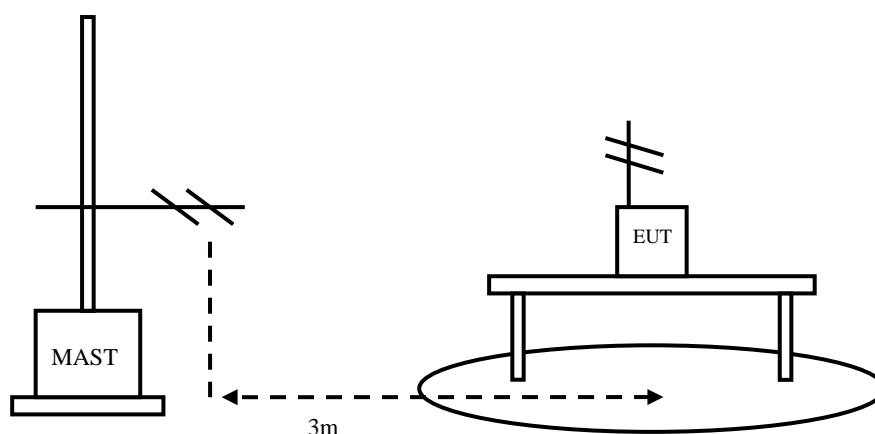

Figure 3

Test Procedure:

EUT+Laptop:

The EUT should be placed on a non-metallic table 80cm above the ground plane. The receive antennas shall be moved from 1 to 4 meters. The distance between EUT and receive antenna should be 3 meters.

The accessories of the EUT are connected with the EUT such as headset etc. The EUT was connected with a laptop via the USB cable and transferred the data by copying large files from laptop to the EUT. The test set-up and the test methods are performed according to ANSI C63.4:2014

Then start the test software EMC32. Sweep the whole frequency band through the range from 30MHz to 1GHz, using receive log period antenna VULB 9163.

During the test, the height of receive antenna shall be moved from 1 to 4 meters, and the antenna shall be performed under horizontal and vertical polarization. The turn table shall be rotated from 0 to 360 degrees for detecting the maximum of radiated spurious signal level. The measurements shall be repeated with orthogonal polarization of the test antenna. The EUT is laid in two modes as follow:
1. put the EUT in horizontal direction; 2. put the EUT in vertical direction.

The data of cable loss and antenna factor have been calibrated in full testing

frequency range before the testing.

EUT+Charger:

The EUT should be placed on a non-metallic table 80cm above the ground plane. The receive antennas shall be moved from 1 to 4 meters. The distance between EUT and receive antenna should be 3 meters.

The accessories of the EUT are connected with the EUT such as headset etc. The EUT should work in idle mode. Open the following functions of EUT: FM, GPS, Camera and video. The test set-up and the test methods are performed according to ANSI C63.4:2014.

Then start the test software EMC32. Sweep the whole frequency band through the range from 30MHz to 1GHz, using receive log period antenna VULB 9163.

During the test, the height of receive antenna shall be moved from 1 to 4 meters, and the antenna shall be performed under horizontal and vertical polarization. The turn table shall be rotated from 0 to 360 degrees for detecting the maximum of radiated spurious signal level. The measurements shall be repeated with orthogonal polarization of the test antenna. The EUT is laid in two modes as follow:
1. put the EUT in horizontal direction; 2. put the EUT in vertical direction.

The data of cable loss and antenna factor have been calibrated in full testing frequency range before the testing. All test results are performed with max hold at the horizontal and vertical polarity.

RBW=120kHz, VBW=300kHz, when the test frequency: 30MHz<f<1GHz

RBW=1MHz, VBW=3MHz, when the test frequency: f>1GHz

A “reference path loss” is established and the A_{Rpl} is the attenuation of “reference path loss”, and including the gain of receive antenna, the gain of the preamplifier, the cable loss.

The measurement results are obtained as described below:

$$\text{Result} = P_{\text{mea}} + A_{Rpl}$$

Limit:

Frequency of Emission(MHz)	Limits	
	Detector	Unit (dB μ V/m)
30~88	Quasi-peak	40
88~216	Quasi-peak	43.5
216~960	Quasi-peak	46
960~1000	Quasi-peak	54
1000~5th harmonic of the highest frequency or 40GHz, whichever is lower	Average	54
	Peak	74

Test result:

Sample calculation: $(7.04 \text{ dB}\mu \text{ V/m}) = (24.74 \text{ dB}\mu \text{ V/m}) + (-17.7 \text{ dB})$, the corresponding frequency is 51.633000MHz.

EUT + 2#USB Cable1+4#Battery1+8#Headset1+Laptop:

Frequency(MHz)	Result(dB μ V/m)	Limit (dB μ V/m)	ARpl (dB)	Pmea (dB μ V/m)	Polarity
51.633000	7.04	40.00	-17.7	24.74	V
55.653500	4.36	40.00	-23.9	22.66	V
167.984500	22.57	43.50	-21.0	44.37	V
269.976000	25.55	46.00	-18.5	42.25	V
503.991500	31.55	46.00	-10.6	42.25	V
647.986500	29.34	46.00	-2.7	37.04	V

EUT +2#USB Cable1+4#Battery1+7#Charger2+8#Headset1:

Frequency(MHz)	Result(dB μ V/m)	Limit (dB μ V/m)	ARpl (dB)	Pmea (dB μ V/m)	Polarity
47.945000	22.64	40.00	-17.7	40.34	V
96.396500	26.37	43.50	-19.9	46.27	V
98.336500	29.68	43.50	-19.4	49.08	V
195.288000	32.24	43.50	-19.4	51.64	V
555.012500	16.05	46.00	-9.6	25.65	V
953.246000	21.31	46.00	-2.7	24.01	V

EUT + 2#USB Cable1+4#Battery1+8#Headset1+Laptop: refer to Pic5, Pic6, Pic7

Full Spectrum

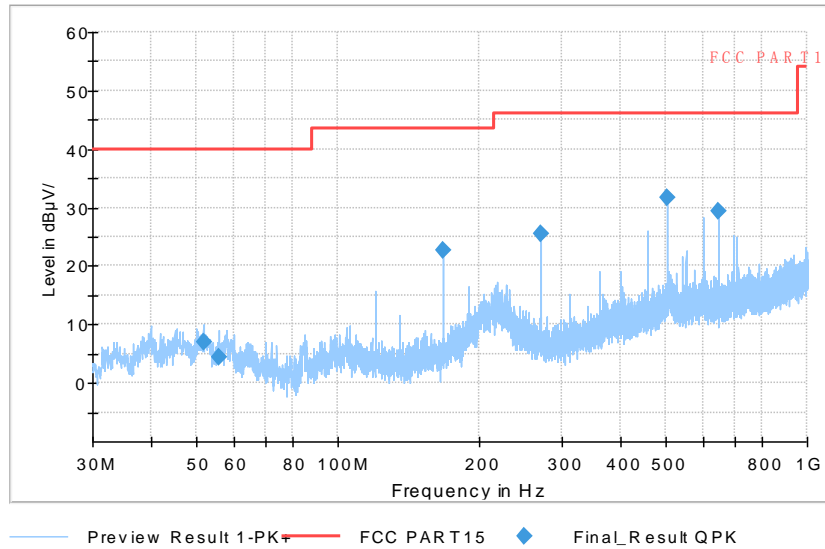

Comment

Pic5. Radiated emission(30MHz – 1GHz)

Note: The test data in the graph includes two polarizations: horizontal and vertical

Full Spectrum

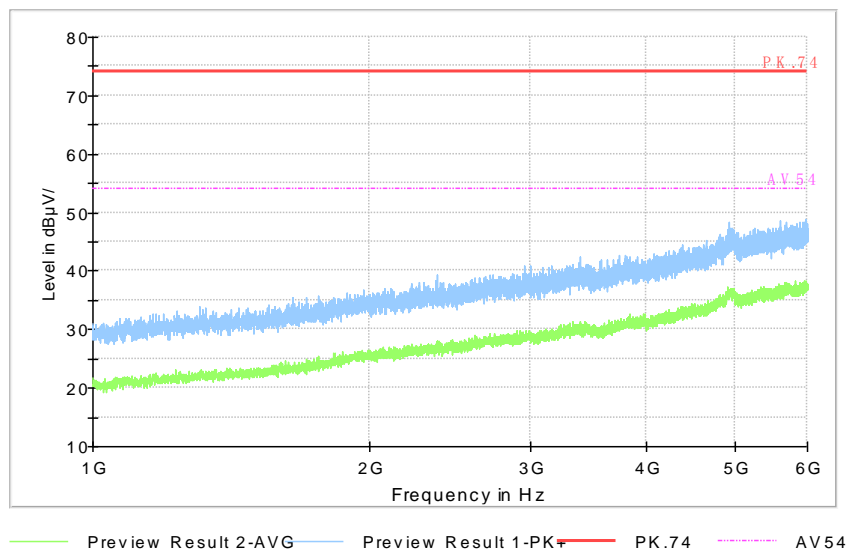

Comment

Pic6. Radiated emission (1GHz –6GHz)

Note: The test data in the graph includes two polarizations: horizontal and vertical.

Full Spectrum

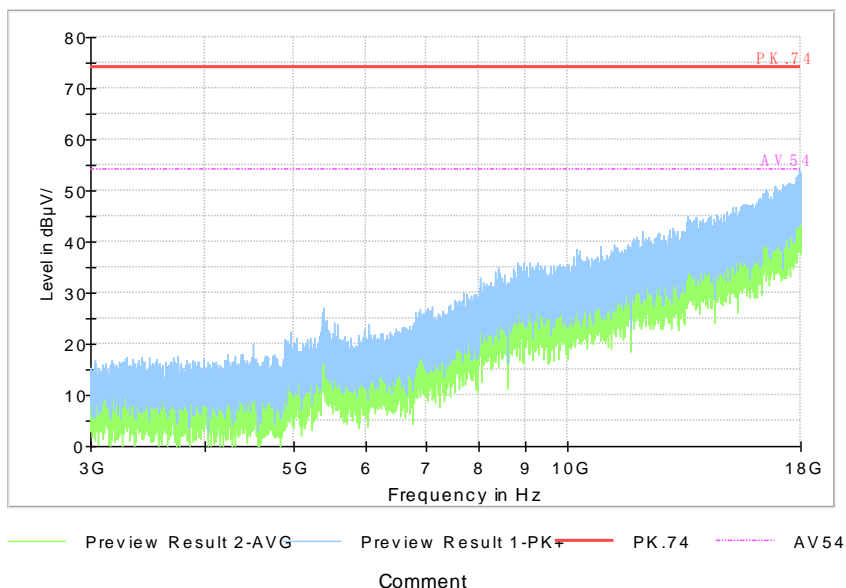

Comment

Pic7. Radiated emission (6GHz –18GHz)

Note: The test data in the graph includes two polarizations: horizontal and vertical.

EUT +2#USB Cable1+4#Battery1+7#Charger2+8#Headset1: refer to Pic8, Pic9, Pic10

Full Spectrum

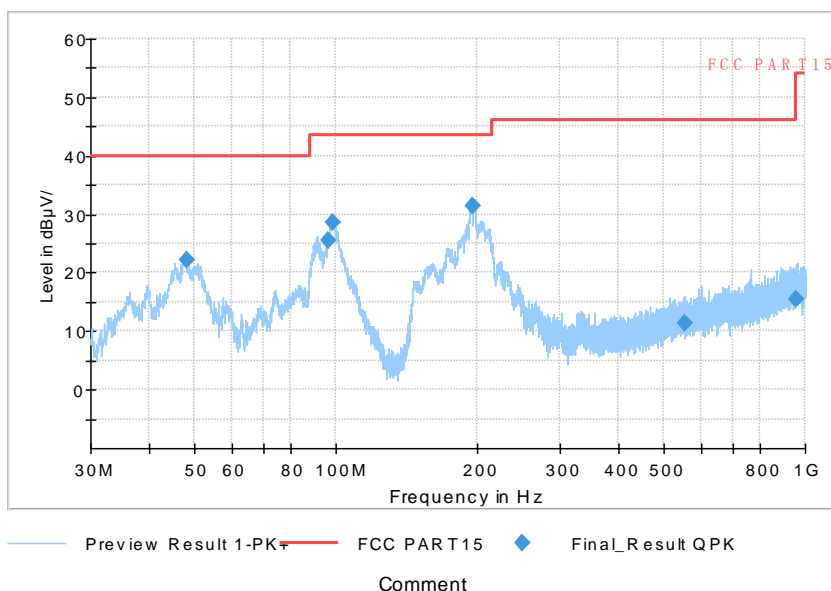

Comment

Pic8. Radiated emission (30MHz – 1GHz)

Note: The test data in the graph includes two polarizations: horizontal and vertical

Full Spectrum

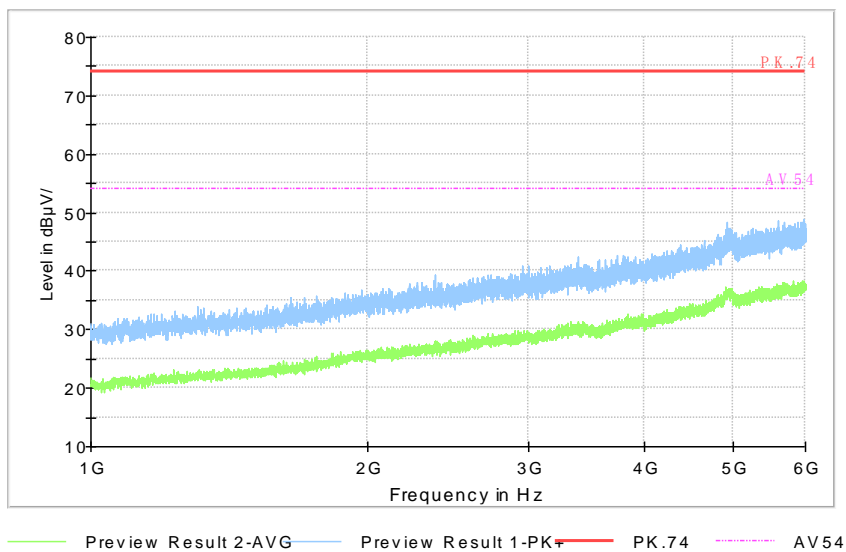

Comment

Pic9. Radiated emission (1GHz –6GHz)

Note: The test data in the graph includes two polarizations: horizontal and vertical.

Full Spectrum

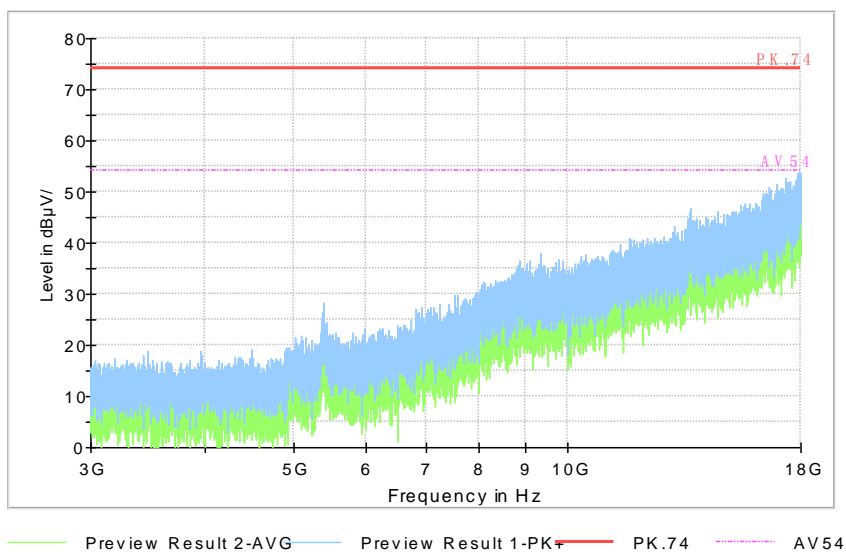

Comment

Pic10. Radiated emission (6GHz –18GHz)

Note: The test data in the graph includes two polarizations: horizontal and vertical.

2.3. List of test equipments

No.	Name/Model	Manufacturer	S/N	Calibration Due Date	Calibration Date
1	23.18m×16.88m×9.60mS emi-AnechoicChamber	FRANKONIA	-----	2023.11.15	2018.11.16
2	ESW EMI test receiver	R&S	101574	2023.06.19	2022.06.20
3	ESR3 EMI test receiver	R&S	102361	2023.04.11	2022.04.12
4	9.080m×5.255m×3.525m Shielding room	FRANKONIA	-----	2025.03.24	2022.03.25
5	VULB 9163 Ultra log test antenna	schwarzbeck	867	2023.05.28	2021.05.29
6	HF 907 Double-Ridged Waveguide Horn Antenna	R&S	100512	2023.05.12	2021.05.13
7	SAS-574 Horn Antenna	schwarzbeck	535	2023.06.19	2021.06.20
8	ENV216 AMN	R&S	3560.6550. 12	2023.06.19	2022.06.20
9	EMC32EMI test software	R&S	-----	-----	-----

-----The End-----