



Add: No.52 HuaYuanBei Road, Haidian District, Beijing, 100191, China  
 Tel: +86-10-62304633-2512 Fax: +86-10-62304633-2504  
 E-mail: cttl@chinattl.com [Http://www.chinattl.cn](http://www.chinattl.cn)

### Receiving Pattern ( $\Phi$ ), $\theta=0^\circ$

f=600 MHz, TEM

f=1800 MHz, R22

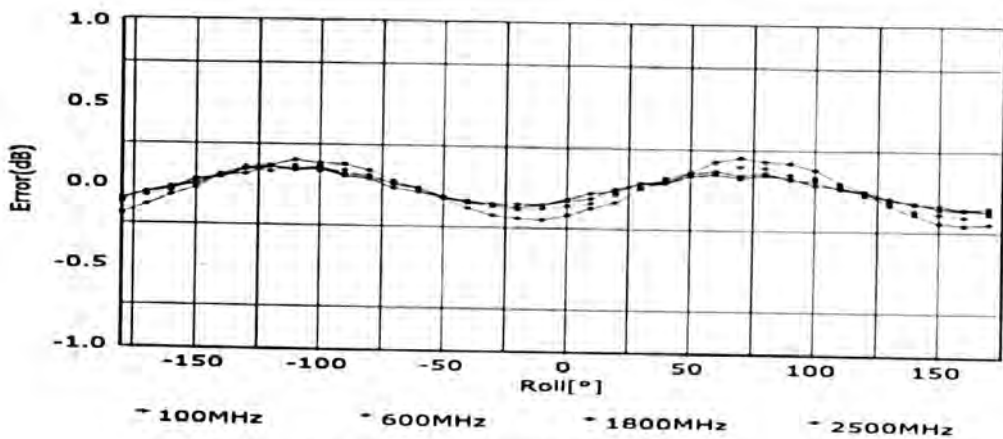
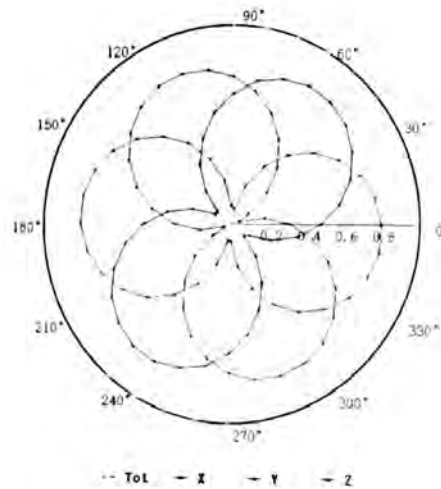
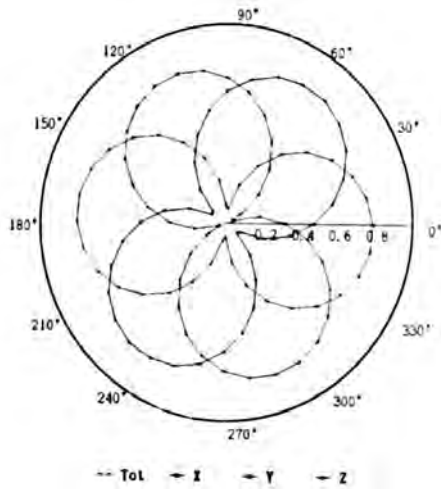

Uncertainty of Axial Isotropy Assessment:  $\pm 1.2\%$  ( $k=2$ )

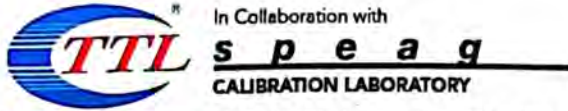

Add: No.52 HuaYuanBei Road, Haidian District, Beijing, 100191, China  
 Tel: +86-10-62304633-2512 Fax: +86-10-62304633-2504  
 E-mail: cttl@chinattl.com Http://www.chinattl.cn

### Dynamic Range f(SAR<sub>head</sub>) (TEM cell, f = 900 MHz)

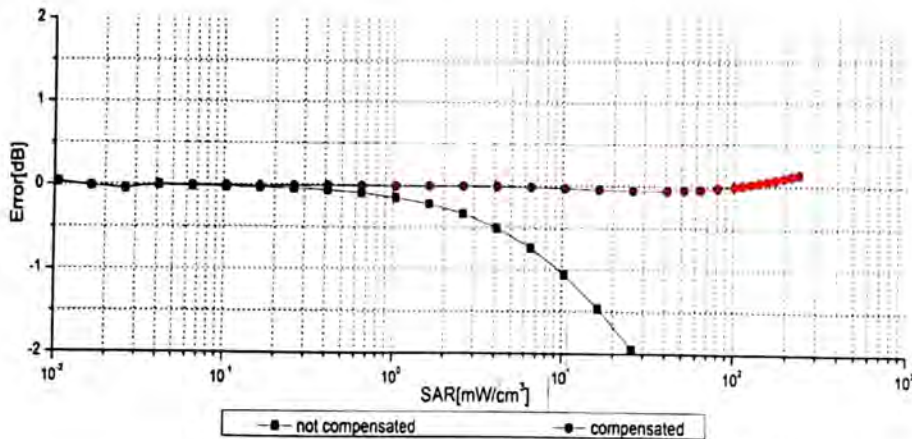
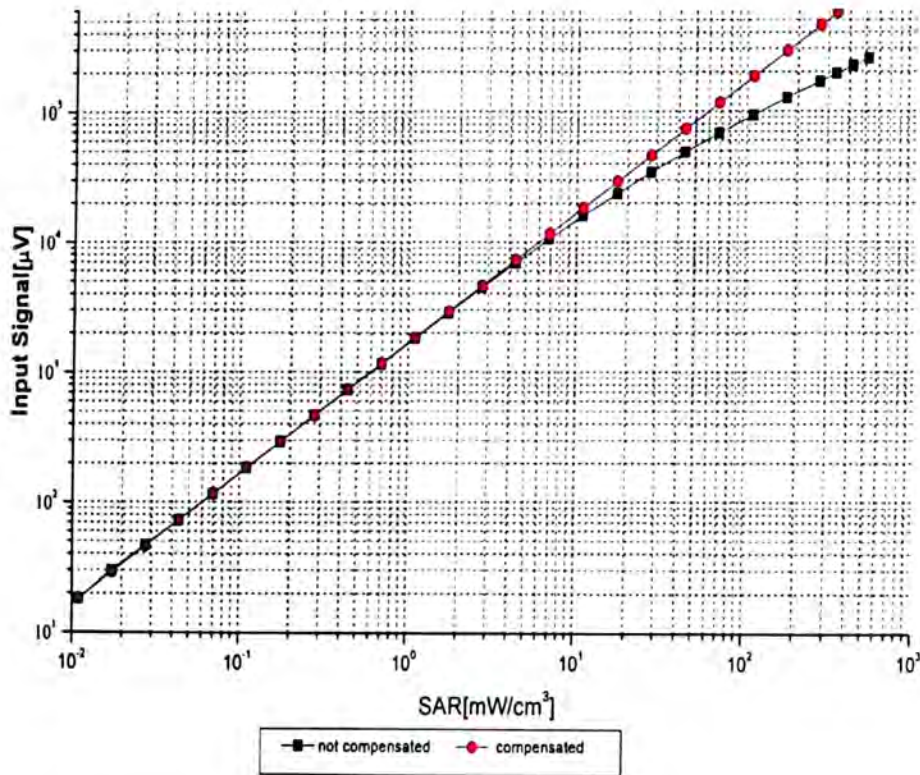

Uncertainty of Linearity Assessment: ±0.9% (k=2)

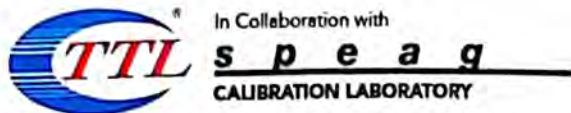

Add: No.52 HuaYuanBei Road, Haidian District, Beijing, 100191, China  
 Tel: +86-10-62304633-2512 Fax: +86-10-62304633-2504  
 E-mail: cttl@chinattl.com [Http://www.chinattl.cn](http://www.chinattl.cn)

## Conversion Factor Assessment

f=750 MHz,WGLS R9(H\_convF)

f=1750 MHz,WGLS R22(H\_convF)

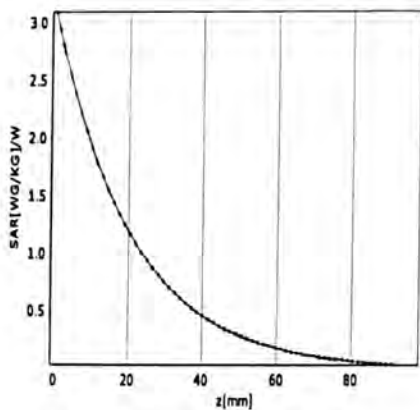

\* analytical \* measured

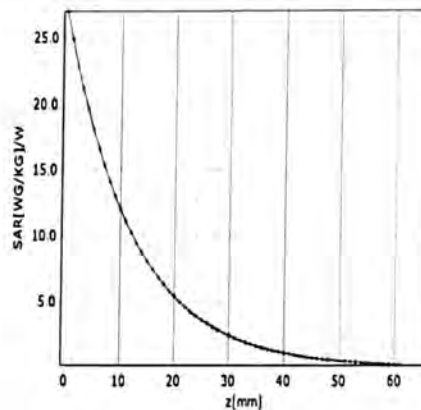

\* analytical \* measured

## Deviation from Isotropy in Liquid

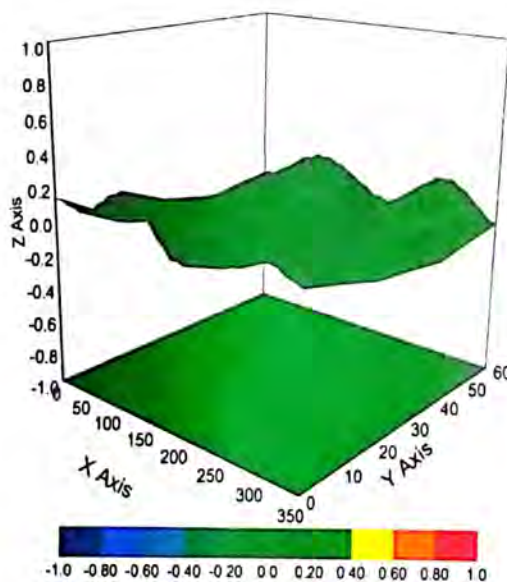

Uncertainty of Spherical Isotropy Assessment:  $\pm 3.2\%$  ( $k=2$ )





Add: No.52 HuaYuanBei Road, Haidian District, Beijing, 100191, China  
 Tel: +86-10-62304633-2512 Fax: +86-10-62304633-2504  
 E-mail: [cttl@chinattl.com](mailto:cttl@chinattl.com) [Http://www.chinattl.cn](http://www.chinattl.cn)

## DASY/EASY – Parameters of Probe: EX3DV4 – SN:7543

### Other Probe Parameters

|   |            |
|---|------------|
| Sensor Arrangement                            | Triangular |
| Connector Angle (°)                           | 50.7       |
| Mechanical Surface Detection Mode             | enabled    |
| Optical Surface Detection Mode                | disable    |
| Probe Overall Length                          | 337mm      |
| Probe Body Diameter                           | 10mm       |
| Tip Length                                    | 9mm        |
| Tip Diameter                                  | 2.5mm      |
| Probe Tip to Sensor X Calibration Point       | 1mm        |
| Probe Tip to Sensor Y Calibration Point       | 1mm        |
| Probe Tip to Sensor Z Calibration Point       | 1mm        |
| Recommended Measurement Distance from Surface | 1.4mm      |



## ANNEX E: D750V3 Dipole Calibration Certificate



In Collaboration with  
**s p e a g**  
CALIBRATION LABORATORY



中国认可  
国际互认  
校准  
CALIBRATION  
CNAS L0570

Add: No.51 Xueyuan Road, Haidian District, Beijing, 100191, China  
Tel: +86-10-62304633-2079 Fax: +86-10-62304633-2504  
E-mail: cttl@chinattl.com http://www.chinattl.cn

Client TA(Shanghai)

Certificate No: Z20-60299

| CALIBRATION CERTIFICATE  |  |  |                       |
|--|--|--|-----------------------|
| Object   | D750V3 - SN: 1045  |  |                       |
| Calibration Procedure(s)   | FF-Z11-003-01<br>Calibration Procedures for dipole validation kits |  |                       |
| Calibration date:  | August 28, 2020  |  |                       |
| <p>This calibration Certificate documents the traceability to national standards, which realize the physical units of measurements(SI). The measurements and the uncertainties with confidence probability are given on the following pages and are part of the certificate.</p> <p>All calibrations have been conducted in the closed laboratory facility; environment temperature(22±3)°C and humidity&lt;70%.</p> <p>Calibration Equipment used (M&amp;TE critical for calibration)</p> |  |  |                       |
| Primary Standards  | ID #   | Cal Date(Calibrated by, Certificate No.) | Scheduled Calibration |
| Power Meter NRP2   | 106276   | 12-May-20 (CTTL, No.J20X02965)           | May-21                |
| Power sensor NRP6A   | 101369   | 12-May-20 (CTTL, No.J20X02965)           | May-21                |
| Reference Probe EX3DV4   | SN 3617  | 30-Jan-20(SPEAG,No.EX3-3617_Jan20)       | Jan-21                |
| DAE4   | SN 771   | 10-Feb-20(CTTL-SPEAG,No.Z20-60017)       | Feb-21                |
| Secondary Standards  | ID #   | Cal Date(Calibrated by, Certificate No.) | Scheduled Calibration |
| Signal Generator E4438C  | MY49071430   | 25-Feb-20 (CTTL, No.J20X00516)           | Feb-21                |
| NetworkAnalyzer E5071C   | MY46110673   | 10-Feb-20 (CTTL, No.J20X00515)           | Feb-21                |
| Calibrated by:   | Name<br>Zhao Jing  | Function<br>SAR Test Engineer            | Signature<br>         |
| Reviewed by:   | Name<br>Lin Hao  | Function<br>SAR Test Engineer            | Signature<br>         |
| Approved by:   | Name<br>Qi Dianyuan  | Function<br>SAR Project Leader           | Signature<br>         |
| Issued: September 3, 2020  |  |  |                       |
| This calibration certificate shall not be reproduced except in full without written approval of the laboratory.  |  |  |                       |

Certificate No: Z20-60299

Page 1 of 8



In Collaboration with  
**s p e a g**  
CALIBRATION LABORATORY

Add: No.51 Xueyuan Road, Haidian District, Beijing, 100191, China  
Tel: +86-10-62304633-2079 Fax: +86-10-62304633-2504  
E-mail: ttl@chematl.com http://www.chinatl.cn

**Glossary:**

|       |  |
|-------|--|
| TSL   | tissue simulating liquid                   |
| ConvF | sensitivity in TSL / NORM <sub>x,y,z</sub> |
| N/A   | not applicable or not measured             |

**Calibration is Performed According to the Following Standards:**

- IEEE Std 1528-2013, "IEEE Recommended Practice for Determining the Peak Spatial-Averaged Specific Absorption Rate (SAR) in the Human Head from Wireless Communications Devices: Measurement Techniques", June 2013
- IEC 62209-1, "Measurement procedure for assessment of specific absorption rate of human exposure to radio frequency fields from hand-held and body-mounted wireless communication devices- Part 1: Device used next to the ear (Frequency range of 300MHz to 6GHz)", July 2016
- IEC 62209-2, "Procedure to measure the Specific Absorption Rate (SAR) For wireless communication devices used in close proximity to the human body (frequency range of 30MHz to 6GHz)", March 2010
- KDB865664, SAR Measurement Requirements for 100 MHz to 6 GHz

**Additional Documentation:**

- DASY4/5 System Handbook

**Methods Applied and Interpretation of Parameters:**

- Measurement Conditions:** Further details are available from the Validation Report at the end of the certificate. All figures stated in the certificate are valid at the frequency indicated.
- Antenna Parameters with TSL:** The dipole is mounted with the spacer to position its feed point exactly below the center marking of the flat phantom section, with the arms oriented parallel to the body axis.
- Feed Point Impedance and Return Loss:** These parameters are measured with the dipole positioned under the liquid filled phantom. The impedance stated is transformed from the measurement at the SMA connector to the feed point. The Return Loss ensures low reflected power. No uncertainty required.
- Electrical Delay:** One-way delay between the SMA connector and the antenna feed point. No uncertainty required.
- SAR measured:** SAR measured at the stated antenna input power.
- SAR normalized:** SAR as measured, normalized to an input power of 1 W at the antenna connector.
- SAR for nominal TSL parameters:** The measured TSL parameters are used to calculate the nominal SAR result.

The reported uncertainty of measurement is stated as the standard uncertainty of Measurement multiplied by the coverage factor  $k=2$ , which for a normal distribution corresponds to a coverage probability of approximately 95%.





In Collaboration with  
**s p e a g**  
CALIBRATION LABORATORY

Add: No.51 Xueyuan Road, Haidian District, Beijing, 100191, China  
Tel: +86-10-62304633-2079 Fax: +86-10-62304633-2504  
E-mail: cttl@chinattl.com http://www.chinattl.cn

**Measurement Conditions**

DASY system configuration, as far as not given on page 1.

|                              |                          |             |
|------------------------------|--------------------------|-------------|
| DASY Version                 | DASY52                   | V52.10.4    |
| Extrapolation                | Advanced Extrapolation   |             |
| Phantom                      | Triple Flat Phantom 5.1C |             |
| Distance Dipole Center - TSL | 15 mm                    | with Spacer |
| Zoom Scan Resolution         | dx, dy, dz = 5 mm        |             |
| Frequency                    | 750 MHz ± 1 MHz          |             |

**Head TSL parameters**

The following parameters and calculations were applied.

|   | Temperature     | Permittivity | Conductivity     |
|---|-----------------|--------------|------------------|
| Nominal Head TSL parameters             | 22.0 °C         | 41.9         | 0.89 mho/m       |
| Measured Head TSL parameters            | (22.0 ± 0.2) °C | 41.3 ± 6 %   | 0.87 mho/m ± 6 % |
| Head TSL temperature change during test | <1.0 °C         | ---          | ---              |

**SAR result with Head TSL**

|   |                    |                          |
|---|--------------------|--------------------------|
| SAR averaged over 1 cm <sup>3</sup> (1 g) of Head TSL   | Condition          |                          |
| SAR measured  | 250 mW input power | 2.07 W/kg                |
| SAR for nominal Head TSL parameters                     | normalized to 1W   | 8.37 W/kg ± 18.8 % (k=2) |
| SAR averaged over 10 cm <sup>3</sup> (10 g) of Head TSL | Condition          |                          |
| SAR measured  | 250 mW input power | 1.38 W/kg                |
| SAR for nominal Head TSL parameters                     | normalized to 1W   | 5.57 W/kg ± 18.7 % (k=2) |

**Body TSL parameters**

The following parameters and calculations were applied.

|   | Temperature     | Permittivity | Conductivity     |
|---|-----------------|--------------|------------------|
| Nominal Body TSL parameters             | 22.0 °C         | 55.5         | 0.96 mho/m       |
| Measured Body TSL parameters            | (22.0 ± 0.2) °C | 54.4 ± 6 %   | 0.94 mho/m ± 6 % |
| Body TSL temperature change during test | <1.0 °C         | ---          | ---              |

**SAR result with Body TSL**

|   |                    |                          |
|---|--------------------|--------------------------|
| SAR averaged over 1 cm <sup>3</sup> (1 g) of Body TSL   | Condition          |                          |
| SAR measured  | 250 mW input power | 2.12 W/kg                |
| SAR for nominal Body TSL parameters                     | normalized to 1W   | 8.58 W/kg ± 18.8 % (k=2) |
| SAR averaged over 10 cm <sup>3</sup> (10 g) of Body TSL | Condition          |                          |
| SAR measured  | 250 mW input power | 1.41 W/kg                |
| SAR for nominal Body TSL parameters                     | normalized to 1W   | 5.70 W/kg ± 18.7 % (k=2) |



In Collaboration with  
**s p e a g**  
 CALIBRATION LABORATORY

Add: No.51 Xueyuan Road, Haidian District, Beijing, 100191, China  
 Tel: +86-10-62304633-2079 Fax: +86-10-62304633-2504  
 E-mail: cttl@chinattl.com http://www.chinattl.cn

**Appendix (Additional assessments outside the scope of CNAS L0570)**

**Antenna Parameters with Head TSL**

|                                      |               |
|--------------------------------------|---------------|
| Impedance, transformed to feed point | 54.3Ω- 2.29jΩ |
| Return Loss                          | - 26.6dB      |

**Antenna Parameters with Body TSL**

|                                      |               |
|--------------------------------------|---------------|
| Impedance, transformed to feed point | 47.7Ω- 4.58jΩ |
| Return Loss                          | - 25.6dB      |

**General Antenna Parameters and Design**

|                                  |          |
|----------------------------------|----------|
| Electrical Delay (one direction) | 0.900 ns |
|----------------------------------|----------|

After long term use with 100W radiated power, only a slight warming of the dipole near the feedpoint can be measured.

The dipole is made of standard semirigid coaxial cable. The center conductor of the feeding line is directly connected to the second arm of the dipole. The antenna is therefore short-circuited for DC-signals. On some of the dipoles, small end caps are added to the dipole arms in order to improve matching when loaded according to the position as explained in the "Measurement Conditions" paragraph. The SAR data are not affected by this change. The overall dipole length is still according to the Standard. No excessive force must be applied to the dipole arms, because they might bend or the soldered connections near the feedpoint may be damaged.

**Additional EUT Data**

|                 |       |
|-----------------|-------|
| Manufactured by | SPEAG |
|-----------------|-------|





In Collaboration with  
**s p e a g**  
CALIBRATION LABORATORY

Add: No.51 Xueyuan Road, Haidian District, Beijing, 100191, China  
Tel: +86-10-62304633-2079 Fax: +86-10-62304633-2504  
E-mail: cttl@chinattl.com http://www.chinattl.cn

**DASY5 Validation Report for Head TSL**

Date: 08.28.2020

Test Laboratory: CTTL, Beijing, China

**DUT: Dipole 750 MHz; Type: D750V3; Serial: D750V3 - SN: 1045**

Communication System: UID 0, CW; Frequency: 750 MHz; Duty Cycle: 1:1

Medium parameters used:  $f = 750 \text{ MHz}$ ;  $\sigma = 0.873 \text{ S/m}$ ;  $\epsilon_r = 41.28$ ;  $\rho = 1000 \text{ kg/m}^3$

Phantom section: Right Section

DASY5 Configuration:

- Probe: EX3DV4 - SN3617; ConvF(10.07, 10.07, 10.07) @ 750 MHz; Calibrated: 2020-01-30
- Sensor-Surface: 1.4mm (Mechanical Surface Detection)
- Electronics: DAE4 Sn771; Calibrated: 2020-02-10
- Phantom: MFP\_V5.1C (20deg probe tilt); Type: QD 000 P51 Cx; Serial: 1062
- Measurement SW: DASY52, Version 52.10 (4); SEMCAD X Version 14.6.14 (7483)

**Dipole Calibration/Zoom Scan (7x7x7) (7x7x7)/Cube 0:** Measurement grid:  $dx=5\text{mm}$ ,

$dy=5\text{mm}$ ,  $dz=5\text{mm}$

Reference Value = 54.97 V/m; Power Drift = -0.02 dB

Peak SAR (extrapolated) = 3.00 W/kg

**SAR(1 g) = 2.07 W/kg; SAR(10 g) = 1.38 W/kg**

Smallest distance from peaks to all points 3 dB below: Larger than measurement grid

Ratio of SAR at M2 to SAR at M1 = 68.7%

Maximum value of SAR (measured) = 2.71 W/kg

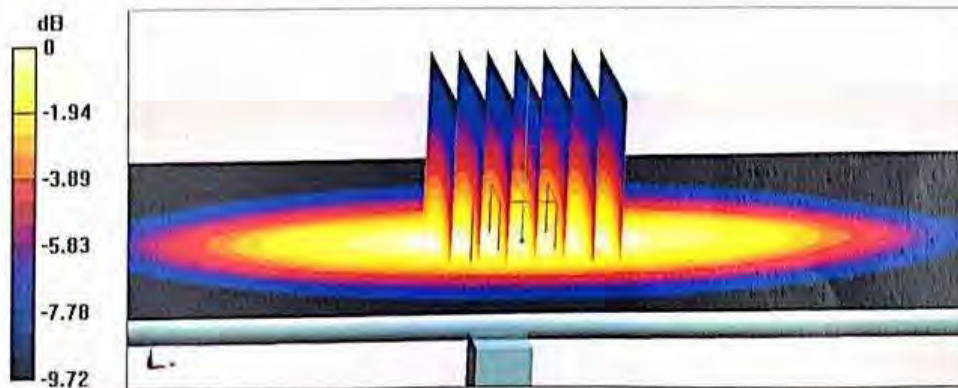

0 dB = 2.71 W/kg = 4.33 dBW/kg



In Collaboration with  
**s p e a g**  
CALIBRATION LABORATORY

Add: No.51 Xueyuan Road, Haidian District, Beijing, 100191, China  
Tel: +86-10-62304633-2079 Fax: +86-10-62304633-2504  
E-mail: cttl@chinattl.com http://www.chinattl.cn

### Impedance Measurement Plot for Head TSL

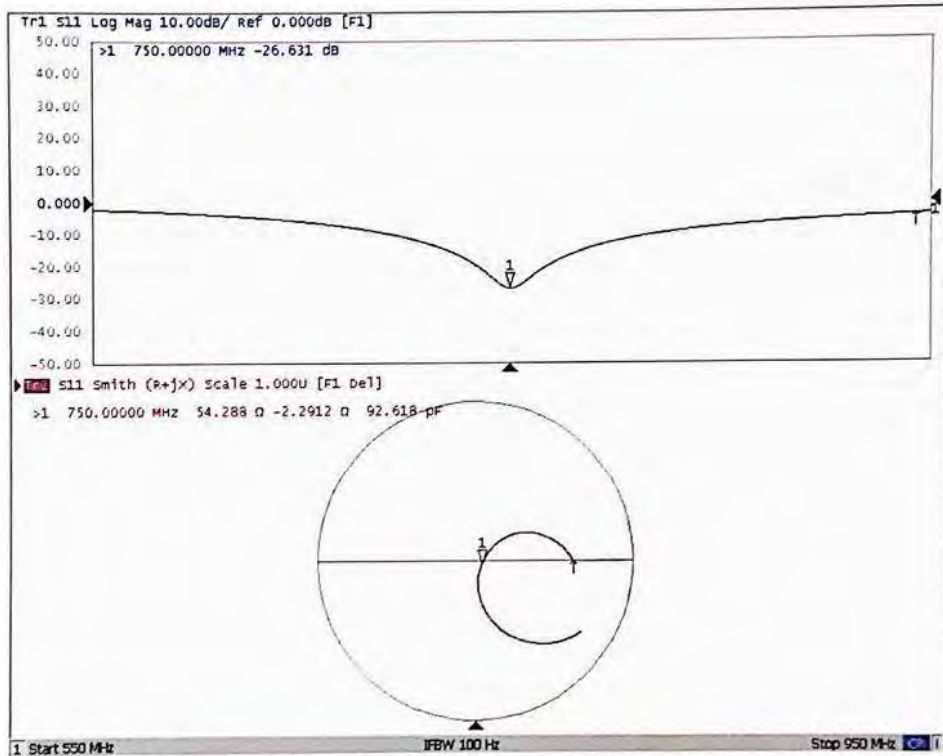



In Collaboration with  
**s p e a g**  
CALIBRATION LABORATORY

Add: No.51 Xueyuan Road, Haidian District, Beijing, 100191, China  
Tel: +86-10-62304633-2079 Fax: +86-10-62304633-2504  
E-mail: ctfl@chinattl.com http://www.chinattl.cn

**DASY5 Validation Report for Body TSL**

Date: 08.28.2020

Test Laboratory: CTTL, Beijing, China

**DUT: Dipole 750 MHz; Type: D750V3; Serial: D750V3 - SN: 1045**

Communication System: UID 0, CW; Frequency: 750 MHz; Duty Cycle: 1:1

Medium parameters used:  $f = 750 \text{ MHz}$ ;  $\sigma = 0.94 \text{ S/m}$ ;  $\epsilon_r = 54.36$ ;  $\rho = 1000 \text{ kg/m}^3$

Phantom section: Center Section

DASY5 Configuration:

- Probe: EX3DV4 - SN3617; ConvF(9.8, 9.8, 9.8) @ 750 MHz; Calibrated: 2020-01-30
- Sensor-Surface: 1.4mm (Mechanical Surface Detection)
- Electronics: DAE4 Sn771; Calibrated: 2020-02-10
- Phantom: MFP\_V5.1C (20deg probe tilt); Type: QD 000 P51 Cx; Serial: 1062
- Measurement SW: DASY52, Version 52.10 (4); SEMCAD X Version 14.6.14 (7483)

**Dipole Calibration/Zoom Scan (7x7x7) (7x7x7)/Cube 0:** Measurement grid: dx=5mm, dy=5mm, dz=5mm

Reference Value = 53.84 V/m; Power Drift = -0.02 dB

Peak SAR (extrapolated) = 3.14 W/kg

**SAR(1 g) = 2.12 W/kg; SAR(10 g) = 1.41 W/kg**

Smallest distance from peaks to all points 3 dB below = 18.4 mm

Ratio of SAR at M2 to SAR at M1 = 67.9%

Maximum value of SAR (measured) = 2.80 W/kg

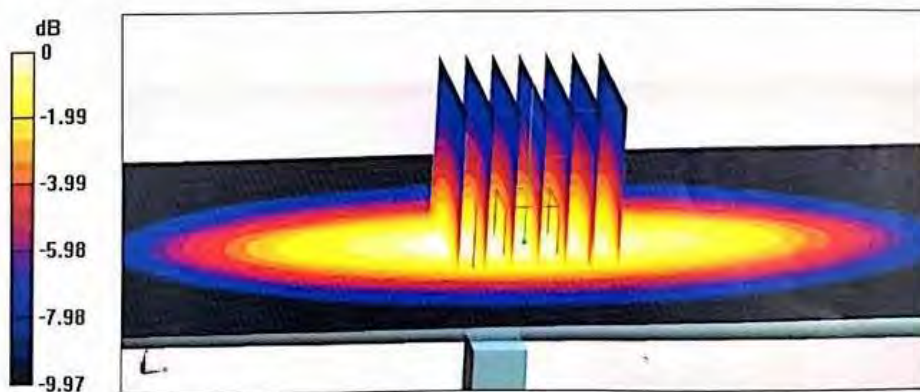

0 dB = 2.80 W/kg = 4.47 dBW/kg



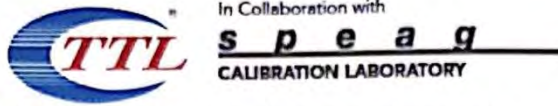

Add: No.51 Xueyuan Road, Haidian District, Beijing, 100191, China  
Tel: +86-10-62304633-2079 Fax: +86-10-62304633-2504  
E-mail: cttl@chinattl.com http://www.chinattl.cn

### Impedance Measurement Plot for Body TSL

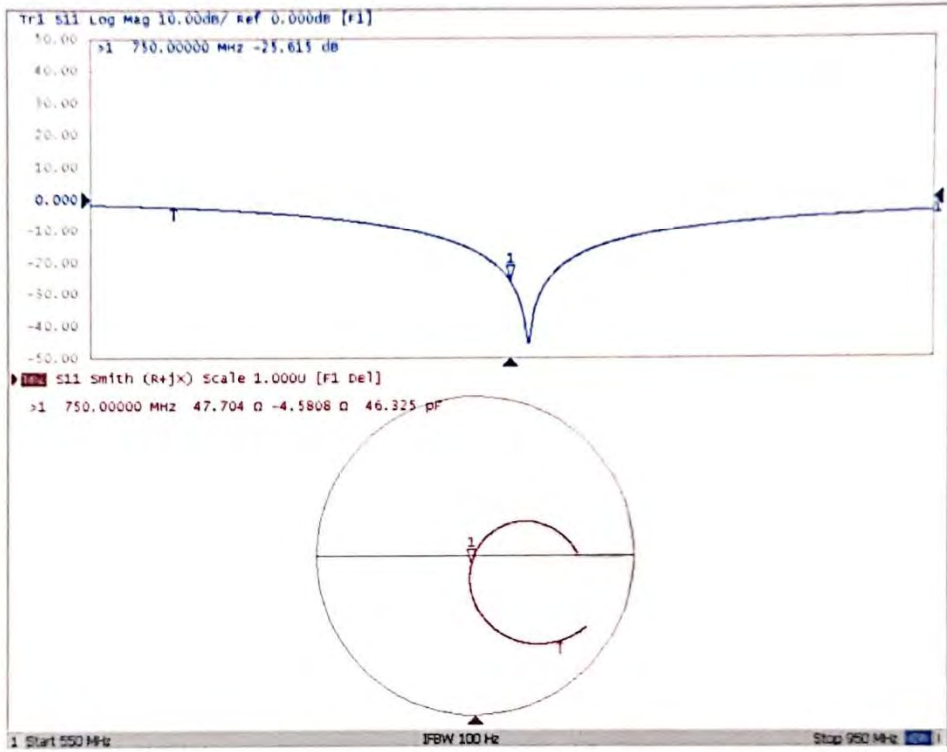



## ANNEX F: D835V2 Dipole Calibration Certificate



In Collaboration with  
**s p e a g**  
CALIBRATION LABORATORY



中国认可  
国际互认  
校准  
CALIBRATION  
CNAS L0570

Add: No.51 Xueyuan Road, Haidian District, Beijing, 100191, China  
Tel: +86-10-62304633-2079 Fax: +86-10-62304633-2504  
E-mail: cttl@chinattl.com http://www.chinattl.cn

Client **TA(Shanghai)**Certificate No: **Z20-60296****CALIBRATION CERTIFICATE**Object **D835V2 - SN: 4d020**Calibration Procedure(s) **FF-Z11-003-01  
Calibration Procedures for dipole validation kits**Calibration date: **August 28, 2020**

This calibration Certificate documents the traceability to national standards, which realize the physical units of measurements(SI). The measurements and the uncertainties with confidence probability are given on the following pages and are part of the certificate.

All calibrations have been conducted in the closed laboratory facility: environment temperature(22±3)°C and humidity<70%.

Calibration Equipment used (M&amp;TE critical for calibration)

| Primary Standards       | ID #       | Cal Date(Calibrated by, Certificate No.) | Scheduled Calibration |
|-------------------------|------------|--|-----------------------|
| Power Meter NRP2        | 106276     | 12-May-20 (CTTL, No.J20X02965)           | May-21                |
| Power sensor NRP6A      | 101369     | 12-May-20 (CTTL, No.J20X02965)           | May-21                |
| Reference Probe EX3DV4  | SN 3617    | 30-Jan-20(SPEAG, No.EX3-3617_Jan20)      | Jan-21                |
| DAE4                    | SN 771     | 10-Feb-20(CTTL-SPEAG, No.Z20-60017)      | Feb-21                |
| Secondary Standards     | ID #       | Cal Date(Calibrated by, Certificate No.) | Scheduled Calibration |
| Signal Generator E4438C | MY49071430 | 25-Feb-20 (CTTL, No.J20X00516)           | Feb-21                |
| NetworkAnalyzer E5071C  | MY46110673 | 10-Feb-20 (CTTL, No.J20X00515)           | Feb-21                |

|                | Name        | Function           | Signature |
|----------------|-------------|--------------------|-----------|
| Calibrated by: | Zhao Jing   | SAR Test Engineer  |           |
| Reviewed by:   | Lin Hao     | SAR Test Engineer  |           |
| Approved by:   | Qi Dianyuan | SAR Project Leader |           |

Issued: September 3, 2020

This calibration certificate shall not be reproduced except in full without written approval of the laboratory.

Certificate No: Z20-60296

Page 1 of 8



In Collaboration with  
**s p e a g**  
CALIBRATION LABORATORY

Add: No.51 Xueyuan Road, Haidian District, Beijing, 100191, China  
Tel: +86-10-62304633-2079 Fax: +86-10-62304633-2504  
E-mail: cttl@chinatl.com http://www.chinatl.cn

**Glossary:**

|       |  |
|-------|--|
| TSL   | tissue simulating liquid                   |
| ConvF | sensitivity in TSL / NORM <sub>x,y,z</sub> |
| N/A   | not applicable or not measured             |

**Calibration is Performed According to the Following Standards:**

- IEEE Std 1528-2013, "IEEE Recommended Practice for Determining the Peak Spatial-Averaged Specific Absorption Rate (SAR) in the Human Head from Wireless Communications Devices: Measurement Techniques", June 2013
- IEC 62209-1, "Measurement procedure for assessment of specific absorption rate of human exposure to radio frequency fields from hand-held and body-mounted wireless communication devices- Part 1: Device used next to the ear (Frequency range of 300MHz to 6GHz)", July 2016
- IEC 62209-2, "Procedure to measure the Specific Absorption Rate (SAR) For wireless communication devices used in close proximity to the human body (frequency range of 30MHz to 6GHz)", March 2010
- KDB865664, SAR Measurement Requirements for 100 MHz to 6 GHz

**Additional Documentation:**

- DASY4/5 System Handbook

**Methods Applied and Interpretation of Parameters:**

- Measurement Conditions:** Further details are available from the Validation Report at the end of the certificate. All figures stated in the certificate are valid at the frequency indicated.
- Antenna Parameters with TSL:** The dipole is mounted with the spacer to position its feed point exactly below the center marking of the flat phantom section, with the arms oriented parallel to the body axis.
- Feed Point Impedance and Return Loss:** These parameters are measured with the dipole positioned under the liquid filled phantom. The impedance stated is transformed from the measurement at the SMA connector to the feed point. The Return Loss ensures low reflected power. No uncertainty required.
- Electrical Delay:** One-way delay between the SMA connector and the antenna feed point. No uncertainty required.
- SAR measured:** SAR measured at the stated antenna input power.
- SAR normalized:** SAR as measured, normalized to an input power of 1 W at the antenna connector.
- SAR for nominal TSL parameters:** The measured TSL parameters are used to calculate the nominal SAR result.

The reported uncertainty of measurement is stated as the standard uncertainty of Measurement multiplied by the coverage factor  $k=2$ , which for a normal distribution Corresponds to a coverage probability of approximately 95%.





In Collaboration with  
**s p e a g**  
 CALIBRATION LABORATORY

Add: No.51 Xueyuan Road, Haidian District, Beijing, 100191, China  
 Tel: +86-10-62304633-2079 Fax: +86-10-62304633-2504  
 E-mail: cttl@chinattl.com http://www.chinattl.cn

**Measurement Conditions**

DASY system configuration, as far as not given on page 1.

|                              |                          |             |
|------------------------------|--------------------------|-------------|
| DASY Version                 | DASY52                   | V52.10.4    |
| Extrapolation                | Advanced Extrapolation   |             |
| Phantom                      | Triple Flat Phantom 5.1C |             |
| Distance Dipole Center - TSL | 15 mm                    | with Spacer |
| Zoom Scan Resolution         | dx, dy, dz = 5 mm        |             |
| Frequency                    | 835 MHz ± 1 MHz          |             |

**Head TSL parameters**

The following parameters and calculations were applied.

|   | Temperature     | Permittivity | Conductivity     |
|---|-----------------|--------------|------------------|
| Nominal Head TSL parameters             | 22.0 °C         | 41.5         | 0.90 mho/m       |
| Measured Head TSL parameters            | (22.0 ± 0.2) °C | 41.2 ± 6 %   | 0.88 mho/m ± 6 % |
| Head TSL temperature change during test | <1.0 °C         | ---          | ---              |

**SAR result with Head TSL**

| SAR averaged over 1 cm <sup>3</sup> (1 g) of Head TSL   | Condition          |                          |
|---|--------------------|--------------------------|
| SAR measured  | 250 mW input power | 2.37 W/kg                |
| SAR for nominal Head TSL parameters                     | normalized to 1W   | 9.65 W/kg ± 18.8 % (k=2) |
| SAR averaged over 10 cm <sup>3</sup> (10 g) of Head TSL | Condition          |                          |
| SAR measured  | 250 mW input power | 1.57 W/kg                |
| SAR for nominal Head TSL parameters                     | normalized to 1W   | 6.37 W/kg ± 18.7 % (k=2) |

**Body TSL parameters**

The following parameters and calculations were applied.

|   | Temperature     | Permittivity | Conductivity     |
|---|-----------------|--------------|------------------|
| Nominal Body TSL parameters             | 22.0 °C         | 55.2         | 0.97 mho/m       |
| Measured Body TSL parameters            | (22.0 ± 0.2) °C | 55.0 ± 6 %   | 0.96 mho/m ± 6 % |
| Body TSL temperature change during test | <1.0 °C         | ---          | ---              |

**SAR result with Body TSL**

| SAR averaged over 1 cm <sup>3</sup> (1 g) of Body TSL   | Condition          |                           |
|---|--------------------|---------------------------|
| SAR measured  | 250 mW input power | 2.42 W/kg                 |
| SAR for nominal Body TSL parameters                     | normalized to 1W   | 9.76 W /kg ± 18.8 % (k=2) |
| SAR averaged over 10 cm <sup>3</sup> (10 g) of Body TSL | Condition          |                           |
| SAR measured  | 250 mW input power | 1.59 W/kg                 |
| SAR for nominal Body TSL parameters                     | normalized to 1W   | 6.40 W/kg ± 18.7 % (k=2)  |



In Collaboration with  
**s p e a g**  
 CALIBRATION LABORATORY

Add: No.51 Xueyuan Road, Haidian District, Beijing, 100191, China  
 Tel: +86-10-62304633-2079 Fax: +86-10-62304633-2504  
 E-mail: cttl@chinattl.com http://www.chinattl.cn

**Appendix (Additional assessments outside the scope of CNAS L0570)**

**Antenna Parameters with Head TSL**

|                                      |               |
|--------------------------------------|---------------|
| Impedance, transformed to feed point | 54.8Ω+ 1.73jΩ |
| Return Loss                          | - 26.2dB      |

**Antenna Parameters with Body TSL**

|                                      |               |
|--------------------------------------|---------------|
| Impedance, transformed to feed point | 46.0Ω- 2.47jΩ |
| Return Loss                          | - 26.2dB      |

**General Antenna Parameters and Design**

|                                  |          |
|----------------------------------|----------|
| Electrical Delay (one direction) | 1.258 ns |
|----------------------------------|----------|

After long term use with 100W radiated power, only a slight warming of the dipole near the feedpoint can be measured.

The dipole is made of standard semirigid coaxial cable. The center conductor of the feeding line is directly connected to the second arm of the dipole. The antenna is therefore short-circuited for DC-signals. On some of the dipoles, small end caps are added to the dipole arms in order to improve matching when loaded according to the position as explained in the "Measurement Conditions" paragraph. The SAR data are not affected by this change. The overall dipole length is still according to the Standard. No excessive force must be applied to the dipole arms, because they might bend or the soldered connections near the feedpoint may be damaged.

**Additional EUT Data**

|                 |       |
|-----------------|-------|
| Manufactured by | SPEAG |
|-----------------|-------|



In Collaboration with  
**s p e a g**  
CALIBRATION LABORATORY

Add: No.51 Xueyuan Road, Haidian District, Beijing, 100191, China  
Tel: +86-10-62304633-2079 Fax: +86-10-62304633-2504  
E-mail: cttl@chinattl.com http://www.chinattl.cn

**DASY5 Validation Report for Head TSL**

Date: 08.28.2020

Test Laboratory: CTTL, Beijing, China

**DUT: Dipole 835 MHz; Type: D835V2; Serial: D835V2 - SN: 4d020**

Communication System: UID 0, CW; Frequency: 835 MHz; Duty Cycle: 1:1

Medium parameters used:  $f = 835$  MHz;  $\sigma = 0.877$  S/m;  $\epsilon_r = 41.23$ ;  $\rho = 1000$  kg/m<sup>3</sup>

Phantom section: Center Section

**DASY5 Configuration:**

- Probe: EX3DV4 - SN3617; ConvF(9.66, 9.66, 9.66) @ 835 MHz; Calibrated: 2020-01-30
- Sensor-Surface: 1.4mm (Mechanical Surface Detection)
- Electronics: DAE4 Sn771; Calibrated: 2020-02-10
- Phantom: MFP\_V5.1C (20deg probe tilt); Type: QD 000 P51 Cx; Serial: 1062
- Measurement SW: DASY52, Version 52.10 (4); SEMCAD X Version 14.6.14 (7483)

**Dipole Calibration/Zoom Scan (7x7x7) (7x7x7)/Cube 0:** Measurement grid: dx=5mm, dy=5mm, dz=5mm

Reference Value = 58.09 V/m; Power Drift = -0.03 dB

Peak SAR (extrapolated) = 3.46 W/kg

**SAR(1 g) = 2.37 W/kg; SAR(10 g) = 1.57 W/kg**

Smallest distance from peaks to all points 3 dB below = 16.6 mm

Ratio of SAR at M2 to SAR at M1 = 68.1%

Maximum value of SAR (measured) = 3.12 W/kg

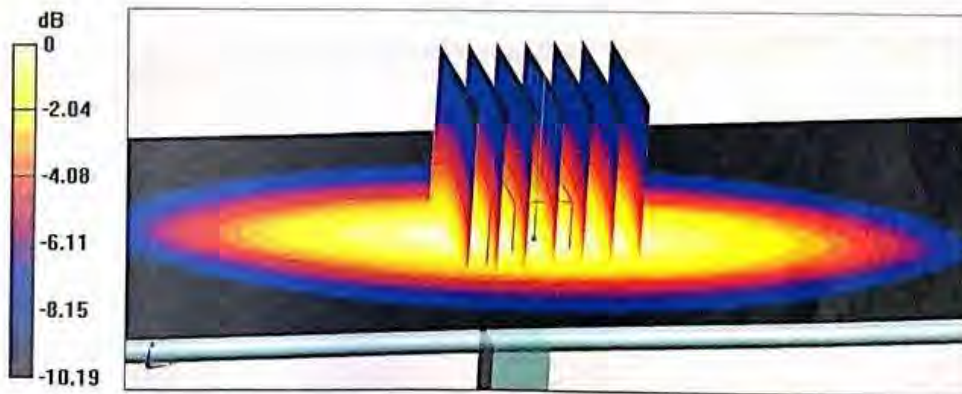

0 dB = 3.12 W/kg = 4.94 dBW/kg





In Collaboration with  
**s p e a g**  
CALIBRATION LABORATORY

Add: No.51 Xueyuan Road, Haidian District, Beijing, 100191, China  
Tel: +86-10-62304633-2079 Fax: +86-10-62304633-2504  
E-mail: ettl@chinattl.com http://www.chinattl.cn

### Impedance Measurement Plot for Head TSL

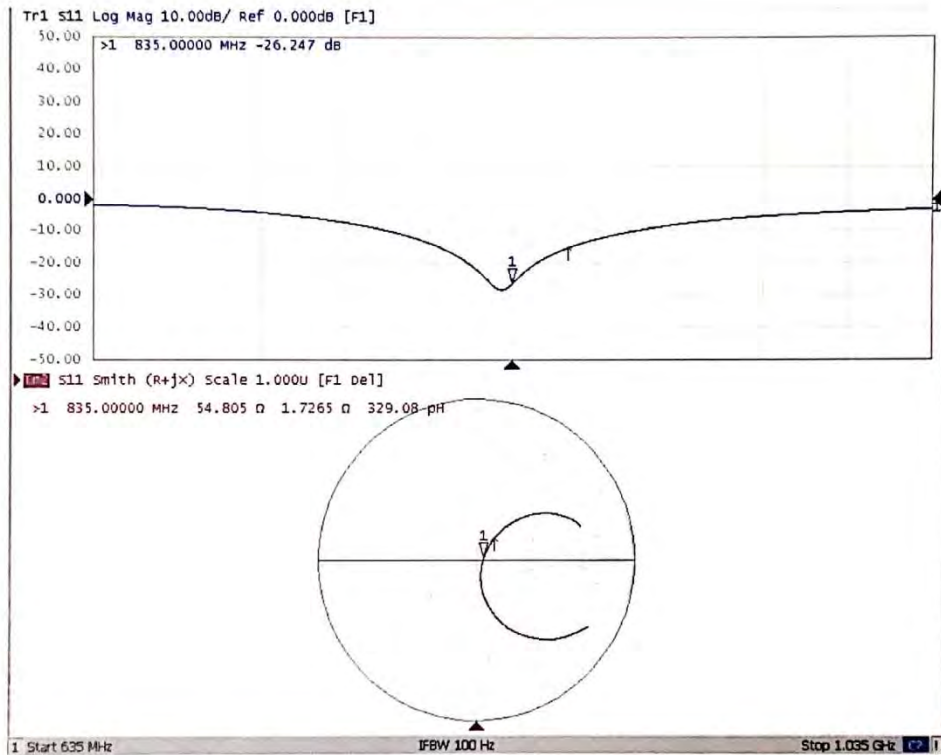



In Collaboration with  
**s p e a g**  
CALIBRATION LABORATORY

Add: No.51 Xueyuan Road, Haidian District, Beijing, 100191, China  
Tel: +86-10-62304633-2079 Fax: +86-10-62304633-2504  
E-mail: cttl@chinattl.com http://www.chinattl.cn

**DASY5 Validation Report for Body TSL**

Date: 08.28.2020

Test Laboratory: CTTL, Beijing, China

**DUT: Dipole 835 MHz; Type: D835V2; Serial: D835V2 - SN: 4d020**

Communication System: UID 0, CW; Frequency: 835 MHz; Duty Cycle: 1:1

Medium parameters used:  $f = 835 \text{ MHz}$ ;  $\sigma = 0.958 \text{ S/m}$ ;  $\epsilon_r = 55.02$ ;  $\rho = 1000 \text{ kg/m}^3$

Phantom section: Right Section

DASY5 Configuration:

- Probe: EX3DV4 - SN3617; ConvF(9.53, 9.53, 9.53) @ 835 MHz; Calibrated: 2020-01-30
- Sensor-Surface: 1.4mm (Mechanical Surface Detection)
- Electronics: DAE4 Sn771; Calibrated: 2020-02-10
- Phantom: MFP\_V5.1C (20deg probe tilt); Type: QD 000 P51 Cx; Serial: 1062
- Measurement SW: DASY52, Version 52.10 (4); SEMCAD X Version 14.6.14 (7483)

**Dipole Calibration/Zoom Scan (7x7x7) (7x7x7)/Cube 0:** Measurement grid: dx=5mm, dy=5mm, dz=5mm

Reference Value = 56.88 V/m; Power Drift = -0.01 dB

Peak SAR (extrapolated) = 3.65 W/kg

**SAR(1 g) = 2.42 W/kg; SAR(10 g) = 1.59 W/kg**

Smallest distance from peaks to all points 3 dB below = 15.8 mm

Ratio of SAR at M2 to SAR at M1 = 66.5%

Maximum value of SAR (measured) = 3.24 W/kg

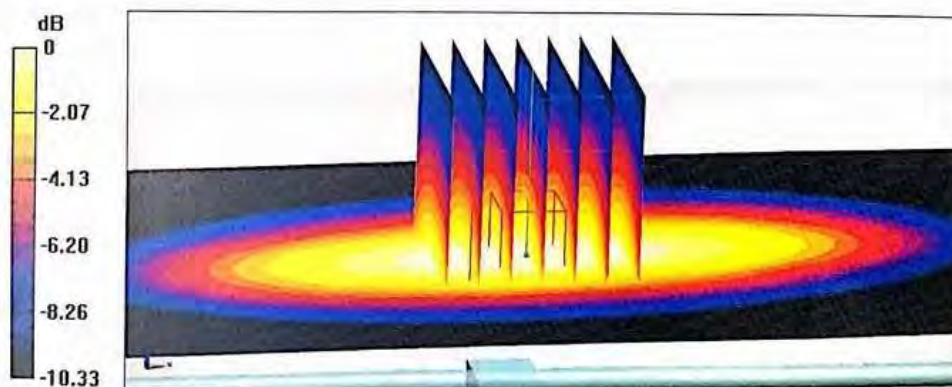

0 dB = 3.24 W/kg = 5.11 dBW/kg



In Collaboration with  
**s p e a g**  
CALIBRATION LABORATORY

Add: No.51 Xueyuan Road, Haidian District, Beijing, 100191, China  
Tel: +86-10-62304633-2079 Fax: +86-10-62304633-2504  
E-mail: ettl@chinattl.com http://www.chinattl.cn

### Impedance Measurement Plot for Body TSL

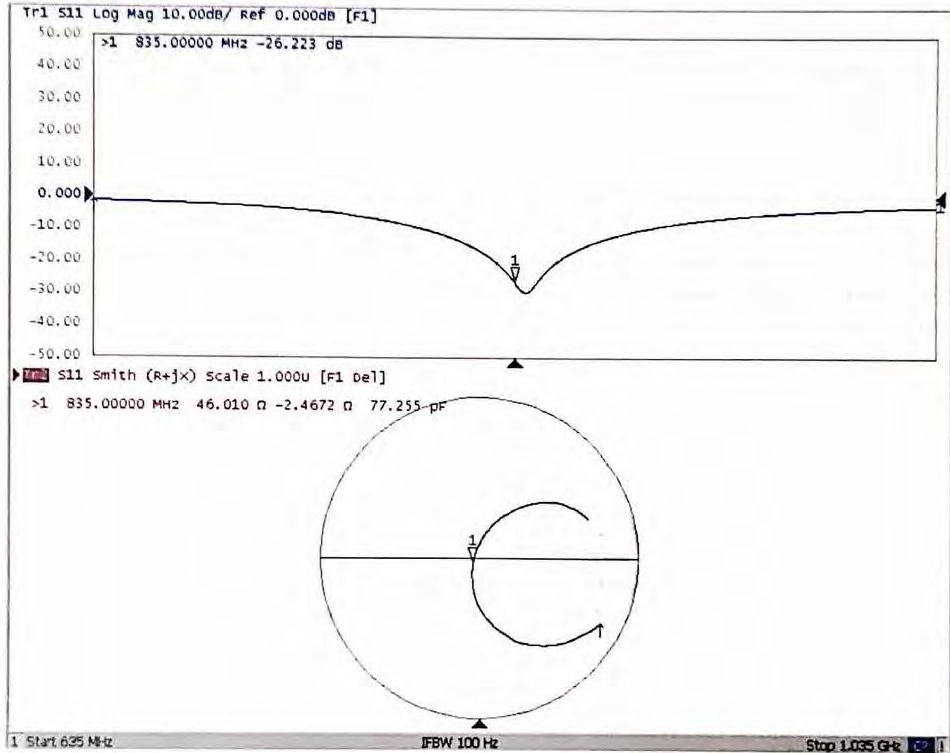



**ANNEX G: D1750V2 Dipole Calibration Certificate**

In Collaboration with  
**s p e a g**  
CALIBRATION LABORATORY



中国认可  
国际互认  
校准  
CALIBRATION  
CNAS L0570

Add: No.51 Xueyuan Road, Haidian District, Beijing, 100191, China  
Tel: +86-10-62304633-2079 Fax: +86-10-62304633-2504  
E-mail: cttl@chinattl.com http://www.chinattl.cn

Client **TA(Shanghai)**Certificate No: **Z20-60079****CALIBRATION CERTIFICATE**

Object **D1750V2 - SN: 1033**

Calibration Procedure(s) **FF-Z11-003-01**  
Calibration Procedures for dipole validation kits

Calibration date: **February 25, 2020**

This calibration Certificate documents the traceability to national standards, which realize the physical units of measurements(SI). The measurements and the uncertainties with confidence probability are given on the following pages and are part of the certificate.

All calibrations have been conducted in the closed laboratory facility: environment temperature(22±3)°C and humidity<70%.

Calibration Equipment used (M&TE critical for calibration)

| Primary Standards       | ID #       | Cal Date(Calibrated by, Certificate No.) | Scheduled Calibration |
|-------------------------|------------|--|-----------------------|
| Power Meter NRP2        | 106276     | 11-Apr-19 (CTTL, No.J19X02605)           | Apr-20                |
| Power sensor NRP6A      | 101369     | 11-Apr-19 (CTTL, No.J19X02605)           | Apr-20                |
| Reference Probe EX3DV4  | SN 3846    | 25-Mar-19(CTTL-SPEAG,No.Z19-60064)       | Mar-20                |
| DAE4                    | SN 1555    | 22-Aug-19(CTTL-SPEAG,No.Z19-60295)       | Aug-20                |
| Secondary Standards     | ID #       | Cal Date(Calibrated by, Certificate No.) | Scheduled Calibration |
| Signal Generator E4438C | MY49071430 | 10-Feb-20 (CTTL, No.J20X00516)           | Feb-21                |
| NetworkAnalyzer E5071C  | MY46110673 | 10-Feb-20 (CTTL, No.J20X00515)           | Feb-21                |

|                | Name        | Function           | Signature |
|----------------|-------------|--------------------|-----------|
| Calibrated by: | Zhao Jing   | SAR Test Engineer  |           |
| Reviewed by:   | Lin Hao     | SAR Test Engineer  |           |
| Approved by:   | Qi Dianyuan | SAR Project Leader |           |

Issued: February 29, 2020

This calibration certificate shall not be reproduced except in full without written approval of the laboratory.

Certificate No: Z20-60079

Page 1 of 8



In Collaboration with  
**s p e a g**  
CALIBRATION LABORATORY

Add: No.51 Xueyuan Road, Haidian District, Beijing, 100191, China  
Tel: +86-10-62304633-2079 Fax: +86-10-62304633-2504  
E-mail: cttl@chinattl.com http://www.chinattl.cn

**Glossary:**

|       |  |
|-------|--|
| TSL   | tissue simulating liquid                   |
| ConvF | sensitivity in TSL / NORM <sub>x,y,z</sub> |
| N/A   | not applicable or not measured             |

**Calibration is Performed According to the Following Standards:**

- IEEE Std 1528-2013, "IEEE Recommended Practice for Determining the Peak Spatial-Averaged Specific Absorption Rate (SAR) in the Human Head from Wireless Communications Devices: Measurement Techniques", June 2013
- IEC 62209-1, "Measurement procedure for assessment of specific absorption rate of human exposure to radio frequency fields from hand-held and body-mounted wireless communication devices- Part 1: Device used next to the ear (Frequency range of 300MHz to 6GHz)", July 2016
- IEC 62209-2, "Procedure to measure the Specific Absorption Rate (SAR) For wireless communication devices used in close proximity to the human body (frequency range of 30MHz to 6GHz)", March 2010
- KDB865664, SAR Measurement Requirements for 100 MHz to 6 GHz

**Additional Documentation:**

- DASY4/5 System Handbook

**Methods Applied and Interpretation of Parameters:**

- Measurement Conditions:** Further details are available from the Validation Report at the end of the certificate. All figures stated in the certificate are valid at the frequency indicated.
- Antenna Parameters with TSL:** The dipole is mounted with the spacer to position its feed point exactly below the center marking of the flat phantom section, with the arms oriented parallel to the body axis.
- Feed Point Impedance and Return Loss:** These parameters are measured with the dipole positioned under the liquid filled phantom. The impedance stated is transformed from the measurement at the SMA connector to the feed point. The Return Loss ensures low reflected power. No uncertainty required.
- Electrical Delay:** One-way delay between the SMA connector and the antenna feed point. No uncertainty required.
- SAR measured:** SAR measured at the stated antenna input power.
- SAR normalized:** SAR as measured, normalized to an input power of 1 W at the antenna connector.
- SAR for nominal TSL parameters:** The measured TSL parameters are used to calculate the nominal SAR result.

The reported uncertainty of measurement is stated as the standard uncertainty of Measurement multiplied by the coverage factor  $k=2$ , which for a normal distribution Corresponds to a coverage probability of approximately 95%.



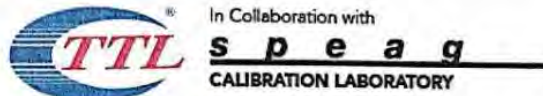

Add: No.51 Xueyuan Road, Haidian District, Beijing, 100191, China  
 Tel: +86-10-62304633-2079 Fax: +86-10-62304633-2504  
 E-mail: cttl@chinattl.com http://www.chinattl.cn

**Measurement Conditions**

DASY system configuration, as far as not given on page 1.

|                              |                          |             |
|------------------------------|--------------------------|-------------|
| DASY Version                 | DASY52                   | V52.10.4    |
| Extrapolation                | Advanced Extrapolation   |             |
| Phantom                      | Triple Flat Phantom 5.1C |             |
| Distance Dipole Center - TSL | 10 mm                    | with Spacer |
| Zoom Scan Resolution         | dx, dy, dz = 5 mm        |             |
| Frequency                    | 1750 MHz ± 1 MHz         |             |

**Head TSL parameters**

The following parameters and calculations were applied.

|   | Temperature     | Permittivity | Conductivity     |
|---|-----------------|--------------|------------------|
| Nominal Head TSL parameters             | 22.0 °C         | 40.1         | 1.37 mho/m       |
| Measured Head TSL parameters            | (22.0 ± 0.2) °C | 39.1 ± 6 %   | 1.35 mho/m ± 6 % |
| Head TSL temperature change during test | <1.0 °C         | ---          | ---              |

**SAR result with Head TSL**

|   |                    |                                 |
|---|--------------------|---------------------------------|
| SAR averaged over 1 cm <sup>3</sup> (1 g) of Head TSL   | Condition          |                                 |
| SAR measured  | 250 mW input power | 8.93 W/kg                       |
| SAR for nominal Head TSL parameters                     | normalized to 1W   | <b>35.9 W/kg ± 18.8 % (k=2)</b> |
| SAR averaged over 10 cm <sup>3</sup> (10 g) of Head TSL | Condition          |                                 |
| SAR measured  | 250 mW input power | 4.71 W/kg                       |
| SAR for nominal Head TSL parameters                     | normalized to 1W   | <b>18.9 W/kg ± 18.7 % (k=2)</b> |

**Body TSL parameters**

The following parameters and calculations were applied.

|   | Temperature     | Permittivity | Conductivity     |
|---|-----------------|--------------|------------------|
| Nominal Body TSL parameters             | 22.0 °C         | 53.4         | 1.49 mho/m       |
| Measured Body TSL parameters            | (22.0 ± 0.2) °C | 52.4 ± 6 %   | 1.48 mho/m ± 6 % |
| Body TSL temperature change during test | <1.0 °C         | ---          | ---              |

**SAR result with Body TSL**

|   |                    |                                 |
|---|--------------------|---------------------------------|
| SAR averaged over 1 cm <sup>3</sup> (1 g) of Body TSL   | Condition          |                                 |
| SAR measured  | 250 mW input power | 9.24 W/kg                       |
| SAR for nominal Body TSL parameters                     | normalized to 1W   | <b>36.9 W/kg ± 18.8 % (k=2)</b> |
| SAR averaged over 10 cm <sup>3</sup> (10 g) of Body TSL | Condition          |                                 |
| SAR measured  | 250 mW input power | 4.95 W/kg                       |
| SAR for nominal Body TSL parameters                     | normalized to 1W   | <b>19.8 W/kg ± 18.7 % (k=2)</b> |





In Collaboration with  
**s p e a g**  
 CALIBRATION LABORATORY

Add: No.51 Xueyuan Road, Haidian District, Beijing, 100191, China  
 Tel: +86-10-62304633-2079 Fax: +86-10-62304633-2504  
 E-mail: cttl@chinattl.com http://www.chinattl.cn

**Appendix (Additional assessments outside the scope of CNAS L0570)**

**Antenna Parameters with Head TSL**

|                                      |                |
|--------------------------------------|----------------|
| Impedance, transformed to feed point | 48.8Ω- 0.06 jΩ |
| Return Loss                          | - 38.3 dB      |

**Antenna Parameters with Body TSL**

|                                      |                |
|--------------------------------------|----------------|
| Impedance, transformed to feed point | 44.5Ω- 0.85 jΩ |
| Return Loss                          | - 24.5 dB      |

**General Antenna Parameters and Design**

|                                  |          |
|----------------------------------|----------|
| Electrical Delay (one direction) | 1.085 ns |
|----------------------------------|----------|

After long term use with 100W radiated power, only a slight warming of the dipole near the feedpoint can be measured.

The dipole is made of standard semirigid coaxial cable. The center conductor of the feeding line is directly connected to the second arm of the dipole. The antenna is therefore short-circuited for DC-signals. On some of the dipoles, small end caps are added to the dipole arms in order to improve matching when loaded according to the position as explained in the "Measurement Conditions" paragraph. The SAR data are not affected by this change. The overall dipole length is still according to the Standard. No excessive force must be applied to the dipole arms, because they might bend or the soldered connections near the feedpoint may be damaged.

**Additional EUT Data**

|                 |       |
|-----------------|-------|
| Manufactured by | SPEAG |
|-----------------|-------|

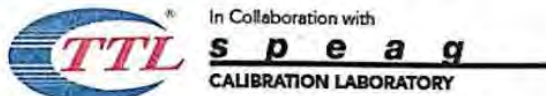

In Collaboration with  
**TTL** **s p e a g**  
**CALIBRATION LABORATORY**  
 Add: No.51 Xueyuan Road, Haidian District, Beijing, 100191, China  
 Tel: +86-10-62304633-2079 Fax: +86-10-62304633-2504  
 E-mail: cttl@chinattl.com http://www.chinattl.cn

**DASY5 Validation Report for Head TSL**

Date: 02.25.2020

Test Laboratory: CTTL, Beijing, China

**DUT: Dipole 1750 MHz; Type: D1750V2; Serial: D1750V2 - SN: 1033**

Communication System: UID 0, CW; Frequency: 1750 MHz; Duty Cycle: 1:1

Medium parameters used:  $f = 1750$  MHz;  $\sigma = 1.349$  S/m;  $\epsilon_r = 39.06$ ;  $\rho = 1000$  kg/m<sup>3</sup>

Phantom section: Right Section

**DASY5 Configuration:**

- Probe: EX3DV4 - SN3846; ConvF(8.2, 8.2, 8.2) @ 1750 MHz; Calibrated: 2019-03-25
- Sensor-Surface: 1.4mm (Mechanical Surface Detection)
- Electronics: DAE4 Sn1555; Calibrated: 2019-08-22
- Phantom: MFP\_V5.1C (20deg probe tilt); Type: QD 000 P51 Cx; Serial: 1062
- Measurement SW: DASY52, Version 52.10 (4); SEMCAD X Version 14.6.14 (7483)

**System Performance Check/Zoom Scan (7x7x7) (7x7x7)/Cube 0: Measurement grid:**

$dx=5$ mm,  $dy=5$ mm,  $dz=5$ mm

Reference Value = 98.26 V/m; Power Drift = -0.02 dB

Peak SAR (extrapolated) = 16.9 W/kg

**SAR(1 g) = 8.93 W/kg; SAR(10 g) = 4.71 W/kg**

Smallest distance from peaks to all points 3 dB below = 10 mm

Ratio of SAR at M2 to SAR at M1 = 53.5%

Maximum value of SAR (measured) = 13.9 W/kg

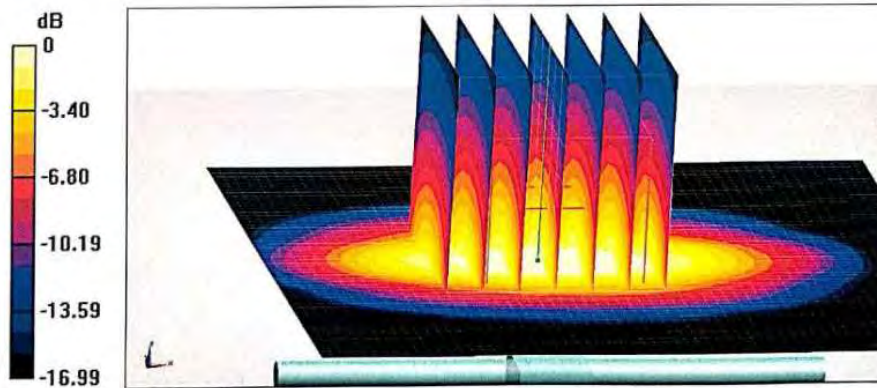

0 dB = 13.9 W/kg = 11.43 dBW/kg

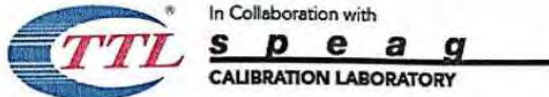

Add: No.51 Xueyuan Road, Haidian District, Beijing, 100191, China  
Tel: +86-10-62304633-2079 Fax: +86-10-62304633-2504  
E-mail: cttl@chinattl.com http://www.chinattl.cn

### Impedance Measurement Plot for Head TSL

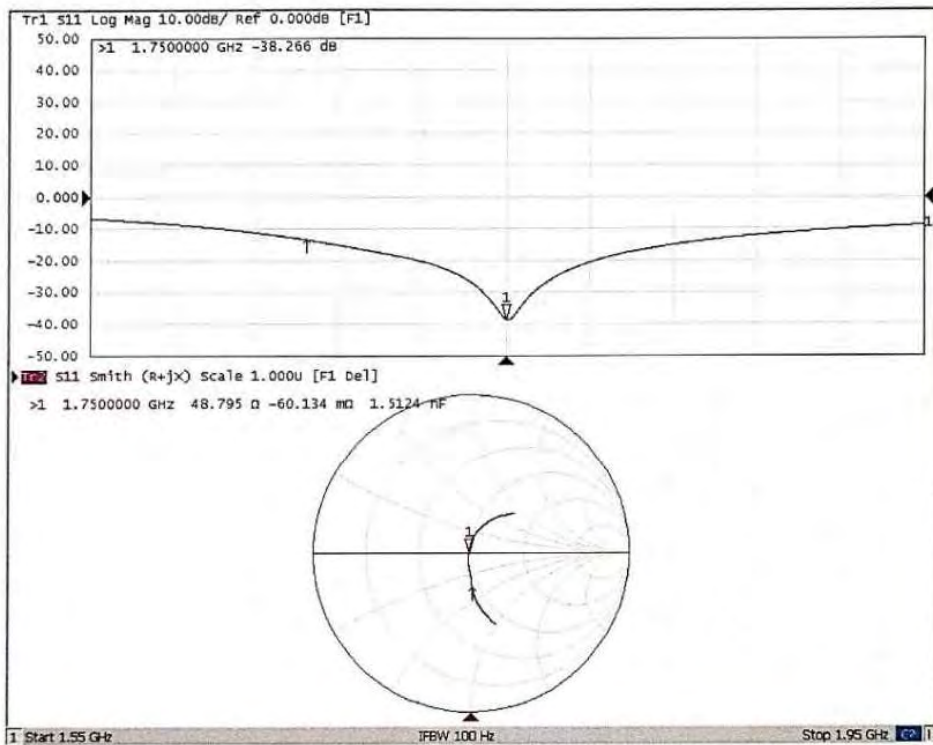



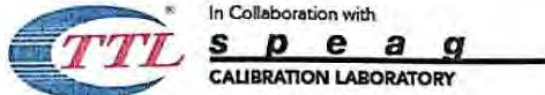

In Collaboration with  
**CTTL** **s p e a g**  
**CALIBRATION LABORATORY**  
 Add: No.51 Xueyuan Road, Haidian District, Beijing, 100191, China  
 Tel: +86-10-62304633-2079 Fax: +86-10-62304633-2504  
 E-mail: cttl@chinattl.com http://www.chinattl.cn

**DASY5 Validation Report for Body TSL**

Date: 02.25.2020

Test Laboratory: CTTL, Beijing, China

**DUT: Dipole 1750 MHz; Type: D1750V2; Serial: D1750V2 - SN: 1033**

Communication System: UID 0, CW; Frequency: 1750 MHz; Duty Cycle: 1:1

Medium parameters used:  $f = 1750$  MHz;  $\sigma = 1.482$  S/m;  $\epsilon_r = 52.35$ ;  $\rho = 1000$  kg/m<sup>3</sup>

Phantom section: Center Section

**DASY5 Configuration:**

- Probe: EX3DV4 - SN3846; ConvF(7.8, 7.8, 7.8) @ 1750 MHz; Calibrated: 2019-03-25
- Sensor-Surface: 1.4mm (Mechanical Surface Detection)
- Electronics: DAE4 Sn1555; Calibrated: 2019-08-22
- Phantom: MFP\_V5.1C (20deg probe tilt); Type: QD 000 P51 Cx; Serial: 1062
- Measurement SW: DASY52, Version 52.10 (4); SEMCAD X Version 14.6.14 (7483)

**System Performance Check/Zoom Scan (7x7x7) (7x7x7)/Cube 0: Measurement grid:**

dx=5mm, dy=5mm, dz=5mm

Reference Value = 94.32 V/m; Power Drift = 0.00 dB

Peak SAR (extrapolated) = 16.9 W/kg

**SAR(1 g) = 9.24 W/kg; SAR(10 g) = 4.95 W/kg**

Smallest distance from peaks to all points 3 dB below = 9.2 mm

Ratio of SAR at M2 to SAR at M1 = 56%

Maximum value of SAR (measured) = 14.1 W/kg

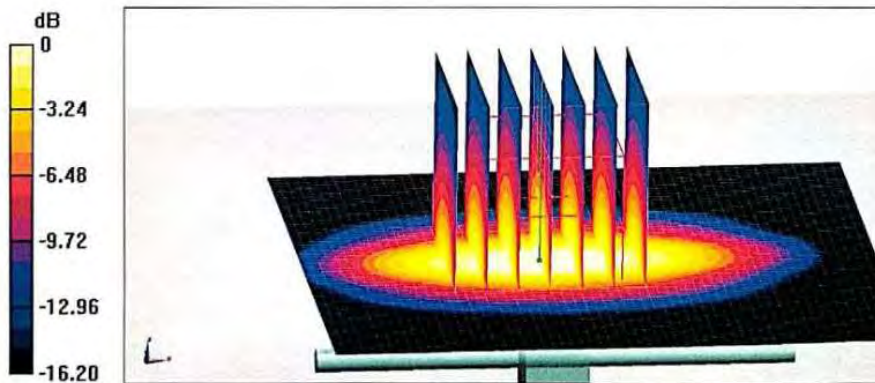

0 dB = 14.1 W/kg = 11.49 dBW/kg

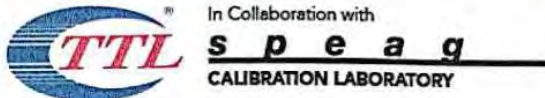

Add: No.51 Xueyuan Road, Haidian District, Beijing, 100191, China  
Tel: +86-10-62304633-2079 Fax: +86-10-62304633-2504  
E-mail: cttl@chinattl.com http://www.chinattl.cn

**Impedance Measurement Plot for Body TSL**

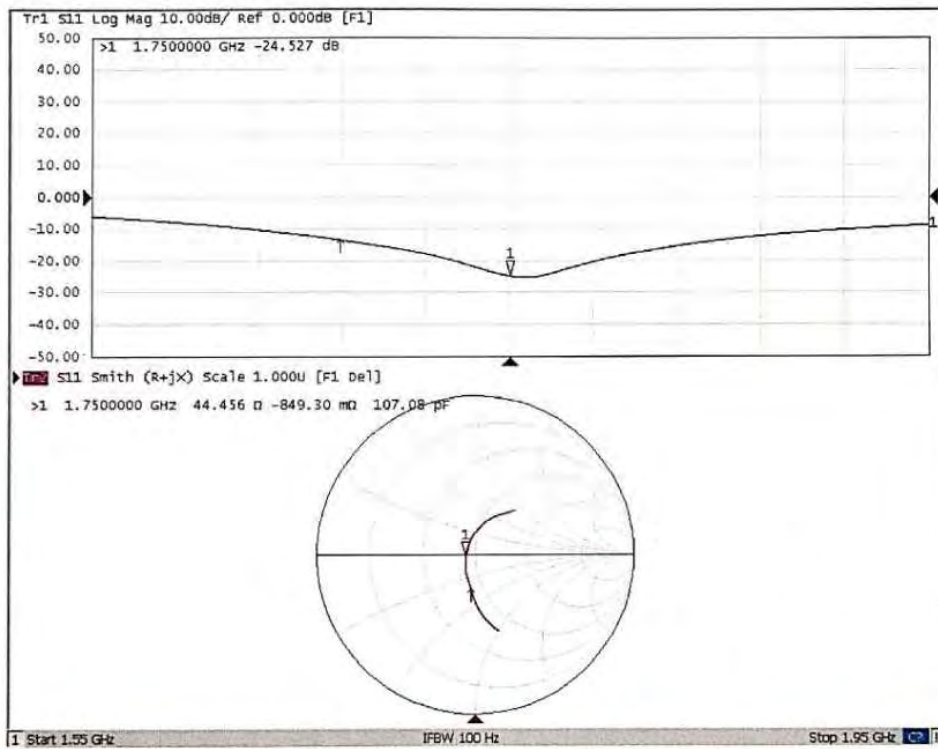



## ANNEX H: D1900V2 Dipole Calibration Certificate



In Collaboration with  
**s p e a g**  
CALIBRATION LABORATORY



中国认可  
国际互认  
校准  
CALIBRATION  
CNAS L0570

Add: No.51 Xueyuan Road, Haidian District, Beijing, 100191, China  
Tel: +86-10-62304633-2079 Fax: +86-10-62304633-2504  
E-mail: cttl@chinattl.com http://www.chinattl.cn

Client TA(Shanghai)

Certificate No: Z20-60297

## CALIBRATION CERTIFICATE

Object D1900V2 - SN: 5d060

Calibration Procedure(s) FF-Z11-003-01  
Calibration Procedures for dipole validation kits

Calibration date: August 27, 2020

This calibration Certificate documents the traceability to national standards, which realize the physical units of measurements(SI). The measurements and the uncertainties with confidence probability are given on the following pages and are part of the certificate.

All calibrations have been conducted in the closed laboratory facility: environment temperature(22±3)°C and humidity<70%.

Calibration Equipment used (M&TE critical for calibration)

| Primary Standards       | ID #       | Cal Date(Calibrated by, Certificate No.) | Scheduled Calibration |
|-------------------------|------------|--|-----------------------|
| Power Meter NRP2        | 106276     | 12-May-20 (CTTL, No.J20X02965)           | May-21                |
| Power sensor NRP6A      | 101369     | 12-May-20 (CTTL, No.J20X02965)           | May-21                |
| Reference Probe EX3DV4  | SN 3617    | 30-Jan-20(SPEAG,No.EX3-3617_Jan20)       | Jan-21                |
| DAE4                    | SN 771     | 10-Feb-20(CTTL-SPEAG,No.Z20-60017)       | Feb-21                |
| Secondary Standards     | ID #       | Cal Date(Calibrated by, Certificate No.) | Scheduled Calibration |
| Signal Generator E4438C | MY49071430 | 25-Feb-20 (CTTL, No.J20X00516)           | Feb-21                |
| NetworkAnalyzer E5071C  | MY46110673 | 10-Feb-20 (CTTL, No.J20X00515)           | Feb-21                |

|                | Name        | Function           | Signature |
|----------------|-------------|--------------------|-----------|
| Calibrated by: | Zhao Jing   | SAR Test Engineer  |           |
| Reviewed by:   | Lin Hao     | SAR Test Engineer  |           |
| Approved by:   | Qi Dianyuan | SAR Project Leader |           |

Issued: September 3, 2020

This calibration certificate shall not be reproduced except in full without written approval of the laboratory.

Certificate No: Z20-60297

Page 1 of 8





In Collaboration with  
**s p e a g**  
CALIBRATION LABORATORY

Add: No.51 Xueyuan Road, Haidian District, Beijing, 100191, China  
Tel: +86-10-62304633-2079 Fax: +86-10-62304633-2504  
E-mail: cttl@chinattl.com http://www.chinattl.cn

**Glossary:**

|       |  |
|-------|--|
| TSL   | tissue simulating liquid                   |
| ConvF | sensitivity in TSL / NORM <sub>x,y,z</sub> |
| N/A   | not applicable or not measured             |

**Calibration is Performed According to the Following Standards:**

- IEEE Std 1528-2013, "IEEE Recommended Practice for Determining the Peak Spatial-Averaged Specific Absorption Rate (SAR) in the Human Head from Wireless Communications Devices: Measurement Techniques", June 2013
- IEC 62209-1, "Measurement procedure for assessment of specific absorption rate of human exposure to radio frequency fields from hand-held and body-mounted wireless communication devices- Part 1: Device used next to the ear (Frequency range of 300MHz to 6GHz)", July 2016
- IEC 62209-2, "Procedure to measure the Specific Absorption Rate (SAR) For wireless communication devices used in close proximity to the human body (frequency range of 30MHz to 6GHz)", March 2010
- KDB865664, SAR Measurement Requirements for 100 MHz to 6 GHz

**Additional Documentation:**

- DASY4/5 System Handbook

**Methods Applied and Interpretation of Parameters:**

- Measurement Conditions:** Further details are available from the Validation Report at the end of the certificate. All figures stated in the certificate are valid at the frequency indicated.
- Antenna Parameters with TSL:** The dipole is mounted with the spacer to position its feed point exactly below the center marking of the flat phantom section, with the arms oriented parallel to the body axis.
- Feed Point Impedance and Return Loss:** These parameters are measured with the dipole positioned under the liquid filled phantom. The impedance stated is transformed from the measurement at the SMA connector to the feed point. The Return Loss ensures low reflected power. No uncertainty required.
- Electrical Delay:** One-way delay between the SMA connector and the antenna feed point. No uncertainty required.
- SAR measured:** SAR measured at the stated antenna input power.
- SAR normalized:** SAR as measured, normalized to an input power of 1 W at the antenna connector.
- SAR for nominal TSL parameters:** The measured TSL parameters are used to calculate the nominal SAR result.

The reported uncertainty of measurement is stated as the standard uncertainty of Measurement multiplied by the coverage factor  $k=2$ , which for a normal distribution Corresponds to a coverage probability of approximately 95%.



Add: No.51 Xueyuan Road, Haidian District, Beijing, 100191, China  
 Tel: +86-10-62304633-2079 Fax: +86-10-62304633-2504  
 E-mail: ett@chinattl.com http://www.chinattl.cn

**Measurement Conditions**

DASY system configuration, as far as not given on page 1.

|                              |                          |             |
|------------------------------|--------------------------|-------------|
| DASY Version                 | DASY52                   | V52.10.4    |
| Extrapolation                | Advanced Extrapolation   |             |
| Phantom                      | Triple Flat Phantom 5.1C |             |
| Distance Dipole Center - TSL | 10 mm                    | with Spacer |
| Zoom Scan Resolution         | dx, dy, dz = 5 mm        |             |
| Frequency                    | 1900 MHz ± 1 MHz         |             |

**Head TSL parameters**

The following parameters and calculations were applied.

|   | Temperature     | Permittivity | Conductivity     |
|---|-----------------|--------------|------------------|
| Nominal Head TSL parameters             | 22.0 °C         | 40.0         | 1.40 mho/m       |
| Measured Head TSL parameters            | (22.0 ± 0.2) °C | 41.1 ± 6 %   | 1.40 mho/m ± 6 % |
| Head TSL temperature change during test | <1.0 °C         | ---          | ---              |

**SAR result with Head TSL**

|   |                    |                                 |
|---|--------------------|---------------------------------|
| SAR averaged over 1 cm <sup>3</sup> (1 g) of Head TSL   | Condition          |                                 |
| SAR measured  | 250 mW input power | 9.82 W/kg                       |
| SAR for nominal Head TSL parameters                     | normalized to 1W   | <b>39.5 W/kg ± 18.8 % (k=2)</b> |
| SAR averaged over 10 cm <sup>3</sup> (10 g) of Head TSL | Condition          |                                 |
| SAR measured  | 250 mW input power | 5.04 W/kg                       |
| SAR for nominal Head TSL parameters                     | normalized to 1W   | <b>20.2 W/kg ± 18.7 % (k=2)</b> |

**Body TSL parameters**

The following parameters and calculations were applied.

|   | Temperature     | Permittivity | Conductivity     |
|---|-----------------|--------------|------------------|
| Nominal Body TSL parameters             | 22.0 °C         | 53.3         | 1.52 mho/m       |
| Measured Body TSL parameters            | (22.0 ± 0.2) °C | 53.5 ± 6 %   | 1.51 mho/m ± 6 % |
| Body TSL temperature change during test | <1.0 °C         | ---          | ---              |

**SAR result with Body TSL**

|   |                    |                                 |
|---|--------------------|---------------------------------|
| SAR averaged over 1 cm <sup>3</sup> (1 g) of Body TSL   | Condition          |                                 |
| SAR measured  | 250 mW input power | 9.89 W/kg                       |
| SAR for nominal Body TSL parameters                     | normalized to 1W   | <b>39.8 W/kg ± 18.8 % (k=2)</b> |
| SAR averaged over 10 cm <sup>3</sup> (10 g) of Body TSL | Condition          |                                 |
| SAR measured  | 250 mW input power | 5.13 W/kg                       |
| SAR for nominal Body TSL parameters                     | normalized to 1W   | <b>20.6 W/kg ± 18.7 % (k=2)</b> |



In Collaboration with  
**s p e a g**  
 CALIBRATION LABORATORY

Add: No.51 Xueyuan Road, Haidian District, Beijing, 100191, China  
 Tel: +86-10-62304633-2079 Fax: +86-10-62304633-2504  
 E-mail: ttl@chinattl.com http://www.chinattl.cn

**Appendix (Additional assessments outside the scope of CNAS L0570)**

**Antenna Parameters with Head TSL**

|                                      |               |
|--------------------------------------|---------------|
| Impedance, transformed to feed point | 52.5Ω+ 6.58jΩ |
| Return Loss                          | - 23.3dB      |

**Antenna Parameters with Body TSL**

|                                      |               |
|--------------------------------------|---------------|
| Impedance, transformed to feed point | 48.0Ω+ 6.72jΩ |
| Return Loss                          | - 22.9dB      |

**General Antenna Parameters and Design**

|                                  |          |
|----------------------------------|----------|
| Electrical Delay (one direction) | 1.061 ns |
|----------------------------------|----------|

After long term use with 100W radiated power, only a slight warming of the dipole near the feedpoint can be measured.

The dipole is made of standard semirigid coaxial cable. The center conductor of the feeding line is directly connected to the second arm of the dipole. The antenna is therefore short-circuited for DC-signals. On some of the dipoles, small end caps are added to the dipole arms in order to improve matching when loaded according to the position as explained in the "Measurement Conditions" paragraph. The SAR data are not affected by this change. The overall dipole length is still according to the Standard. No excessive force must be applied to the dipole arms, because they might bend or the soldered connections near the feedpoint may be damaged.

**Additional EUT Data**

|                 |       |
|-----------------|-------|
| Manufactured by | SPEAG |
|-----------------|-------|



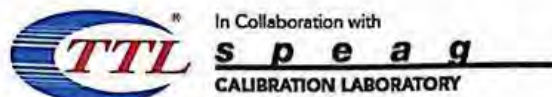

Add: No.51 Xueyuan Road, Haidian District, Beijing, 100191, China  
 Tel: +86-10-62304633-2079 Fax: +86-10-62304633-2504  
 E-mail: cttl@chinattl.com http://www.chinattl.cn

**DASY5 Validation Report for Head TSL**

Date: 08.27.2020

Test Laboratory: CTTL, Beijing, China

**DUT: Dipole 1900 MHz; Type: D1900V2; Serial: D1900V2 - SN: 5d060**

Communication System: UID 0, CW; Frequency: 1900 MHz; Duty Cycle: 1:1

Medium parameters used:  $f = 1900$  MHz;  $\sigma = 1.404$  S/m;  $\epsilon_r = 41.12$ ;  $\rho = 1000$  kg/m<sup>3</sup>

Phantom section: Center Section

**DASY5 Configuration:**

- Probe: EX3DV4 - SN3617; ConvF(8.14, 8.14, 8.14) @ 1900 MHz; Calibrated: 2020-01-30
- Sensor-Surface: 1.4mm (Mechanical Surface Detection)
- Electronics: DAE4 Sn771; Calibrated: 2020-02-10
- Phantom: MFP\_V5.1C (20deg probe tilt); Type: QD 000 P51 Cx; Serial: 1062
- Measurement SW: DASY52, Version 52.10 (4); SEMCAD X Version 14.6.14 (7483)

**System Performance Check/Zoom Scan (7x7x7) (7x7x7)/Cube 0: Measurement grid:**

dx=5mm, dy=5mm, dz=5mm

Reference Value = 100.3 V/m; Power Drift = -0.03 dB

Peak SAR (extrapolated) = 19.0 W/kg

SAR(1 g) = 9.82 W/kg; SAR(10 g) = 5.04 W/kg

Smallest distance from peaks to all points 3 dB below = 10 mm

Ratio of SAR at M2 to SAR at M1 = 51.9%

Maximum value of SAR (measured) = 15.6 W/kg

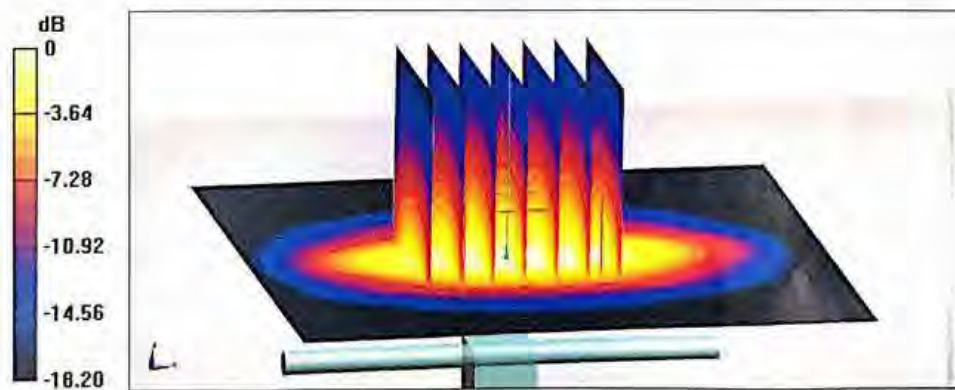

0 dB = 15.6 W/kg = 11.93 dBW/kg



Add: No.51 Xueyuan Road, Haidian District, Beijing, 100191, China  
Tel: +86-10-62304633-2079 Fax: +86-10-62304633-2504  
E-mail: cttl@chinattl.com http://www.chinattl.cn

### Impedance Measurement Plot for Head TSL

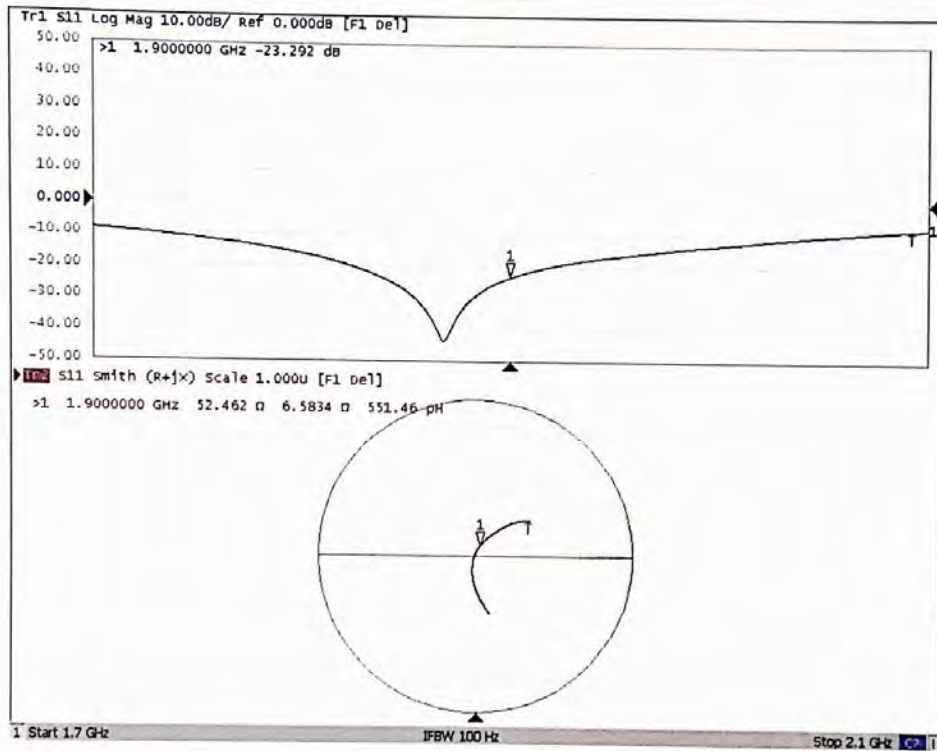

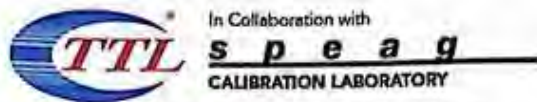

Add: No.51 Xueyuan Road, Haidian District, Beijing, 100191, China  
 Tel: +86-10-62304633-2079 Fax: +86-10-62304633-2504  
 E-mail: ettl@chinattl.com http://www.chinattl.cn

**DASY5 Validation Report for Body TSL**

Date: 08.27.2020

Test Laboratory: CTTL, Beijing, China

**DUT: Dipole 1900 MHz; Type: D1900V2; Serial: D1900V2 - SN: 5d060**

Communication System: UID 0, CW; Frequency: 1900 MHz; Duty Cycle: 1:1

Medium parameters used:  $f = 1900$  MHz;  $\sigma = 1.508$  S/m;  $\epsilon_r = 53.5$ ;  $\rho = 1000$  kg/m<sup>3</sup>

Phantom section: Right Section

**DASY5 Configuration:**

- Probe: EX3DV4 - SN3617; ConvF(7.94, 7.94, 7.94) @ 1900 MHz; Calibrated: 2020-01-30
- Sensor-Surface: 1.4mm (Mechanical Surface Detection)
- Electronics: DAE4 Sn771; Calibrated: 2020-02-10
- Phantom: MFP\_V5.1C (20deg probe tilt); Type: QD 000 P51 Cx; Serial: 1062
- Measurement SW: DASY52, Version 52.10 (4); SEMCAD X Version 14.6.14 (7483)

**System Performance Check/Zoom Scan (7x7x7) (7x7x7)/Cube 0: Measurement grid:**

$dx=5$ mm,  $dy=5$ mm,  $dz=5$ mm

Reference Value = 97.34 V/m; Power Drift = -0.03 dB

Peak SAR (extrapolated) = 18.2 W/kg

SAR(1 g) = 9.89 W/kg; SAR(10 g) = 5.13 W/kg

Smallest distance from peaks to all points 3 dB below = 9 mm

Ratio of SAR at M2 to SAR at M1 = 55.4%

Maximum value of SAR (measured) = 15.3 W/kg

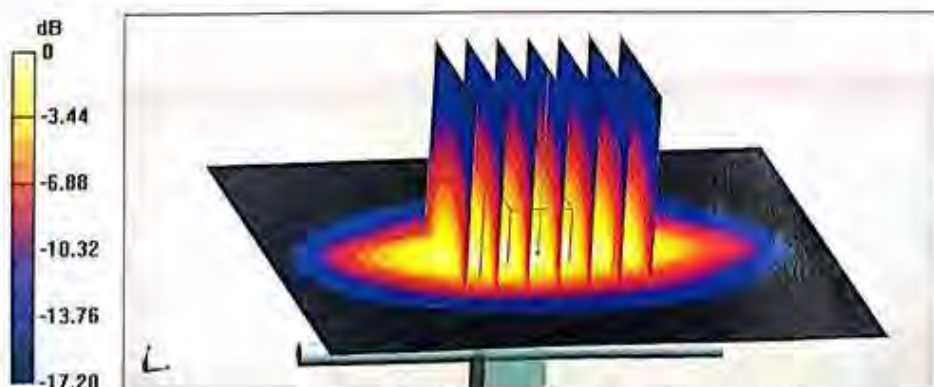

0 dB = 15.3 W/kg = 11.85 dBW/kg



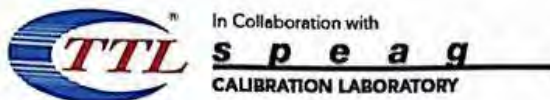

Add: No.51 Xueyuan Road, Haidian District, Beijing, 100191, China  
Tel: +86-10-62304633-2079 Fax: +86-10-62304633-2504  
E-mail: ttl@chinattl.com http://www.chinattl.cn

### Impedance Measurement Plot for Body TSL

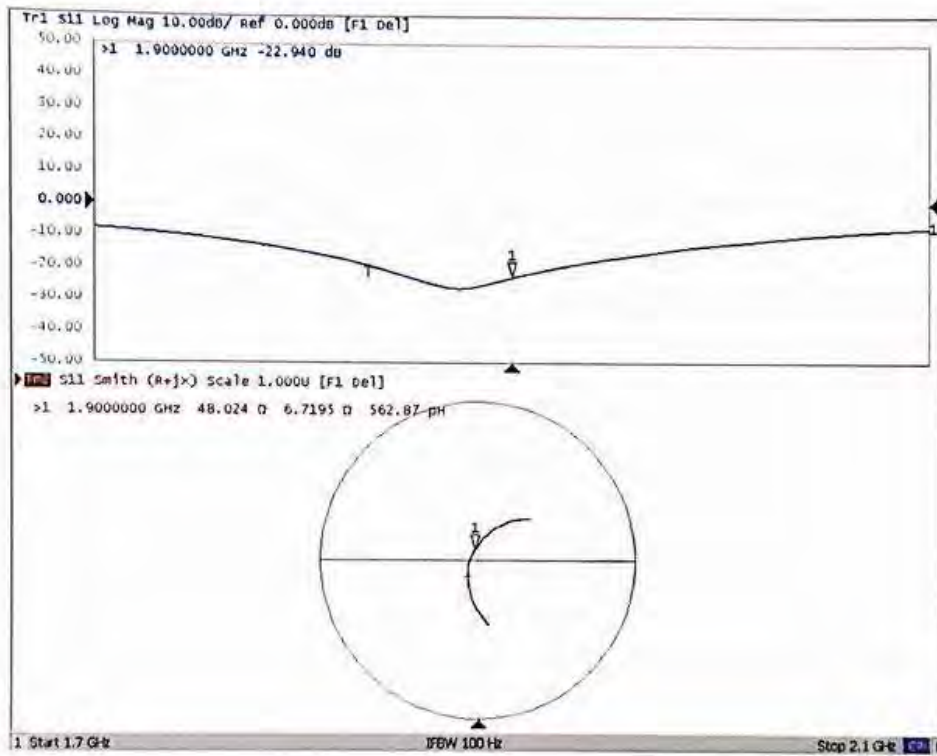



# ANNEX I: D2300V2 Dipole Calibration Certificate

**Calibration Laboratory of  
Schmid & Partner  
Engineering AG**  
Zeughausstrasse 43, 8004 Zurich, Switzerland



**S** Schweizerischer Kalibrierdienst  
**C** Service suisse d'étalonnage  
**S** Servizio svizzero di taratura  
**S** Swiss Calibration Service

Accredited by the Swiss Accreditation Service (SAS)  
The Swiss Accreditation Service is one of the signatories to the EA  
Multilateral Agreement for the recognition of calibration certificates

Accreditation No.: **SCS 0108**

Client **7 layers (Auden)**

Certificate No: **D2300V2-1110\_Sep20**

## CALIBRATION CERTIFICATE

Object **D2300V2 - SN:1110**

Calibration procedure(s) **QA CAL-05.v11  
Calibration Procedure for SAR Validation Sources between 0.7-3 GHz**

Calibration date: **September 28, 2020**

This calibration certificate documents the traceability to national standards, which realize the physical units of measurements (SI).  
The measurements and the uncertainties with confidence probability are given on the following pages and are part of the certificate.

All calibrations have been conducted in the closed laboratory facility: environment temperature ( $22 \pm 3$ )°C and humidity < 70%.

Calibration Equipment used (M&TE critical for calibration)

| Primary Standards           | ID #               | Cal Date (Certificate No.)      | Scheduled Calibration |
|-----------------------------|--------------------|---------------------------------|-----------------------|
| Power meter NRP             | SN: 104778         | 01-Apr-20 (No. 217-03100/03101) | Apr-21                |
| Power sensor NRP-Z91        | SN: 103244         | 01-Apr-20 (No. 217-03100)       | Apr-21                |
| Power sensor NRP-Z91        | SN: 103245         | 01-Apr-20 (No. 217-03101)       | Apr-21                |
| Reference 20 dB Attenuator  | SN: BH9394 (20k)   | 31-Mar-20 (No. 217-03106)       | Apr-21                |
| Type-N mismatch combination | SN: 310982 / 06327 | 31-Mar-20 (No. 217-03104)       | Apr-21                |
| Reference Probe EX3DV4      | SN: 7405           | 29-Jun-20 (No. EX3-7405_Jun20)  | Jun-21                |
| D4E4                        | SN: 601            | 27-Dec-19 (No. D4E4-601_Dec19)  | Dec-20                |

| Secondary Standards             | ID #           | Check Date (in house)             | Scheduled Check        |
|---------------------------------|----------------|-----------------------------------|------------------------|
| Power meter E4419B              | SN: GB39512475 | 30-Oct-14 (in house check Feb-19) | In house check: Oct-20 |
| Power sensor HP 8481A           | SN: US37292783 | 07-Oct-15 (in house check Oct-18) | In house check: Oct-20 |
| Power sensor HP 8481A           | SN: MY41092317 | 07-Oct-15 (in house check Oct-18) | In house check: Oct-20 |
| RF generator R&S SMT-06         | SN: 100972     | 15-Jun-15 (in house check Oct-18) | In house check: Oct-20 |
| Network Analyzer Agilent E8358A | SN: US41080477 | 31-Mar-14 (in house check Oct-19) | In house check: Oct-20 |

|                | Name          | Function              | Signature |
|----------------|---------------|-----------------------|-----------|
| Calibrated by: | Michael Weber | Laboratory Technician |           |
| Approved by:   | Katja Pokovic | Technical Manager     |           |

Issued: September 28, 2020

This calibration certificate shall not be reproduced except in full without written approval of the laboratory.

**Calibration Laboratory of  
Schmid & Partner  
Engineering AG**  
Zeughausstrasse 43, 8004 Zurich, Switzerland



**S** Schweizerischer Kalibrierdienst  
**S** Service suisse d'étalonnage  
**C** Servizio svizzero di taratura  
**S** Swiss Calibration Service

Accredited by the Swiss Accreditation Service (SAS)  
The Swiss Accreditation Service is one of the signatories to the EA  
Multilateral Agreement for the recognition of calibration certificates

Accreditation No.: **SCS 0108**

#### Glossary:

|       |                                 |
|-------|---------------------------------|
| TSL   | tissue simulating liquid        |
| ConvF | sensitivity in TSL / NORM x,y,z |
| N/A   | not applicable or not measured  |

#### Calibration is Performed According to the Following Standards:

- IEEE Std 1528-2013, "IEEE Recommended Practice for Determining the Peak Spatial-Averaged Specific Absorption Rate (SAR) in the Human Head from Wireless Communications Devices: Measurement Techniques", June 2013
- IEC 62209-1, "Measurement procedure for the assessment of Specific Absorption Rate (SAR) from hand-held and body-mounted devices used next to the ear (frequency range of 300 MHz to 6 GHz)", July 2016
- IEC 62209-2, "Procedure to determine the Specific Absorption Rate (SAR) for wireless communication devices used in close proximity to the human body (frequency range of 30 MHz to 6 GHz)", March 2010
- KDB 865664, "SAR Measurement Requirements for 100 MHz to 6 GHz"

#### Additional Documentation:

- DASY4/5 System Handbook

#### Methods Applied and Interpretation of Parameters:

- Measurement Conditions:* Further details are available from the Validation Report at the end of the certificate. All figures stated in the certificate are valid at the frequency indicated.
- Antenna Parameters with TSL:* The dipole is mounted with the spacer to position its feed point exactly below the center marking of the flat phantom section, with the arms oriented parallel to the body axis.
- Feed Point Impedance and Return Loss:* These parameters are measured with the dipole positioned under the liquid filled phantom. The impedance stated is transformed from the measurement at the SMA connector to the feed point. The Return Loss ensures low reflected power. No uncertainty required.
- Electrical Delay:* One-way delay between the SMA connector and the antenna feed point. No uncertainty required.
- SAR measured:* SAR measured at the stated antenna input power.
- SAR normalized:* SAR as measured, normalized to an input power of 1 W at the antenna connector.
- SAR for nominal TSL parameters:* The measured TSL parameters are used to calculate the nominal SAR result.

The reported uncertainty of measurement is stated as the standard uncertainty of measurement multiplied by the coverage factor  $k=2$ , which for a normal distribution corresponds to a coverage probability of approximately 95%.



**Measurement Conditions**

DASY system configuration, as far as not given on page 1.

|                              |                        |             |
|------------------------------|------------------------|-------------|
| DASY Version                 | DASY5                  | V52.10.4    |
| Extrapolation                | Advanced Extrapolation |             |
| Phantom                      | Modular Flat Phantom   |             |
| Distance Dipole Center - TSL | 10 mm                  | with Spacer |
| Zoom Scan Resolution         | dx, dy, dz = 5 mm      |             |
| Frequency                    | 2300 MHz $\pm$ 1 MHz   |             |

**Head TSL parameters**

The following parameters and calculations were applied.

|   | Temperature         | Permittivity   | Conductivity         |
|---|---------------------|----------------|----------------------|
| Nominal Head TSL parameters             | 22.0 °C             | 39.5           | 1.67 mho/m           |
| Measured Head TSL parameters            | (22.0 $\pm$ 0.2) °C | 38.8 $\pm$ 6 % | 1.68 mho/m $\pm$ 6 % |
| Head TSL temperature change during test | < 0.5 °C            | ----           | ----                 |

**SAR result with Head TSL**

| SAR averaged over 1 cm <sup>3</sup> (1 g) of Head TSL | Condition          |  |
|---|--------------------|--|
| SAR measured  | 250 mW input power | 12.0 W/kg                                      |
| SAR for nominal Head TSL parameters                   | normalized to 1W   | <b>47.7 W/kg <math>\pm</math> 17.0 % (k=2)</b> |

| SAR averaged over 10 cm <sup>3</sup> (10 g) of Head TSL | condition          |  |
|---|--------------------|--|
| SAR measured  | 250 mW input power | 5.77 W/kg                                      |
| SAR for nominal Head TSL parameters                     | normalized to 1W   | <b>23.0 W/kg <math>\pm</math> 16.5 % (k=2)</b> |

**Appendix (Additional assessments outside the scope of SCS 0108)**

**Antenna Parameters with Head TSL**

|                                      |                                |
|--------------------------------------|--------------------------------|
| Impedance, transformed to feed point | 48.2 $\Omega$ + 3.8 j $\Omega$ |
| Return Loss                          | - 27.5 dB                      |

**General Antenna Parameters and Design**

|                                  |          |
|----------------------------------|----------|
| Electrical Delay (one direction) | 1.165 ns |
|----------------------------------|----------|

After long term use with 100W radiated power, only a slight warming of the dipole near the feedpoint can be measured.

The dipole is made of standard semirigid coaxial cable. The center conductor of the feeding line is directly connected to the second arm of the dipole. The antenna is therefore short-circuited for DC-signals. On some of the dipoles, small end caps are added to the dipole arms in order to improve matching when loaded according to the position as explained in the "Measurement Conditions" paragraph. The SAR data are not affected by this change. The overall dipole length is still according to the Standard.

No excessive force must be applied to the dipole arms, because they might bend or the soldered connections near the feedpoint may be damaged.

**Additional EUT Data**

|                 |       |
|-----------------|-------|
| Manufactured by | SPEAG |
|-----------------|-------|

**DASY5 Validation Report for Head TSL**

Date: 28.09.2020

Test Laboratory: SPEAG, Zurich, Switzerland

**DUT: Dipole 2300 MHz; Type: D2300V2; Serial: D2300V2 - SN:1110**

Communication System: UID 0 - CW; Frequency: 2300 MHz  
 Medium parameters used:  $f = 2300$  MHz;  $\sigma = 1.68$  S/m;  $\epsilon_r = 38.8$ ;  $\rho = 1000$  kg/m<sup>3</sup>  
 Phantom section: Flat Section  
 Measurement Standard: DASY5 (IEEE/IEC/ANSI C63.19-2011)

DASY52 Configuration:

- Probe: EX3DV4 - SN7405; ConvF(8.03, 8.03, 8.03) @ 2300 MHz; Calibrated: 29.06.2020
- Sensor-Surface: 1.4mm (Mechanical Surface Detection)
- Electronics: DAE4 Sn601; Calibrated: 27.12.2019
- Phantom: Flat Phantom 5.0 (front); Type: QD 000 P50 AA; Serial: 1001
- DASY52 52.10.4(1527); SEMCAD X 14.6.14(7483)

**Dipole Calibration for Head Tissue/Pin=250 mW, d=10mm/Zoom Scan (7x7x7)/Cube 0:**

Measurement grid:  $dx=5$ mm,  $dy=5$ mm,  $dz=5$ mm  
 Reference Value = 112.8 V/m; Power Drift = 0.01 dB  
 Peak SAR (extrapolated) = 23.4 W/kg  
**SAR(1 g) = 12 W/kg; SAR(10 g) = 5.77 W/kg**  
 Smallest distance from peaks to all points 3 dB below = 9 mm  
 Ratio of SAR at M2 to SAR at M1 = 51.8%  
 Maximum value of SAR (measured) = 19.5 W/kg

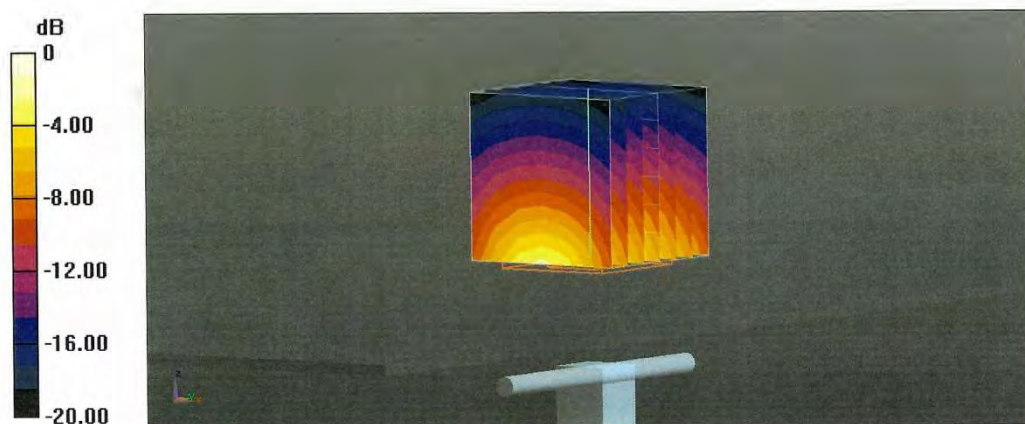





### Impedance Measurement Plot for Head TSL

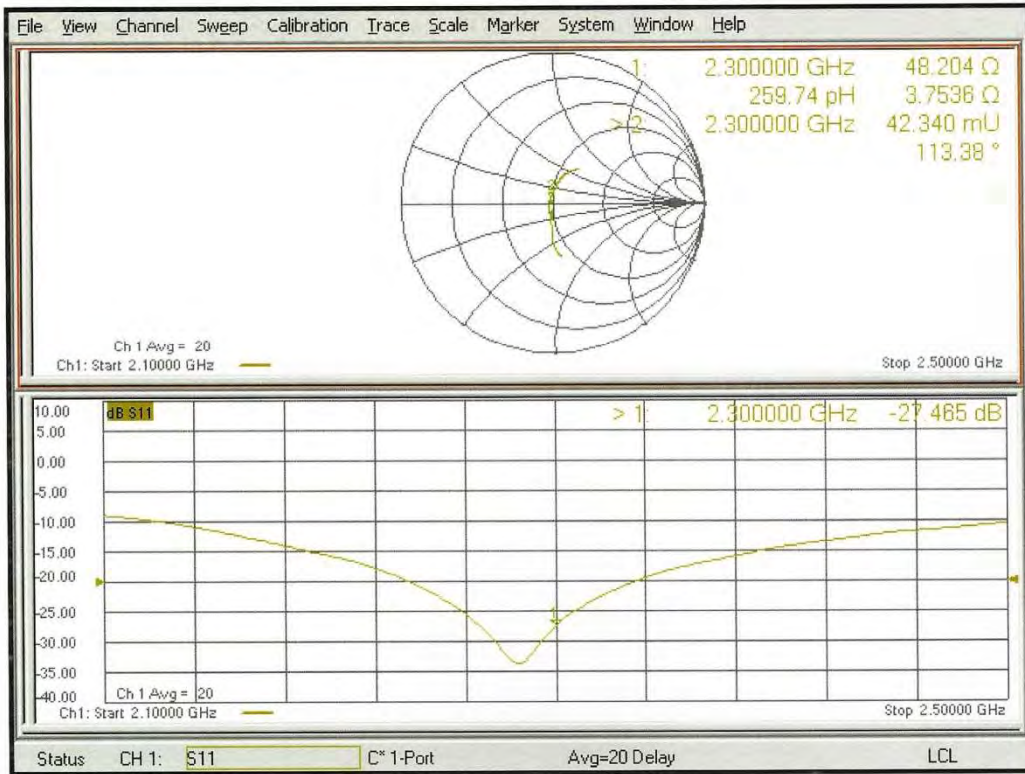



## ANNEX J: D2450V2 Dipole Calibration Certificate



In Collaboration with  
**s p e a g**  
CALIBRATION LABORATORY



中国认可  
国际互认  
校准  
CALIBRATION  
CNAS L0570

Add: No.51 Xueyuan Road, Haidian District, Beijing, 100191, China  
Tel: +86-10-62304633-2079 Fax: +86-10-62304633-2504  
E-mail: cttl@chinattl.com http://www.chinattl.cn

Client **TA(Shanghai)**Certificate No: **Z20-60298****CALIBRATION CERTIFICATE**Object **D2450V2 - SN: 786**Calibration Procedure(s) **FF-Z11-003-01  
Calibration Procedures for dipole validation kits**Calibration date: **August 27, 2020**

This calibration Certificate documents the traceability to national standards, which realize the physical units of measurements(SI). The measurements and the uncertainties with confidence probability are given on the following pages and are part of the certificate.

All calibrations have been conducted in the closed laboratory facility: environment temperature(22±3)°C and humidity<70%.

Calibration Equipment used (M&amp;TE critical for calibration)

| Primary Standards       | ID #       | Cal Date(Calibrated by, Certificate No.) | Scheduled Calibration |
|-------------------------|------------|--|-----------------------|
| Power Meter NRP2        | 106276     | 12-May-20 (CTTL, No.J20X02965)           | May-21                |
| Power sensor NRP6A      | 101369     | 12-May-20 (CTTL, No.J20X02965)           | May-21                |
| Reference Probe EX3DVB4 | SN 3617    | 30-Jan-20(SPEAG, No.EX3-3617_Jan20)      | Jan-21                |
| DAE4                    | SN 771     | 10-Feb-20(CTTL-SPEAG, No.Z20-60017)      | Feb-21                |
| Secondary Standards     | ID #       | Cal Date(Calibrated by, Certificate No.) | Scheduled Calibration |
| Signal Generator E4438C | MY49071430 | 25-Feb-20 (CTTL, No.J20X00516)           | Feb-21                |
| NetworkAnalyzer E5071C  | MY46107873 | 10-Feb-20 (CTTL, No.J20X00515)           | Feb-21                |

|                | Name        | Function           | Signature |
|----------------|-------------|--------------------|-----------|
| Calibrated by: | Zhao Jing   | SAR Test Engineer  |           |
| Reviewed by:   | Lin Hao     | SAR Test Engineer  |           |
| Approved by:   | Qi Dianyuan | SAR Project Leader |           |

Issued: September 2, 2020

This calibration certificate shall not be reproduced except in full without written approval of the laboratory.



In Collaboration with  
**s p e a q**  
CALIBRATION LABORATORY

Add: No.51 Xueyuan Road, Haidian District, Beijing, 100191, China  
Tel: +86-10-62304633-2079 Fax: +86-10-62304633-2504  
E-mail: cttl@chinattl.com http://www.chinattl.cn

**Glossary:**

|       |  |
|-------|--|
| TSL   | tissue simulating liquid                   |
| ConvF | sensitivity in TSL / NORM <sub>x,y,z</sub> |
| N/A   | not applicable or not measured             |

**Calibration is Performed According to the Following Standards:**

- IEEE Std 1528-2013, "IEEE Recommended Practice for Determining the Peak Spatial-Averaged Specific Absorption Rate (SAR) in the Human Head from Wireless Communications Devices: Measurement Techniques", September 2013
- IEC 62209-1, "Measurement procedure for assessment of specific absorption rate of human exposure to radio frequency fields from hand-held and body-mounted wireless communication devices- Part 1: Device used next to the ear (Frequency range of 300MHz to 6GHz)", July 2016
- IEC 62209-2, "Procedure to measure the Specific Absorption Rate (SAR) For wireless communication devices used in close proximity to the human body (frequency range of 30MHz to 6GHz)", March 2010
- KDB865664, SAR Measurement Requirements for 100 MHz to 6 GHz

**Additional Documentation:**

- DASY4/5 System Handbook

**Methods Applied and Interpretation of Parameters:**

- Measurement Conditions:** Further details are available from the Validation Report at the end of the certificate. All figures stated in the certificate are valid at the frequency indicated.
- Antenna Parameters with TSL:** The dipole is mounted with the spacer to position its feed point exactly below the center marking of the flat phantom section, with the arms oriented parallel to the body axis.
- Feed Point Impedance and Return Loss:** These parameters are measured with the dipole positioned under the liquid filled phantom. The impedance stated is transformed from the measurement at the SMA connector to the feed point. The Return Loss ensures low reflected power. No uncertainty required.
- Electrical Delay:** One-way delay between the SMA connector and the antenna feed point. No uncertainty required.
- SAR measured:** SAR measured at the stated antenna input power.
- SAR normalized:** SAR as measured, normalized to an input power of 1 W at the antenna connector.
- SAR for nominal TSL parameters:** The measured TSL parameters are used to calculate the nominal SAR result.

The reported uncertainty of measurement is stated as the standard uncertainty of Measurement multiplied by the coverage factor  $k=2$ , which for a normal distribution Corresponds to a coverage probability of approximately 95%.





In Collaboration with  
**s p e a g**  
CALIBRATION LABORATORY

Add: No.51 Xueyuan Road, Haidian District, Beijing, 100191, China  
Tel: +86-10-62304633-2079 Fax: +86-10-62304633-2504  
E-mail: cttl@chinattl.com http://www.chinattl.cn

**Measurement Conditions**

DASY system configuration, as far as not given on page 1.

|                              |                          |             |
|------------------------------|--------------------------|-------------|
| DASY Version                 | DASY52                   | V52.10.4    |
| Extrapolation                | Advanced Extrapolation   |             |
| Phantom                      | Triple Flat Phantom 5.1C |             |
| Distance Dipole Center - TSL | 10 mm                    | with Spacer |
| Zoom Scan Resolution         | dx, dy, dz = 5 mm        |             |
| Frequency                    | 2450 MHz ± 1 MHz         |             |

**Head TSL parameters**

The following parameters and calculations were applied.

|   | Temperature     | Permittivity | Conductivity     |
|---|-----------------|--------------|------------------|
| Nominal Head TSL parameters             | 22.0 °C         | 39.2         | 1.80 mho/m       |
| Measured Head TSL parameters            | (22.0 ± 0.2) °C | 39.5 ± 6 %   | 1.79 mho/m ± 6 % |
| Head TSL temperature change during test | <1.0 °C         | ---          | ---              |

**SAR result with Head TSL**

| SAR averaged over 1 cm <sup>3</sup> (1 g) of Head TSL   | Condition          |                          |
|---|--------------------|--------------------------|
| SAR measured  | 250 mW input power | 13.0 W/kg                |
| SAR for nominal Head TSL parameters                     | normalized to 1W   | 52.3 W/kg ± 18.8 % (k=2) |
| SAR averaged over 10 cm <sup>3</sup> (10 g) of Head TSL | Condition          |                          |
| SAR measured  | 250 mW input power | 5.99 W/kg                |
| SAR for nominal Head TSL parameters                     | normalized to 1W   | 24.0 W/kg ± 18.7 % (k=2) |

**Body TSL parameters**

The following parameters and calculations were applied.

|   | Temperature     | Permittivity | Conductivity     |
|---|-----------------|--------------|------------------|
| Nominal Body TSL parameters             | 22.0 °C         | 52.7         | 1.95 mho/m       |
| Measured Body TSL parameters            | (22.0 ± 0.2) °C | 52.1 ± 6 %   | 1.94 mho/m ± 6 % |
| Body TSL temperature change during test | <1.0 °C         | ---          | ---              |

**SAR result with Body TSL**

| SAR averaged over 1 cm <sup>3</sup> (1 g) of Body TSL   | Condition          |                          |
|---|--------------------|--------------------------|
| SAR measured  | 250 mW input power | 13.1 W/kg                |
| SAR for nominal Body TSL parameters                     | normalized to 1W   | 52.4 W/kg ± 18.8 % (k=2) |
| SAR averaged over 10 cm <sup>3</sup> (10 g) of Body TSL | Condition          |                          |
| SAR measured  | 250 mW input power | 6.08 W/kg                |
| SAR for nominal Body TSL parameters                     | normalized to 1W   | 24.3 W/kg ± 18.7 % (k=2) |



In Collaboration with  
**s p e a g**  
 CALIBRATION LABORATORY

Add: No.51 Xueyuan Road, Haidian District, Beijing, 100191, China  
 Tel: +86-10-62304633-2079 Fax: +86-10-62304633-2504  
 E-mail: cttl@chinattl.com http://www.chinattl.cn

**Appendix (Additional assessments outside the scope of CNAS L0570)**

**Antenna Parameters with Head TSL**

|                                      |                |
|--------------------------------------|----------------|
| Impedance, transformed to feed point | 54.5Ω+ 1.44 jΩ |
| Return Loss                          | - 26.9dB       |

**Antenna Parameters with Body TSL**

|                                      |                |
|--------------------------------------|----------------|
| Impedance, transformed to feed point | 50.9Ω+ 5.09 jΩ |
| Return Loss                          | - 25.8dB       |

**General Antenna Parameters and Design**

|                                  |          |
|----------------------------------|----------|
| Electrical Delay (one direction) | 1.018 ns |
|----------------------------------|----------|

After long term use with 100W radiated power, only a slight warming of the dipole near the feedpoint can be measured.

The dipole is made of standard semirigid coaxial cable. The center conductor of the feeding line is directly connected to the second arm of the dipole. The antenna is therefore short-circuited for DC-signals. On some of the dipoles, small end caps are added to the dipole arms in order to improve matching when loaded according to the position as explained in the "Measurement Conditions" paragraph. The SAR data are not affected by this change. The overall dipole length is still according to the Standard. No excessive force must be applied to the dipole arms, because they might bend or the soldered connections near the feedpoint may be damaged.

**Additional EUT Data**

|                 |       |
|-----------------|-------|
| Manufactured by | SPEAG |
|-----------------|-------|



In Collaboration with  
**s p e a g**  
CALIBRATION LABORATORY

Add: No.51 Xueyuan Road, Haidian District, Beijing, 100191, China  
Tel: +86-10-62304633-2079 Fax: +86-10-62304633-2504  
E-mail: cttl@chinattl.com http://www.chinattl.cn

**DASY5 Validation Report for Head TSL**

Date: 08.27.2020

Test Laboratory: CTTL, Beijing, China

**DUT: Dipole 2450 MHz; Type: D2450V2; Serial: D2450V2 - SN: 786**

Communication System: UID 0, CW; Frequency: 2450 MHz; Duty Cycle: 1:1

Medium parameters used:  $f = 2450 \text{ MHz}$ ;  $\sigma = 1.787 \text{ S/m}$ ;  $\epsilon_r = 39.53$ ;  $\rho = 1000 \text{ kg/m}^3$

Phantom section: Center Section

DASY5 Configuration:

- Probe: EX3DV4 - SN3617; ConvF(7.65, 7.65, 7.65) @ 2450 MHz; Calibrated: 2020-01-30
- Sensor-Surface: 1.4mm (Mechanical Surface Detection)
- Electronics: DAE4 Sn771; Calibrated: 2020-02-10
- Phantom: MFP\_V5.1C (20deg probe tilt); Type: QD 000 P51 Cx; Serial: 1062
- Measurement SW: DASY52, Version 52.10 (4); SEMCAD X Version 14.6.14 (7483)

**Dipole Calibration/Zoom Scan (7x7x7) (7x7x7)/Cube 0:** Measurement grid: dx=5mm, dy=5mm, dz=5mm

Reference Value = 102.7 V/m; Power Drift = -0.04 dB

Peak SAR (extrapolated) = 27.7 W/kg

**SAR(1 g) = 13 W/kg; SAR(10 g) = 5.99 W/kg**

Smallest distance from peaks to all points 3 dB below = 8.9 mm

Ratio of SAR at M2 to SAR at M1 = 47%

Maximum value of SAR (measured) = 22.0 W/kg

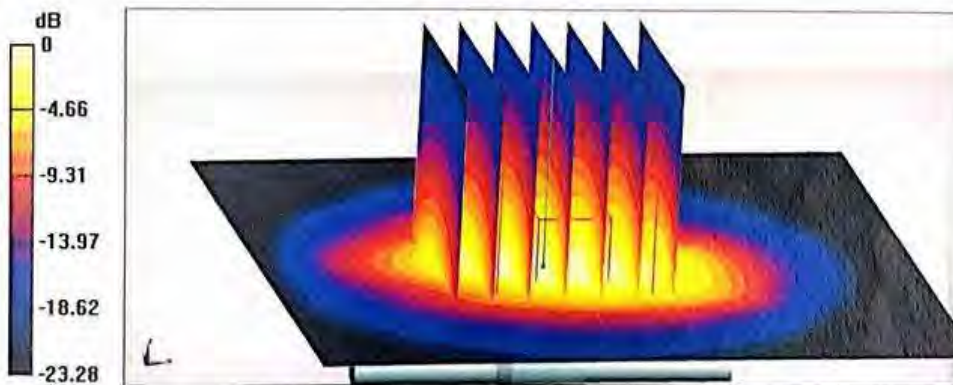

0 dB = 22.0 W/kg = 13.42 dBW/kg





In Collaboration with  
**s p e a g**  
CALIBRATION LABORATORY

Add: No.51 Xueyuan Road, Haidian District, Beijing, 100191, China  
Tel: +86-10-62304633-2079 Fax: +86-10-62304633-2504  
E-mail: cttl@chinattl.com http://www.chinattl.cn

### Impedance Measurement Plot for Head TSL

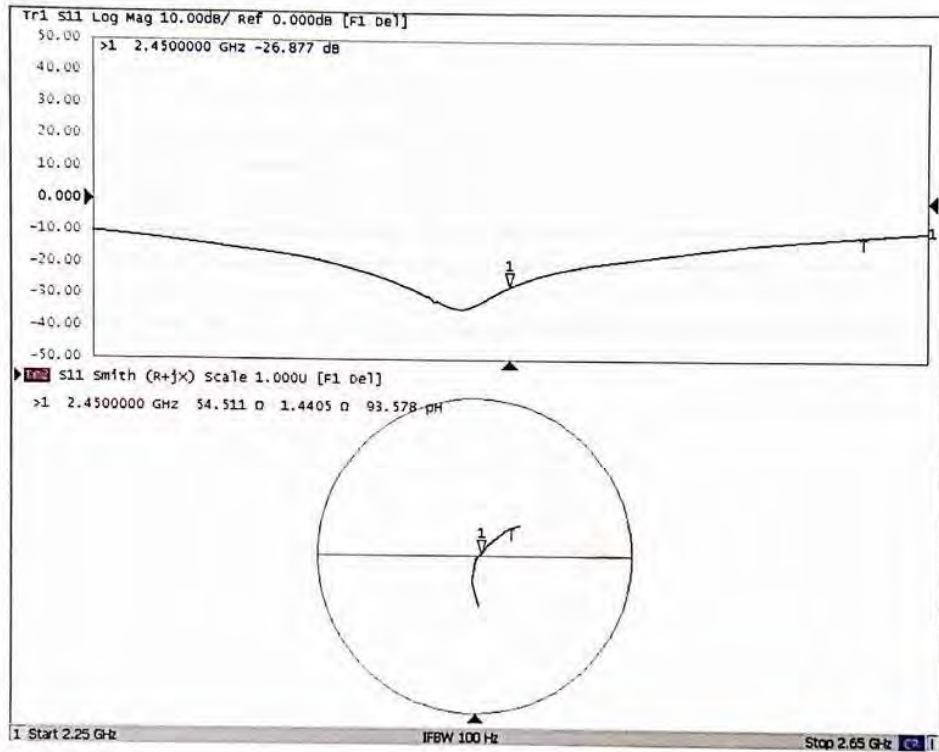



In Collaboration with  
**s p e a g**  
CALIBRATION LABORATORY

Add: No.51 Xueyuan Road, Haidian District, Beijing, 100191, China  
Tel: +86-10-62304633-2079 Fax: +86-10-62304633-2504  
E-mail: ttl@chinattf.com http://www.chinattf.cn

**DASY5 Validation Report for Body TSL.**

Date: 08.27.2020

Test Laboratory: CTTL, Beijing, China

**DUT: Dipole 2450 MHz; Type: D2450V2; Serial: D2450V2 - SN: 786**

Communication System: UID 0, CW; Frequency: 2450 MHz; Duty Cycle: 1:1

Medium parameters used:  $f = 2450$  MHz;  $\sigma = 1.938$  S/m;  $\epsilon_r = 52.06$ ;  $\rho = 1000$  kg/m<sup>3</sup>

Phantom section: Right Section

**DASY5 Configuration:**

- Probe: EX3DV4 - SN3617; ConvF(7.76, 7.76, 7.76) @ 2450 MHz; Calibrated: 2020-01-30
- Sensor-Surface: 1.4mm (Mechanical Surface Detection)
- Electronics: DAE4 Sn771; Calibrated: 2020-02-10
- Phantom: MFP\_V5.IC (20deg probe tilt); Type: QD 000 P51 Cx; Serial: 1062
- Measurement SW: DASY52, Version 52.10 (4); SEMCAD X Version 14.6.14 (7483)

**Dipole Calibration/Zoom Scan (7x7x7) (7x7x7)/Cube 0: Measurement grid: dx=5mm, dy=5mm, dz=5mm**

Reference Value = 102.9 V/m; Power Drift = -0.03 dB

Peak SAR (extrapolated) = 26.9 W/kg

**SAR(1 g) = 13.1 W/kg; SAR(10 g) = 6.08 W/kg**

Smallest distance from peaks to all points 3 dB below = 8.5 mm

Ratio of SAR at M2 to SAR at M1 = 49.9%

Maximum value of SAR (measured) = 21.8 W/kg

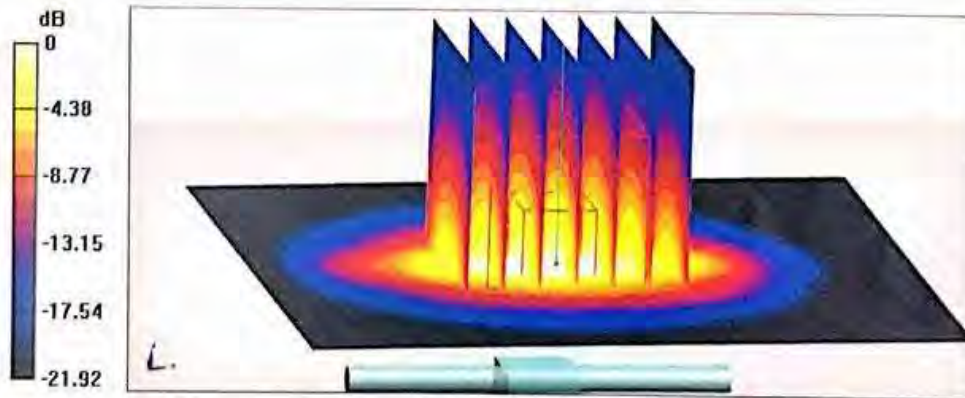

0 dB = 21.8 W/kg = 13.38 dBW/kg



In Collaboration with  
**s p e a g**  
CALIBRATION LABORATORY

Add: No.51 Xueyuan Road, Haidian District, Beijing, 100191, China  
Tel: +86-10-62304633-2079 Fax: +86-10-62304633-2504  
E-mail: ettl@chinattl.com http://www.chinattl.cn

### Impedance Measurement Plot for Body TSL

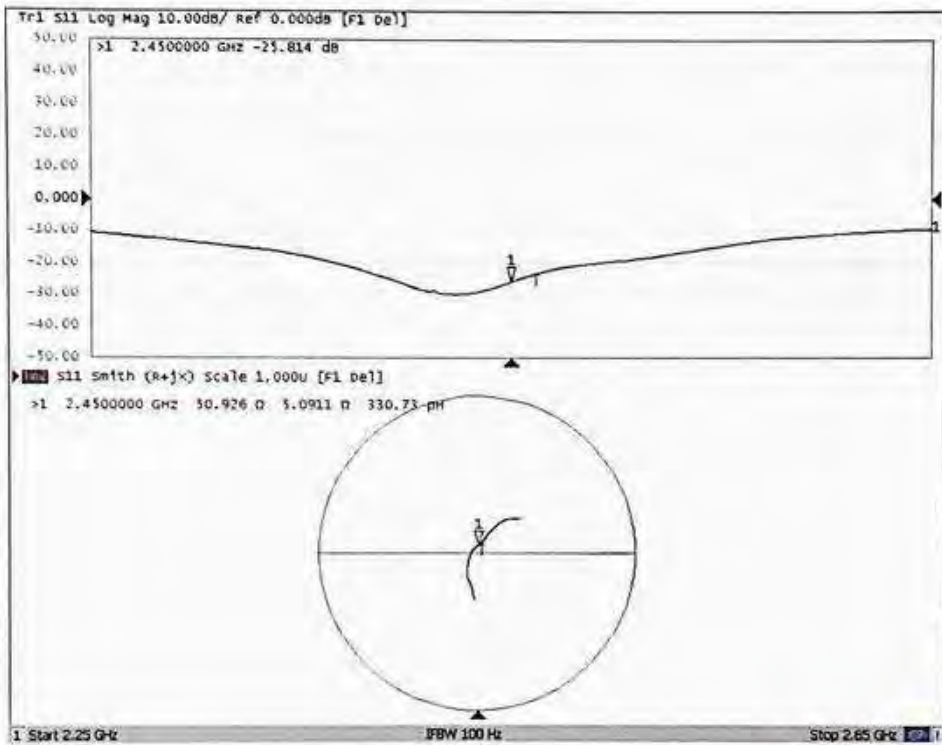





## ANNEX K: D2600V2 Dipole Calibration Certificate



In Collaboration with  
**s p e a g**  
CALIBRATION LABORATORY

Add: No.52 HuaYuanBei Road, Haidian District, Beijing, 100191, Chi  
Tel: +86-10-62304633-2079 Fax: +86-10-62304633-2504  
E-mail: cntl@chinattl.com http://www.chinattl.cn



中国认可  
国际互认  
校准  
CALIBRATION  
CNAS L0570

Client TA(Shanghai)

Certificate No: Z21-60156

## CALIBRATION CERTIFICATE

Object D2600V2 - SN: 1025

Calibration Procedure(s)  
FF-Z11-003-01  
Calibration Procedures for dipole validation kits

Calibration date: April 23, 2021

This calibration Certificate documents the traceability to national standards, which realize the physical units of measurements (SI). The measurements and the uncertainties with confidence probability are given on the following pages and are part of the certificate.

All calibrations have been conducted in the closed laboratory facility: environment temperature (22±3)°C and humidity<70%.

Calibration Equipment used (M&amp;TE critical for calibration)

| Primary Standards       | ID #       | Cal Date(Calibrated by, Certificate No.) | Scheduled Calibration |
|-------------------------|------------|--|-----------------------|
| Power Meter NRP2        | 106276     | 12-May-20 (CTTL, No.J20X02965)           | May-21                |
| Power sensor NRP6A      | 101399     | 12-May-20 (CTTL, No.J20X02965)           | May-21                |
| Reference Probe EX3DV4  | SN 3517    | 27-Jan-21(SPEAG,No EX3-3617_Jan21)       | Jan-22                |
| DAE4                    | SN 777     | 08-Jan-21(CTTL-SPEAG,No.Z21-60003)       | Jan-22                |
| Secondary Standards     | ID #       | Cal Date(Calibrated by, Certificate No.) | Scheduled Calibration |
| Signal Generator E4438C | MY49071430 | 01-Feb-21 (CTTL, No.J21X00593)           | Jan-22                |
| Network Analyzer E5071C | MY46110573 | 14-Jan-21 (CTTL, No.J21X00232)           | Jan-22                |

|                | Name        | Function           | Signature |
|----------------|-------------|--------------------|-----------|
| Calibrated by: | Zhao Jing   | SAR Test Engineer  |           |
| Reviewed by:   | Lin Hao     | SAR Test Engineer  |           |
| Approved by:   | Qi Dianyuan | SAR Project Leader |           |

Issued: April 29, 2021

This calibration certificate shall not be reproduced except in full without written approval of the laboratory.

Certificate No: Z21-60156

Page 1 of 6

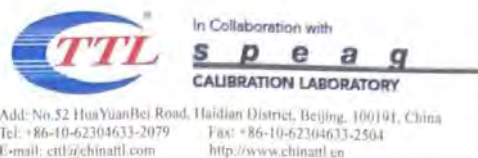
**Glossary:**

|       |  |
|-------|--|
| TSL   | tissue simulating liquid                   |
| ConvF | sensitivity in TSL / NORM <sub>x,y,z</sub> |
| N/A   | not applicable or not measured             |

**Calibration is Performed According to the Following Standards:**

- IEEE Std 1528-2013, "IEEE Recommended Practice for Determining the Peak Spatial-Averaged Specific Absorption Rate (SAR) in the Human Head from Wireless Communications Devices: Measurement Techniques", June 2013
- IEC 62209-1, "Measurement procedure for assessment of specific absorption rate of human exposure to radio frequency fields from hand-held and body-mounted wireless communication devices- Part 1: Device used next to the ear (Frequency range of 300MHz to 6GHz)", July 2016
- IEC 62209-2, "Procedure to measure the Specific Absorption Rate (SAR) For wireless communication devices used in close proximity to the human body (frequency range of 30MHz to 6GHz)", March 2010
- KDB865664, SAR Measurement Requirements for 100 MHz to 6 GHz

**Additional Documentation:**

- DASY4/5 System Handbook

**Methods Applied and Interpretation of Parameters:**

- Measurement Conditions:** Further details are available from the Validation Report at the end of the certificate. All figures stated in the certificate are valid at the frequency indicated.
- Antenna Parameters with TSL:** The dipole is mounted with the spacer to position its feed point exactly below the center marking of the flat phantom section, with the arms oriented parallel to the body axis.
- Feed Point Impedance and Return Loss:** These parameters are measured with the dipole positioned under the liquid filled phantom. The impedance stated is transformed from the measurement at the SMA connector to the feed point. The Return Loss ensures low reflected power. No uncertainty required.
- Electrical Delay:** One-way delay between the SMA connector and the antenna feed point. No uncertainty required.
- SAR measured:** SAR measured at the stated antenna input power.
- SAR normalized:** SAR as measured, normalized to an input power of 1 W at the antenna connector.
- SAR for nominal TSL parameters:** The measured TSL parameters are used to calculate the nominal SAR result.

The reported uncertainty of measurement is stated as the standard uncertainty of Measurement multiplied by the coverage factor  $k=2$ , which for a normal distribution corresponds to a coverage probability of approximately 95%.



In Collaboration with  
**s p e a g**  
CALIBRATION LABORATORY

Add: No.52 HuaYuanBei Road, Haidian District, Beijing, 100191, China  
Tel: +86-10-62304633-2079 Fax: +86-10-62304633-2504  
E-mail: cttl@chinattl.com http://www.chinattl.cn

**Measurement Conditions**

DASY system configuration, as far as not given on page 1

|                              |                          |             |
|------------------------------|--------------------------|-------------|
| DASY Version                 | DASY52                   | V52.10.4    |
| Extrapolation                | Advanced Extrapolation   |             |
| Phantom                      | Triple Flat Phantom 5.1C |             |
| Distance Dipole Center - TSL | 10 mm                    | with Spacer |
| Zoom Scan Resolution         | dx, dy, dz = 5 mm        |             |
| Frequency                    | 2600 MHz ± 1 MHz         |             |

**Head TSL parameters**

The following parameters and calculations were applied

|   | Temperature     | Permittivity | Conductivity     |
|---|-----------------|--------------|------------------|
| Nominal Head TSL parameters             | 22.0 °C         | 39.0         | 1.96 mho/m       |
| Measured Head TSL parameters            | (22.0 ± 0.2) °C | 39.9 ± 6 %   | 1.94 mho/m ± 6 % |
| Head TSL temperature change during test | <1.0 °C         | —            | —                |

**SAR result with Head TSL**

|   |                    |                          |
|---|--------------------|--------------------------|
| SAR averaged over 1 cm <sup>3</sup> (1 g) of Head TSL   | Condition          |                          |
| SAR measured  | 250 mW input power | 13.9 W/kg                |
| SAR for nominal Head TSL parameters                     | normalized to 1W   | 56.1 W/kg ± 18.8 % (k=2) |
| SAR averaged over 10 cm <sup>3</sup> (10 g) of Head TSL | Condition          |                          |
| SAR measured  | 250 mW input power | 6.10 W/kg                |
| SAR for nominal Head TSL parameters                     | normalized to 1W   | 24.5 W/kg ± 18.7 % (k=2) |





In Collaboration with  
**s p e a g**  
CALIBRATION LABORATORY

Add: No.52 HuaYuanBei Road, Haidian District, Beijing, 100191, China  
Tel: +86-10-62304633-2079 Fax: +86-10-62304633-2504  
E-mail: cttl@chinattl.com http://www.chinattl.cn

#### Appendix(Additional assessments outside the scope of CNAS L0570)

##### Antenna Parameters with Head TSL

|                                      |               |
|--------------------------------------|---------------|
| Impedance, transformed to feed point | 50.1Ω- 7.19jΩ |
| Return Loss                          | - 22.9dB      |

##### General Antenna Parameters and Design

|                                  |          |
|----------------------------------|----------|
| Electrical Delay (one direction) | 1.055 ns |
|----------------------------------|----------|

After long term use with 100W radiated power, only a slight warming of the dipole near the feedpoint can be measured.

The dipole is made of standard semirigid coaxial cable. The center conductor of the feeding line is directly connected to the second arm of the dipole. The antenna is therefore short-circuited for DC-signals. On some of the dipoles, small end caps are added to the dipole arms in order to improve matching when loaded according to the position as explained in the "Measurement Conditions" paragraph. The SAR data are not affected by this change. The overall dipole length is still according to the Standard. No excessive force must be applied to the dipole arms, because they might bend or the soldered connections near the feedpoint may be damaged.

##### Additional EUT Data

|                 |       |
|-----------------|-------|
| Manufactured by | SPEAG |
|-----------------|-------|



In Collaboration with  
**s p e a g**  
CALIBRATION LABORATORY

Add: No.52 HuaYuanBei Road, Haidian District, Beijing, 100191, China  
Tel: +86-10-62304633-2079 Fax: +86-10-62304633-2504  
E-mail: ettl@chinattl.com http://www.chinattl.cn

**DASY5 Validation Report for Head TSL**

Date: 04.23.2021

Test Laboratory: CTTL, Beijing, China

**DUT: Dipole 2600 MHz; Type: D2600V2; Serial: D2600V2 - SN: 1025**

Communication System: UID 0, CW; Frequency: 2600 MHz; Duty Cycle: 1:1

Medium parameters used:  $f = 2600$  MHz;  $\sigma = 1.944$  S/m;  $\epsilon_r = 39.94$ ;  $\rho = 1000$  kg/m<sup>3</sup>

Phantom section: Center Section

DASY5 Configuration:

- Probe: EX3DV4 - SN3617; ConvF(7.55, 7.55, 7.55) @ 2600 MHz; Calibrated: 2021-01-27
- Sensor-Surface: 1.4mm (Mechanical Surface Detection)
- Electronics: DAE4 Sn777; Calibrated: 2021-01-08
- Phantom: MFP\_V5.1C (20deg probe tilt); Type: QD 000 P51 Cx; Serial: 1062
- Measurement SW: DASY52, Version 52.10 (4); SEMCAD X Version 14.6.14 (7483)

**Dipole Calibration/Zoom Scan (7x7x7) (7x7x7)/Cube 0:** Measurement grid: dx=5mm, dy=5mm, dz=5mm

Reference Value = 101.1 V/m; Power Drift = -0.09 dB

Peak SAR (extrapolated) = 31.5 W/kg

**SAR(1 g) = 13.9 W/kg; SAR(10 g) = 6.1 W/kg**

Smallest distance from peaks to all points 3 dB below = 9 mm

Ratio of SAR at M2 to SAR at M1 = 44%

Maximum value of SAR (measured) = 24.4 W/kg

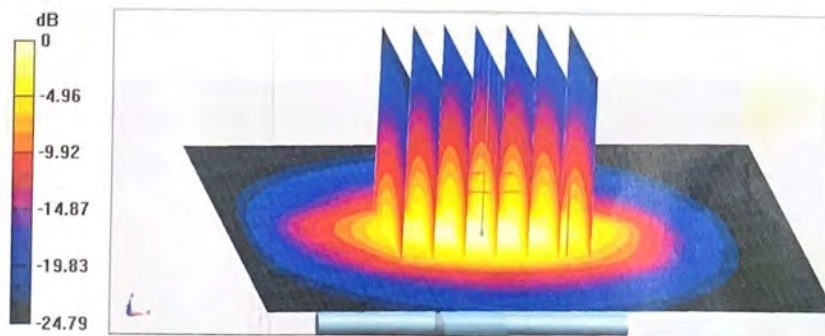

0 dB = 24.4 W/kg = 13.87 dBW/kg



In Collaboration with  
**s p e a g**  
CALIBRATION LABORATORY

Add: No.52 HuaYuanBei Road, Haidian District, Beijing, 100191, China  
Tel: +86-10-62304633-2079 Fax: +86-10-62304633-2501  
E-mail: cttl@chinatl.com http://www.chinatl.cn

Impedance Measurement Plot for Head TSL

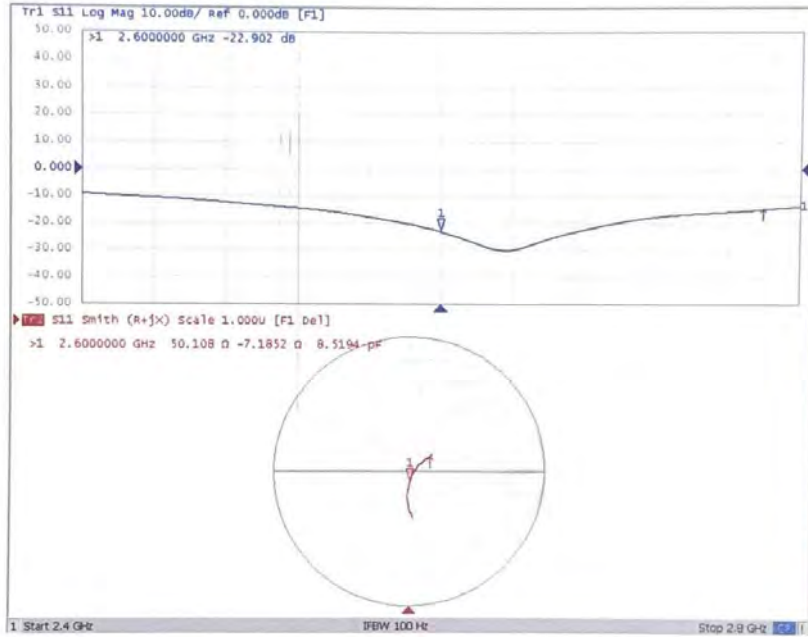





# ANNEX L: D3500V2 Dipole Calibration Certificate

**Calibration Laboratory of  
Schmid & Partner  
Engineering AG**  
Zeughausstrasse 43, 8004 Zurich, Switzerland



**S** Schweizerischer Kalibrierdienst  
**C** Service suisse d'étalonnage  
**S** Servizio svizzero di taratura  
**S** Swiss Calibration Service

Accredited by the Swiss Accreditation Service (SAS)  
The Swiss Accreditation Service is one of the signatories to the EA  
Multilateral Agreement for the recognition of calibration certificates

Accreditation No.: **SCS 0108**

Client **TA-SH (Auden)**

Certificate No: **D3500V2-1083\_Sep19**

## CALIBRATION CERTIFICATE

Object **D3500V2 - SN:1083**

Calibration procedure(s) **QA CAL-22.v4  
Calibration Procedure for SAR Validation Sources between 3-6 GHz**

Calibration date: **September 20, 2019**

This calibration certificate documents the traceability to national standards, which realize the physical units of measurements (SI).  
The measurements and the uncertainties with confidence probability are given on the following pages and are part of the certificate.

All calibrations have been conducted in the closed laboratory facility: environment temperature (22 ± 3)°C and humidity < 70%.

Calibration Equipment used (M&TE critical for calibration)

| Primary Standards               | ID #               | Cal Date (Certificate No.)        | Scheduled Calibration  |
|---------------------------------|--------------------|-----------------------------------|------------------------|
| Power meter NRP                 | SN: 104778         | 03-Apr-19 (No. 217-02892/02893)   | Apr-20                 |
| Power sensor NRP-Z91            | SN: 103244         | 03-Apr-19 (No. 217-02892)         | Apr-20                 |
| Power sensor NRP-Z91            | SN: 103245         | 03-Apr-19 (No. 217-02893)         | Apr-20                 |
| Reference 20 dB Attenuator      | SN: 5058 (20k)     | 04-Apr-19 (No. 217-02894)         | Apr-20                 |
| Type-N mismatch combination     | SN: 5047.2 / 06327 | 04-Apr-19 (No. 217-02895)         | Apr-20                 |
| Reference Probe EX3DV4          | SN: 3503           | 25-Mar-19 (No. EX3-3503_Mar19)    | Mar-20                 |
| DAE4                            | SN: 601            | 30-Apr-19 (No. DAE4-601_Apr19)    | Apr-20                 |
| Secondary Standards             | ID #               | Check Date (in house)             | Scheduled Check        |
| Power meter E4419B              | SN: GB39512475     | 30-Oct-14 (in house check Feb-19) | In house check: Oct-20 |
| Power sensor HP 8481A           | SN: US37292783     | 07-Oct-15 (in house check Oct-18) | In house check: Oct-20 |
| Power sensor HP 8481A           | SN: MY41092317     | 07-Oct-15 (in house check Oct-18) | In house check: Oct-20 |
| RF generator R&S SMT-06         | SN: 100972         | 15-Jun-15 (in house check Oct-18) | In house check: Oct-20 |
| Network Analyzer Agilent E8358A | SN: US41080477     | 31-Mar-14 (in house check Oct-18) | In house check: Oct-19 |

Calibrated by: **Name: Jeton Kastrati, Function: Laboratory Technician**

Signature

Approved by: **Name: Katja Pokovic, Function: Technical Manager**

Signature

Issued: September 24, 2019

This calibration certificate shall not be reproduced except in full without written approval of the laboratory.

**Calibration Laboratory of  
Schmid & Partner  
Engineering AG**  
Zeughausstrasse 43, 8004 Zurich, Switzerland



**S** Schweizerischer Kalibrierdienst  
**C** Service suisse d'étalonnage  
**S** Servizio svizzero di taratura  
**S** Swiss Calibration Service

Accredited by the Swiss Accreditation Service (SAS)  
The Swiss Accreditation Service is one of the signatories to the EA  
Multilateral Agreement for the recognition of calibration certificates

Accreditation No.: **SCS 0108**

**Glossary:**

TSL tissue simulating liquid  
ConvF sensitivity in TSL / NORM x,y,z  
N/A not applicable or not measured

**Calibration is Performed According to the Following Standards:**

- a) IEEE Std 1528-2013, "IEEE Recommended Practice for Determining the Peak Spatial-Averaged Specific Absorption Rate (SAR) in the Human Head from Wireless Communications Devices: Measurement Techniques", June 2013
- b) IEC 62209-1, "Measurement procedure for the assessment of Specific Absorption Rate (SAR) from hand-held and body-mounted devices used next to the ear (frequency range of 300 MHz to 6 GHz)", July 2016
- c) IEC 62209-2, "Procedure to determine the Specific Absorption Rate (SAR) for wireless communication devices used in close proximity to the human body (frequency range of 30 MHz to 6 GHz)", March 2010
- d) KDB 865664, "SAR Measurement Requirements for 100 MHz to 6 GHz"

**Additional Documentation:**

- e) DASY4/5 System Handbook

**Methods Applied and Interpretation of Parameters:**

- *Measurement Conditions:* Further details are available from the Validation Report at the end of the certificate. All figures stated in the certificate are valid at the frequency indicated.
- *Antenna Parameters with TSL:* The dipole is mounted with the spacer to position its feed point exactly below the center marking of the flat phantom section, with the arms oriented parallel to the body axis.
- *Feed Point Impedance and Return Loss:* These parameters are measured with the dipole positioned under the liquid filled phantom. The impedance stated is transformed from the measurement at the SMA connector to the feed point. The Return Loss ensures low reflected power. No uncertainty required.
- *Electrical Delay:* One-way delay between the SMA connector and the antenna feed point. No uncertainty required.
- *SAR measured:* SAR measured at the stated antenna input power.
- *SAR normalized:* SAR as measured, normalized to an input power of 1 W at the antenna connector.
- *SAR for nominal TSL parameters:* The measured TSL parameters are used to calculate the nominal SAR result.

The reported uncertainty of measurement is stated as the standard uncertainty of measurement multiplied by the coverage factor  $k=2$ , which for a normal distribution corresponds to a coverage probability of approximately 95%.



**Measurement Conditions**

DASY system configuration, as far as not given on page 1.

|                              |                                      |                                  |
|------------------------------|--------------------------------------|----------------------------------|
| DASY Version                 | DASY5                                | V52.10.2                         |
| Extrapolation                | Advanced Extrapolation               |                                  |
| Phantom                      | Modular Flat Phantom                 |                                  |
| Distance Dipole Center - TSL | 10 mm                                | with Spacer                      |
| Zoom Scan Resolution         | dx, dy = 4 mm, dz = 1.4 mm           | Graded Ratio = 1.4 (Z direction) |
| Frequency                    | 3400 MHz ± 1 MHz<br>3500 MHz ± 1 MHz |                                  |

**Head TSL parameters at 3400 MHz**

The following parameters and calculations were applied.

|   | Temperature     | Permittivity | Conductivity     |
|---|-----------------|--------------|------------------|
| Nominal Head TSL parameters             | 22.0 °C         | 37.4         | 2.81 mho/m       |
| Measured Head TSL parameters            | (22.0 ± 0.2) °C | 37.7 ± 6 %   | 2.84 mho/m ± 6 % |
| Head TSL temperature change during test | < 0.5 °C        | ----         | ----             |

**SAR result with Head TSL at 3400 MHz**

| SAR averaged over 1 cm <sup>3</sup> (1 g) of Head TSL | Condition          |                          |
|---|--------------------|--------------------------|
| SAR measured  | 100 mW input power | 6.97 W/kg                |
| SAR for nominal Head TSL parameters                   | normalized to 1W   | 69.6 W/kg ± 19.9 % (k=2) |

| SAR averaged over 10 cm <sup>3</sup> (10 g) of Head TSL | condition          |                          |
|---|--------------------|--------------------------|
| SAR measured  | 100 mW input power | 2.62 W/kg                |
| SAR for nominal Head TSL parameters                     | normalized to 1W   | 26.2 W/kg ± 19.5 % (k=2) |

**Head TSL parameters at 3500 MHz**

The following parameters and calculations were applied.

|   | Temperature     | Permittivity | Conductivity     |
|---|-----------------|--------------|------------------|
| Nominal Head TSL parameters             | 22.0 °C         | 37.9         | 2.91 mho/m       |
| Measured Head TSL parameters            | (22.0 ± 0.2) °C | 37.6 ± 6 %   | 2.91 mho/m ± 6 % |
| Head TSL temperature change during test | < 0.5 °C        | ----         | ----             |

**SAR result with Head TSL at 3500 MHz**

| SAR averaged over 1 cm <sup>3</sup> (1 g) of Head TSL | Condition          |                          |
|---|--------------------|--------------------------|
| SAR measured  | 100 mW input power | 6.72 W/kg                |
| SAR for nominal Head TSL parameters                   | normalized to 1W   | 67.1 W/kg ± 19.9 % (k=2) |

| SAR averaged over 10 cm <sup>3</sup> (10 g) of Head TSL | condition          |                          |
|---|--------------------|--------------------------|
| SAR measured  | 100 mW input power | 2.53 W/kg                |
| SAR for nominal Head TSL parameters                     | normalized to 1W   | 25.3 W/kg ± 19.5 % (k=2) |



**Body TSL parameters at 3400 MHz**

The following parameters and calculations were applied.

|   | Temperature     | Permittivity | Conductivity     |
|---|-----------------|--------------|------------------|
| Nominal Body TSL parameters             | 22.0 °C         | 51.5         | 3.20 mho/m       |
| Measured Body TSL parameters            | (22.0 ± 0.2) °C | 40.9 ± 6 %   | 3.25 mho/m ± 6 % |
| Body TSL temperature change during test | < 0.5 °C        | ----         | ----             |

**SAR result with Body TSL at 3400 MHz**

| SAR averaged over 1 cm <sup>3</sup> (1 g) of Body TSL | Condition          |                                 |
|---|--------------------|---------------------------------|
| SAR measured  | 100 mW input power | 6.56 W/kg                       |
| SAR for nominal Body TSL parameters                   | normalized to 1W   | <b>64.9 W/kg ± 19.9 % (k=2)</b> |

| SAR averaged over 10 cm <sup>3</sup> (10 g) of Body TSL | condition          |                                 |
|---|--------------------|---------------------------------|
| SAR measured  | 100 mW input power | 2.44 W/kg                       |
| SAR for nominal Body TSL parameters                     | normalized to 1W   | <b>24.2 W/kg ± 19.5 % (k=2)</b> |

**Body TSL parameters at 3500 MHz**

The following parameters and calculations were applied.

|   | Temperature     | Permittivity | Conductivity     |
|---|-----------------|--------------|------------------|
| Nominal Body TSL parameters             | 22.0 °C         | 51.3         | 3.31 mho/m       |
| Measured Body TSL parameters            | (22.0 ± 0.2) °C | 49.8 ± 6 %   | 3.35 mho/m ± 6 % |
| Body TSL temperature change during test | < 0.5 °C        | ----         | ----             |

**SAR result with Body TSL at 3500MHz**

| SAR averaged over 1 cm <sup>3</sup> (1 g) of Body TSL | Condition          |                                 |
|---|--------------------|---------------------------------|
| SAR measured  | 100 mW input power | 6.52 W/kg                       |
| SAR for nominal Body TSL parameters                   | normalized to 1W   | <b>64.6 W/kg ± 19.9 % (k=2)</b> |

| SAR averaged over 10 cm <sup>3</sup> (10 g) of Body TSL | condition          |                                 |
|---|--------------------|---------------------------------|
| SAR measured  | 100 mW input power | 2.42 W/kg                       |
| SAR for nominal Body TSL parameters                     | normalized to 1W   | <b>24.0 W/kg ± 19.5 % (k=2)</b> |

**Appendix (Additional assessments outside the scope of SCS 0108)**

**Antenna Parameters with Head TSL at 3400 MHz**

|                                      |                 |
|--------------------------------------|-----------------|
| Impedance, transformed to feed point | 44.5 Ω - 5.6 jΩ |
| Return Loss                          | - 21.6 dB       |

**Antenna Parameters with Head TSL at 3500 MHz**

|                                      |                 |
|--------------------------------------|-----------------|
| Impedance, transformed to feed point | 52.3 Ω - 1.5 jΩ |
| Return Loss                          | - 31.4 dB       |

**Antenna Parameters with Body TSL at 3400 MHz**

|                                      |                 |
|--------------------------------------|-----------------|
| Impedance, transformed to feed point | 42.8 Ω - 4.0 jΩ |
| Return Loss                          | - 21.1 dB       |

**Antenna Parameters with Body TSL at 3500MHz**

|                                      |                 |
|--------------------------------------|-----------------|
| Impedance, transformed to feed point | 50.2 Ω + 2.8 jΩ |
| Return Loss                          | - 31.2 dB       |

**General Antenna Parameters and Design**

|                                  |          |
|----------------------------------|----------|
| Electrical Delay (one direction) | 1.135 ns |
|----------------------------------|----------|

After long term use with 100W radiated power, only a slight warming of the dipole near the feedpoint can be measured.

The dipole is made of standard semirigid coaxial cable. The center conductor of the feeding line is directly connected to the second arm of the dipole. The antenna is therefore short-circuited for DC-signals. On some of the dipoles, small end caps are added to the dipole arms in order to improve matching when loaded according to the position as explained in the "Measurement Conditions" paragraph. The SAR data are not affected by this change. The overall dipole length is still according to the Standard.

No excessive force must be applied to the dipole arms, because they might bend or the soldered connections near the feedpoint may be damaged.

**Additional EUT Data**

|                 |       |
|-----------------|-------|
| Manufactured by | SPEAG |
|-----------------|-------|

**DASY5 Validation Report for Head TSL**

Date: 20.09.2019

Test Laboratory: SPEAG, Zurich, Switzerland

**DUT: Dipole 3500 MHz; Type: D3500V2; Serial: D3500V2 - SN:1083**

Communication System: UID 0 - CW; Frequency: 3400 MHz, Frequency: 3500 MHz  
 Medium parameters used:  $f = 3400$  MHz;  $\sigma = 2.84$  S/m;  $\epsilon_r = 37.7$ ;  $\rho = 1000$  kg/m<sup>3</sup> ,  
 Medium parameters used:  $f = 3500$  MHz;  $\sigma = 2.91$  S/m;  $\epsilon_r = 37.6$ ;  $\rho = 1000$  kg/m<sup>3</sup>  
 Phantom section: Flat Section  
 Measurement Standard: DASY5 (IEEE/IEC/ANSI C63.19-2011)

**DASY52 Configuration:**

- Probe: EX3DV4 - SN3503; ConvF(7.75, 7.75, 7.75) @ 3400 MHz, ConvF(7.75, 7.75, 7.75) @ 3500 MHz; Calibrated: 25.03.2019
- Sensor-Surface: 1.4mm (Mechanical Surface Detection)
- Electronics: DAE4 Sn601; Calibrated: 30.04.2019
- Phantom: Flat Phantom 5.0 (front); Type: QD 000 P50 AA; Serial: 1001
- DASY52 52.10.2(1504); SEMCAD X 14.6.12(7470)

**Dipole Calibration for Head Tissue/Pin=100 mW, d=10mm 3400/Zoom Scan, dist=1.4mm**

**(8x8x8)/Cube 0:** Measurement grid: dx=4mm, dy=4mm, dz=1.4mm

Reference Value = 74.62 V/m; Power Drift = -0.08 dB

Peak SAR (extrapolated) = 18.9 W/kg

**SAR(1 g) = 6.97 W/kg; SAR(10 g) = 2.62 W/kg**

Maximum value of SAR (measured) = 13.2 W/kg

**Dipole Calibration for Head Tissue/Pin=100 mW, d=10mm 3500/Zoom Scan, dist=1.4mm**

**(8x8x8)/Cube 0:** Measurement grid: dx=4mm, dy=4mm, dz=1.4mm

Reference Value = 72.32 V/m; Power Drift = -0.07 dB

Peak SAR (extrapolated) = 18.4 W/kg

**SAR(1 g) = 6.72 W/kg; SAR(10 g) = 2.53 W/kg**

Maximum value of SAR (measured) = 12.8 W/kg



0 dB = 12.8 W/kg = 11.07 dBW/kg