

U-NII-2C, 802.11n HT40, Channel No.: 102

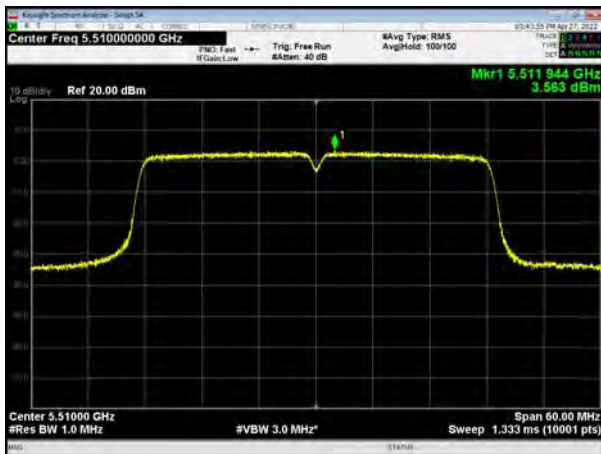

U-NII-2C, 802.11ac VHT20, Channel No.: 100



U-NII-2C, 802.11n HT40, Channel No.: 110

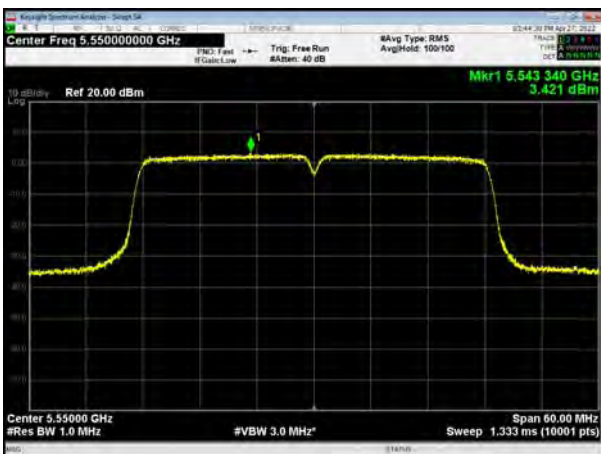

U-NII-2C, 802.11ac VHT20, Channel No.: 116

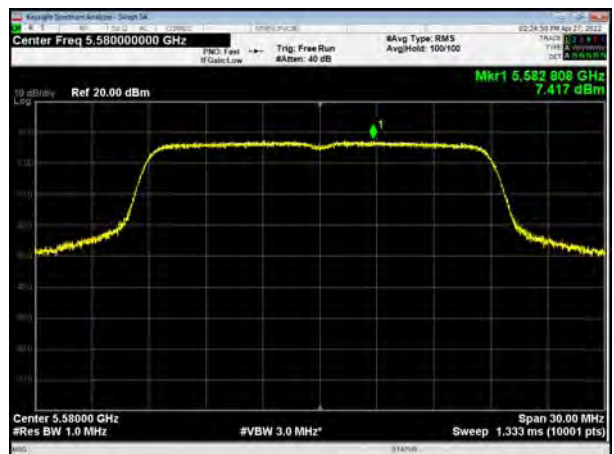

U-NII-2C, 802.11n HT40, Channel No.: 134



U-NII-2C, 802.11ac VHT20, Channel No.: 140

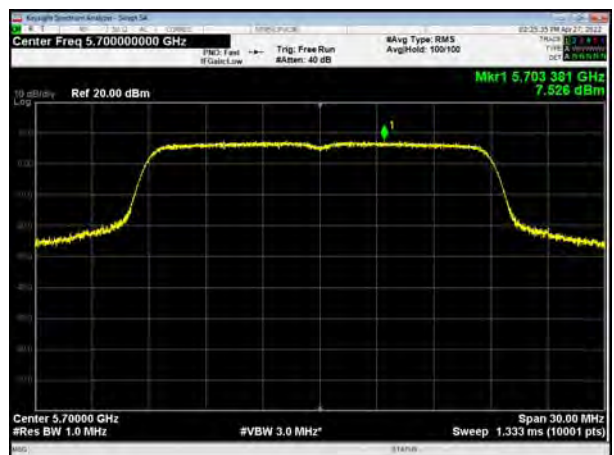

U-NII-2C, 802.11n HT40, Channel No.: 142



U-NII-2C, 802.11ac VHT20, Channel No.: 144

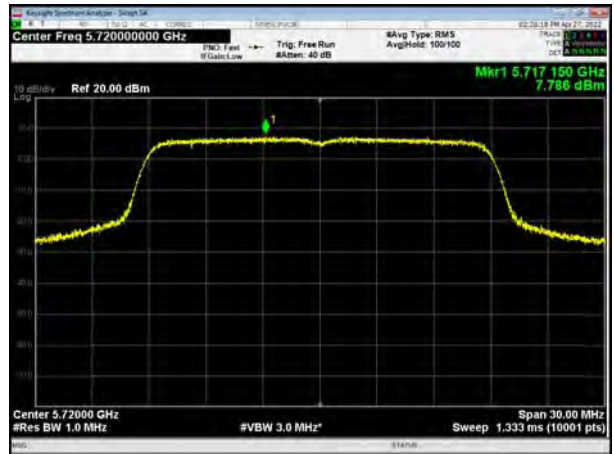

U-NII-2C, 802.11ac VHT40, Channel No.: 102

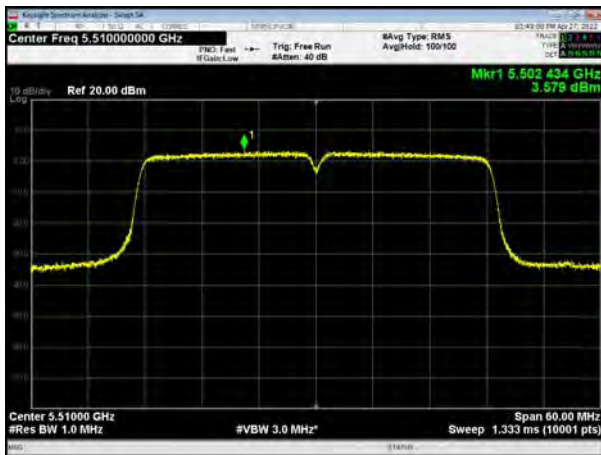

U-NII-2C, 802.11ac VHT80, Channel No.: 106

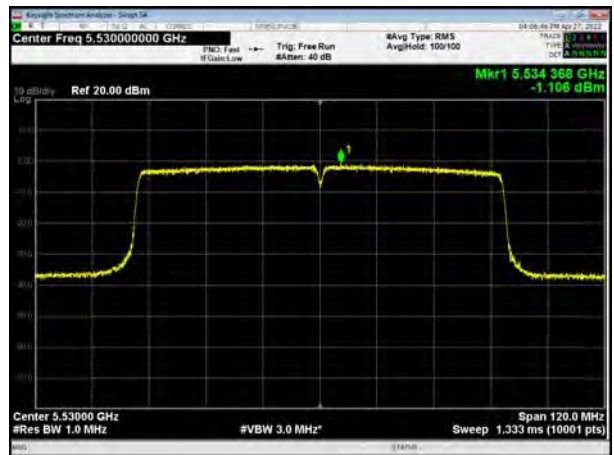

U-NII-2C, 802.11ac VHT40, Channel No.: 110

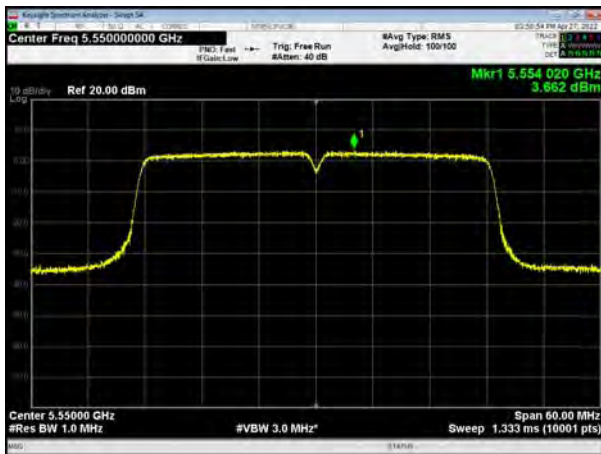

U-NII-2C, 802.11ac VHT80, Channel No.: 138

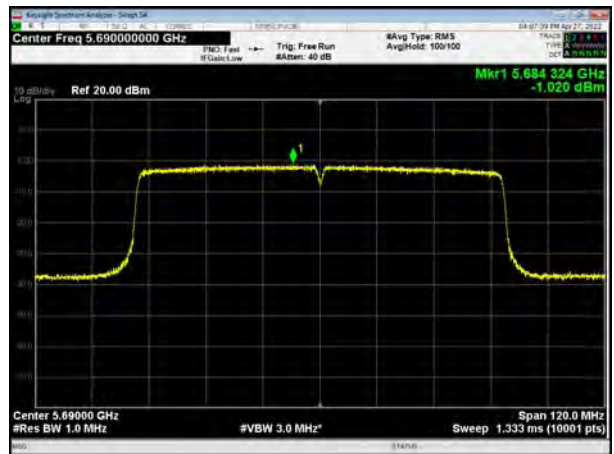

U-NII-2C, 802.11ac VHT40, Channel No.: 134

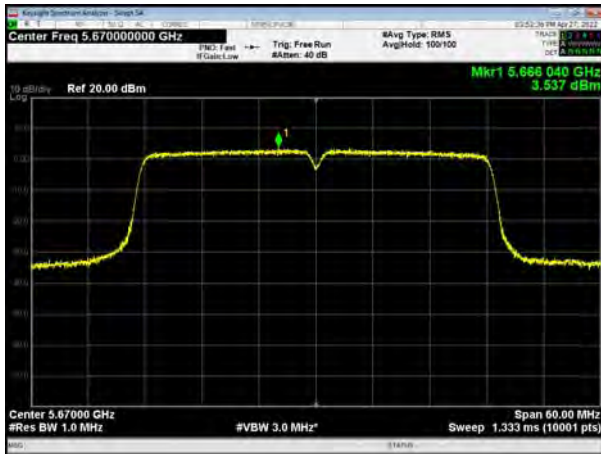

U-NII-2C, 802.11ac VHT40, Channel No.: 142

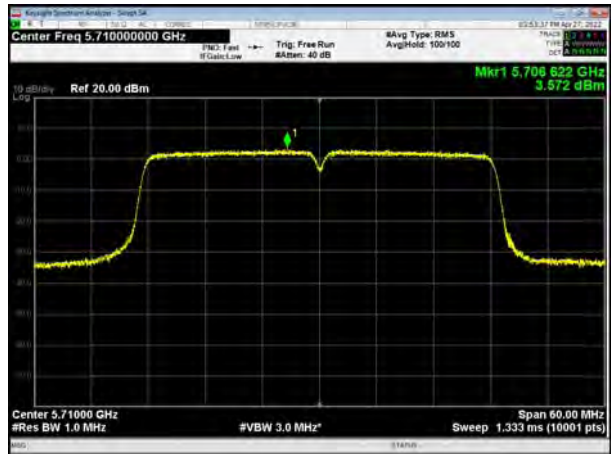

U-NII-2C, 802.11ax HE20, Channel No.: 100

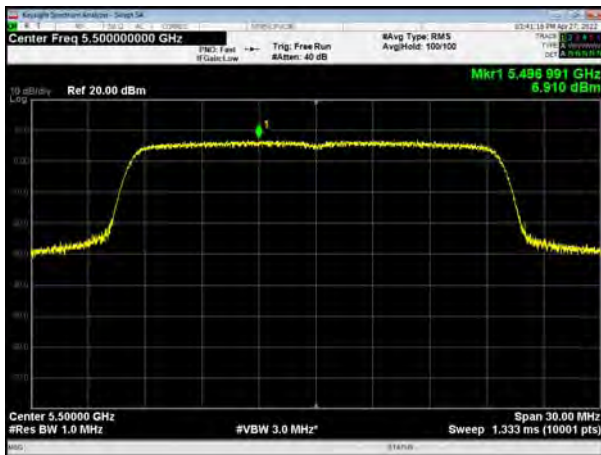

U-NII-2C, 802.11ax HE40, Channel No.: 102

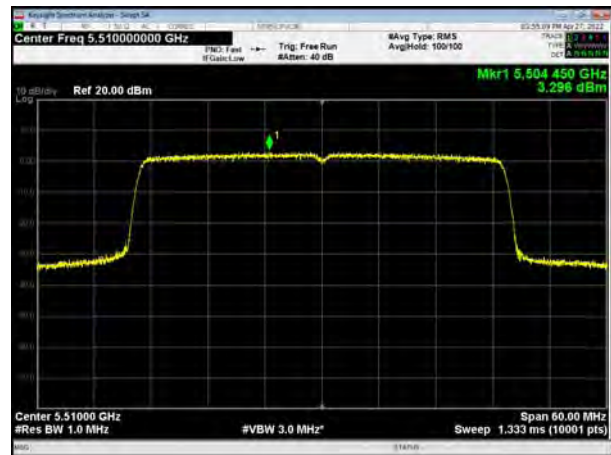

U-NII-2C, 802.11ax HE20, Channel No.: 116



U-NII-2C, 802.11ax HE40, Channel No.: 110







U-NII-2C, 802.11ax HE20, Channel No.: 140

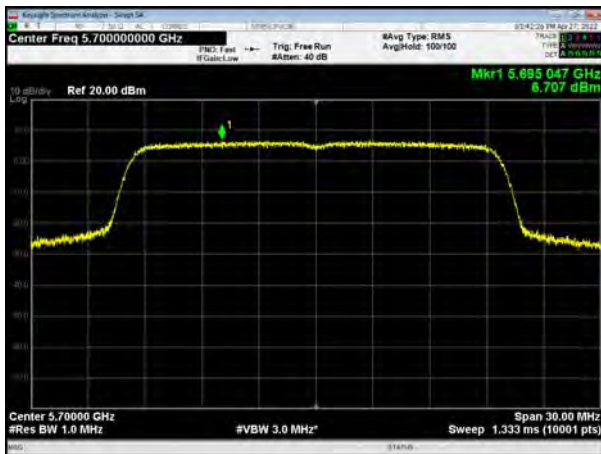

U-NII-2C, 802.11ax HE40, Channel No.: 134

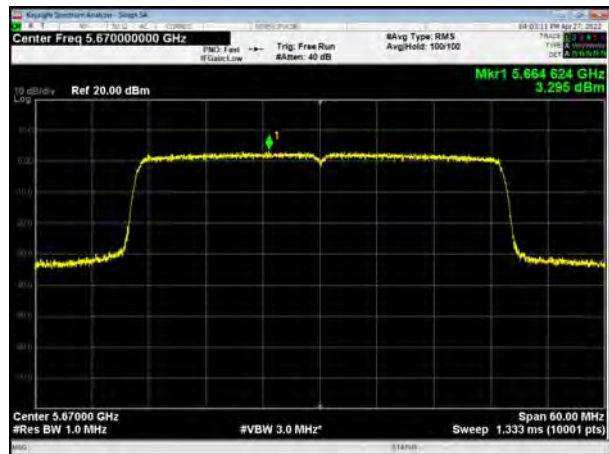

U-NII-2C, 802.11ax HE20, Channel No.: 144



U-NII-2C, 802.11ax HE40, Channel No.: 142

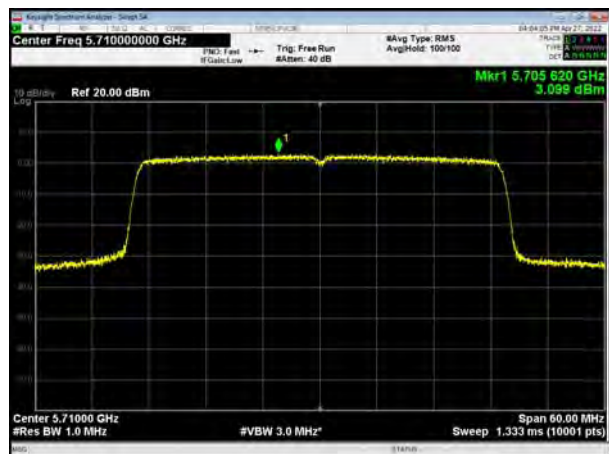

U-NII-2C, 802.11ax HE80, Channel No.: 106

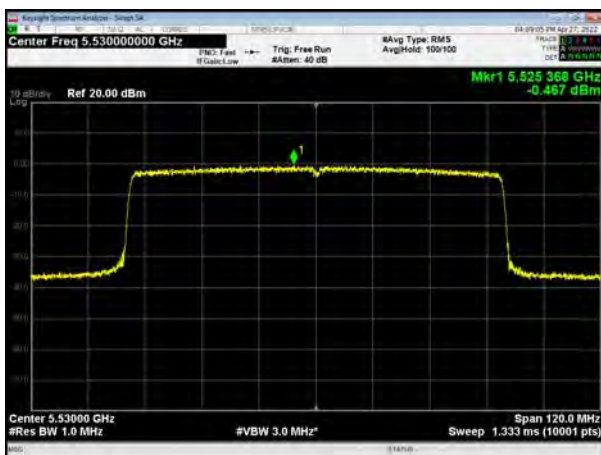

U-NII-2C, 802.11ax HE80, Channel No.: 138

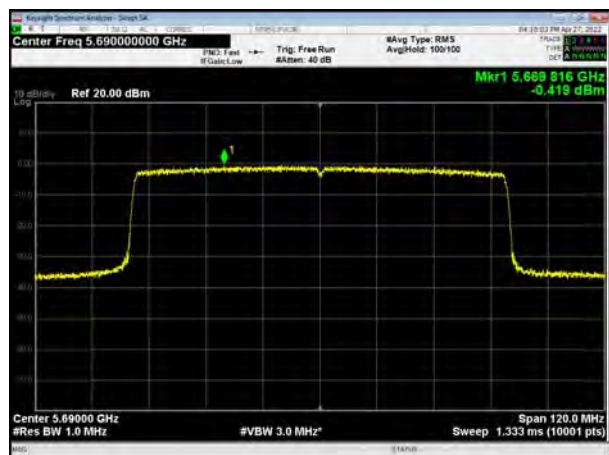

U-NII-3, 802.11a, Channel No.: 149

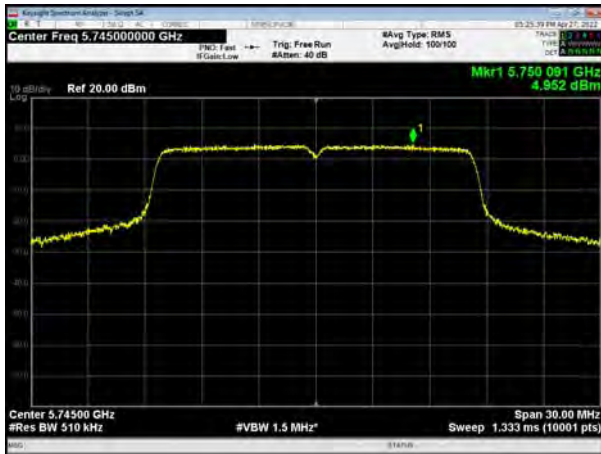

U-NII-3, 802.11n HT20, Channel No.: 149

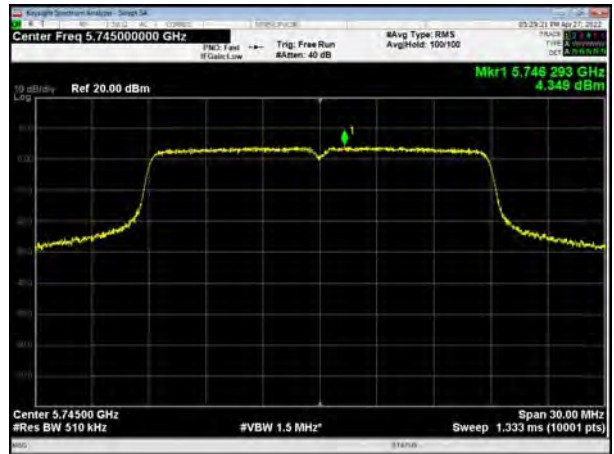

U-NII-3, 802.11a, Channel No.: 157



U-NII-3, 802.11n HT20, Channel No.: 157

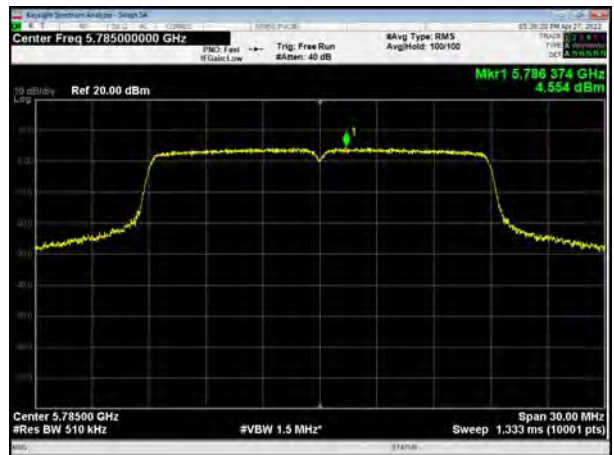

U-NII-3, 802.11a, Channel No.: 165

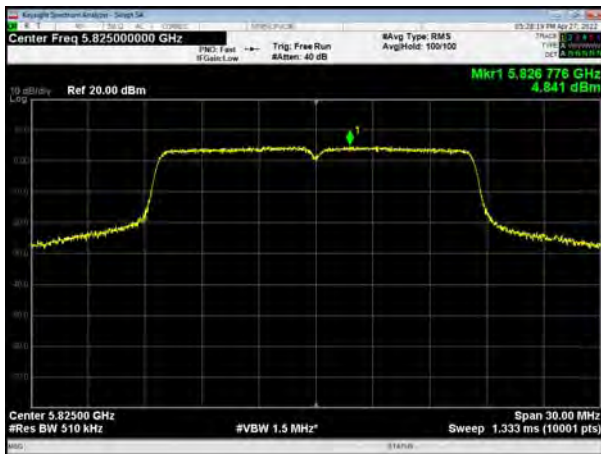

U-NII-3, 802.11n HT20, Channel No.: 165

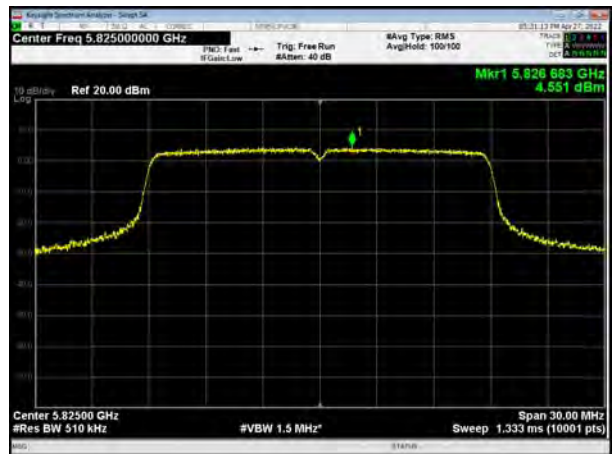

U-NII-3, 802.11n HT40, Channel No.: 151

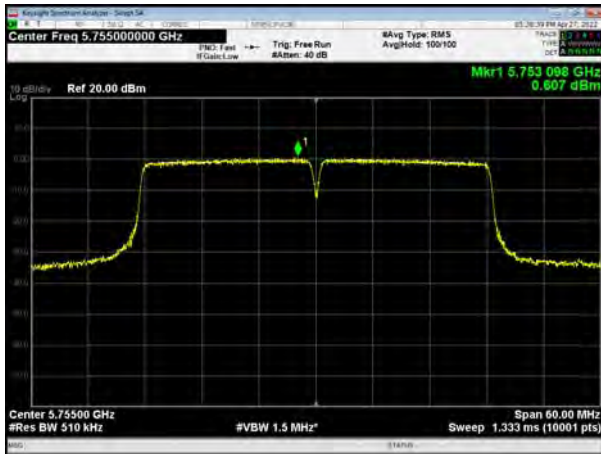

U-NII-3, 802.11ac VHT20, Channel No.: 149

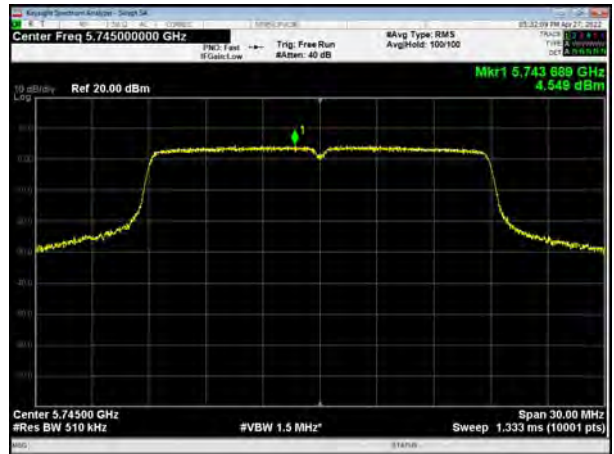

U-NII-3, 802.11n HT40, Channel No.: 159

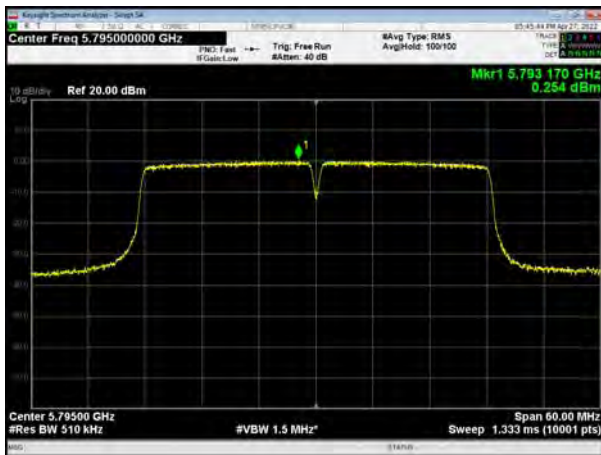

U-NII-3, 802.11ac VHT20, Channel No.: 157

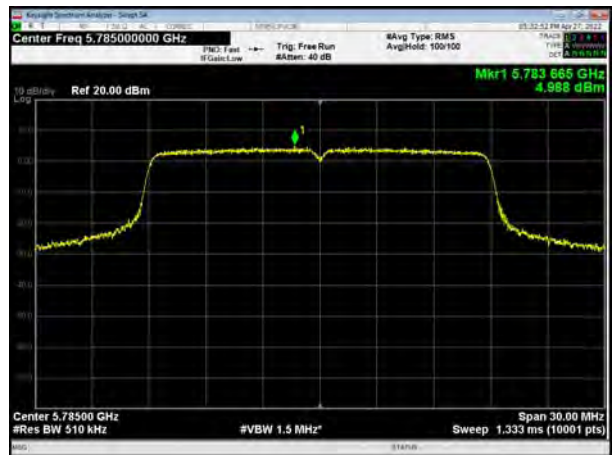

U-NII-3, 802.11ac VHT40, Channel No.: 151

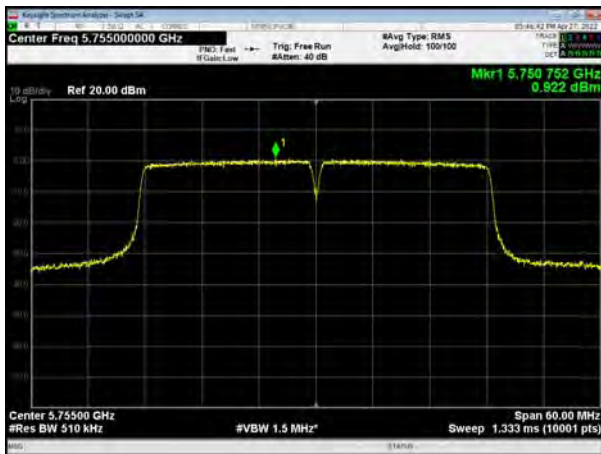

U-NII-3, 802.11ac VHT20, Channel No.: 165

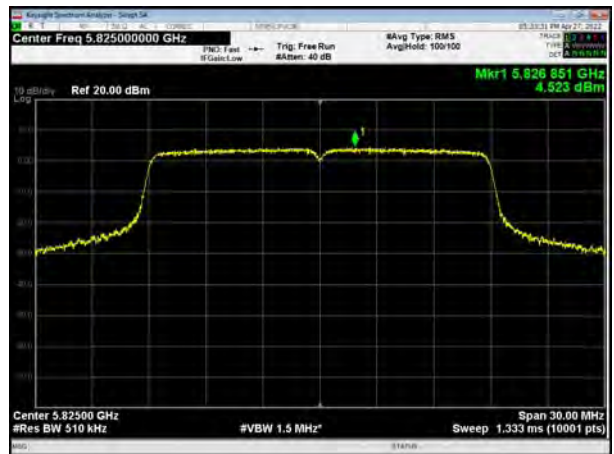





U-NII-3, 802.11ac VHT40, Channel No.: 159

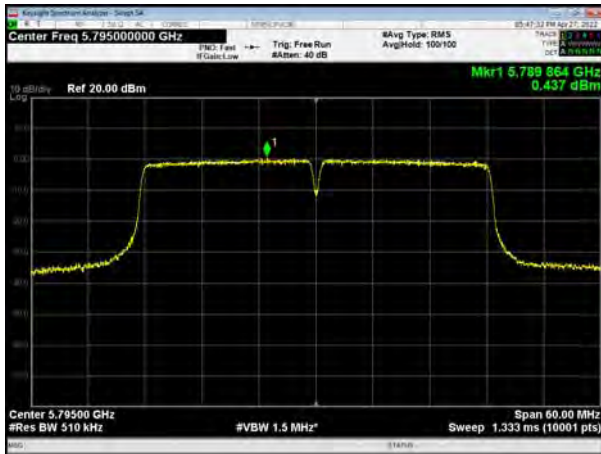

U-NII-3, 802.11ac VHT80, Channel No.: 155

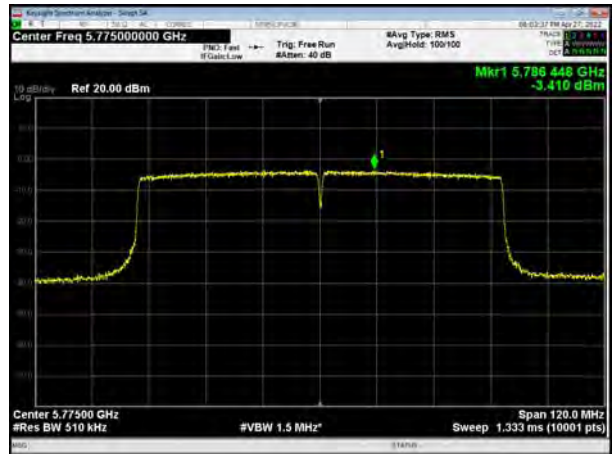

U-NII-3, 802.11ax HE20, Channel No.: 149

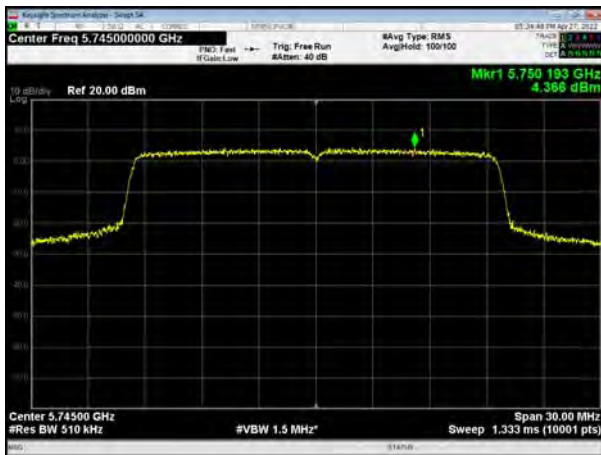

U-NII-3, 802.11ax HE40, Channel No.: 151

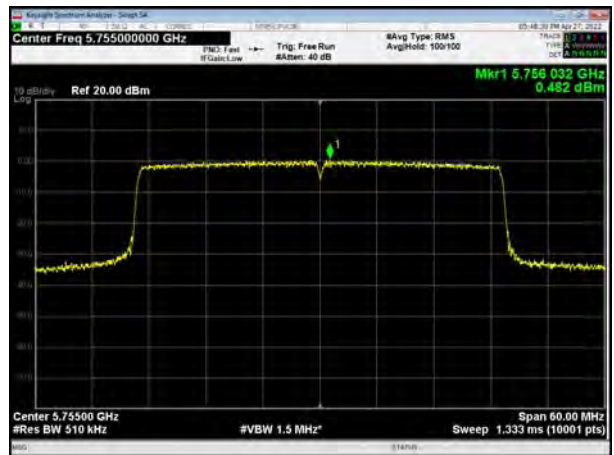

U-NII-3, 802.11ax HE20, Channel No.: 157

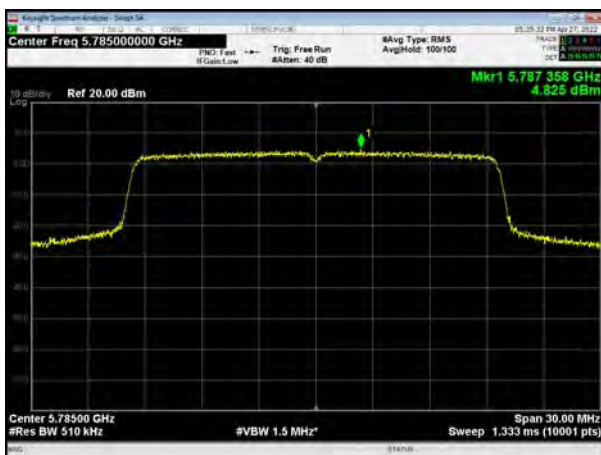

U-NII-3, 802.11ax HE40, Channel No.: 159

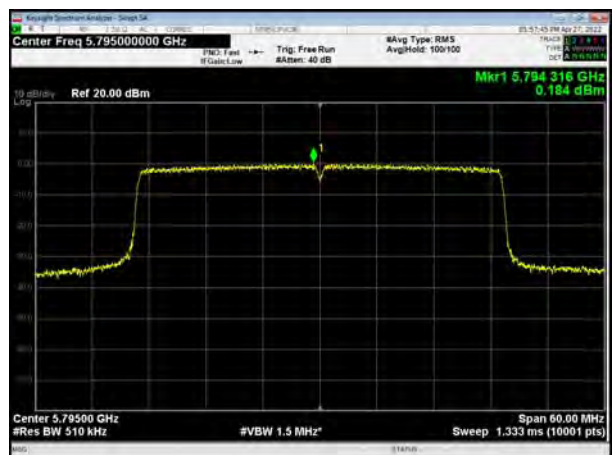



U-NII-3, 802.11ax HE20, Channel No.: 165

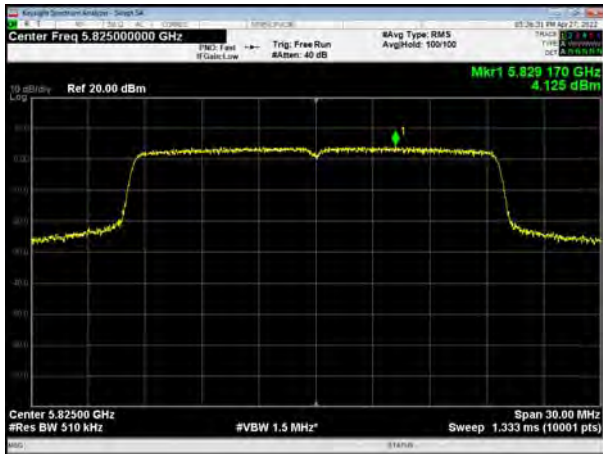

U-NII-3, 802.11ax HE80, Channel No.: 155

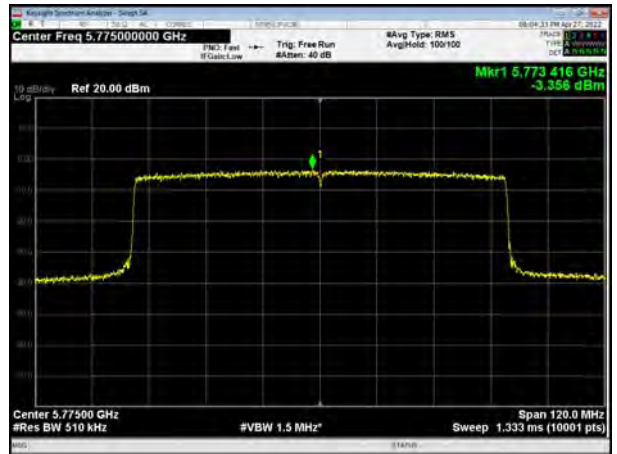





## 5.5. Unwanted Emission

### Ambient condition

Temperature	Relative humidity	Pressure
23°C ~25°C	45%~50%	101.5kPa

### Method of Measurement

The test set-up was made in accordance to the general provisions of ANSI C63.10. The Equipment Under Test (EUT) was set up on a non-conductive table in the semi-anechoic chamber. The test was performed at the distance of 3 m between the EUT and the receiving antenna. The radiated emissions measurements were made in a typical installation configuration.

Sweep the whole frequency band range from 9kHz to the 10th harmonic of the carrier, and the emissions less than 20 dB below the permissible value are reported.

During the test, the height of receive antenna shall be moved from 1 to 4 meters, and the antenna shall be performed under horizontal and vertical polarization. The turntable shall be rotated from 0 to 360 degrees for detecting the maximum of radiated spurious signal level. The measurements shall be repeated with orthogonal polarization of the test antenna. The data of cable loss and antenna factor has been calibrated in full testing frequency range before the testing.

Set the spectrum analyzer in the following:

9kHz~150 kHz

RBW=200Hz, VBW=1kHz/ Sweep=AUTO

150 kHz~30MHz

RBW=9KHz, VBW=30KHz,/ Sweep=AUTO

Below 1GHz

RBW=100kHz / VBW=300kHz / Sweep=AUTO

a) Peak emission levels are measured by setting the instrument as follows:

Above 1GHz

PEAK: RBW=1MHz VBW=3MHz/ Sweep=AUTO

b) Average emission levels are measured by setting the instrument as follows:

Above 1GHz

AVERAGE: RBW=1MHz / VBW=3MHz / Sweep=AUTO

c) Detector: The measurements employing a CISPR quasi-peak detector except for the frequency bands 9-90 kHz, 110-490 kHz and above 1000 MHz. Radiated emission limits in these three bands are based on measurements employing an average detector.

d) Averaging type = power (i.e., rms) (As an alternative, the detector and averaging type may be set for linear voltage averaging. Some instruments require linear display mode to use linear voltage averaging. Log or dB averaging shall not be used.)

e) Sweep time = auto.

f) Perform a trace average of at least 100 traces if the transmission is continuous. If the transmission is not continuous, then the number of traces shall be increased by a factor of  $1/D$ , where D is the duty cycle. For example, with 50% duty cycle, at least 200 traces shall be averaged. (If a specific



emission is demonstrated to be continuous—i.e., 100% duty cycle—then rather than turning ON and OFF with the transmit cycle, at least 100 traces shall be averaged.)

g) If tests are performed with the EUT transmitting at a duty cycle less than 98%, then a correction factor shall be added to the measurement results prior to comparing with the emission limit, to compute the emission level that would have been measured had the test been performed at 100% duty cycle. The correction factor is computed as follows:

1) If power averaging (rms) mode was used in the preceding step e), then the correction factor is  $[10 \log (1 / D)]$ , where D is the duty cycle. For example, if the transmit duty cycle was 50%, then 3 dB shall be added to the measured emission levels.

2) If linear voltage averaging mode was used in the preceding step e), then the correction factor is  $[20 \log (1 / D)]$ , where D is the duty cycle. For example, if the transmit duty cycle was 50%, then 6 dB shall be added to the measured emission levels.

3) If a specific emission is demonstrated to be continuous (100% duty cycle) rather than turning ON and OFF with the transmit cycle, then no duty cycle correction is required for that emission.

Reduce the video bandwidth until no significant variations in the displayed signal are observed in subsequent traces, provided the video bandwidth is no less than 1 Hz. For regulatory requirements that specify averaging only over the transmit duration (e.g., digital transmission system [DTS] and Unlicensed National Information Infrastructure [U-NII]), the video bandwidth shall be greater than  $[1 / (\text{minimum transmitter on time})]$  and no less than 1 Hz.

The field strength of spurious emission was measured in the following position: EUT stand-up position (Z axis), lie-down position (X, Y axis). The worst emission was found in stand-up position (Z axis) and the loop antenna is vertical, others antenna are vertical and horizontal.

The test is in transmitting mode.

9KHz~~~30MHz

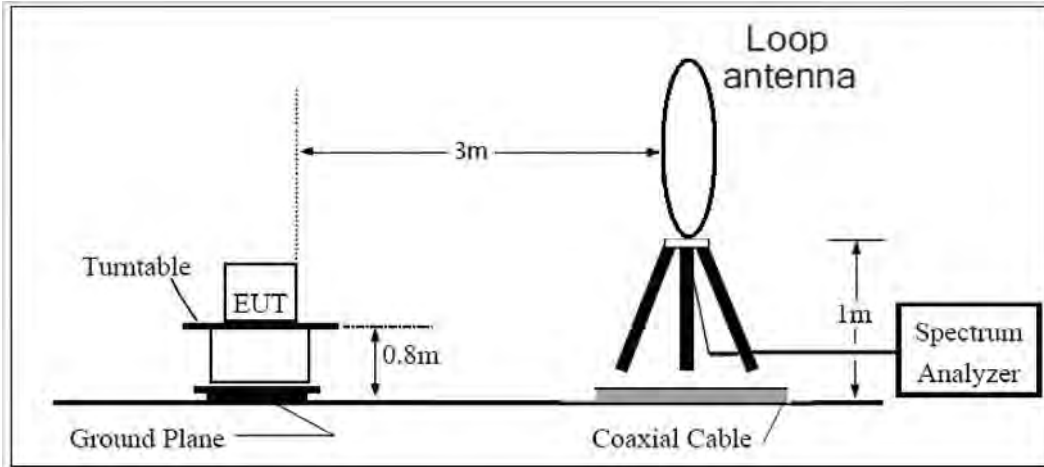

30MHz~~~ 1GHz

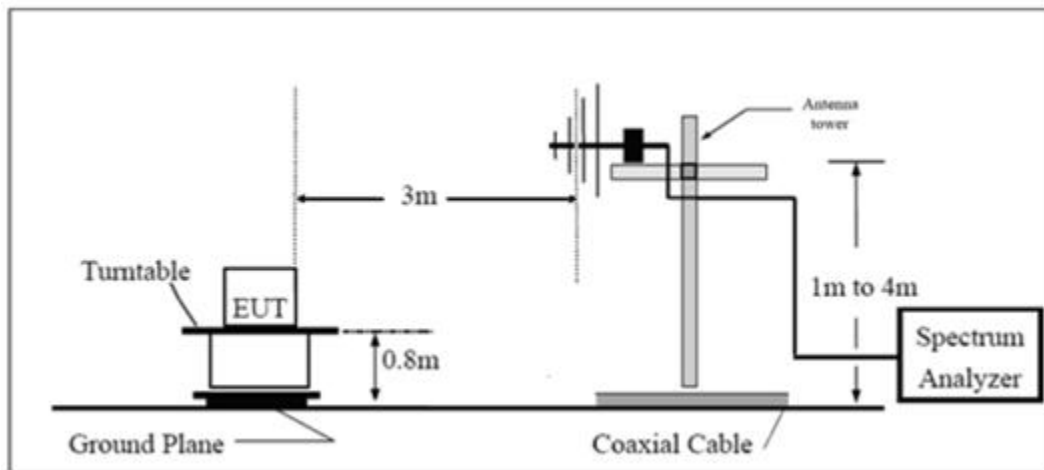

Above 1GHz

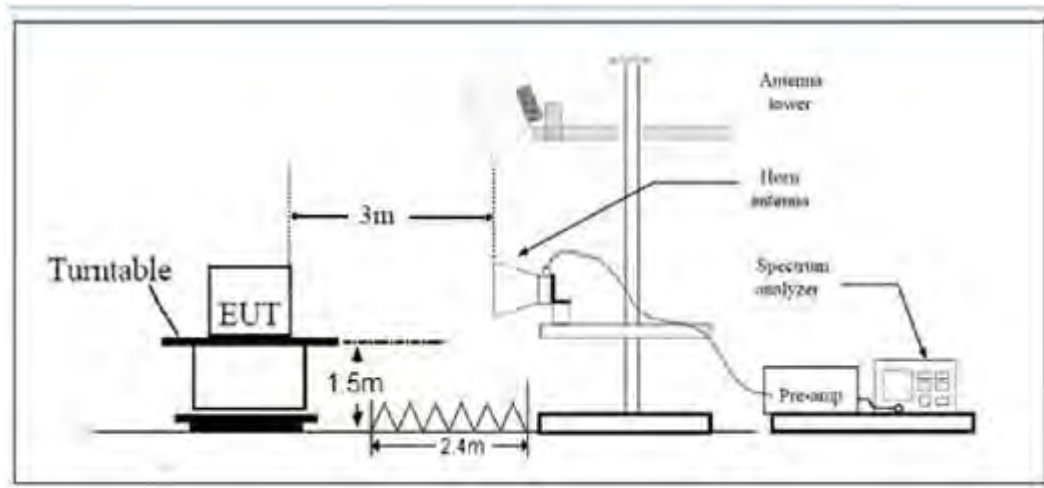

Note: Area side:2.4mX3.6m



**Limits**

- (1) For transmitters operating in the 5725-5850 MHz band: All emissions shall be limited to a level of -27 dBm/MHz at 75 MHz or more above or below the band edge increasing linearly to 10 dBm/MHz at 25 MHz above or below the band edge, and from 25 MHz above or below the band edge increasing linearly to a level of 15.6 dBm/MHz at 5 MHz above or below the band edge, and from 5 MHz above or below the band edge increasing linearly to a level of 27 dBm/MHz at the band edge.
- (2) For transmitters operating in the 5.15-5.25 GHz band: All emissions outside of the 5.15-5.35 GHz band shall not exceed an e.i.r.p. of -27 dBm/MHz(68.2dBμV/m).
- (3) For transmitters operating in the 5.25-5.35 GHz band: All emissions outside of the 5.15-5.35 GHz band shall not exceed an e.i.r.p. of -27 dBm/MHz(68.2dBμV/m).
- (4) For transmitters operating in the 5.47-5.725 GHz band: All emissions outside of the 5.47-5.725 GHz band shall not exceed an e.i.r.p. of -27 dBm/MHz(68.2dBμV/m).

Note: the following formula is used to convert the EIRP to field strength

§1、  $E[\text{dB}\mu\text{V}/\text{m}] = \text{EIRP}[\text{dBm}] - 20 \log(d[\text{meters}]) + 104.77$ , where E = field strength and

d = distance at which field strength limit is specified in the rules;

§2、  $E[\text{dB}\mu\text{V}/\text{m}] = \text{EIRP}[\text{dBm}] + 95.2$ , for d = 3 meters

- (5) Unwanted spurious emissions fallen in restricted bands per FCC Part15.205 shall comply with the general field strength limits set forth in § 15.209 as below table.

Frequency of emission (MHz)	Field strength(uV/m)	Field strength(dBuV/m)
0.009–0.490	2400/F(kHz)	/
0.490–1.705	24000/F(kHz)	/
1.705–30.0	30	/
30-88	100	40
88-216	150	43.5
216-960	200	46
Above960	500	54



MHz	MHz	MHz	GHz
0.090 - 0.110	16.42 - 16.423	399.9 - 410	4.5 - 5.15
0.495 - 0.505	16.69475 - 16.69525	608 - 614	5.35 - 5.46
2.1735 - 2.1905	16.80425 - 16.80475	960 - 1240	7.25 - 7.75
4.125 - 4.128	25.5 - 25.67	1300 - 1427	8.025 - 8.5
4.17725 - 4.17775	37.5 - 38.25	1435 - 1626.5	9.0 - 9.2
4.20725 - 4.20775	73 - 74.6	1645.5 - 1646.5	9.3 - 9.5
6.215 - 6.218	74.8 - 75.2	1660 - 1710	10.6 - 12.7
6.26775 - 6.26825	108 - 121.94	1718.8 - 1722.2	13.25 - 13.4
6.31175 - 6.31225	123 - 138	2200 - 2300	14.47 - 14.5
8.291 - 8.294	149.9 - 150.05	2310 - 2390	15.35 - 16.2
8.362 - 8.366	156.52475 - 156.52525	2483.5 - 2500	17.7 - 21.4
8.37625 - 8.38675	156.7 - 156.9	2690 - 2900	22.01 - 23.12
8.41425 - 8.41475	162.0125 - 167.17	3260 - 3267	23.6 - 24.0
12.29 - 12.293	167.72 - 173.2	3332 - 3339	31.2 - 31.8
12.51975 - 12.52025	240 - 285	3345.8 - 3358	36.43 - 36.5
12.57675 - 12.57725	322 - 335.4	3600 - 4400	( <sup>2</sup> )
13.36 - 13.41			

**Measurement Uncertainty**

The assessed measurement uncertainty to ensure 95% confidence level for the normal distribution is with the coverage factor  $k = 1.96$ .

Frequency	Uncertainty
9KHz-30MHz	3.55 dB
30MHz-200MHz	4.17 dB
200MHz-1GHz	4.84 dB
1-18GHz	4.35 dB
18-26.5GHz	5.90 dB
26.5GHz~40GHz	5.92 dB



**Test Results:**

The modulation and bandwidth are similar for 802.11n mode for 20MHz/40MHz and 802.11ac mode for V20MHz/V40MHz, therefore investigated worst case to representative mode in test report.

A font (Level in dB $\mu$ V/m) in the test plot =(level in dB  $\mu$  V/m)

A font (Level in dB $\mu$ V) in the test plot =(level in dB  $\mu$  V/m)

The signal beyond the limit is carrier.

**U-NII-1**

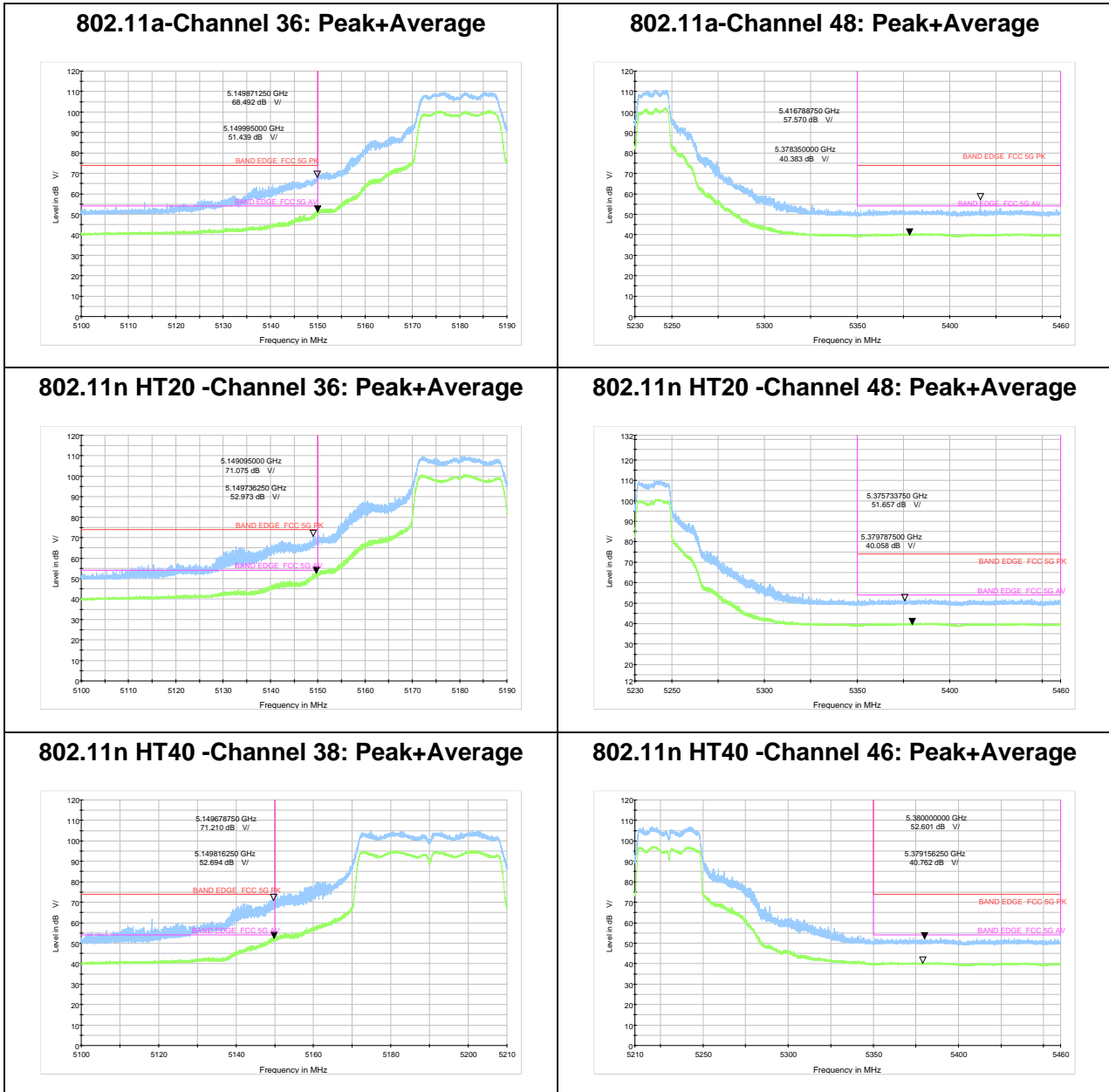





### 802.11ac VHT80-Channel 42: Peak+Average

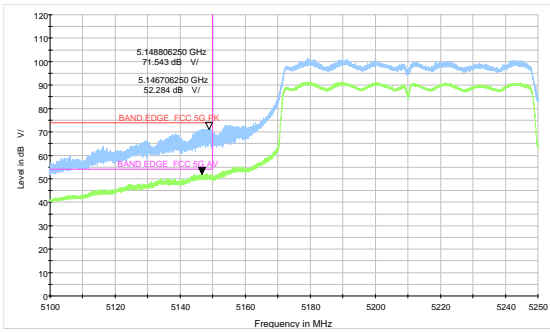

### 802.11ax HE20 -Channel 36: Peak+Average

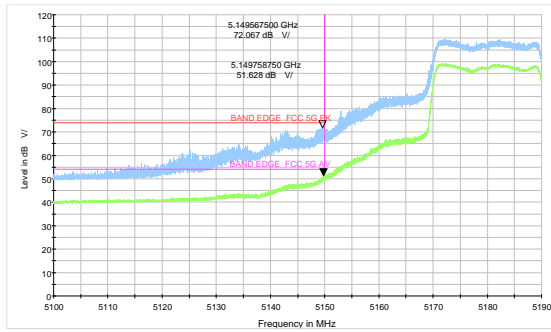

### 802.11ax HE20 -Channel 48: Peak+Average

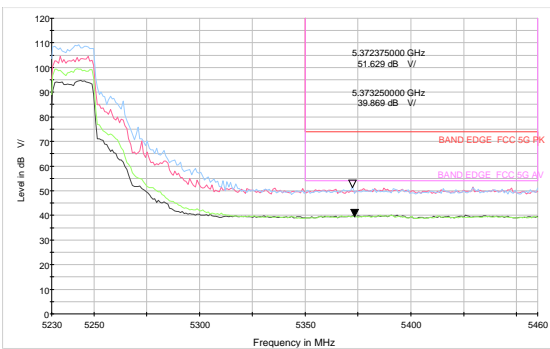

### 802.11ax HE40-Channel 38: Peak+Average

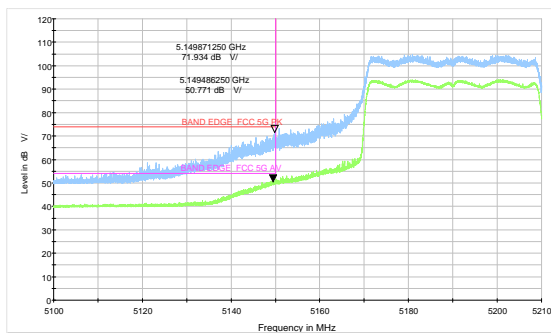

### 802.11ax HE40-Channel 46: Peak+Average

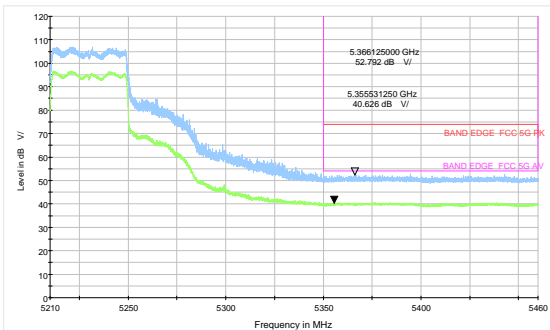

### 802.11ax HE80-Channel 42: Peak+Average

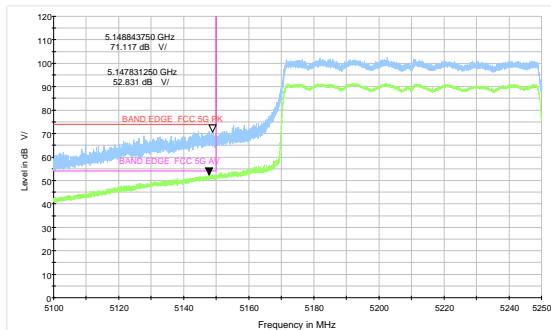



U-NII-2A

802.11a-Channel 52: Peak+Average

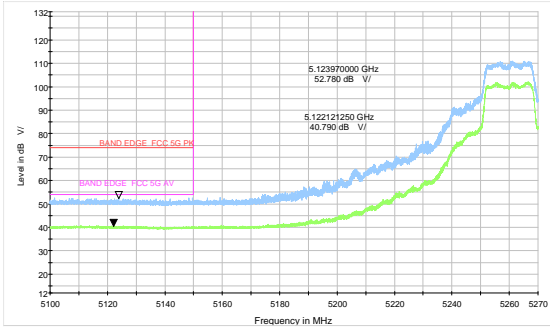

802.11a-Channel 64: Peak+Average

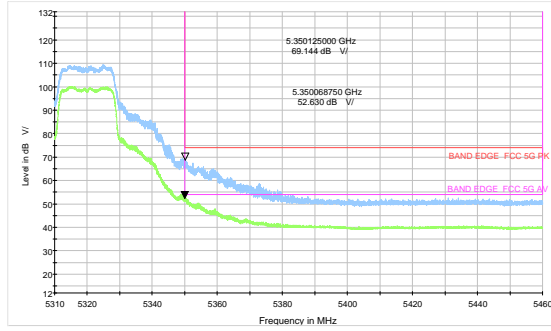

802.11n HT20 -Channel 52: Peak+Average

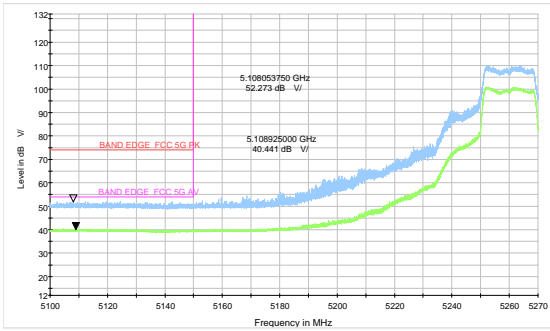

802.11n HT20 -Channel 64: Peak+Average

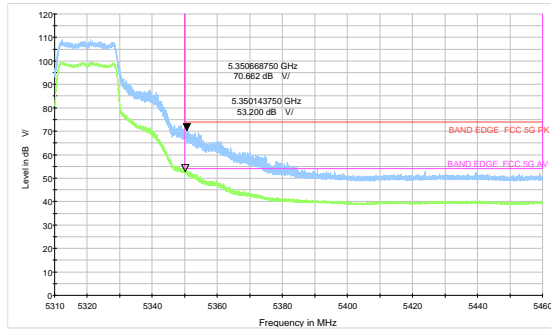

802.11n HT40-Channel 54: Peak+Average

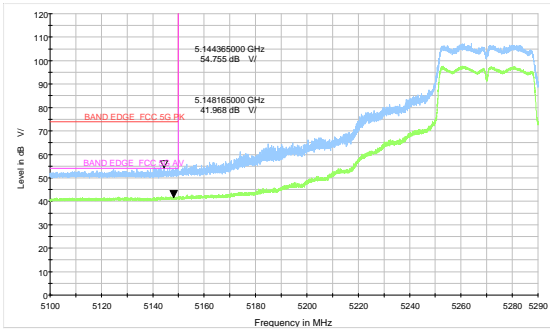

802.11n HT40-Channel 62: Peak+Average

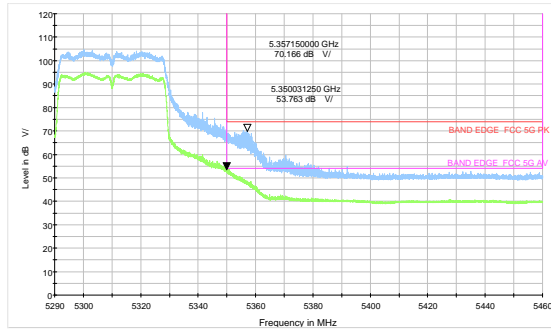

802.11ac VHT80- Channel 58: Peak+Average

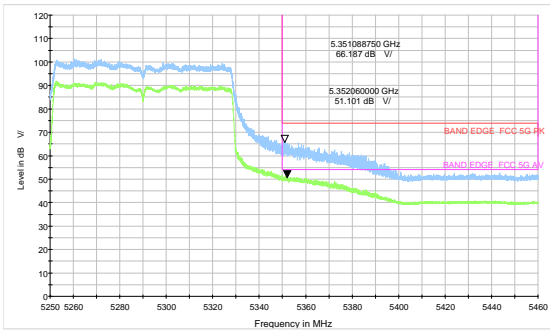

802.11ax HE20 -Channel 64: Peak+Average

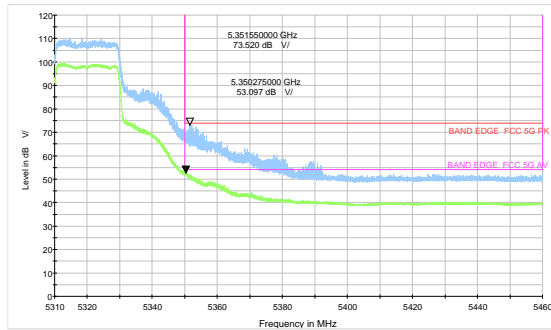



### 802.11ax HE40-Channel 54: Peak+Average

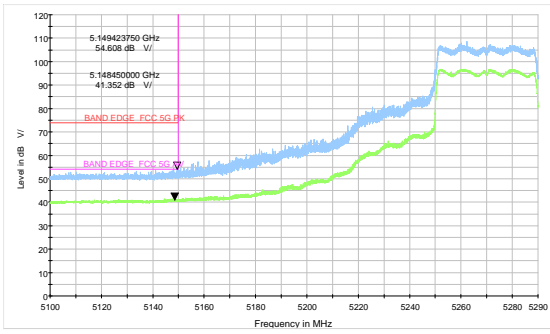

### 802.11ax HE40-Channel 62: Peak+Average

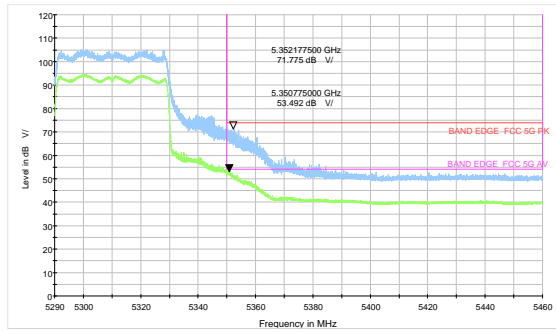

### 802.11ax HE80- Channel 58: Peak+Average

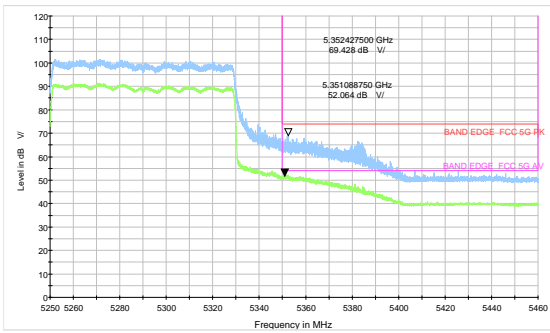





U-NII-2C

802.11a-Channel 100: Peak+Average

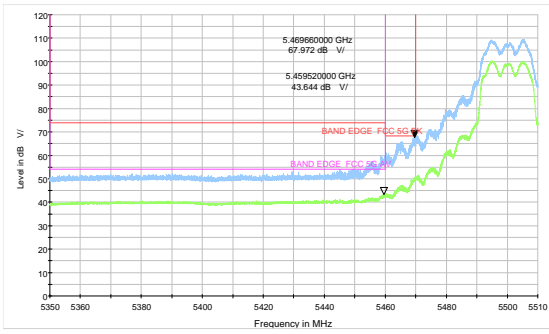

802.11n HT20-Channel 100: Peak+Average

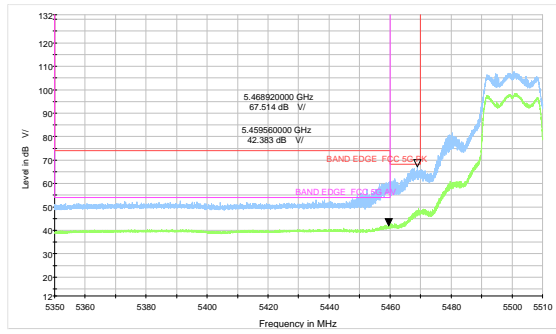

802.11a-Channel 140: Peak

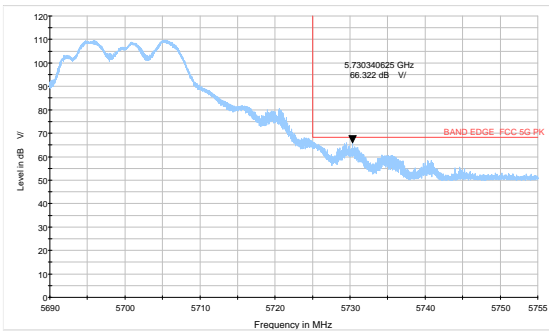

802.11n HT20-Channel 140: Peak+Average

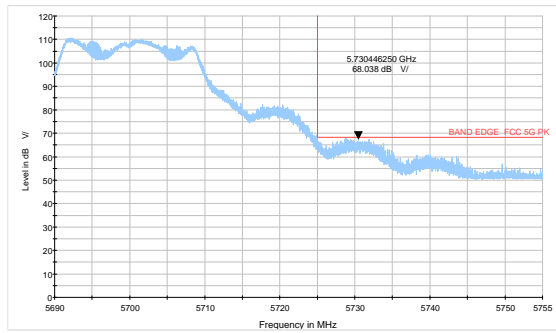

802.11a-Channel 144: Peak

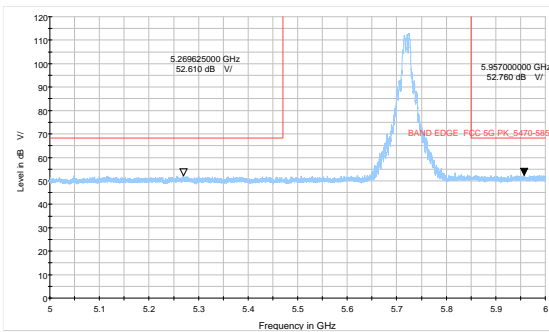

802.11n HT20-Channel 144: Peak

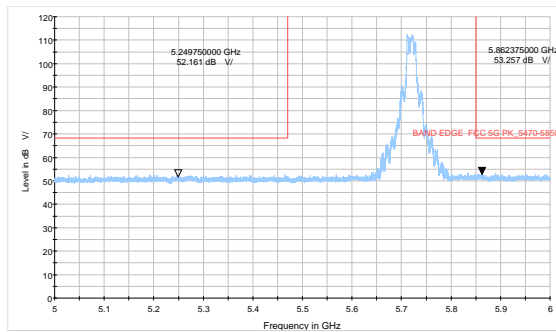

802.11n HT40-Channel 102: Peak+Average

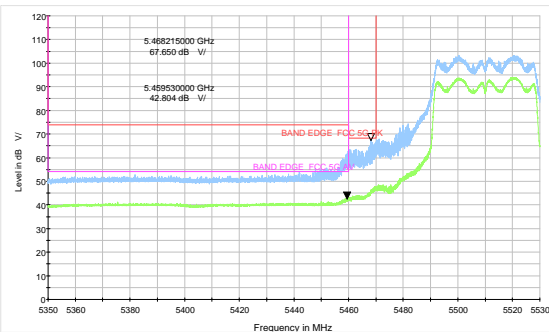

802.11n HT40-Channel 134: Peak

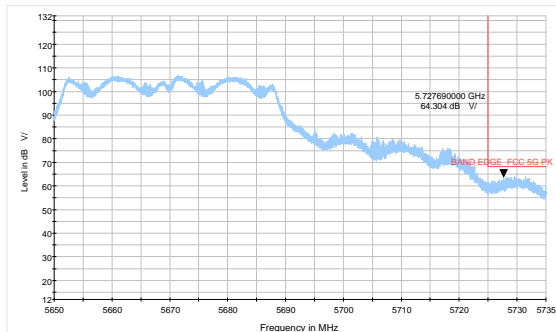



802.11n HT40-Channel 142: Peak

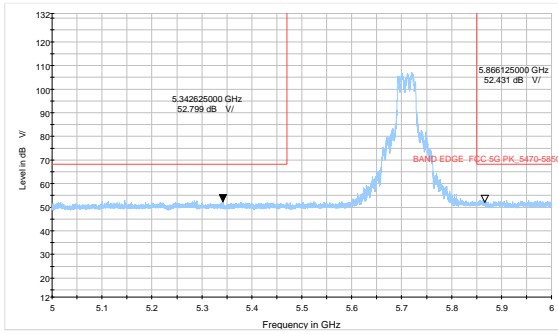

802.11ac VHT80-Channel 106: Peak+Average

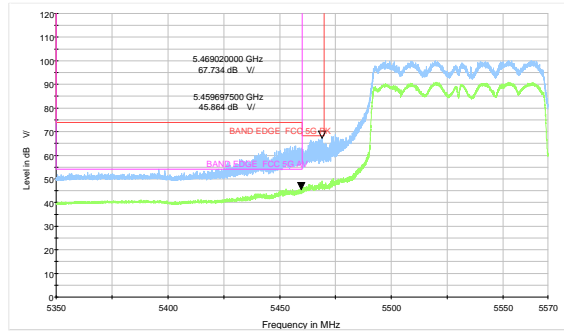

802.11ac VHT80 -Channel 138: Peak

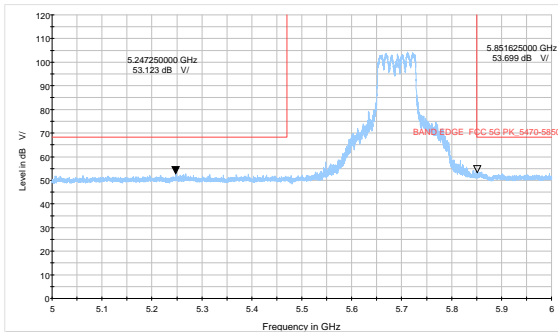

802.11ax HE20-Channel 100: Peak+Average

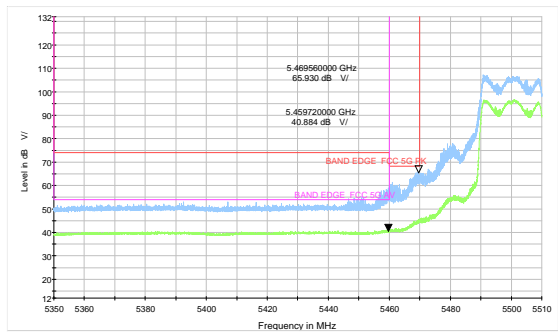

802.11ax HE40-Channel 102: Peak+Average

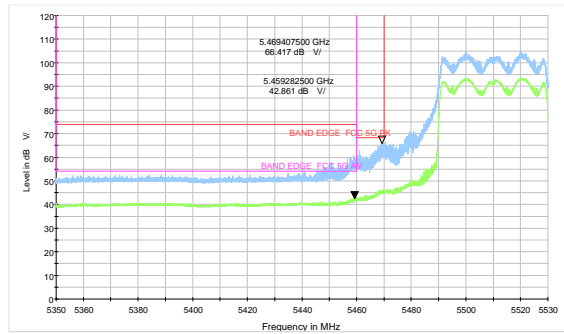

802.11ax HE20-Channel 140: Peak

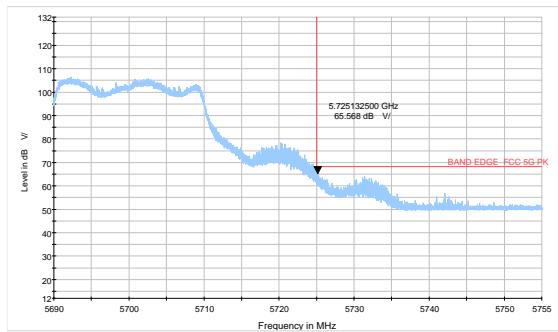

802.11ax HE40-Channel 134: Peak

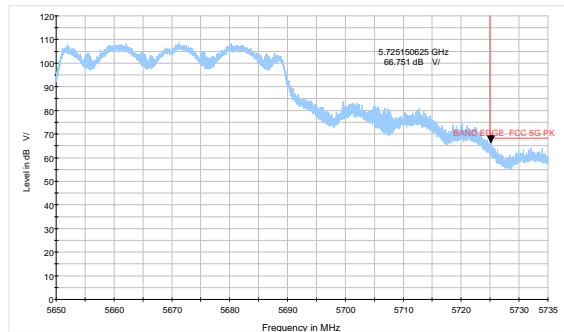



### 802.11ax HE20-Channel 144: Peak

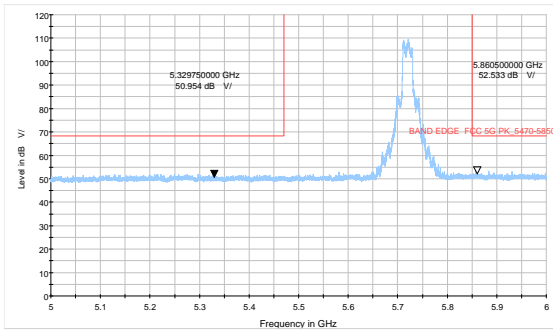

### 802.11ax HE40-Channel 142: Peak

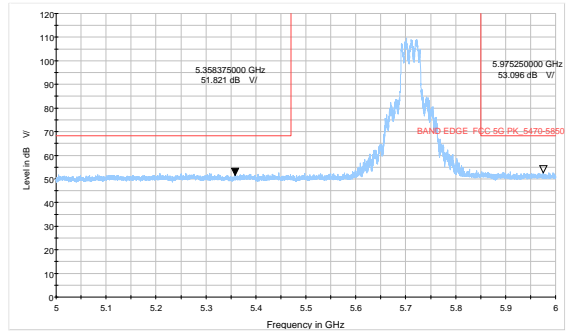

### 802.11ax HE80-Channel 106: Peak+Average

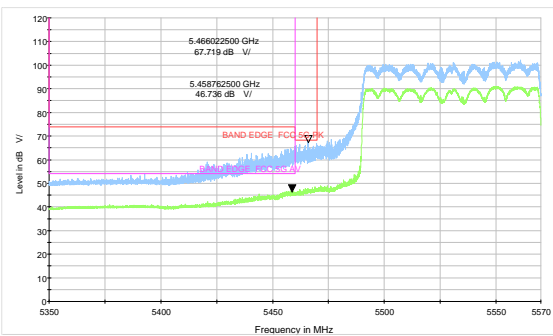

### 802.11ax HE80-Channel 138: Peak+Average

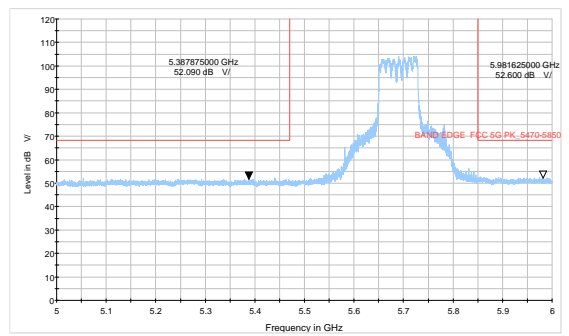



U-NII-3

802.11a-Channel 149: Peak

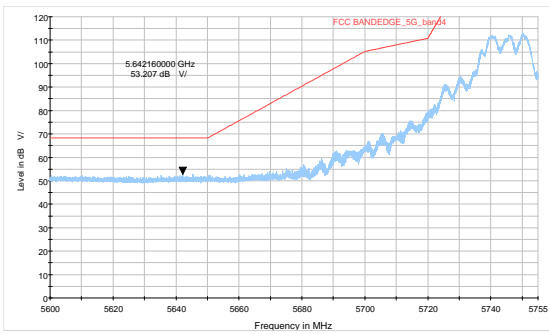

802.11a-Channel 165: Peak+Average

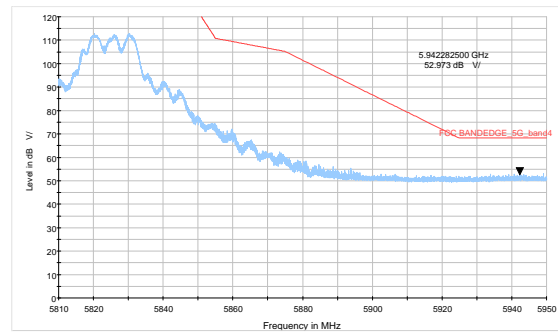

802.11n HT20-Channel 149: Peak

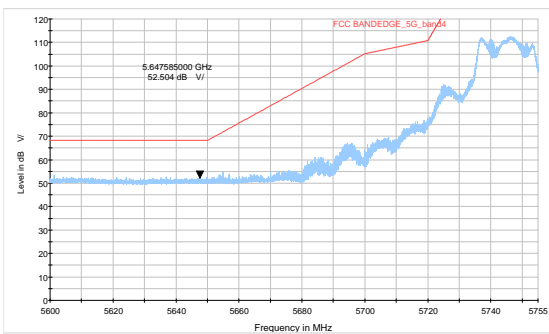

802.11n HT20-Channel 165: Peak

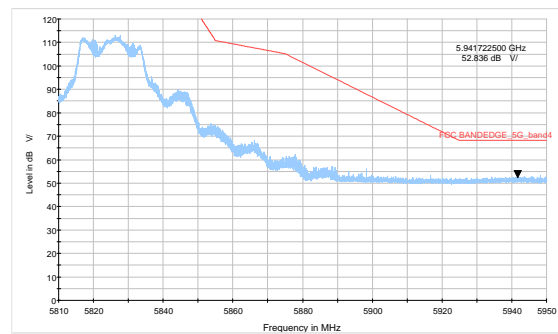

802.11n HT40-Channel 151: Peak

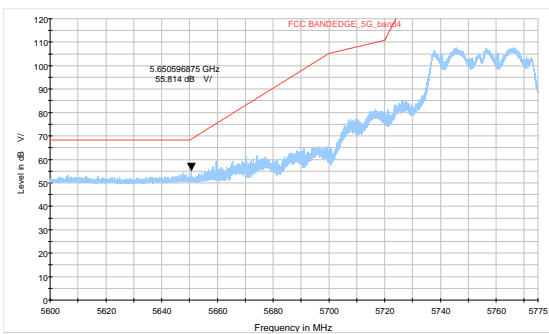

802.11n HT40-Channel 159: Peak

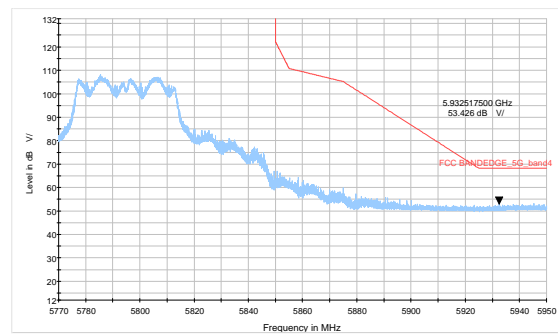

802.11ac VHT80- Channel 155: Peak

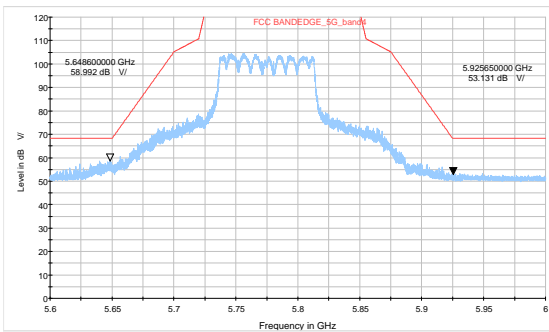

802.11ax HE20-Channel 149: Peak

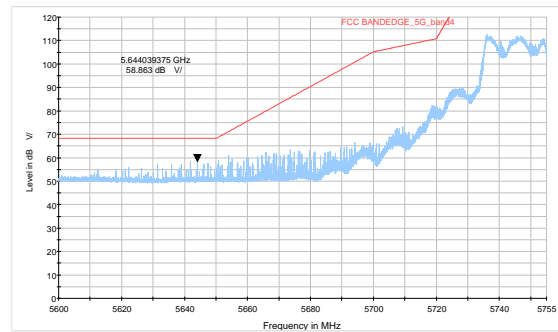



### 802.11ax HE40-Channel 151: Peak

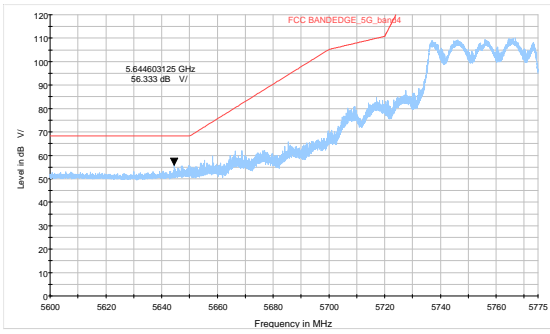

### 802.11ax HE20-Channel 165: Peak

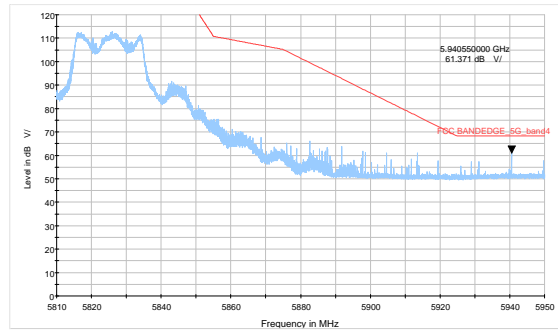

### 802.11ax HE40-Channel 159: Peak

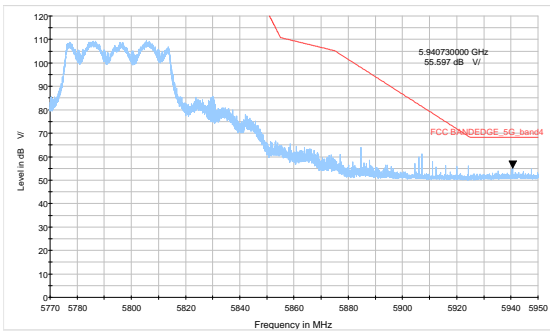

### 802.11ax HE80- Channel 155: Peak

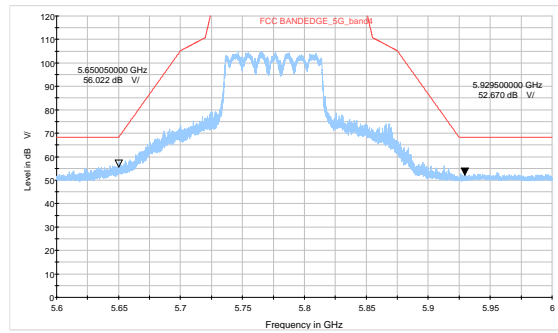





**After the pretest, MIMO was selected as the worst antenna.**

A font (Level in dB  $\mu$  V/m) in the test plot =(level in dB  $\mu$  V/m)

During the test, the Radiates Emission from 30MHz to 1GHz was performed in all modes with all channels, 802.11ax (HE40), Channel 46 are selected as the worst condition. The test data of the worst-case condition was recorded in this report.

**Continuous TX mode:**

FCC RE 9K-90KHz AV

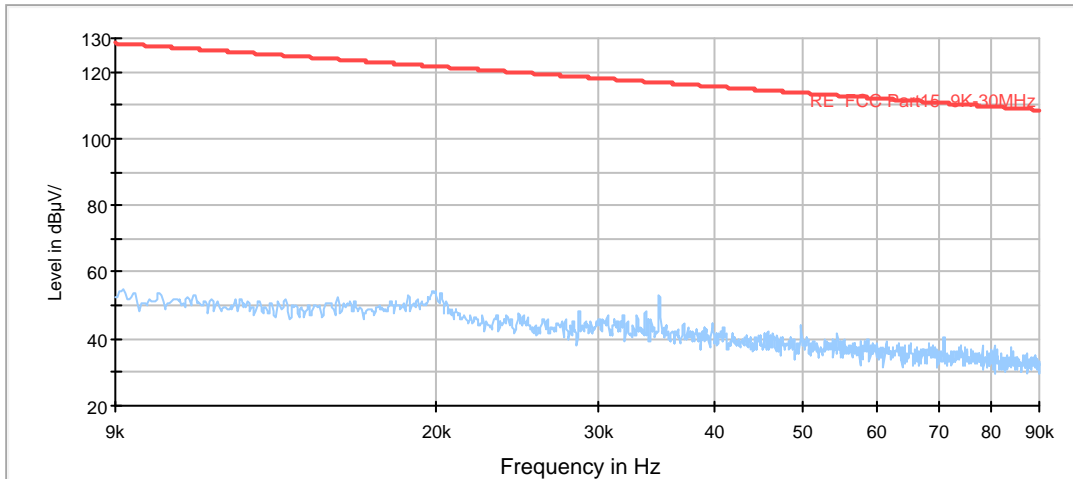

Radiates Emission from 9KHz to 90KHz

FCC RE 90K-110KHz QP

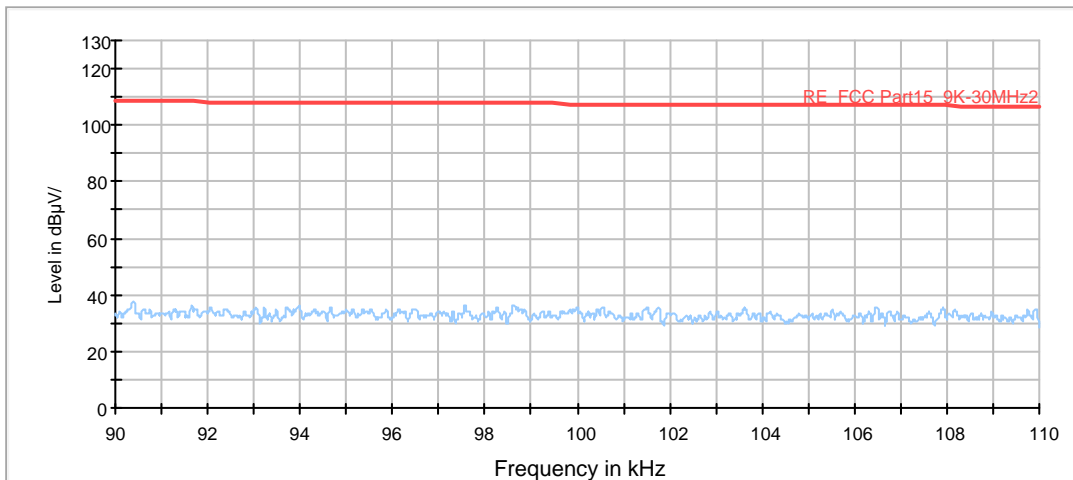

Radiates Emission from 90KHz to 110KHz



FCC RE 110K-490KHz AV

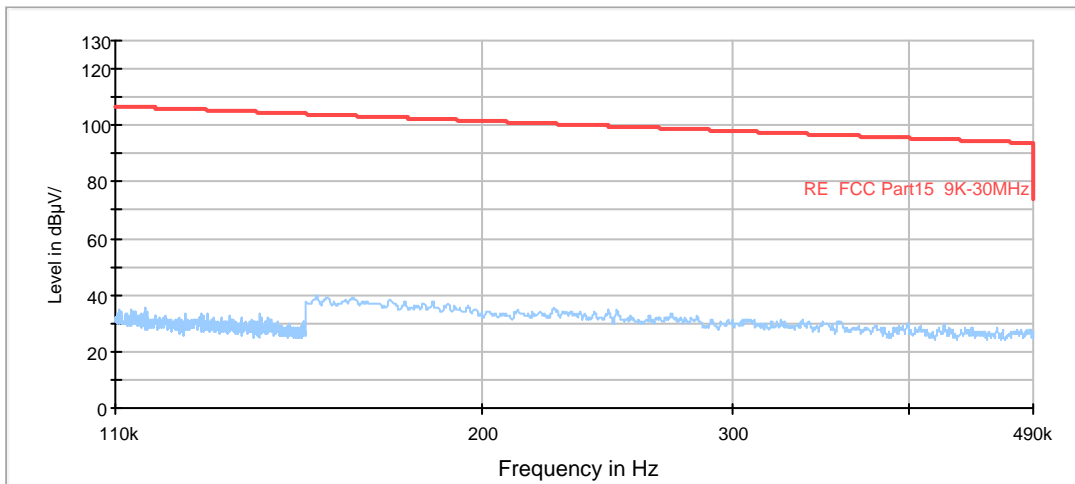

Radiates Emission from 110KHz to 490KHz

FCC RE 490K-30MHz QP

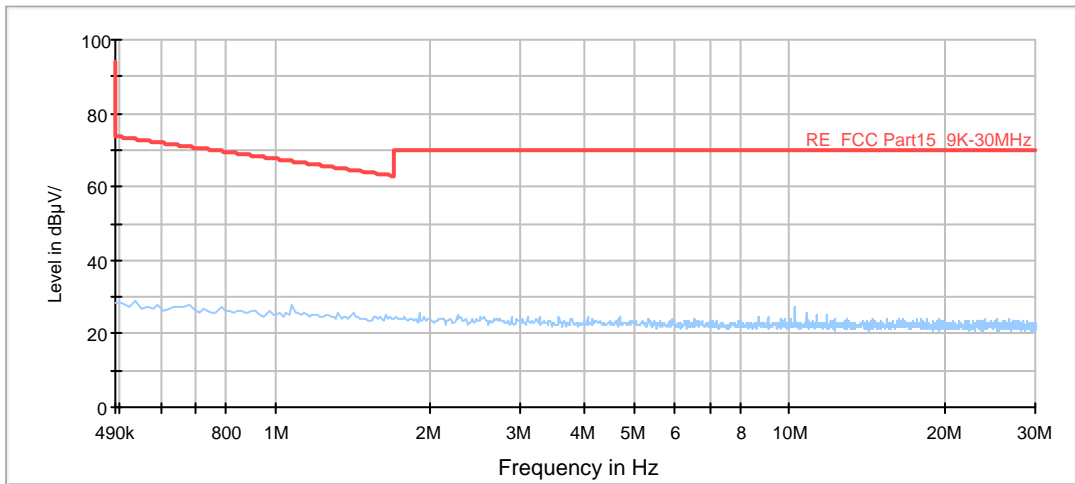

Radiates Emission from 490KHz to 30MHz

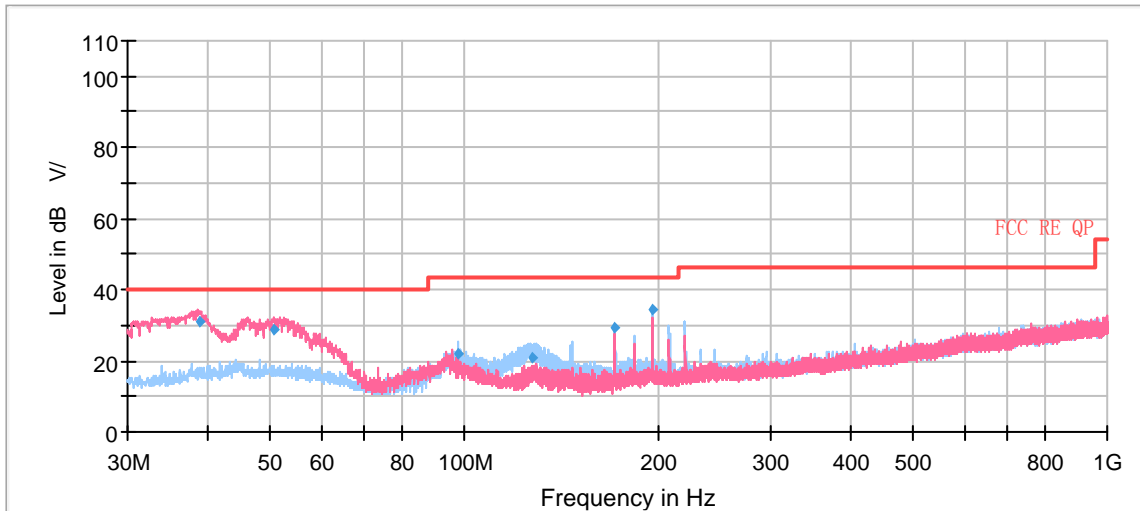

Radiates Emission from 30MHz to 1GHz

Frequency (MHz)	Quasi-Peak (dBuV/m)	Height (cm)	Polarization	Azimuth (deg)	Correct Factor (dB)	Margin (dB)	Limit (dBuV/m)
38.79	31.17	100.0	V	291.00	19	8.83	40.00
50.61	28.57	109.0	V	24.00	21	11.44	40.00
98.16	21.73	200.0	H	112.00	19	21.77	43.50
127.81	21.05	175.0	H	118.00	15	22.45	43.50
171.76	29.10	175.0	H	106.00	16	14.40	43.50
196.30	34.38	110.0	H	98.00	18	9.12	43.50

Remark: 1. Correction Factor = Antenna factor+ Insertion loss(cable loss+amplifier gain)  
 2. Margin = Limit – Quasi-Peak



802.11a CH36

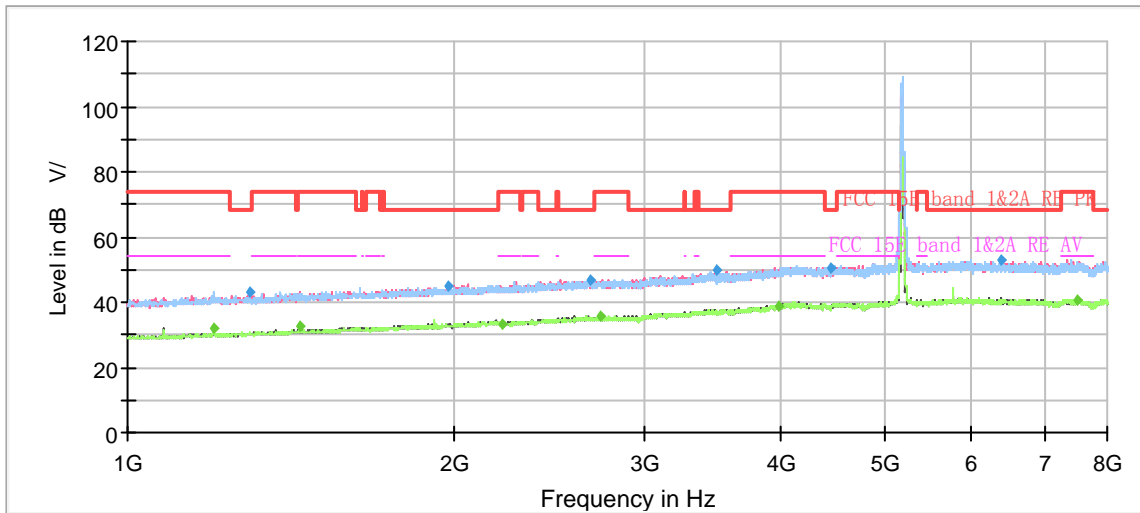

Note: The signal beyond the limit is carrier.  
Radiates Emission from 1GHz to 8GHz

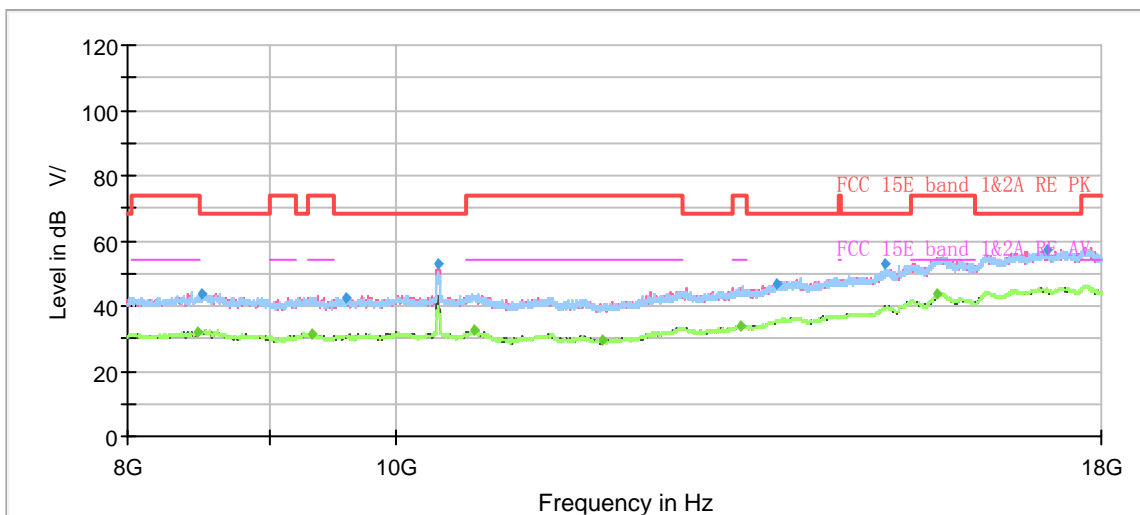

Radiates Emission from 8GHz to 18GHz



Frequency (MHz)	Peak (dBuV/m)	Average (dBuV/m)	Limit (dBuV/m)	Margin (dB)	Height (cm)	Polarization	Azimuth (deg)	Correct Factor (dB)
1199.50	---	32.16	54.00	21.84	200.0	V	311.00	-8
1295.75	43.01	---	68.20	25.19	100.0	H	153.00	-7
1440.13	---	32.41	54.00	21.59	200.0	H	85.00	-6
1974.75	44.69	---	68.20	23.51	100.0	H	65.00	-3
2215.38	---	33.36	54.00	20.64	200.0	V	286.00	-2
2672.13	46.84	---	68.20	21.36	200.0	V	311.00	0
2728.13	---	35.61	54.00	18.39	100.0	V	255.00	1
3484.13	50.13	---	68.20	18.07	200.0	V	230.00	4
3987.25	---	38.92	54.00	15.08	200.0	V	60.00	6
4439.63	50.44	---	68.20	17.76	200.0	V	335.00	7
6388.25	52.71	---	68.20	15.49	100.0	H	325.00	10
7507.38	---	40.72	54.00	13.28	100.0	H	183.00	11

Remark: 1. Correction Factor = Antenna factor+ Insertion loss (cable loss + amplifier gain)





802.11a CH40

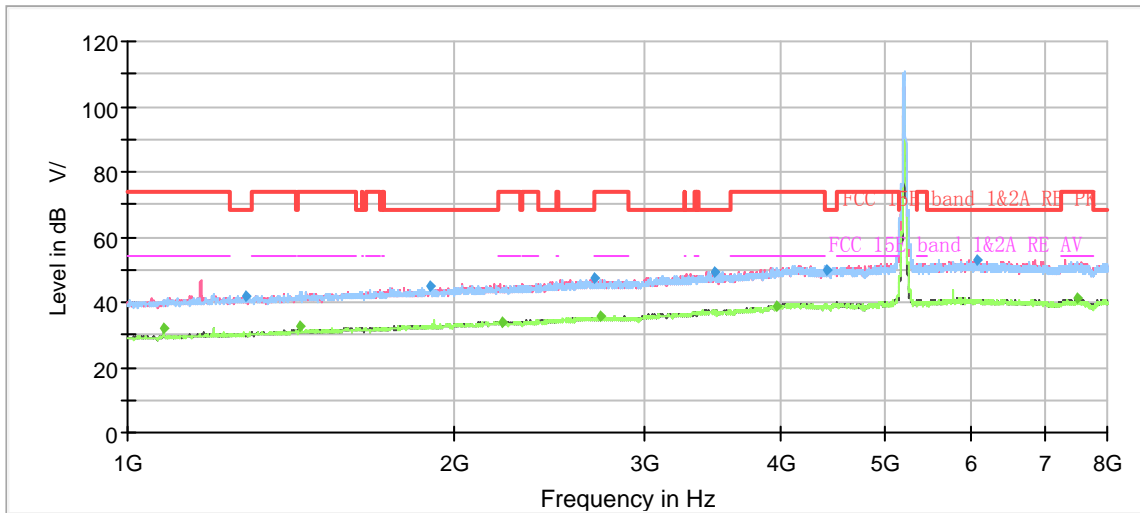

Note: The signal beyond the limit is carrier.  
Radiates Emission from 1GHz to 8GHz

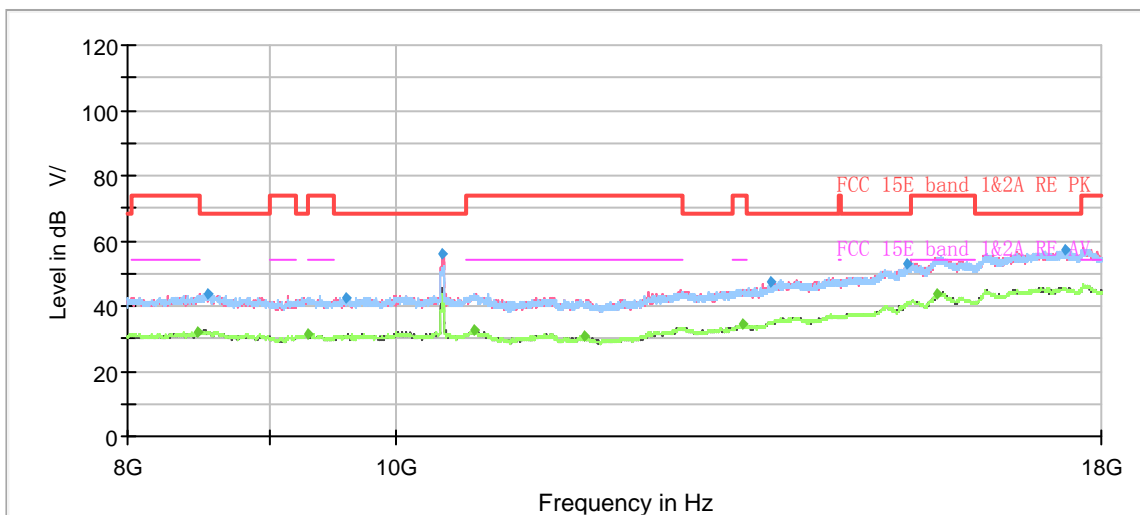

Radiates Emission from 8GHz to 18GHz



Frequency (MHz)	Peak (dBuV/m)	Average (dBuV/m)	Limit (dBuV/m)	Margin (dB)	Height (cm)	Polarization	Azimuth (deg)	Correct Factor (dB)
1079.63	---	32.25	54.00	21.75	100.0	V	113.00	-8
1282.63	41.83	---	68.20	26.37	100.0	V	188.00	-7
1440.13	---	32.71	54.00	21.29	200.0	H	26.00	-6
1903.88	44.90	---	68.20	23.30	200.0	H	21.00	-4
2211.00	---	33.71	54.00	20.29	200.0	V	262.00	-2
2689.63	47.15	---	68.20	21.05	100.0	H	335.00	1
2723.75	---	35.81	54.00	18.19	100.0	V	59.00	1
3478.88	49.39	---	68.20	18.81	100.0	V	64.00	4
3966.25	---	39.03	54.00	14.97	200.0	V	106.00	6
4411.63	49.89	---	68.20	18.31	200.0	V	179.00	7
6067.13	53.05	---	68.20	15.15	100.0	V	64.00	10
7496.88	---	40.94	54.00	13.06	200.0	V	116.00	11

Remark: 1. Correction Factor = Antenna factor+ Insertion loss (cable loss + amplifier gain)



### 802.11a CH48

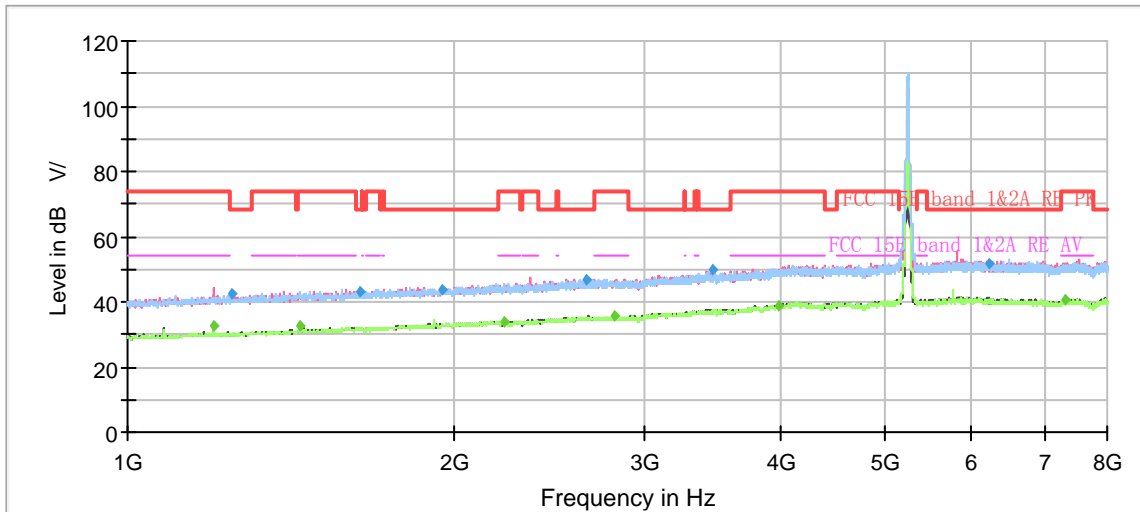

Note: The signal beyond the limit is carrier.  
Radiates Emission from 1GHz to 8GHz

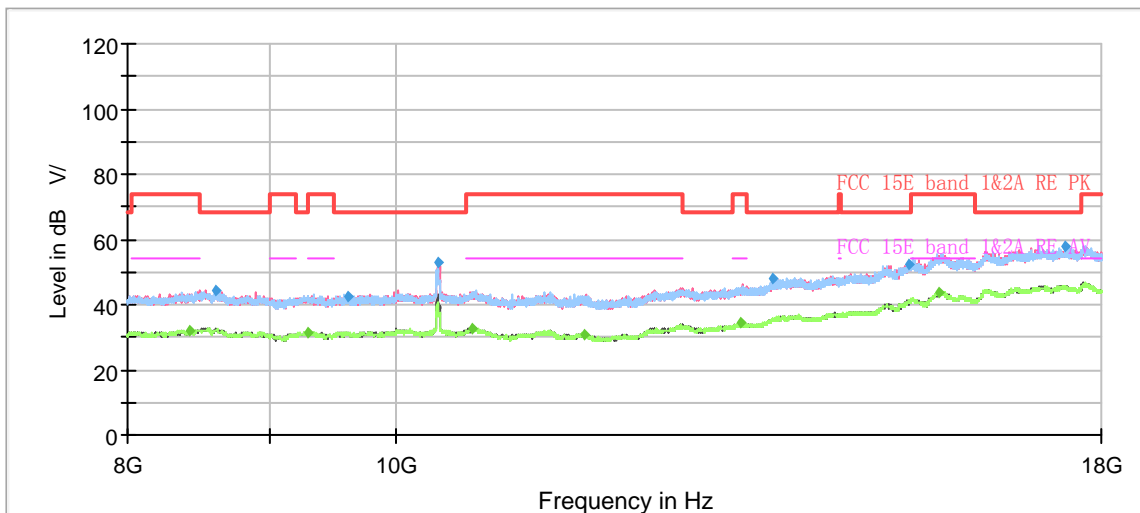

Radiates Emission from 8GHz to 18GHz



Frequency (MHz)	Peak (dBuV/m)	Average (dBuV/m)	Limit (dBuV/m)	Margin (dB)	Height (cm)	Polarization	Azimuth (deg)	Correct Factor (dB)
1199.50	---	32.31	54.00	21.69	100.0	V	134.00	-8
1245.88	42.20	---	68.20	26.00	100.0	H	2.00	-7
1440.13	---	32.71	54.00	21.29	200.0	H	332.00	-6
1635.25	43.02	---	68.20	25.18	100.0	V	114.00	-5
1948.50	43.66	---	68.20	24.54	200.0	V	241.00	-3
2221.50	---	33.57	54.00	20.43	100.0	V	294.00	-2
2651.13	46.80	---	68.20	21.40	200.0	H	107.00	0
2813.00	---	35.61	54.00	18.39	200.0	V	236.00	1
3457.88	49.61	---	68.20	18.59	200.0	H	14.00	4
3982.88	---	39.02	54.00	14.98	100.0	V	168.00	6
6218.50	51.99	---	68.20	16.21	100.0	V	8.00	10
7329.75	---	40.68	54.00	13.32	200.0	V	171.00	11

Remark: 1. Correction Factor = Antenna factor+ Insertion loss (cable loss + amplifier gain)



### 802.11a CH52

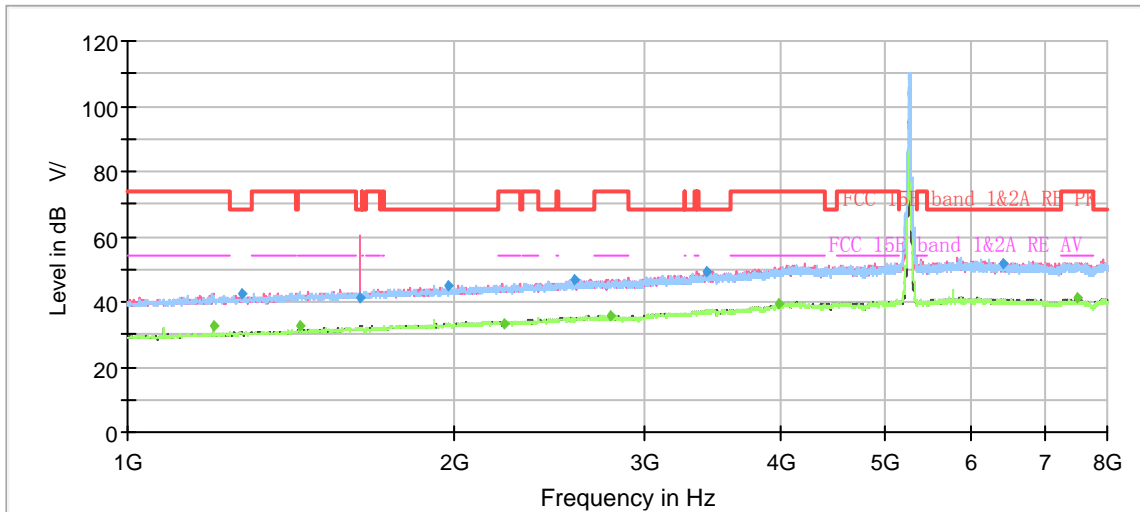

Note: The signal beyond the limit is carrier.  
Radiates Emission from 1GHz to 8GHz

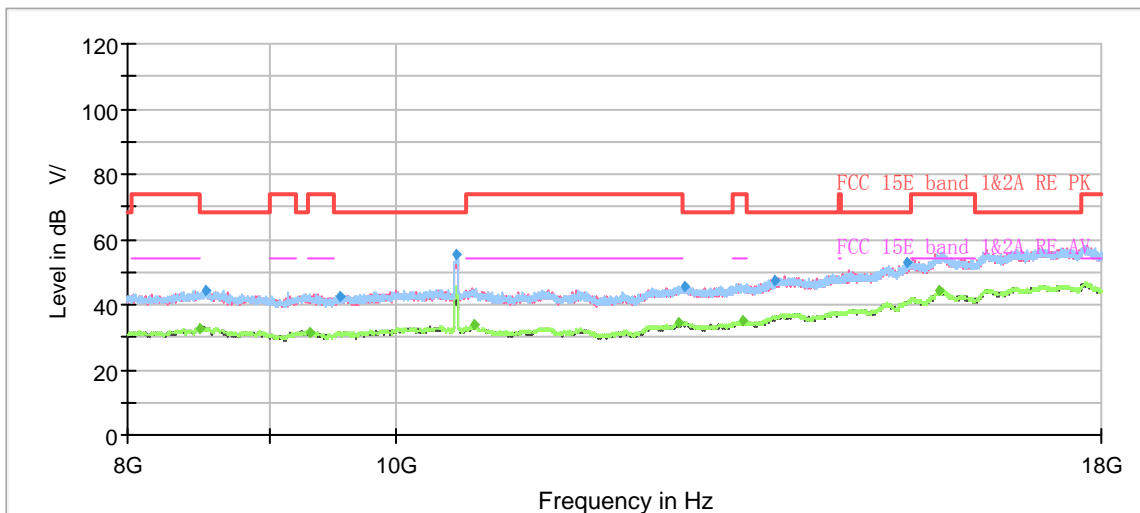

Radiates Emission from 8GHz to 18GHz





Frequency (MHz)	Peak (dBuV/m)	Average (dBuV/m)	Limit (dBuV/m)	Margin (dB)	Height (cm)	Polarization	Azimuth (deg)	Correct Factor (dB)
1199.50	---	32.50	54.00	21.50	100.0	V	123.00	-8
1273.00	42.20	---	68.20	26.00	100.0	H	346.00	-7
1440.13	---	32.54	54.00	21.47	200.0	H	343.00	-6
1634.38	41.50	---	68.20	26.70	200.0	H	216.00	-5
1972.13	45.05	---	68.20	23.15	200.0	V	0.00	-3
2221.50	---	33.38	54.00	20.62	200.0	V	282.00	-2
2582.00	46.95	---	68.20	21.25	200.0	V	313.00	0
2788.50	---	35.54	54.00	18.46	100.0	V	10.00	1
3424.63	49.08	---	68.20	19.12	100.0	H	284.00	4
3977.63	---	39.10	54.00	14.90	200.0	V	203.00	6
6420.63	51.82	---	68.20	16.38	200.0	V	203.00	10
7504.75	---	41.29	54.00	12.71	100.0	V	113.00	11

Remark: 1. Correction Factor = Antenna factor+ Insertion loss (cable loss + amplifier gain)

802.11a CH60

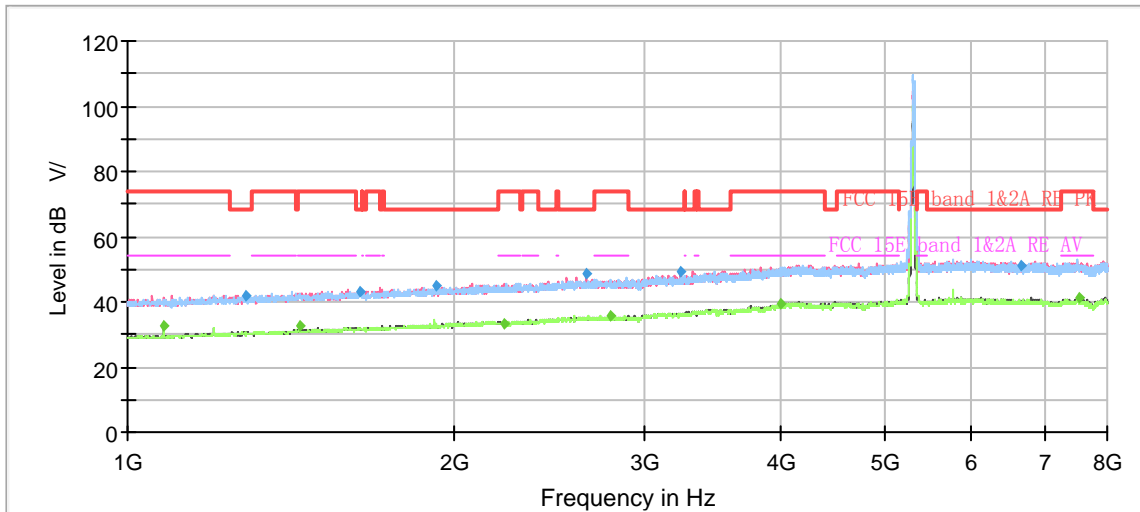

Note: The signal beyond the limit is carrier.  
Radiates Emission from 1GHz to 8GHz

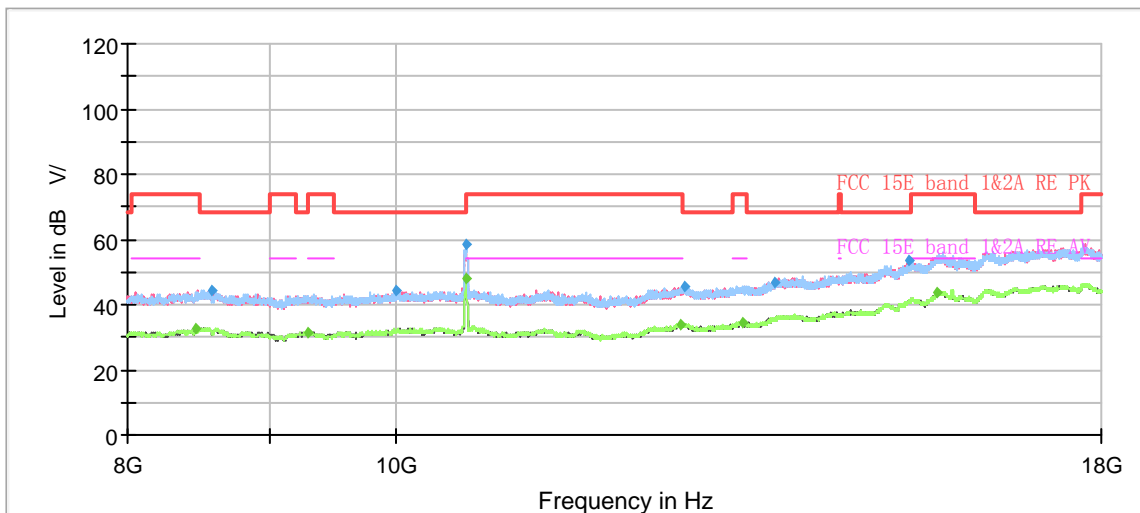

Radiates Emission from 8GHz to 18GHz



Frequency (MHz)	Peak (dBuV/m)	Average (dBuV/m)	Limit (dBuV/m)	Margin (dB)	Height (cm)	Polarization	Azimuth (deg)	Correct Factor (dB)
1079.63	---	32.63	54.00	21.37	200.0	V	0.00	-8
1285.25	41.83	---	68.20	26.37	200.0	V	305.00	-7
1440.13	---	32.80	54.00	21.20	200.0	V	178.00	-6
1634.38	42.97	---	68.20	25.23	100.0	V	158.00	-5
1927.50	44.89	---	68.20	23.31	100.0	V	231.00	-3
2221.50	---	33.46	54.00	20.54	100.0	V	2.00	-2
2647.63	48.54	---	68.20	19.66	100.0	V	31.00	0
2783.25	---	35.67	54.00	18.33	100.0	H	275.00	1
3229.50	49.21	---	68.20	18.99	200.0	V	339.00	3
3996.00	---	39.08	54.00	14.92	100.0	V	177.00	6
6656.00	51.22	---	68.20	16.98	200.0	V	238.00	10
7545.00	---	41.04	54.00	12.96	100.0	V	162.00	11

Remark: 1. Correction Factor = Antenna factor+ Insertion loss (cable loss + amplifier gain)

802.11a CH64

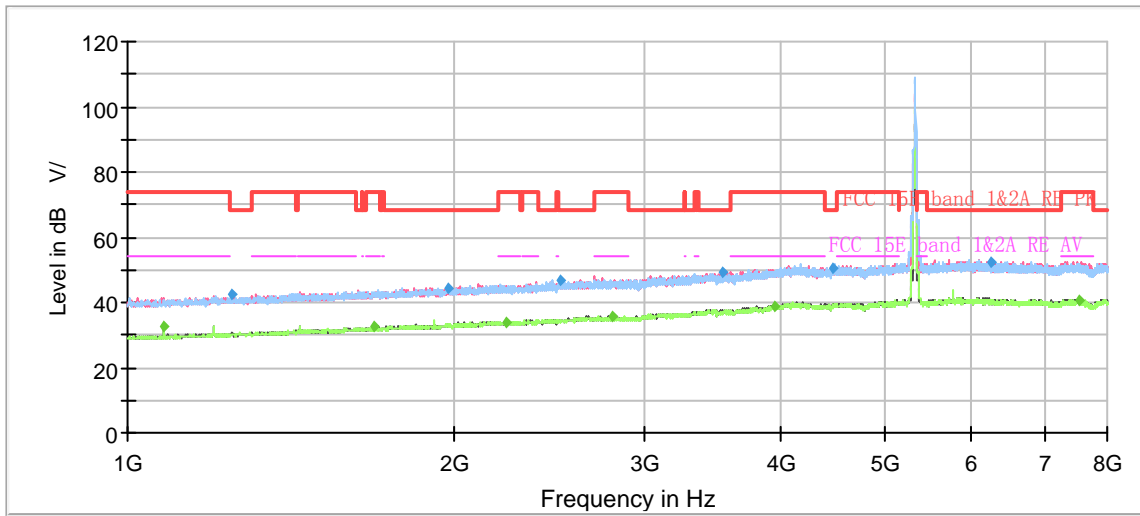

Note: The signal beyond the limit is carrier.  
Radiates Emission from 1GHz to 8GHz

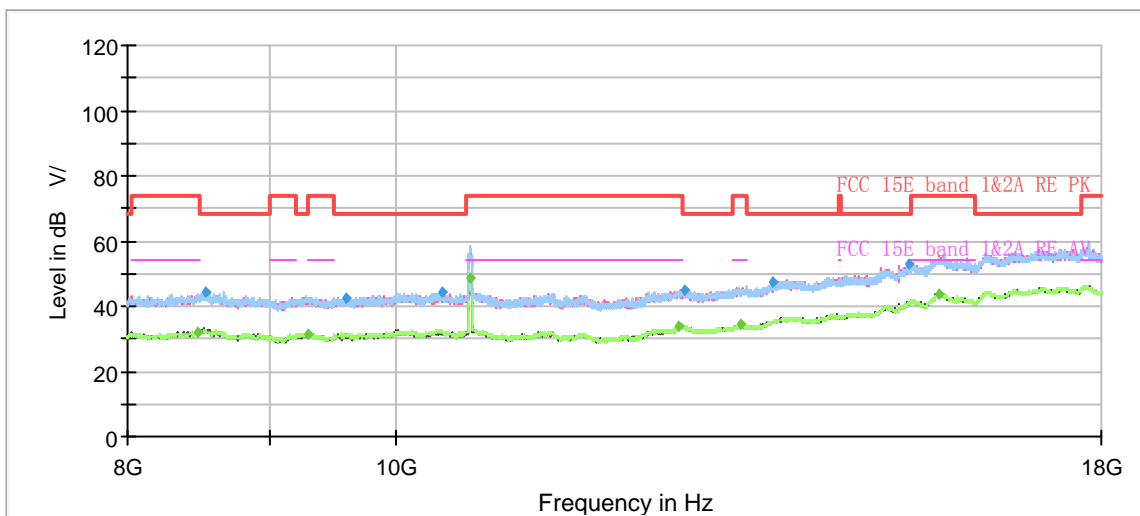

Radiates Emission from 8GHz to 18GHz



Frequency (MHz)	Peak (dBuV/m)	Average (dBuV/m)	Limit (dBuV/m)	Margin (dB)	Height (cm)	Polarization	Azimuth (deg)	Correct Factor (dB)
1079.63	---	32.46	54.00	21.54	200.0	V	0.00	-8
1247.63	42.29	---	68.20	25.91	100.0	H	322.00	-7
1688.63	---	32.84	54.00	21.16	100.0	V	307.00	-5
1976.50	44.59	---	68.20	23.61	200.0	H	167.00	-3
2230.25	---	34.06	54.00	19.94	100.0	H	275.00	-2
2503.25	46.73	---	68.20	21.47	100.0	H	317.00	0
2797.25	---	35.79	54.00	18.21	100.0	H	326.00	1
3534.88	49.29	---	68.20	18.91	200.0	H	191.00	4
3943.50	---	38.98	54.00	15.02	100.0	H	308.00	6
4465.00	50.50	---	68.20	17.70	100.0	V	88.00	7
6262.25	52.20	---	68.20	16.00	100.0	H	34.00	10
7539.75	---	40.66	54.00	13.34	200.0	V	90.00	11

Remark: 1. Correction Factor = Antenna factor+ Insertion loss (cable loss + amplifier gain)



802.11a CH100

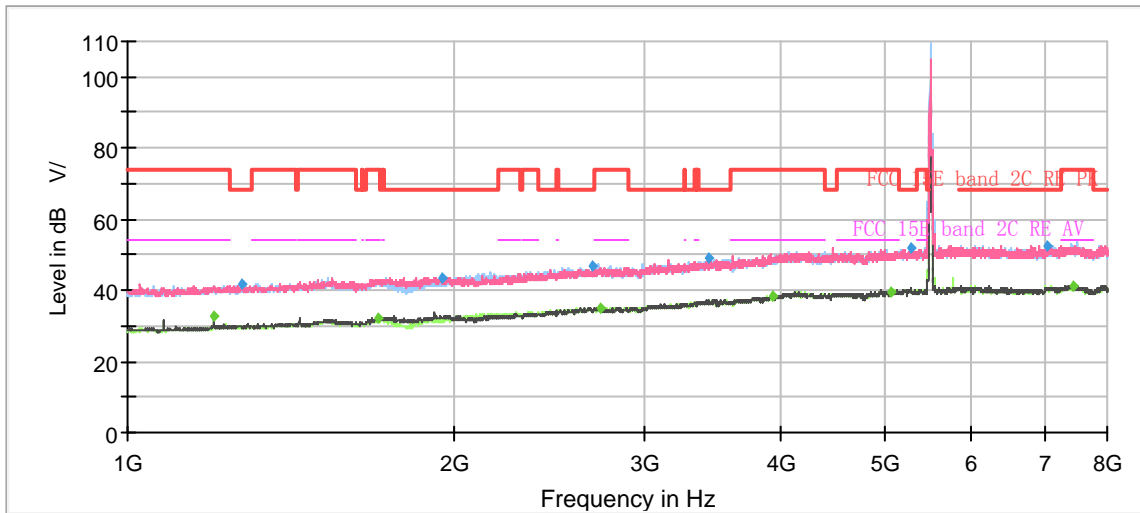

Note: The signal beyond the limit is carrier.  
Radiates Emission from 1GHz to 8GHz

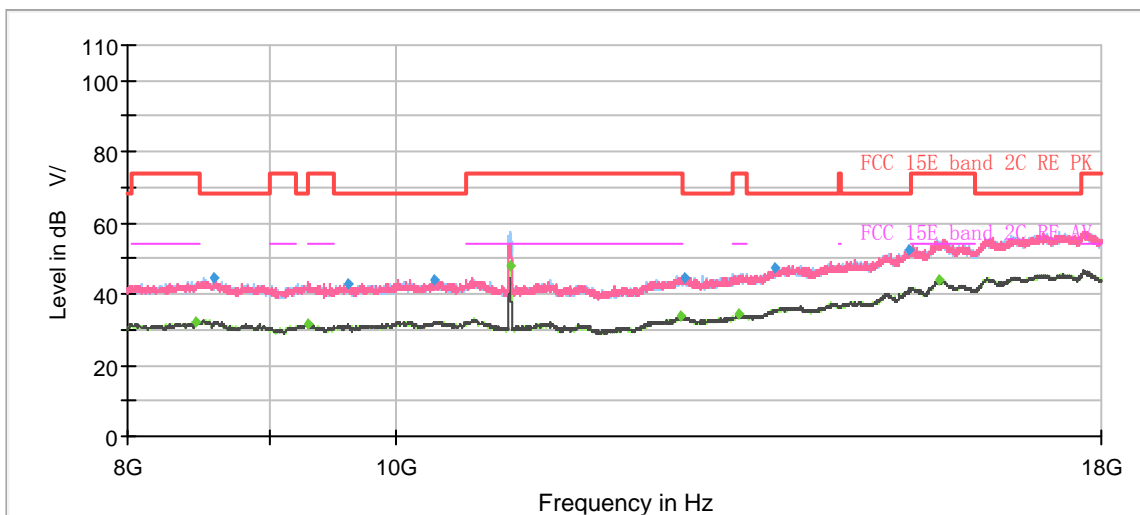

Radiates Emission from 8GHz to 18GHz



Frequency (MHz)	Peak (dBuV/m)	Average (dBuV/m)	Limit (dBuV/m)	Margin (dB)	Height (cm)	Polarization	Azimuth (deg)	Correct Factor (dB)
1199.50	---	32.44	54.00	21.56	100.0	V	297.00	-8
1275.63	41.96	---	68.20	26.24	100.0	V	191.00	-7
1702.63	---	32.13	54.00	21.87	200.0	V	30.00	-5
1945.88	43.58	---	68.20	24.62	100.0	V	0.00	-3
2687.00	46.93	---	68.20	21.27	100.0	V	204.00	1
2724.63	---	34.95	54.00	19.05	200.0	V	64.00	1
3438.63	48.86	---	68.20	19.34	200.0	V	35.00	4
3940.88	---	38.58	54.00	15.42	200.0	H	169.00	6
5045.13	---	39.63	54.00	14.37	100.0	V	263.00	9
5274.38	51.76	---	68.20	16.44	100.0	H	104.00	9
7048.00	52.63	---	68.20	15.57	100.0	V	64.00	11
7443.50	---	41.41	54.00	12.59	200.0	V	30.00	11

Remark: 1. Correction Factor = Antenna factor+ Insertion loss (cable loss + amplifier gain)



## 802.11a CH116

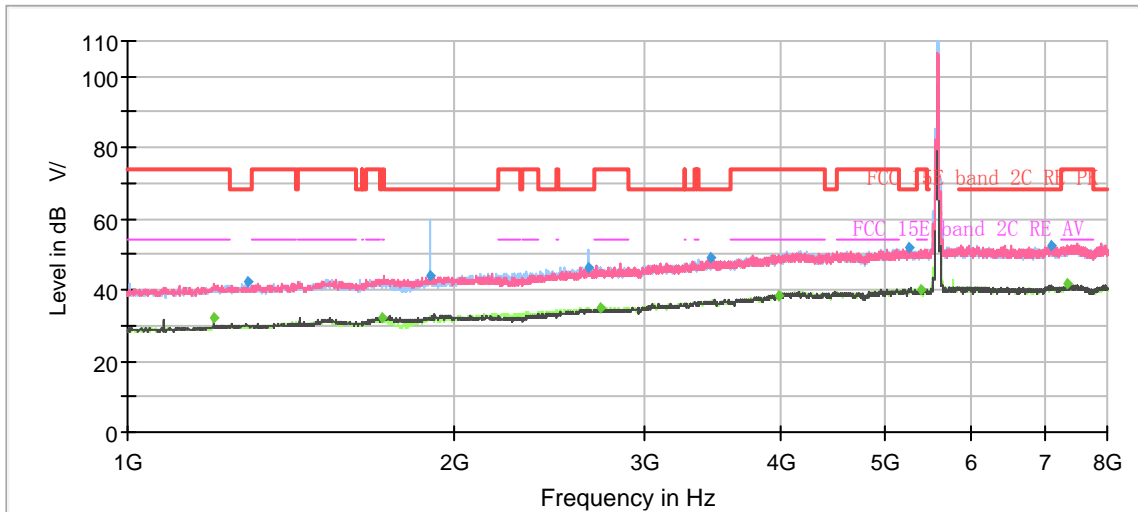

Note: The signal beyond the limit is carrier.  
Radiates Emission from 1GHz to 8GHz

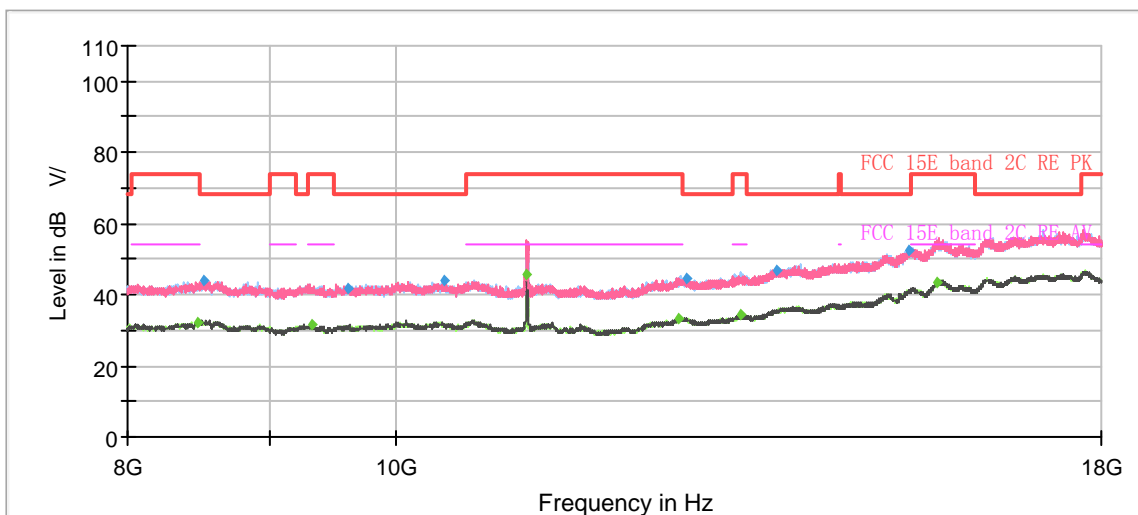

Radiates Emission from 8GHz to 18GHz



Frequency (MHz)	Peak (dBuV/m)	Average (dBuV/m)	Limit (dBuV/m)	Margin (dB)	Height (cm)	Polarization	Azimuth (deg)	Correct Factor (dB)
1199.50	---	32.16	54.00	21.84	100.0	V	295.00	-8
1293.13	42.06	---	68.20	26.14	100.0	H	35.00	-7
1719.25	---	32.11	54.00	21.89	100.0	V	329.00	-5
1898.63	43.76	---	68.20	24.44	100.0	H	359.00	-4
2662.50	46.07	---	68.20	22.13	100.0	H	191.00	0
2724.63	---	35.18	54.00	18.82	100.0	H	6.00	1
3445.63	48.81	---	68.20	19.39	100.0	H	118.00	4
3978.50	---	38.59	54.00	15.41	100.0	V	0.00	6
5248.13	51.94	---	68.20	16.26	200.0	H	309.00	9
5385.50	---	40.22	54.00	13.78	100.0	V	286.00	9
7111.00	52.57	---	68.20	15.63	100.0	H	122.00	11
7352.50	---	41.48	54.00	12.52	100.0	V	258.00	11

Remark: 1. Correction Factor = Antenna factor+ Insertion loss (cable loss + amplifier gain)

802.11a CH140

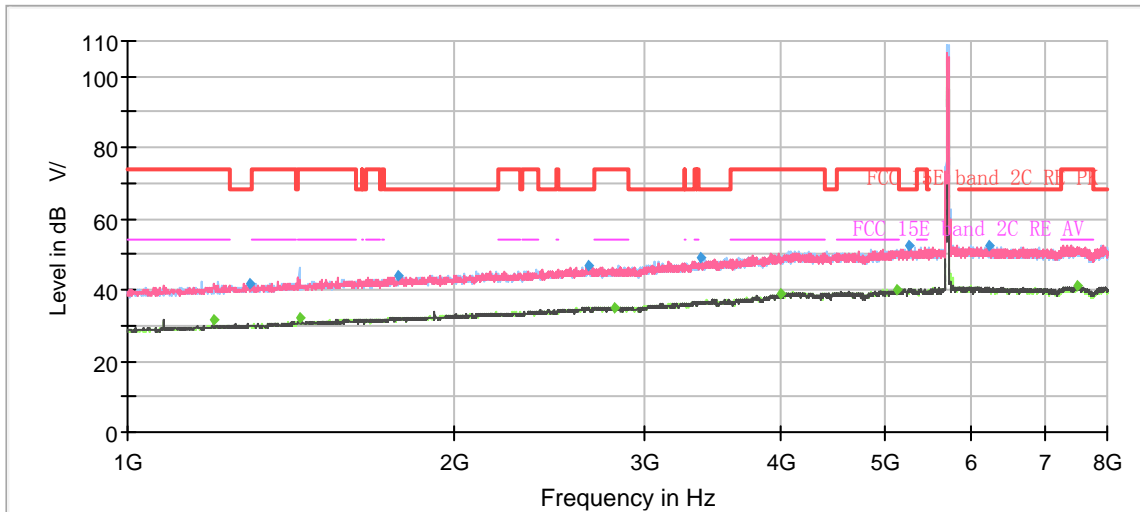

Note: The signal beyond the limit is carrier.  
Radiates Emission from 1GHz to 8GHz

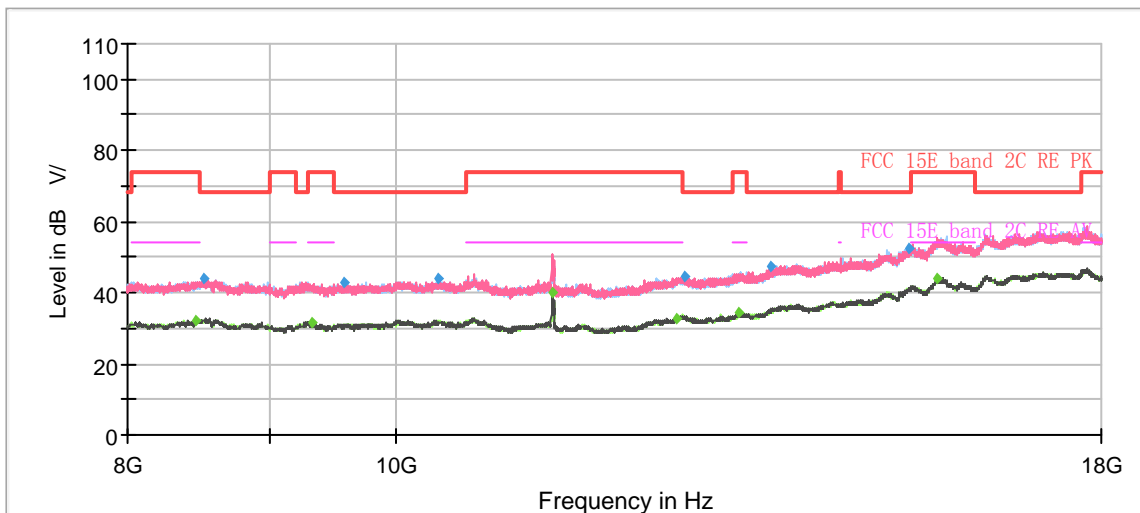

Radiates Emission from 8GHz to 18GHz



Frequency (MHz)	Peak (dBuV/m)	Average (dBuV/m)	Limit (dBuV/m)	Margin (dB)	Height (cm)	Polarization	Azimuth (deg)	Correct Factor (dB)
1199.50	---	31.86	54.00	22.14	100.0	V	296.00	-8
1295.75	41.87	---	68.20	26.33	100.0	H	62.00	-7
1440.13	---	32.36	54.00	21.64	100.0	V	330.00	-6
1775.25	44.04	---	68.20	24.16	100.0	V	354.00	-4
2664.25	46.57	---	68.20	21.63	200.0	H	314.00	0
2809.50	---	35.24	54.00	18.76	100.0	H	126.00	1
3373.00	49.22	---	68.20	18.98	100.0	H	198.00	3
3996.88	---	38.66	54.00	15.34	100.0	H	260.00	6
5121.25	---	40.22	54.00	13.78	200.0	V	138.00	9
5243.75	52.57	---	68.20	15.63	100.0	H	193.00	9
6222.00	52.48	---	68.20	15.72	100.0	H	19.00	10
7515.25	---	41.01	54.00	12.99	100.0	V	310.00	11

Remark: 1. Correction Factor = Antenna factor+ Insertion loss (cable loss + amplifier gain)



802.11a CH144

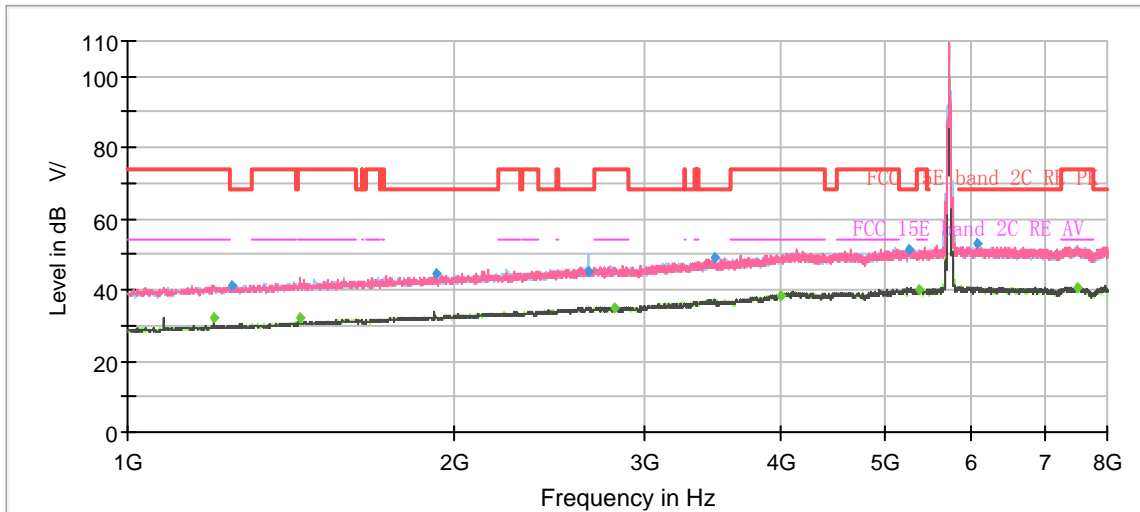

Note: The signal beyond the limit is carrier.  
Radiates Emission from 1GHz to 8GHz

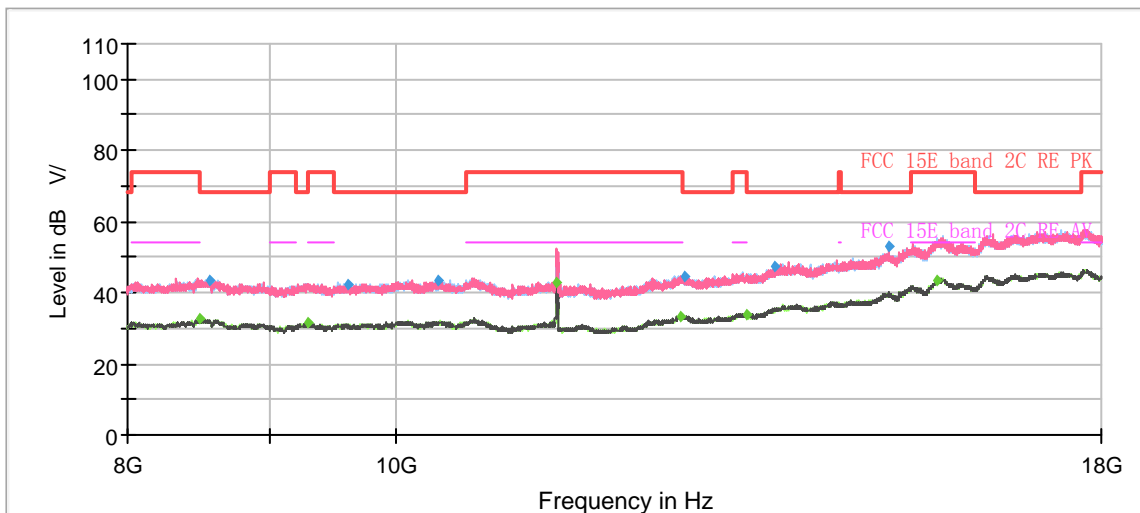

Radiates Emission from 8GHz to 18GHz



Frequency (MHz)	Peak (dBuV/m)	Average (dBuV/m)	Limit (dBuV/m)	Margin (dB)	Height (cm)	Polarization	Azimuth (deg)	Correct Factor (dB)
1199.50	---	32.17	54.00	21.83	100.0	V	299.00	-8
1248.50	41.28	---	68.20	26.92	200.0	H	218.00	-7
1440.13	---	32.15	54.00	21.85	100.0	V	290.00	-6
1925.75	44.58	---	68.20	23.62	200.0	V	14.00	-3
2659.00	45.35	---	68.20	22.85	100.0	H	295.00	0
2813.88	---	35.06	54.00	18.94	200.0	V	58.00	1
3471.88	49.00	---	68.20	19.20	200.0	H	345.00	4
3991.63	---	38.48	54.00	15.52	200.0	V	151.00	6
5244.63	51.30	---	68.20	16.90	100.0	H	172.00	9
5365.38	---	39.97	54.00	14.03	100.0	V	280.00	9
6070.63	52.89	---	68.20	15.31	200.0	V	44.00	10
7495.13	---	40.83	54.00	13.17	200.0	V	34.00	11

Remark: 1. Correction Factor = Antenna factor+ Insertion loss (cable loss + amplifier gain)

## 802.11a CH149

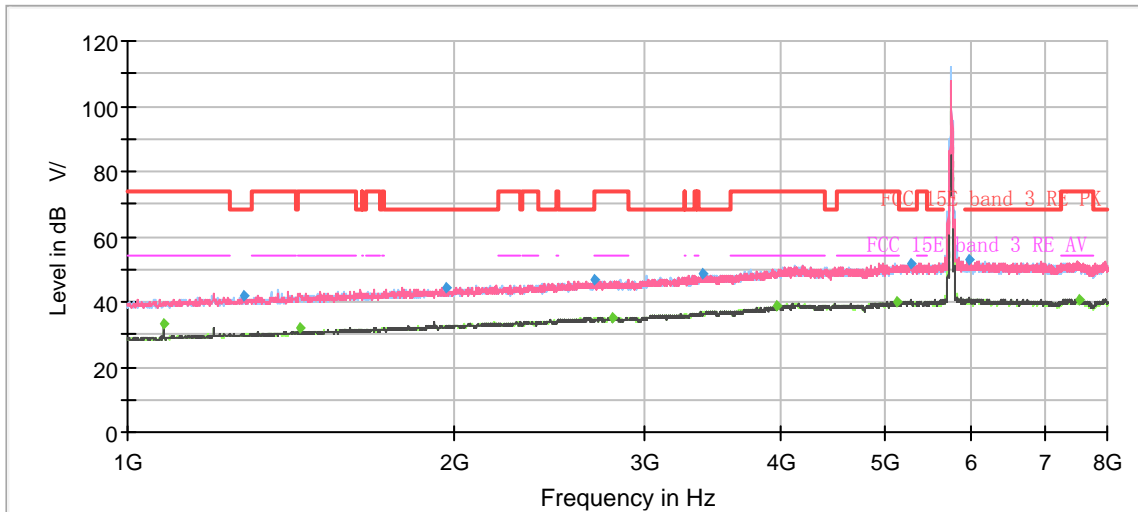

Note: The signal beyond the limit is carrier.  
Radiates Emission from 1GHz to 8GHz

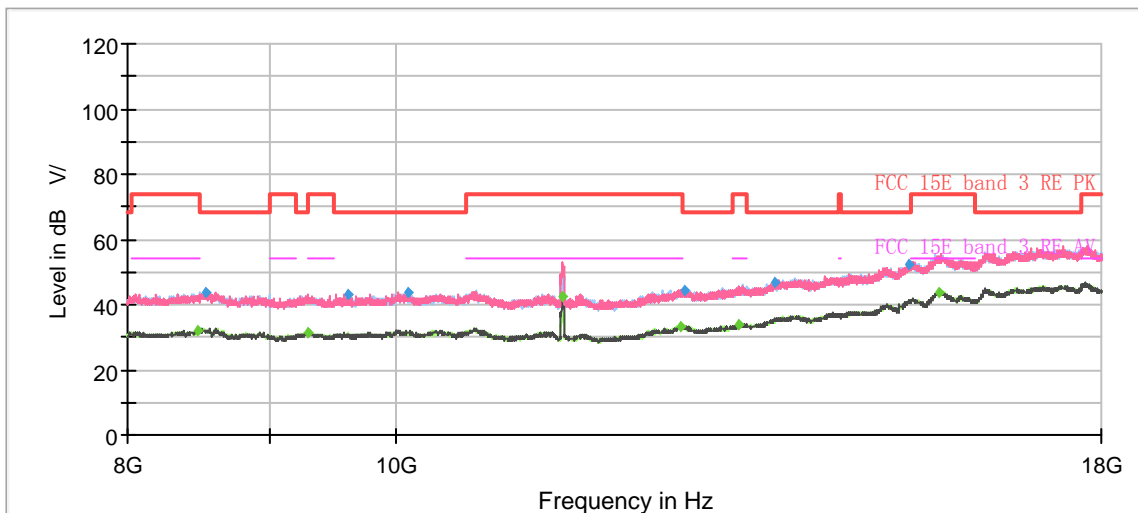

Radiates Emission from 8GHz to 18GHz





Frequency (MHz)	Peak (dBuV/m)	Average (dBuV/m)	Limit (dBuV/m)	Margin (dB)	Height (cm)	Polarization	Azimuth (deg)	Correct Factor (dB)
1079.63	---	32.96	54.00	21.04	200.0	V	70.00	-8
1281.75	41.63	---	68.20	26.57	200.0	V	203.00	-7
1440.13	---	32.06	54.00	21.94	100.0	V	292.00	-6
1966.00	44.35	---	68.20	23.85	100.0	H	107.00	-3
2688.75	46.80	---	68.20	21.40	200.0	V	61.00	1
2799.00	---	35.10	54.00	18.90	200.0	V	155.00	1
3387.00	48.49	---	68.20	19.71	100.0	H	190.00	3
3971.50	---	38.75	54.00	15.25	100.0	H	70.00	6
5111.63	---	40.18	54.00	13.82	200.0	V	165.00	9
5275.25	51.97	---	68.20	16.23	100.0	V	311.00	9
5953.38	52.70	---	68.20	15.50	200.0	V	174.00	10
7536.25	---	40.71	54.00	13.29	100.0	V	85.00	11

Remark: 1. Correction Factor = Antenna factor+ Insertion loss (cable loss + amplifier gain)

## 802.11a CH157

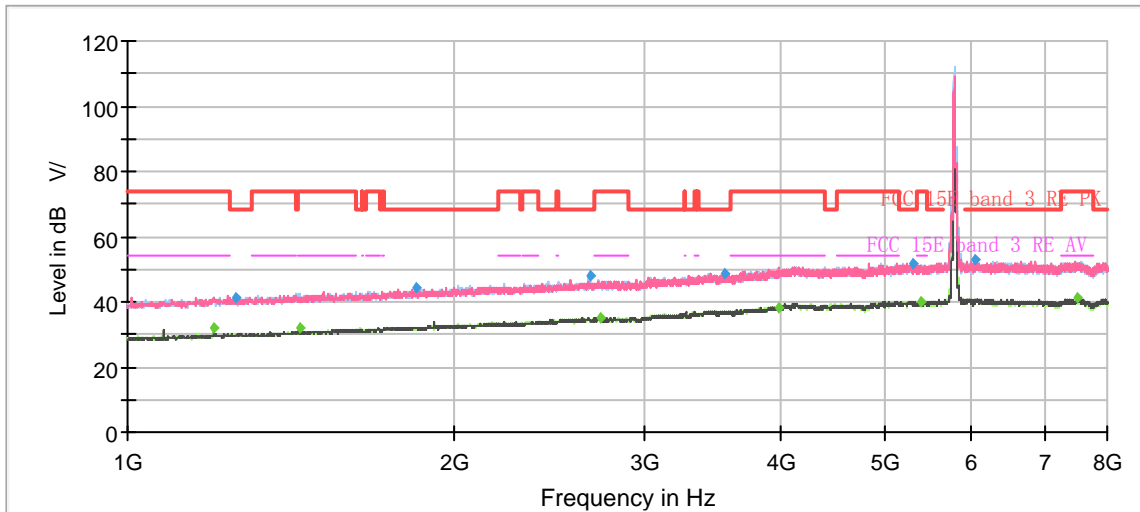

Note: The signal beyond the limit is carrier.  
Radiates Emission from 1GHz to 8GHz

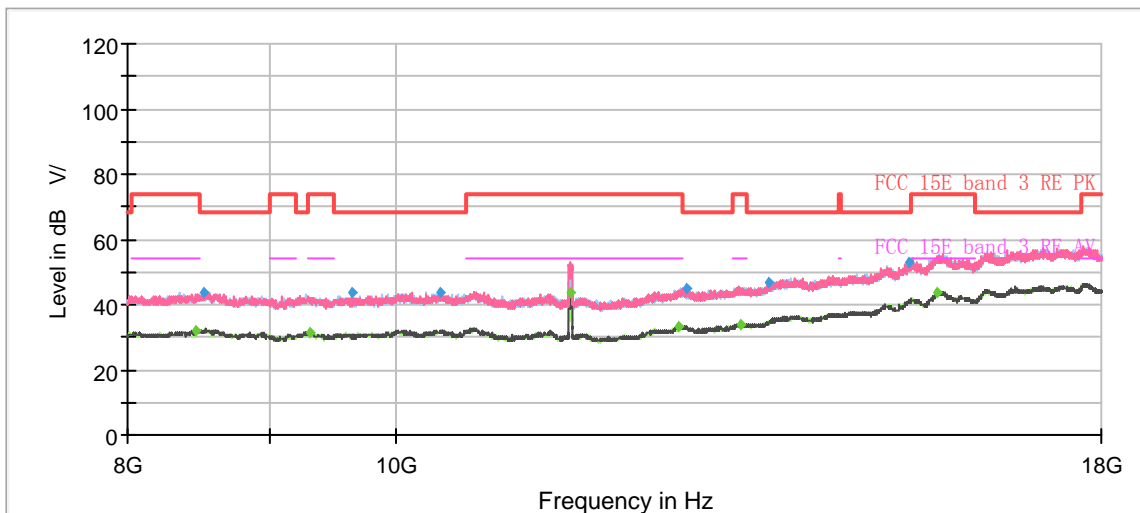

Radiates Emission from 8GHz to 18GHz



Frequency (MHz)	Peak (dBuV/m)	Average (dBuV/m)	Limit (dBuV/m)	Margin (dB)	Height (cm)	Polarization	Azimuth (deg)	Correct Factor (dB)
1199.50	---	32.12	54.00	21.89	100.0	H	38.00	-8
1255.50	41.39	---	68.20	26.81	100.0	V	198.00	-7
1440.13	---	31.99	54.00	22.01	200.0	H	344.00	-6
1842.63	44.24	---	68.20	23.96	100.0	V	91.00	-4
2672.13	47.74	---	68.20	20.46	200.0	H	200.00	0
2726.38	---	35.07	54.00	18.93	100.0	V	213.00	1
3549.75	48.89	---	68.20	19.31	100.0	H	245.00	4
3987.25	---	38.40	54.00	15.60	200.0	V	73.00	6
5302.38	51.86	---	68.20	16.34	200.0	V	0.00	9
5382.88	---	40.11	54.00	13.89	100.0	V	332.00	9
6033.88	52.69	---	68.20	15.51	200.0	V	64.00	10
7498.63	---	41.23	54.00	12.77	200.0	V	291.00	11

Remark: 1. Correction Factor = Antenna factor+ Insertion loss (cable loss + amplifier gain)



802.11a CH165

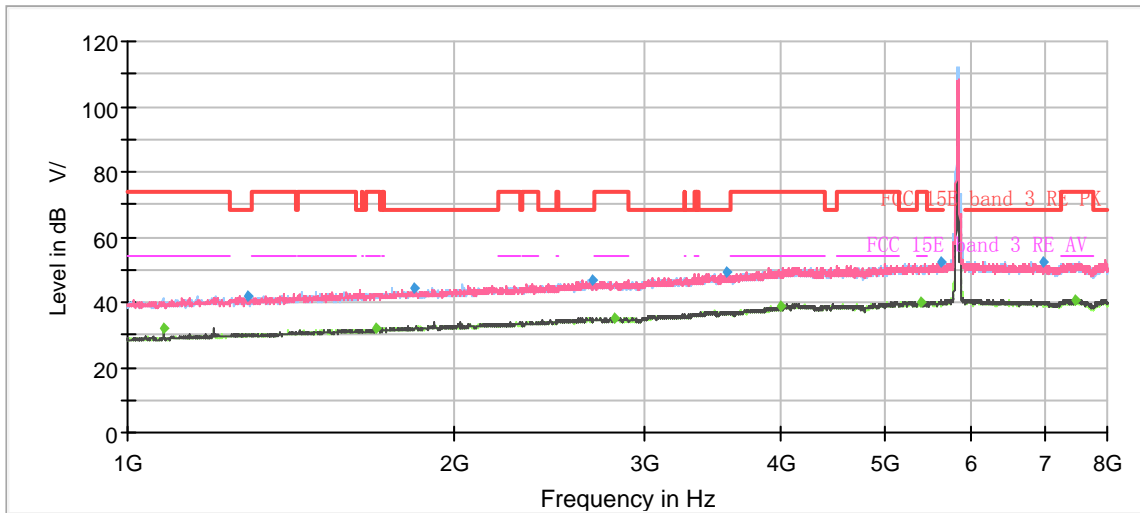

Note: The signal beyond the limit is carrier.  
Radiates Emission from 1GHz to 8GHz

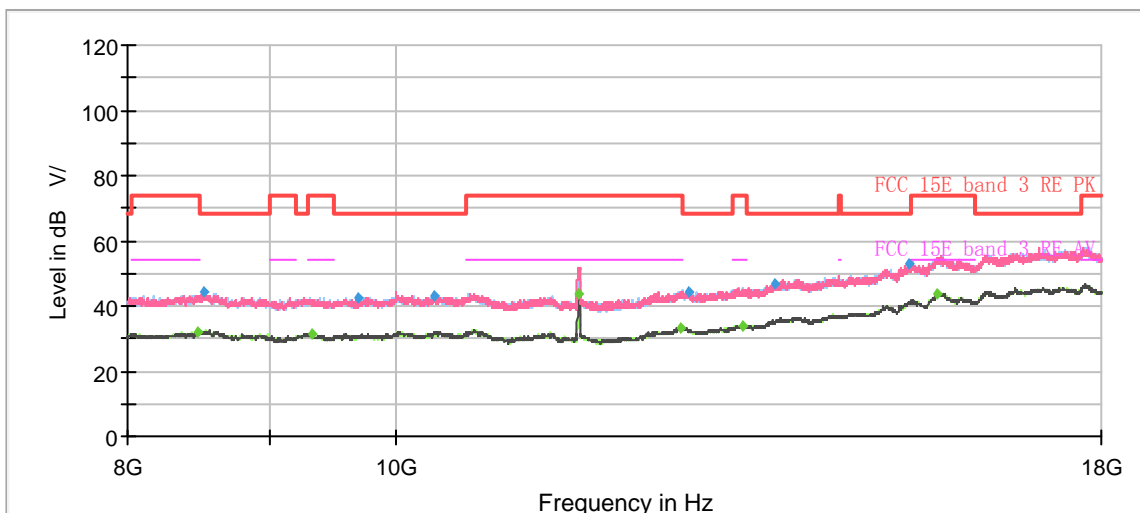

Radiates Emission from 8GHz to 18GHz



Frequency (MHz)	Peak (dBuV/m)	Average (dBuV/m)	Limit (dBuV/m)	Margin (dB)	Height (cm)	Polarization	Azimuth (deg)	Correct Factor (dB)
1079.63	---	32.17	54.00	21.83	200.0	V	335.00	-8
1291.38	41.72	---	68.20	26.48	100.0	H	256.00	-7
1693.00	---	31.76	54.00	22.24	100.0	H	168.00	-5
1836.50	44.35	---	68.20	23.85	100.0	H	275.00	-4
2685.25	46.89	---	68.20	21.31	200.0	H	256.00	0
2813.00	---	35.03	54.00	18.97	200.0	H	271.00	1
3572.50	49.54	---	68.20	18.66	200.0	V	110.00	4
3996.88	---	38.72	54.00	15.28	200.0	V	4.00	6
5389.88	---	40.10	54.00	13.90	100.0	H	101.00	9
5609.50	52.18	---	68.20	16.02	100.0	H	48.00	10
6983.25	52.32	---	68.20	15.88	200.0	H	261.00	11
7487.25	---	40.87	54.00	13.13	200.0	V	316.00	11

Remark: 1. Correction Factor = Antenna factor+ Insertion loss (cable loss + amplifier gain)

802.11n (HT20) CH36

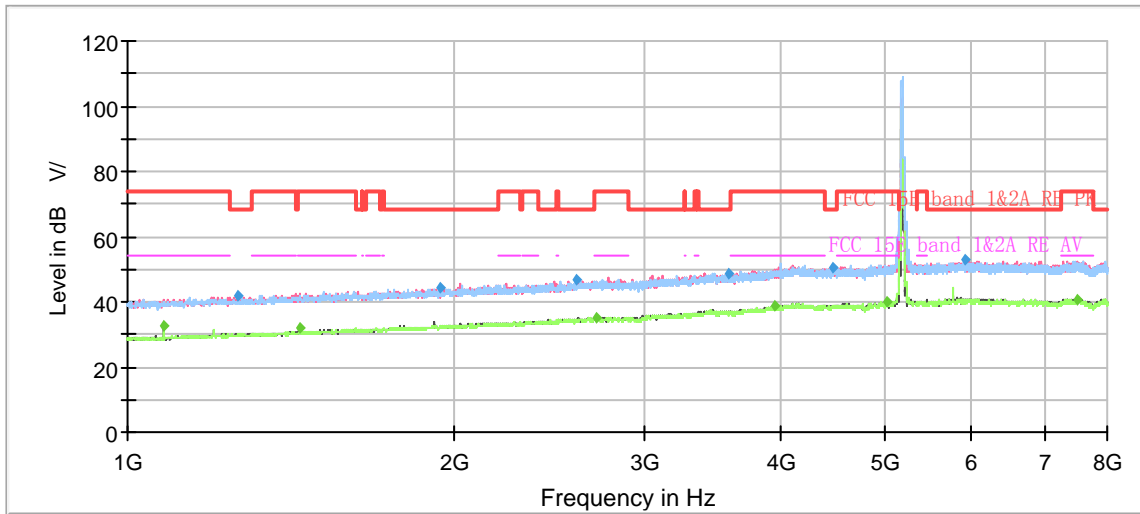

Note: The signal beyond the limit is carrier.  
Radiates Emission from 1GHz to 8GHz

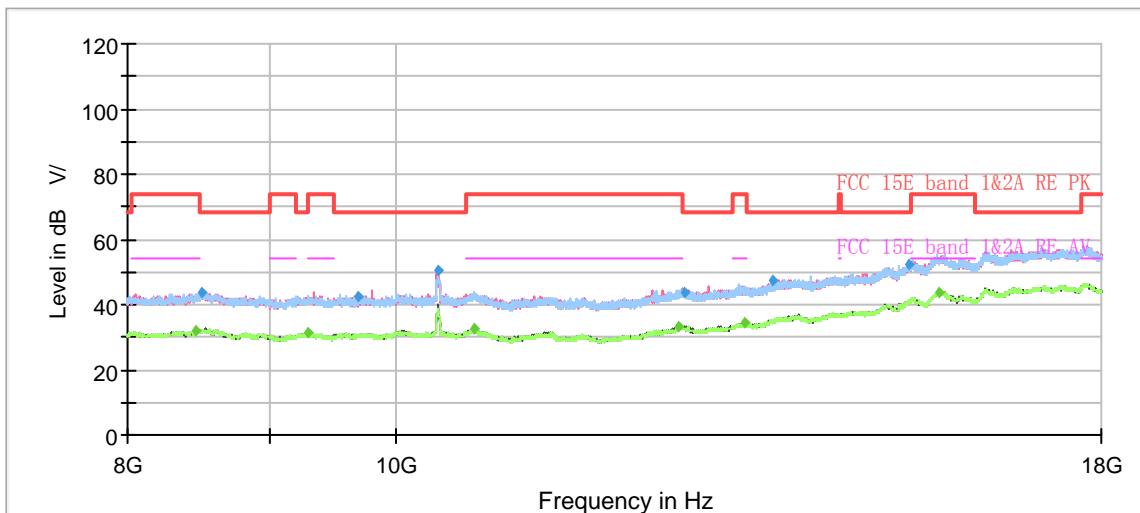

Radiates Emission from 8GHz to 18GHz



Frequency (MHz)	Peak (dBuV/m)	Average (dBuV/m)	Limit (dBuV/m)	Margin (dB)	Height (cm)	Polarization	Azimuth (deg)	Correct Factor (dB)
1079.63	---	32.50	54.00	21.50	200.0	V	269.00	-8
1265.13	41.78	---	68.20	26.42	100.0	V	189.00	-7
1440.13	---	32.23	54.00	21.77	200.0	V	310.00	-6
1941.50	44.11	---	68.20	24.09	100.0	V	135.00	-3
2587.25	46.57	---	68.20	21.63	100.0	H	43.00	0
2708.00	---	35.07	54.00	18.93	100.0	V	8.00	1
3588.25	48.87	---	68.20	19.33	100.0	H	100.00	4
3946.13	---	38.61	54.00	15.39	100.0	V	203.00	6
4470.25	50.66	---	68.20	17.54	200.0	V	9.00	7
5019.75	---	39.88	54.00	14.12	200.0	V	310.00	9
5927.13	52.68	---	68.20	15.52	200.0	V	73.00	10
7506.50	---	40.75	54.00	13.25	100.0	V	0.00	11

Remark: 1. Correction Factor = Antenna factor+ Insertion loss (cable loss + amplifier gain)





### 802.11n (HT20) CH40

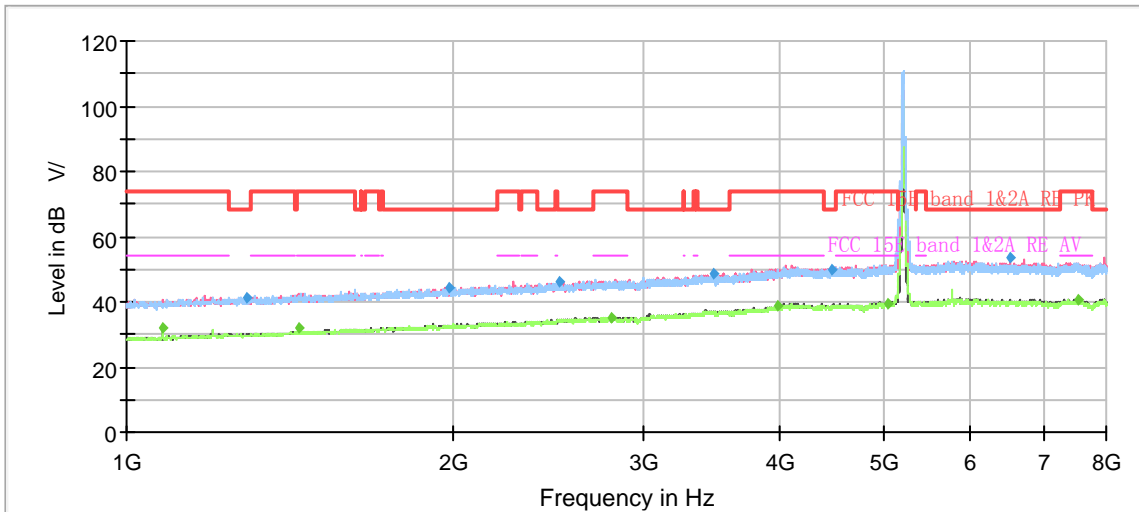

Note: The signal beyond the limit is carrier.  
Radiates Emission from 1GHz to 8GHz

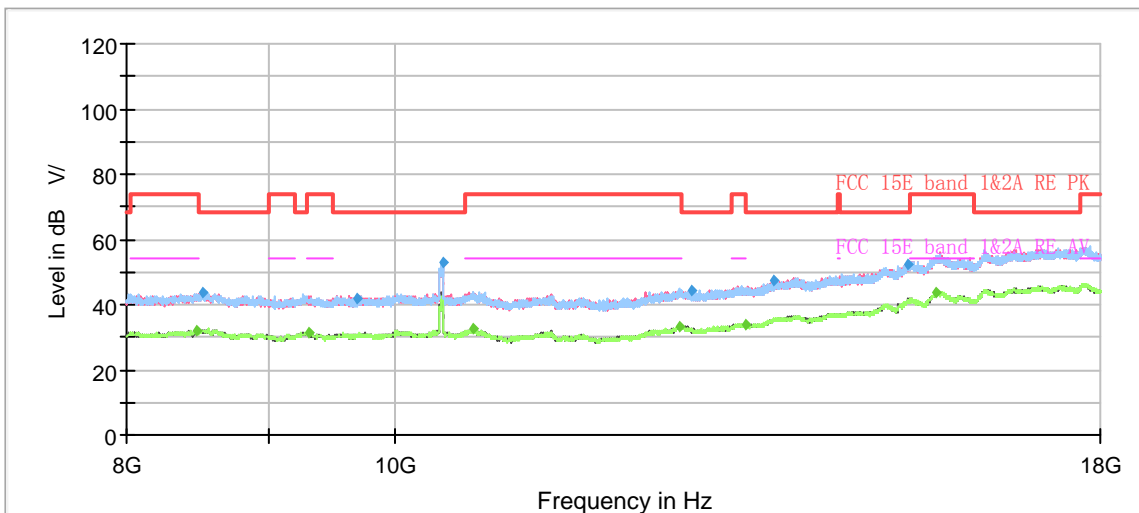

Radiates Emission from 8GHz to 18GHz



Frequency (MHz)	Peak (dBuV/m)	Average (dBuV/m)	Limit (dBuV/m)	Margin (dB)	Height (cm)	Polarization	Azimuth (deg)	Correct Factor (dB)
1079.63	---	31.83	54.00	22.17	200.0	V	263.00	-8
1292.25	41.48	---	68.20	26.72	200.0	V	329.00	-7
1440.13	---	32.23	54.00	21.77	100.0	V	115.00	-6
1981.75	44.15	---	68.20	24.05	100.0	H	159.00	-3
2505.88	46.41	---	68.20	21.79	100.0	V	125.00	0
2803.38	---	35.04	54.00	18.96	100.0	V	0.00	1
3478.88	48.38	---	68.20	19.82	100.0	V	29.00	4
3982.88	---	38.67	54.00	15.33	100.0	H	252.00	6
4470.25	50.00	---	68.20	18.20	200.0	V	161.00	7
5030.25	---	39.59	54.00	14.41	200.0	V	89.00	9
6514.25	53.68	---	68.20	14.52	200.0	V	132.00	10
7537.13	---	40.69	54.00	13.31	200.0	V	118.00	11

Remark: 1. Correction Factor = Antenna factor+ Insertion loss (cable loss + amplifier gain)



### 802.11n (HT20) CH48

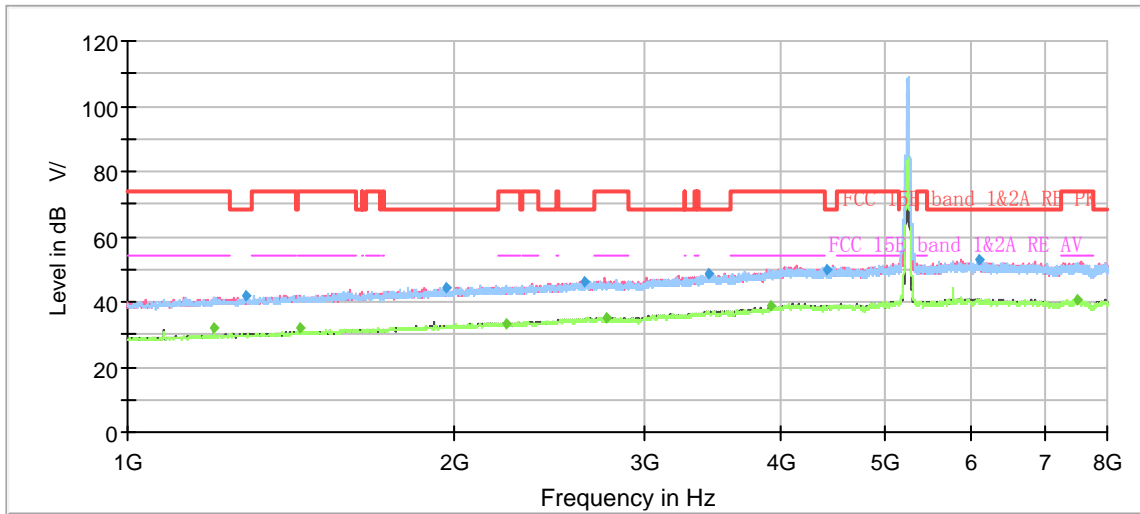

Note: The signal beyond the limit is carrier.  
Radiates Emission from 1GHz to 8GHz

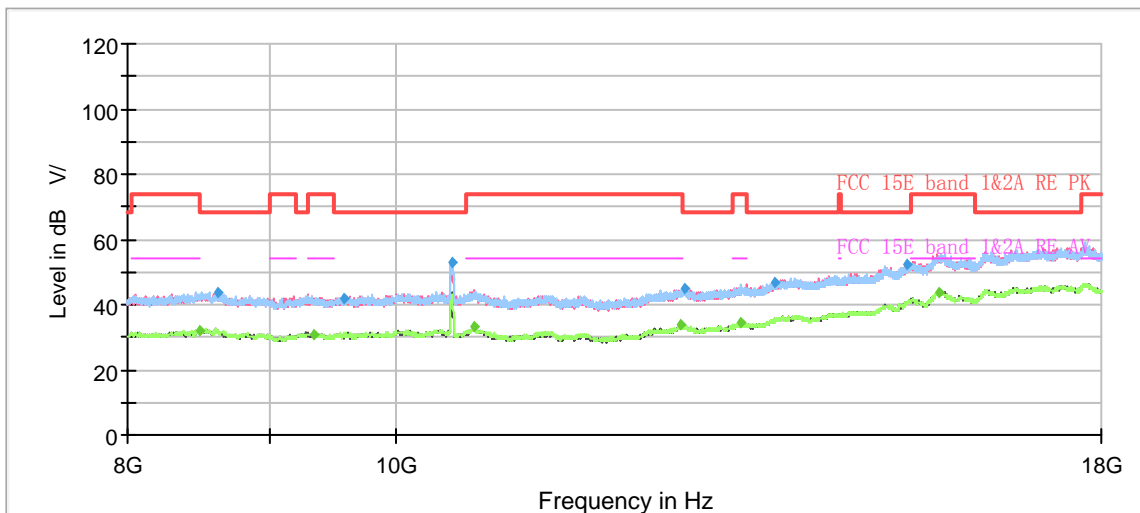

Radiates Emission from 8GHz to 18GHz



Frequency (MHz)	Peak (dBuV/m)	Average (dBuV/m)	Limit (dBuV/m)	Margin (dB)	Height (cm)	Polarization	Azimuth (deg)	Correct Factor (dB)
1199.50	---	32.02	54.00	21.98	200.0	V	33.00	-8
1283.50	41.94	---	68.20	26.26	100.0	H	237.00	-7
1440.13	---	32.04	54.00	21.96	100.0	V	242.00	-6
1967.75	44.22	---	68.20	23.98	100.0	H	194.00	-3
2232.88	---	33.09	54.00	20.91	100.0	V	106.00	-2
2638.88	46.33	---	68.20	21.87	100.0	V	0.00	0
2768.38	---	35.16	54.00	18.84	100.0	V	0.00	1
3431.63	48.50	---	68.20	19.70	100.0	V	97.00	4
3923.38	---	38.53	54.00	15.47	100.0	H	204.00	6
4420.38	50.14	---	68.20	18.06	100.0	V	0.00	7
6097.75	52.67	---	68.20	15.53	100.0	V	120.00	10
7494.25	---	40.60	54.00	13.40	100.0	V	76.00	11

Remark: 1. Correction Factor = Antenna factor+ Insertion loss (cable loss + amplifier gain)



### 802.11n (HT20) CH52

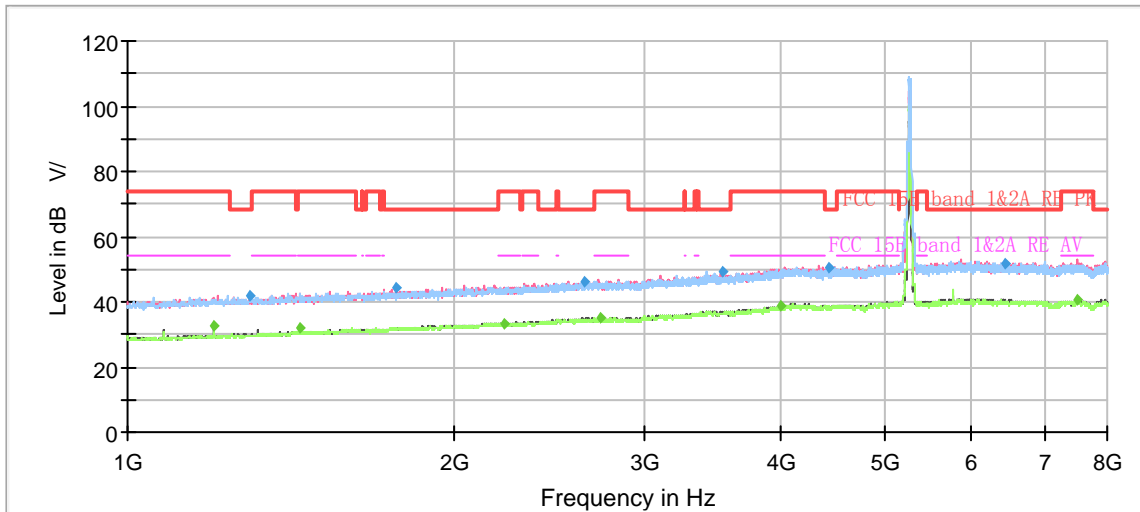

Note: The signal beyond the limit is carrier.  
Radiates Emission from 1GHz to 8GHz

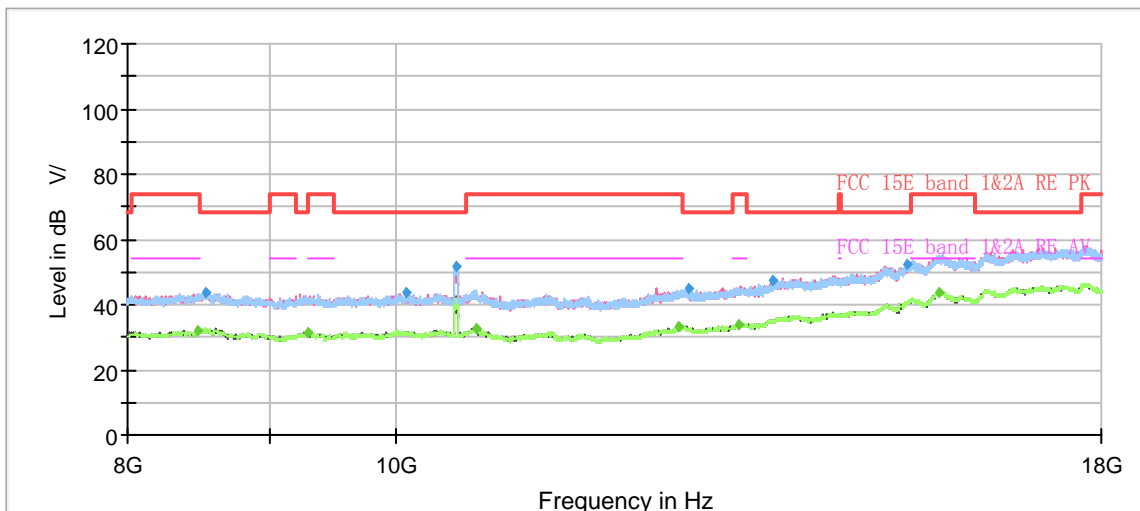

Radiates Emission from 8GHz to 18GHz



Frequency (MHz)	Peak (dBuV/m)	Average (dBuV/m)	Limit (dBuV/m)	Margin (dB)	Height (cm)	Polarization	Azimuth (deg)	Correct Factor (dB)
1199.50	---	32.47	54.00	21.53	200.0	V	290.00	-8
1296.63	41.94	---	68.20	26.26	200.0	V	344.00	-7
1440.13	---	31.95	54.00	22.05	100.0	H	148.00	-6
1770.88	44.29	---	68.20	23.91	100.0	V	88.00	-4
2222.38	---	33.35	54.00	20.65	200.0	V	38.00	-2
2633.63	46.29	---	68.20	21.91	200.0	H	243.00	0
2727.25	---	35.15	54.00	18.85	100.0	H	163.00	1
3541.88	49.21	---	68.20	18.99	200.0	V	208.00	4
3991.63	---	38.52	54.00	15.48	100.0	H	177.00	6
4427.38	50.24	---	68.20	17.96	100.0	H	186.00	7
6453.88	51.75	---	68.20	16.45	100.0	V	232.00	10
7491.63	---	40.41	54.00	13.59	100.0	V	232.00	11

Remark: 1. Correction Factor = Antenna factor+ Insertion loss (cable loss + amplifier gain)

## 802.11n (HT20) CH60

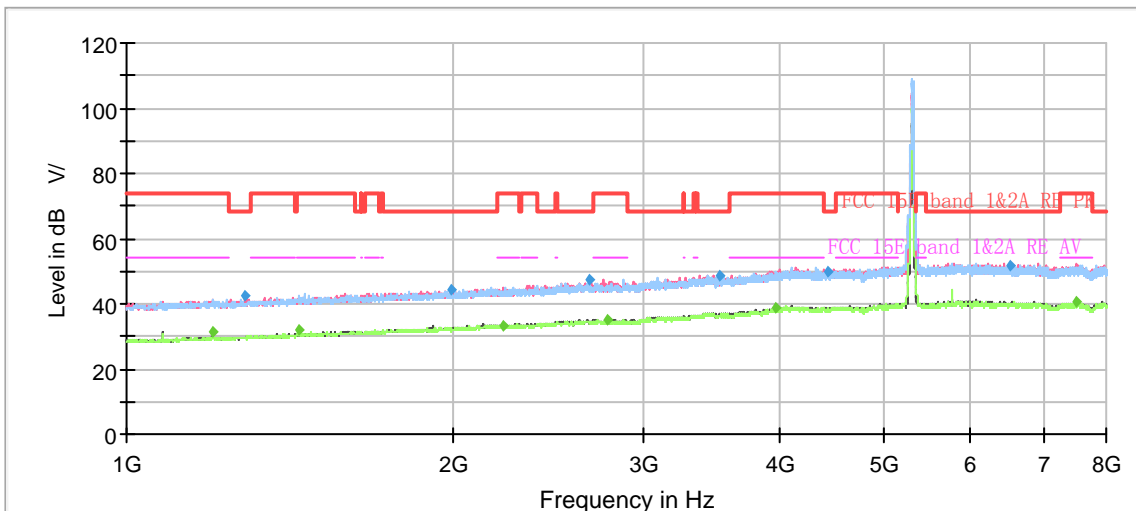

Note: The signal beyond the limit is carrier.  
Radiates Emission from 1GHz to 8GHz

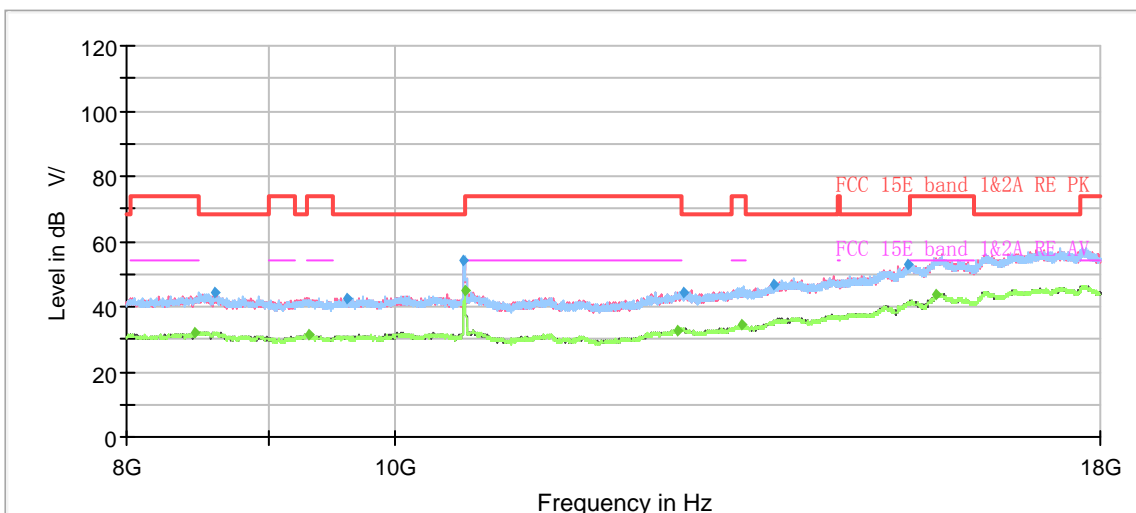

Radiates Emission from 8GHz to 18GHz





Frequency (MHz)	Peak (dBuV/m)	Average (dBuV/m)	Limit (dBuV/m)	Margin (dB)	Height (cm)	Polarization	Azimuth (deg)	Correct Factor (dB)
1199.50	---	31.64	54.00	22.36	200.0	V	28.00	-8
1283.50	42.34	---	68.20	25.86	200.0	V	0.00	-7
1440.13	---	32.14	54.00	21.86	200.0	H	142.00	-6
1995.75	44.11	---	68.20	24.09	100.0	V	252.00	-3
2221.50	---	33.21	54.00	20.79	200.0	V	312.00	-2
2668.63	47.16	---	68.20	21.04	200.0	V	101.00	0
2780.63	---	34.93	54.00	19.07	200.0	V	297.00	1
3523.50	48.89	---	68.20	19.31	100.0	H	296.00	4
3968.88	---	38.52	54.00	15.48	100.0	V	136.00	6
4430.88	49.62	---	68.20	18.58	100.0	V	194.00	7
6512.50	51.83	---	68.20	16.37	100.0	H	9.00	10
7503.00	---	40.68	54.00	13.32	200.0	V	106.00	11

Remark: 1. Correction Factor = Antenna factor+ Insertion loss (cable loss + amplifier gain)

## 802.11n (HT20) CH64

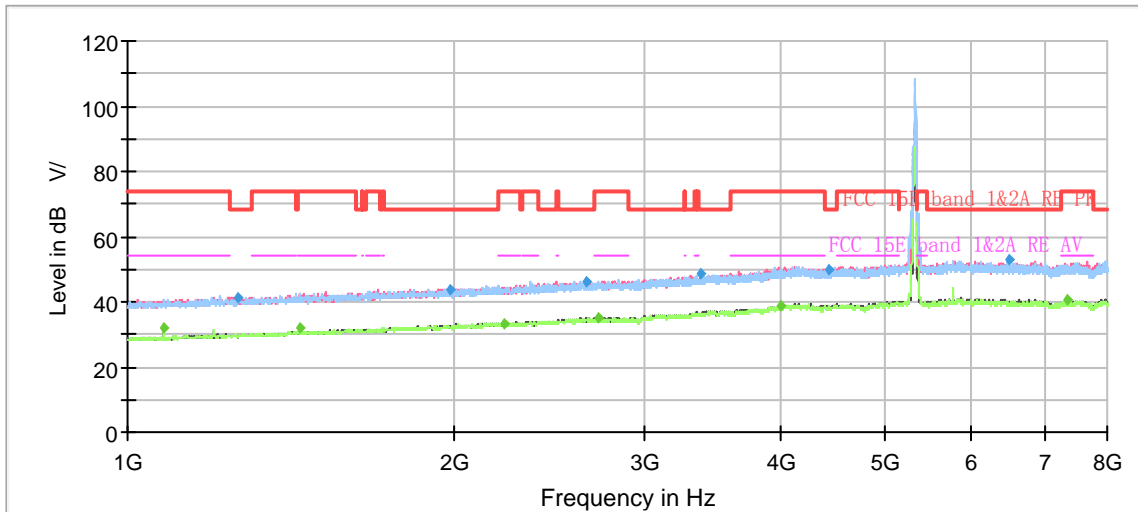

Note: The signal beyond the limit is carrier.  
Radiates Emission from 1GHz to 8GHz

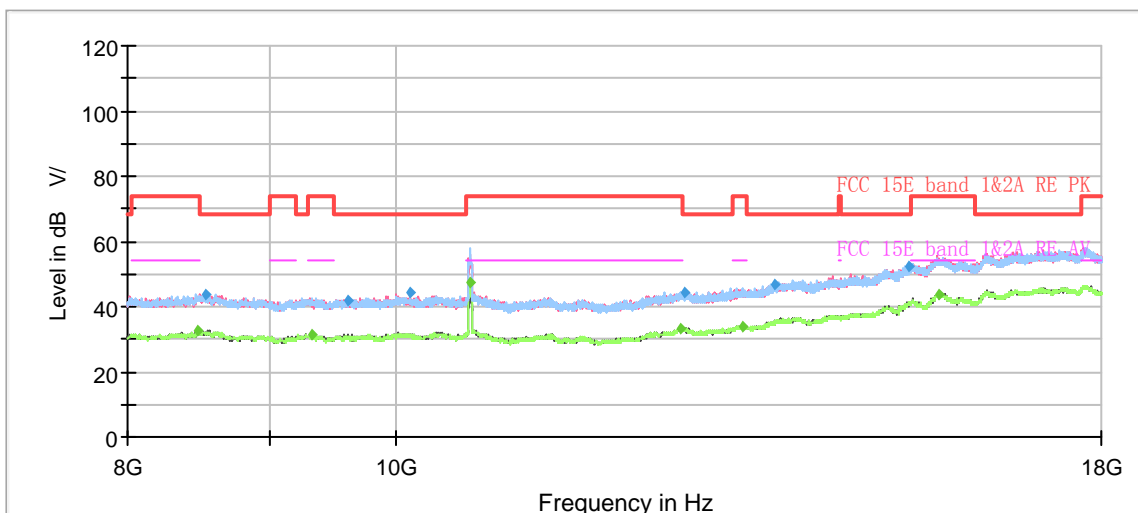

Radiates Emission from 8GHz to 18GHz



Frequency (MHz)	Peak (dBuV/m)	Average (dBuV/m)	Limit (dBuV/m)	Margin (dB)	Height (cm)	Polarization	Azimuth (deg)	Correct Factor (dB)
1079.63	---	32.01	54.00	21.99	100.0	V	94.00	-8
1264.25	41.37	---	68.20	26.83	200.0	H	128.00	-7
1440.13	---	32.29	54.00	21.71	100.0	H	142.00	-6
1980.88	43.88	---	68.20	24.32	100.0	H	191.00	-3
2221.50	---	33.07	54.00	20.93	200.0	V	122.00	-2
2649.38	46.32	---	68.20	21.88	100.0	V	86.00	0
2715.88	---	35.13	54.00	18.87	200.0	V	171.00	1
3380.88	48.47	---	68.20	19.73	200.0	V	253.00	3
3991.63	---	38.69	54.00	15.31	100.0	V	195.00	6
4425.63	49.59	---	68.20	18.61	200.0	V	330.00	7
6499.38	52.70	---	68.20	15.50	100.0	H	191.00	10
7358.63	---	40.36	54.00	13.64	100.0	H	323.00	11

Remark: 1. Correction Factor = Antenna factor+ Insertion loss (cable loss + amplifier gain)

802.11n (HT20) CH100

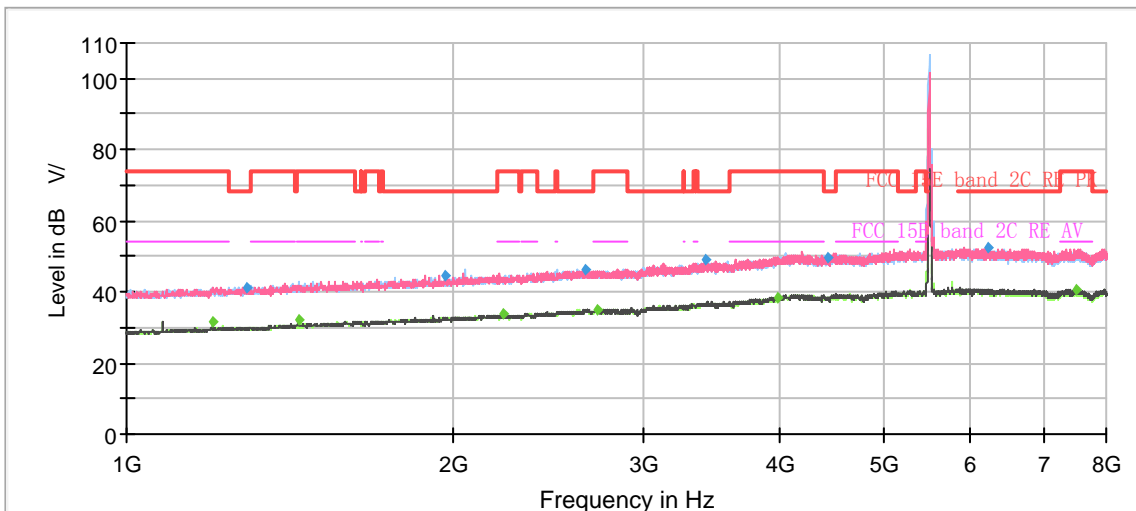

Note: The signal beyond the limit is carrier.  
Radiates Emission from 1GHz to 8GHz

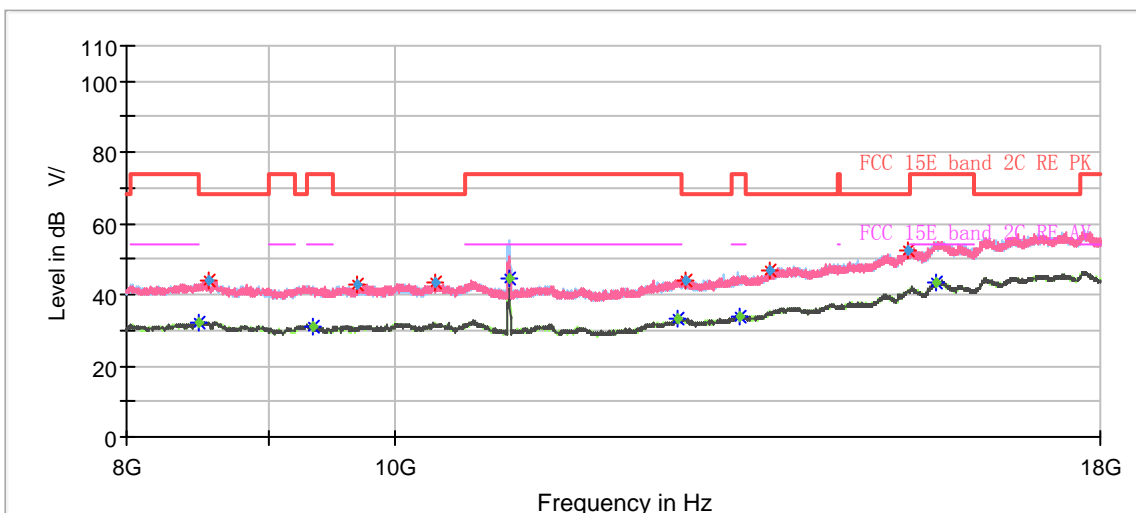

Radiates Emission from 8GHz to 18GHz



Frequency (MHz)	Peak (dBuV/m)	Average (dBuV/m)	Limit (dBuV/m)	Margin (dB)	Height (cm)	Polarization	Azimuth (deg)	Correct Factor (dB)
1199.50	---	31.81	54.00	22.19	200.0	V	34.00	-8
1291.38	41.44	---	68.20	26.76	100.0	H	183.00	-7
1440.13	---	32.33	54.00	21.67	100.0	V	130.00	-6
1966.88	44.75	---	68.20	23.45	200.0	V	120.00	-3
2222.38	---	33.64	54.00	20.36	100.0	V	334.00	-2
2646.75	46.20	---	68.20	22.00	100.0	V	46.00	0
2721.13	---	35.06	54.00	18.94	100.0	V	70.00	1
3410.63	48.82	---	68.20	19.38	200.0	V	95.00	4
3976.75	---	38.59	54.00	15.41	200.0	H	103.00	6
4437.88	49.75	---	68.20	18.45	200.0	V	271.00	7
6221.13	52.23	---	68.20	15.97	200.0	V	214.00	10
7494.25	---	40.69	54.00	13.31	100.0	V	338.00	11

Remark: 1. Correction Factor = Antenna factor+ Insertion loss (cable loss + amplifier gain)

802.11n (HT20) CH116

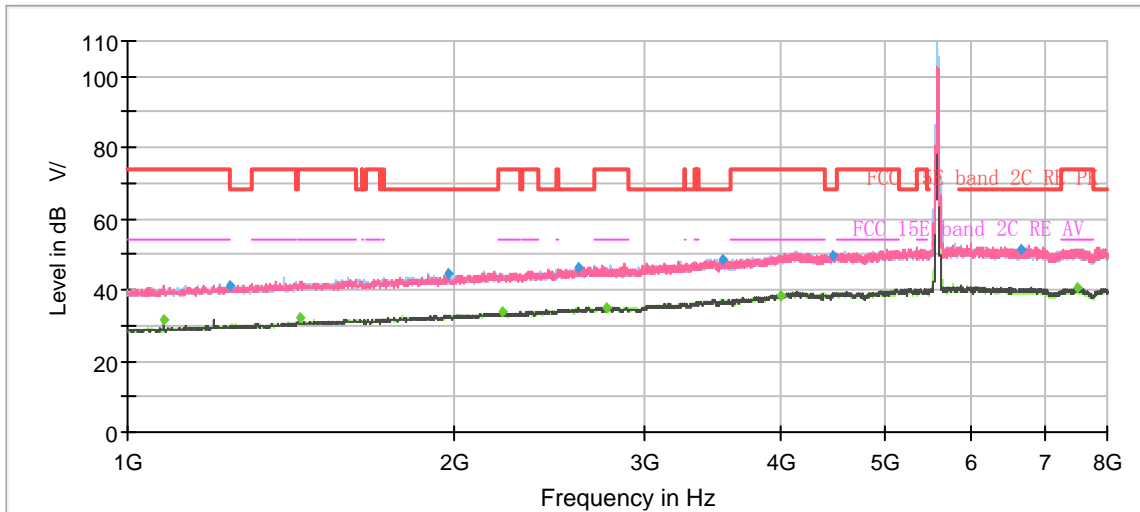

Note: The signal beyond the limit is carrier.  
Radiates Emission from 1GHz to 8GHz

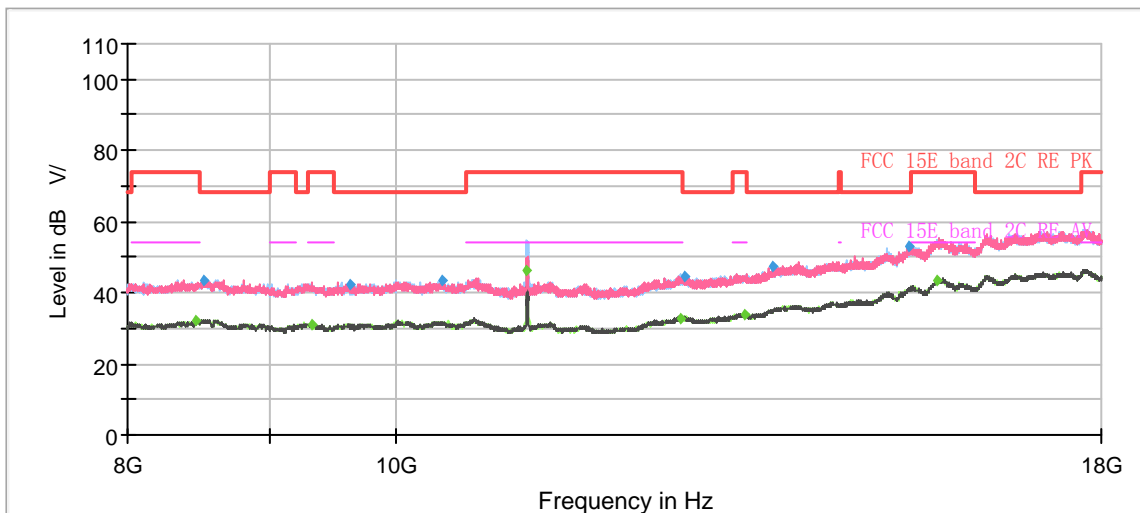

Radiates Emission from 8GHz to 18GHz



Frequency (MHz)	Peak (dBuV/m)	Average (dBuV/m)	Limit (dBuV/m)	Margin (dB)	Height (cm)	Polarization	Azimuth (deg)	Correct Factor (dB)
1079.63	---	31.65	54.00	22.35	100.0	V	21.00	-8
1243.25	41.15	---	68.20	27.05	200.0	H	74.00	-7
1440.13	---	31.95	54.00	22.05	100.0	V	130.00	-6
1977.38	44.44	---	68.20	23.76	100.0	H	92.00	-3
2211.88	---	33.68	54.00	20.32	200.0	V	107.00	-2
2598.63	46.18	---	68.20	22.02	100.0	H	235.00	0
2757.88	---	35.07	54.00	18.93	100.0	V	311.00	1
3529.63	48.46	---	68.20	19.74	200.0	H	64.00	4
3994.25	---	38.46	54.00	15.54	200.0	H	131.00	6
4458.88	49.84	---	68.20	18.36	100.0	H	291.00	7
6658.63	51.38	---	68.20	16.82	100.0	V	64.00	10
7495.13	---	40.52	54.00	13.48	200.0	V	204.00	11

Remark: 1. Correction Factor = Antenna factor+ Insertion loss (cable loss + amplifier gain)

## 802.11n (HT20) CH140

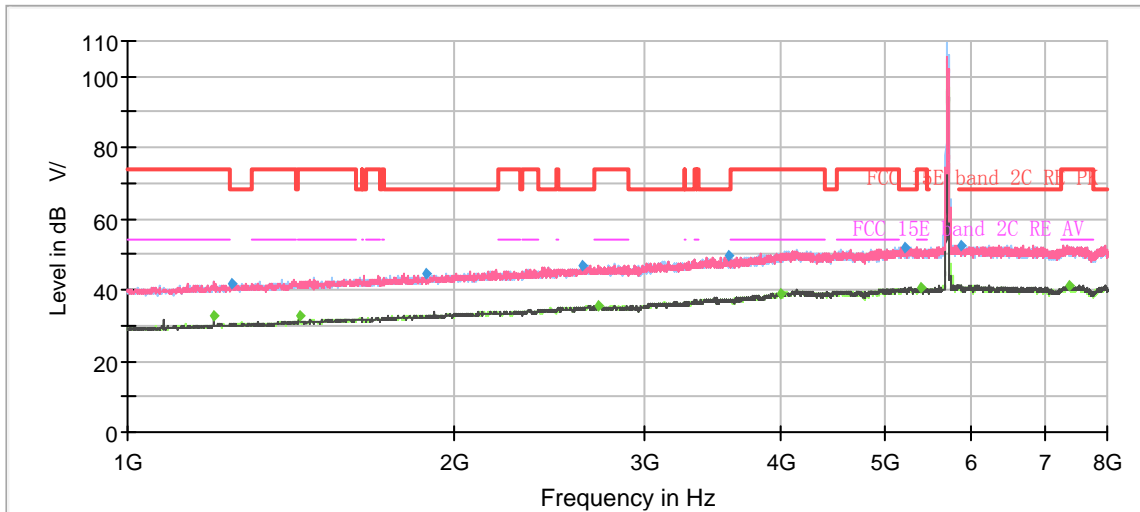

Note: The signal beyond the limit is carrier.  
Radiates Emission from 1GHz to 8GHz

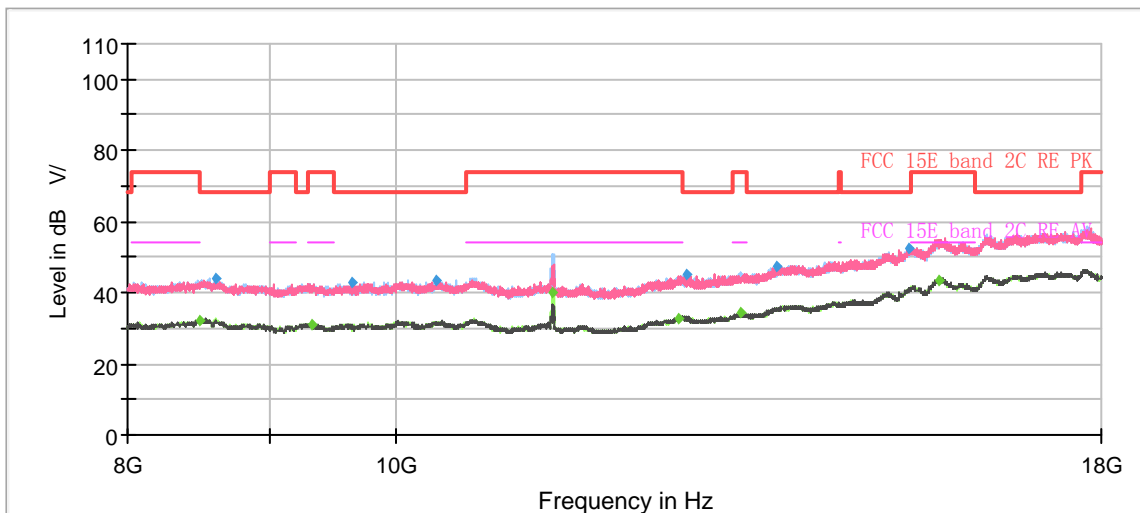

Radiates Emission from 8GHz to 18GHz





Frequency (MHz)	Peak (dBuV/m)	Average (dBuV/m)	Limit (dBuV/m)	Margin (dB)	Height (cm)	Polarization	Azimuth (deg)	Correct Factor (dB)
1199.50	---	32.52	54.00	21.48	200.0	V	91.00	-8
1246.75	41.66	---	68.20	26.54	100.0	V	173.00	-7
1440.13	---	32.76	54.00	21.24	100.0	V	297.00	-6
1888.13	44.63	---	68.20	23.57	200.0	V	23.00	-4
2627.50	47.01	---	68.20	21.19	200.0	V	193.00	0
2715.88	---	35.63	54.00	18.37	100.0	V	67.00	1
3583.00	49.57	---	68.20	18.63	200.0	V	62.00	4
3996.88	---	39.06	54.00	14.94	100.0	H	238.00	6
5196.50	51.93	---	68.20	16.27	100.0	V	236.00	9
5387.25	---	40.39	54.00	13.61	100.0	H	51.00	9
5857.13	52.44	---	68.20	15.76	100.0	V	160.00	10
7382.25	---	41.18	54.00	12.82	100.0	V	212.00	11

Remark: 1. Correction Factor = Antenna factor+ Insertion loss (cable loss + amplifier gain)

802.11n (HT20) CH144

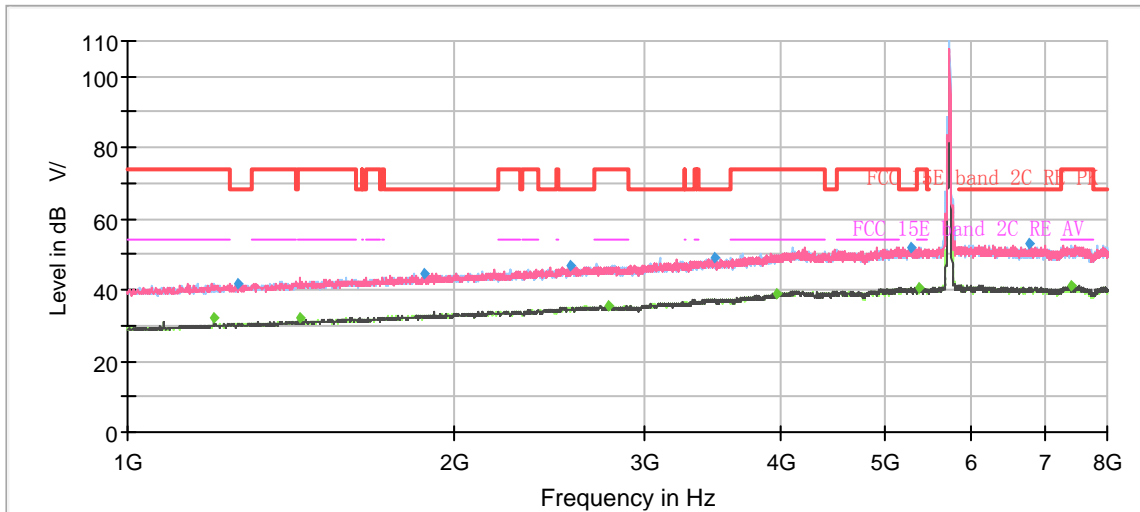

Note: The signal beyond the limit is carrier.  
Radiates Emission from 1GHz to 8GHz

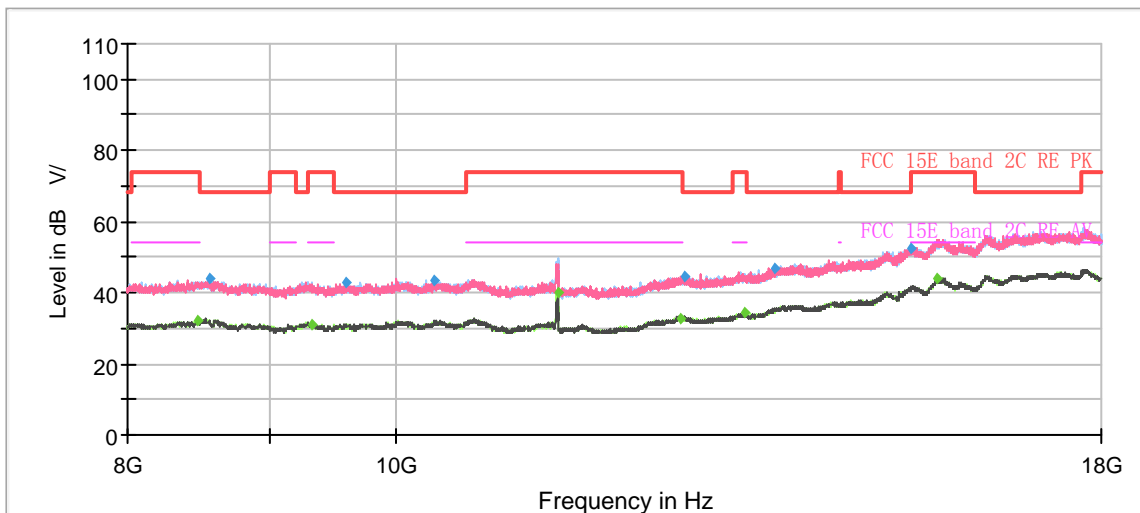

Radiates Emission from 8GHz to 18GHz



Frequency (MHz)	Peak (dBuV/m)	Average (dBuV/m)	Limit (dBuV/m)	Margin (dB)	Height (cm)	Polarization	Azimuth (deg)	Correct Factor (dB)
1199.50	---	31.93	54.00	22.07	100.0	V	0.00	-8
1266.00	41.72	---	68.20	26.48	200.0	H	194.00	-7
1440.13	---	32.15	54.00	21.85	100.0	V	359.00	-6
1875.88	44.81	---	68.20	23.39	200.0	H	292.00	-4
2554.88	47.04	---	68.20	21.16	100.0	V	274.00	0
2778.88	---	35.41	54.00	18.59	100.0	V	354.00	1
3478.88	48.84	---	68.20	19.36	200.0	H	321.00	4
3959.25	---	38.83	54.00	15.17	100.0	V	287.00	6
5277.00	51.83	---	68.20	16.37	100.0	V	311.00	9
5374.13	---	40.37	54.00	13.63	200.0	V	77.00	9
6772.38	52.75	---	68.20	15.45	100.0	V	82.00	10
7398.00	---	41.08	54.00	12.92	100.0	V	236.00	11

Remark: 1. Correction Factor = Antenna factor+ Insertion loss (cable loss + amplifier gain)

802.11n (HT20) CH149

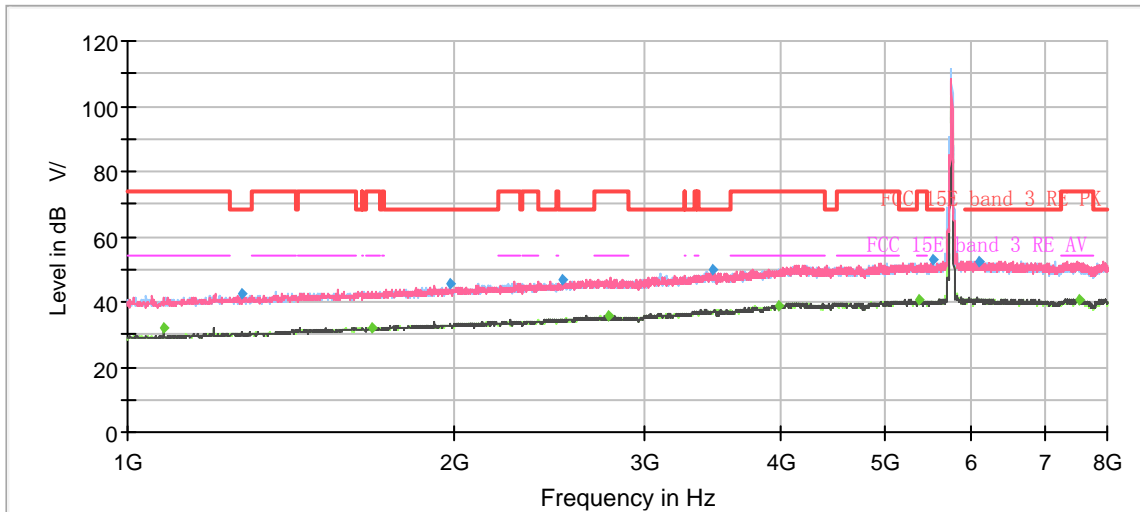

Note: The signal beyond the limit is carrier.  
Radiates Emission from 1GHz to 8GHz

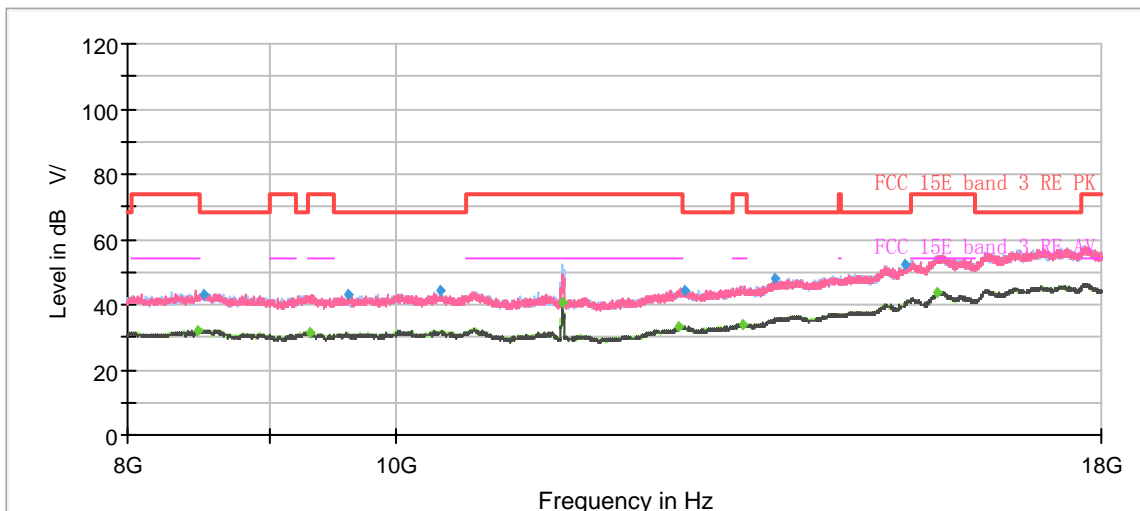

Radiates Emission from 8GHz to 18GHz



Frequency (MHz)	Peak (dBuV/m)	Average (dBuV/m)	Limit (dBuV/m)	Margin (dB)	Height (cm)	Polarization	Azimuth (deg)	Correct Factor (dB)
1079.63	---	32.12	54.00	21.88	200.0	V	96.00	-8
1272.13	42.27	---	68.20	25.93	200.0	H	196.00	-7
1680.75	---	32.09	54.00	21.91	100.0	V	322.00	-5
1981.75	45.78	---	68.20	22.42	200.0	V	193.00	-3
2513.75	46.87	---	68.20	21.33	100.0	V	302.00	0
2774.50	---	35.57	54.00	18.43	100.0	V	357.00	1
3464.88	50.01	---	68.20	18.19	200.0	V	63.00	4
3988.13	---	38.92	54.00	15.08	100.0	V	260.00	6
5373.25	---	40.37	54.00	13.63	100.0	V	216.00	9
5515.00	52.63	---	68.20	15.57	200.0	V	115.00	9
6081.13	52.50	---	68.20	15.70	200.0	H	127.00	10
7531.88	---	40.83	54.00	13.17	100.0	V	264.00	11

Remark: 1. Correction Factor = Antenna factor+ Insertion loss (cable loss + amplifier gain)

## 802.11n (HT20) CH157

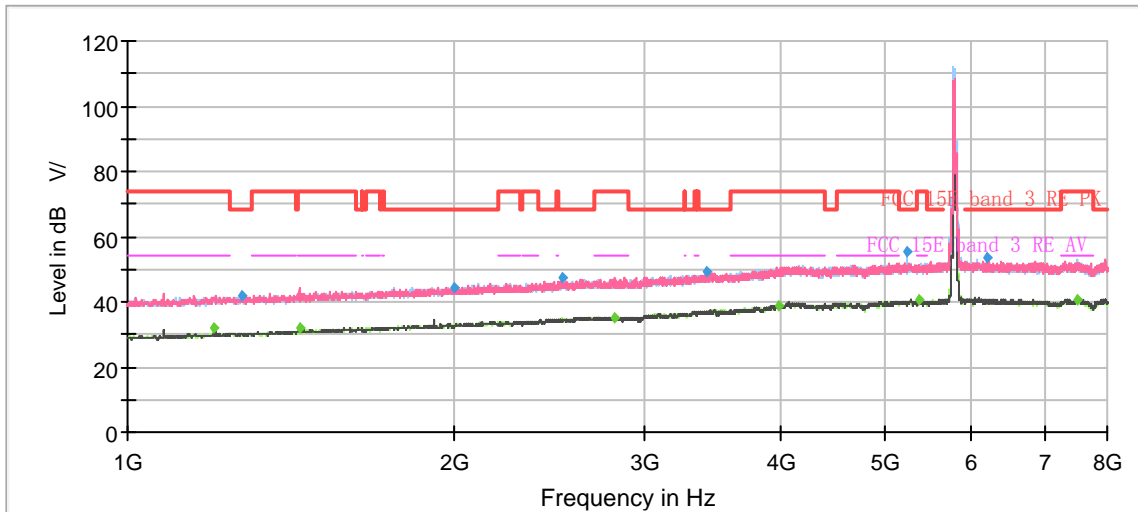

Note: The signal beyond the limit is carrier.  
Radiates Emission from 1GHz to 8GHz

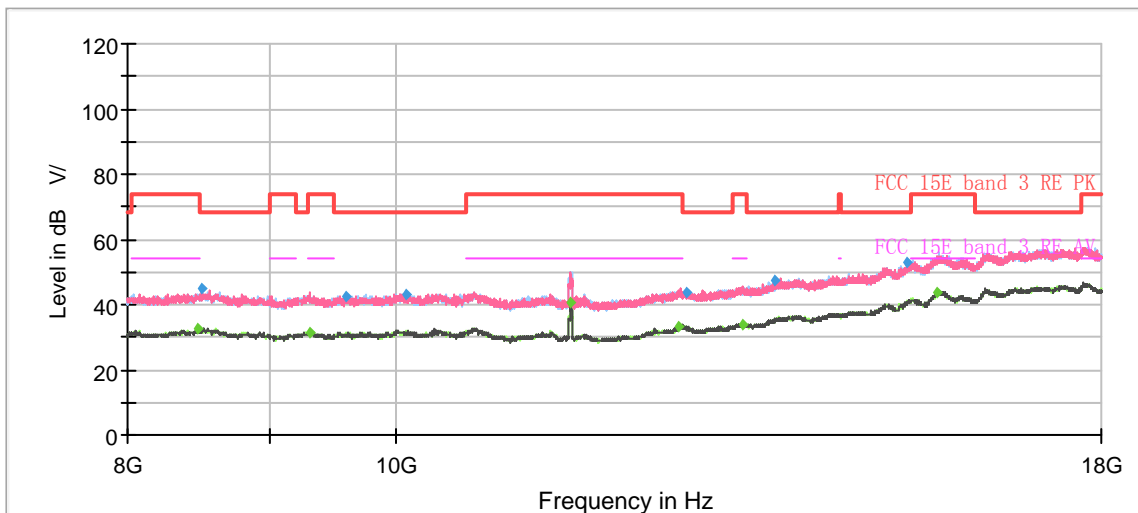

Radiates Emission from 8GHz to 18GHz



Frequency (MHz)	Peak (dBuV/m)	Average (dBuV/m)	Limit (dBuV/m)	Margin (dB)	Height (cm)	Polarization	Azimuth (deg)	Correct Factor (dB)
1199.50	---	32.26	54.00	21.74	100.0	V	238.00	-8
1273.00	41.90	---	68.20	26.30	100.0	V	305.00	-7
1440.13	---	32.19	54.00	21.81	100.0	V	278.00	-6
1996.63	44.53	---	68.20	23.67	200.0	V	272.00	-3
2520.75	47.32	---	68.20	20.88	100.0	V	121.00	0
2814.75	---	35.26	54.00	18.74	200.0	H	180.00	1
3411.50	49.12	---	68.20	19.08	200.0	V	326.00	4
3989.88	---	38.93	54.00	15.07	200.0	H	255.00	6
5221.00	55.45	---	68.20	12.75	100.0	H	148.00	9
5375.00	---	40.32	54.00	13.68	200.0	V	67.00	9
6200.13	53.50	---	68.20	14.70	100.0	V	243.00	10
7491.63	---	40.73	54.00	13.27	100.0	V	218.00	11

Remark: 1. Correction Factor = Antenna factor+ Insertion loss (cable loss + amplifier gain)



802.11n (HT20) CH165

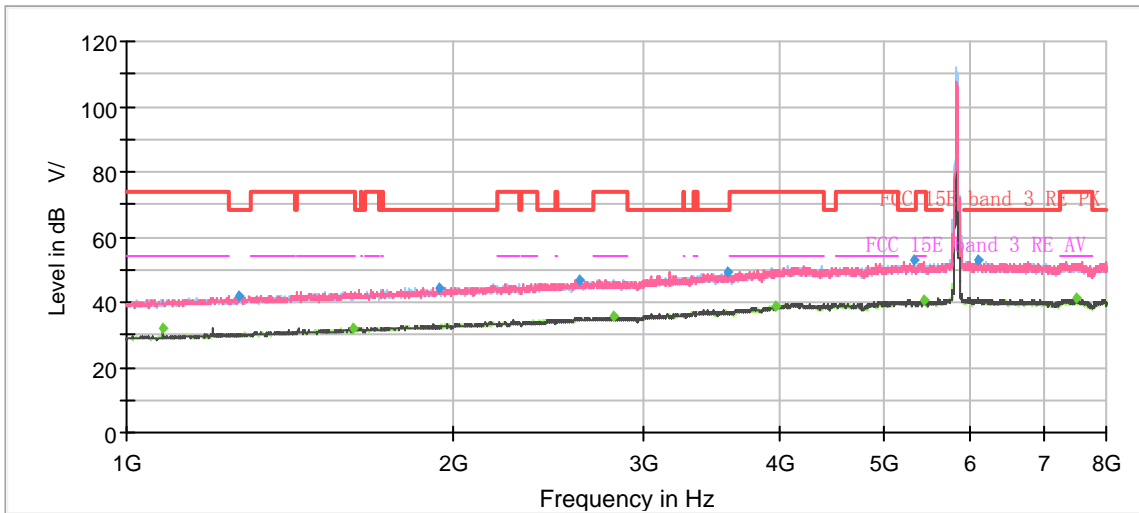

Note: The signal beyond the limit is carrier.  
Radiates Emission from 1GHz to 8GHz

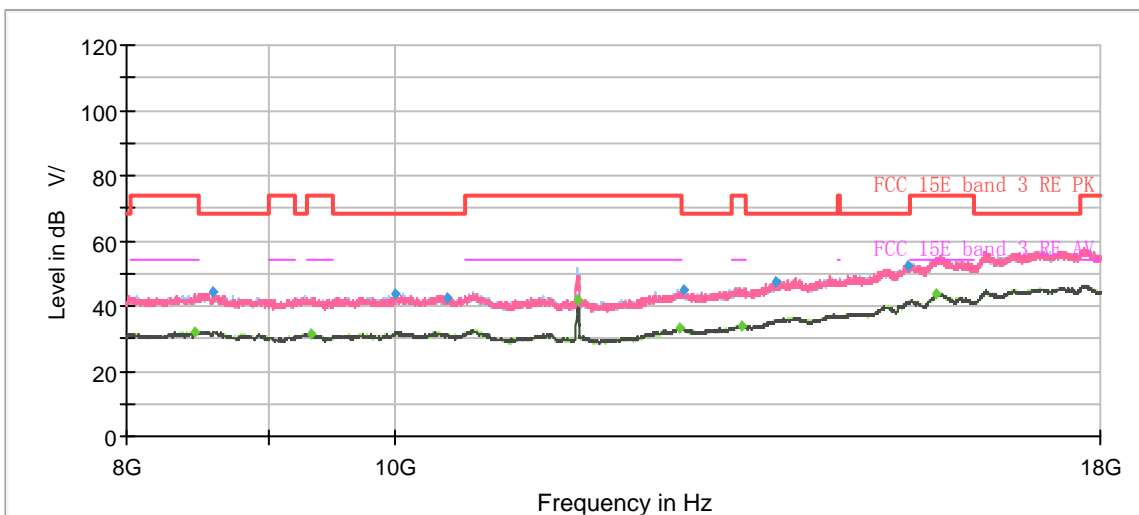

Radiates Emission from 8GHz to 18GHz





Frequency (MHz)	Peak (dBuV/m)	Average (dBuV/m)	Limit (dBuV/m)	Margin (dB)	Height (cm)	Polarization	Azimuth (deg)	Correct Factor (dB)
1079.63	---	32.10	54.00	21.90	200.0	V	105.00	-8
1268.63	41.99	---	68.20	26.21	200.0	V	12.00	-7
1619.50	---	32.18	54.00	21.82	100.0	V	96.00	-5
1939.75	44.61	---	68.20	23.59	100.0	V	251.00	-3
2610.00	46.78	---	68.20	21.42	200.0	V	81.00	0
2807.75	---	35.56	54.00	18.44	100.0	V	135.00	1
3579.50	49.34	---	68.20	18.86	200.0	V	288.00	4
3963.63	---	39.08	54.00	14.92	100.0	H	194.00	6
5326.88	52.84	---	68.20	15.36	100.0	V	286.00	9
5433.63	---	40.35	54.00	13.65	100.0	V	4.00	9
6086.38	52.87	---	68.20	15.33	100.0	V	106.00	10
7502.13	---	40.97	54.00	13.03	200.0	V	7.00	11

Remark: 1. Correction Factor = Antenna factor+ Insertion loss (cable loss + amplifier gain)

## 802.11n (HT40) CH38

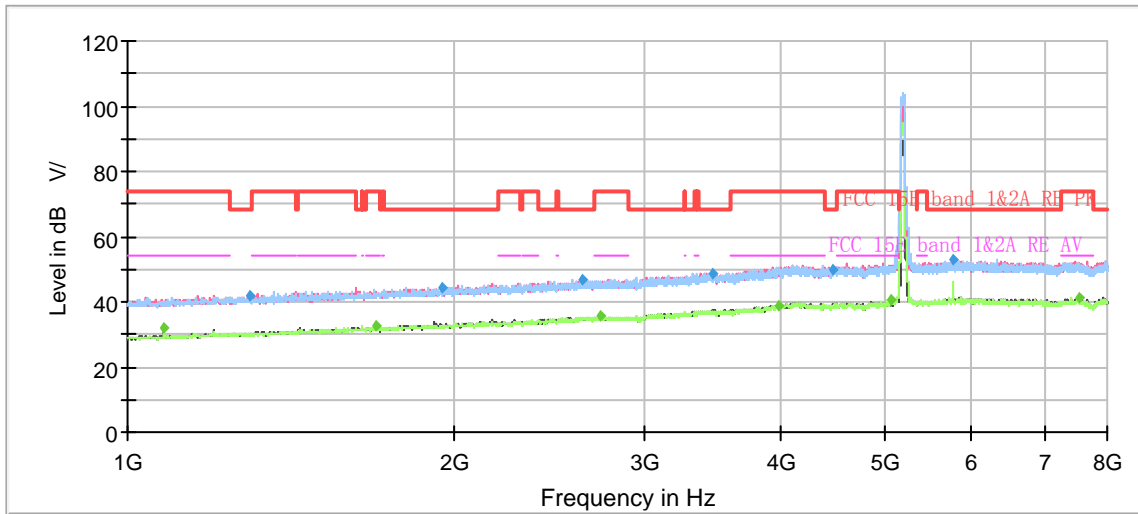

Note: The signal beyond the limit is carrier.  
Radiates Emission from 1GHz to 8GHz

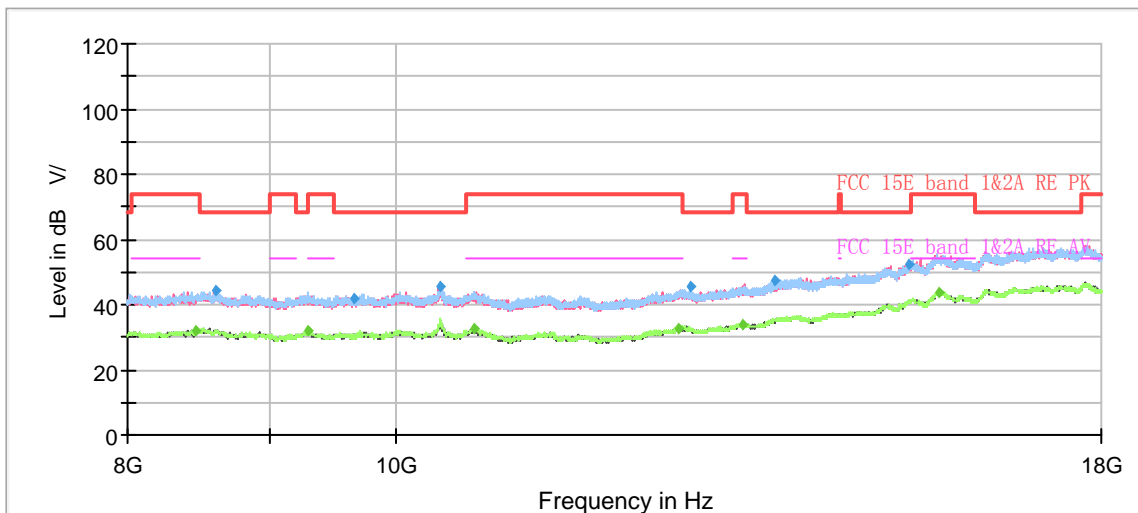

Radiates Emission from 8GHz to 18GHz



Frequency (MHz)	Peak (dBuV/m)	Average (dBuV/m)	Limit (dBuV/m)	Margin (dB)	Height (cm)	Polarization	Azimuth (deg)	Correct Factor (dB)
1079.63	---	31.69	54.00	22.31	100.0	V	0.00	-8
1294.00	41.91	---	68.20	26.29	200.0	V	252.00	-7
1695.63	---	32.36	54.00	21.64	200.0	H	75.00	-5
1948.50	44.43	---	68.20	23.77	100.0	V	188.00	-3
2620.50	46.96	---	68.20	21.24	100.0	V	0.00	0
2722.88	---	35.46	54.00	18.54	200.0	V	348.00	1
3460.50	48.87	---	68.20	19.33	200.0	H	70.00	4
3987.25	---	39.07	54.00	14.93	200.0	V	320.00	6
4472.00	49.97	---	68.20	18.23	200.0	V	71.00	7
5046.00	---	40.34	54.00	13.66	100.0	H	354.00	9
5760.00	53.11	---	68.20	15.09	200.0	H	0.00	10
7526.63	---	40.96	54.00	13.04	100.0	V	3.00	11

Remark: 1. Correction Factor = Antenna factor+ Insertion loss (cable loss + amplifier gain)

## 802.11n (HT40) CH46

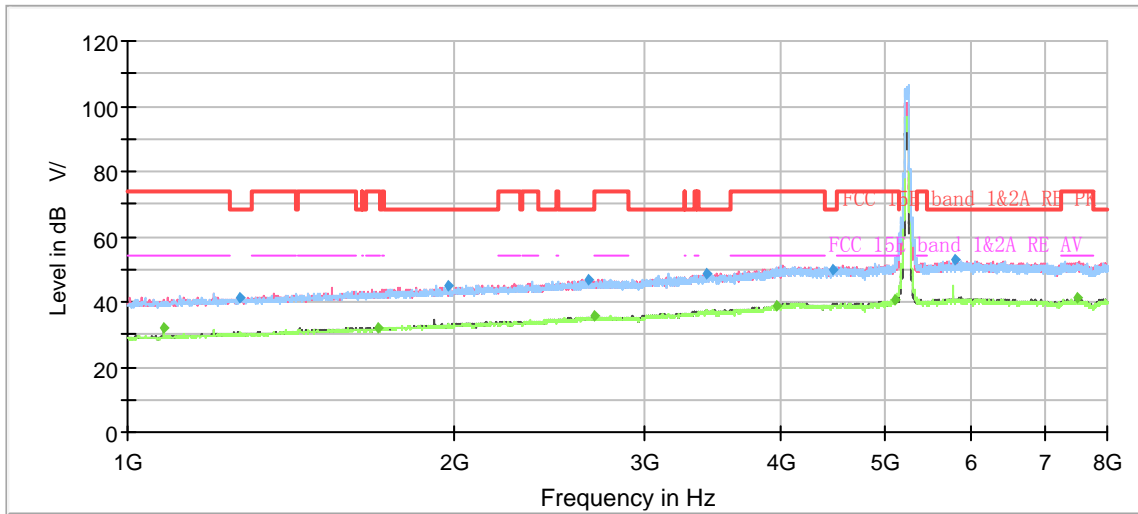

Note: The signal beyond the limit is carrier.  
Radiates Emission from 1GHz to 8GHz

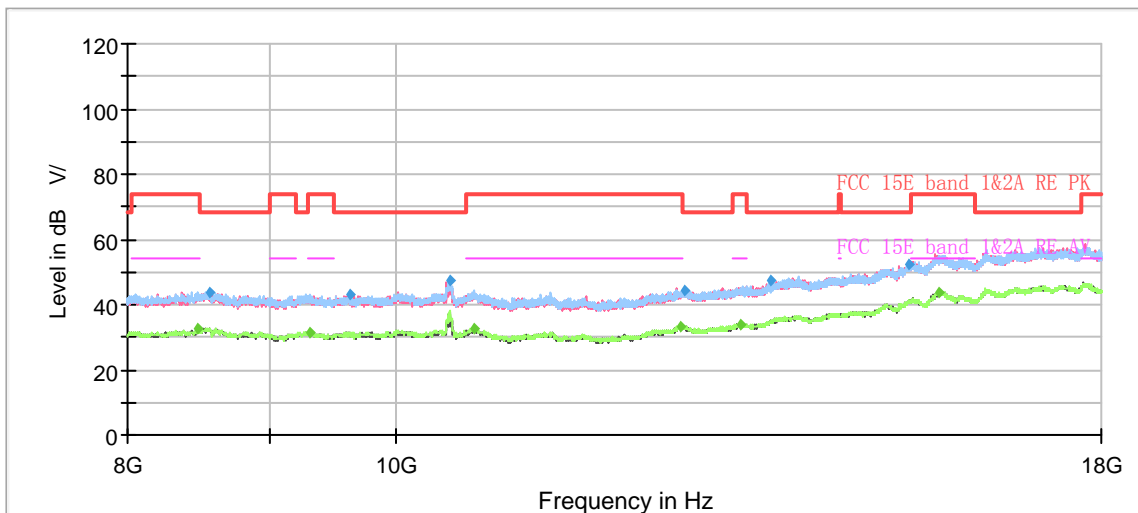

Radiates Emission from 8GHz to 18GHz



Frequency (MHz)	Peak (dBuV/m)	Average (dBuV/m)	Limit (dBuV/m)	Margin (dB)	Height (cm)	Polarization	Azimuth (deg)	Correct Factor (dB)
1079.63	---	31.82	54.00	22.18	200.0	V	233.00	-8
1266.88	41.51	---	68.20	26.69	100.0	H	32.00	-7
1700.00	---	32.14	54.00	21.86	200.0	V	294.00	-5
1973.88	44.85	---	68.20	23.35	100.0	V	249.00	-3
2659.00	46.80	---	68.20	21.40	100.0	V	126.00	0
2695.75	---	35.44	54.00	18.56	100.0	H	14.00	1
3423.75	48.86	---	68.20	19.34	100.0	H	265.00	4
3967.13	---	38.91	54.00	15.09	200.0	V	340.00	6
4474.63	50.12	---	68.20	18.08	100.0	V	69.00	7
5100.25	---	40.76	54.00	13.24	200.0	H	337.00	9
5779.25	53.07	---	68.20	15.13	100.0	H	188.00	10
7496.88	---	40.99	54.00	13.01	100.0	V	165.00	11

Remark: 1. Correction Factor = Antenna factor+ Insertion loss (cable loss + amplifier gain)



### 802.11n (HT40) CH54

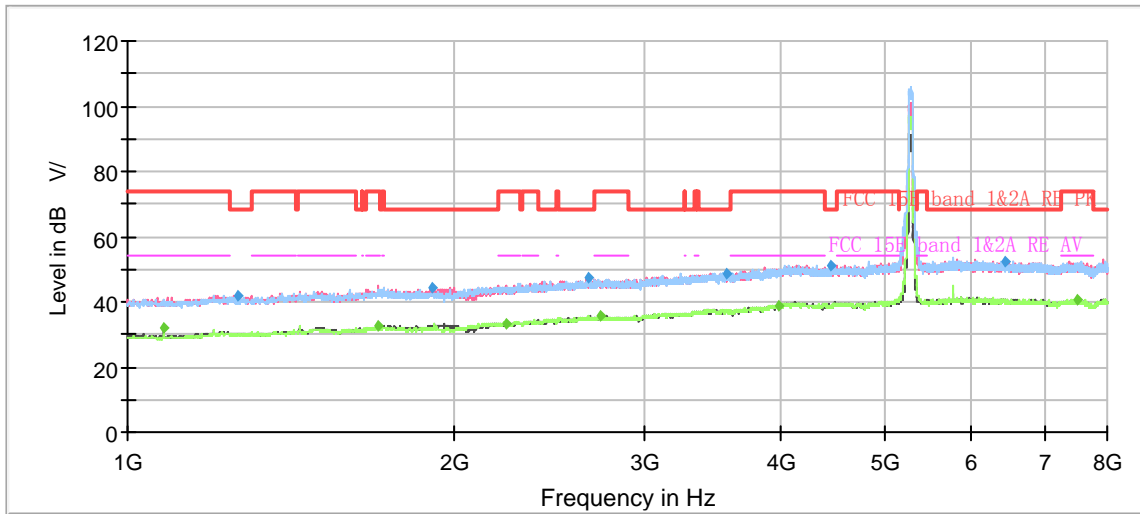

Note: The signal beyond the limit is carrier.  
Radiates Emission from 1GHz to 8GHz

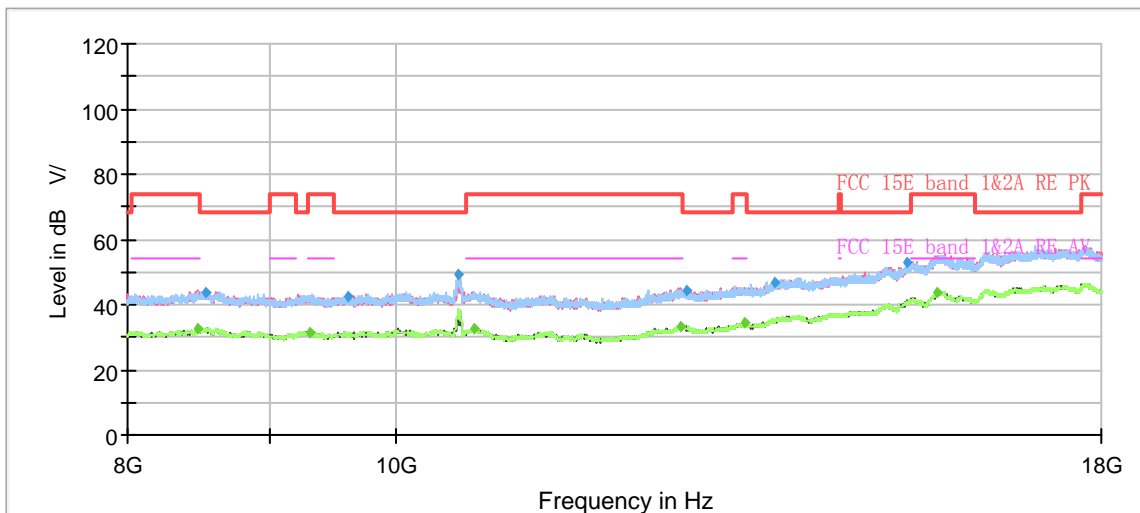

Radiates Emission from 8GHz to 18GHz



Frequency (MHz)	Peak (dBuV/m)	Average (dBuV/m)	Limit (dBuV/m)	Margin (dB)	Height (cm)	Polarization	Azimuth (deg)	Correct Factor (dB)
1079.63	---	32.03	54.00	21.97	100.0	V	329.00	-8
1264.25	41.68	---	68.20	26.52	200.0	V	233.00	-7
1703.50	---	32.48	54.00	21.52	200.0	V	89.00	-5
1904.75	44.57	---	68.20	23.63	100.0	V	223.00	-4
2232.88	---	33.16	54.00	20.84	100.0	V	145.00	-2
2658.13	47.36	---	68.20	20.84	100.0	V	16.00	0
2725.50	---	35.44	54.00	18.56	200.0	V	267.00	1
3569.88	48.83	---	68.20	19.37	100.0	V	203.00	4
3975.00	---	38.90	54.00	15.10	100.0	V	243.00	6
4445.75	50.84	---	68.20	17.36	200.0	V	104.00	7
6434.63	52.12	---	68.20	16.08	100.0	V	61.00	10
7502.13	---	40.89	54.00	13.11	100.0	H	330.00	11

Remark: 1. Correction Factor = Antenna factor+ Insertion loss (cable loss + amplifier gain)



### 802.11n (HT40) CH62

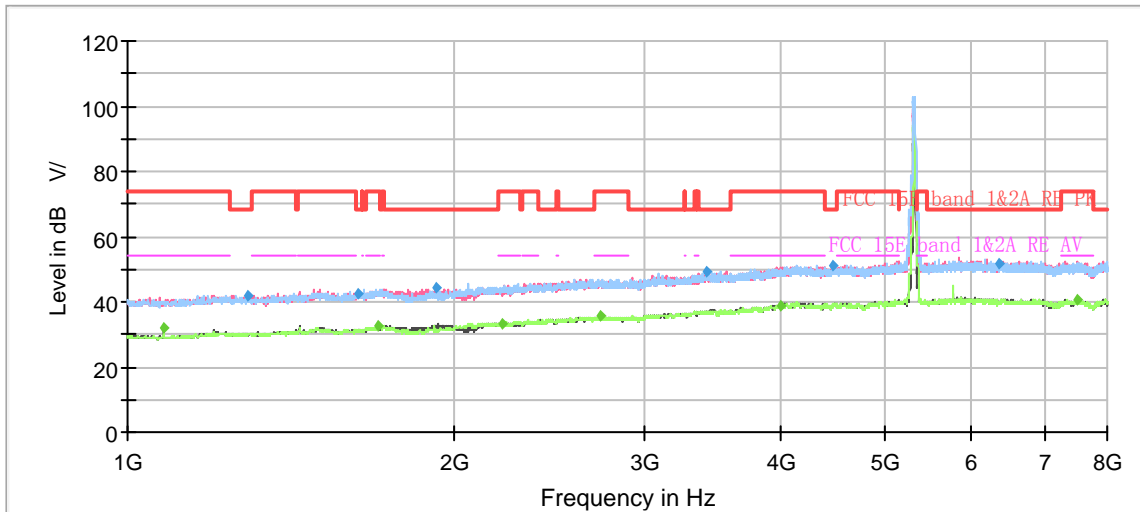

Note: The signal beyond the limit is carrier.  
Radiates Emission from 1GHz to 8GHz

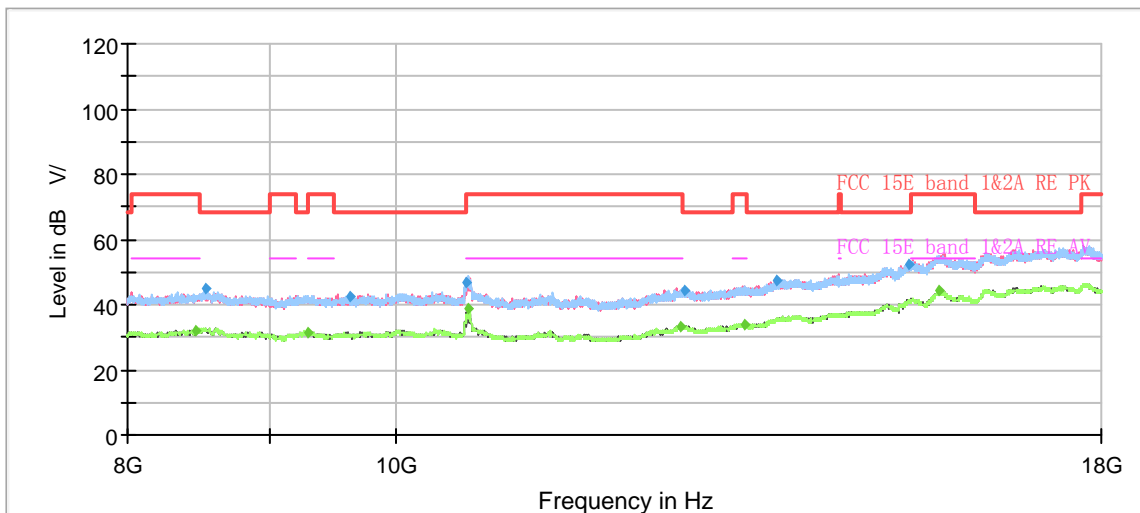

Radiates Emission from 8GHz to 18GHz





Frequency (MHz)	Peak (dBuV/m)	Average (dBuV/m)	Limit (dBuV/m)	Margin (dB)	Height (cm)	Polarization	Azimuth (deg)	Correct Factor (dB)
1079.63	---	31.84	54.00	22.16	100.0	V	315.00	-8
1292.25	42.05	---	68.20	26.15	100.0	H	281.00	-7
1630.88	42.64	---	68.20	25.56	200.0	V	269.00	-5
1702.63	---	32.37	54.00	21.63	100.0	H	267.00	-5
1926.63	44.17	---	68.20	24.04	200.0	V	47.00	-3
2218.00	---	33.25	54.00	20.75	100.0	H	142.00	-2
2724.63	---	35.42	54.00	18.58	200.0	H	16.00	1
3422.88	49.53	---	68.20	18.67	200.0	H	300.00	4
3997.75	---	38.81	54.00	15.19	200.0	H	16.00	6
4473.75	50.89	---	68.20	17.31	200.0	V	209.00	7
6354.13	51.68	---	68.20	16.52	200.0	H	138.00	10
7498.63	---	40.48	54.00	13.52	200.0	V	130.00	11

Remark: 1. Correction Factor = Antenna factor+ Insertion loss (cable loss + amplifier gain)

802.11n (HT40) CH102

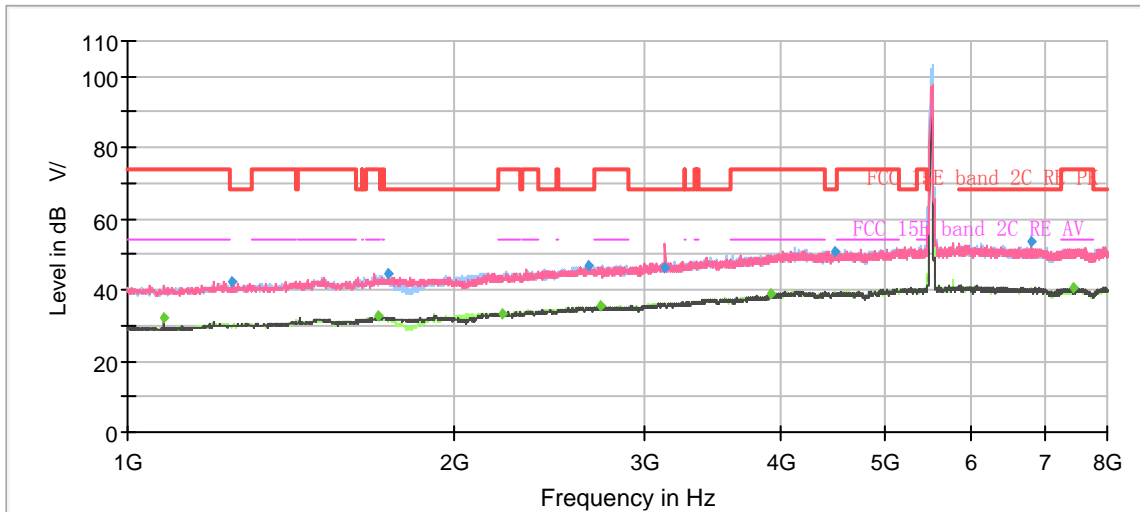

Note: The signal beyond the limit is carrier.  
Radiates Emission from 1GHz to 8GHz

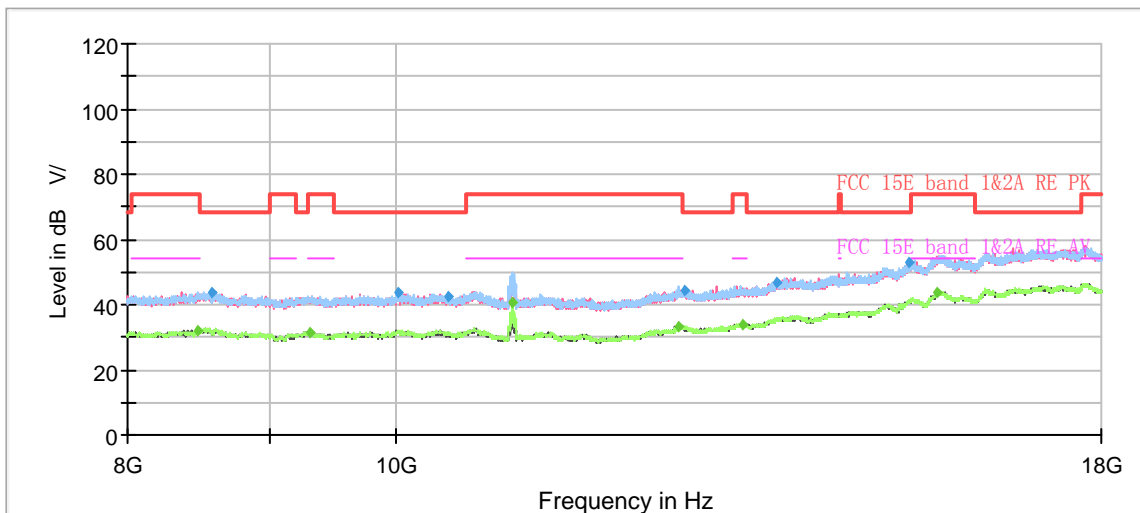

Radiates Emission from 8GHz to 18GHz



Frequency (MHz)	Peak (dBuV/m)	Average (dBuV/m)	Limit (dBuV/m)	Margin (dB)	Height (cm)	Polarization	Azimuth (deg)	Correct Factor (dB)
1079.63	---	32.11	54.00	21.89	100.0	V	333.00	-8
1245.88	42.05	---	68.20	26.15	100.0	H	67.00	-7
1702.63	---	32.49	54.00	21.51	100.0	H	129.00	-5
1741.13	44.29	---	68.20	23.91	100.0	V	110.00	-4
2215.38	---	33.12	54.00	20.88	100.0	H	278.00	-2
2662.50	47.03	---	68.20	21.17	100.0	H	37.00	0
2724.63	---	35.33	54.00	18.67	200.0	H	117.00	1
3130.63	46.48	---	68.20	21.72	200.0	V	135.00	2
3917.25	---	38.90	54.00	15.10	200.0	V	111.00	6
4481.63	50.91	---	68.20	17.29	100.0	V	216.00	7
6802.13	53.53	---	68.20	14.67	100.0	V	249.00	10
7442.63	---	40.54	54.00	13.46	100.0	V	0.00	11

**Remark: 1. Correction Factor = Antenna factor+ Insertion loss (cable loss + amplifier gain)**

802.11n (HT40) CH134

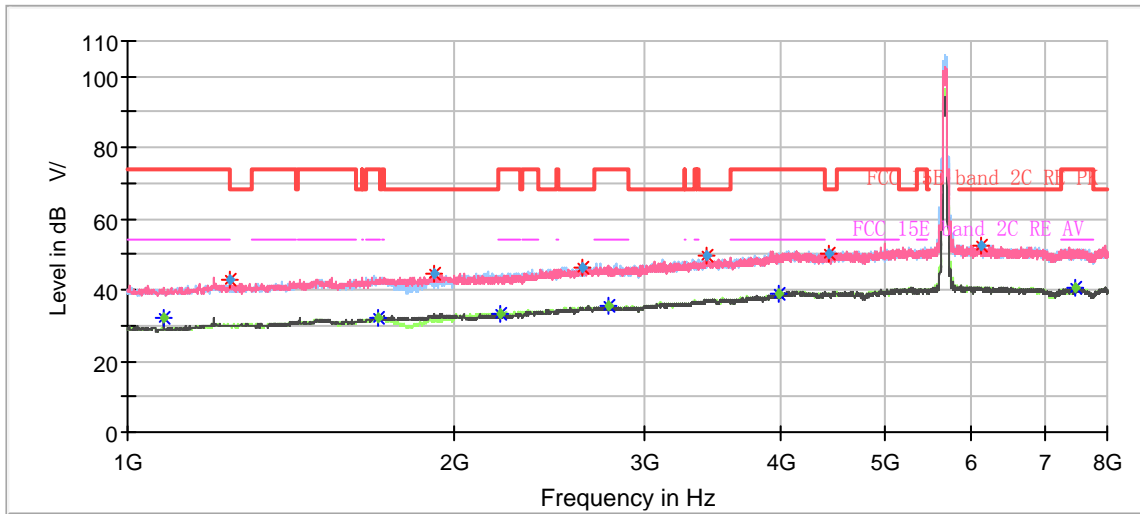

Note: The signal beyond the limit is carrier.  
Radiates Emission from 1GHz to 8GHz

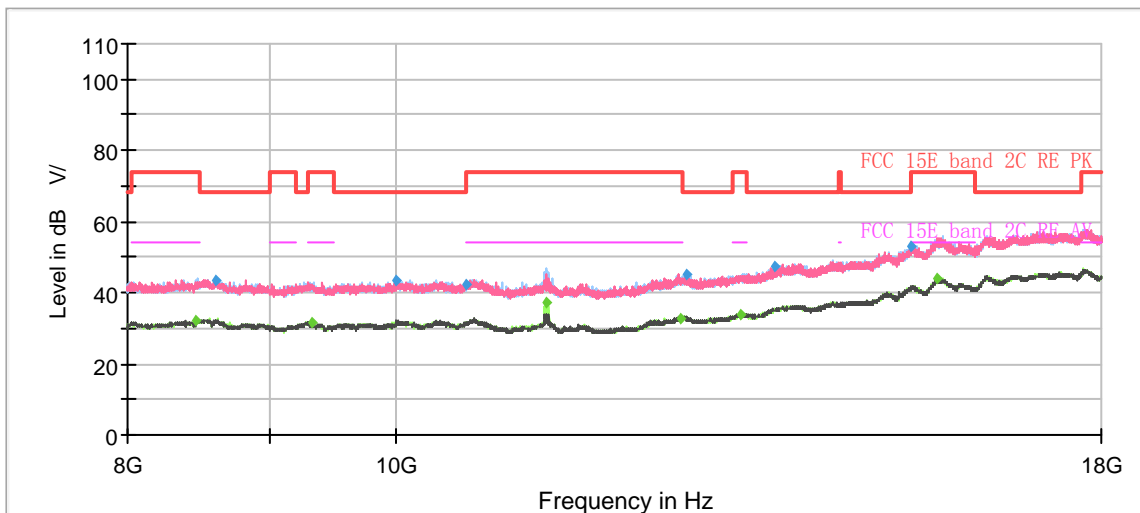

Radiates Emission from 8GHz to 18GHz



Frequency (MHz)	Peak (dBuV/m)	Average (dBuV/m)	Limit (dBuV/m)	Margin (dB)	Height (cm)	Polarization	Azimuth (deg)	Correct Factor (dB)
1079.63	---	32.25	54.00	21.75	200.0	V	7.00	-8
1244.13	42.96	---	68.20	25.24	100.0	V	350.00	-7
1702.63	---	32.22	54.00	21.78	100.0	H	16.00	-5
1918.75	44.46	---	68.20	23.74	100.0	V	77.00	-3
2206.63	---	33.15	54.00	20.85	100.0	H	11.00	-2
2626.63	46.49	---	68.20	21.71	200.0	H	299.00	0
2780.63	---	35.35	54.00	18.65	200.0	H	294.00	1
3414.13	49.64	---	68.20	18.56	100.0	H	83.00	4
3983.75	---	38.76	54.00	15.24	200.0	V	108.00	6
4426.50	50.35	---	68.20	17.85	200.0	H	155.00	7
6128.38	52.64	---	68.20	15.56	200.0	H	338.00	10
7482.88	---	40.44	54.00	13.56	100.0	V	341.00	11

Remark: 1. Correction Factor = Antenna factor+ Insertion loss (cable loss + amplifier gain)



802.11n (HT40) CH142

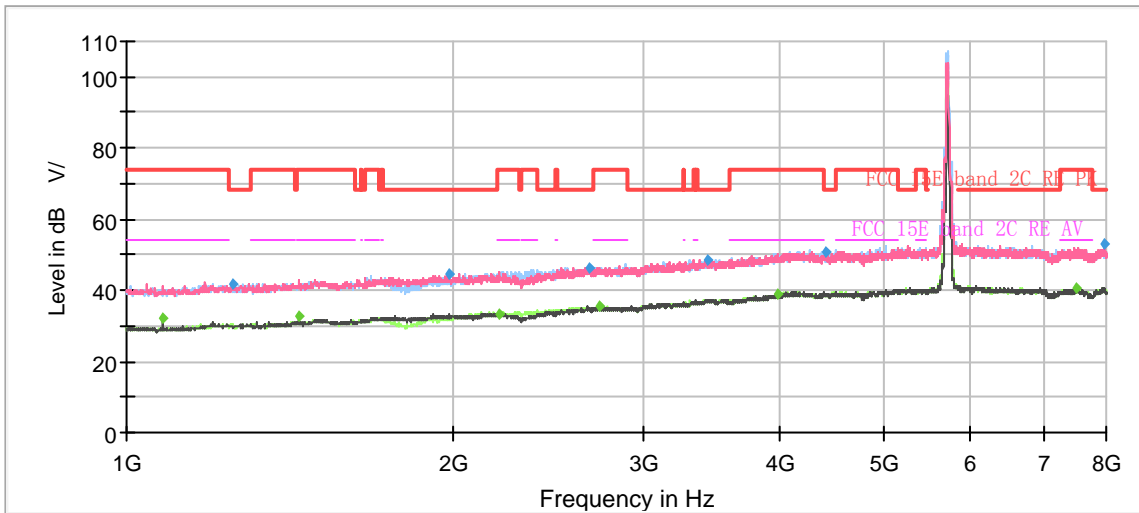

Note: The signal beyond the limit is carrier.  
Radiates Emission from 1GHz to 8GHz

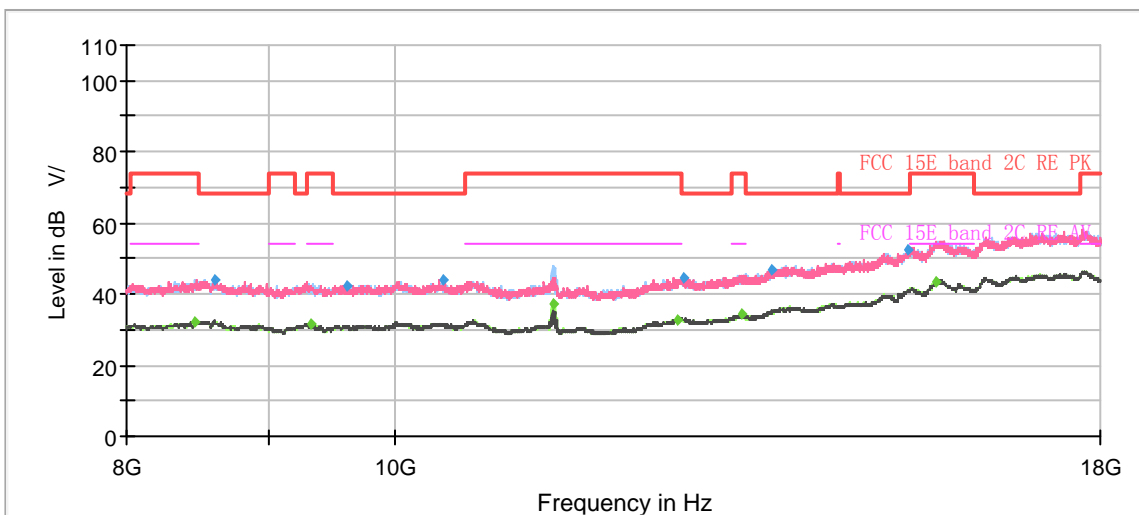

Radiates Emission from 8GHz to 18GHz



Frequency (MHz)	Peak (dBuV/m)	Average (dBuV/m)	Limit (dBuV/m)	Margin (dB)	Height (cm)	Polarization	Azimuth (deg)	Correct Factor (dB)
1079.63	---	31.98	54.00	22.02	200.0	V	201.00	-8
1250.25	41.88	---	68.20	26.32	100.0	V	354.00	-7
1440.13	---	32.53	54.00	21.47	200.0	H	343.00	-6
1983.50	44.35	---	68.20	23.85	100.0	V	258.00	-3
2205.75	---	33.11	54.00	20.89	200.0	H	279.00	-2
2670.38	46.54	---	68.20	21.66	100.0	H	325.00	0
2727.25	---	35.47	54.00	18.53	100.0	H	155.00	1
3434.25	48.54	---	68.20	19.66	100.0	V	350.00	4
3990.75	---	38.95	54.00	15.05	100.0	H	15.00	6
4403.75	50.66	---	68.20	17.54	200.0	H	279.00	7
7516.13	---	40.36	54.00	13.64	100.0	V	0.00	11
7964.13	52.80	---	68.20	15.40	100.0	V	299.00	12

Remark: 1. Correction Factor = Antenna factor+ Insertion loss (cable loss + amplifier gain)

## 802.11n (HT40) CH151

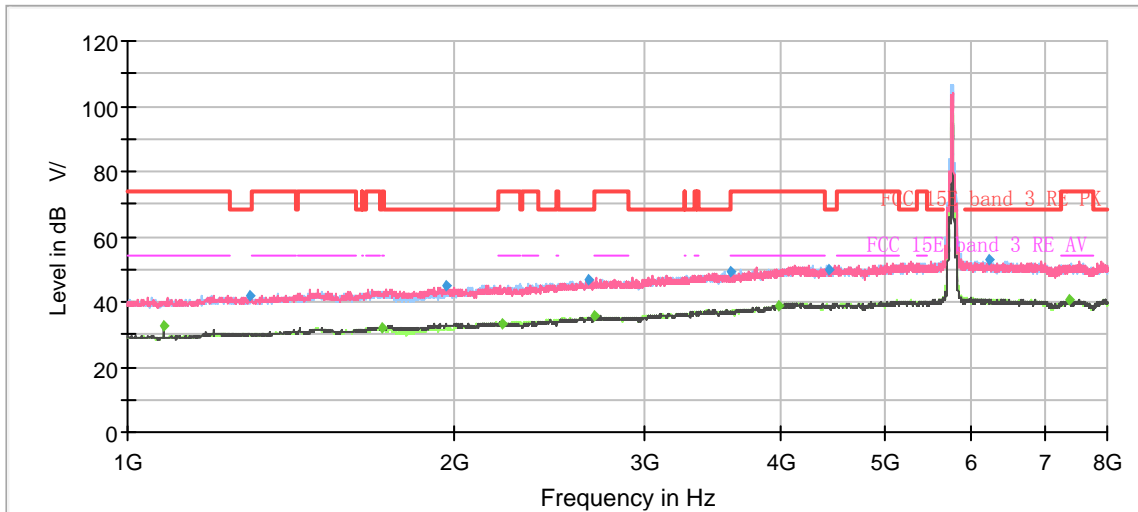

Note: The signal beyond the limit is carrier.  
Radiates Emission from 1GHz to 8GHz

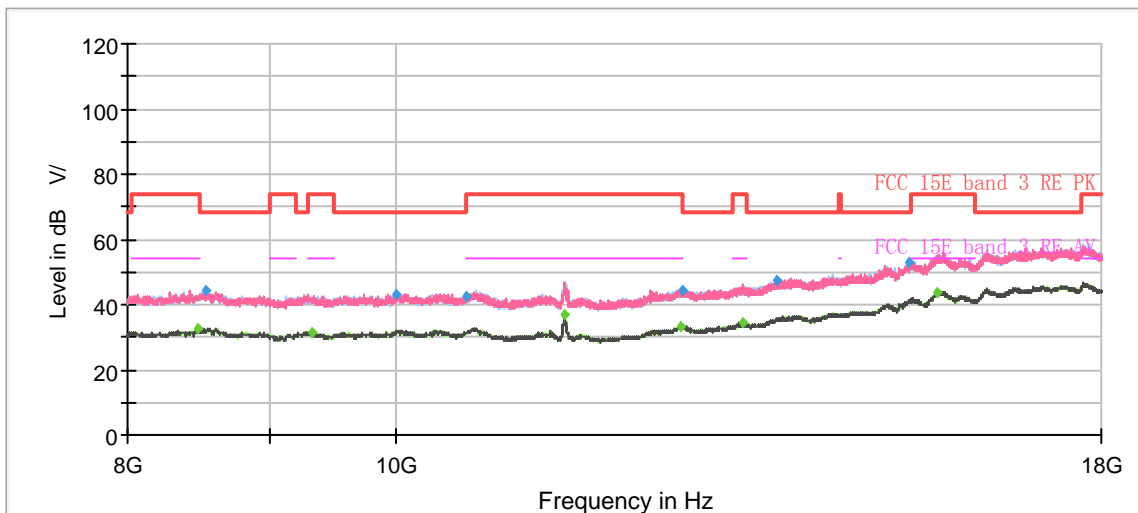

Radiates Emission from 8GHz to 18GHz





Frequency (MHz)	Peak (dBuV/m)	Average (dBuV/m)	Limit (dBuV/m)	Margin (dB)	Height (cm)	Polarization	Azimuth (deg)	Correct Factor (dB)
1079.63	---	32.44	54.00	21.56	100.0	V	355.00	-8
1297.50	41.68	---	68.20	26.52	200.0	V	223.00	-7
1719.25	---	32.26	54.00	21.74	100.0	V	332.00	-5
1966.00	45.15	---	68.20	23.05	100.0	V	198.00	-3
2211.00	---	33.07	54.00	20.93	100.0	H	357.00	-2
2654.63	46.77	---	68.20	21.43	100.0	H	314.00	0
2697.50	---	35.46	54.00	18.54	100.0	H	12.00	1
3592.63	49.05	---	68.20	19.15	100.0	V	188.00	4
3986.38	---	38.80	54.00	15.20	100.0	H	267.00	6
4421.25	50.00	---	68.20	18.20	100.0	H	29.00	7
6222.88	52.75	---	68.20	15.45	100.0	V	179.00	10
7374.38	---	40.63	54.00	13.37	100.0	V	246.00	11

Remark: 1. Correction Factor = Antenna factor+ Insertion loss (cable loss + amplifier gain)

802.11n (HT40) CH159

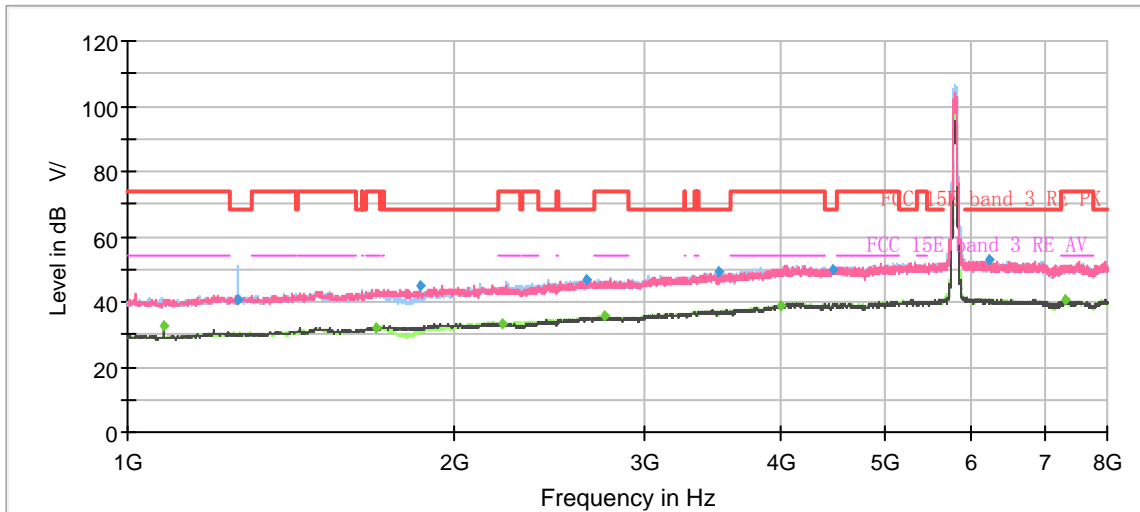

Note: The signal beyond the limit is carrier.  
Radiates Emission from 1GHz to 8GHz

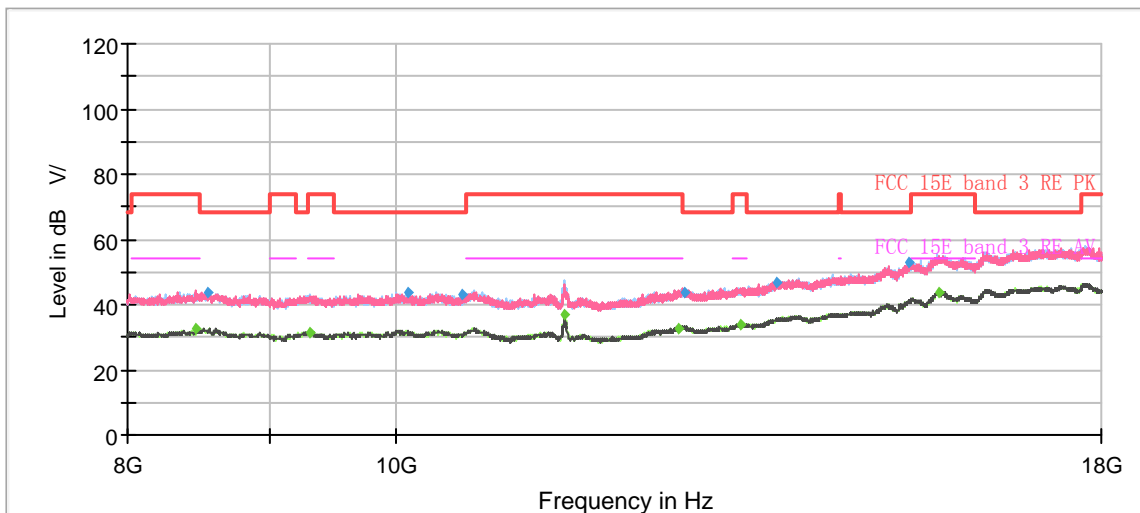

Radiates Emission from 8GHz to 18GHz



Frequency (MHz)	Peak (dBuV/m)	Average (dBuV/m)	Limit (dBuV/m)	Margin (dB)	Height (cm)	Polarization	Azimuth (deg)	Correct Factor (dB)
1079.63	---	32.76	54.00	21.24	100.0	V	335.00	-8
1261.63	40.72	---	68.20	27.48	200.0	V	299.00	-7
1691.25	---	32.29	54.00	21.71	200.0	H	306.00	-5
1860.13	44.82	---	68.20	23.38	200.0	V	356.00	-4
2215.38	---	33.08	54.00	20.92	100.0	H	255.00	-2
2646.75	47.00	---	68.20	21.20	100.0	H	351.00	0
2756.13	---	35.41	54.00	18.59	100.0	H	356.00	1
3509.50	49.02	---	68.20	19.18	200.0	V	54.00	4
3996.00	---	38.87	54.00	15.13	100.0	H	237.00	6
4474.63	50.11	---	68.20	18.09	100.0	H	275.00	7
6237.75	52.77	---	68.20	15.43	100.0	V	0.00	10
7324.50	---	40.36	54.00	13.64	100.0	V	48.00	11

Remark: 1. Correction Factor = Antenna factor+ Insertion loss (cable loss + amplifier gain)

802.11ac (VHT80) CH42

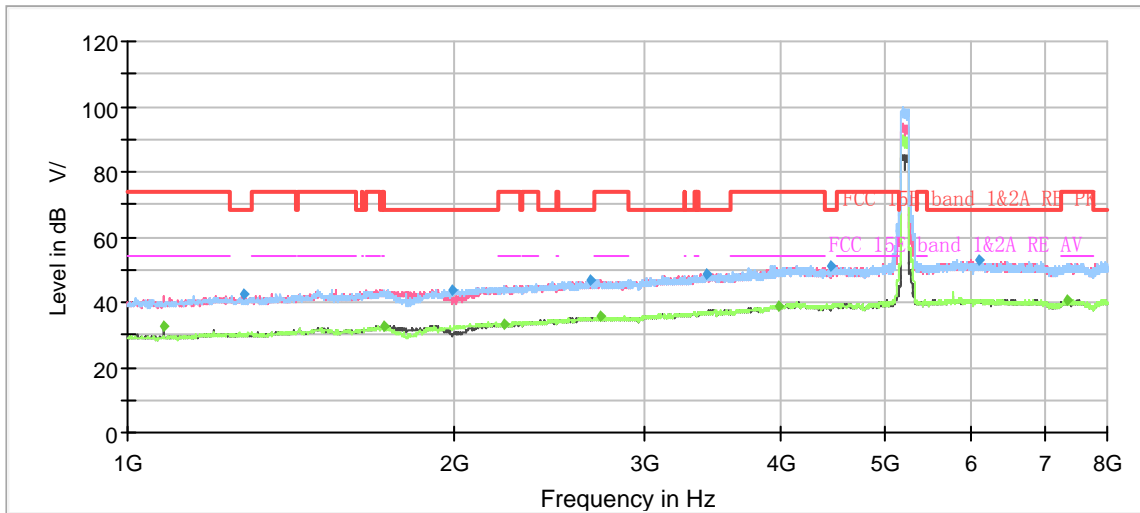

Note: The signal beyond the limit is carrier.  
Radiates Emission from 1GHz to 8GHz

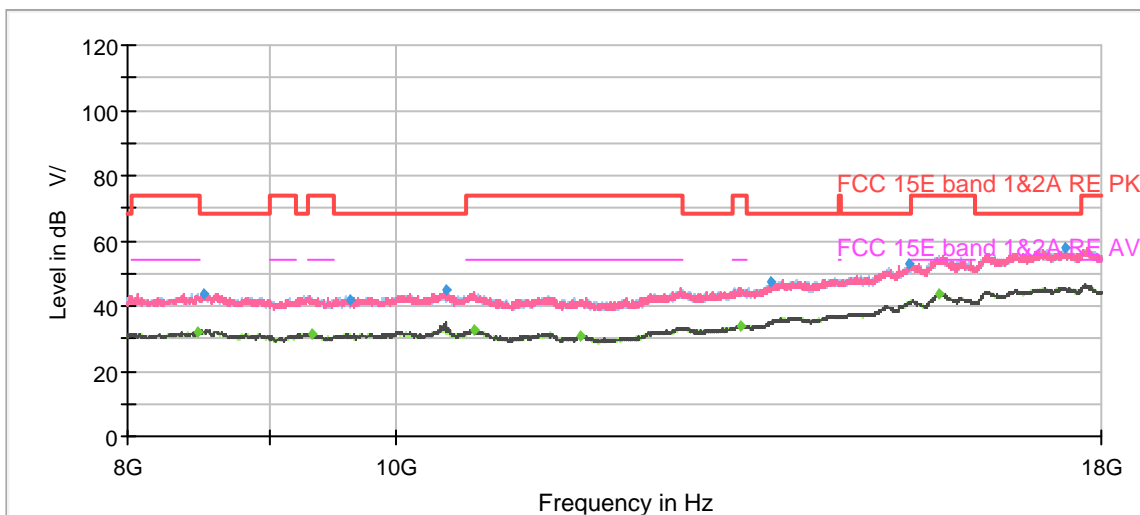

Radiates Emission from 8GHz to 18GHz



Frequency (MHz)	Peak (dBuV/m)	Average (dBuV/m)	Limit (dBuV/m)	Margin (dB)	Height (cm)	Polarization	Azimuth (deg)	Correct Factor (dB)
1079.63	---	32.81	54.00	21.19	100.0	V	348.00	-8
1280.88	42.16	---	68.20	26.04	200.0	V	31.00	-7
1721.88	---	32.49	54.00	21.51	200.0	V	7.00	-4
1987.88	43.85	---	68.20	24.35	100.0	H	150.00	-3
2226.75	---	33.16	54.00	20.84	200.0	V	36.00	-2
2675.63	46.51	---	68.20	21.69	100.0	H	92.00	0
2725.50	---	35.47	54.00	18.53	100.0	V	338.00	1
3422.00	48.81	---	68.20	19.39	100.0	V	328.00	4
3984.63	---	38.93	54.00	15.07	100.0	V	290.00	6
4458.00	51.08	---	68.20	17.12	200.0	H	39.00	7
6085.50	53.05	---	68.20	15.15	100.0	H	233.00	10
7356.00	---	40.55	54.00	13.45	100.0	H	29.00	11

Remark: 1. Correction Factor = Antenna factor+ Insertion loss (cable loss + amplifier gain)



### 802.11ac (VHT80) CH58

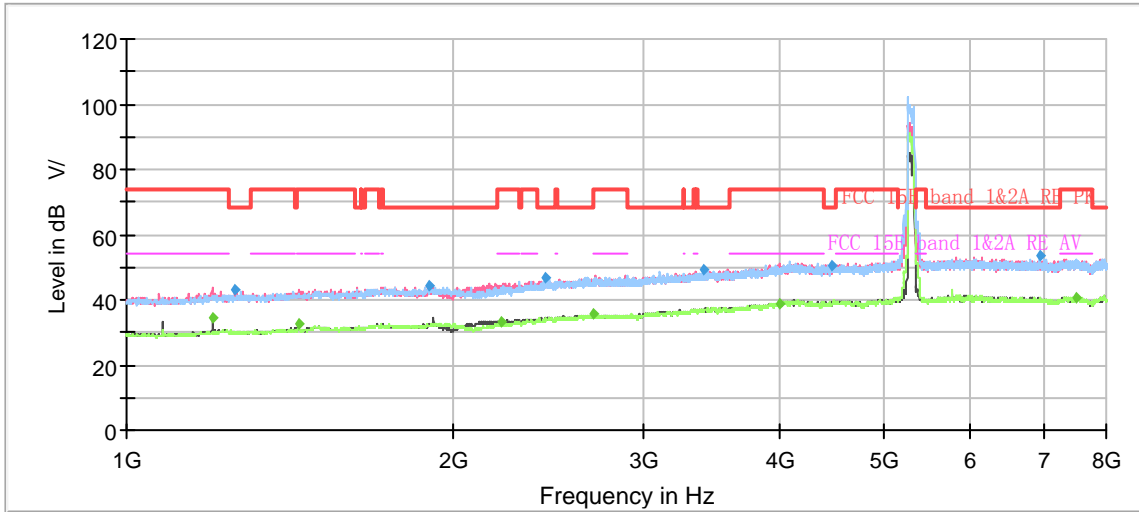

Note: The signal beyond the limit is carrier.  
Radiates Emission from 1GHz to 8GHz

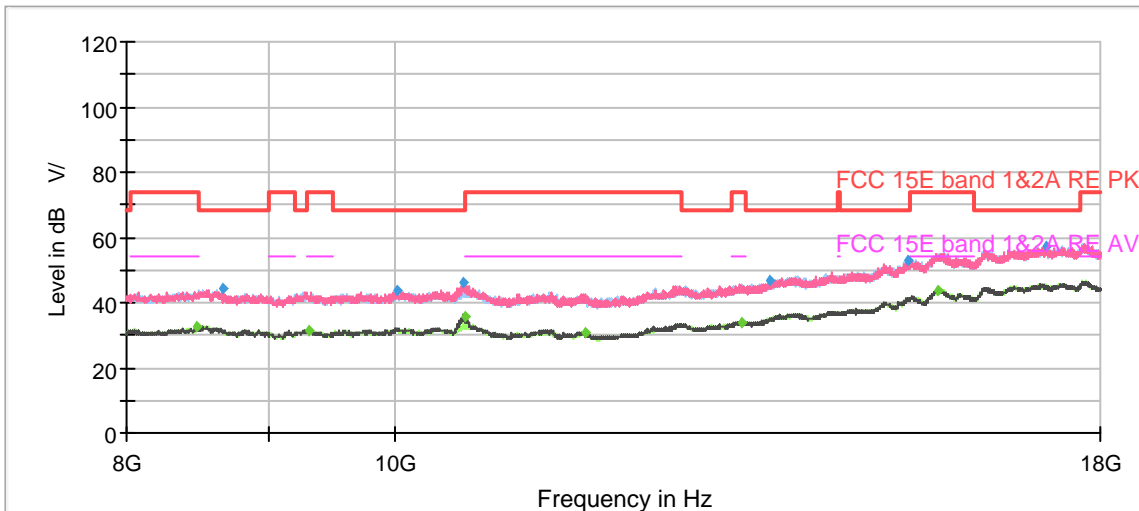

Radiates Emission from 8GHz to 18GHz



Frequency (MHz)	Peak (dBuV/m)	Average (dBuV/m)	Limit (dBuV/m)	Margin (dB)	Height (cm)	Polarization	Azimuth (deg)	Correct Factor (dB)
1199.50	---	34.24	54.00	19.76	200.0	V	10.00	-8
1259.88	42.85	---	68.20	25.35	200.0	V	0.00	-7
1440.13	---	32.55	54.00	21.45	100.0	V	0.00	-6
1896.88	44.07	---	68.20	24.13	100.0	V	234.00	-4
2218.88	---	33.29	54.00	20.71	100.0	V	79.00	-2
2433.25	47.00	---	68.20	21.20	200.0	V	75.00	-1
2696.63	---	35.47	54.00	18.53	200.0	V	70.00	1
3408.88	49.30	---	68.20	18.90	200.0	V	271.00	4
3999.50	---	38.82	54.00	15.18	100.0	H	3.00	6
4466.75	50.61	---	68.20	17.59	200.0	H	317.00	7
6938.63	53.43	---	68.20	14.77	100.0	H	47.00	11
7504.75	---	40.88	54.00	13.12	200.0	V	80.00	11

Remark: 1. Correction Factor = Antenna factor+ Insertion loss (cable loss + amplifier gain)

802.11ac (VHT80) CH106

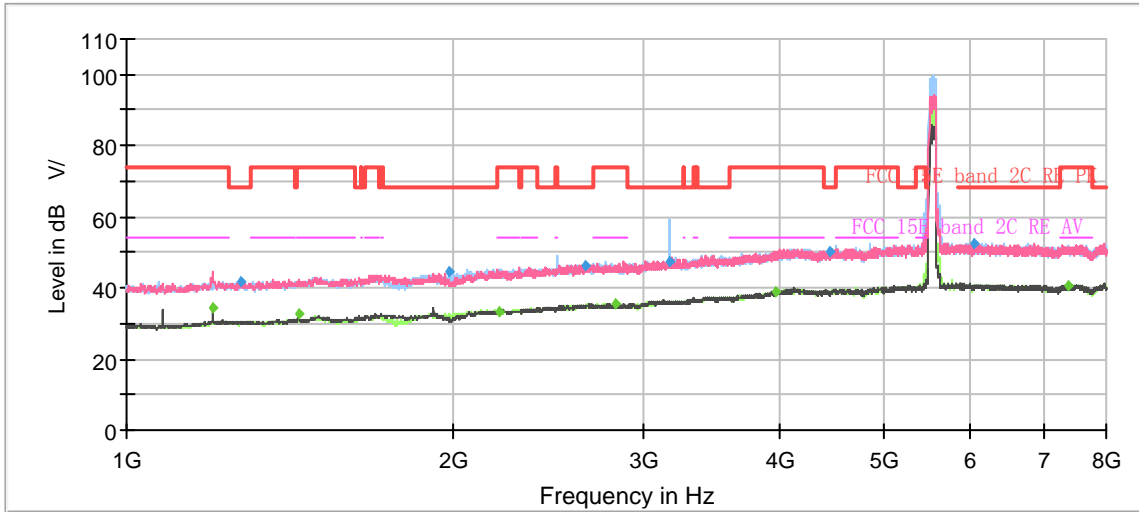

Note: The signal beyond the limit is carrier.  
Radiates Emission from 1GHz to 8GHz

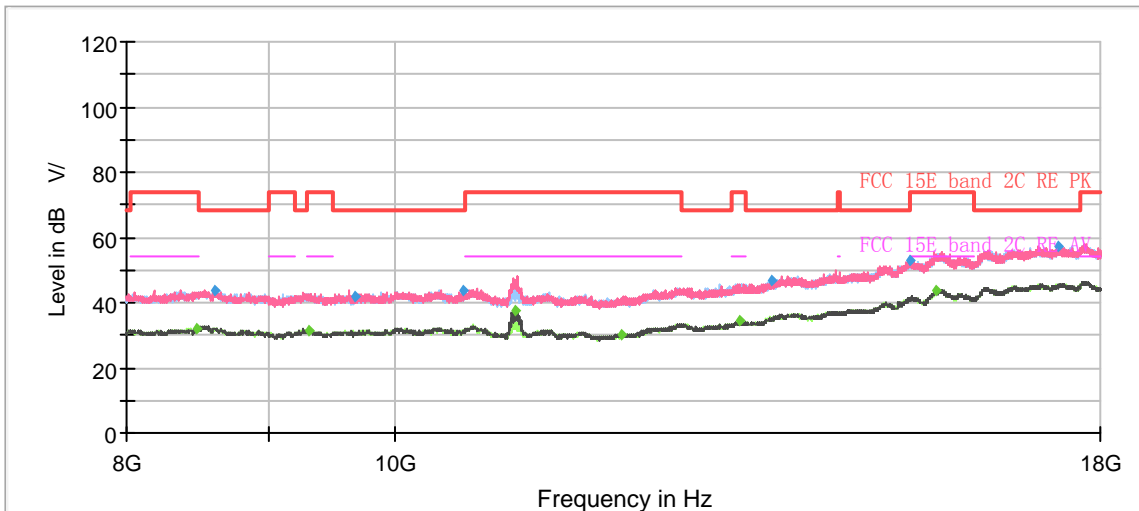

Radiates Emission from 8GHz to 18GHz





Frequency (MHz)	Peak (dBuV/m)	Average (dBuV/m)	Limit (dBuV/m)	Margin (dB)	Height (cm)	Polarization	Azimuth (deg)	Correct Factor (dB)
1199.50	---	34.46	54.00	19.54	200.0	V	338.00	-8
1276.50	41.93	---	68.20	26.27	200.0	V	283.00	-7
1440.13	---	32.94	54.00	21.06	100.0	V	246.00	-6
1987.00	44.61	---	68.20	23.59	100.0	H	320.00	-3
2210.13	---	33.42	54.00	20.58	200.0	H	35.00	-2
2647.63	46.50	---	68.20	21.70	100.0	V	15.00	0
2827.00	---	35.48	54.00	18.52	200.0	H	10.00	1
3167.38	47.23	---	68.20	20.97	200.0	V	298.00	2
3968.00	---	39.03	54.00	14.97	200.0	H	150.00	6
4457.13	50.16	---	68.20	18.04	100.0	V	0.00	7
6054.00	52.68	---	68.20	15.52	100.0	V	321.00	10
7391.00	---	40.86	54.00	13.14	100.0	V	0.00	11

Remark: 1. Correction Factor = Antenna factor+ Insertion loss (cable loss + amplifier gain)



802.11ac (VHT80) CH1138

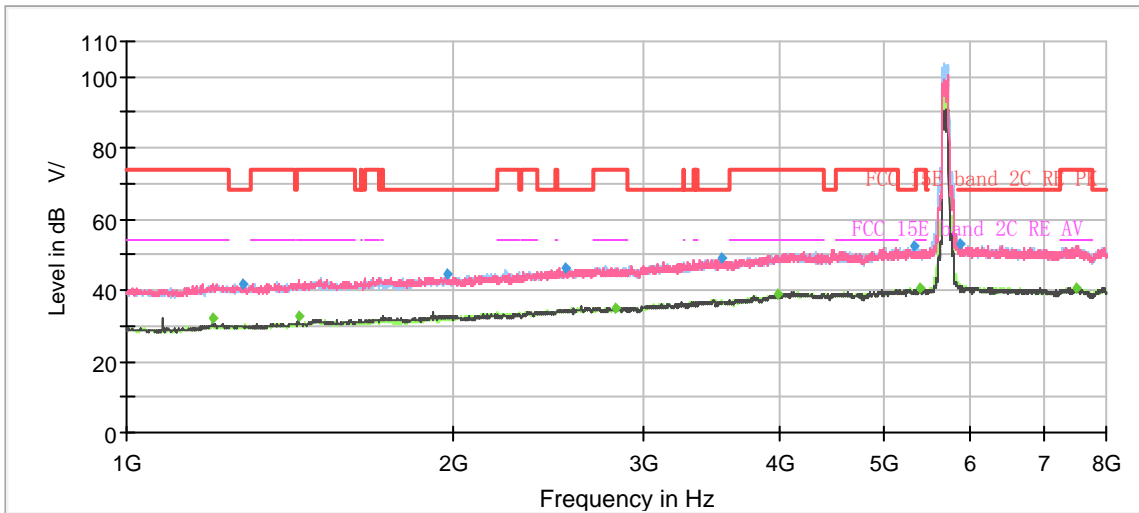

Note: The signal beyond the limit is carrier.  
Radiates Emission from 1GHz to 8GHz

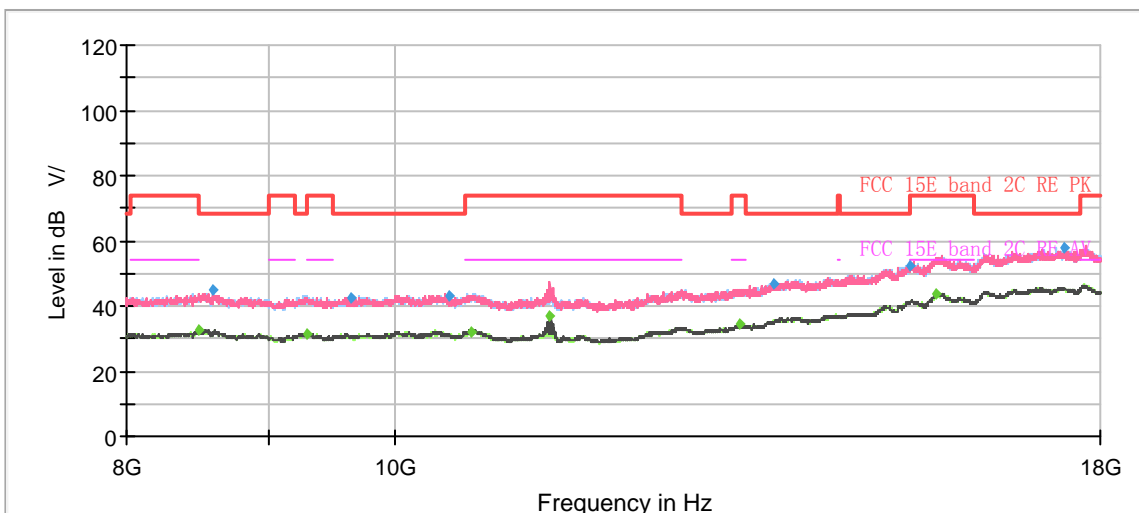

Radiates Emission from 8GHz to 18GHz



Frequency (MHz)	Peak (dBuV/m)	Average (dBuV/m)	Limit (dBuV/m)	Margin (dB)	Height (cm)	Polarization	Azimuth (deg)	Correct Factor (dB)
1199.50	---	31.98	54.00	22.02	200.0	V	17.00	-8
1280.88	41.75	---	68.20	26.45	200.0	V	112.00	-7
1440.13	---	32.83	54.00	21.17	200.0	V	306.00	-6
1976.50	44.29	---	68.20	23.91	100.0	V	29.00	-3
2535.63	46.13	---	68.20	22.07	100.0	V	287.00	0
2823.50	---	35.24	54.00	18.76	100.0	V	20.00	1
3535.75	49.15	---	68.20	19.05	100.0	V	277.00	4
3981.13	---	38.66	54.00	15.34	100.0	H	309.00	6
5315.50	52.32	---	68.20	15.88	100.0	V	160.00	9
5396.00	---	40.34	54.00	13.66	100.0	H	236.00	9
5863.25	53.11	---	68.20	15.09	200.0	H	351.00	10
7505.63	---	40.76	54.00	13.24	200.0	H	122.00	11

Remark: 1. Correction Factor = Antenna factor+ Insertion loss (cable loss + amplifier gain)

802.11ac (VHT80) CH155

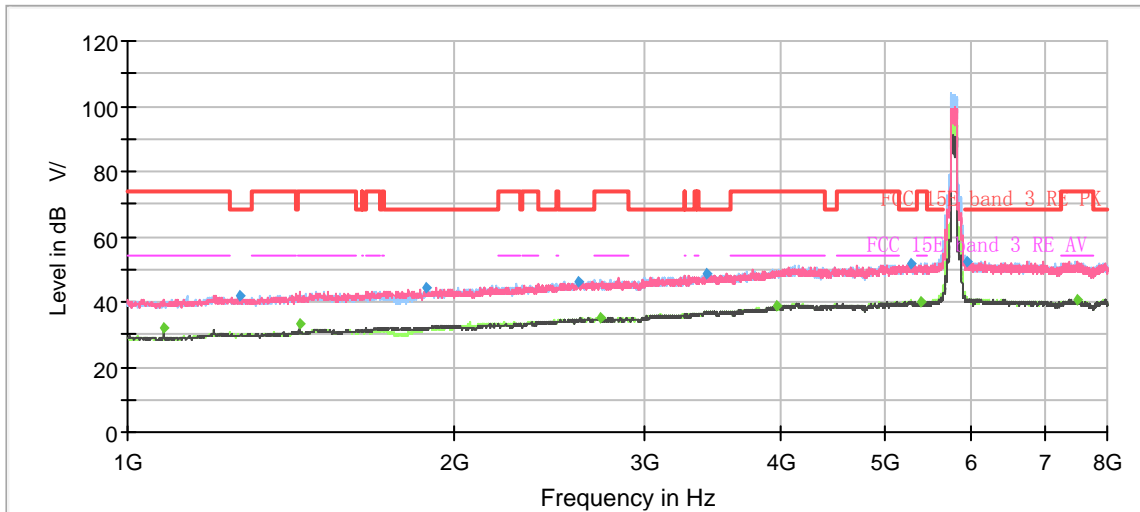

Note: The signal beyond the limit is carrier.  
Radiates Emission from 1GHz to 8GHz

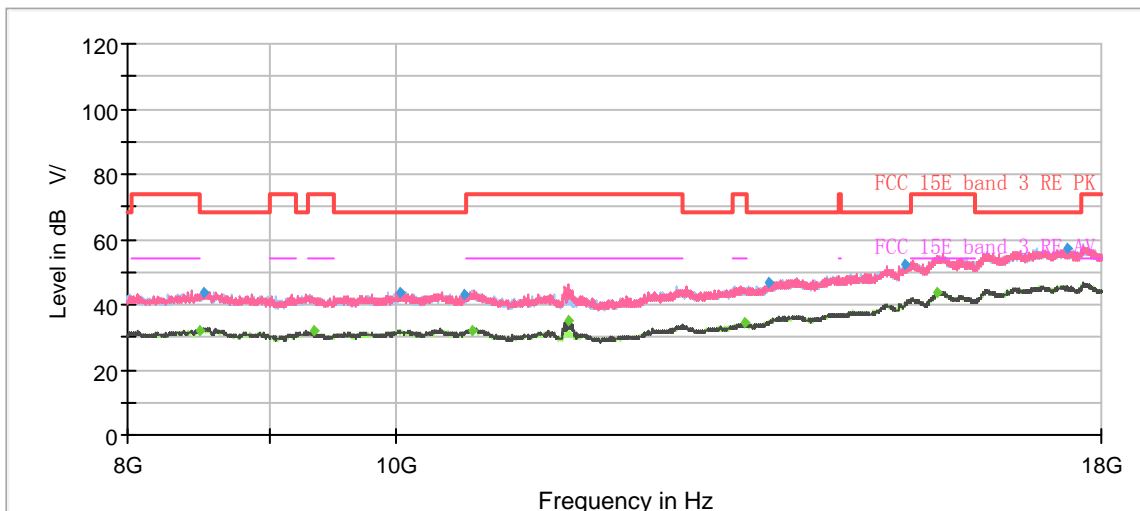

Radiates Emission from 8GHz to 18GHz



Frequency (MHz)	Peak (dBuV/m)	Average (dBuV/m)	Limit (dBuV/m)	Margin (dB)	Height (cm)	Polarization	Azimuth (deg)	Correct Factor (dB)
1079.63	---	32.20	54.00	21.80	100.0	V	287.00	-8
1267.75	41.68	---	68.20	26.52	200.0	V	164.00	-7
1440.13	---	33.07	54.00	20.93	100.0	V	162.00	-6
1888.13	44.24	---	68.20	23.96	200.0	H	100.00	-4
2608.25	46.05	---	68.20	22.15	100.0	H	0.00	0
2724.63	---	35.15	54.00	18.85	200.0	H	153.00	1
3415.00	48.88	---	68.20	19.32	100.0	H	345.00	4
3972.38	---	38.61	54.00	15.39	100.0	V	31.00	6
5277.00	51.76	---	68.20	16.44	200.0	V	328.00	9
5375.88	---	40.05	54.00	13.95	200.0	H	298.00	9
5938.50	52.53	---	68.20	15.67	200.0	H	0.00	10
7497.75	---	40.63	54.00	13.37	200.0	H	256.00	11

Remark: 1. Correction Factor = Antenna factor+ Insertion loss (cable loss + amplifier gain)



802.11ax (HE20) CH36

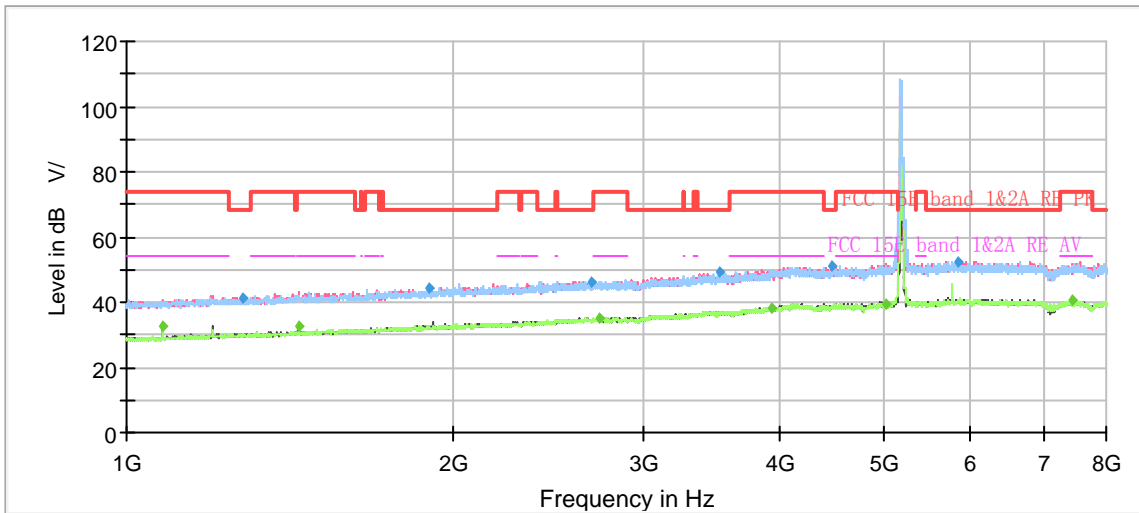

Note: The signal beyond the limit is carrier.  
Radiates Emission from 1GHz to 8GHz

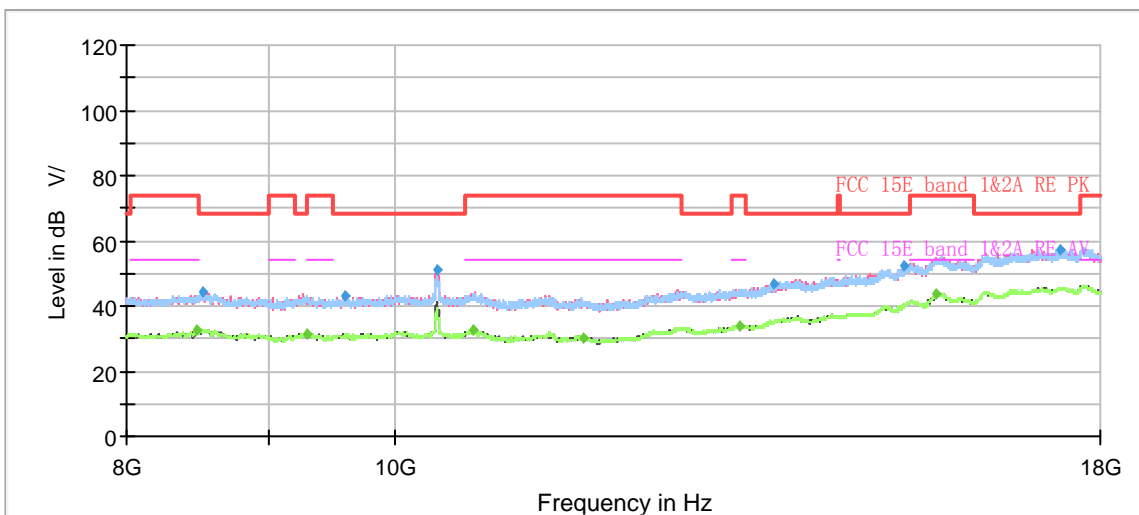

Radiates Emission from 8GHz to 18GHz



Frequency (MHz)	Peak (dBuV/m)	Average (dBuV/m)	Limit (dBuV/m)	Margin (dB)	Height (cm)	Polarization	Azimuth (deg)	Correct Factor (dB)
1079.63	---	32.48	54.00	21.52	100.0	V	263.00	-8
1280.00	41.41	---	68.20	26.79	200.0	V	31.00	-7
1440.13	---	32.56	54.00	21.44	100.0	V	151.00	-6
1896.88	44.50	---	68.20	23.70	100.0	V	258.00	-4
2682.63	46.30	---	68.20	21.90	200.0	H	220.00	0
2725.50	---	35.36	54.00	18.64	100.0	V	105.00	1
3527.00	49.15	---	68.20	19.05	100.0	V	258.00	4
3937.38	---	38.46	54.00	15.54	200.0	V	286.00	6
4472.00	50.90	---	68.20	17.30	200.0	V	296.00	7
5017.13	---	39.63	54.00	14.37	100.0	V	7.00	9
5849.25	52.56	---	68.20	15.64	100.0	H	270.00	10
7447.00	---	40.36	54.00	13.64	200.0	V	330.00	11

Remark: 1. Correction Factor = Antenna factor+ Insertion loss (cable loss + amplifier gain)



802.11ax (HE20) CH40

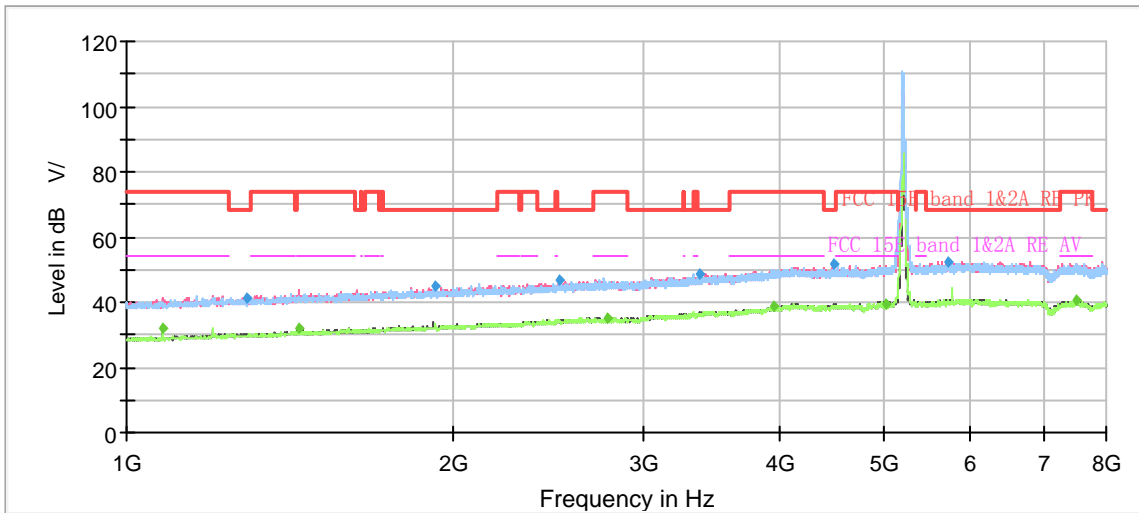

Note: The signal beyond the limit is carrier.  
Radiates Emission from 1GHz to 8GHz

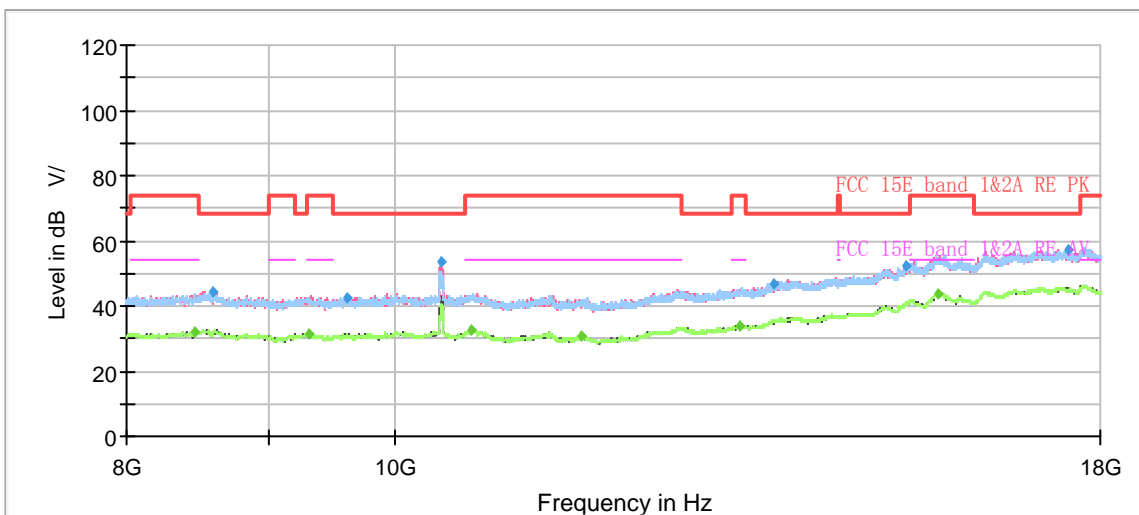

Radiates Emission from 8GHz to 18GHz





Frequency (MHz)	Peak (dBuV/m)	Average (dBuV/m)	Limit (dBuV/m)	Margin (dB)	Height (cm)	Polarization	Azimuth (deg)	Correct Factor (dB)
1079.63	---	32.09	54.00	21.91	200.0	V	307.00	-8
1293.13	41.42	---	68.20	26.78	100.0	V	137.00	-7
1440.13	---	32.24	54.00	21.76	100.0	V	158.00	-6
1928.38	44.67	---	68.20	23.53	100.0	H	219.00	-3
2501.50	46.75	---	68.20	21.45	100.0	H	214.00	0
2778.00	---	35.10	54.00	18.90	100.0	V	0.00	1
3379.13	48.79	---	68.20	19.41	200.0	V	233.00	3
3941.75	---	38.56	54.00	15.44	100.0	V	61.00	6
4483.38	51.46	---	68.20	16.74	200.0	V	36.00	7
5021.50	---	39.67	54.00	14.33	100.0	H	197.00	9
5725.00	52.41	---	68.20	15.79	100.0	H	83.00	10
7494.25	---	40.44	54.00	13.56	200.0	V	265.00	11

Remark: 1. Correction Factor = Antenna factor+ Insertion loss (cable loss + amplifier gain)



802.11ax (HE20) CH48

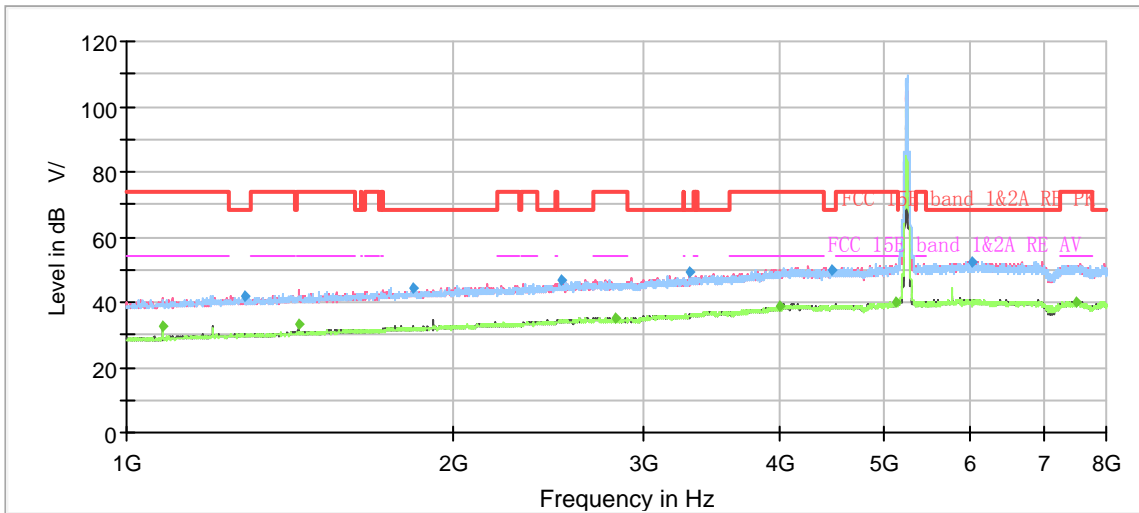

Note: The signal beyond the limit is carrier.  
Radiates Emission from 1GHz to 8GHz

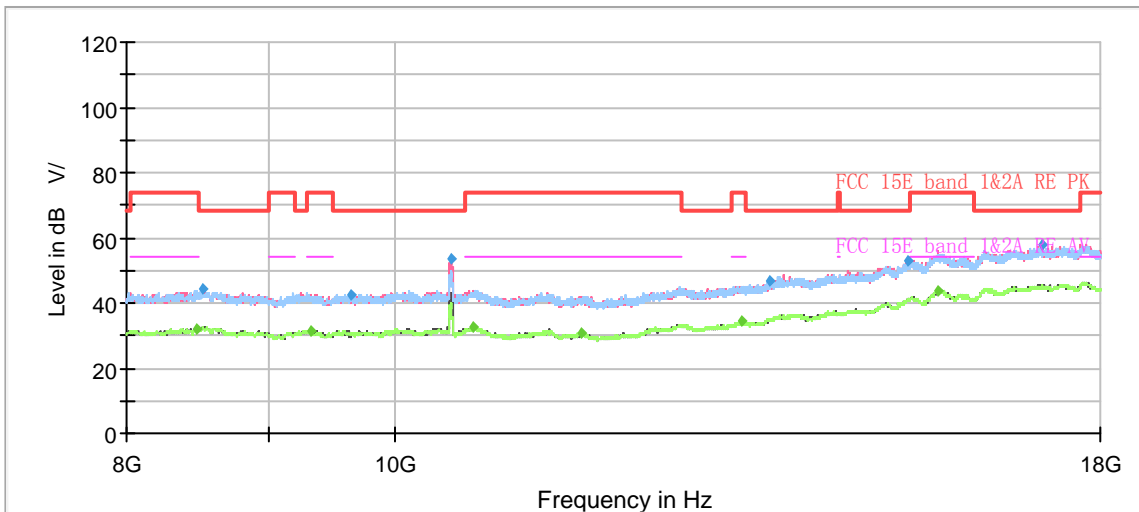

Radiates Emission from 8GHz to 18GHz



Frequency (MHz)	Peak (dBuV/m)	Average (dBuV/m)	Limit (dBuV/m)	Margin (dB)	Height (cm)	Polarization	Azimuth (deg)	Correct Factor (dB)
1079.63	---	32.82	54.00	21.18	100.0	V	134.00	-8
1282.63	41.67	---	68.20	26.53	100.0	H	321.00	-7
1440.13	---	33.20	54.00	20.80	100.0	V	251.00	-6
1835.63	44.45	---	68.20	23.75	100.0	V	123.00	-4
2518.13	46.92	---	68.20	21.28	200.0	V	334.00	0
2823.50	---	35.04	54.00	18.96	100.0	V	94.00	1
3305.63	49.15	---	68.20	19.05	100.0	V	286.00	3
3997.75	---	38.65	54.00	15.35	100.0	V	327.00	6
4472.00	49.71	---	68.20	18.49	100.0	H	262.00	7
5124.75	---	40.16	54.00	13.84	200.0	H	1.00	9
6021.63	52.59	---	68.20	15.61	200.0	V	259.00	10
7490.75	---	40.22	54.00	13.78	200.0	V	159.00	11

Remark: 1. Correction Factor = Antenna factor+ Insertion loss (cable loss + amplifier gain)



802.11ax (HE20) CH52

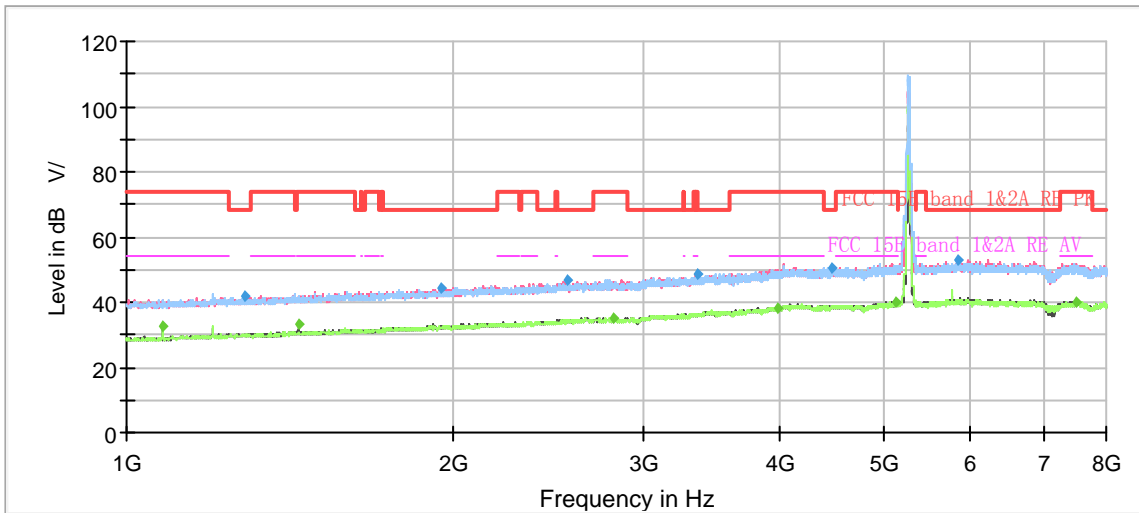

Note: The signal beyond the limit is carrier.  
Radiates Emission from 1GHz to 8GHz

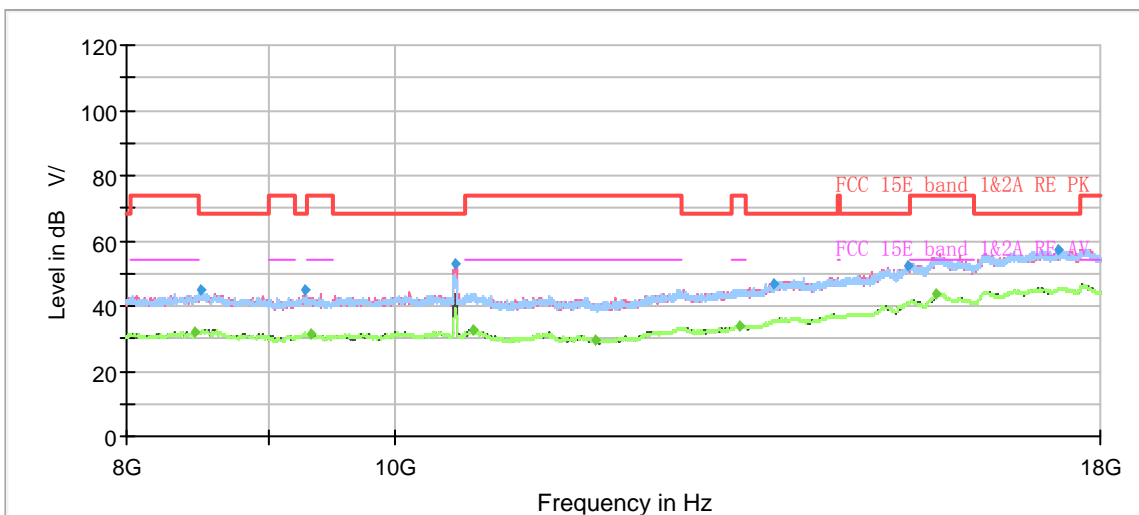

Radiates Emission from 8GHz to 18GHz



Frequency (MHz)	Peak (dBuV/m)	Average (dBuV/m)	Limit (dBuV/m)	Margin (dB)	Height (cm)	Polarization	Azimuth (deg)	Correct Factor (dB)
1079.63	---	32.52	54.00	21.48	100.0	V	270.00	-8
1286.13	41.97	---	68.20	26.23	200.0	H	118.00	-7
1440.13	---	32.93	54.00	21.07	100.0	V	250.00	-6
1950.25	44.21	---	68.20	23.99	100.0	V	335.00	-3
2552.25	46.55	---	68.20	21.65	200.0	V	44.00	0
2809.50	---	35.11	54.00	18.89	100.0	V	194.00	1
3362.50	48.82	---	68.20	19.38	100.0	V	72.00	3
3982.00	---	38.39	54.00	15.61	100.0	V	290.00	6
4467.63	50.23	---	68.20	17.97	100.0	V	349.00	7
5126.50	---	40.10	54.00	13.90	200.0	V	314.00	9
5840.50	53.23	---	68.20	14.97	200.0	V	340.00	10
7503.88	---	40.16	54.00	13.84	200.0	H	182.00	11

Remark: 1. Correction Factor = Antenna factor+ Insertion loss (cable loss + amplifier gain)



802.11ax (HE20) CH60

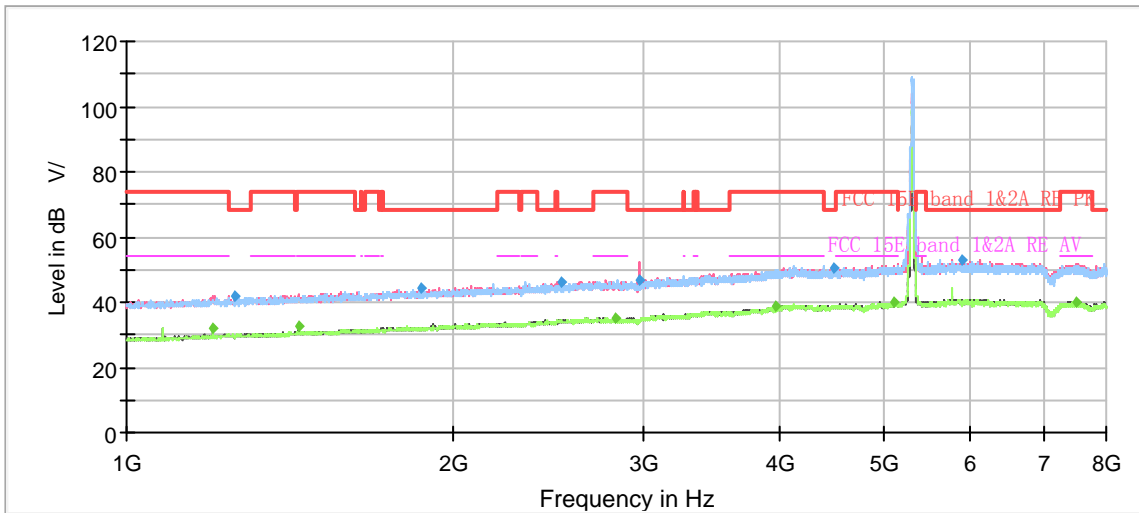

Note: The signal beyond the limit is carrier.  
Radiates Emission from 1GHz to 8GHz

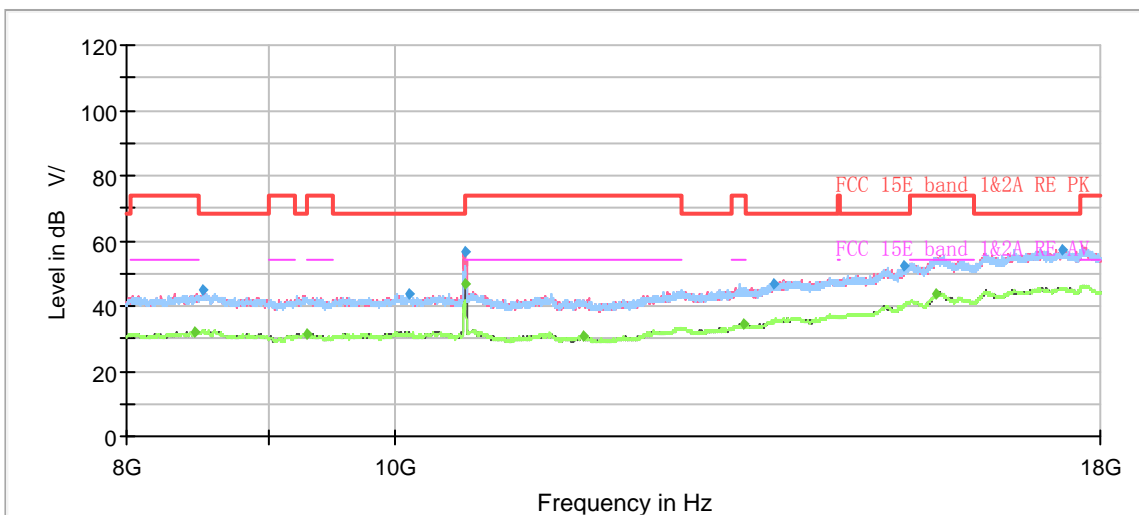

Radiates Emission from 8GHz to 18GHz



Frequency (MHz)	Peak (dBuV/m)	Average (dBuV/m)	Limit (dBuV/m)	Margin (dB)	Height (cm)	Polarization	Azimuth (deg)	Correct Factor (dB)
1199.50	---	31.94	54.00	22.06	200.0	V	0.00	-8
1259.00	41.64	---	68.20	26.56	200.0	V	54.00	-7
1440.13	---	32.65	54.00	21.35	100.0	V	284.00	-6
1872.38	44.47	---	68.20	23.73	200.0	H	240.00	-4
2516.38	46.28	---	68.20	21.92	100.0	V	353.00	0
2821.75	---	35.09	54.00	18.91	100.0	V	314.00	1
2966.13	47.03	---	68.20	21.17	100.0	V	108.00	1
3962.75	---	38.47	54.00	15.53	100.0	V	194.00	6
4483.38	50.25	---	68.20	17.95	100.0	V	333.00	7
5107.25	---	39.74	54.00	14.26	200.0	V	98.00	9
5893.00	52.69	---	68.20	15.51	200.0	V	54.00	10
7489.88	---	40.09	54.00	13.91	100.0	V	103.00	11

Remark: 1. Correction Factor = Antenna factor+ Insertion loss (cable loss + amplifier gain)



802.11ax (HE20) CH64

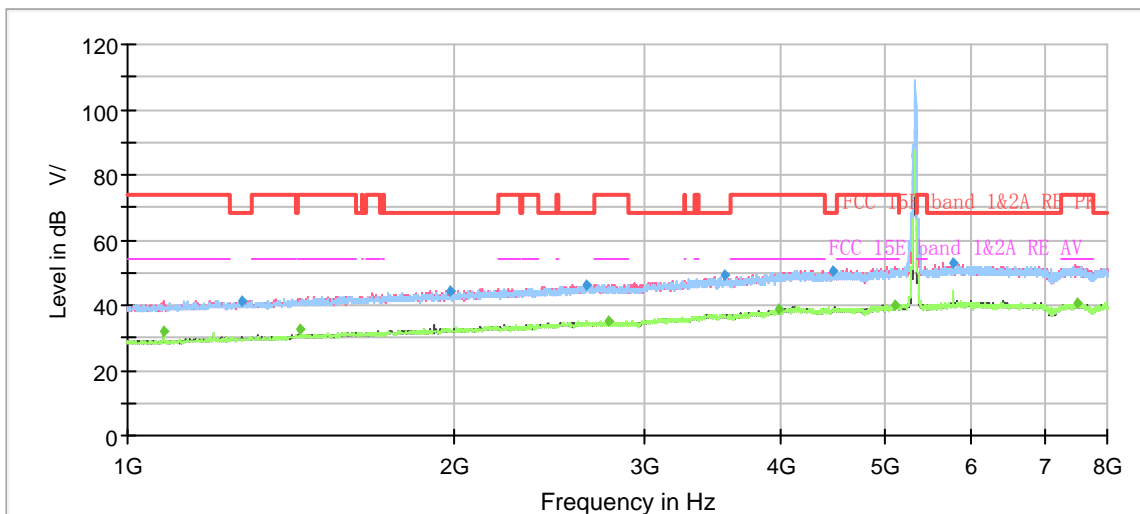

Note: The signal beyond the limit is carrier.  
Radiates Emission from 1GHz to 8GHz

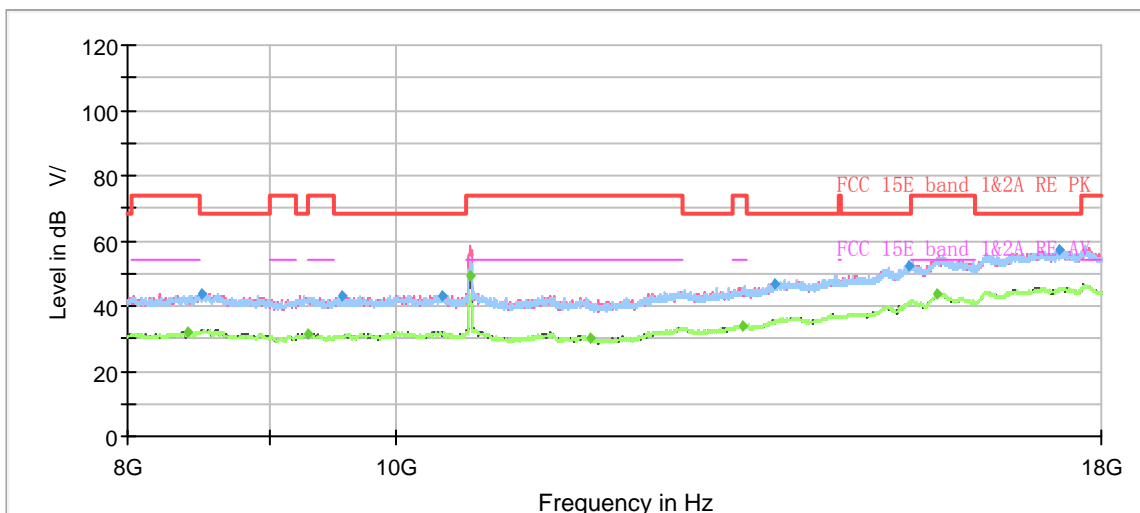

Radiates Emission from 8GHz to 18GHz





Frequency (MHz)	Peak (dBuV/m)	Average (dBuV/m)	Limit (dBuV/m)	Margin (dB)	Height (cm)	Polarization	Azimuth (deg)	Correct Factor (dB)
1079.63	---	31.83	54.00	22.17	200.0	V	35.00	-8
1273.00	41.48	---	68.20	26.72	200.0	H	180.00	-7
1440.13	---	32.44	54.00	21.56	200.0	V	316.00	-6
1979.13	44.45	---	68.20	23.75	100.0	V	254.00	-3
2646.75	46.28	---	68.20	21.92	200.0	H	87.00	0
2776.25	---	34.93	54.00	19.07	100.0	H	198.00	1
3552.38	49.05	---	68.20	19.15	100.0	V	168.00	4
3987.25	---	38.48	54.00	15.52	200.0	V	94.00	6
4468.50	50.19	---	68.20	18.01	200.0	V	257.00	7
5104.63	---	39.74	54.00	14.26	200.0	V	0.00	9
5760.00	52.96	---	68.20	15.24	200.0	H	340.00	10
7508.25	---	40.51	54.00	13.49	200.0	V	340.00	11

Remark: 1. Correction Factor = Antenna factor+ Insertion loss (cable loss + amplifier gain)



802.11ax (HE20) CH100

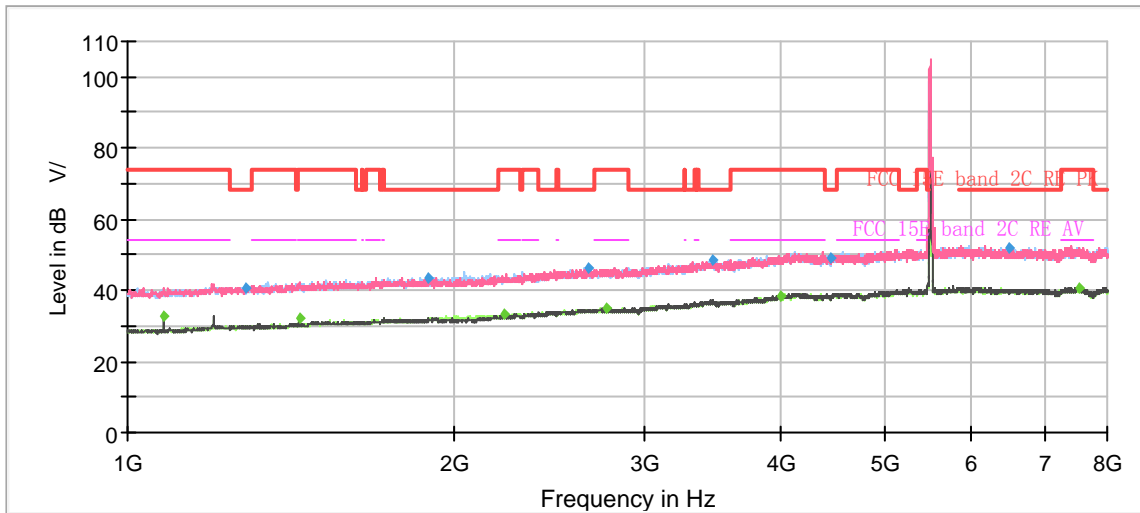

Note: The signal beyond the limit is carrier.  
Radiates Emission from 1GHz to 8GHz

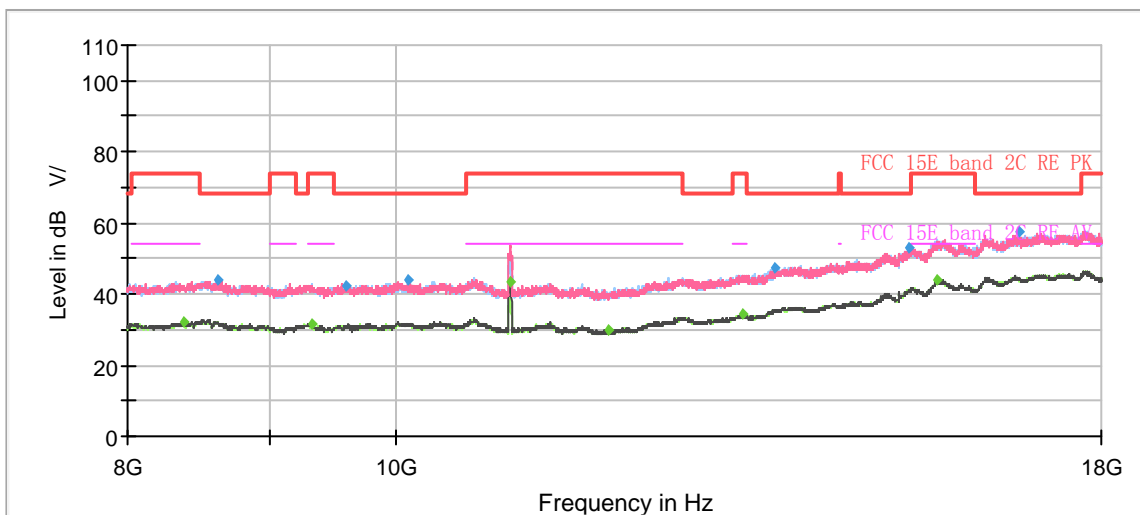

Radiates Emission from 8GHz to 18GHz



Frequency (MHz)	Peak (dBuV/m)	Average (dBuV/m)	Limit (dBuV/m)	Margin (dB)	Height (cm)	Polarization	Azimuth (deg)	Correct Factor (dB)
1079.63	---	32.72	54.00	21.28	200.0	V	105.00	-8
1282.63	40.83	---	68.20	27.37	200.0	V	48.00	-7
1439.25	---	32.40	54.00	21.60	100.0	V	54.00	-6
1893.38	43.63	---	68.20	24.57	100.0	H	58.00	-4
2222.38	---	33.33	54.00	20.67	200.0	H	315.00	-2
2655.50	46.52	---	68.20	21.68	200.0	H	237.00	0
2759.63	---	34.88	54.00	19.12	100.0	V	0.00	1
3464.88	48.44	---	68.20	19.76	200.0	V	32.00	4
3995.13	---	38.34	54.00	15.66	100.0	H	34.00	6
4457.13	49.17	---	68.20	19.03	100.0	H	135.00	7
6483.63	51.76	---	68.20	16.44	100.0	H	255.00	10
7528.38	---	40.80	54.00	13.20	100.0	H	212.00	11

Remark: 1. Correction Factor = Antenna factor+ Insertion loss (cable loss + amplifier gain)



802.11ax (HE20) CH116

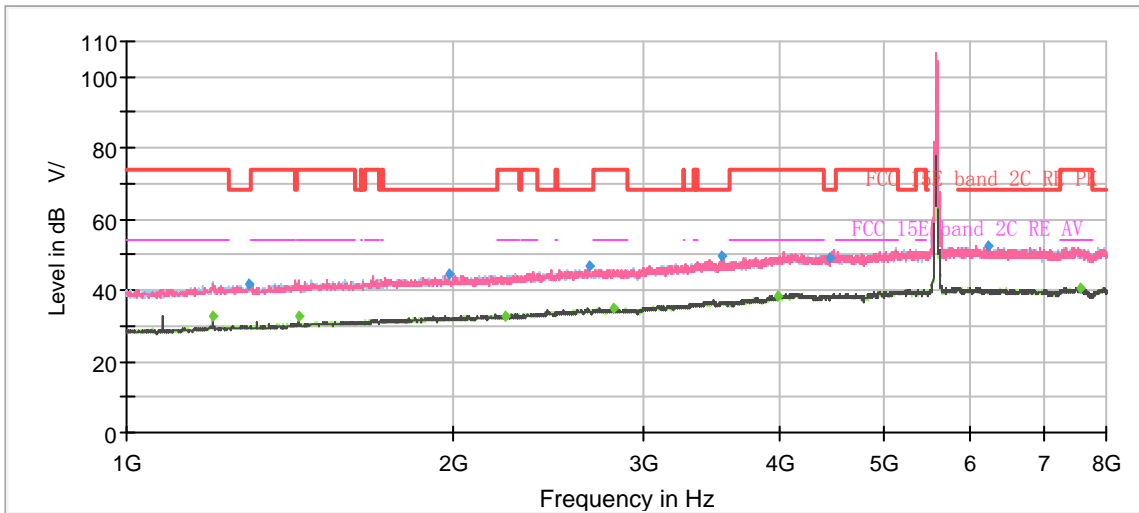

Note: The signal beyond the limit is carrier.  
Radiates Emission from 1GHz to 8GHz

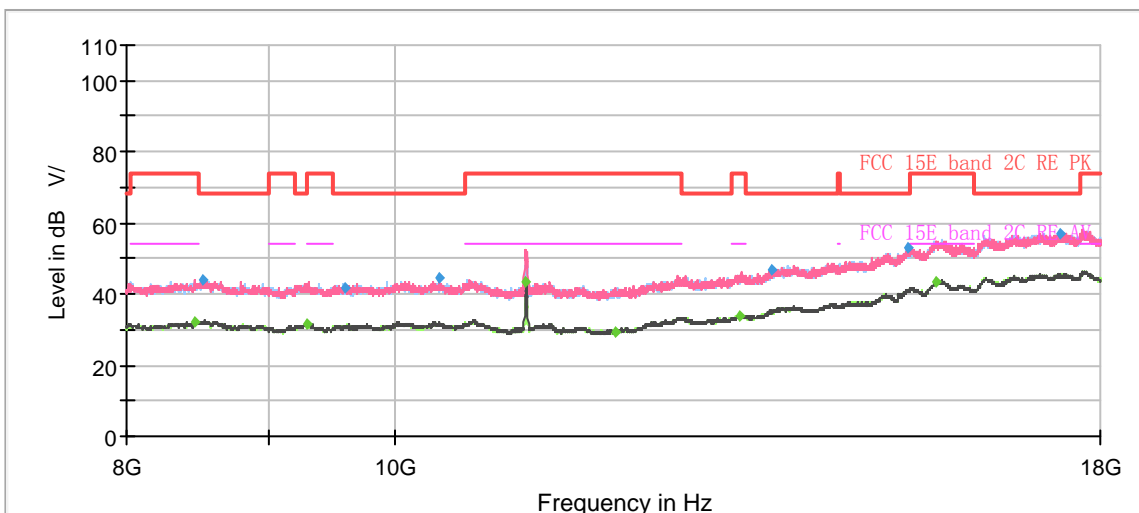

Radiates Emission from 8GHz to 18GHz



Frequency (MHz)	Peak (dBuV/m)	Average (dBuV/m)	Limit (dBuV/m)	Margin (dB)	Height (cm)	Polarization	Azimuth (deg)	Correct Factor (dB)
1199.50	---	32.87	54.00	21.13	100.0	V	142.00	-8
1294.00	41.77	---	68.20	26.43	200.0	V	152.00	-7
1440.13	---	32.71	54.00	21.29	100.0	V	211.00	-6
1984.38	44.48	---	68.20	23.72	100.0	V	289.00	-3
2232.88	---	32.65	54.00	21.35	100.0	H	320.00	-2
2672.13	46.64	---	68.20	21.56	100.0	V	240.00	0
2813.88	---	35.10	54.00	18.90	100.0	V	98.00	1
3532.25	49.49	---	68.20	18.71	100.0	V	294.00	4
3986.38	---	38.21	54.00	15.79	100.0	V	344.00	6
4440.50	49.21	---	68.20	18.99	100.0	H	117.00	7
6219.38	52.45	---	68.20	15.75	200.0	H	171.00	10
7554.63	---	40.56	54.00	13.44	100.0	V	299.00	11

Remark: 1. Correction Factor = Antenna factor+ Insertion loss (cable loss + amplifier gain)



802.11ax (HE20) CH140

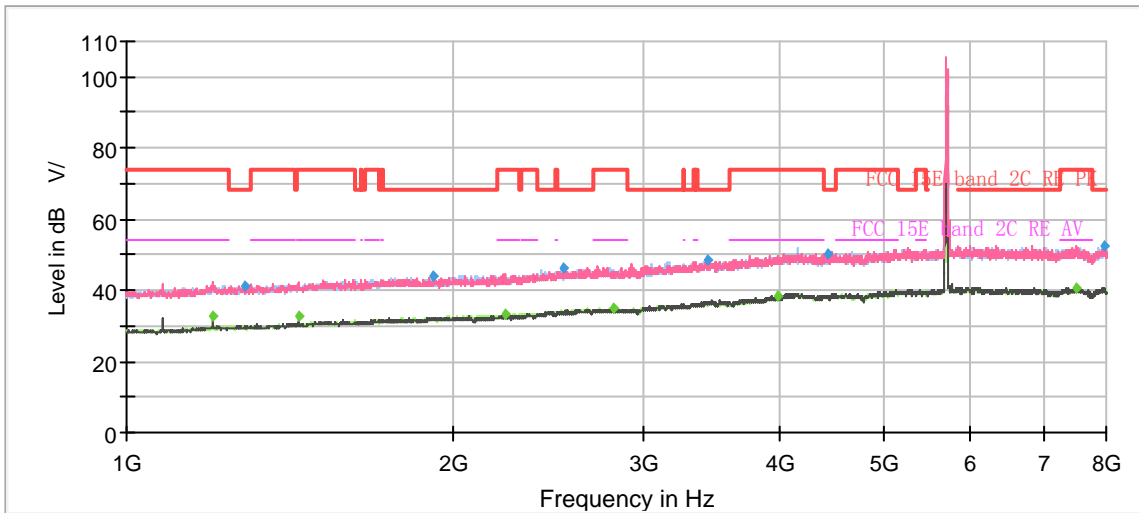

Note: The signal beyond the limit is carrier.  
Radiates Emission from 1GHz to 8GHz

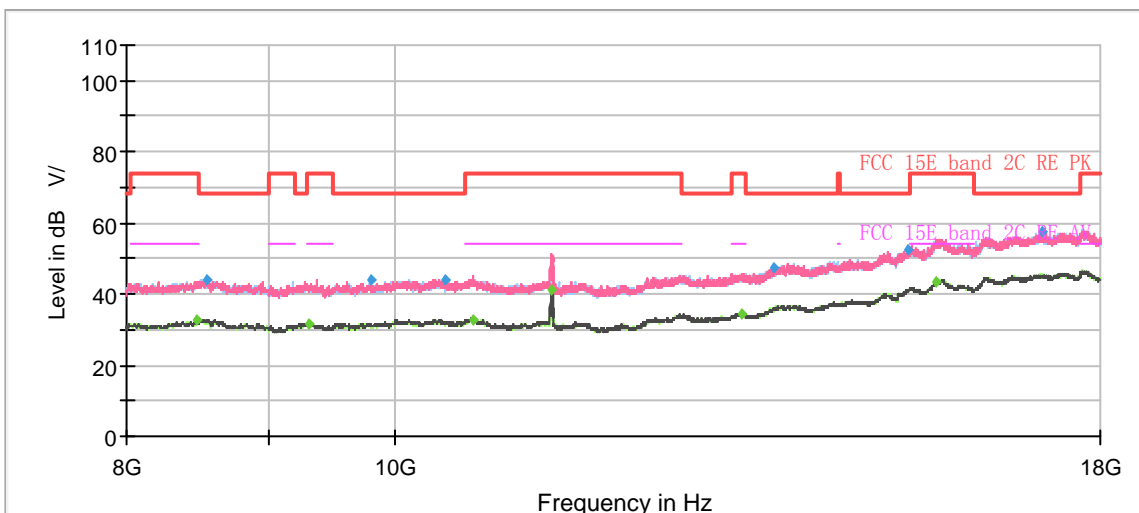

Radiates Emission from 8GHz to 18GHz



Frequency (MHz)	Peak (dBuV/m)	Average (dBuV/m)	Limit (dBuV/m)	Margin (dB)	Height (cm)	Polarization	Azimuth (deg)	Correct Factor (dB)
1199.50	---	32.82	54.00	21.18	100.0	V	140.00	-8
1284.38	41.26	---	68.20	26.94	100.0	V	303.00	-7
1440.13	---	32.96	54.00	21.04	100.0	H	142.00	-6
1919.63	43.72	---	68.20	24.48	100.0	V	131.00	-3
2235.50	---	33.07	54.00	20.93	100.0	H	69.00	-2
2529.50	46.38	---	68.20	21.82	100.0	H	321.00	0
2809.50	---	35.02	54.00	18.98	100.0	V	316.00	1
3433.38	48.47	---	68.20	19.73	100.0	V	0.00	4
3988.13	---	38.28	54.00	15.72	100.0	V	212.00	6
4434.38	49.97	---	68.20	18.23	200.0	H	289.00	7
7501.25	---	40.60	54.00	13.40	200.0	V	149.00	11
7958.88	52.50	---	68.20	15.70	100.0	V	289.00	12

**Remark: 1. Correction Factor = Antenna factor+ Insertion loss (cable loss + amplifier gain)**



802.11ax (HE20) CH144

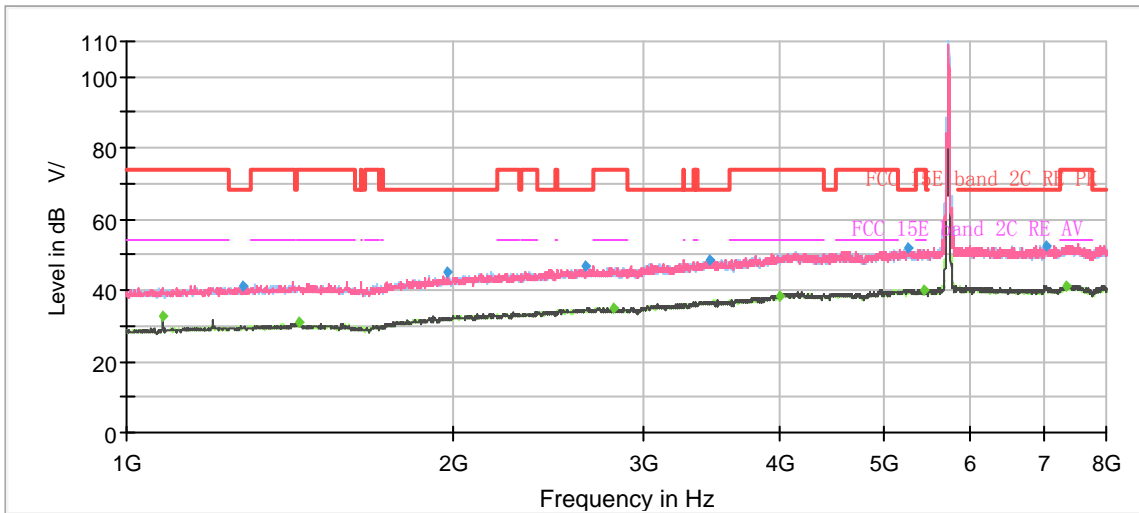

Note: The signal beyond the limit is carrier.  
Radiates Emission from 1GHz to 8GHz

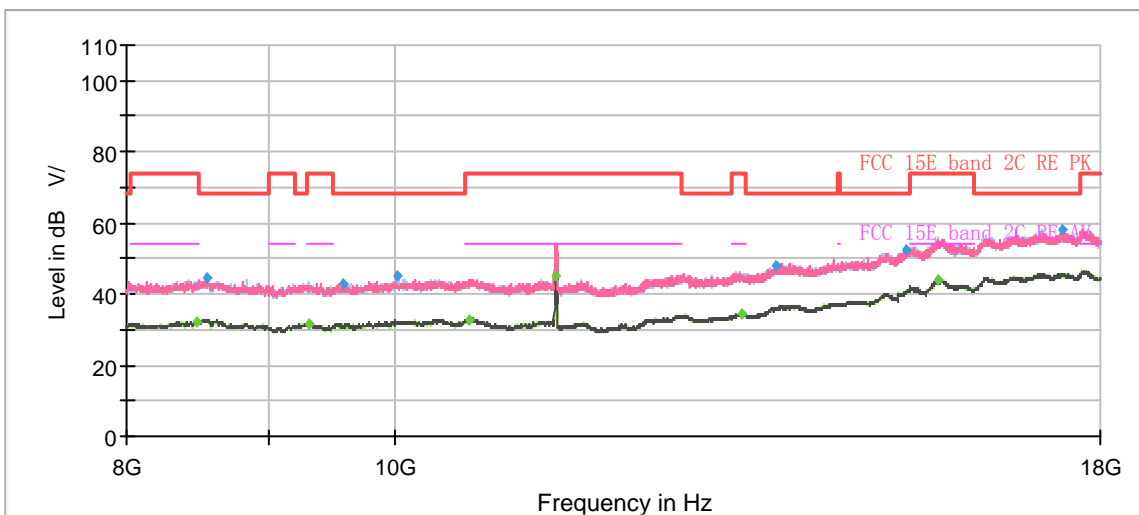

Radiates Emission from 8GHz to 18GHz





Frequency (MHz)	Peak (dBuV/m)	Average (dBuV/m)	Limit (dBuV/m)	Margin (dB)	Height (cm)	Polarization	Azimuth (deg)	Correct Factor (dB)
1079.63	---	32.58	54.00	21.42	200.0	H	332.00	-8
1281.75	41.14	---	68.20	27.06	100.0	V	278.00	-7
1440.13	---	30.94	54.00	23.06	200.0	V	152.00	-6
1978.25	44.90	---	68.20	23.30	100.0	V	66.00	-3
2648.50	46.57	---	68.20	21.63	200.0	V	289.00	0
2813.88	---	35.23	54.00	18.77	100.0	V	333.00	1
3450.00	48.77	---	68.20	19.43	200.0	H	232.00	4
3998.63	---	38.59	54.00	15.41	100.0	V	173.00	6
5249.88	51.82	---	68.20	16.38	100.0	V	121.00	9
5441.50	---	40.23	54.00	13.77	100.0	V	306.00	9
7034.88	52.65	---	68.20	15.55	100.0	H	83.00	11
7356.00	---	41.20	54.00	12.80	100.0	H	154.00	11

Remark: 1. Correction Factor = Antenna factor+ Insertion loss (cable loss + amplifier gain)



802.11ax (HE20) CH149

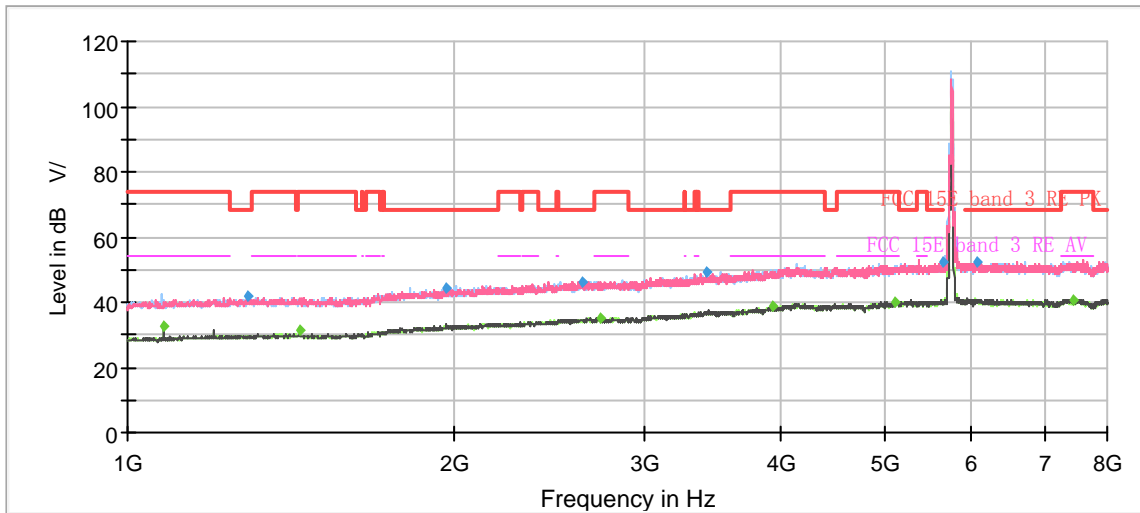

Note: The signal beyond the limit is carrier.  
Radiates Emission from 1GHz to 8GHz

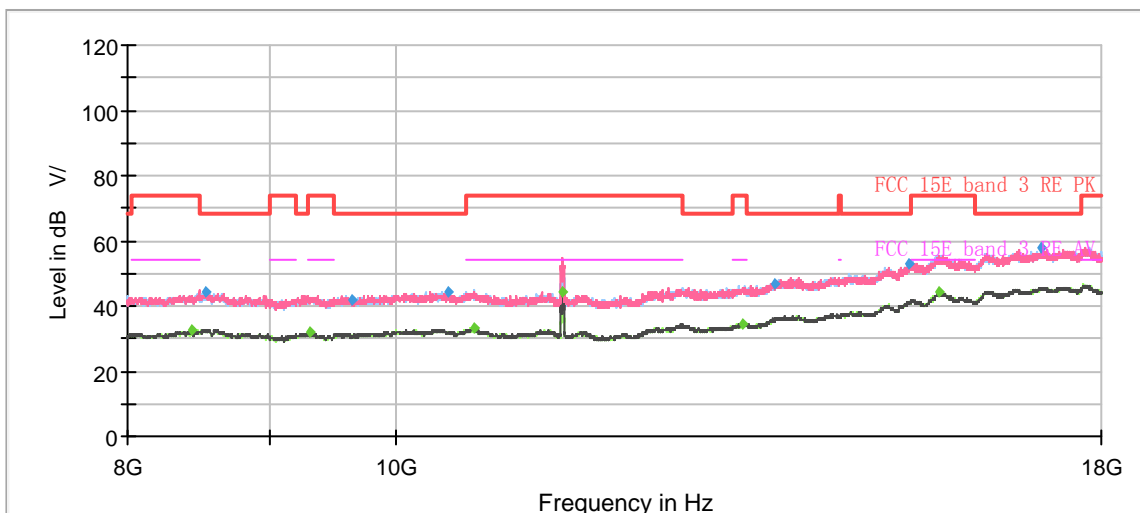

Radiates Emission from 8GHz to 18GHz



Frequency (MHz)	Peak (dBuV/m)	Average (dBuV/m)	Limit (dBuV/m)	Margin (dB)	Height (cm)	Polarization	Azimuth (deg)	Correct Factor (dB)
1079.63	---	32.38	54.00	21.62	200.0	H	322.00	-8
1292.25	41.70	---	68.20	26.50	200.0	H	125.00	-7
1440.13	---	31.42	54.00	22.58	200.0	V	283.00	-6
1968.63	44.13	---	68.20	24.07	100.0	H	204.00	-3
2623.13	46.41	---	68.20	21.79	200.0	V	0.00	0
2725.50	---	35.06	54.00	18.94	200.0	H	326.00	1
3417.63	49.26	---	68.20	18.94	100.0	V	260.00	4
3940.00	---	38.50	54.00	15.50	100.0	V	130.00	6
5107.25	---	40.11	54.00	13.89	200.0	V	125.00	9
5634.00	52.21	---	68.20	15.99	200.0	V	298.00	10
6079.38	52.54	---	68.20	15.66	200.0	V	139.00	10
7440.88	---	40.81	54.00	13.19	100.0	H	28.00	11

Remark: 1. Correction Factor = Antenna factor+ Insertion loss (cable loss + amplifier gain)



802.11ax (HE20) CH157

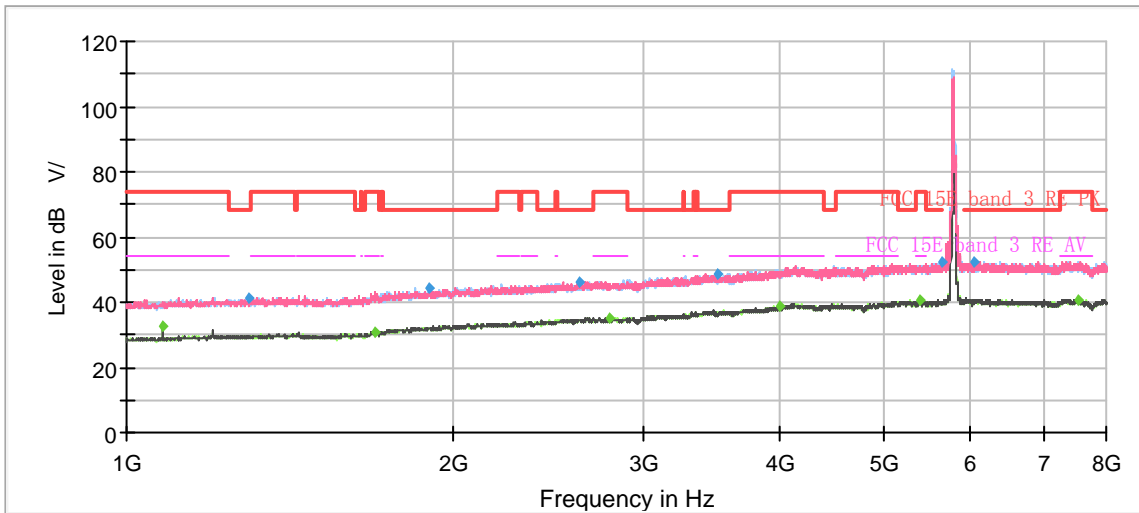

Note: The signal beyond the limit is carrier.  
Radiates Emission from 1GHz to 8GHz

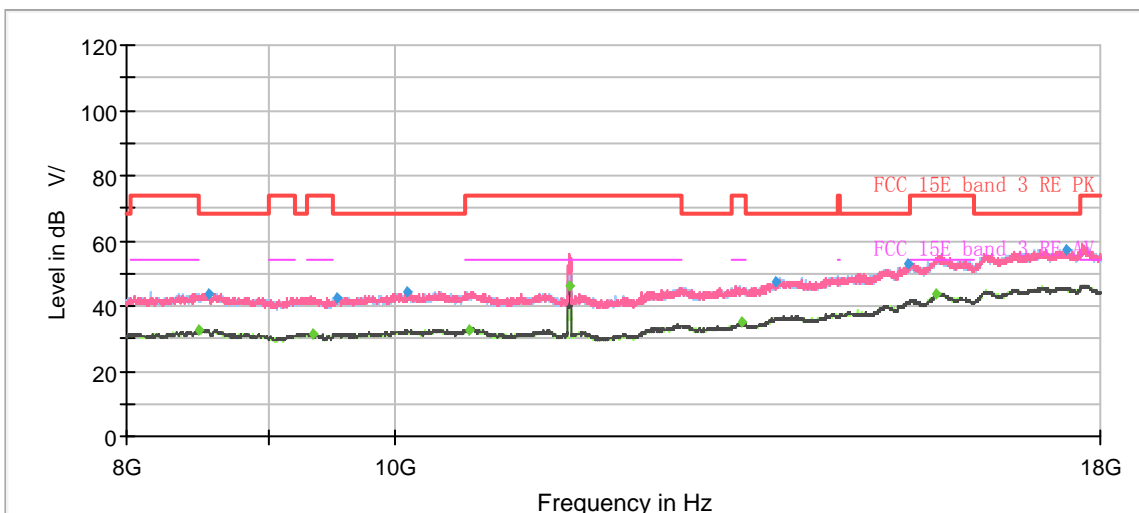

Radiates Emission from 8GHz to 18GHz



Frequency (MHz)	Peak (dBuV/m)	Average (dBuV/m)	Limit (dBuV/m)	Margin (dB)	Height (cm)	Polarization	Azimuth (deg)	Correct Factor (dB)
1079.63	---	32.56	54.00	21.44	200.0	H	327.00	-8
1294.88	41.44	---	68.20	26.76	200.0	H	298.00	-7
1696.50	---	30.87	54.00	23.13	100.0	V	192.00	-5
1903.88	44.14	---	68.20	24.06	200.0	H	317.00	-4
2619.63	46.44	---	68.20	21.76	100.0	H	184.00	0
2781.50	---	34.89	54.00	19.11	100.0	V	65.00	1
3507.75	48.76	---	68.20	19.44	100.0	V	341.00	4
3995.13	---	38.65	54.00	15.35	200.0	V	161.00	6
5382.88	---	40.44	54.00	13.56	200.0	H	109.00	9
5646.25	52.26	---	68.20	15.94	100.0	H	179.00	10
6040.00	52.55	---	68.20	15.65	100.0	V	234.00	10
7531.00	---	40.75	54.00	13.25	200.0	V	67.00	11

Remark: 1. Correction Factor = Antenna factor+ Insertion loss (cable loss + amplifier gain)



802.11ax (HE20) CH165

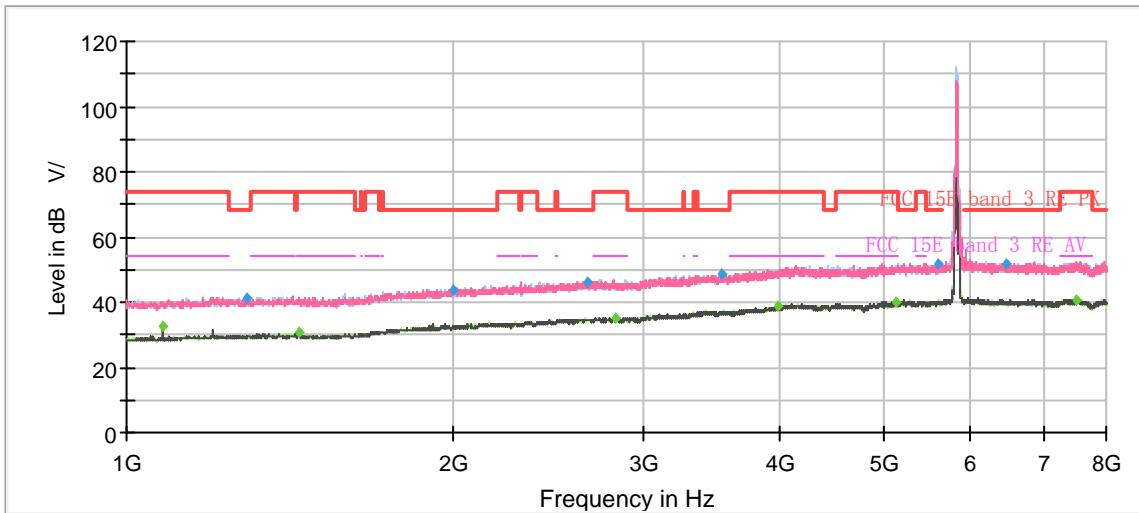

Note: The signal beyond the limit is carrier.  
Radiates Emission from 1GHz to 8GHz

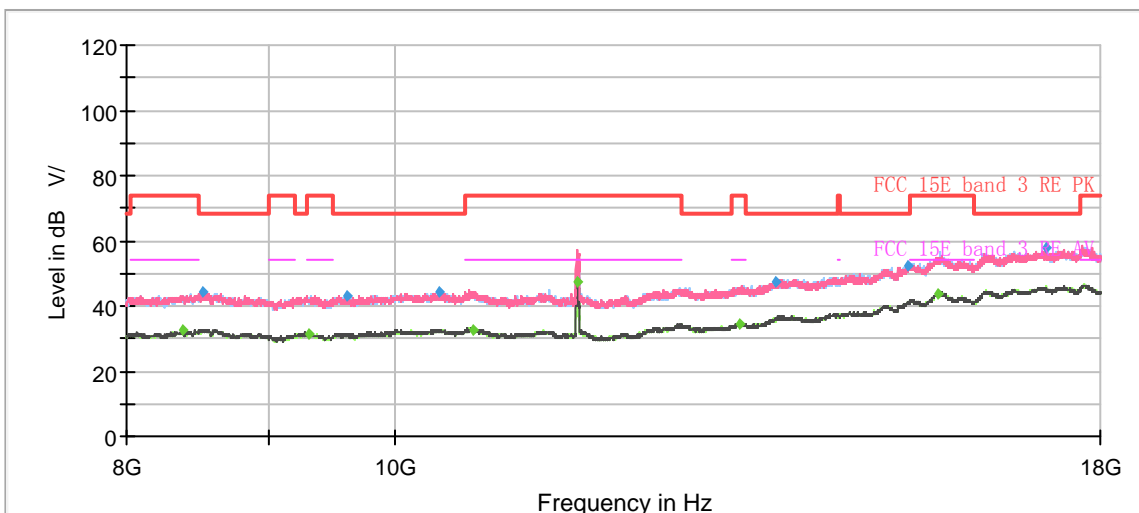

Radiates Emission from 8GHz to 18GHz



Frequency (MHz)	Peak (dBuV/m)	Average (dBuV/m)	Limit (dBuV/m)	Margin (dB)	Height (cm)	Polarization	Azimuth (deg)	Correct Factor (dB)
1079.63	---	32.76	54.00	21.24	200.0	H	333.00	-8
1289.63	41.42	---	68.20	26.78	100.0	V	270.00	-7
1440.13	---	31.02	54.00	22.98	200.0	V	254.00	-6
1999.25	43.99	---	68.20	24.21	100.0	H	116.00	-3
2659.88	46.45	---	68.20	21.75	100.0	V	141.00	0
2821.75	---	35.11	54.00	18.89	100.0	H	190.00	1
3530.50	48.77	---	68.20	19.43	100.0	V	289.00	4
3986.38	---	38.64	54.00	15.36	100.0	H	140.00	6
5127.38	---	40.30	54.00	13.70	200.0	V	118.00	9
5607.75	51.97	---	68.20	16.23	100.0	H	278.00	10
6469.63	51.77	---	68.20	16.43	100.0	H	234.00	10
7510.88	---	40.75	54.00	13.25	100.0	V	344.00	11

Remark: 1. Correction Factor = Antenna factor+ Insertion loss (cable loss + amplifier gain)



802.11ax (HE40) CH38

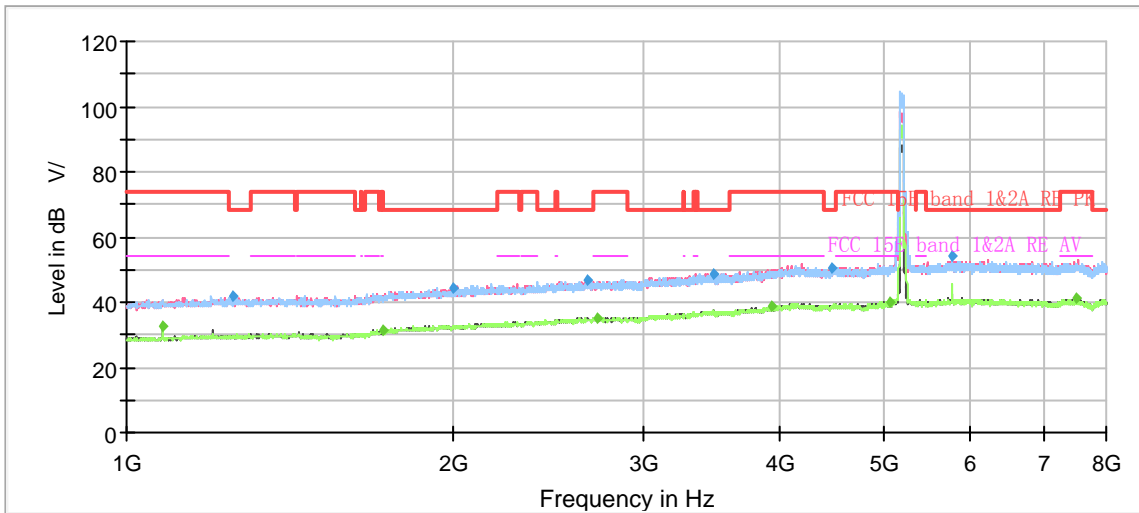

Note: The signal beyond the limit is carrier.  
Radiates Emission from 1GHz to 8GHz

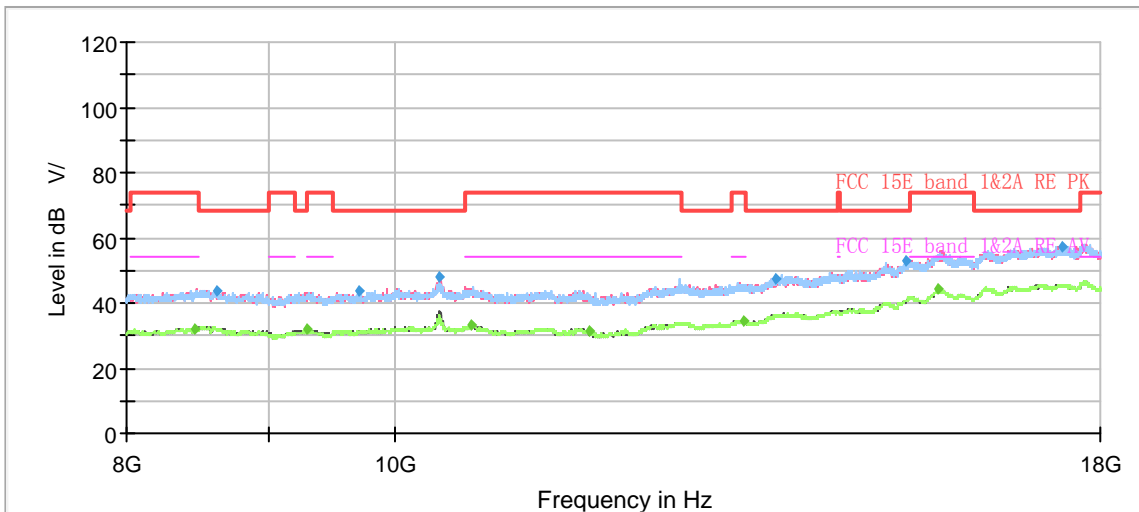

Radiates Emission from 8GHz to 18GHz





Frequency (MHz)	Peak (dBuV/m)	Average (dBuV/m)	Limit (dBuV/m)	Margin (dB)	Height (cm)	Polarization	Azimuth (deg)	Correct Factor (dB)
1079.63	---	32.58	54.00	21.42	200.0	H	330.00	-8
1254.63	41.68	---	68.20	26.52	100.0	V	150.00	-7
1721.88	---	31.47	54.00	22.53	200.0	H	50.00	-4
1998.38	44.44	---	68.20	23.76	100.0	H	294.00	-3
2659.00	46.61	---	68.20	21.59	200.0	H	213.00	0
2714.13	---	35.23	54.00	18.77	100.0	V	203.00	1
3483.25	48.91	---	68.20	19.29	100.0	V	227.00	4
3940.88	---	38.83	54.00	15.17	100.0	V	25.00	6
4461.50	50.31	---	68.20	17.89	200.0	H	40.00	7
5047.75	---	39.78	54.00	14.22	200.0	V	238.00	9
5760.00	53.92	---	68.20	14.28	200.0	H	0.00	10
7501.25	---	40.93	54.00	13.07	200.0	V	324.00	11

Remark: 1. Correction Factor = Antenna factor+ Insertion loss (cable loss + amplifier gain)



802.11ax (HE40) CH46

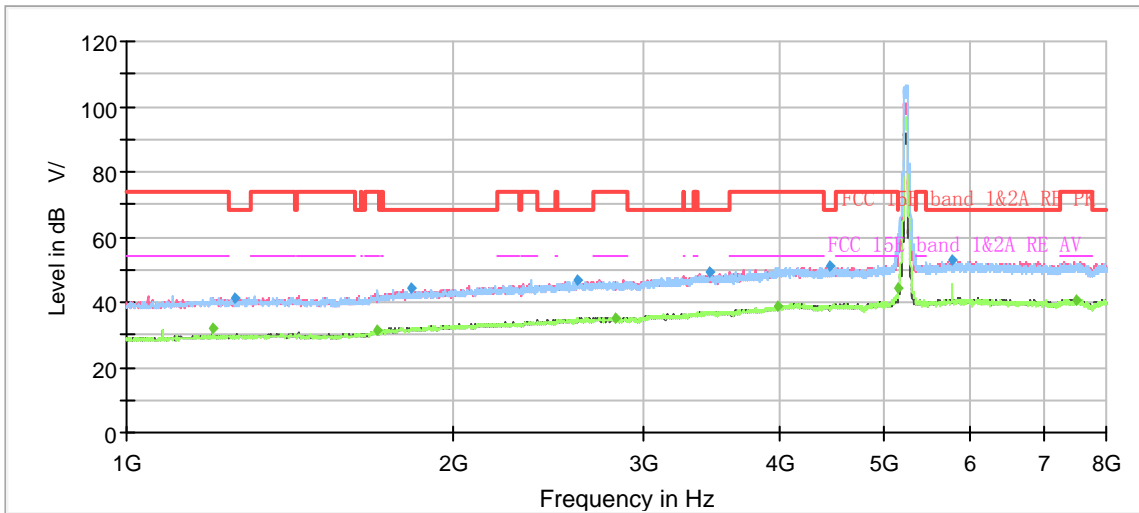

Note: The signal beyond the limit is carrier.  
Radiates Emission from 1GHz to 8GHz

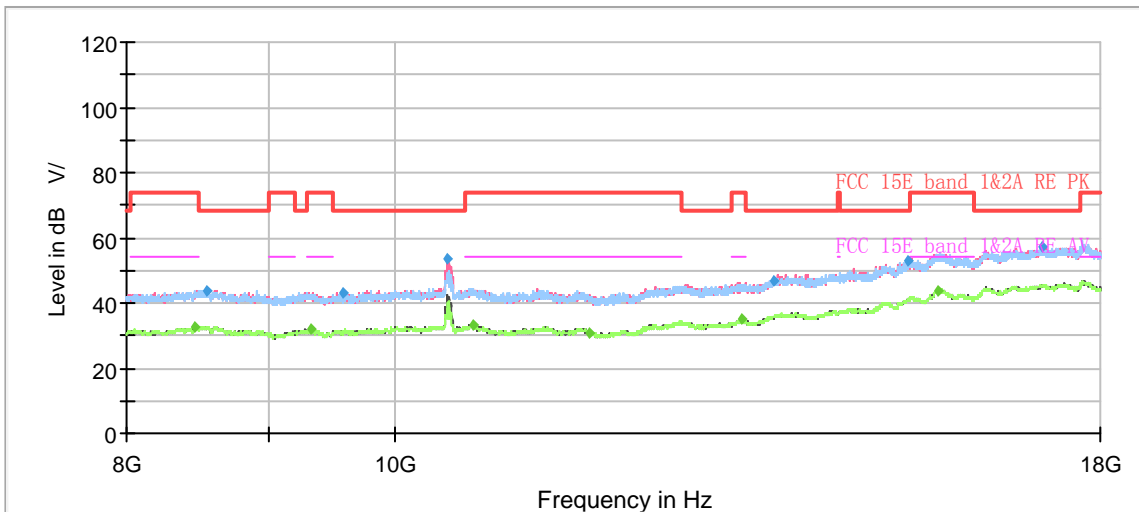

Radiates Emission from 8GHz to 18GHz



Frequency (MHz)	Peak (dBuV/m)	Average (dBuV/m)	Limit (dBuV/m)	Margin (dB)	Height (cm)	Polarization	Azimuth (deg)	Correct Factor (dB)
1199.50	---	32.02	54.00	21.98	200.0	V	188.00	-8
1258.13	41.29	---	68.20	26.91	100.0	V	129.00	-7
1702.63	---	31.23	54.00	22.77	100.0	V	289.00	-5
1826.88	44.23	---	68.20	23.97	100.0	V	304.00	-4
2604.75	46.61	---	68.20	21.59	200.0	H	47.00	0
2827.00	---	35.23	54.00	18.77	200.0	V	83.00	1
3443.88	49.15	---	68.20	19.05	200.0	V	0.00	4
3982.00	---	38.78	54.00	15.22	100.0	H	231.00	6
4445.75	50.85	---	68.20	17.35	100.0	H	160.00	7
5148.38	---	44.32	54.00	9.68	200.0	H	349.00	9
5760.00	52.75	---	68.20	15.45	200.0	H	12.00	10
7503.00	---	40.78	54.00	13.22	200.0	V	355.00	11

Remark: 1. Correction Factor = Antenna factor+ Insertion loss (cable loss + amplifier gain)



802.11ax (HE40) CH54

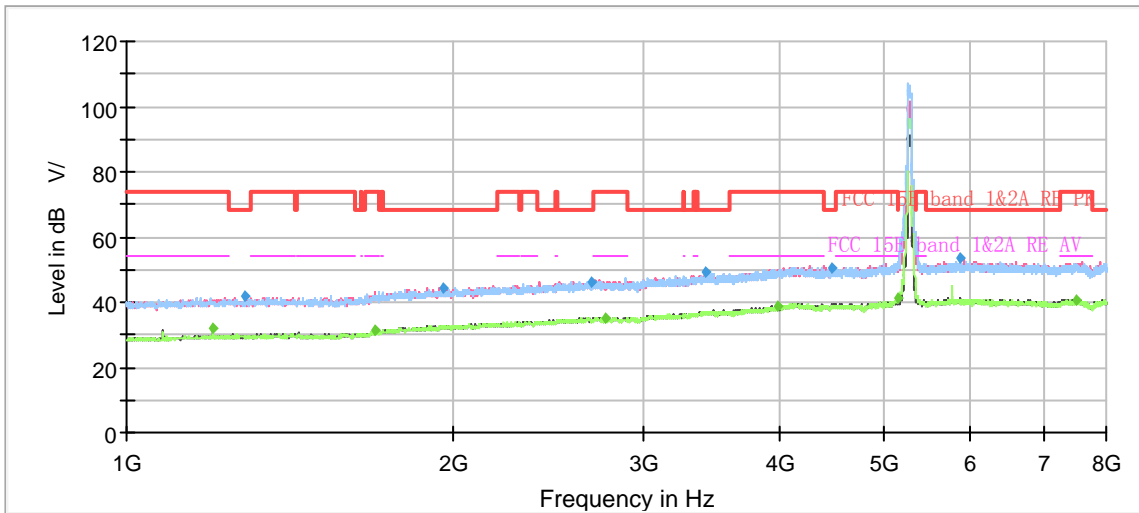

Note: The signal beyond the limit is carrier.  
Radiates Emission from 1GHz to 8GHz

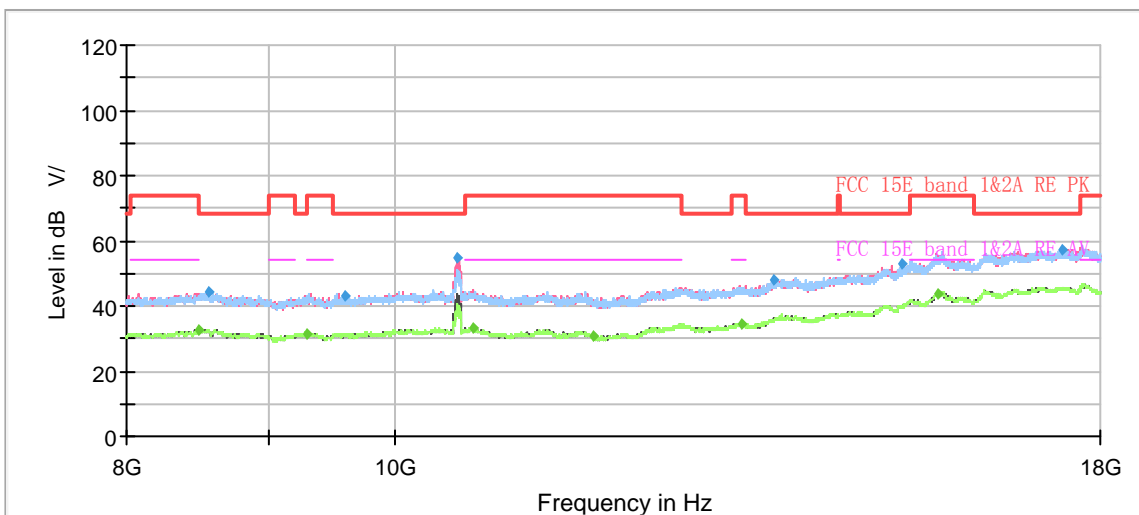

Radiates Emission from 8GHz to 18GHz



Frequency (MHz)	Peak (dBuV/m)	Average (dBuV/m)	Limit (dBuV/m)	Margin (dB)	Height (cm)	Polarization	Azimuth (deg)	Correct Factor (dB)
1199.50	---	32.07	54.00	21.93	200.0	V	44.00	-8
1284.38	41.65	---	68.20	26.55	100.0	H	23.00	-7
1697.38	---	31.23	54.00	22.77	100.0	V	163.00	-5
1955.50	44.30	---	68.20	23.90	200.0	H	157.00	-3
2677.38	46.39	---	68.20	21.81	100.0	H	303.00	0
2757.88	---	35.11	54.00	18.89	200.0	V	259.00	1
3410.63	49.04	---	68.20	19.16	100.0	V	218.00	4
3983.75	---	38.74	54.00	15.26	100.0	H	264.00	6
4465.88	50.16	---	68.20	18.04	200.0	V	348.00	7
5148.38	---	40.93	54.00	13.07	200.0	H	324.00	9
5861.50	53.45	---	68.20	14.75	200.0	H	12.00	10
7496.88	---	40.60	54.00	13.40	100.0	V	163.00	11

Remark: 1. Correction Factor = Antenna factor+ Insertion loss (cable loss + amplifier gain)



802.11ax (HE40) CH62

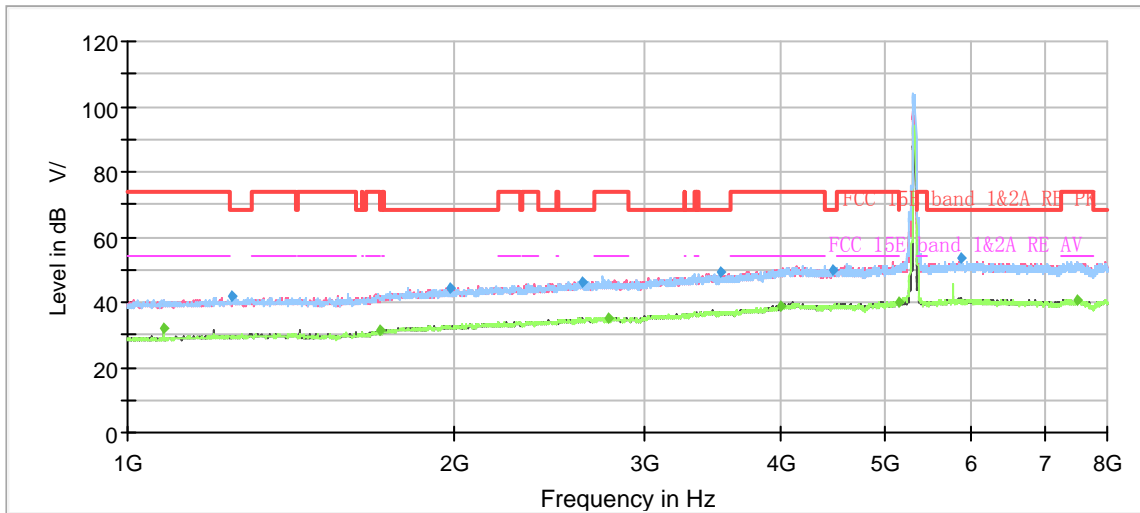

Note: The signal beyond the limit is carrier.  
Radiates Emission from 1GHz to 8GHz

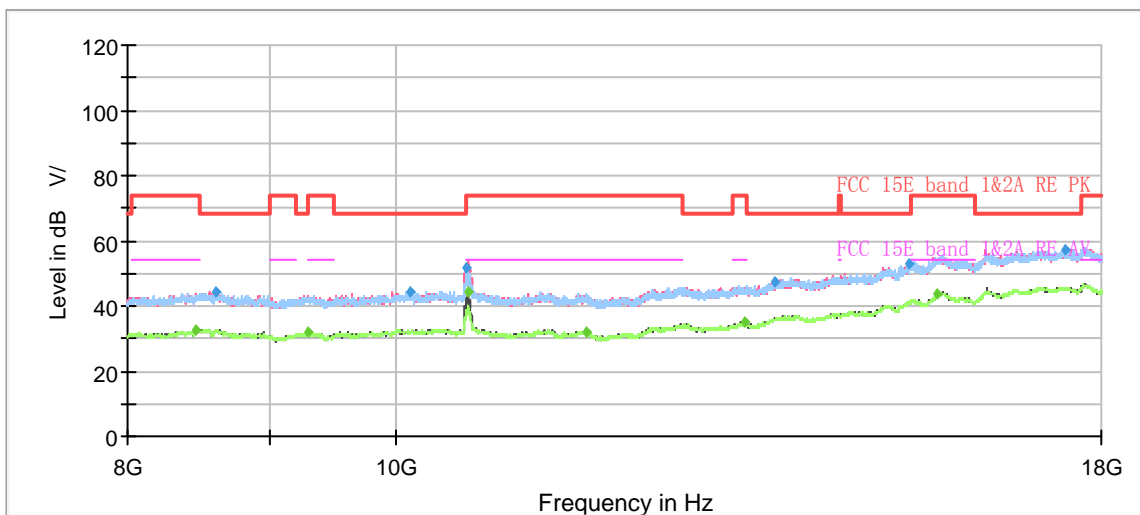

Radiates Emission from 8GHz to 18GHz



Frequency (MHz)	Peak (dBuV/m)	Average (dBuV/m)	Limit (dBuV/m)	Margin (dB)	Height (cm)	Polarization	Azimuth (deg)	Correct Factor (dB)
1079.63	---	31.97	54.00	22.03	200.0	H	310.00	-8
1249.38	41.58	---	68.20	26.62	100.0	H	148.00	-7
1705.25	---	31.37	54.00	22.63	200.0	V	318.00	-5
1979.13	44.49	---	68.20	23.71	100.0	V	7.00	-3
2622.25	46.29	---	68.20	21.91	200.0	V	318.00	0
2778.88	---	35.29	54.00	18.71	200.0	V	207.00	1
3523.50	49.08	---	68.20	19.12	200.0	V	1.00	4
3996.88	---	38.75	54.00	15.25	200.0	V	230.00	6
4460.63	49.66	---	68.20	18.54	200.0	H	130.00	7
5130.00	---	40.08	54.00	13.92	200.0	H	0.00	9
5864.13	53.38	---	68.20	14.82	100.0	V	2.00	10
7496.88	---	40.85	54.00	13.15	100.0	V	204.00	11

Remark: 1. Correction Factor = Antenna factor+ Insertion loss (cable loss + amplifier gain)



802.11ax (HE40) CH102

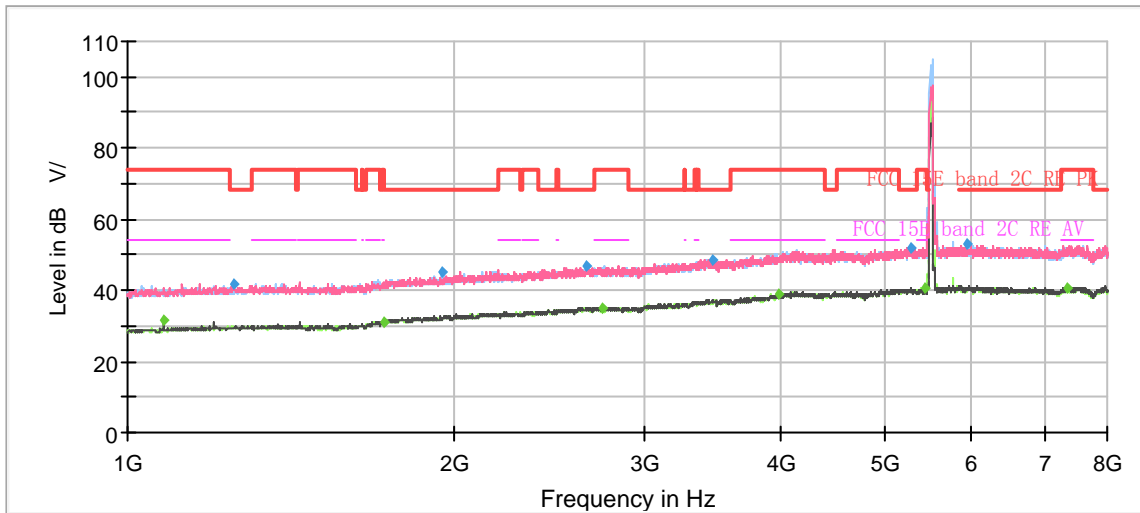

Note: The signal beyond the limit is carrier.  
Radiates Emission from 1GHz to 8GHz

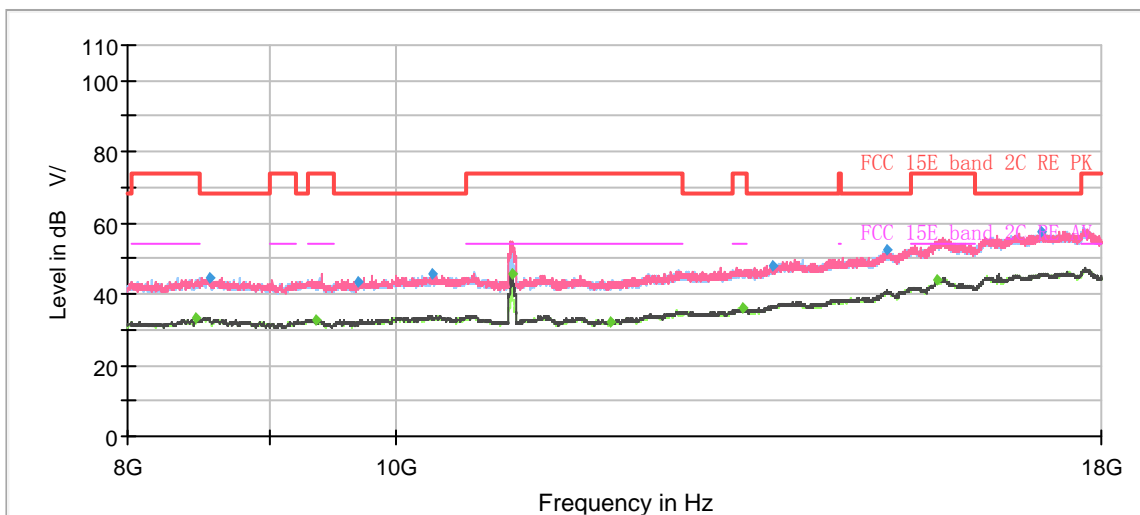

Radiates Emission from 8GHz to 18GHz





Frequency (MHz)	Peak (dBuV/m)	Average (dBuV/m)	Limit (dBuV/m)	Margin (dB)	Height (cm)	Polarization	Azimuth (deg)	Correct Factor (dB)
1079.63	---	31.68	54.00	22.32	200.0	H	326.00	-8
1250.25	41.53	---	68.20	26.67	200.0	V	224.00	-7
1721.00	---	31.08	54.00	22.92	100.0	H	159.00	-4
1945.88	45.37	---	68.20	22.83	200.0	H	267.00	-3
2649.38	46.68	---	68.20	21.52	100.0	V	150.00	0
2739.50	---	35.14	54.00	18.86	200.0	V	99.00	1
3464.88	48.69	---	68.20	19.51	100.0	V	234.00	4
3989.88	---	38.83	54.00	15.17	200.0	V	200.00	6
5276.13	52.03	---	68.20	16.17	100.0	H	258.00	9
5431.00	---	40.65	54.00	13.35	200.0	H	340.00	9
5940.25	52.91	---	68.20	15.29	100.0	H	117.00	10
7335.00	---	40.81	54.00	13.19	200.0	V	205.00	11

Remark: 1. Correction Factor = Antenna factor+ Insertion loss (cable loss + amplifier gain)

802.11ax (HE40) CH134

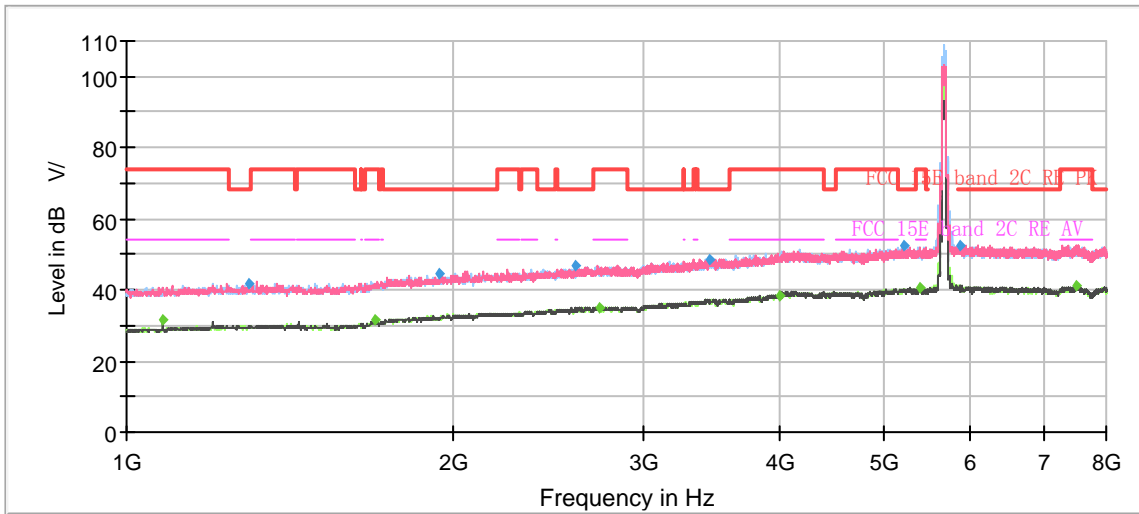

Note: The signal beyond the limit is carrier.  
Radiates Emission from 1GHz to 8GHz

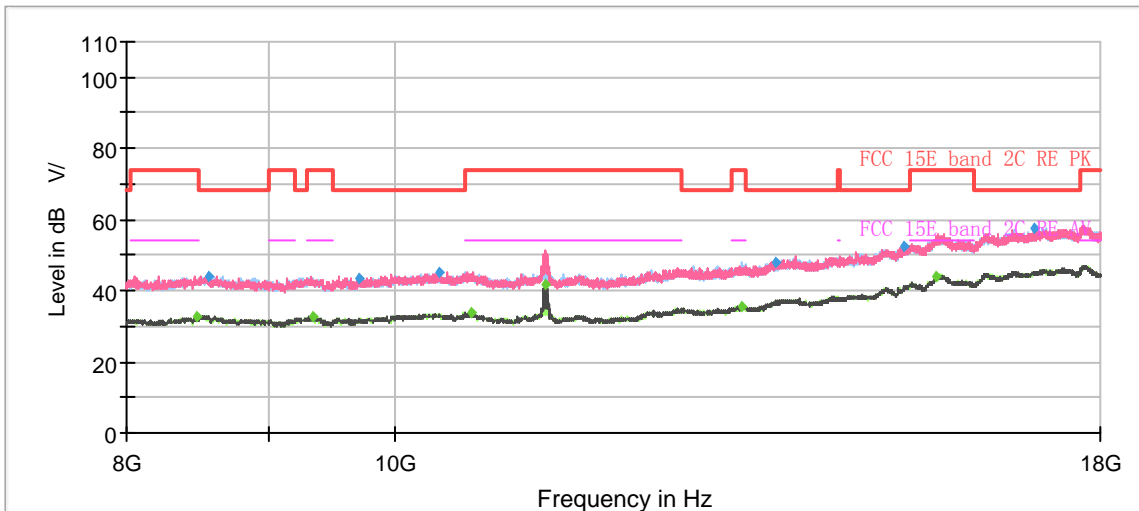

Radiates Emission from 8GHz to 18GHz



Frequency (MHz)	Peak (dBuV/m)	Average (dBuV/m)	Limit (dBuV/m)	Margin (dB)	Height (cm)	Polarization	Azimuth (deg)	Correct Factor (dB)
1079.63	---	31.56	54.00	22.44	200.0	H	318.00	-8
1295.75	41.47	---	68.20	26.73	100.0	H	293.00	-7
1696.50	---	31.37	54.00	22.63	200.0	H	323.00	-5
1942.38	44.48	---	68.20	23.72	100.0	H	9.00	-3
2593.38	46.78	---	68.20	21.42	200.0	V	269.00	0
2724.63	---	35.14	54.00	18.86	200.0	V	48.00	1
3444.75	48.70	---	68.20	19.50	200.0	V	81.00	4
3997.75	---	38.63	54.00	15.37	100.0	H	115.00	6
5197.38	52.31	---	68.20	15.89	200.0	V	67.00	9
5387.25	---	40.47	54.00	13.53	100.0	H	283.00	9
5859.75	52.66	---	68.20	15.54	200.0	H	357.00	10
7502.13	---	40.94	54.00	13.06	200.0	V	153.00	11

Remark: 1. Correction Factor = Antenna factor+ Insertion loss (cable loss + amplifier gain)

802.11ax (HE40) CH142

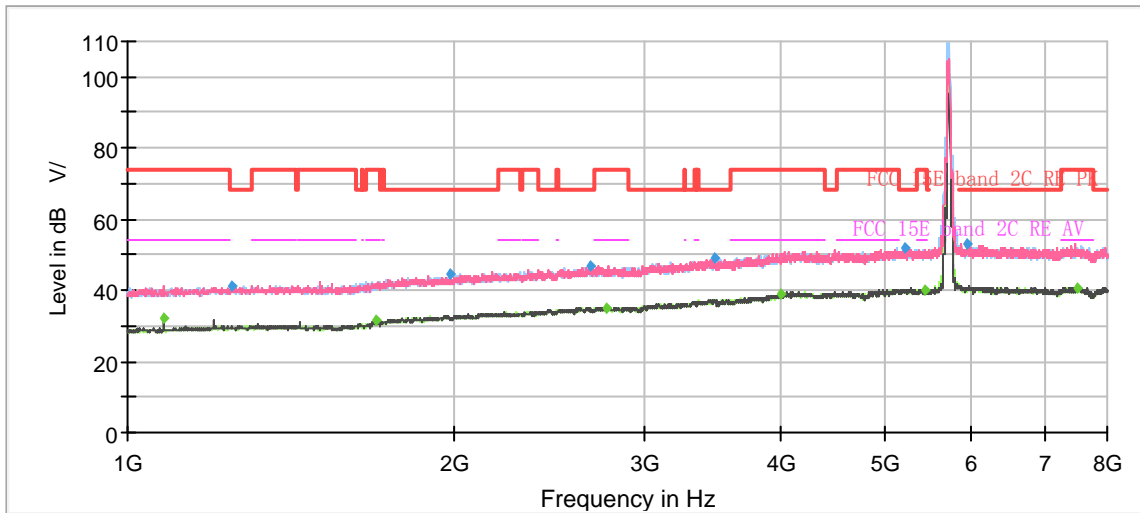

Note: The signal beyond the limit is carrier.  
Radiates Emission from 1GHz to 8GHz

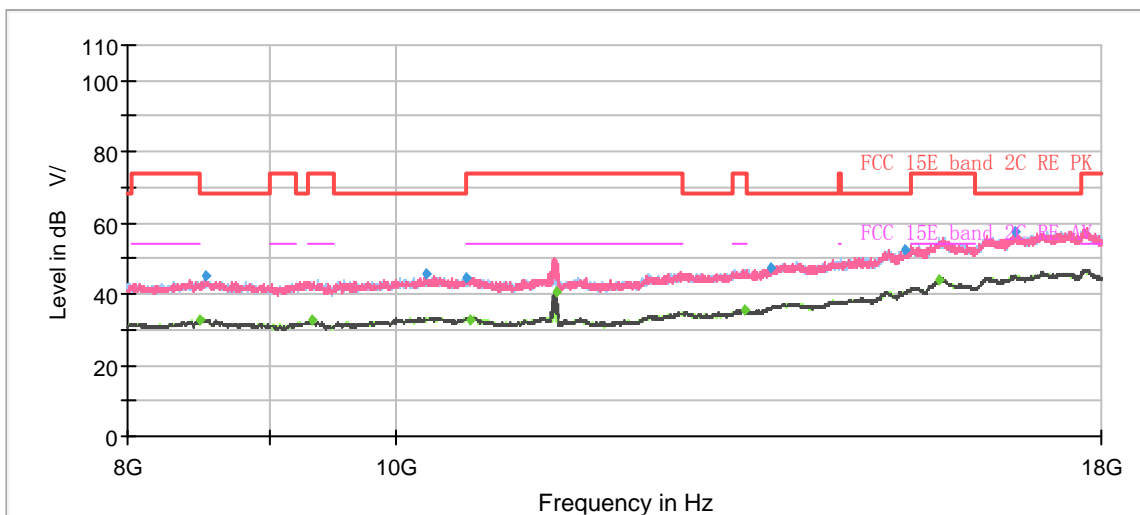

Radiates Emission from 8GHz to 18GHz



Frequency (MHz)	Peak (dBuV/m)	Average (dBuV/m)	Limit (dBuV/m)	Margin (dB)	Height (cm)	Polarization	Azimuth (deg)	Correct Factor (dB)
1079.63	---	32.05	54.00	21.95	200.0	H	321.00	-8
1246.75	41.25	---	68.20	26.95	200.0	V	163.00	-7
1695.63	---	31.47	54.00	22.53	100.0	H	31.00	-5
1981.75	44.53	---	68.20	23.67	100.0	H	228.00	-3
2674.75	46.77	---	68.20	21.43	100.0	V	159.00	0
2767.50	---	35.21	54.00	18.79	200.0	V	82.00	1
3472.75	49.34	---	68.20	18.86	200.0	V	149.00	4
3993.38	---	38.77	54.00	15.23	100.0	H	116.00	6
5214.00	51.74	---	68.20	16.46	100.0	V	330.00	9
5442.38	---	40.20	54.00	13.80	200.0	V	48.00	9
5943.75	53.07	---	68.20	15.13	100.0	V	358.00	10
7498.63	---	40.83	54.00	13.17	100.0	V	179.00	11

Remark: 1. Correction Factor = Antenna factor+ Insertion loss (cable loss + amplifier gain)



802.11ax (HE40) CH151

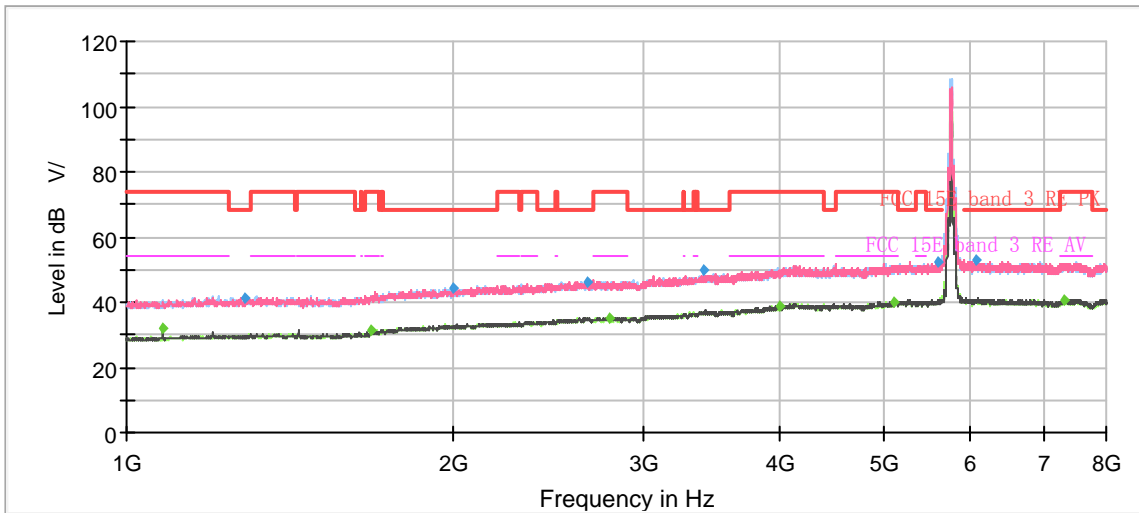

Note: The signal beyond the limit is carrier.  
Radiates Emission from 1GHz to 8GHz

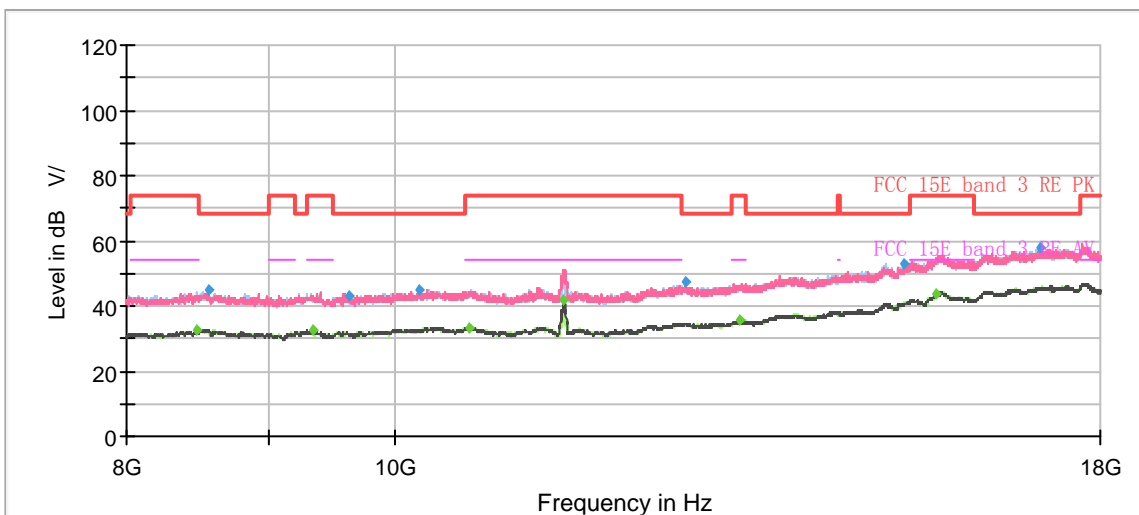

Radiates Emission from 8GHz to 18GHz



Frequency (MHz)	Peak (dBuV/m)	Average (dBuV/m)	Limit (dBuV/m)	Margin (dB)	Height (cm)	Polarization	Azimuth (deg)	Correct Factor (dB)
1079.63	---	31.89	54.00	22.11	200.0	H	333.00	-8
1287.00	40.99	---	68.20	27.21	200.0	H	83.00	-7
1680.75	---	31.44	54.00	22.56	100.0	V	123.00	-5
1999.25	44.29	---	68.20	23.91	100.0	H	169.00	-3
2664.25	46.43	---	68.20	21.77	100.0	H	40.00	0
2787.63	---	35.31	54.00	18.69	200.0	H	189.00	1
3408.88	49.60	---	68.20	18.60	200.0	H	50.00	4
3996.00	---	38.91	54.00	15.09	200.0	H	146.00	6
5102.00	---	40.24	54.00	13.76	100.0	V	91.00	9
5608.63	52.56	---	68.20	15.64	200.0	H	0.00	10
6058.38	52.68	---	68.20	15.52	200.0	H	353.00	10
7315.75	---	40.73	54.00	13.27	100.0	V	162.00	11

Remark: 1. Correction Factor = Antenna factor+ Insertion loss (cable loss + amplifier gain)



802.11ax (HE40) CH159

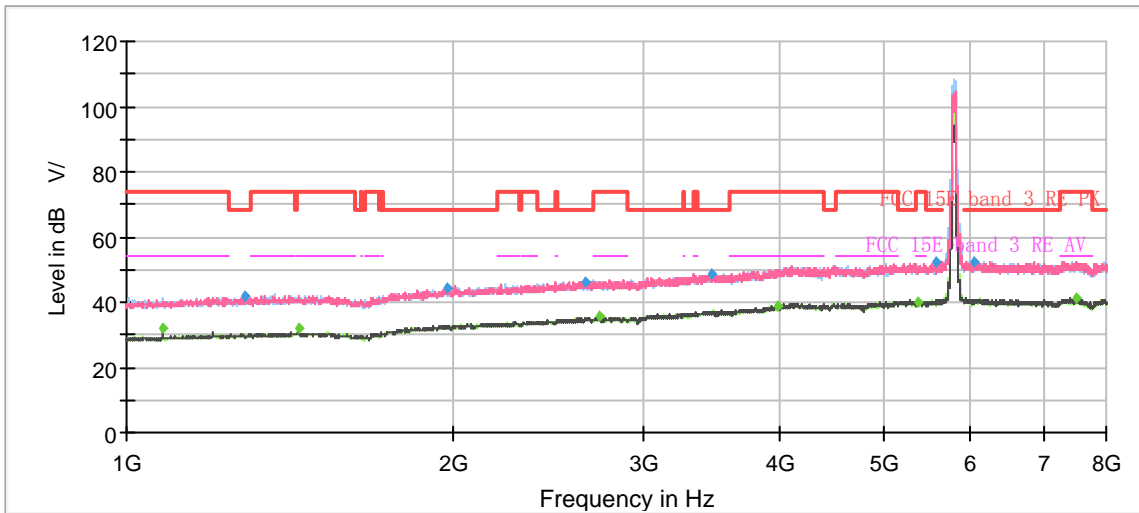

Note: The signal beyond the limit is carrier.  
Radiates Emission from 1GHz to 8GHz

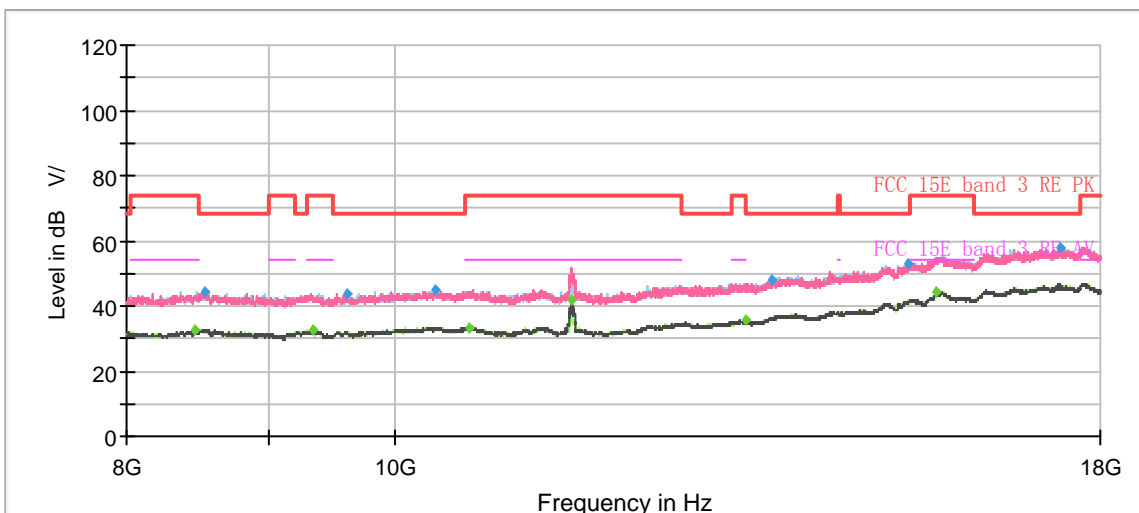

Radiates Emission from 8GHz to 18GHz





Frequency (MHz)	Peak (dBuV/m)	Average (dBuV/m)	Limit (dBuV/m)	Margin (dB)	Height (cm)	Polarization	Azimuth (deg)	Correct Factor (dB)
1079.63	---	32.02	54.00	21.98	200.0	V	225.00	-8
1286.13	41.66	---	68.20	26.54	100.0	H	22.00	-7
1440.13	---	31.95	54.00	22.05	100.0	V	29.00	-6
1976.50	44.29	---	68.20	23.91	200.0	H	35.00	-3
2648.50	46.29	---	68.20	21.91	200.0	H	216.00	0
2727.25	---	35.44	54.00	18.56	200.0	H	341.00	1
3463.13	48.41	---	68.20	19.79	100.0	V	243.00	4
3989.88	---	38.67	54.00	15.33	100.0	V	195.00	6
5360.13	---	40.30	54.00	13.70	100.0	H	98.00	9
5565.75	52.10	---	68.20	16.10	100.0	H	98.00	10
6029.50	52.56	---	68.20	15.64	100.0	H	232.00	10
7503.00	---	41.10	54.00	12.90	200.0	V	6.00	11

Remark: 1. Correction Factor = Antenna factor+ Insertion loss (cable loss + amplifier gain)



802.11ax (HE80) CH42

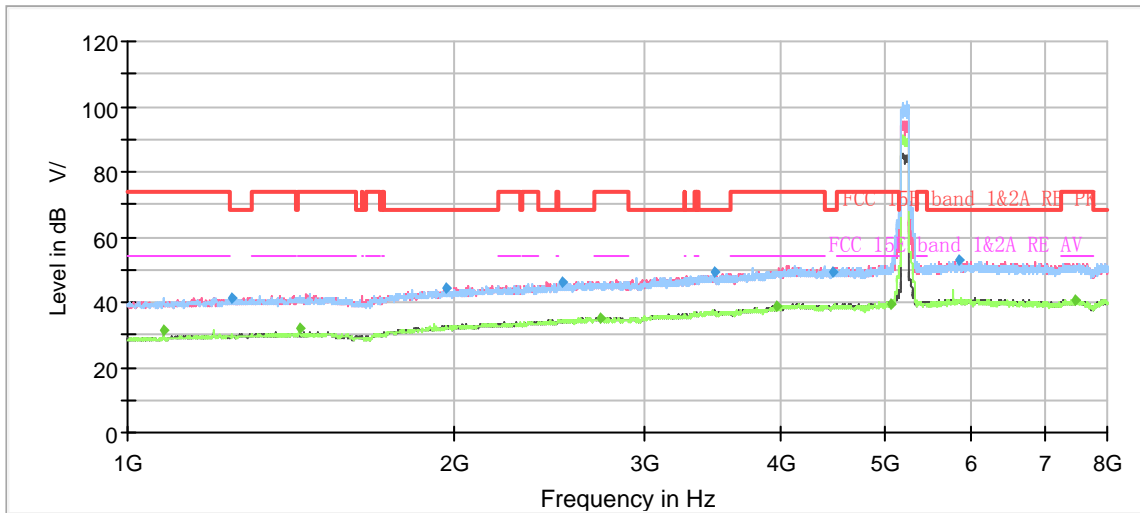

Note: The signal beyond the limit is carrier.  
Radiates Emission from 1GHz to 8GHz

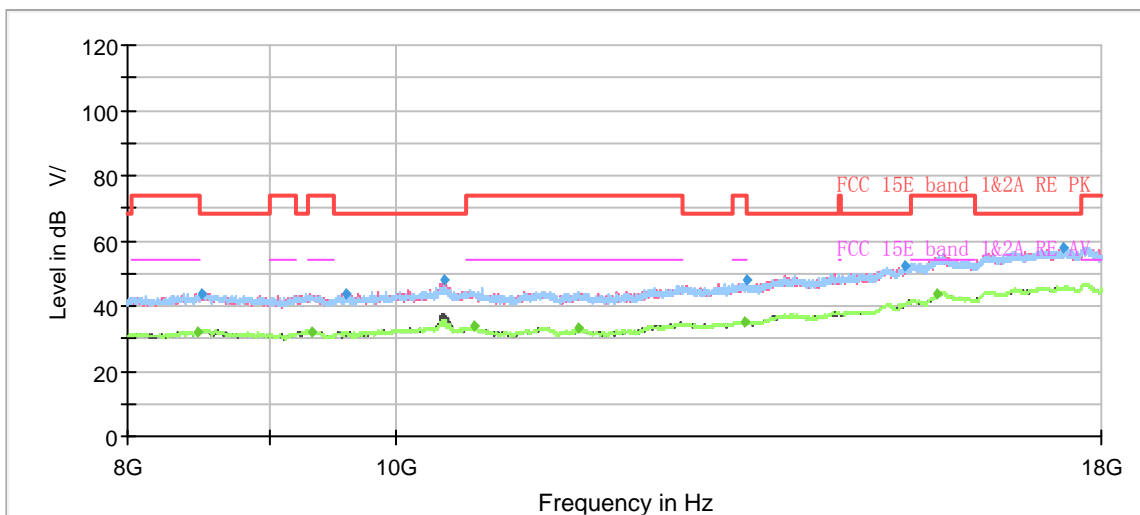

Radiates Emission from 8GHz to 18GHz



Frequency (MHz)	Peak (dBuV/m)	Average (dBuV/m)	Limit (dBuV/m)	Margin (dB)	Height (cm)	Polarization	Azimuth (deg)	Correct Factor (dB)
1079.63	---	31.44	54.00	22.56	200.0	V	306.00	-8
1245.88	41.31	---	68.20	26.89	200.0	V	340.00	-7
1440.13	---	31.89	54.00	22.11	100.0	H	173.00	-6
1964.25	44.34	---	68.20	23.86	100.0	H	281.00	-3
2513.75	46.42	---	68.20	21.78	200.0	V	316.00	0
2725.50	---	35.36	54.00	18.64	200.0	V	316.00	1
3477.13	48.94	---	68.20	19.26	200.0	V	235.00	4
3963.63	---	38.77	54.00	15.23	100.0	V	124.00	6
4462.38	49.40	---	68.20	18.80	200.0	V	230.00	7
5045.13	---	39.43	54.00	14.57	100.0	V	214.00	9
5837.88	53.07	---	68.20	15.13	100.0	H	305.00	10
7489.00	---	40.85	54.00	13.15	100.0	V	33.00	11

Remark: 1. Correction Factor = Antenna factor+ Insertion loss (cable loss + amplifier gain)



802.11ax (HE80) CH58

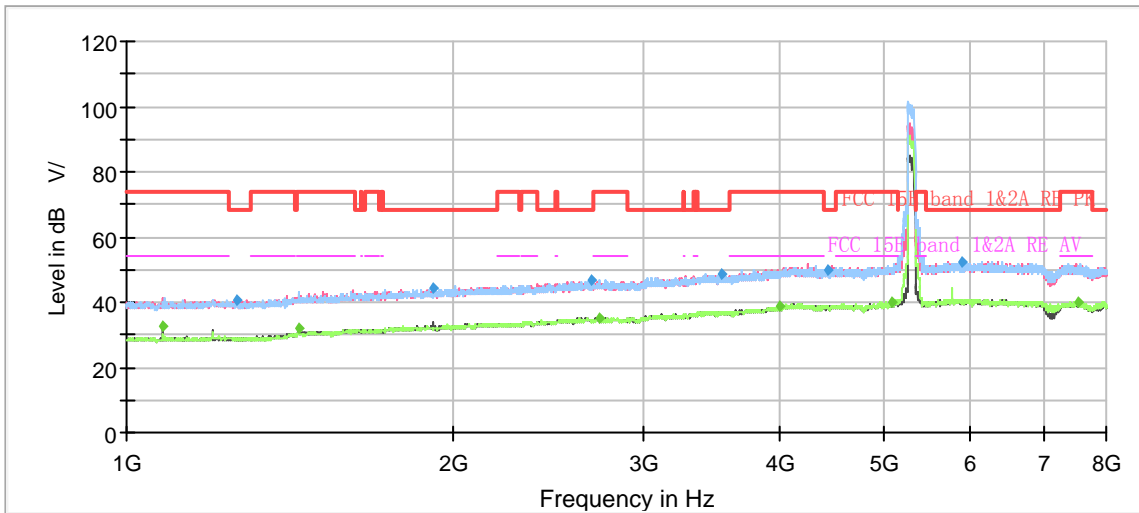

Note: The signal beyond the limit is carrier.  
Radiates Emission from 1GHz to 8GHz

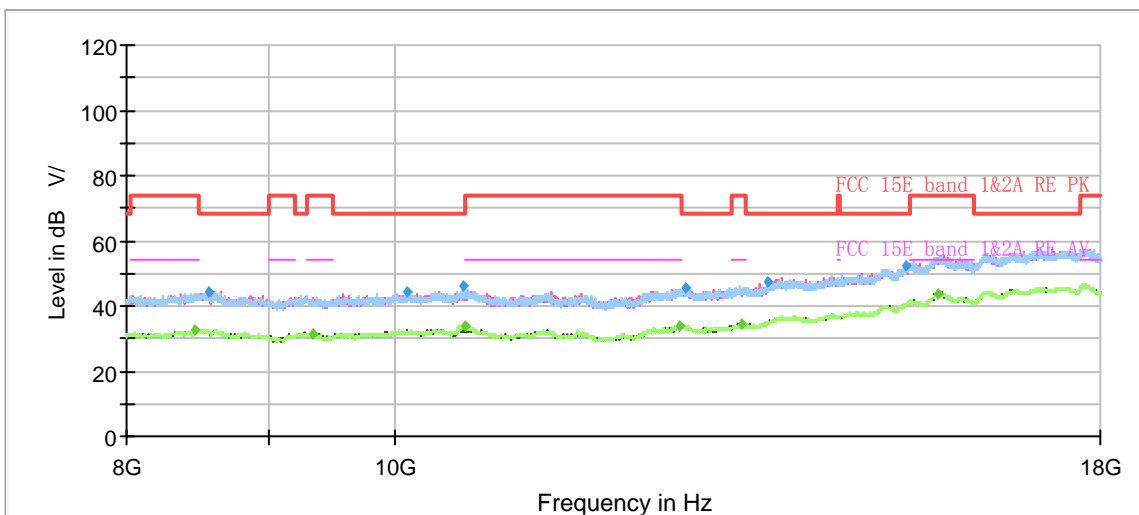

Radiates Emission from 8GHz to 18GHz



Frequency (MHz)	Peak (dBuV/m)	Average (dBuV/m)	Limit (dBuV/m)	Margin (dB)	Height (cm)	Polarization	Azimuth (deg)	Correct Factor (dB)
1079.63	---	32.39	54.00	21.61	200.0	V	88.00	-8
1264.25	40.53	---	68.20	27.67	100.0	H	349.00	-7
1440.13	---	32.09	54.00	21.91	100.0	V	290.00	-6
1918.75	44.19	---	68.20	24.01	100.0	V	184.00	-3
2687.00	46.50	---	68.20	21.70	200.0	V	0.00	1
2723.75	---	35.04	54.00	18.96	200.0	H	212.00	1
3534.88	48.60	---	68.20	19.60	100.0	H	244.00	4
3994.25	---	38.50	54.00	15.50	200.0	H	255.00	6
4426.50	49.94	---	68.20	18.26	200.0	H	284.00	7
5081.00	---	39.93	54.00	14.07	100.0	V	24.00	9
5898.25	52.62	---	68.20	15.58	100.0	V	104.00	10
7543.25	---	40.17	54.00	13.83	100.0	H	254.00	11

Remark: 1. Correction Factor = Antenna factor+ Insertion loss (cable loss + amplifier gain)



802.11ax (HE80) CH106

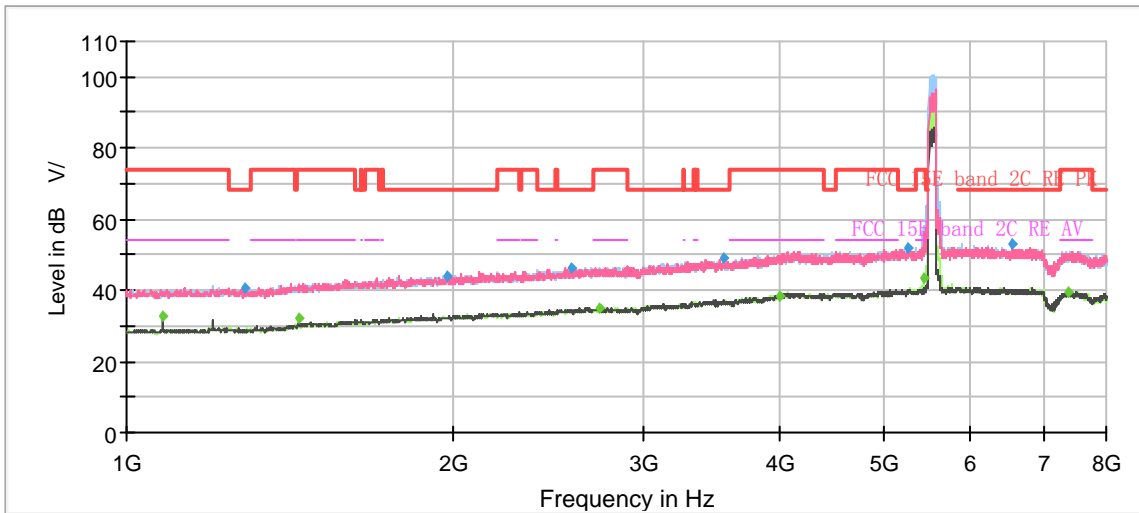

Note: The signal beyond the limit is carrier.  
Radiates Emission from 1GHz to 8GHz

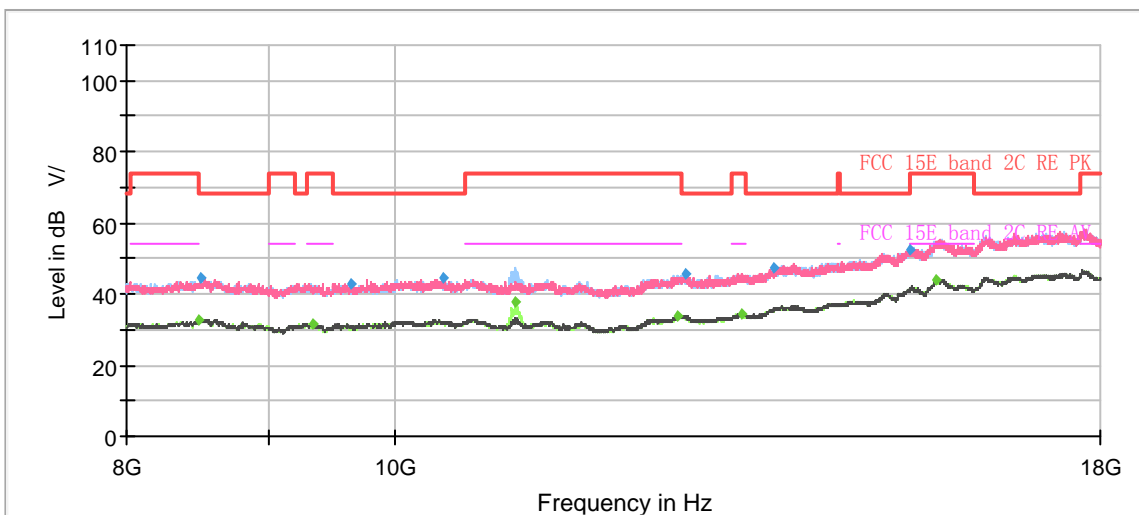

Radiates Emission from 8GHz to 18GHz



Frequency (MHz)	Peak (dBuV/m)	Average (dBuV/m)	Limit (dBuV/m)	Margin (dB)	Height (cm)	Polarization	Azimuth (deg)	Correct Factor (dB)
1079.63	---	32.49	54.00	21.51	200.0	V	88.00	-8
1286.13	40.53	---	68.20	27.67	100.0	H	17.00	-7
1440.13	---	32.13	54.00	21.87	100.0	V	292.00	-6
1978.25	44.15	---	68.20	24.05	200.0	V	57.00	-3
2571.50	46.20	---	68.20	22.00	200.0	V	33.00	0
2722.88	---	35.18	54.00	18.82	100.0	H	159.00	1
3552.38	49.02	---	68.20	19.18	200.0	V	112.00	4
3994.25	---	38.39	54.00	15.61	200.0	H	137.00	6
5242.00	51.68	---	68.20	16.52	100.0	V	330.00	9
5442.38	---	43.32	54.00	10.68	200.0	H	332.00	9
6544.88	52.85	---	68.20	15.35	100.0	V	256.00	10
7384.00	---	39.39	54.00	14.61	200.0	H	207.00	11

Remark: 1. Correction Factor = Antenna factor+ Insertion loss (cable loss + amplifier gain)



802.11ax (HE80) CH138

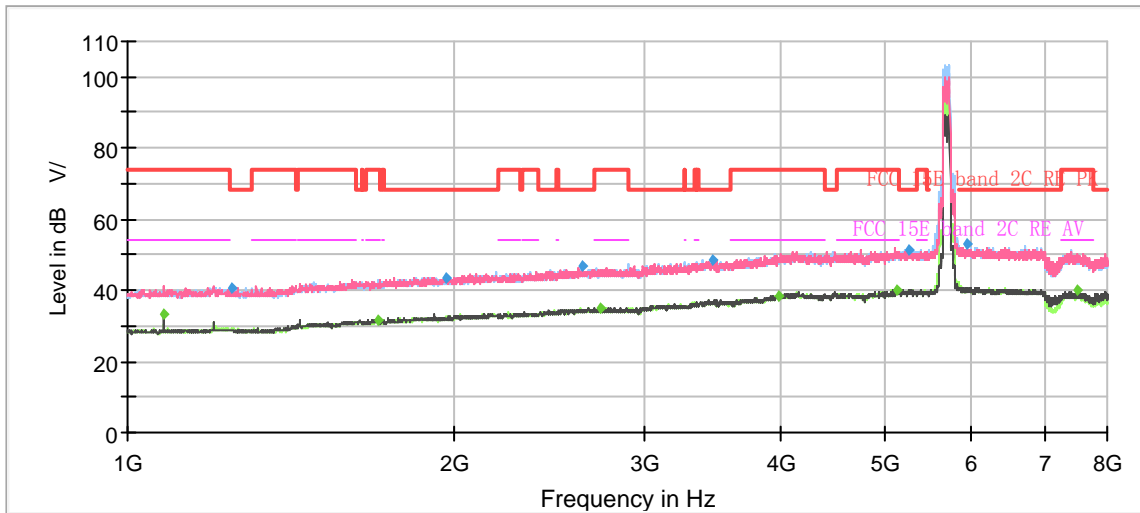

Note: The signal beyond the limit is carrier.  
Radiates Emission from 1GHz to 8GHz

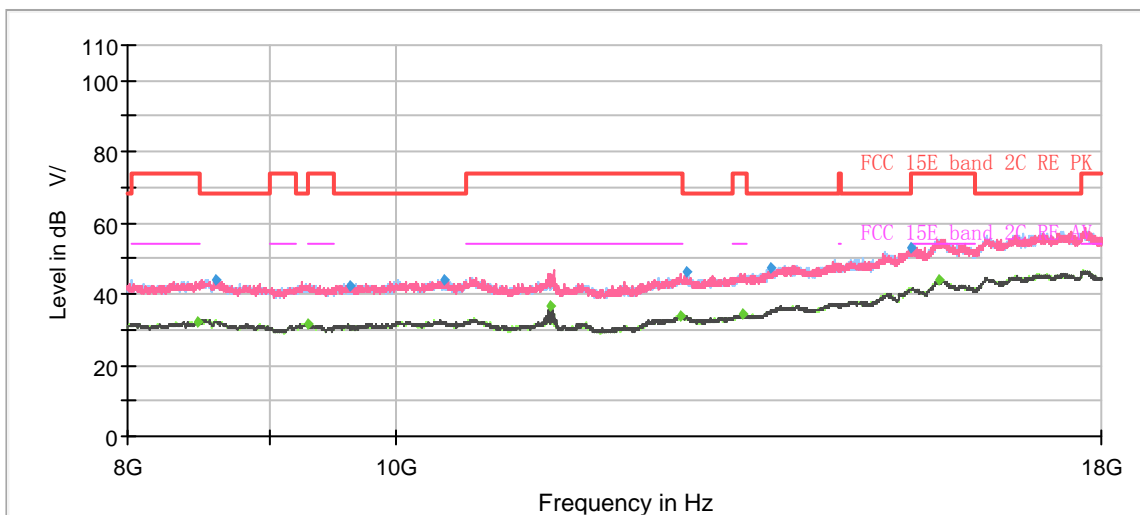

Radiates Emission from 8GHz to 18GHz





Frequency (MHz)	Peak (dBuV/m)	Average (dBuV/m)	Limit (dBuV/m)	Margin (dB)	Height (cm)	Polarization	Azimuth (deg)	Correct Factor (dB)
1079.63	---	33.42	54.00	20.58	200.0	V	90.00	-8
1245.00	40.82	---	68.20	27.38	100.0	H	178.00	-7
1704.38	---	31.72	54.00	22.28	100.0	H	165.00	-5
1966.00	43.71	---	68.20	24.49	200.0	V	109.00	-3
2629.25	46.60	---	68.20	21.60	200.0	V	122.00	0
2723.75	---	35.23	54.00	18.77	200.0	H	225.00	1
3468.38	48.63	---	68.20	19.57	100.0	V	247.00	4
3987.25	---	38.47	54.00	15.53	100.0	H	123.00	6
5109.88	---	39.96	54.00	14.04	200.0	H	310.00	9
5240.25	51.58	---	68.20	16.62	100.0	H	183.00	9
5931.50	52.85	---	68.20	15.35	100.0	V	125.00	10
7496.00	---	40.09	54.00	13.91	100.0	V	1.00	11

Remark: 1. Correction Factor = Antenna factor+ Insertion loss (cable loss + amplifier gain)



802.11ax (HE80) CH155

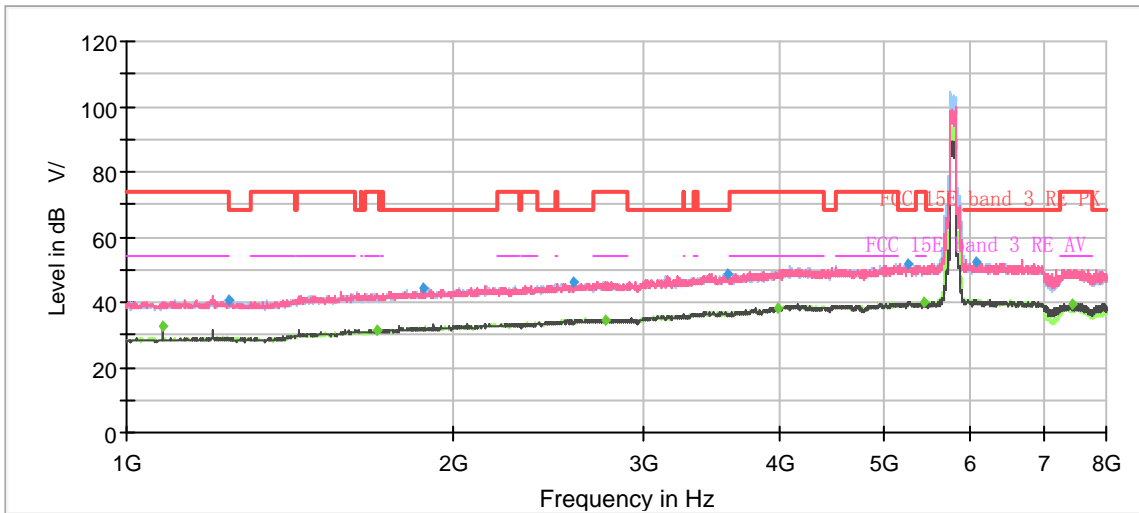

Note: The signal beyond the limit is carrier.  
Radiates Emission from 1GHz to 8GHz

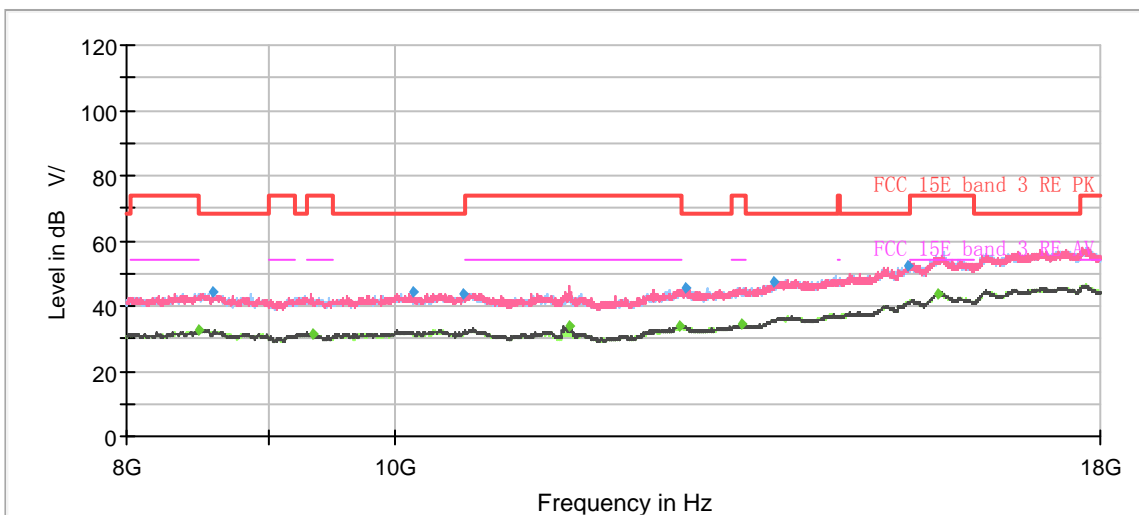

Radiates Emission from 8GHz to 18GHz



Frequency (MHz)	Peak (dBuV/m)	Average (dBuV/m)	Limit (dBuV/m)	Margin (dB)	Height (cm)	Polarization	Azimuth (deg)	Correct Factor (dB)
1079.63	---	32.56	54.00	21.44	200.0	V	87.00	-8
1242.38	40.36	---	68.20	27.84	200.0	V	176.00	-7
1703.50	---	31.48	54.00	22.52	200.0	H	253.00	-5
1873.25	44.32	---	68.20	23.88	100.0	H	129.00	-4
2584.63	45.95	---	68.20	22.25	200.0	H	195.00	0
2759.63	---	34.67	54.00	19.33	100.0	V	37.00	1
3578.63	48.82	---	68.20	19.38	100.0	V	276.00	4
3979.38	---	38.34	54.00	15.66	100.0	V	247.00	6
5246.38	51.46	---	68.20	16.74	100.0	V	128.00	9
5426.63	---	40.00	54.00	14.00	200.0	H	195.00	9
6072.38	52.44	---	68.20	15.76	200.0	V	171.00	10
7446.13	---	39.34	54.00	14.66	100.0	V	97.00	11

Remark: 1. Correction Factor = Antenna factor+ Insertion loss (cable loss + amplifier gain)



During the test, the Radiates Emission from 18GHz to 40GHz was performed in all modes with all channels, 802.11ax (HE40), Channel 46 are selected as the worst condition. The test data of the worst-case condition was recorded in this report.

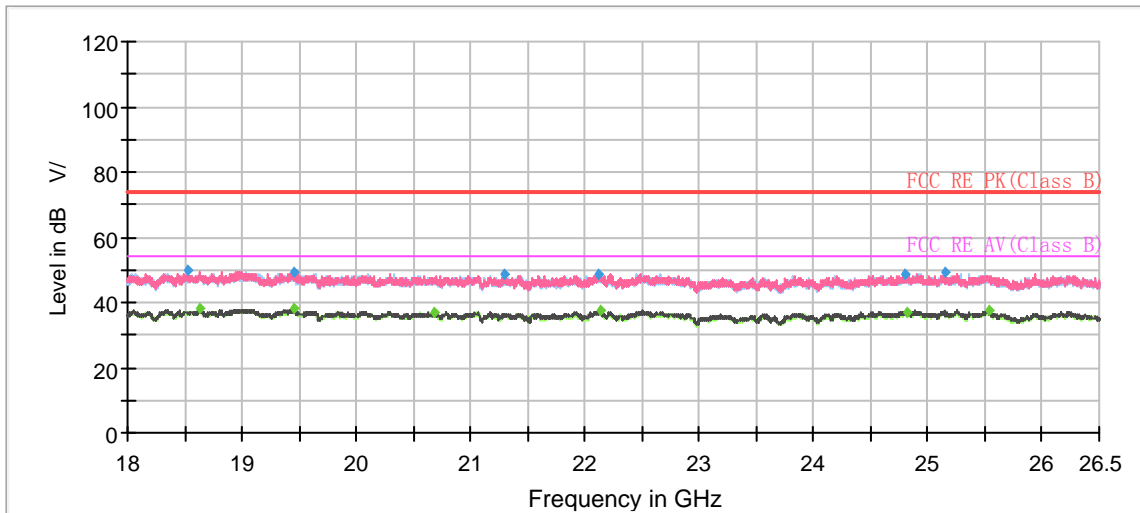

Radiates Emission from 18GHz to 26.5GHz

Frequency (MHz)	Peak (dBuV/m)	Average (dBuV/m)	Limit (dBuV/m)	Margin (dB)	Height (cm)	Polarization	Azimuth (deg)	Correct Factor (dB)
18528.06	49.63	---	74.00	24.37	100.0	H	15.00	-2
18625.81	---	37.99	54.00	16.01	200.0	V	47.00	-2
19447.13	---	37.92	54.00	16.08	200.0	V	67.00	-1
19456.69	49.31	---	74.00	24.69	100.0	H	261.00	-1
20683.88	---	36.89	54.00	17.11	200.0	V	1.00	0
21292.69	48.46	---	74.00	25.54	200.0	V	271.00	0
22123.56	48.84	---	74.00	25.16	100.0	H	89.00	1
22131.00	---	37.38	54.00	16.62	200.0	V	319.00	1
24808.50	48.41	---	74.00	25.59	100.0	V	204.00	3
24817.00	---	37.09	54.00	16.91	100.0	V	237.00	3
25146.38	48.97	---	74.00	25.03	200.0	V	26.00	3
25532.06	---	37.44	54.00	16.56	200.0	V	187.00	3

Remark: 1. Correction Factor = Antenna factor+ Insertion loss (cable loss + amplifier gain)

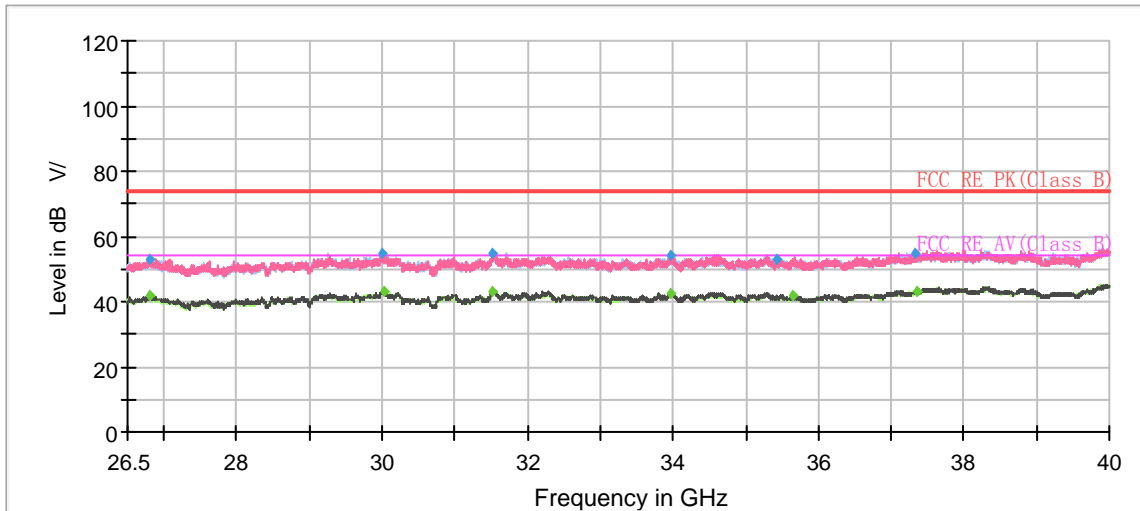

Radiates Emission from 26.5GHz to 40GHz

Frequency (MHz)	Peak (dBuV/m)	Average (dBuV/m)	Limit (dBuV/m)	Margin (dB)	Height (cm)	Polarization	Azimuth (deg)	Correct Factor (dB)
26795.31	53.01	---	74.00	20.99	100.0	V	308.00	8
26810.50	---	42.01	54.00	11.99	200.0	V	255.00	8
30003.25	54.69	---	74.00	19.31	100.0	H	24.00	7
30030.25	---	43.11	54.00	10.89	100.0	H	191.00	7
31518.63	---	43.38	54.00	10.62	200.0	V	166.00	8
31523.69	54.66	---	74.00	19.34	200.0	V	0.00	8
33970.56	---	42.72	54.00	11.28	200.0	V	81.00	8
33973.94	54.26	---	74.00	19.74	100.0	H	281.00	8
35425.19	53.05	---	74.00	20.95	200.0	V	306.00	8
35656.38	---	41.77	54.00	12.23	200.0	V	51.00	8
37335.44	54.84	---	74.00	19.16	100.0	V	283.00	11
37342.19	---	43.28	54.00	10.72	100.0	H	95.00	11

Remark: 1. Correction Factor = Antenna factor+ Insertion loss (cable loss + amplifier gain)

### 5.6. Conducted Emission

#### Ambient condition

Temperature	Relative humidity	Pressure
23°C ~25°C	45%~50%	101.5kPa

#### Methods of Measurement

The EUT IS placed on a non-metallic table of 80cm height above the horizontal metal reference ground plane. During the test, the EUT was operating in its typical mode. The test method is according to ANSI C63.10. Connect the AC power line of the EUT to the LISN Use EMI receiver to detect the average and Quasi-peak value. RBW is set to 9kHz, VBW is set to 30kHz The measurement result should include both L line and N line.

The test is in transmitting mode.

#### Test Setup

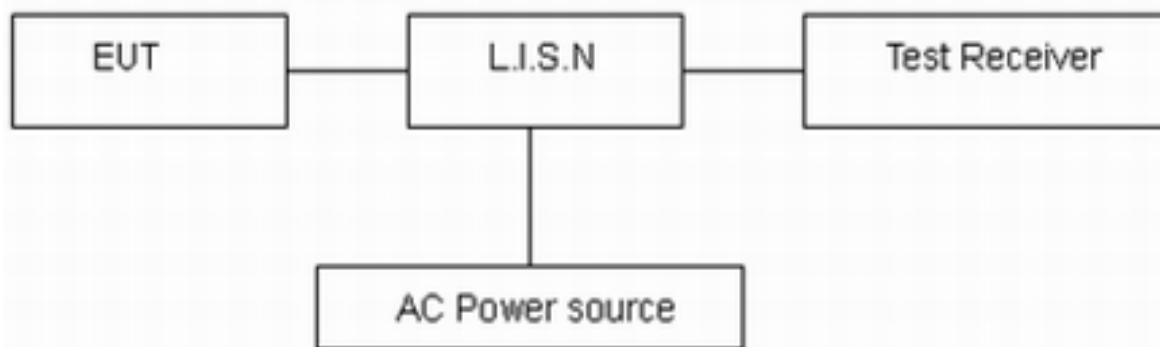

Note: AC Power source is used to change the voltage 110V/60Hz.

#### Limits

Frequency (MHz)	Conducted Limits(dBμV)	
	Quasi-peak	Average
0.15 - 0.5	66 to 56 *	56 to 46 *
0.5 - 5	56	46
5 - 30	60	50

\*: Decreases with the logarithm of the frequency.

#### Measurement Uncertainty

The assessed measurement uncertainty to ensure 95% confidence level for the normal distribution is with the coverage factor  $k = 1.96$ ,  $U = 2.69$  dB.

**Test Results:**

Following plots, Blue trace uses the peak detection and Green trace uses the average detection. During the test, the Conducted Emission was performed in all modes with all channels, 802.11ax (HE40), Channel 46 are selected as the worst condition. The test data of the worst-case condition was recorded in this report.

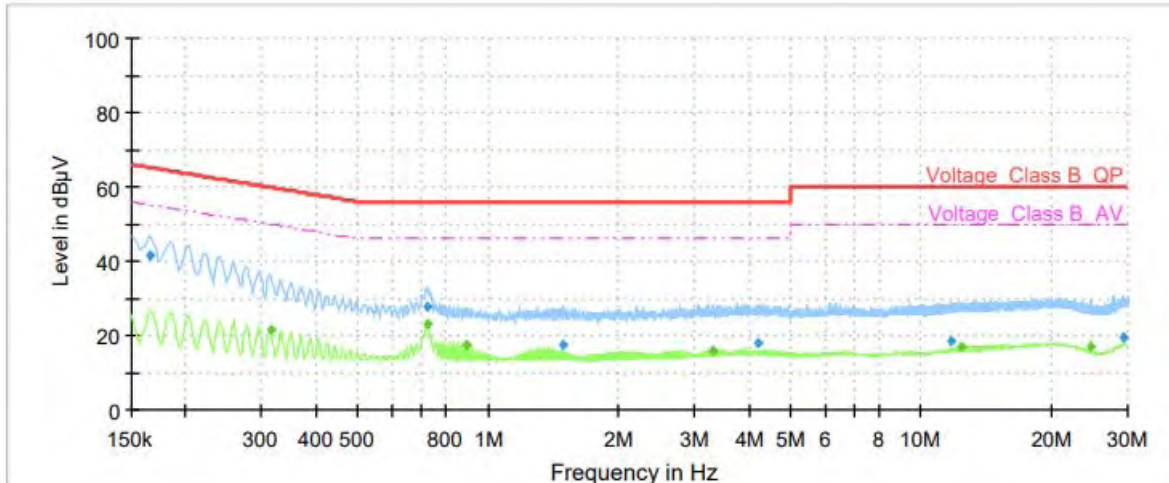

Frequency (MHz)	QuasiPeak (dBµV)	Average (dBµV)	Limit (dBµV)	Margin (dB)	Meas. Time (ms)	Bandwidth (kHz)	Line	Filter	Corr. (dB)
0.17	41.63	---	65.17	23.54	1000.00	9.000	L1	ON	21
0.31	---	21.72	49.86	28.14	1000.00	9.000	L1	ON	21
0.72	---	23.21	46.00	22.79	1000.00	9.000	L1	ON	20
0.72	27.64	---	56.00	28.36	1000.00	9.000	L1	ON	20
0.89	---	17.41	46.00	28.59	1000.00	9.000	L1	ON	20
1.49	17.62	---	56.00	38.38	1000.00	9.000	L1	ON	20
3.28	---	16.03	46.00	29.97	1000.00	9.000	L1	ON	19
4.19	17.82	---	56.00	38.18	1000.00	9.000	L1	ON	19
11.76	18.44	---	60.00	41.56	1000.00	9.000	L1	ON	20
12.40	---	16.68	50.00	33.32	1000.00	9.000	L1	ON	20
24.54	---	16.78	50.00	33.22	1000.00	9.000	L1	ON	20
29.29	19.68	---	60.00	40.32	1000.00	9.000	L1	ON	20

**Remark: Correct factor=cable loss + LISN factor**

L line Conducted Emission from 150 KHz to 30 MHz

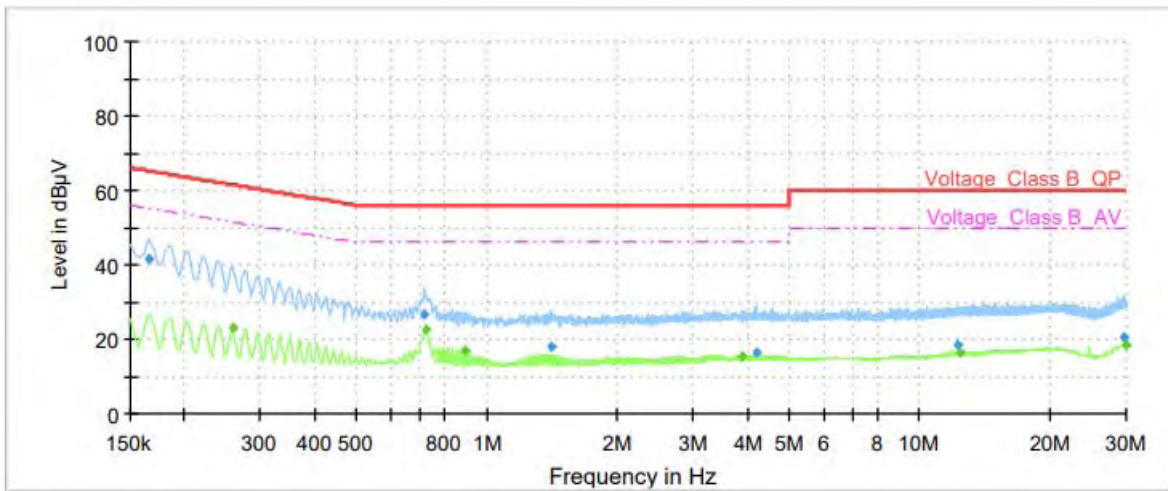

Frequency (MHz)	QuasiPeak (dBµV)	Average (dBµV)	Limit (dBµV)	Margin (dB)	Meas. Time (ms)	Bandwidth (kHz)	Line	Filter	Corr. (dB)
0.17	41.68	---	65.17	23.49	1000.00	9.000	N	ON	21
0.26	---	23.15	51.50	28.35	1000.00	9.000	N	ON	21
0.72	26.84	---	56.00	29.16	1000.00	9.000	N	ON	20
0.72	---	22.80	46.00	23.20	1000.00	9.000	N	ON	20
0.89	---	16.84	46.00	29.16	1000.00	9.000	N	ON	20
1.40	17.77	---	56.00	38.23	1000.00	9.000	N	ON	20
3.89	---	15.55	46.00	30.45	1000.00	9.000	N	ON	19
4.18	16.51	---	56.00	39.49	1000.00	9.000	N	ON	19
12.28	18.65	---	60.00	41.35	1000.00	9.000	N	ON	20
12.40	---	16.57	50.00	33.43	1000.00	9.000	N	ON	20
29.56	20.63	---	60.00	39.37	1000.00	9.000	N	ON	20
29.87	---	18.44	50.00	31.56	1000.00	9.000	N	ON	20

Remark: Correct factor=cable loss + LISN factor

N line Conducted Emission from 150 KHz to 30 MHz





## 6. Main Test Instruments

Date of Testing: April 29, 2022 ~ May 9, 2022

Name	Manufacturer	Type	Serial Number	Calibration Date	Expiration Date
Power sensor	R&S	NRP18S	101954	2021-05-15	2022-05-14
Spectrum Analyzer	KEYSIGHT	N9020A	MY52330084	2021-05-15	2022-05-14
DC Power Supply	GWINSTEK	GPS-3030D	GEP882653	2021-05-15	2022-05-14
Climate Chamber	ESPEC	SU-242	93000506	2021-12-12	2022-12-11

Date of Testing: April 15, 2022 ~ May 25, 2022

Name	Manufacturer	Type	Serial Number	Calibration Date	Expiration Date
Radiated Emission					
EMI Test Receiver	R&S	ESC17	100936	2021-12-12	2022-12-11
Signal Analyzer	R&S	FSV40	101297	2021-05-15	2022-05-14
				2021-12-12	2022-12-11
Signal Analyzer	R&S	FSV30	100815	2021-05-15	2022-05-14
				2021-12-12	2022-12-11
TRILOG Broadband Antenna	SCHWARZBECK	VULB 9163	391	2019-12-16	2022-12-15
Loop antenna	SCHWARZBECK	FMZB1519	1519-047	2020-04-02	2023-04-01
Horn Antenna	Schwarzbeck	BBHA 9120D	430	2021-07-26	2024-07-25
Horn Antenna	ETS-Lindgren	3160-09	00102643	2021-10-10	2024-10-09
Horn Antenna	STEATITE	QSH-SL-26-40 -K-15	16779	2019-12-24	2022-12-23
Software	R&S	EMC32	9.26.01	/	/
Conducted Emission					
Artificial main network	R&S	ENV216	102191	2020-12-13	2022-12-12
EMI Test Receiver	R&S	ESR	102389	2021-05-15	2022-05-14
				2021-06-04	2022-06-03
Software	R&S	EMC32	10.35.10	/	/

Date of Testing: June 1, 2022

Name	Manufacturer	Type	Serial Number	Calibration Date	Expiration Date
Spectrum Analyzer	KEYSIGHT	N9020A	MY54420163	2021-12-12	2022-12-11

\*\*\*\*\*END OF REPORT \*\*\*\*\*



## ANNEX A: The EUT Appearance

The EUT Appearance are submitted separately.



## **ANNEX B: Test Setup Photos**

The Test Setup Photos are submitted separately.