

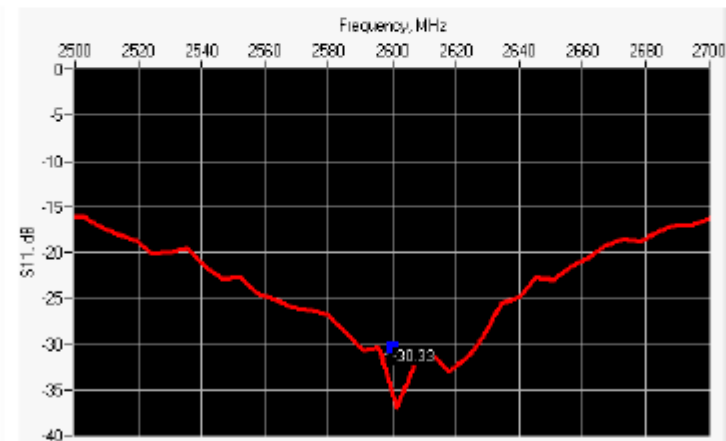

10 g	20.1 %
------	--------

6 CALIBRATION MEASUREMENT RESULTS

6.1 RETURN LOSS AND IMPEDANCE IN HEAD LIQUID



Frequency (MHz)	Return Loss (dB)	Requirement (dB)	Impedance
2600	-30.33	-20	53.1 Ω - 0.7 j Ω

6.2 RETURN LOSS AND IMPEDANCE IN BODY LIQUID

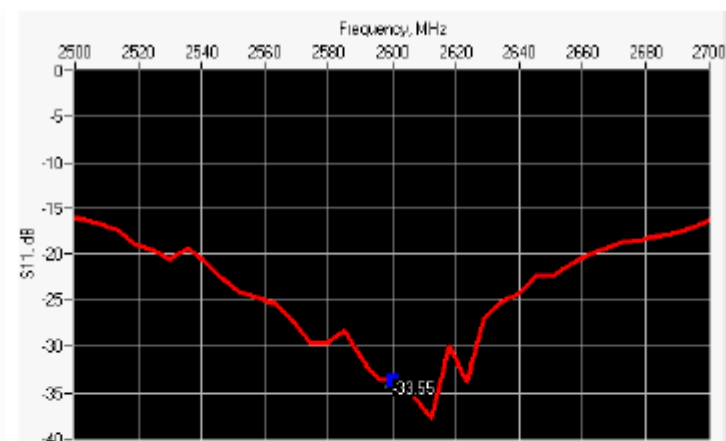

Frequency (MHz)	Return Loss (dB)	Requirement (dB)	Impedance
2600	-33.55	-20	49.4 Ω - 2.1 j Ω

6.3 MECHANICAL DIMENSIONS

Frequency MHz	L mm		h mm		d mm	
	required	measured	required	measured	required	measured
300	420.0 \pm 1 %		250.0 \pm 1 %		6.35 \pm 1 %	



SAR REFERENCE DIPOLE CALIBRATION REPORT

Ref. ACR.332.10.17.SATUA

450	290.0 ±1 %		166.7 ±1 %		6.35 ±1 %	
750	176.0 ±1 %		100.0 ±1 %		6.35 ±1 %	
835	161.0 ±1 %		89.8 ±1 %		3.6 ±1 %	
900	149.0 ±1 %		83.3 ±1 %		3.6 ±1 %	
1450	89.1 ±1 %		51.7 ±1 %		3.6 ±1 %	
1500	80.5 ±1 %		50.0 ±1 %		3.6 ±1 %	
1640	79.0 ±1 %		45.7 ±1 %		3.6 ±1 %	
1750	75.2 ±1 %		42.9 ±1 %		3.6 ±1 %	
1800	72.0 ±1 %		41.7 ±1 %		3.6 ±1 %	
1900	68.0 ±1 %		39.5 ±1 %		3.6 ±1 %	
1950	66.3 ±1 %		38.5 ±1 %		3.6 ±1 %	
2000	64.5 ±1 %		37.5 ±1 %		3.6 ±1 %	
2100	61.0 ±1 %		35.7 ±1 %		3.6 ±1 %	
2300	55.5 ±1 %		32.6 ±1 %		3.6 ±1 %	
2450	51.5 ±1 %		30.4 ±1 %		3.6 ±1 %	
2600	48.5 ±1 %	PASS	28.8 ±1 %	PASS	3.6 ±1 %	PASS
3000	41.5 ±1 %		25.0 ±1 %		3.6 ±1 %	
3500	37.0 ±1 %		26.4 ±1 %		3.6 ±1 %	
3700	34.7 ±1 %		26.4 ±1 %		3.6 ±1 %	

7 VALIDATION MEASUREMENT

The IEEE Std. 1528, FCC KDBs and CEI/IEC 62209 standards state that the system validation measurements must be performed using a reference dipole meeting the fore mentioned return loss and mechanical dimension requirements. The validation measurement must be performed against a liquid filled flat phantom, with the phantom constructed as outlined in the fore mentioned standards. Per the standards, the dipole shall be positioned below the bottom of the phantom, with the dipole length centered and parallel to the longest dimension of the flat phantom, with the top surface of the dipole at the described distance from the bottom surface of the phantom.

7.1 HEAD LIQUID MEASUREMENT

Frequency MHz	Relative permittivity (ϵ_r)		Conductivity (σ) S/m	
	required	measured	required	measured
300	45.3 ±5 %		0.87 ±5 %	
450	43.5 ±5 %		0.87 ±5 %	
750	41.9 ±5 %		0.89 ±5 %	
835	41.5 ±5 %		0.90 ±5 %	
900	41.5 ±5 %		0.97 ±5 %	
1450	40.5 ±5 %		1.20 ±5 %	
1500	40.4 ±5 %		1.23 ±5 %	
1640	40.2 ±5 %		1.31 ±5 %	
1750	40.1 ±5 %		1.37 ±5 %	

Page: 7/11



SAR REFERENCE DIPOLE CALIBRATION REPORT

Ref. ACR.332.10.17.SATU.A

1800	40.0 ± 5 %		1.40 ± 5 %	
1900	40.0 ± 5 %		1.40 ± 5 %	
1950	40.0 ± 5 %		1.40 ± 5 %	
2000	40.0 ± 5 %		1.40 ± 5 %	
2100	39.8 ± 5 %		1.49 ± 5 %	
2300	39.5 ± 5 %		1.67 ± 5 %	
2450	39.2 ± 5 %		1.80 ± 5 %	
2600	39.0 ± 5 %	PASS	1.96 ± 5 %	PASS
3000	38.5 ± 5 %		2.40 ± 5 %	
3500	37.9 ± 5 %		2.91 ± 5 %	

7.2 SAR MEASUREMENT RESULT WITH HEAD LIQUID

The IEEE Std. 1528 and CEI/IEC 62209 standards state that the system validation measurements should produce the SAR values shown below (for phantom thickness of 2 mm), within the uncertainty for the system validation. All SAR values are normalized to 1 W forward power. In bracket, the measured SAR is given with the used input power.

Software	OPENSAR V4
Phantom	SN 20/09 SAM71
Probe	SN 18/11 EPG122
Liquid	Head Liquid Values: $\epsilon_s' : 38.5$ $\sigma : 2.01$
Distance between dipole center and liquid	10.0 mm
Area scan resolution	$dx=8mm/dy=8mm$
Zoon Scan Resolution	$dx=5mm/dy=5mm/dz=5mm$
Frequency	2600 MHz
Input power	20 dBm
Liquid Temperature	21 °C
Lab Temperature	21 °C
Lab Humidity	45 %

Frequency MHz	1 g SAR (W/kg/W)		10 g SAR (W/kg/W)	
	required	measured	required	measured
300	2.85		1.94	
450	4.58		3.06	
750	8.49		5.55	
835	9.56		6.22	
900	10.9		6.99	
1450	29		16	
1500	30.5		16.8	
1640	34.2		18.4	
1750	36.4		19.3	
1800	38.4		20.1	

SAR REFERENCE DIPOLE CALIBRATION REPORT

Ref. ACR.332.10.17.SATU.A

1900	39.7		20.5	
1950	40.5		20.9	
2000	41.1		21.1	
2100	43.6		21.9	
2300	48.7		23.3	
2450	52.4		24	
2600	55.3	55.47 (5.55)	24.6	24.49 (2.45)
3000	63.8		25.7	
3500	67.1		25	
3700	67.4		24.2	

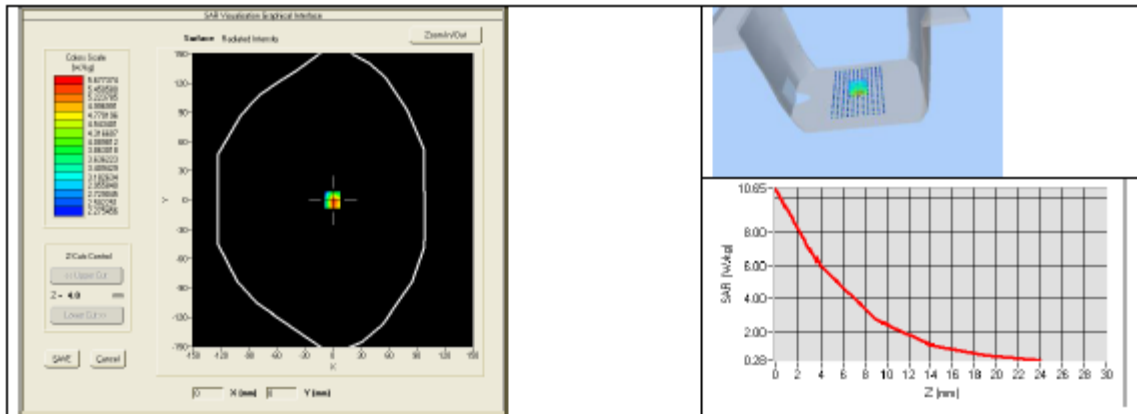
7.3 BODY LIQUID MEASUREMENT

Frequency MHz	Relative permittivity (ϵ_r')		Conductivity (σ) S/m	
	required	measured	required	measured
150	61.9 ± 5 %		0.80 ± 5 %	
300	58.2 ± 5 %		0.92 ± 5 %	
450	56.7 ± 5 %		0.94 ± 5 %	
750	55.5 ± 5 %		0.96 ± 5 %	
835	55.2 ± 5 %		0.97 ± 5 %	
900	55.0 ± 5 %		1.05 ± 5 %	
915	55.0 ± 5 %		1.06 ± 5 %	
1450	54.0 ± 5 %		1.30 ± 5 %	
1610	53.8 ± 5 %		1.40 ± 5 %	
1800	53.3 ± 5 %		1.52 ± 5 %	
1900	53.3 ± 5 %		1.52 ± 5 %	
2000	53.3 ± 5 %		1.52 ± 5 %	
2100	53.2 ± 5 %		1.62 ± 5 %	
2300	52.9 ± 5 %		1.81 ± 5 %	



SAR REFERENCE DIPOLE CALIBRATION REPORT

Ref. ACR.332.10.17.SATUA

2450	52.7 ± 5 %		1.95 ± 5 %	
2600	52.5 ± 5 %	PASS	2.16 ± 5 %	PASS
3000	52.0 ± 5 %		2.73 ± 5 %	
3500	51.3 ± 5 %		3.31 ± 5 %	
3700	51.0 ± 5 %		3.55 ± 5 %	
5200	49.0 ± 10 %		5.30 ± 10 %	
5300	48.9 ± 10 %		5.42 ± 10 %	
5400	48.7 ± 10 %		5.53 ± 10 %	
5500	48.6 ± 10 %		5.65 ± 10 %	
5600	48.5 ± 10 %		5.77 ± 10 %	
5800	48.2 ± 10 %		6.00 ± 10 %	

7.4 SAR MEASUREMENT RESULT WITH BODY LIQUID

Software	OPENSAR V4
Phantom	SN 20/09 SAM71
Probe	SN 18/11 EPG122
Liquid	Body Liquid Values: ϵ_p : 52.0 σ : 2.16
Distance between dipole center and liquid	10.0 mm
Area scan resolution	dx=8mm/dy=8mm
Zoon Scan Resolution	dx=5mm/dy=5mm/dz=5mm
Frequency	2600 MHz
Input power	20 dBm
Liquid Temperature	21 °C
Lab Temperature	21 °C
Lab Humidity	45 %

Frequency MHz	1 g SAR (W/kg/W)	10 g SAR (W/kg/W)
	measured	measured
2600	53.45 (5.34)	24.00 (2.40)

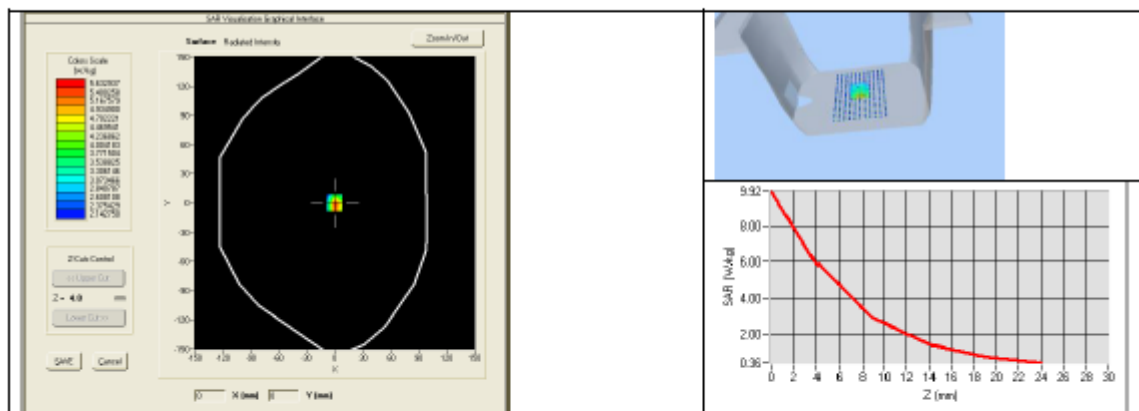

**8 LIST OF EQUIPMENT**

Equipment Summary Sheet				
Equipment Description	Manufacturer / Model	Identification No.	Current Calibration Date	Next Calibration Date
SAM Phantom	MVG	SN-20/09-SAM71	Validated. No cal required.	Validated. No cal required.
COMOSAR Test Bench	Version 3	NA	Validated. No cal required.	Validated. No cal required.
Network Analyzer	Rhode & Schwarz ZVA	SN100132	02/2016	02/2019
Calipers	Carrera	CALIPER-01	01/2017	01/2020
Reference Probe	MVG	EPG122 SN 18/11	10/2017	10/2018
Multimeter	Keithley 2000	1188656	01/2017	01/2020
Signal Generator	Agilent E4438C	MY49070581	01/2017	01/2020
Amplifier	Aethercomm	SN 046	Characterized prior to test. No cal required.	Characterized prior to test. No cal required.
Power Meter	HP E4418A	US38261498	01/2017	01/2020
Power Sensor	HP ECP-E26A	US37181460	01/2017	01/2020
Directional Coupler	Narda 4216-20	01386	Characterized prior to test. No cal required.	Characterized prior to test. No cal required.
Temperature and Humidity Sensor	Control Company	150798832	11/2017	11/2020

SID5G Dipole Calibration Report

**SAR Reference Waveguide Calibration Report**

Ref: ACR.332.11.17.SATU.A

**CCIC SOUTHERN ELECTRONIC PRODUCT
TESTING (SHENZHEN) CO., LTD**
ELECTRONIC TESTING BUILDING, NO. 43 SHAHE ROAD,
XILI JIEDAO, NANSHAN DISTRICT
SHENZHEN, GUANGDONG, CHINA
MVG COMOSAR REFERENCE WAVEGUIDE
FREQUENCY: 5000-6000 MHZ
SERIAL NO.: SN 15/15 WGA39

Calibrated at MVG US
2105 Barrett Park Dr. - Kennesaw, GA 30144



Calibration Date: 11/27/17

Summary:

This document presents the method and results from an accredited SAR reference waveguide calibration performed in MVG USA using the COMOSAR test bench. All calibration results are traceable to national metrology institutions.



SAR REFERENCE WAVEGUIDE CALIBRATION REPORT

Ref: ACR.332.11.17.SATU.A

	<i>Name</i>	<i>Function</i>	<i>Date</i>	<i>Signature</i>
<i>Prepared by :</i>	Jérôme LUC	Product Manager	11/28/2017	<i>JS</i>
<i>Checked by :</i>	Jérôme LUC	Product Manager	11/28/2017	<i>JS</i>
<i>Approved by :</i>	Kim RUTKOWSKI	Quality Manager	11/28/2017	<i>Kim Rutkowski</i>

	<i>Customer Name</i>
<i>Distribution :</i>	CCIC SOUTHERN ELECTRONIC PRODUCT TESTING (SHENZHEN) Co., Ltd

<i>Issue</i>	<i>Date</i>	<i>Modifications</i>
A	11/28/2017	Initial release



TABLE OF CONTENTS

1 Introduction.....4

2 Device Under Test4

3 Product Description4

 3.1 General Information 4

4 Measurement Method4

 4.1 Return Loss Requirements4

 4.2 Mechanical Requirements4

5 Measurement Uncertainty 5

 5.1 Return Loss 5

 5.2 Dimension Measurement 5

 5.3 Validation Measurement 5

6 Calibration Measurement Results 5

 6.1 Return Loss 5

 6.2 Mechanical Dimensions 6

7 Validation measurement 7

 7.1 Head Liquid Measurement 7

 7.2 Measurement Result 7

 7.3 Body Measurement Result 10

8 List of Equipment 13



1 INTRODUCTION

This document contains a summary of the requirements set forth by the IEEE 1528 and CEI/IEC 62209 standards for reference waveguides used for SAR measurement system validations and the measurements that were performed to verify that the product complies with the fore mentioned standards.

2 DEVICE UNDER TEST

Device Under Test	
Device Type	COMOSAR 5000-6000 MHz REFERENCE WAVEGUIDE
Manufacturer	MVG
Model	SWG5500
Serial Number	SN 15/15 WGA39
Product Condition (new / used)	Used

A yearly calibration interval is recommended.

3 PRODUCT DESCRIPTION

3.1 GENERAL INFORMATION

MVG's COMOSAR Validation Waveguides are built in accordance to the IEEE 1528 and CEI/IEC 62209 standards.

4 MEASUREMENT METHOD

The IEEE 1528 and CEI/IEC 62209 standards provide requirements for reference waveguides used for system validation measurements. The following measurements were performed to verify that the product complies with the fore mentioned standards.

4.1 RETURN LOSS REQUIREMENTS

The waveguide used for SAR system validation measurements and checks must have a return loss of -8 dB or better. The return loss measurement shall be performed with matching layer placed in the open end of the waveguide, with the waveguide and matching layer in direct contact with the phantom shell as outlined in the fore mentioned standards.

4.2 MECHANICAL REQUIREMENTS

The IEEE 1528 and CEI/IEC 62209 standards specify the mechanical dimensions of the validation waveguide, the specified dimensions are as shown in Section 6.2. Figure 1 shows how the dimensions relate to the physical construction of the waveguide.



5 MEASUREMENT UNCERTAINTY

All uncertainties listed below represent an expanded uncertainty expressed at approximately the 95% confidence level using a coverage factor of $k=2$, traceable to the Internationally Accepted Guides to Measurement Uncertainty.

5.1 RETURN LOSS

The following uncertainties apply to the return loss measurement:

Frequency band	Expanded Uncertainty on Return Loss
400-6000MHz	0.1 dB

5.2 DIMENSION MEASUREMENT

The following uncertainties apply to the dimension measurements:

Length (mm)	Expanded Uncertainty on Length
3 - 300	0.05 mm

5.3 VALIDATION MEASUREMENT

The guidelines outlined in the IEEE 1528 and CEI/IEC 62209 standards were followed to generate the measurement uncertainty for validation measurements.

Scan Volume	Expanded Uncertainty
1 g	20.3 %
10 g	20.1 %

6 CALIBRATION MEASUREMENT RESULTS

6.1 RETURN LOSS IN HEAD LIQUID

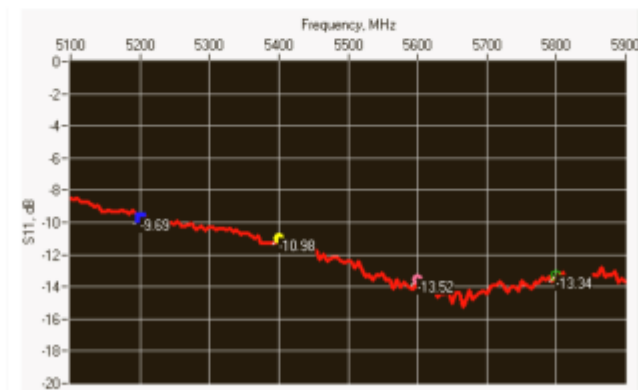



SAR REFERENCE WAVEGUIDE CALIBRATION REPORT

Ref: ACR.332.11.17.SATU.A

Frequency (MHz)	Return Loss (dB)	Requirement (dB)	Impedance
5200	-9.69	-8	25.64 Ω + 4.71 j Ω
5400	-10.98	-8	84.04 Ω + 17.11 j Ω
5600	-13.52	-8	36.63 Ω - 12.55 j Ω
5800	-13.34	-8	47.82 Ω + 21.42 j Ω

6.2 RETURN LOSS IN BODY LIQUID

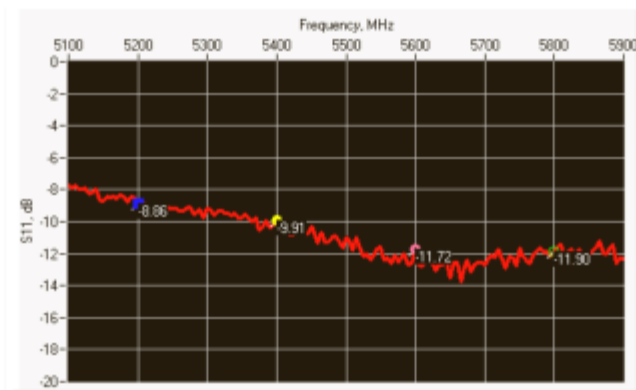

Frequency (MHz)	Return Loss (dB)	Requirement (dB)	Impedance
5200	-8.86	-8	23.97 Ω + 5.78 j Ω
5400	-9.91	-8	92.64 Ω + 17.22 j Ω
5600	-11.72	-8	32.59 Ω - 13.02 j Ω
5800	-11.90	-8	48.49 Ω + 25.88 j Ω

6.3 MECHANICAL DIMENSIONS

Frequency (MHz)	L (mm)		W (mm)		L _r (mm)		W _r (mm)		T (mm)	
	Require d	Measure d	Require d	Measure d	Require d	Measure d	Require d	Measure d	Require d	Measure d
5200	40.39 ± 0.13	PASS	20.19 ± 0.13	PASS	81.03 ± 0.13	PASS	61.98 ± 0.13	PASS	5.3*	PASS
5800	40.39 ± 0.13	PASS	20.19 ± 0.13	PASS	81.03 ± 0.13	PASS	61.98 ± 0.13	PASS	4.3*	PASS

* The tolerance for the matching layer is included in the return loss measurement.

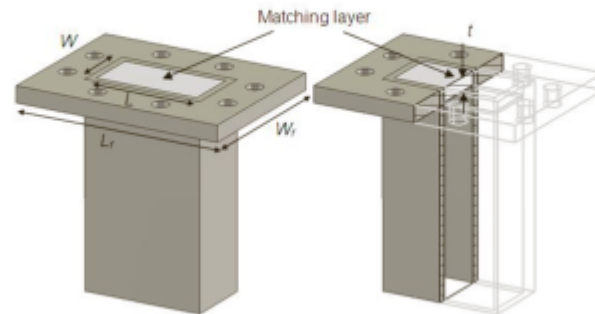

Figure 1: Validation Waveguide Dimensions

7 VALIDATION MEASUREMENT

The IEEE Std. 1528 and CEI/IEC 62209 standards state that the system validation measurements must be performed using a reference waveguide meeting the fore mentioned return loss and mechanical dimension requirements. The validation measurement must be performed with the matching layer placed in the open end of the waveguide, with the waveguide and matching layer in direct contact with the phantom shell.

7.1 HEAD LIQUID MEASUREMENT

Frequency MHz	Relative permittivity (ϵ_r')		Conductivity (σ) S/m	
	required	measured	required	measured
5000	36.2 \pm 10 %		4.45 \pm 10 %	
5100	36.1 \pm 10 %		4.56 \pm 10 %	
5200	36.0 \pm 10 %	PASS	4.66 \pm 10 %	PASS
5300	35.9 \pm 10 %	PASS	4.76 \pm 10 %	PASS
5400	35.8 \pm 10 %	PASS	4.86 \pm 10 %	PASS
5500	35.6 \pm 10 %	PASS	4.97 \pm 10 %	PASS
5600	35.5 \pm 10 %	PASS	5.07 \pm 10 %	PASS
5700	35.4 \pm 10 %		5.17 \pm 10 %	
5800	35.3 \pm 10 %	PASS	5.27 \pm 10 %	PASS
5900	35.2 \pm 10 %		5.38 \pm 10 %	
6000	35.1 \pm 10 %		5.48 \pm 10 %	

7.2 SAR MEASUREMENT RESULT WITH HEAD LIQUID

At those frequencies, the target SAR value can not be generic. Hereunder is the target SAR value defined by MVG, within the uncertainty for the system validation. All SAR values are normalized to 1 W net power. In bracket, the measured SAR is given with the used input power.



SAR REFERENCE WAVEGUIDE CALIBRATION REPORT

Ref: ACR.332.11.17.SATU.A

Software	OPENSAR V4
Phantom	SN 20/09 SAM71
Probe	SN 18/11 EPG122
Liquid	Head Liquid Values 5200 MHz: eps' :35.14 sigma : 4.74 Head Liquid Values 5400 MHz: eps' :34.52 sigma : 4.77 Head Liquid Values 5600 MHz: eps' :37.08 sigma : 5.03 Head Liquid Values 5800 MHz: eps' :34.64 sigma : 5.19
Distance between dipole waveguide and liquid	0 mm
Area scan resolution	dx=8mm/dy=8mm
Zoon Scan Resolution	dx=4mm/dy=4m/dz=2mm
Frequency	5200 MHz 5400 MHz 5600 MHz 5800 MHz
Input power	20 dBm
Liquid Temperature	21 °C
Lab Temperature	21 °C
Lab Humidity	45 %

Frequency (MHz)	1 g SAR (W/kg)		10 g SAR (W/kg)	
	required	measured	required	measured
5200	159.00	164.10 (16.41)	56.90	55.98 (5.60)
5400	166.40	171.25 (17.13)	58.43	57.79 (5.78)
5600	173.80	178.98 (17.90)	59.97	59.93 (5.99)
5800	181.20	185.54 (18.55)	61.50	61.47 (6.15)

SAR MEASUREMENT PLOTS @ 5200 MHz

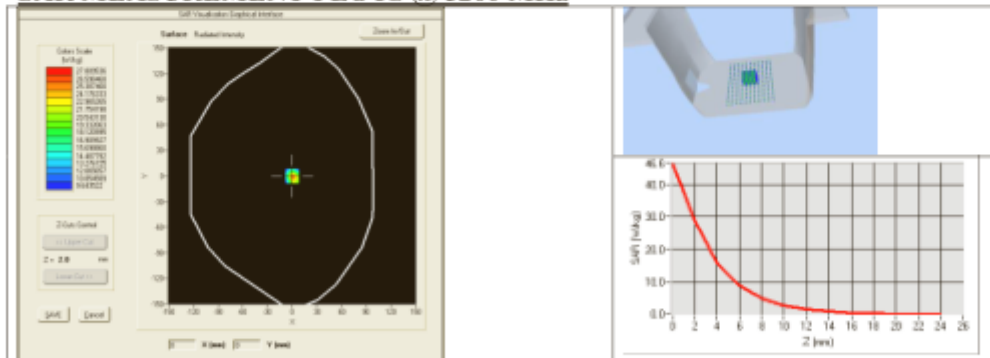



SAR MEASUREMENT PLOTS @ 5400 MHz

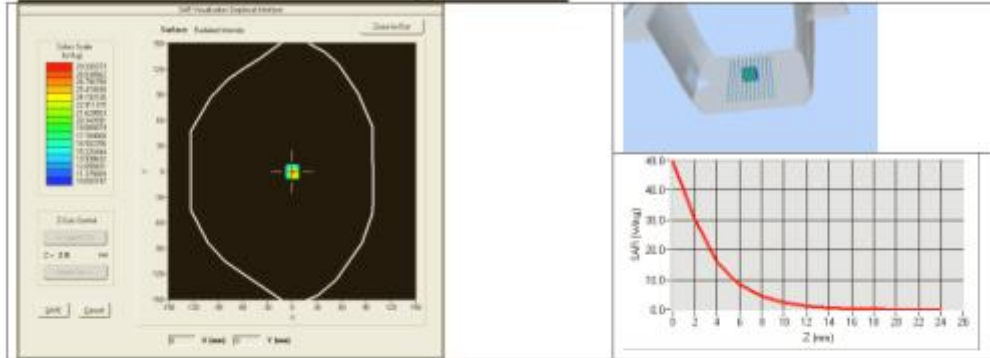

SAR MEASUREMENT PLOTS @ 5600 MHz

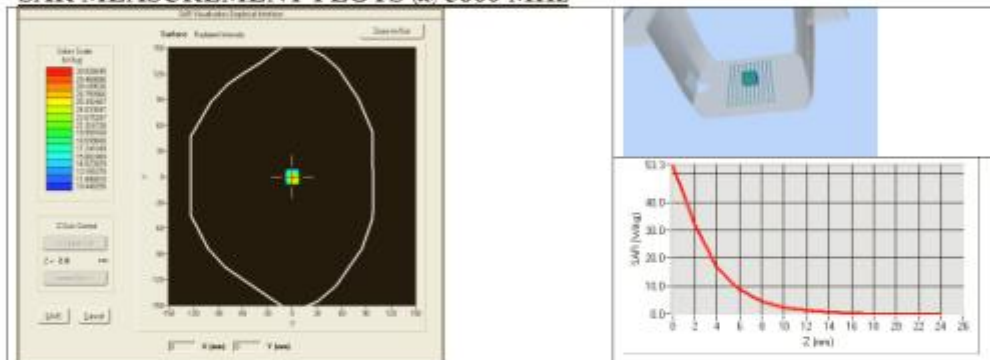

SAR MEASUREMENT PLOTS @ 5800 MHz

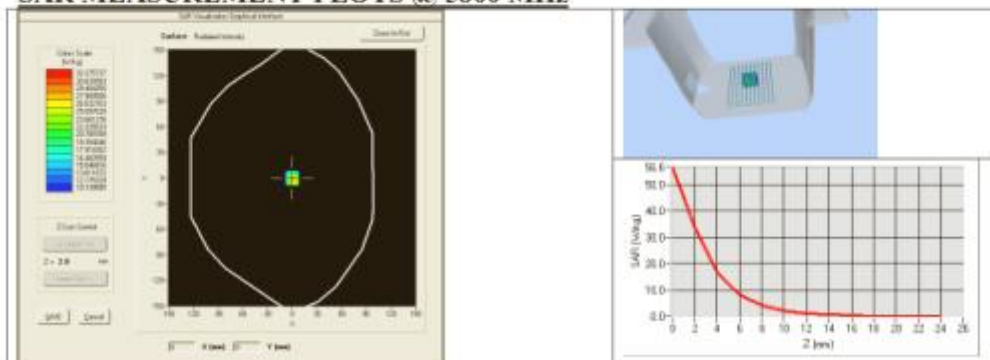



SAR REFERENCE WAVEGUIDE CALIBRATION REPORT

Ref: ACR.332.11.17.SATU.A

7.3 BODY LIQUID MEASUREMENT

Frequency MHz	Relative permittivity (ϵ_r)		Conductivity (σ) S/m	
	required	measured	required	measured
5200	49.0 \pm 10 %	PASS	5.30 \pm 10 %	PASS
5400	48.7 \pm 10 %	PASS	5.53 \pm 10 %	PASS
5600	48.5 \pm 10 %	PASS	5.77 \pm 10 %	PASS
5800	48.2 \pm 10 %	PASS	6.00 \pm 10 %	PASS

7.4 SAR MEASUREMENT RESULT WITH BODY LIQUID

Software	OPENSAR V4
Phantom	SN 20/09 SAM71
Probe	SN 18/11 EPG122
Liquid	Body Liquid Values 5200 MHz: ϵ_r :49.01 sigma : 5.27 Body Liquid Values 5400 MHz: ϵ_r :49.67 sigma : 5.45 Body Liquid Values 5600 MHz: ϵ_r :47.57 sigma : 5.69 Body Liquid Values 5800 MHz: ϵ_r :49.82 sigma : 5.94
Distance between dipole waveguide and liquid	0 mm
Area scan resolution	dx=8mm/dy=8mm
Zoon Scan Resolution	dx=4mm/dy=4m/dz=2mm
Frequency	5200 MHz 5400 MHz 5600 MHz 5800 MHz
Input power	20 dBm
Liquid Temperature	21 °C
Lab Temperature	21 °C
Lab Humidity	45 %

Frequency (MHz)	1 g SAR (W/kg)	10 g SAR (W/kg)
	measured	measured
5200	155.78 (15.58)	54.48 (5.45)
5400	160.24 (16.02)	55.34 (5.53)
5600	167.61 (16.76)	56.92 (5.69)
5800	170.49 (17.05)	57.26 (5.73)



BODY SAR MEASUREMENT PLOTS @ 5200 MHz

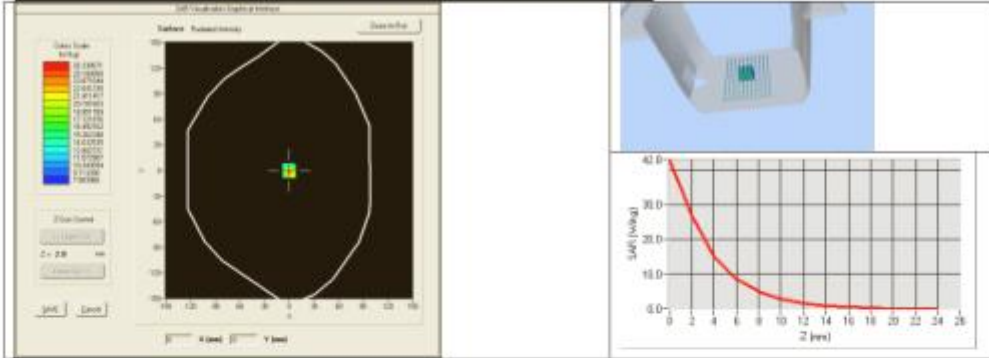

BODY SAR MEASUREMENT PLOTS @ 5400 MHz

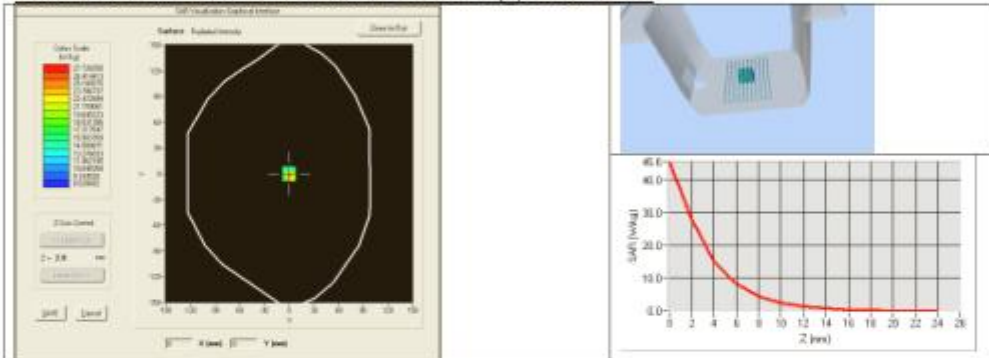

BODY SAR MEASUREMENT PLOTS @ 5600 MHz

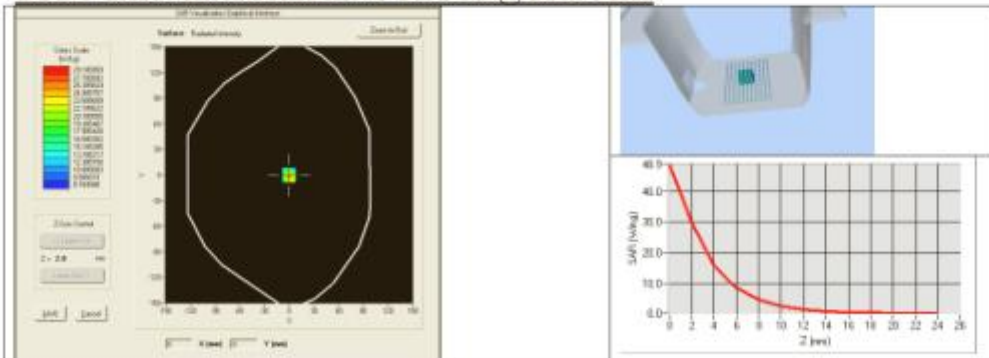

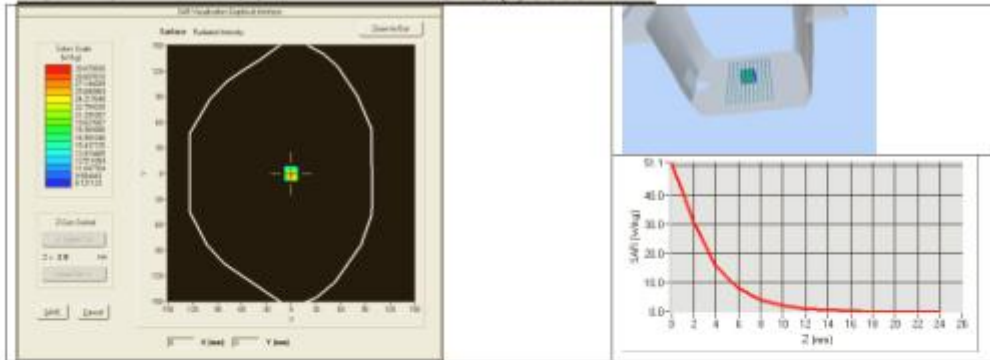
**BODY SAR MEASUREMENT PLOTS @ 5800 MHz**



8 LIST OF EQUIPMENT

Equipment Summary Sheet				
Equipment Description	Manufacturer / Model	Identification No.	Current Calibration Date	Next Calibration Date
Flat Phantom	MVG	SN-20/09-SAM71	Validated. No cal required.	Validated. No cal required.
COMOSAR Test Bench	Version 3	NA	Validated. No cal required.	Validated. No cal required.
Network Analyzer	Rhode & Schwarz ZVA	SN100132	02/2016	02/2019
Calipers	Carrera	CALIPER-01	01/2017	01/2020
Reference Probe	MVG	EPG122 SN 18/11	10/2017	10/2018
Multimeter	Keithley 2000	1188656	01/2017	01/2020
Signal Generator	Agilent E4438C	MY49070581	01/2017	01/2020
Amplifier	Aethercomm	SN 046	Characterized prior to test. No cal required.	Characterized prior to test. No cal required.
Power Meter	HP E4418A	US38261498	01/2017	01/2020
Power Sensor	HP ECP-E26A	US37181460	01/2017	01/2020
Directional Coupler	Narda 4216-20	01386	Characterized prior to test. No cal required.	Characterized prior to test. No cal required.
Temperature and Humidity Sensor	Control Company	150798832	11/2017	11/2020

<Justification of the extended calibration>

If dipoles are verified in return loss(<-20dB, within 20% of prior calibration),and in impedance (within 5 ohm of prior calibration), the annual calibration is not necessary and the calibration interval can be extended.

Head 750MHz				
Date of Measurement	Return Loss (dB)	Delta (%)	Impedance	Delta(ohm)
2017.11.27	-40.35	-	49.1	-
2019.11.26	-40.17	4.23	48.98	-0.12

The return loss is <-20dB, within 20% of prior calibration; the impedance is within 5ohm of prior calibration. Therefore the verification result should support extended calibration.

<Dipole Verification Data>

Head 750MHz

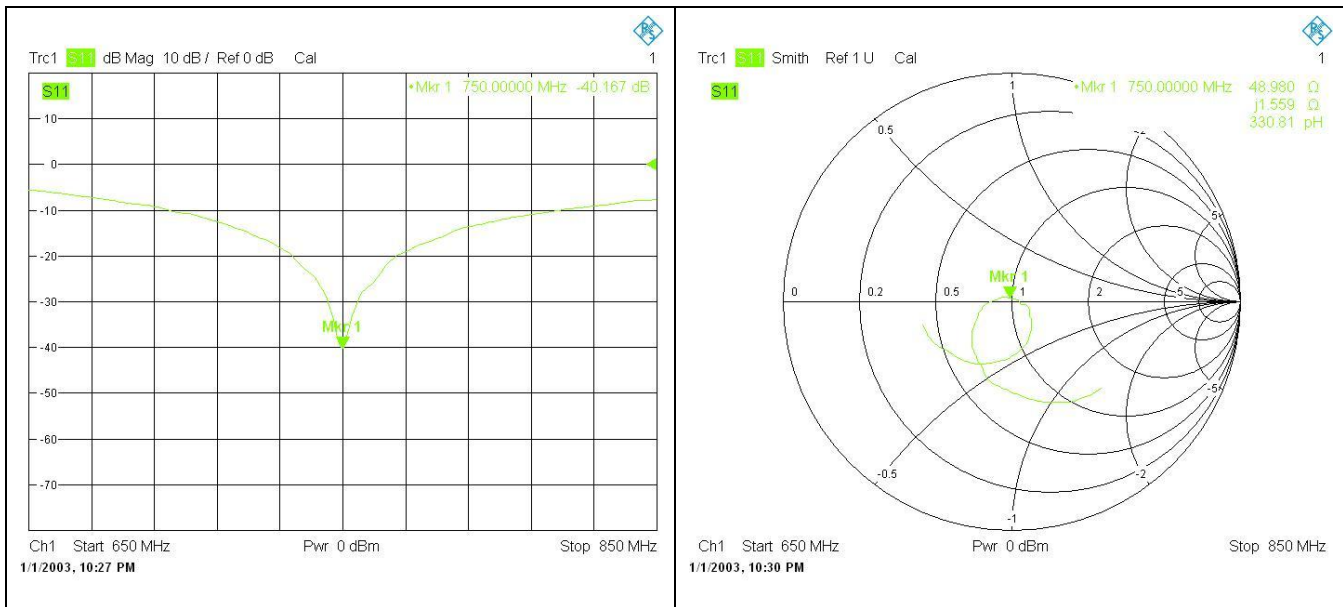



Head 835MHz				
Date of Measurement	Return Loss (dB)	Delta (%)	Impedance	Delta(ohm)
2017.11.27	-21.05	-	59.7	-
2019.11.26	-21.09	-0.93	59.74	0.04

The return loss is <math>< -20\text{dB}</math>, within 20% of prior calibration; the impedance is within 5ohm of prior calibration. Therefore the verification result should support extended calibration.

<Dipole Verification Data>

Head 835MHz

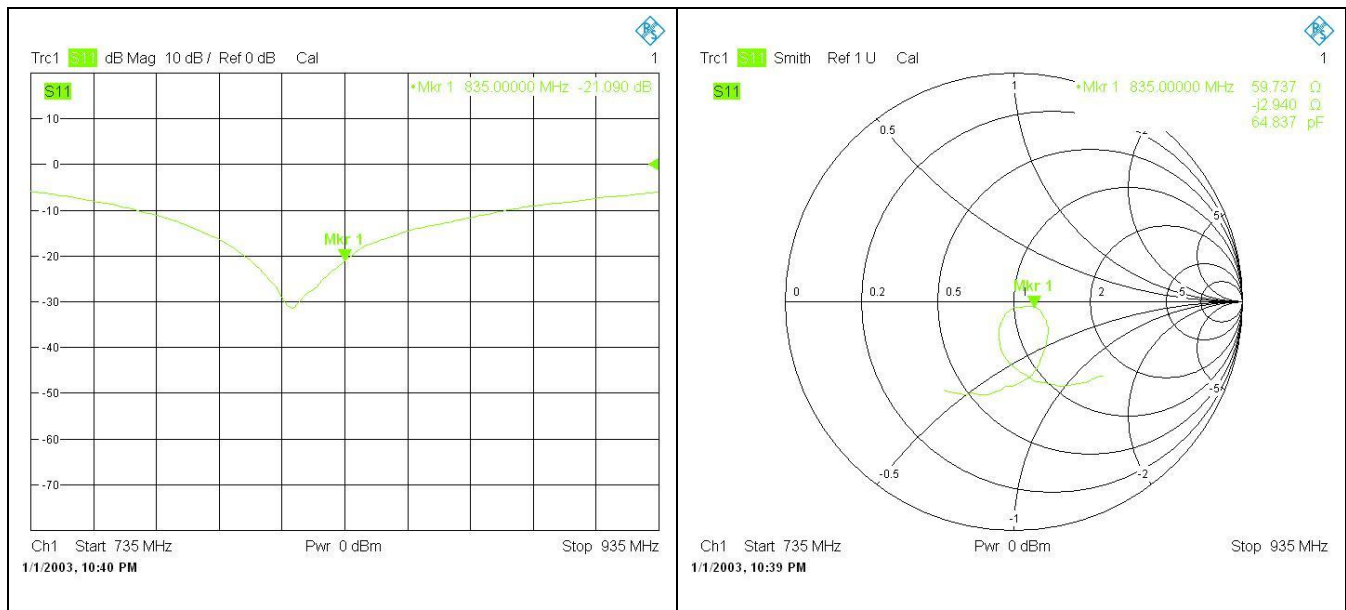



Head 1800MHz				
Date of Measurement	Return Loss (dB)	Delta (%)	Impedance	Delta(ohm)
2017.11.27	-21.94	-	44.7	-
2019.11.26	-21.48	11.17	44.12	-0.58

The return loss is <-20dB, within 20% of prior calibration; the impedance is within 5 ohm of prior calibration. Therefore the verification result should support extended calibration.

<Dipole Verification Data>

Head 1800MHz

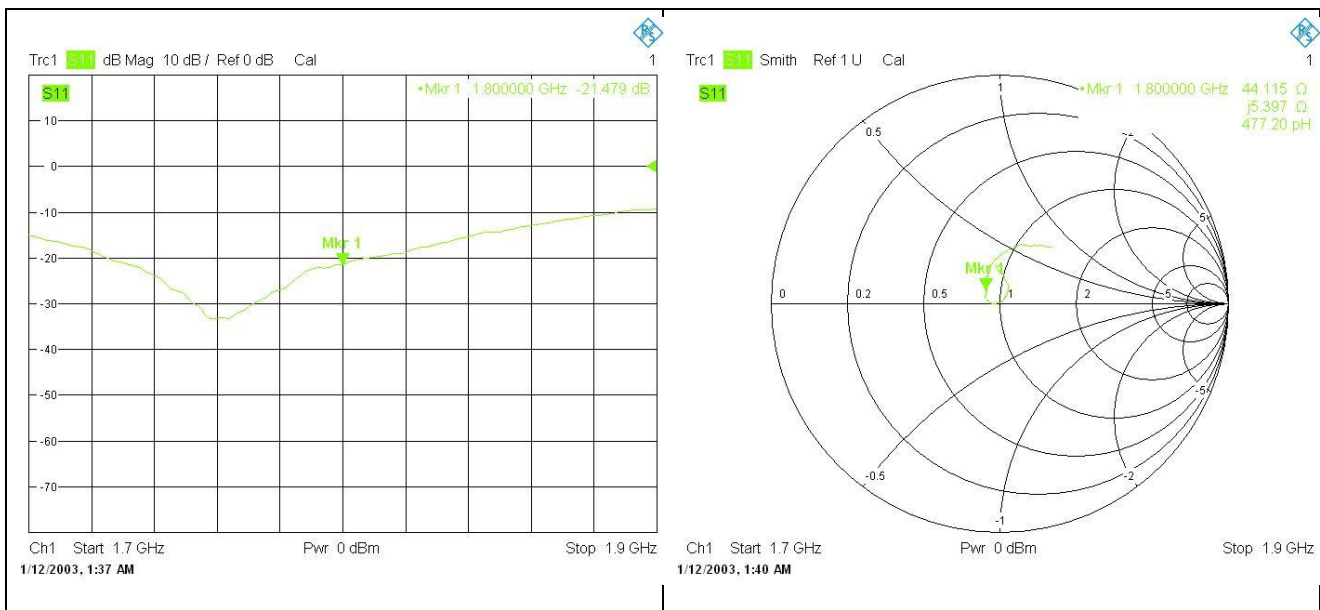



Head 1900MHz				
Date of Measurement	Return Loss (dB)	Delta (%)	Impedance	Delta(ohm)
2017.11.27	-24.08	-	51.2	-
2019.11.26	-24.07	0.23	54.29	3.09

The return loss is <-20dB, within 20% of prior calibration; the impedance is within 5 ohm of prior calibration. Therefore the verification result should support extended calibration.

<Dipole Verification Data>

Head 1900MHz

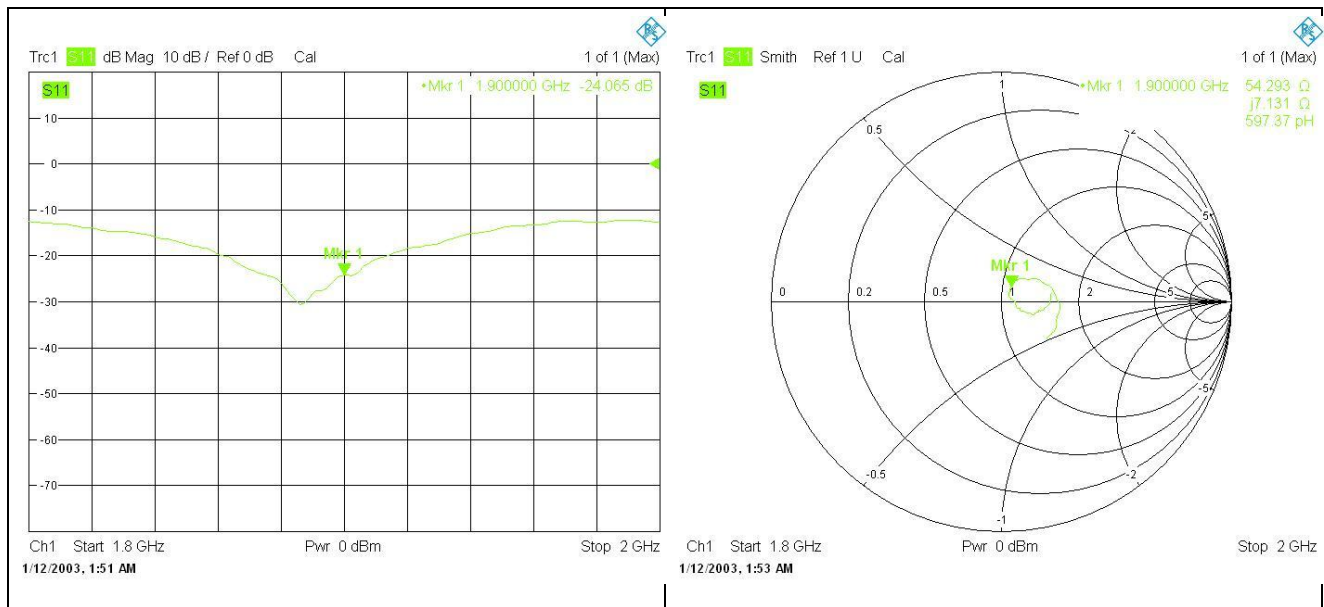



Head 2450MHz				
Date of Measurement	Return Loss (dB)	Delta (%)	Impedance	Delta(ohm)
2017.11.27	-27.94	-	49.5	-
2019.11.26	-27.59	8.39	47.93	-1.57

The return loss is <-20dB, within 20% of prior calibration; the impedance is within 5 ohm of prior calibration. Therefore the verification result should support extended calibration.

<Dipole Verification Data>

Head 2450MHz

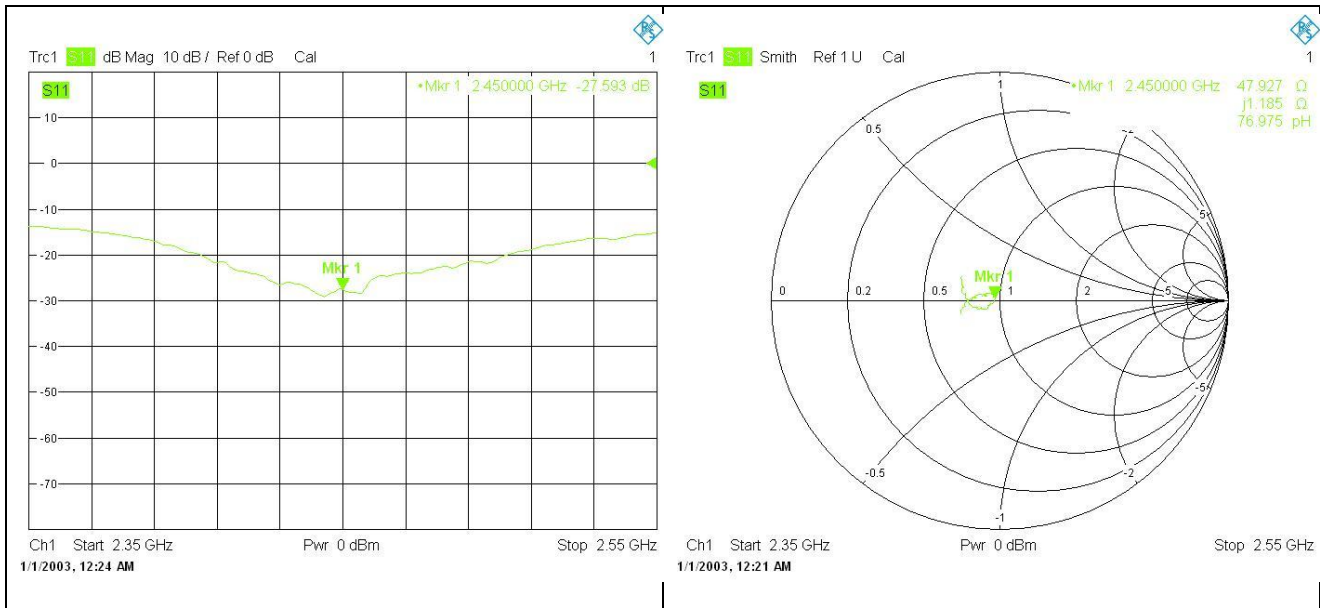



Head 2600MHz				
Date of Measurement	Return Loss (dB)	Delta (%)	Impedance	Delta(ohm)
2017.11.27	-30.33	-	53.1	-
2019.11.26	-29.92	9.90	51.54	-1.56

The return loss is <-20dB, within 20% of prior calibration; the impedance is within 5 ohm of prior calibration. Therefore the verification result should support extended calibration.

<Dipole Verification Data>

Head 2600MHz

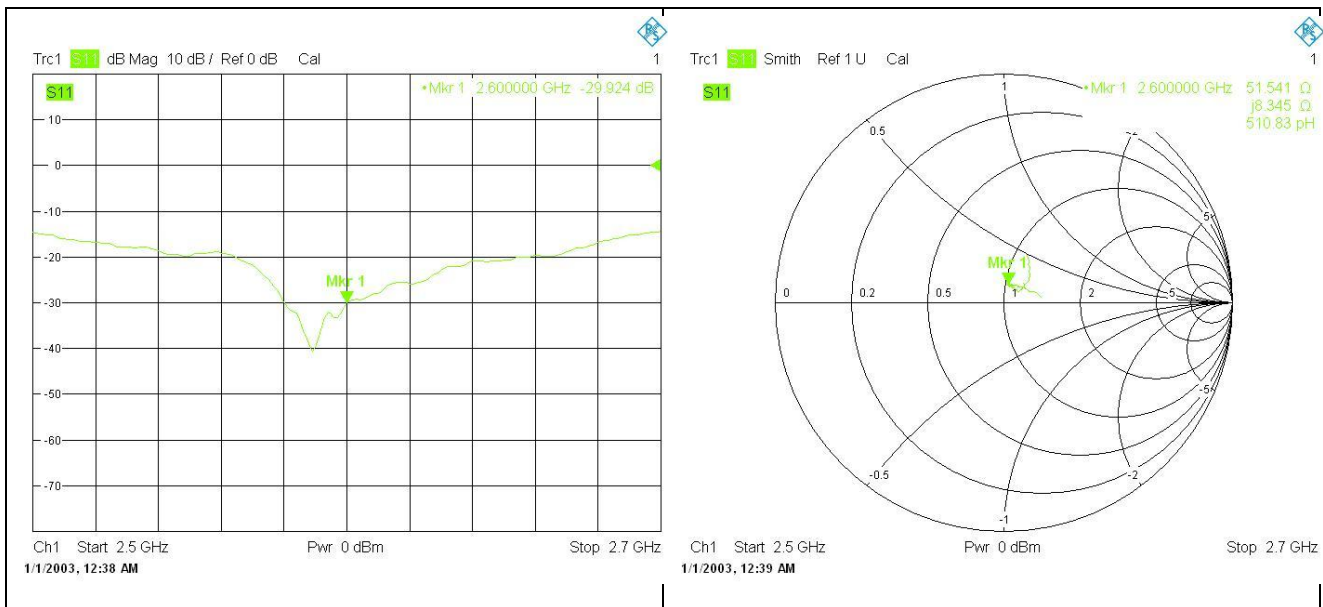



Head 5-6GHz					
Date of Measurement	Frequency (MHz)	Return Loss (dB)	Delta (%)	Impedance	Delta(ohm)
2017.11.27	5200	-9.69	-	25.64	-
2017.11.27	5400	-10.98	-	84.04	-
2017.11.27	5600	-13.52	-	36.63	-
2017.11.27	5800	-13.34	-	47.82	-
2019.11.26	5200	-9.70	-0.23	27.66	2.02
2019.11.26	5400	-11.02	-0.93	84.54	0.50
2019.11.26	5600	-13.34	4.23	36.02	-0.61
2019.11.26	5800	-13.49	0.69	51.67	3.85

The return loss is <math><-20\text{dB}</math>, within 20% of prior calibration; the impedance is within 5 ohm of prior calibration. Therefore the verification result should support extended calibration.

<Dipole Verification Data>

Head 5-6GHz

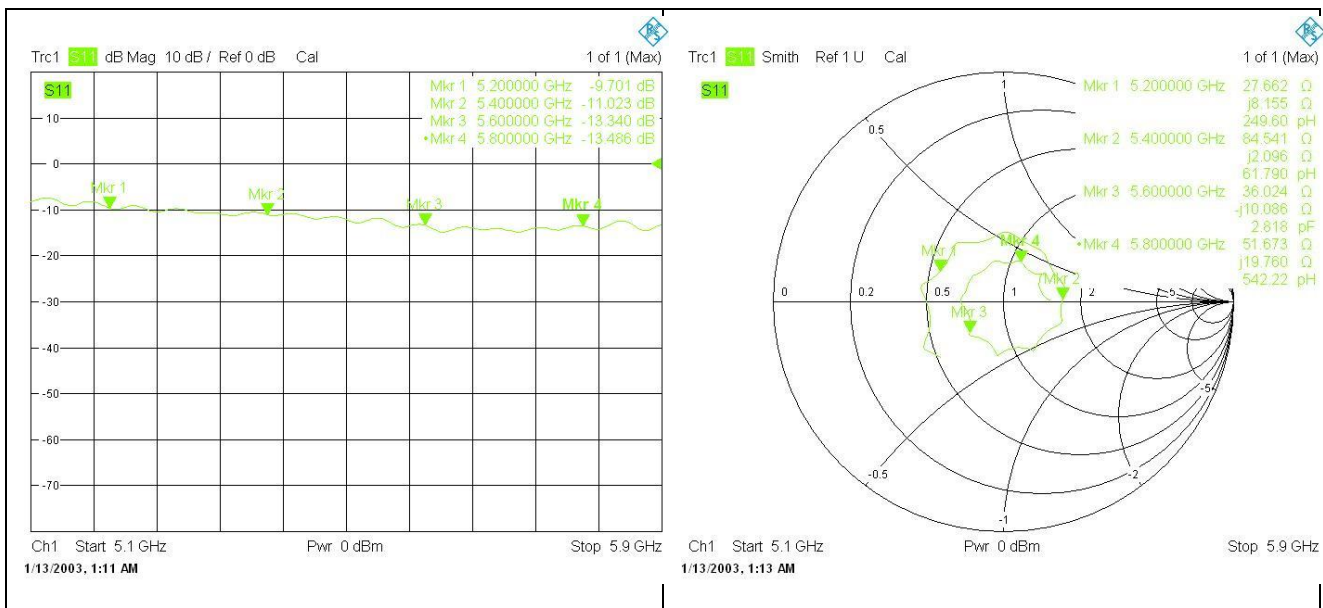



Body 750MHz				
Date of Measurement	Return Loss (dB)	Delta (%)	Impedance	Delta(ohm)
2017.11.27	-27.32	-	46.8	-
2019.11.26	-27.28	0.93	46.60	-0.20

The return loss is <-20dB, within 20% of prior calibration; the impedance is within 5ohm of prior calibration. Therefore the verification result should support extended calibration.

<Dipole Verification Data>

Body 750MHz

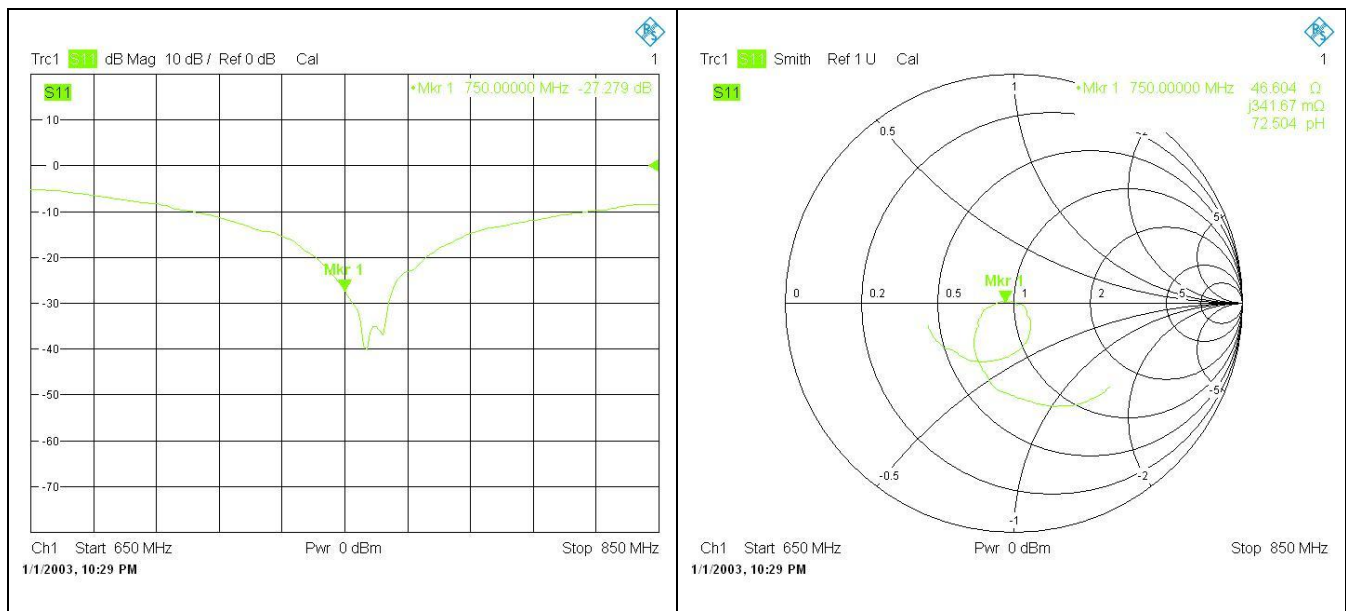



Body 835MHz				
Date of Measurement	Return Loss (dB)	Delta (%)	Impedance	Delta(ohm)
2017.11.27	-25.17	-	55.1	-
2019.11.26	-25.25	-1.86	56.65	1.55

The return loss is <-20dB, within 20% of prior calibration; the impedance is within 5ohm of prior calibration. Therefore the verification result should support extended calibration.

<Dipole Verification Data>

Body 835MHz

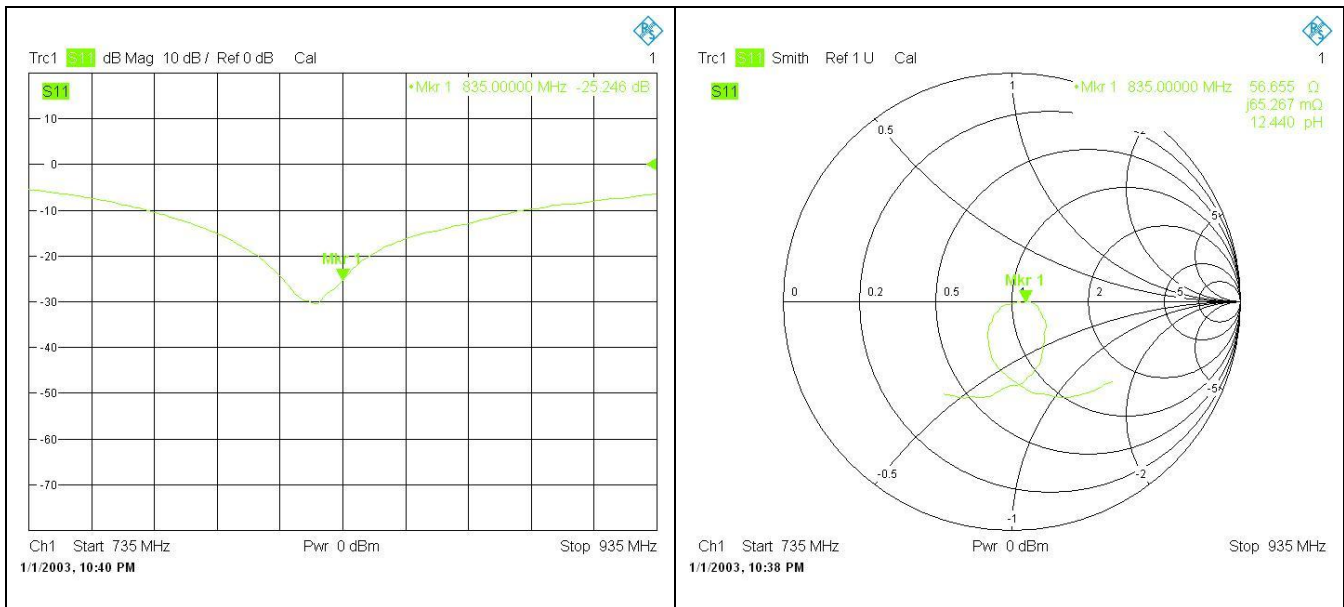



Body 1800MHz				
Date of Measurement	Return Loss (dB)	Delta (%)	Impedance	Delta(ohm)
2017.11.27	-24.11	-	44.3	-
2019.11.26	-24.16	-1.15	43.81	-0.49

The return loss is <math>< -20\text{dB}</math>, within 20% of prior calibration; the impedance is within 5 ohm of prior calibration. Therefore the verification result should support extended calibration.

<Dipole Verification Data>

Body 1800MHz

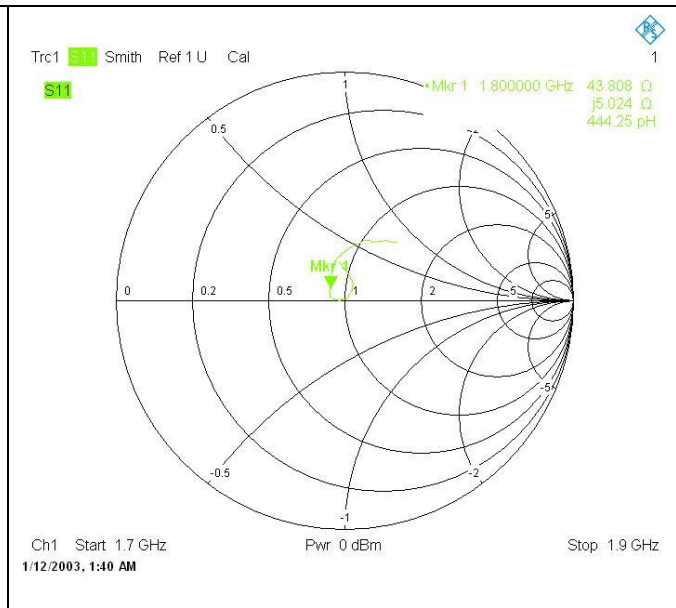
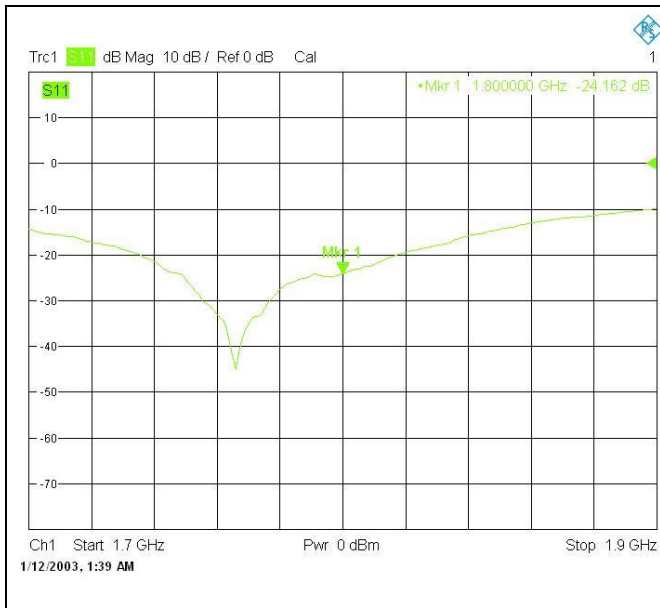



Body 1900MHz				
Date of Measurement	Return Loss (dB)	Delta (%)	Impedance	Delta(ohm)
2017.11.27	-22.17	-	46.8	-
2019.11.26	-21.90	6.41	50.56	3.76

The return loss is <-20dB, within 20% of prior calibration; the impedance is within 5 ohm of prior calibration. Therefore the verification result should support extended calibration.

<Dipole Verification Data>

Body 1900MHz

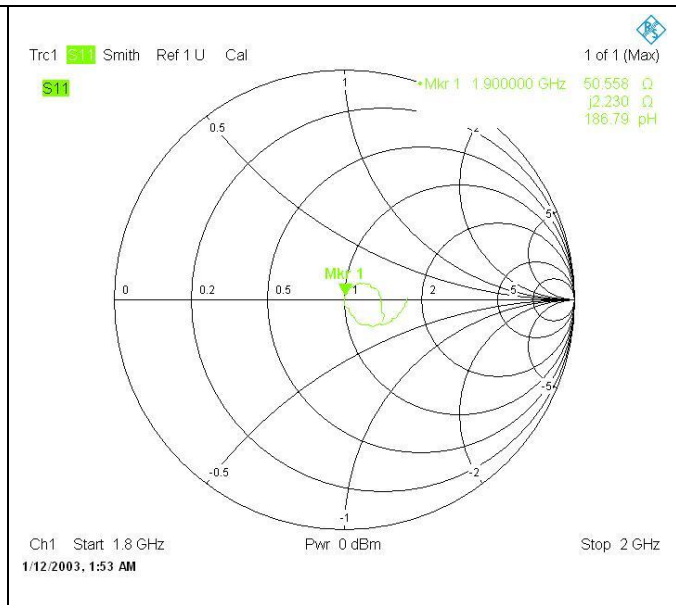
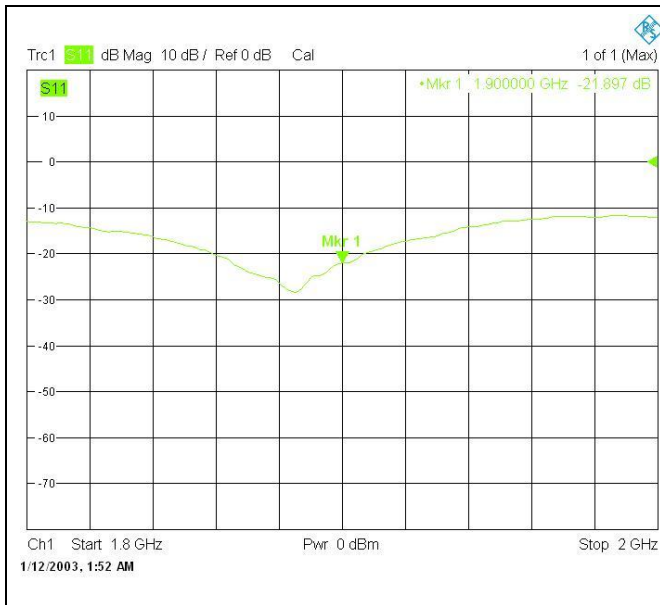



Body 2450MHz				
Date of Measurement	Return Loss (dB)	Delta (%)	Impedance	Delta(ohm)
2017.11.27	-26.02	-	53.2	-
2019.11.26	-25.55	11.43	50.04	-3.16

The return loss is <-20dB, within 20% of prior calibration; the impedance is within 5 ohm of prior calibration. Therefore the verification result should support extended calibration.

<Dipole Verification Data>

Body 2450MHz

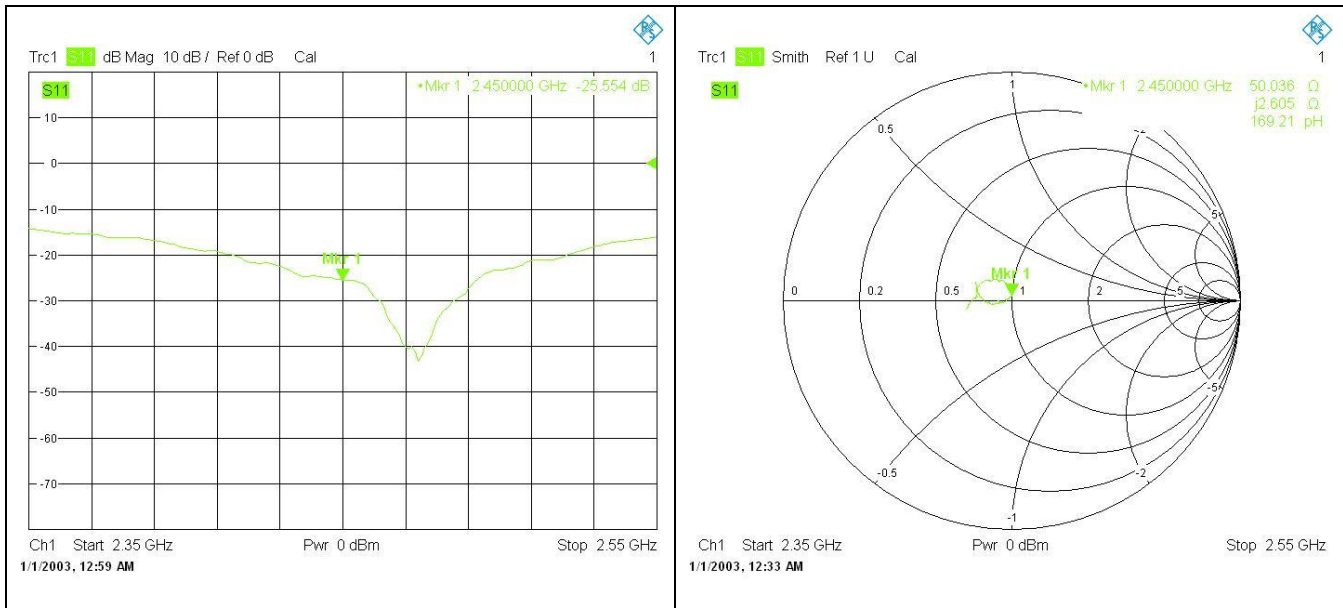



Body 2600MHz				
Date of Measurement	Return Loss (dB)	Delta (%)	Impedance	Delta(ohm)
2017.11.27	-33.55	-	49.4	-
2019.11.26	-33.56	-0.23	49.14	-0.26

The return loss is <-20dB, within 20% of prior calibration; the impedance is within 5 ohm of prior calibration. Therefore the verification result should support extended calibration.

<Dipole Verification Data>

Body 2600MHz

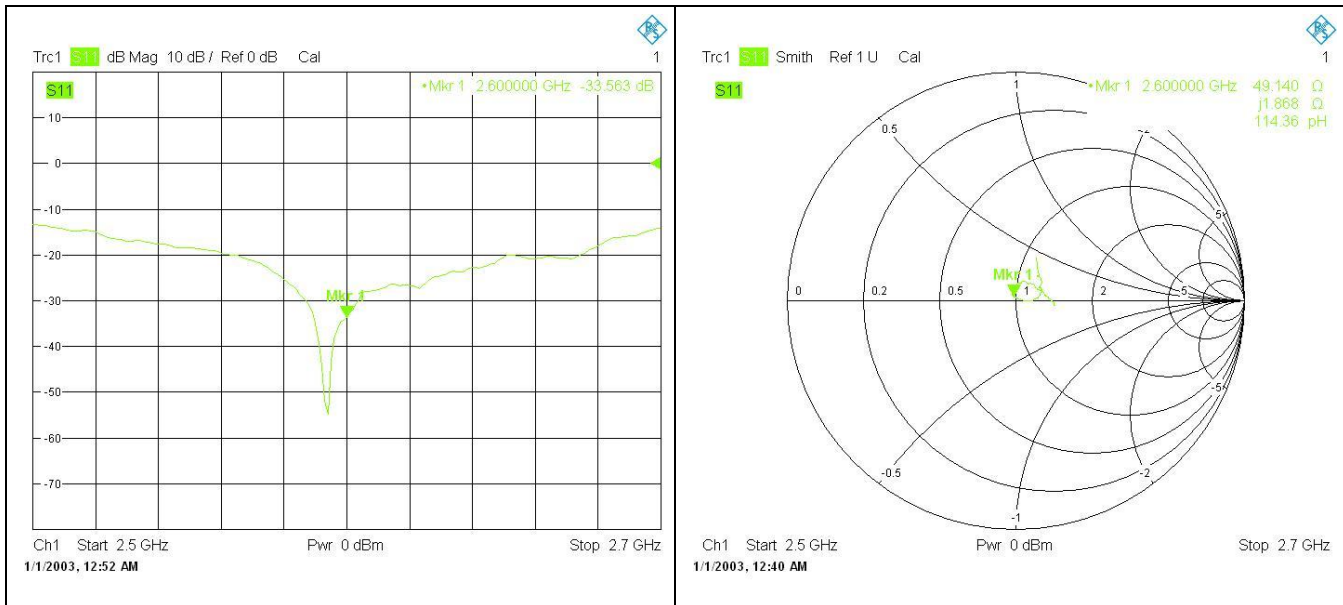



Body 5-6GHz					
Date of Measurement	Frequency (MHz)	Return Loss (dB)	Delta (%)	Impedance	Delta(ohm)
2017.11.27	5200	-8.86	-	23.97	-
2017.11.27	5400	-9.91	-	92.64	-
2017.11.27	5600	-11.72	-	32.59	-
2017.11.27	5800	-11.90	-	48.49	-
2019.11.26	5200	-8.63	5.44	24.83	0.86
2019.11.26	5400	-10.31	-9.65	92.19	-0.45
2019.11.26	5600	-11.88	-3.75	32.81	0.22
2019.11.26	5800	-11.63	6.41	52.91	4.42

The return loss is <math><-20\text{dB}</math>, within 20% of prior calibration; the impedance is within 5 ohm of prior calibration. Therefore the verification result should support extended calibration.

<Dipole Verification Data>

Body 5-6GHz

