

### 3.3 Occupied Bandwidth

#### 3.3.1. Limit

FCC 47 CFR Part 90 Subpart S - §90.209 (a)

Each authorization issued to a station licensed under this part will show an emission designator representing the class of emission authorized. The designator will be prefixed by a specified necessary bandwidth. This number does not necessarily indicate the bandwidth occupied by the emission at any instant. In those cases where §2.202 of this chapter does not provide a formula for the computation of necessary bandwidth, the occupied bandwidth, as defined in part 2 of this chapter, may be used in lieu of the necessary bandwidth.

#### 3.3.2. Test Setup

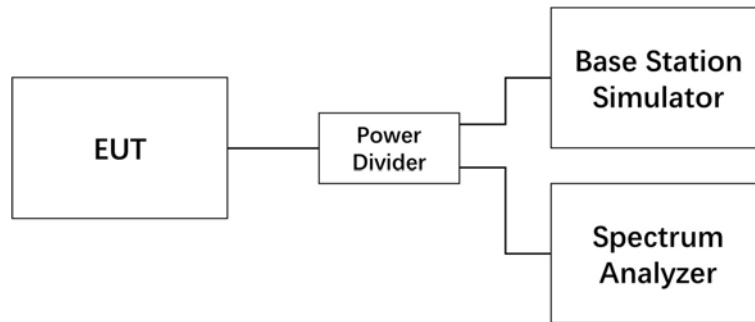

#### 3.3.3. Test Procedures

- 1) The measurement procedure follows ANSI C63.26-2015, clause 5.2.7
- 2) The RF output of the EUT, BS simulator and spectrum analyzer are connected via a power divider.
- 3) The nominal RBW of spectrum analyzer shall be in the range of 1% to 5% of the anticipated OBW, and the VBW shall be set  $\geq 3 \times$  RBW.
- 4) Record the measured results of 26dB and 99% bandwidth.

#### 3.3.4. Test Result

<b>Test Engineer</b>	Xu Dongxu	<b>Test Date</b>	2021/03/04
<b>Temperature</b>	18.6°C	<b>Relative Humidity</b>	48.7%
<b>Pressure</b>	105.1kPa	<b>Test Sample Selected</b>	No.1

Frequency (MHz)	Channel No.	BW (MHz)	RB Size	RB Offset	Bandwidth of 99% Power (MHz)					
					QPSK		16-QAM		64-QAM	
814.7	26697	1.4	6	0	1.09	Fig.1	1.08	Fig.2	1.09	Fig.3
819.0	26740		6	0	1.08	Fig.4	1.08	Fig.5	1.08	Fig.6
823.3	26783		6	0	1.08	Fig.7	1.08	Fig.8	1.08	Fig.9
815.5	26705	3	15	0	2.68	Fig.10	2.68	Fig.11	2.67	Fig.12
819.0	26740		15	0	2.68	Fig.13	2.68	Fig.14	2.68	Fig.15
822.5	26775		15	0	2.68	Fig.16	2.68	Fig.17	2.68	Fig.18
816.5	26715	5	25	0	4.47	Fig.19	4.47	Fig.20	4.47	Fig.21
819.0	26740		25	0	4.47	Fig.22	4.47	Fig.23	4.47	Fig.24
821.5	26765		25	0	4.49	Fig.25	4.47	Fig.26	4.47	Fig.27
819.0	26740	10	50	0	8.94	Fig.28	8.94	Fig.29	8.94	Fig.30

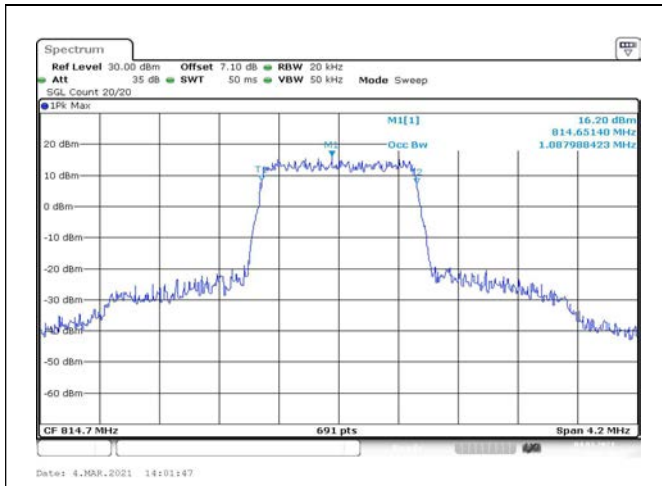

Fig.1

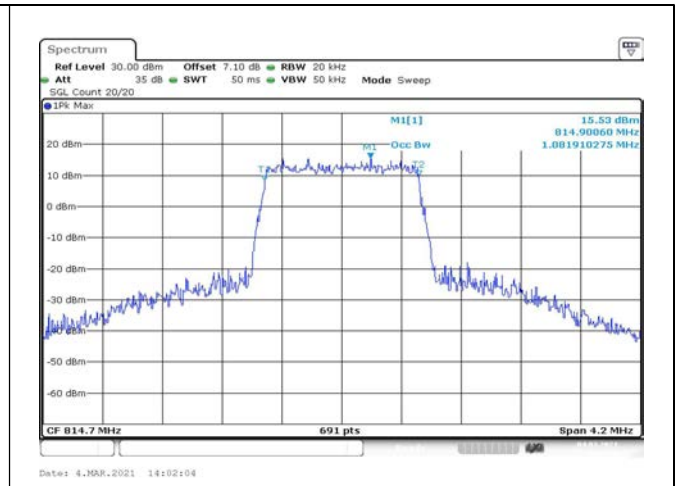

Fig.2

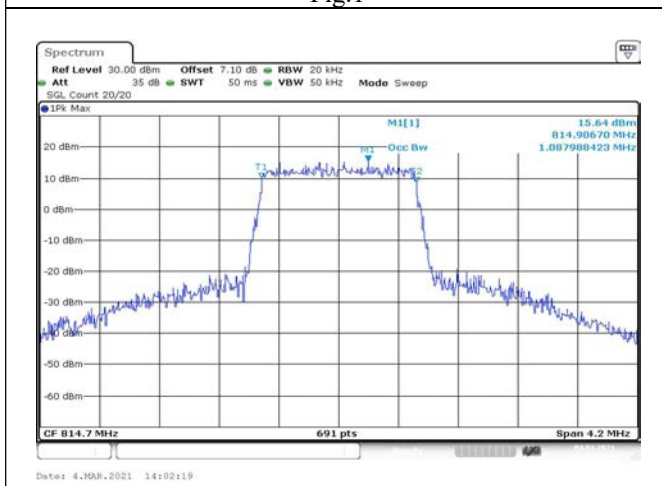

Fig.3

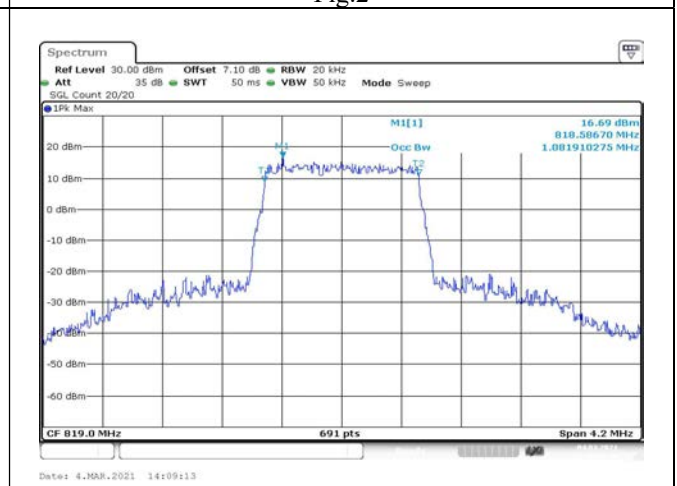

Fig.4

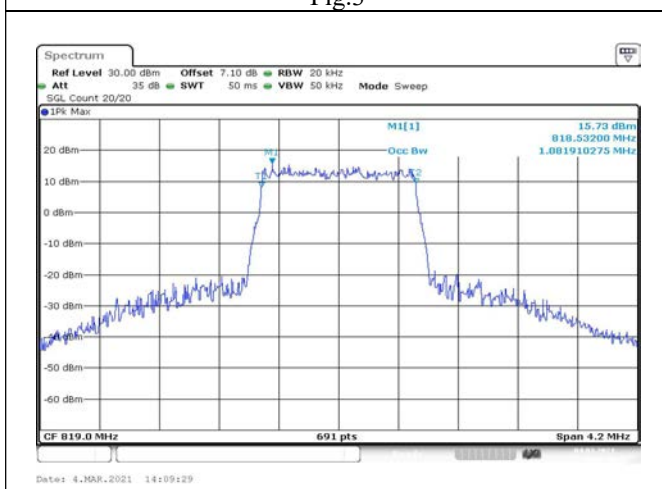

Fig.5

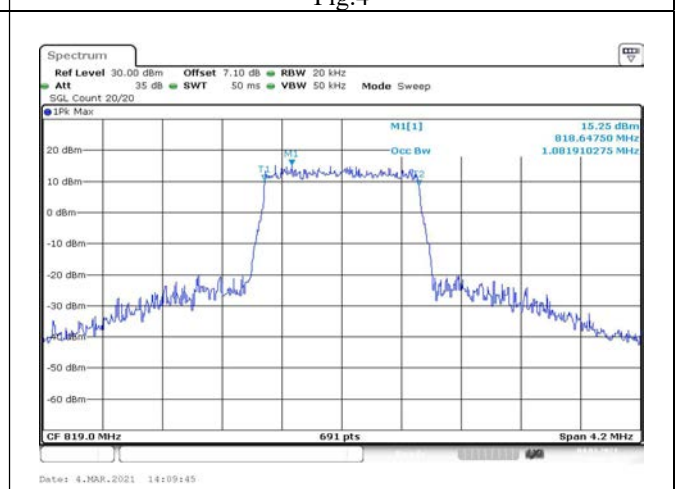

Fig.6

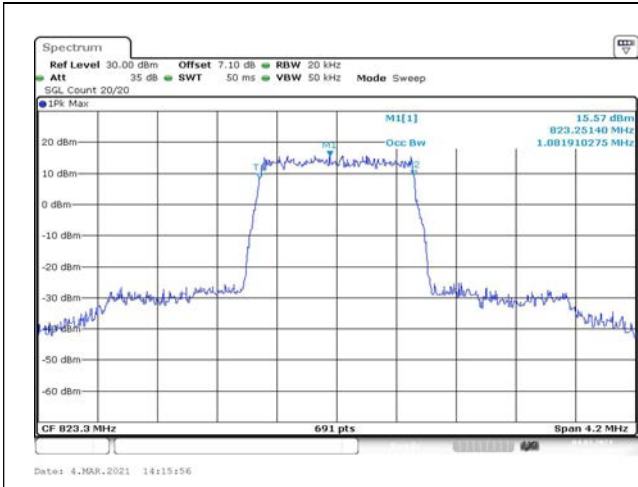

Fig.7

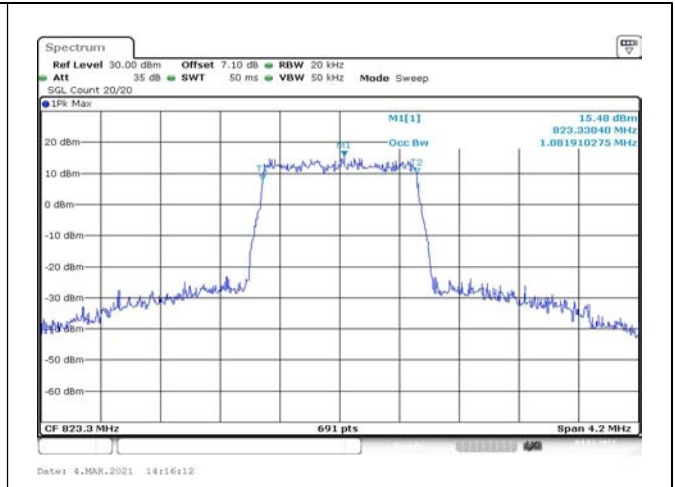

Fig.8

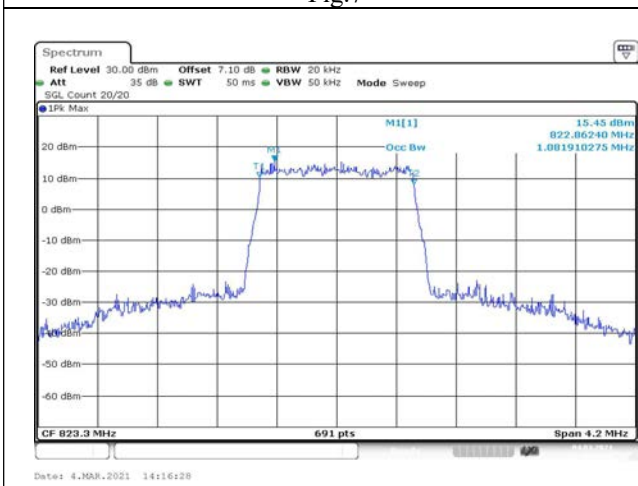

Fig.9

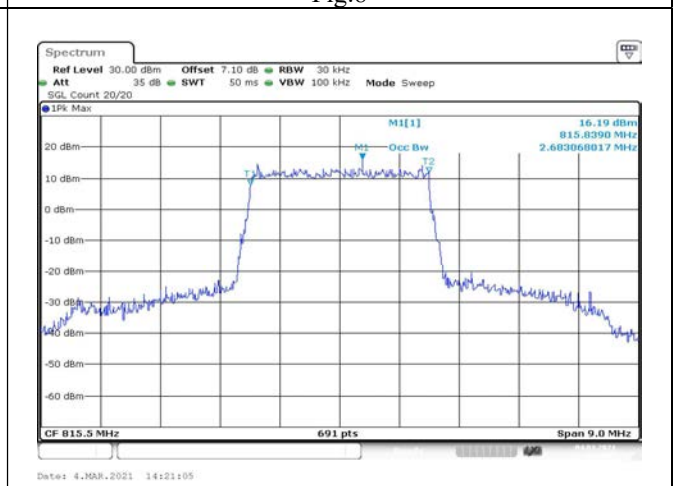

Fig.10

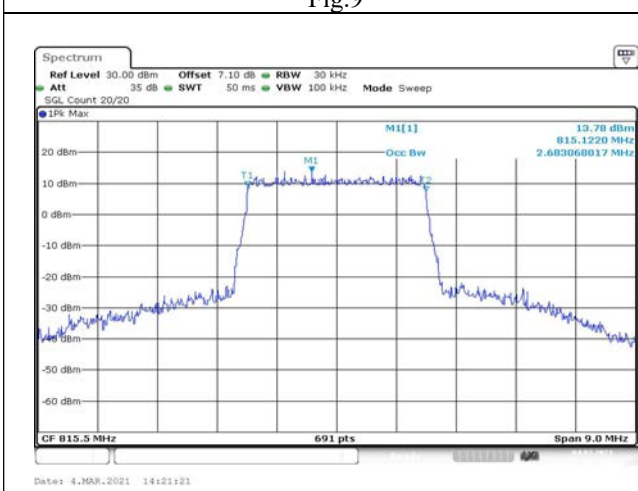

Fig.11

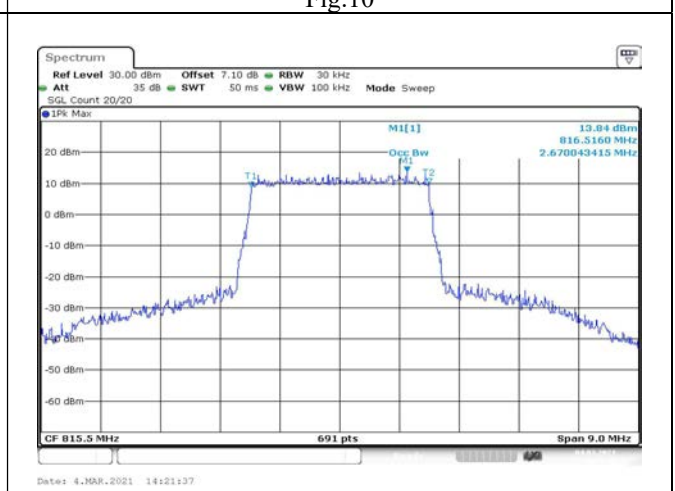
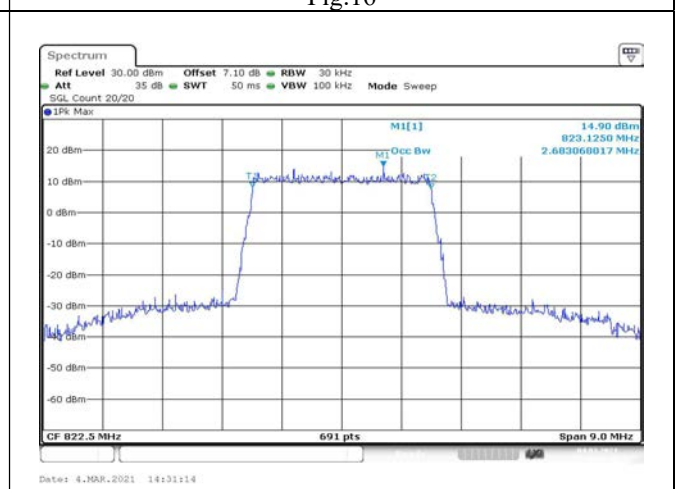
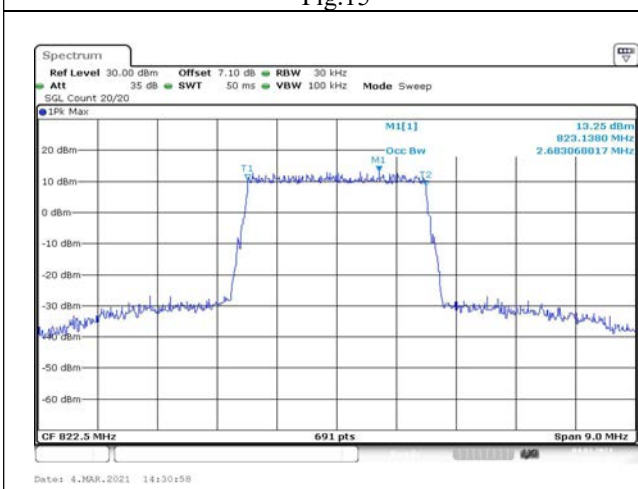
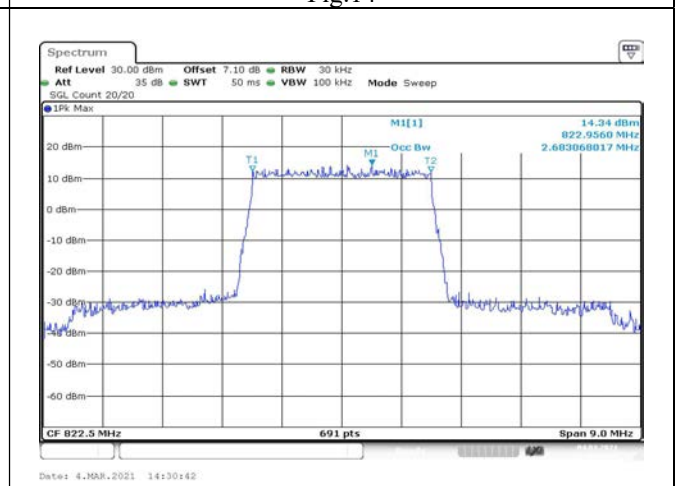
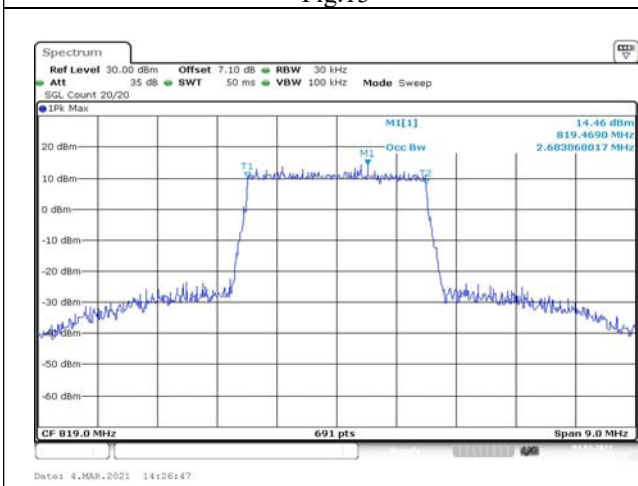
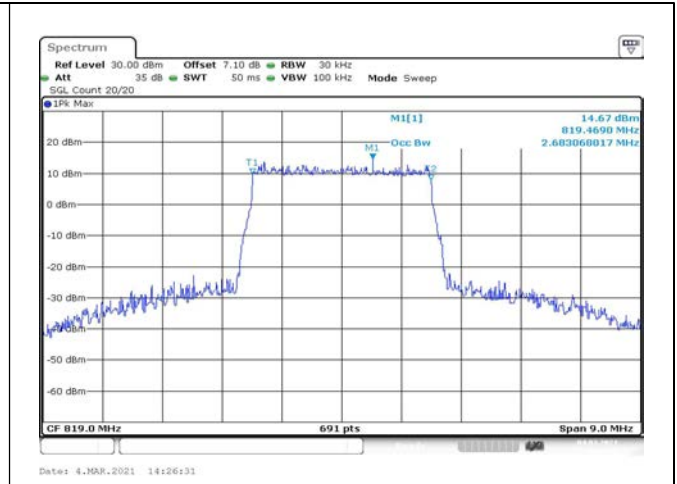
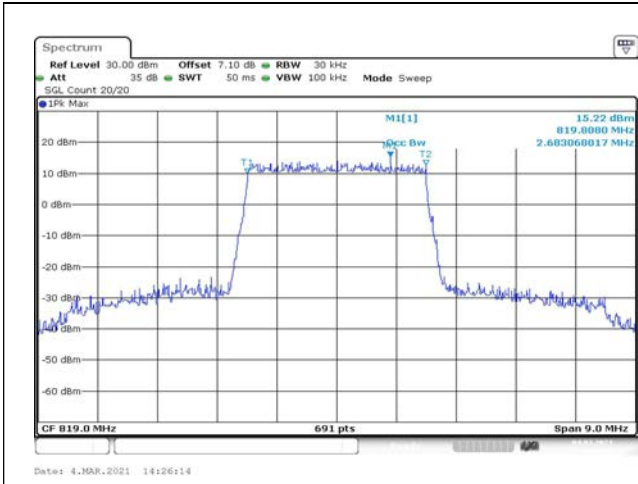

Fig.12



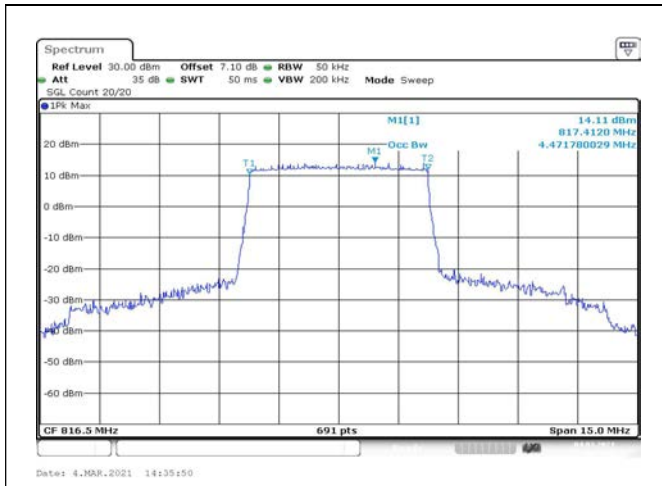

Fig.19

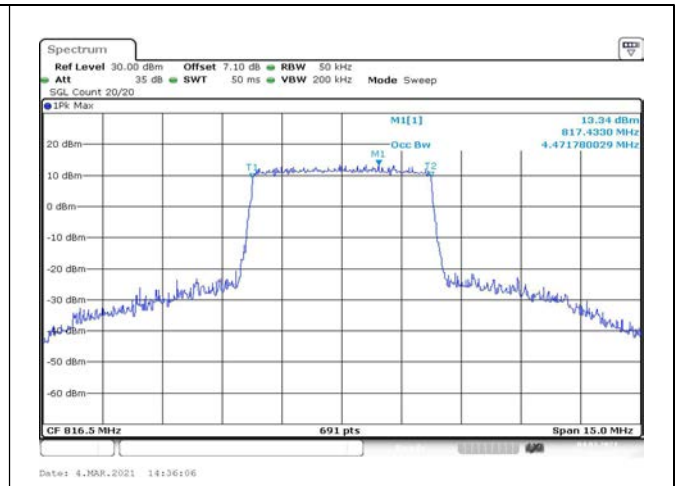

Fig.20

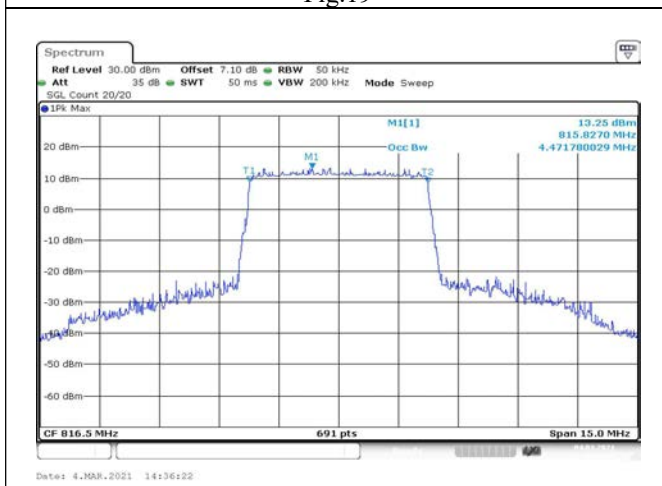

Fig.21

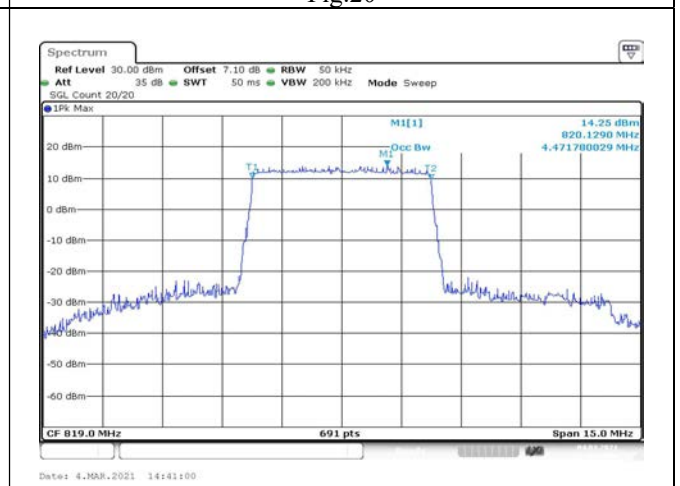

Fig.22

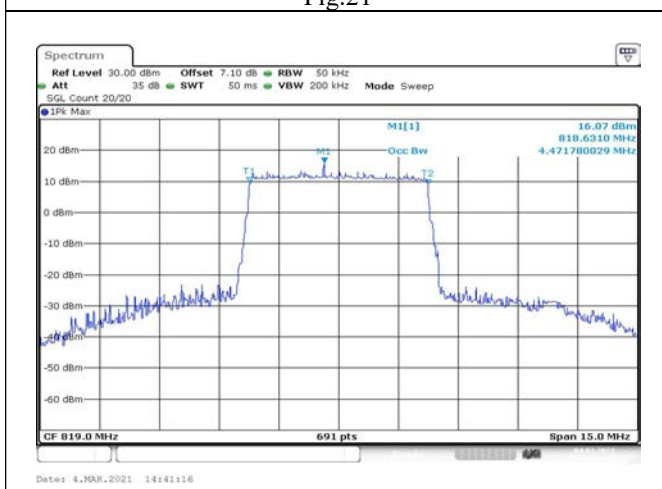

Fig.23

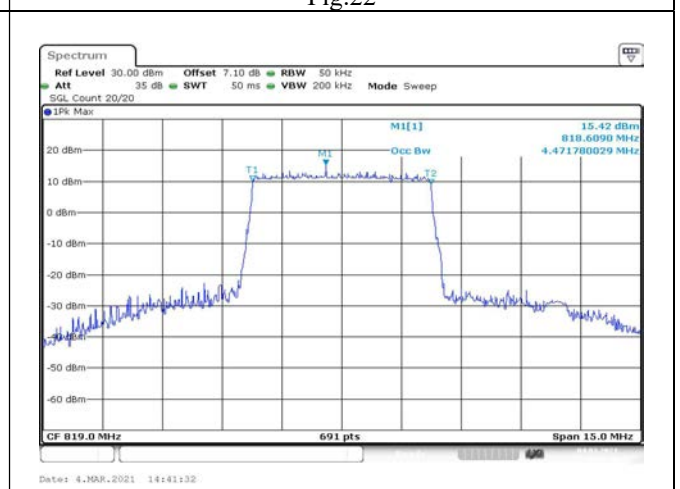

Fig.24

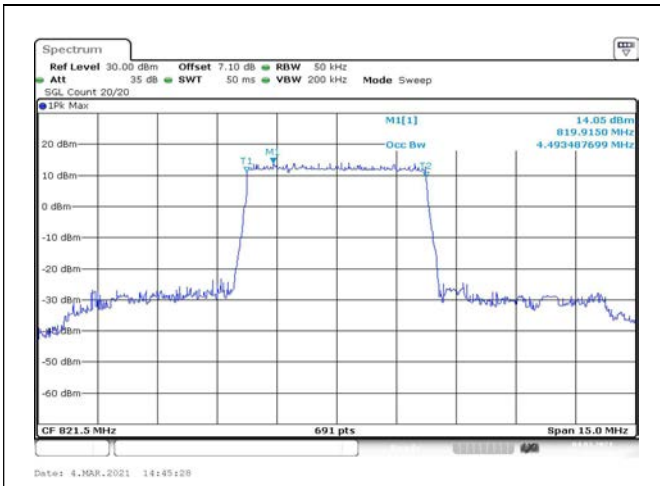

Fig.25

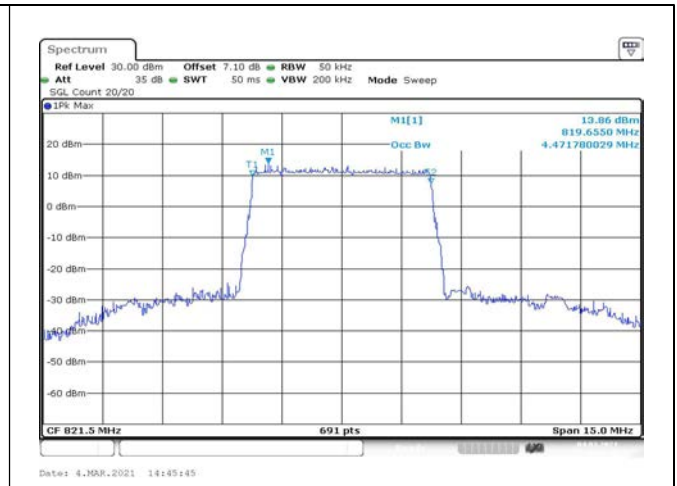

Fig.26

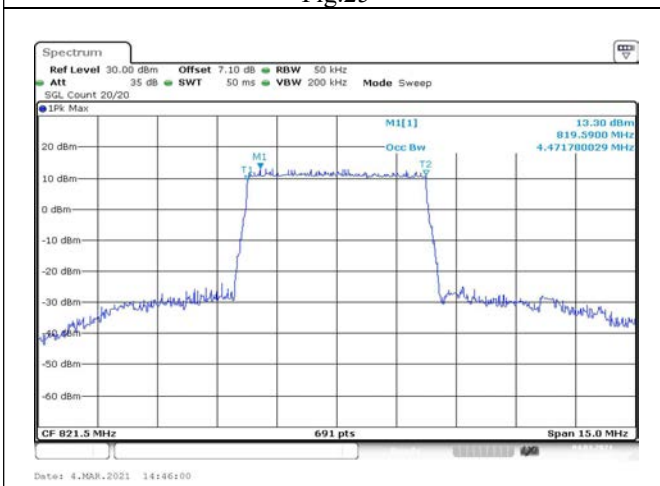

Fig.27

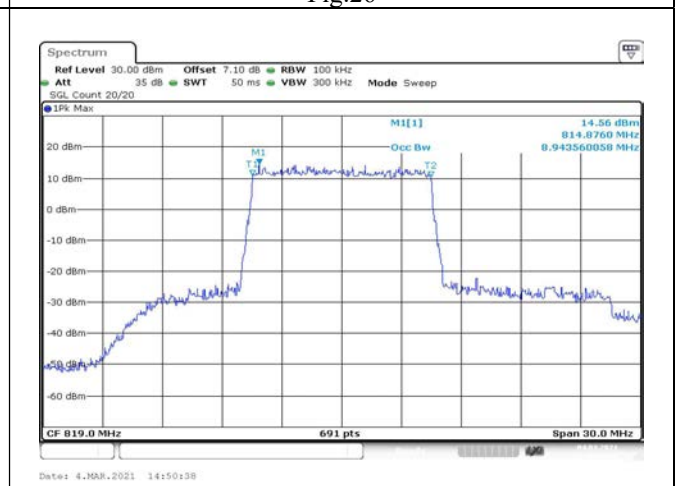

Fig.28

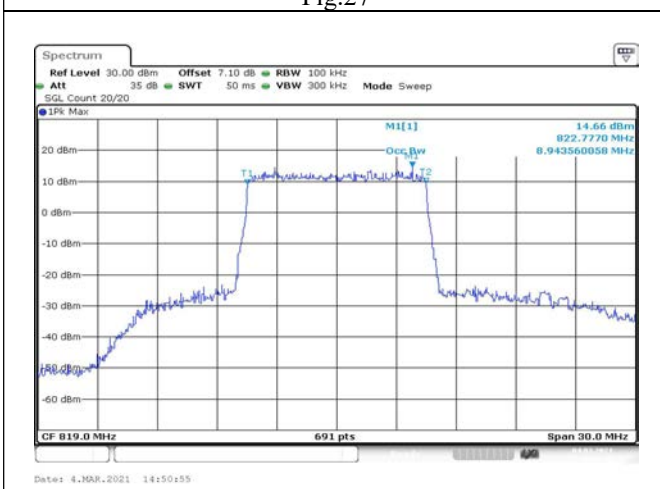

Fig.29

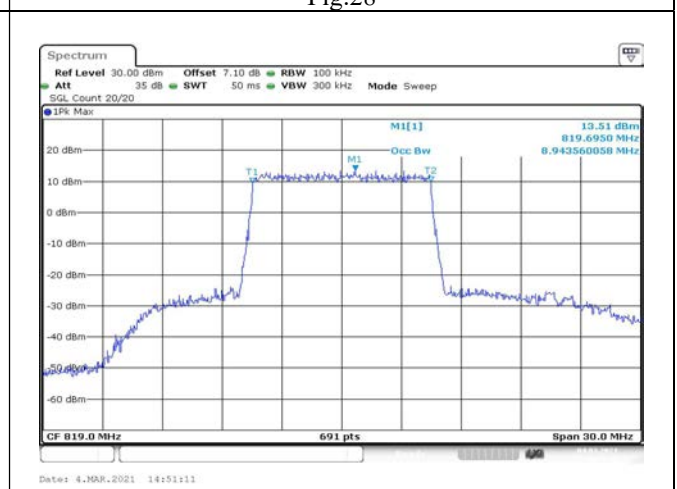
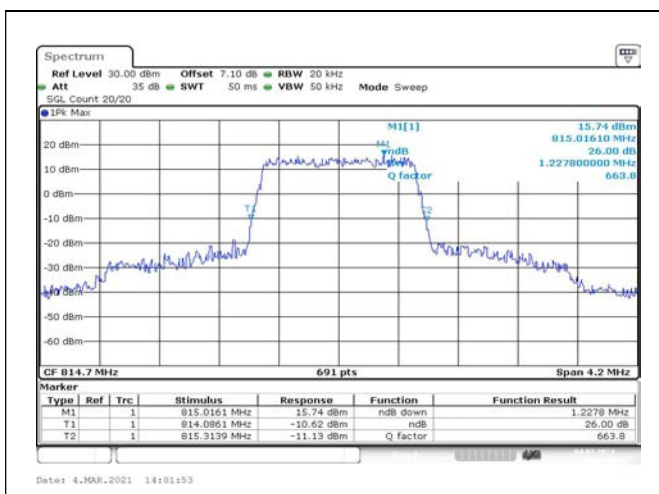
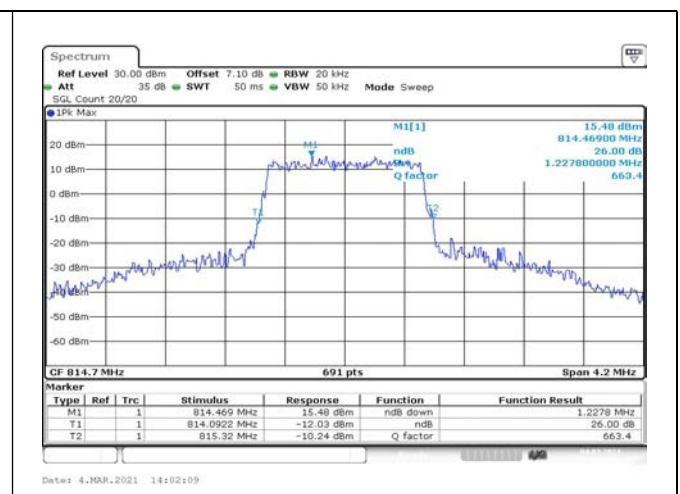
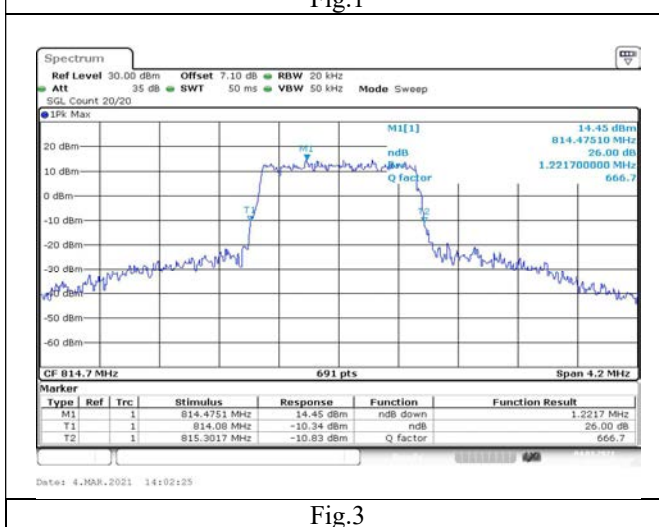
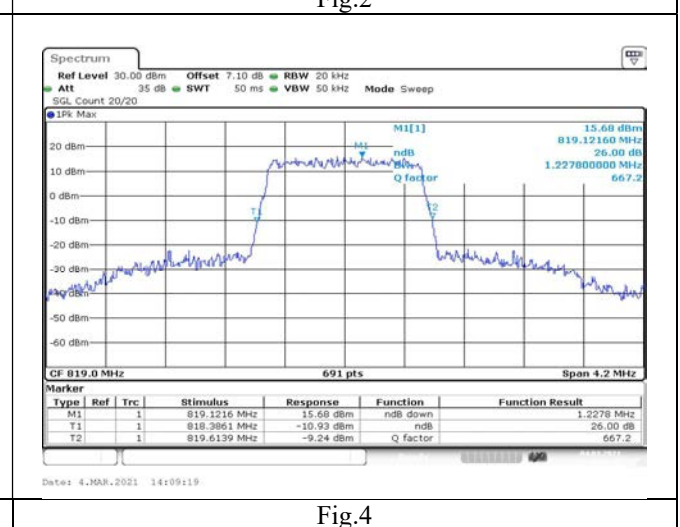

Fig.30

Frequency (MHz)	Channel No.	BW (MHz)	RB Size	RB Offset	Bandwidth of -26dB (MHz)					
					QPSK		16-QAM		64-QAM	
814.7	26697	1.4	6	0	1.23	Fig.1	1.23	Fig.2	1.22	Fig.3
819.0	26740		6	0	1.23	Fig.4	1.23	Fig.5	1.23	Fig.6
823.3	26783		6	0	1.23	Fig.7	1.23	Fig.8	1.23	Fig.9
815.5	26705	3	15	0	3.00	Fig.10	2.97	Fig.11	2.98	Fig.12
819.0	26740		15	0	2.97	Fig.13	2.97	Fig.14	2.98	Fig.15
822.5	26775		15	0	2.98	Fig.16	2.96	Fig.17	3.01	Fig.18
816.5	26715	5	25	0	4.88	Fig.19	4.88	Fig.20	4.91	Fig.21
819.0	26740		25	0	4.86	Fig.22	4.88	Fig.23	4.91	Fig.24
821.5	26765		25	0	4.88	Fig.25	4.91	Fig.26	4.86	Fig.27
819.0	26740	10	50	0	9.68	Fig.28	9.68	Fig.29	9.68	Fig.30

**Fig.1**

**Fig.2**

**Fig.3**

**Fig.4**

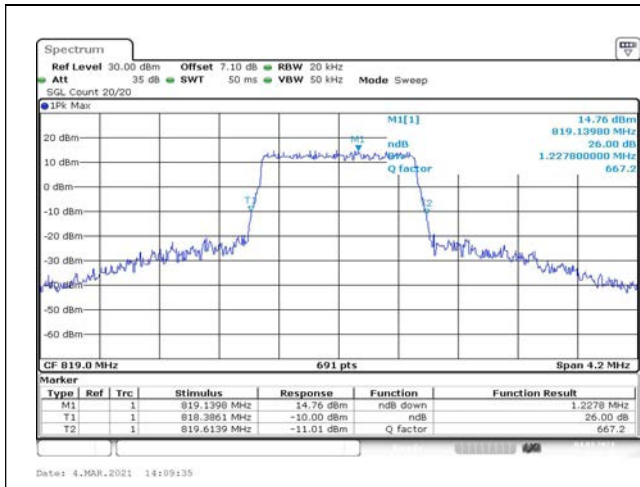

Fig.5

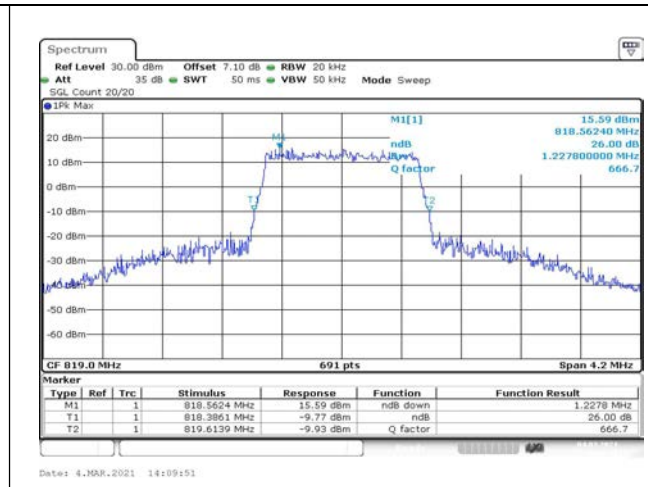

Fig.6

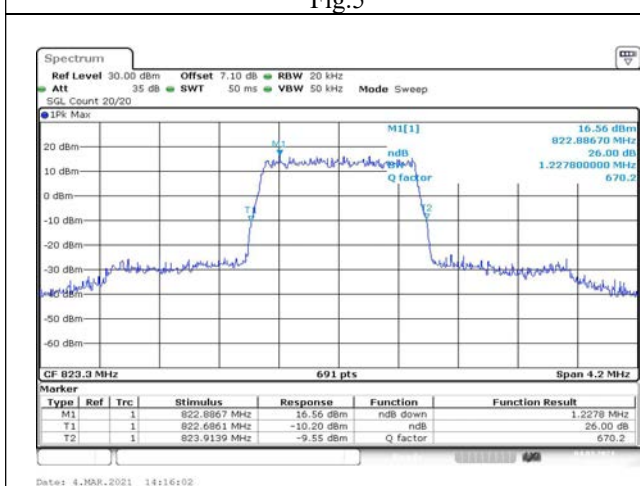

Fig.7

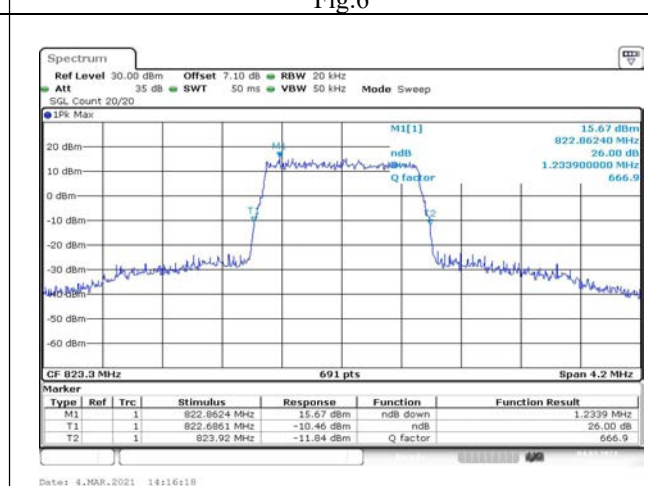

Fig.8

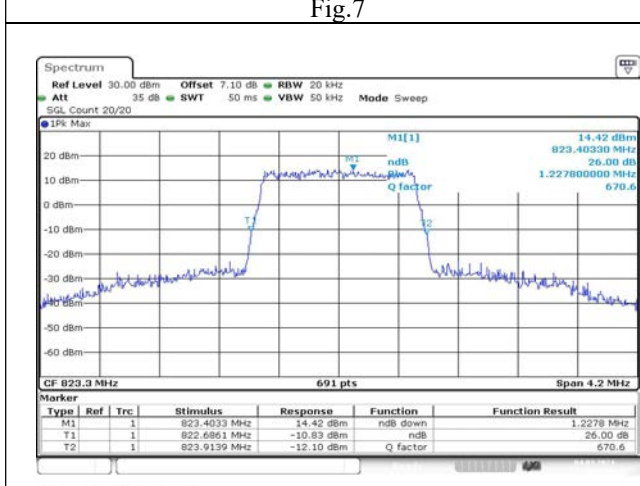

Fig.9

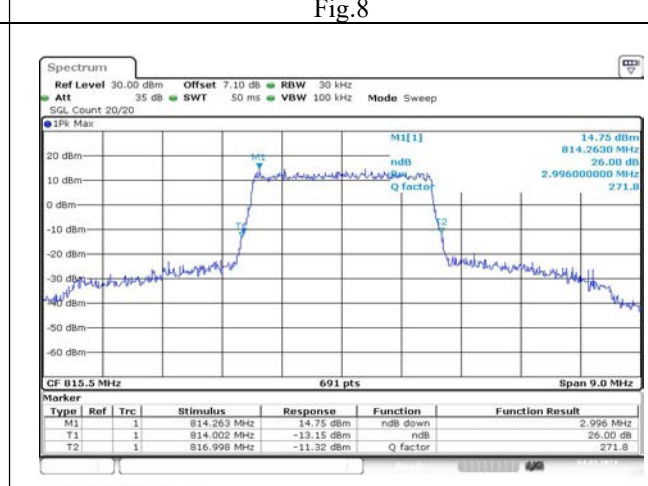

Fig.10



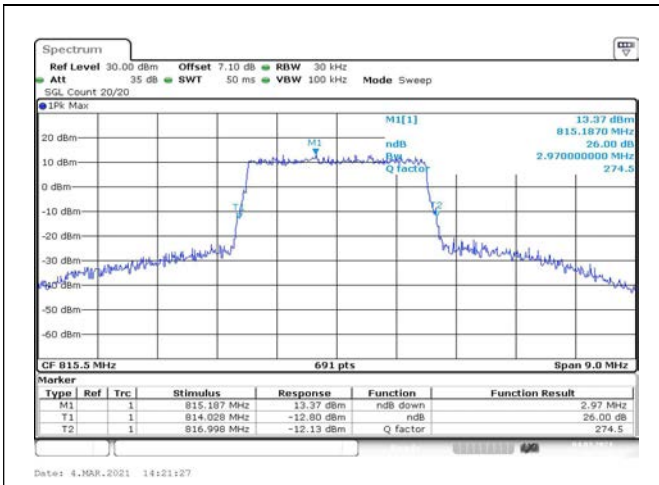

Fig.11

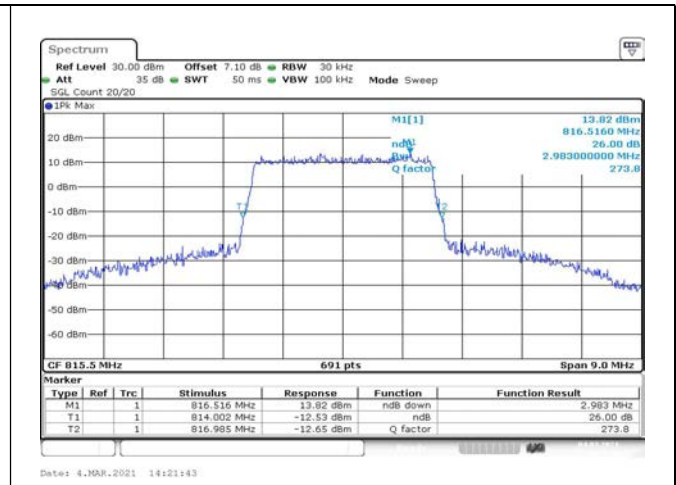

Fig.12

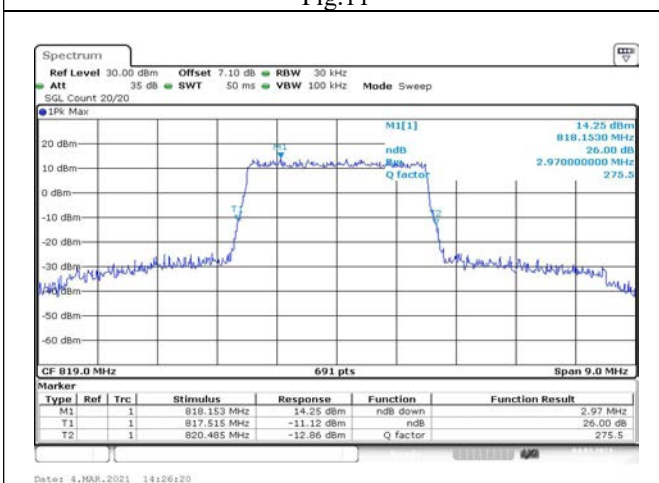

Fig.13

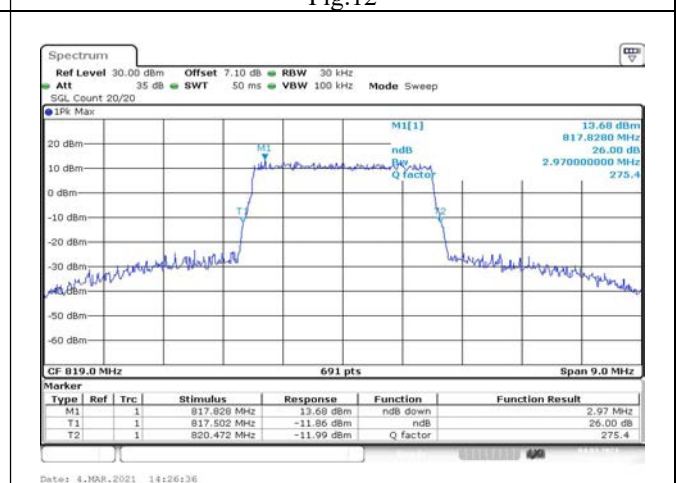

Fig.14

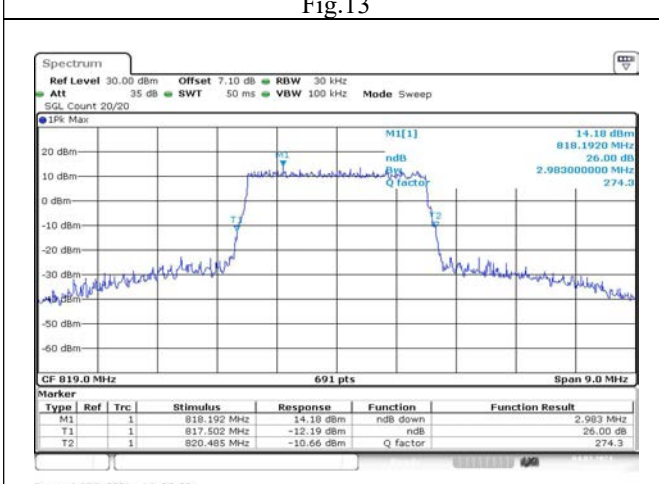

Fig.15

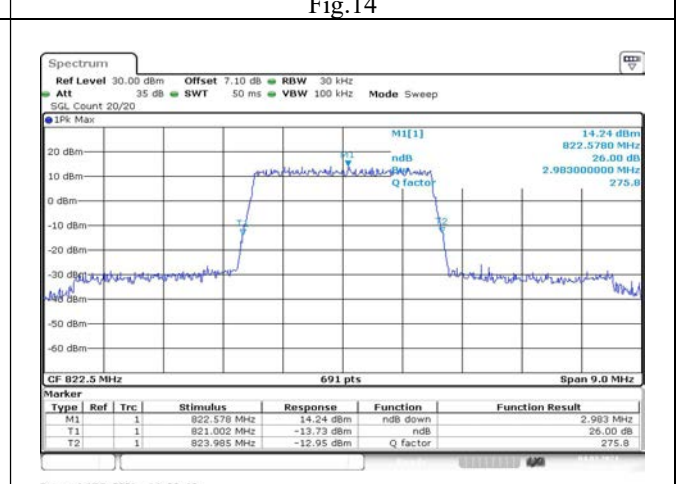

Fig.16

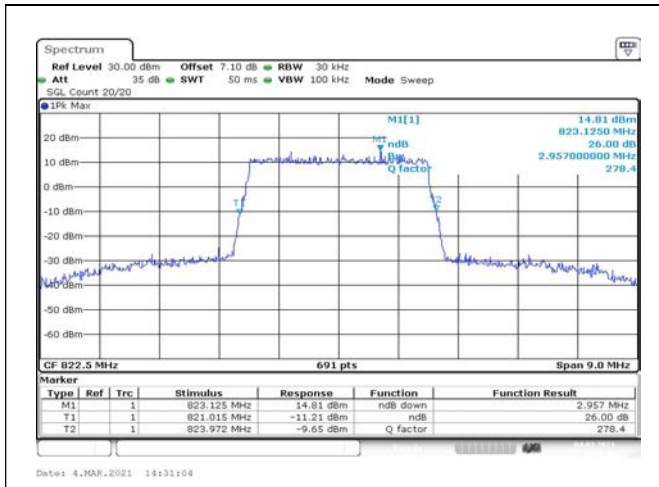

Fig.17

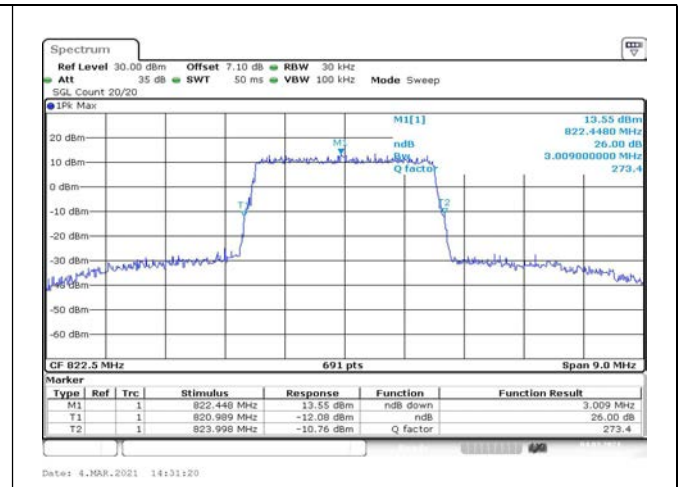

Fig.18

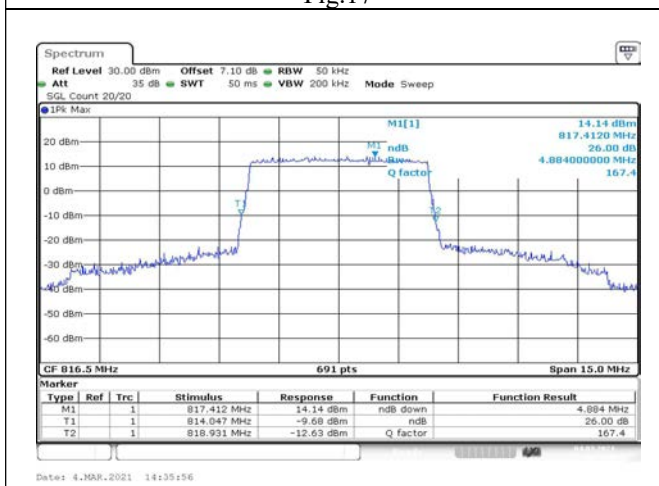

Fig.19

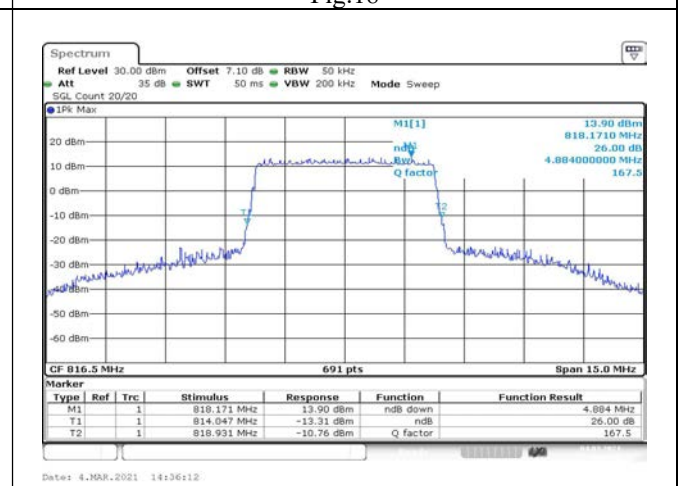

Fig.20

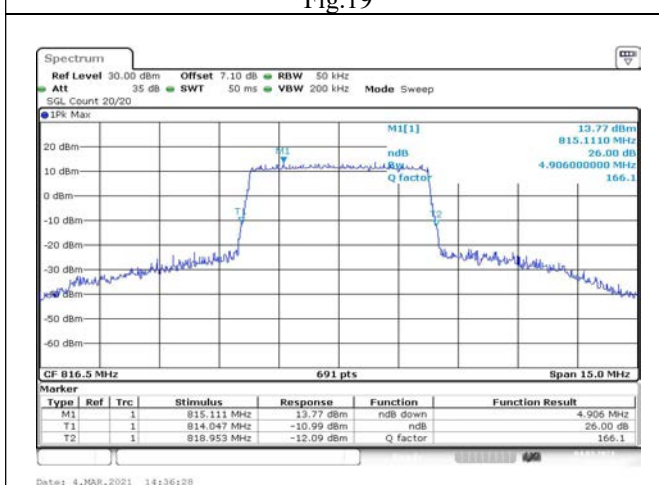

Fig.21

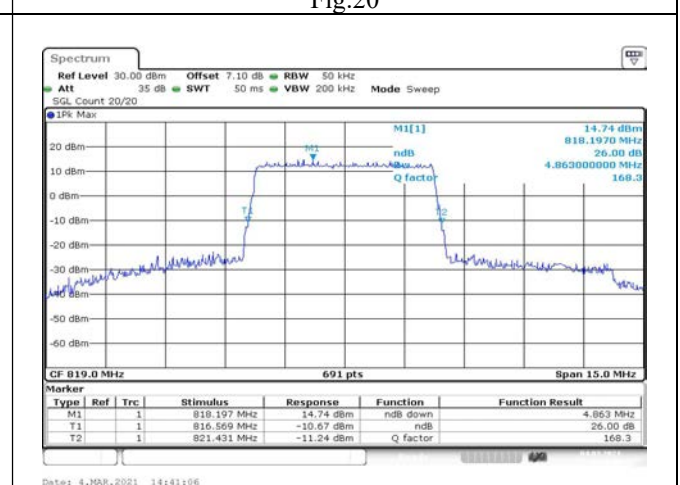

Fig.22

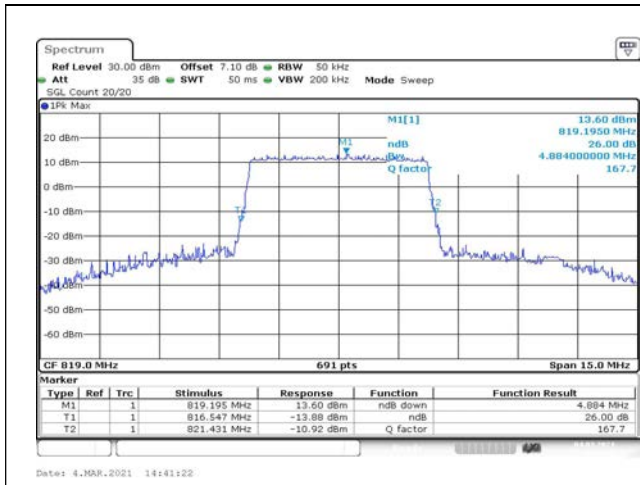

Fig.23

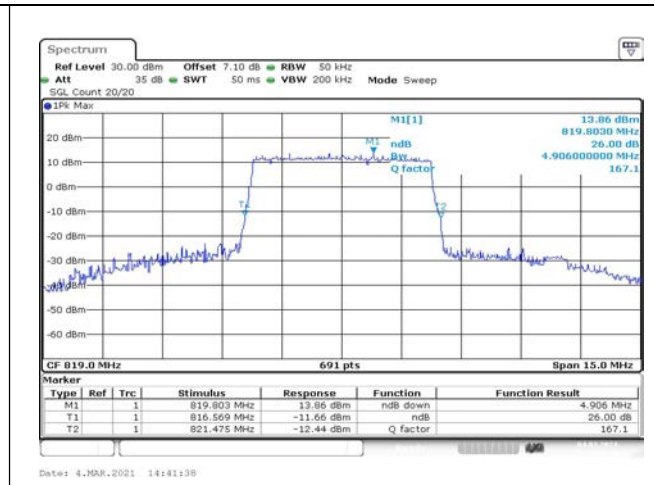

Fig.24

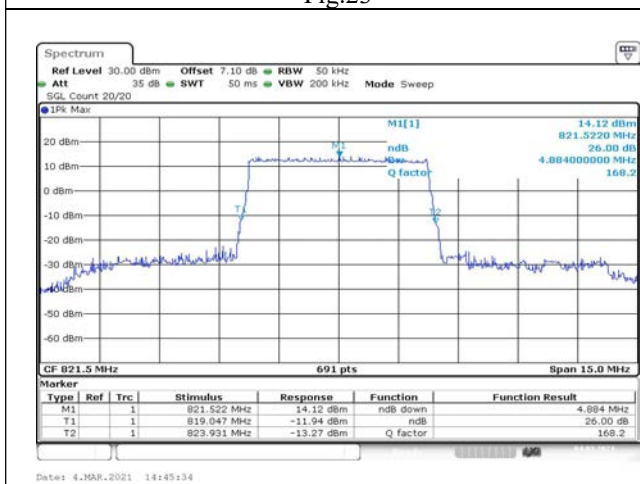

Fig.25

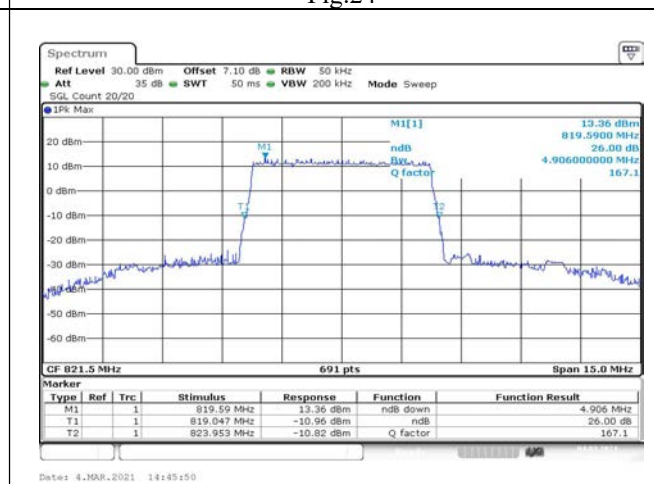

Fig.26

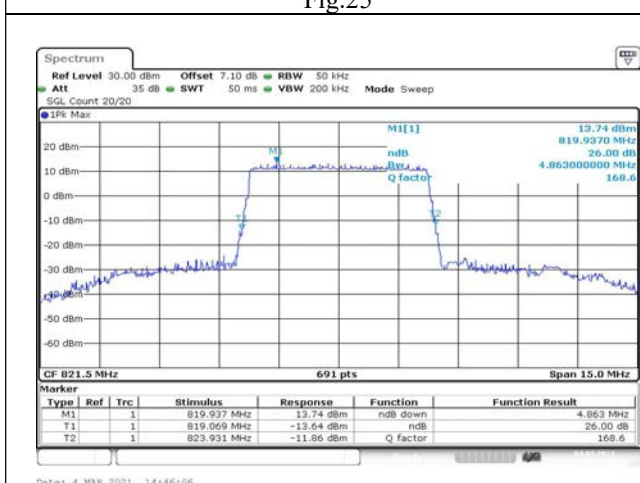

Fig.27

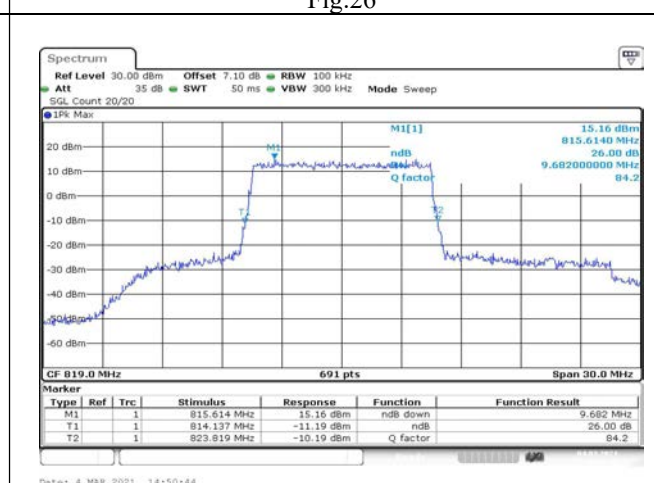

Fig.28

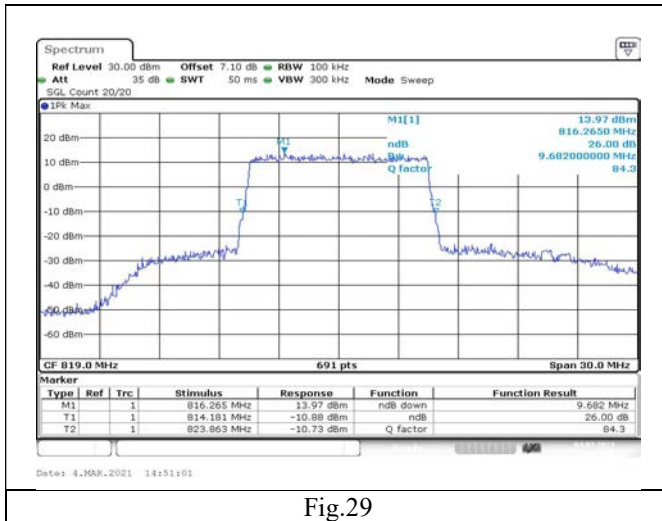

Fig.29

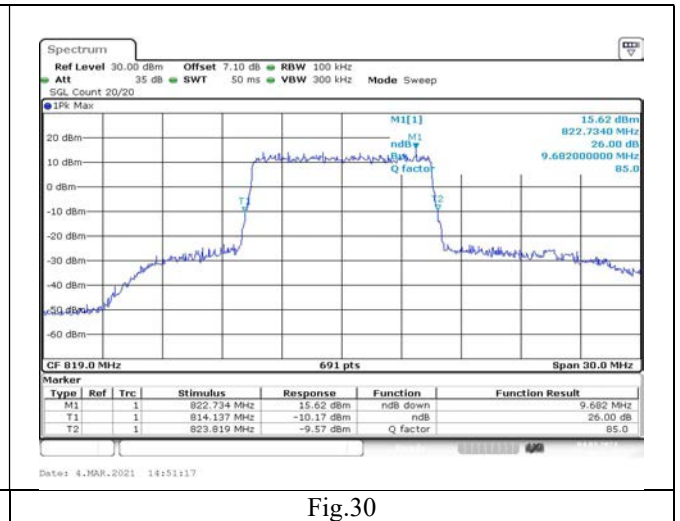

Fig.30

### 3.3.5. Uncertainty

Frequency (MHz)	$U_{lab}$	$k$
814.7	71.15Hz	2
819.0	71.44Hz	2
823.3	71.73Hz	2
815.5	71.21Hz	2
822.5	71.68Hz	2
816.5	71.27Hz	2
821.5	71.61Hz	2

### 3.4 Spurious Emission at Antenna Terminal

#### 3.4.1. Limit

FCC 47 CFR Part 90 Subpart S - §90.691

For any frequency removed from the EA licensee's frequency block greater than 37.5 kHz, the power of any emission shall be attenuated below the transmitter power (P) in watts by at least  $43 + 10\text{Log}_{10}(P)$  decibels or 80 decibels, whichever is the lesser attenuation, where f is the frequency removed from the center of the outer channel in the block in kilohertz and where f is greater than 37.5 kHz.

#### 3.4.2. Test Setup

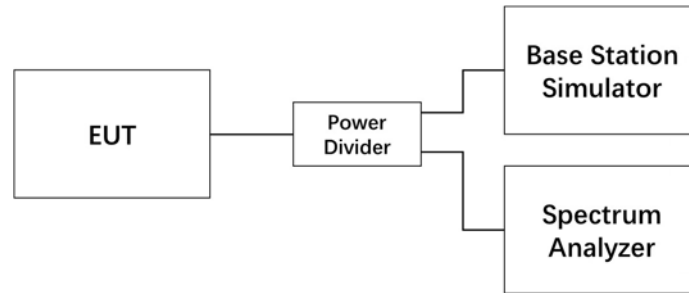

#### 3.4.3. Test Procedures

- 1) The measurement procedure follows ANSI C63.26-2015, clause 5.7.
- 2) The RF output of EUT, BS simulator and spectrum analyzer is connected via a power divider.
- 3) EUT is configured to transmit continuously at fully power while the compliance measurement is performed.
- 4) The span in Spectrum analyzer shall be from 30MHz to 10 times the operating frequency in GHz, with an appropriate resolution bandwidth, video bandwidth, sweep time and detector type.
- 5) Check if some unwanted emission happens, and if amplitude of unwanted emission is higher than the limit.
- 6) The result in worse case will be recorded.

#### 3.4.4. Test Result

<b>Test Engineer</b>	Xu Dongxu	<b>Test Date</b>	2021/03/04
<b>Temperature</b>	18.6°C	<b>Relative Humidity</b>	48.7%
<b>Pressure</b>	105.1kPa	<b>Test Sample Selected</b>	No.1

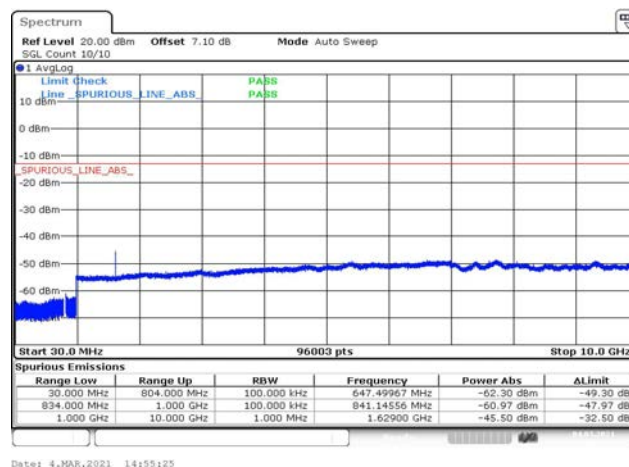

#### 3.4.5. Uncertainty

$$U_{lab}=2.46\text{dB} (k=2)$$

### 3.5 Field Strength of Spurious Radiation

#### 3.5.1. Limit

FCC 47 CFR Part 90 Subpart S - §90.691

For any frequency removed from the EA licensee's frequency block greater than 37.5 kHz, the power of any emission shall be attenuated below the transmitter power (P) in watts by at least  $43 + 10\text{Log}_{10}(P)$  decibels or 80 decibels, whichever is the lesser attenuation, where f is the frequency removed from the center of the outer channel in the block in kilohertz and where f is greater than 37.5 kHz.

#### 3.5.2. Test Setup

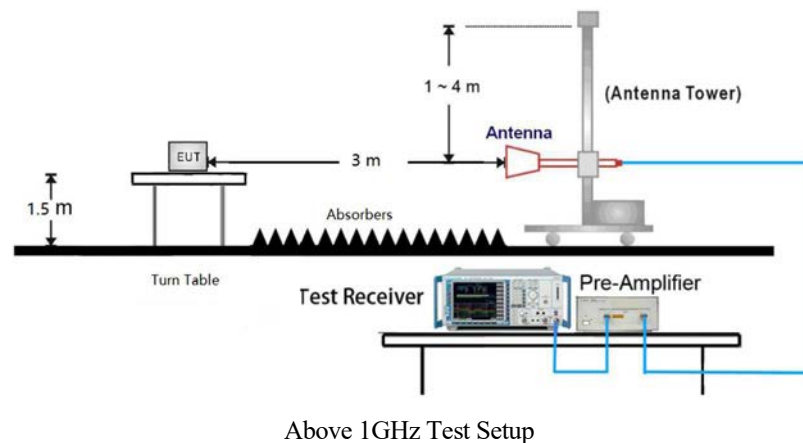
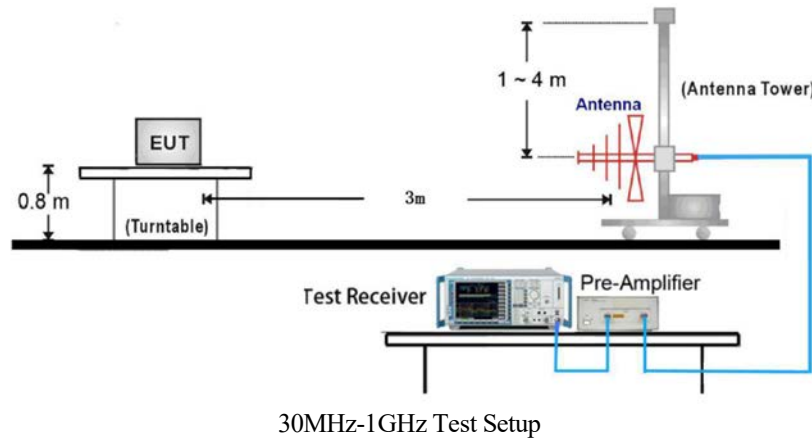

#### 3.5.3. Test Procedures

- 1) The measurement procedure follows ANSI C63.26-2015, clause 5.5.2.5 and 5.5.3.
- 2) Pre-scan is performed to determine the general EUT radiated emissions characteristics and, when necessary, the EUT-to-measurement antenna orientation that produces the maximum emission amplitude.
- 3) Use the substitution method to measure the spurious emissions:
  - (a) Place the EUT in the center of the turntable. The antenna of EUT shall be positioned to produce the worst-case emission at the fundamental operating frequency;
  - (b) Each emission under consideration shall be evaluated:
    - i) Raise and lower the measurement antenna to enable detection of the maximum emission amplitude relative to measurement antenna height.
    - ii) Rotate the EUT through 360° to determine the maximum emission level relative to the axial position.
    - iii) Return the turntable to the azimuth where the highest emission amplitude level was

- observed.
- iv) Vary the measurement antenna height again through 1 m to 4 m again to find the height associated with the maximum emission amplitude.
  - v) Record the measured emission amplitude level and frequency using the appropriate RBW.
  - (c) Repeat step (b) for each emission frequency with the measurement antenna oriented in both the horizontal and vertical polarizations to determine the orientation that gives the maximum emissions amplitude.
  - (d) Set-up the substitution measurement with the reference point of the substitution antenna located as near as possible to where the center of the EUT radiating element was located during the initial EUT measurement
  - (e) Connect a signal generator to the substitution antenna. Set the signal generator to the frequency where emissions are detected, and set an output power level such that the radiated signal can be detected by the measurement instrument, with sufficient dynamic range relative to the noise floor.
  - (f) For each emission that was detected and measured in the initial test [ in step (b) and step (c)].
  - (g) Repeat step (f) with the measurement antenna oriented in the opposite polarization.
  - (h) Calculate the emission power in dBm referenced to a half-wave dipole using the following equation:  $P_e = P_s(\text{dBm}) - \text{cable loss (dB)} + \text{antenna gain (dBd)}$   
where  
 $P_e$  = equivalent emission power in dBm  
 $P_s$  = source (signal generator) power in dBm
  - (i) Correct the antenna gain of the substitution antenna if necessary, to reference the emission power to a half-wave dipole. When using measurement antennas with the gain specified in dBi, the equivalent dipole-referenced gain can be determined from:  $\text{gain (dBd)} = \text{gain (dBi)} - 2.15 \text{ dB}$ . If necessary, the antenna gain can be calculated from calibrated antenna factor information.

### 3.5.4. Test Result

<b>Test Engineer</b>	Tian Ye	<b>Test Date</b>	2021/03/03
<b>Temperature</b>	19.7°C	<b>Relative Humidity</b>	59.8%
<b>Pressure</b>	105.3kPa	<b>Test Sample Selected</b>	No.2

Frequency (MHz)	Generator Level (dBm)	Cable Loss (dB)	Gain (dBi)	Level (dBm)	Limit (dBm)	Margin (dB)	Height (cm)	Pol	Azimuth (deg)
2937.50	-66.70	1.46	11.26	-59.05	-13.00	46.05	200.0	V	80.0
3492.38	-70.92	2.23	12.30	-63.00	-13.00	50.00	100.0	V	1.0
4792.54	-67.67	1.81	12.70	-58.93	-13.00	45.93	100.0	V	359.0
6444.68	-64.89	2.02	12.28	-56.78	-13.00	43.78	100.0	V	216.0
7905.71	-61.74	2.74	11.78	-54.85	-13.00	41.85	100.0	V	102.0
8603.81	-59.94	2.35	11.71	-52.73	-13.00	39.73	100.0	H	1.0

### 3.5.5. Uncertainty

Frequency (MHz)	$U_{lab}$	$k$
Below 1GHz	3.24	2
1GHz - 18GHz	3.40	2

### 3.6 Band Edge

#### 3.6.1. Limit

FCC 47 CFR Part 90 Subpart S - §90.691

For any frequency removed from the EA licensee's frequency block by up to and including 37.5 kHz, the power of any emission shall be attenuated below the transmitter power (P) in watts by at least  $116 \text{Log}_{10}(f/6.1)$  decibels or  $50 + 10 \text{Log}_{10}(P)$  decibels or 80 decibels, whichever is the lesser attenuation, where f is the frequency removed from the center of the outer channel in the block in kilohertz and where f is greater than 12.5 kHz.

For any frequency removed from the EA licensee's frequency block greater than 37.5 kHz, the power of any emission shall be attenuated below the transmitter power (P) in watts by at least  $43 + 10\text{Log}_{10}(P)$  decibels or 80 decibels, whichever is the lesser attenuation, where f is the frequency removed from the center of the outer channel in the block in kilohertz and where f is greater than 37.5 kHz.

#### 3.6.2. Test Setup

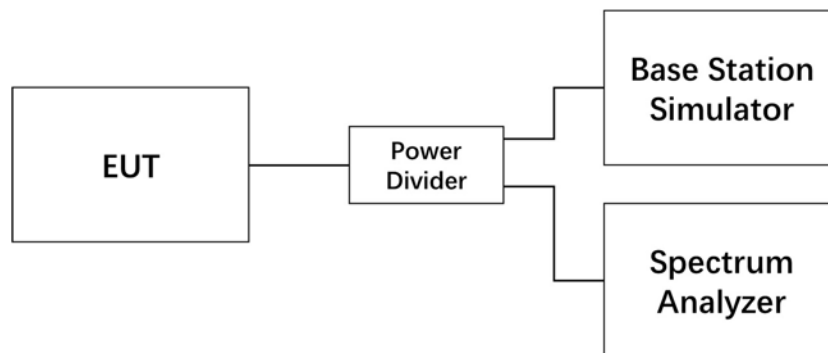

#### 3.6.3. Test Procedures

- 1) The measurement procedure follows ANSI C63.26-2015, clause 5.7.3.
- 2) The RF output of EUT, BS simulator and spectrum analyzer are connected via a power divider.
- 3) EUT is configured to transmit continuously at fully power while the compliance measurement is performed.
- 4) Set the spectrum analyzer center frequency to the block, band, or channel edge frequency.
- 5) Set the span wide enough to capture the fundamental emission closest to the band edge, and to include all modulation products that spill into the immediately adjacent frequency band.
- 6) Set the number of points in sweep  $\geq 2 \times \text{span} / \text{RBW}$ . And Sweep time should be auto.

#### 3.6.4. Test Result

Test Engineer	Xu Dongxu	Test Date	2021/03/04
Temperature	18.6°C	Relative Humidity	48.7%
Pressure	105.1kPa	Test Sample Selected	No.1

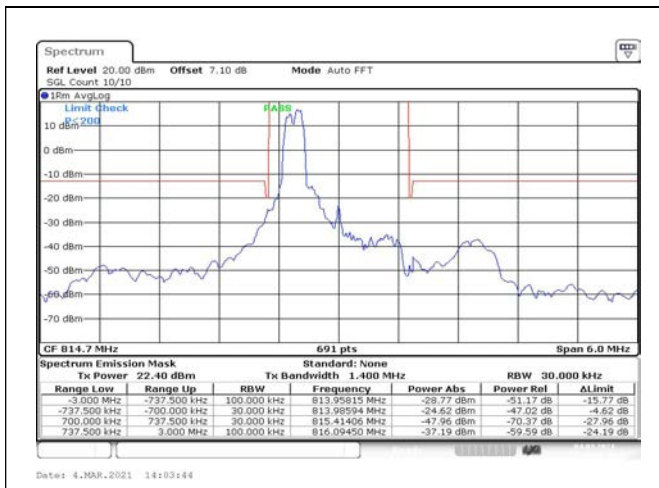
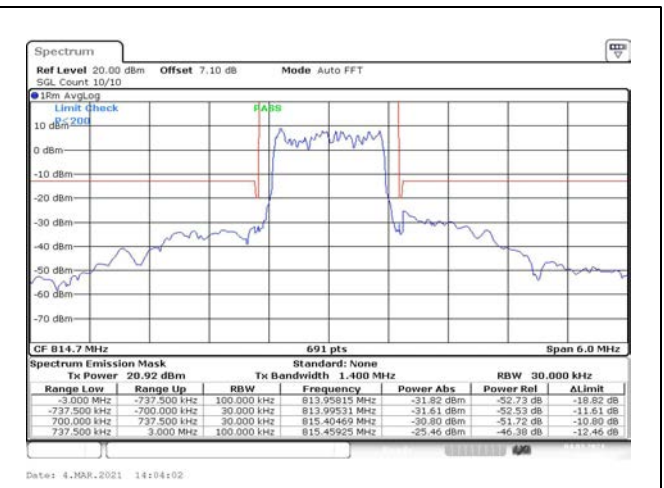
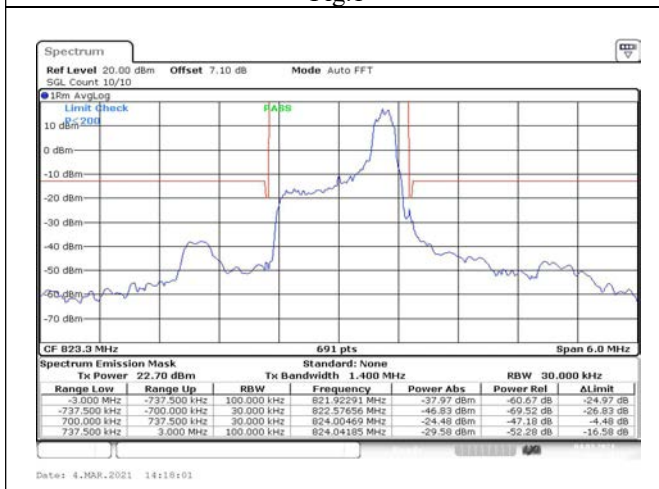
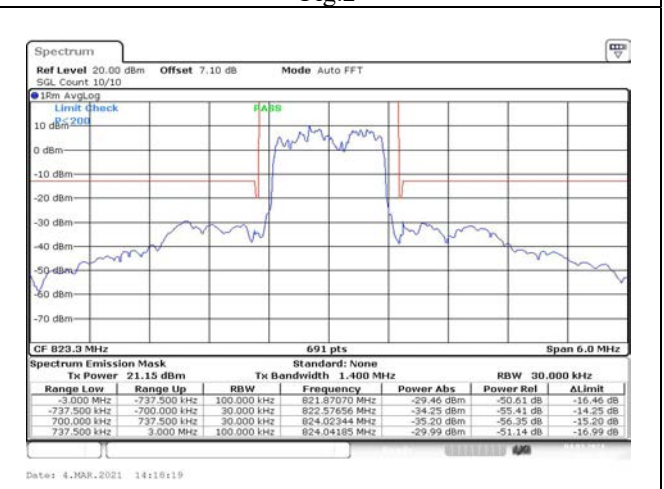

Frequency (MHz)	Channel No.	BW (MHz)	RB Size	RB Offset	Band Edges Plot
					QPSK
814.7	26697	1.4	1	0	Fig.1
			6	0	Fig.2
823.3	26783		1	5	Fig.3
			6	0	Fig.4
815.5	26705	3	1	0	Fig.5
			15	0	Fig.6
822.5	26775		1	14	Fig.7
			15	0	Fig.8
816.5	26715	5	1	0	Fig.9
			25	0	Fig.10
821.5	26765		1	24	Fig.11
			25	0	Fig.12
819.0	26740	10	1	0	Fig.13
			50	0	Fig.14
			1	49	Fig.15
				50	0

**Fig.1**

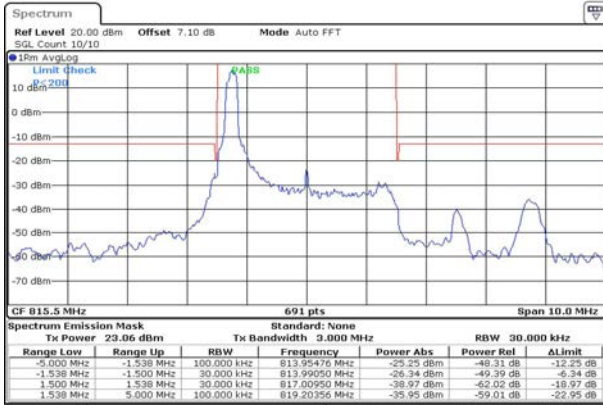
**Fig.2**

**Fig.3**

**Fig.4**

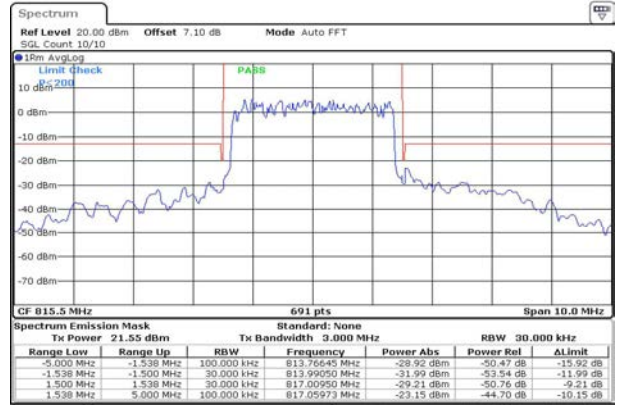

Date: 4.MAR.2021 14:23:01

Fig.5



Date: 4.MAR.2021 14:23:19

Fig.6

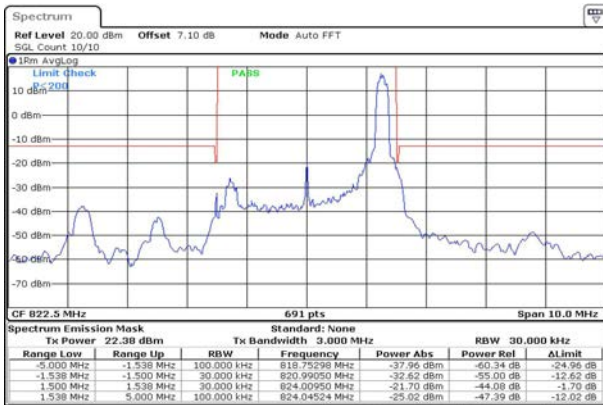

Date: 4.MAR.2021 14:32:47

Fig.7

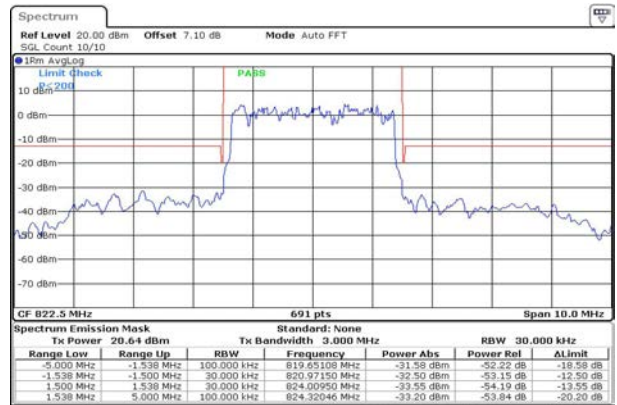

Date: 4.MAR.2021 14:33:05

Fig.8

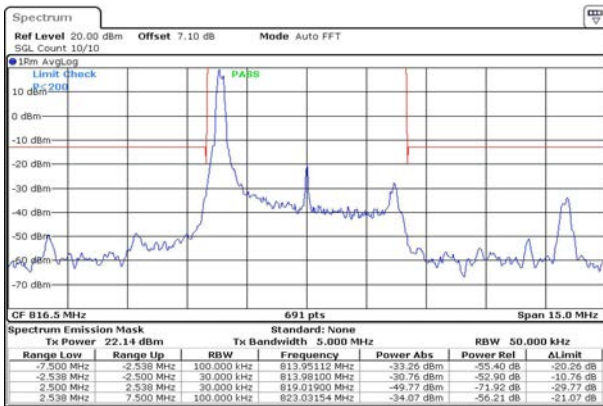

Date: 4.MAR.2021 14:37:47

Fig.9

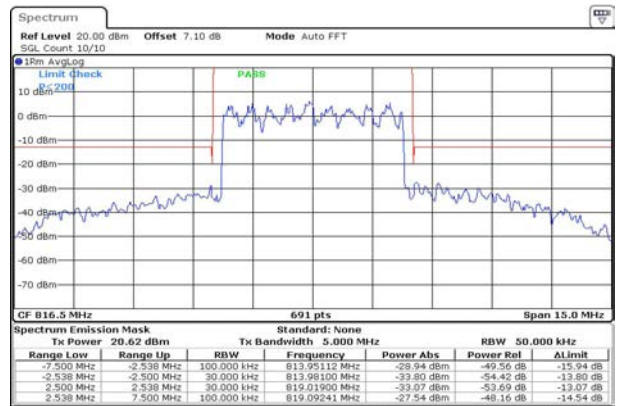

Date: 4.MAR.2021 14:38:05

Fig.10

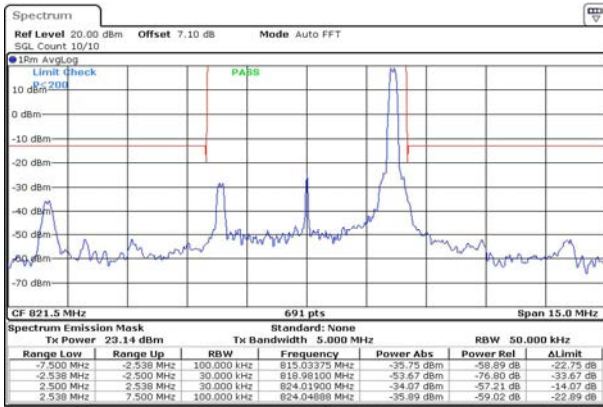

Date: 4.MAR.2021 14:47:34

Fig.11

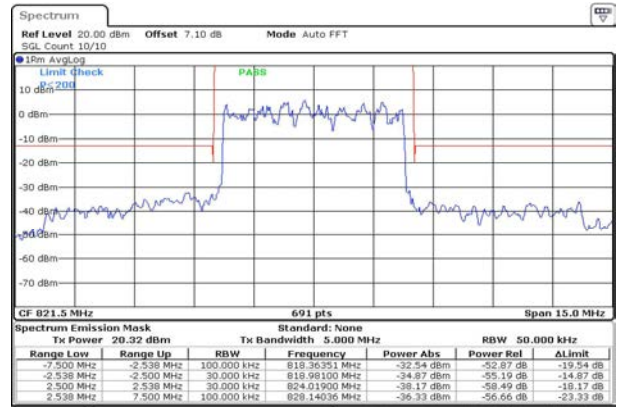

Date: 4.MAR.2021 14:47:51

Fig.12

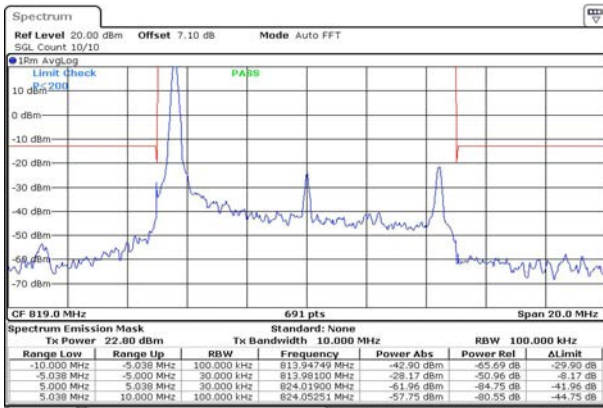

Date: 4.MAR.2021 14:55:38

Fig.13

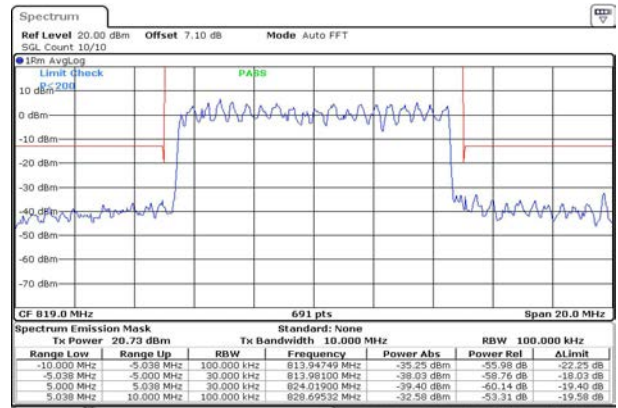

Date: 4.MAR.2021 14:55:56

Fig.14

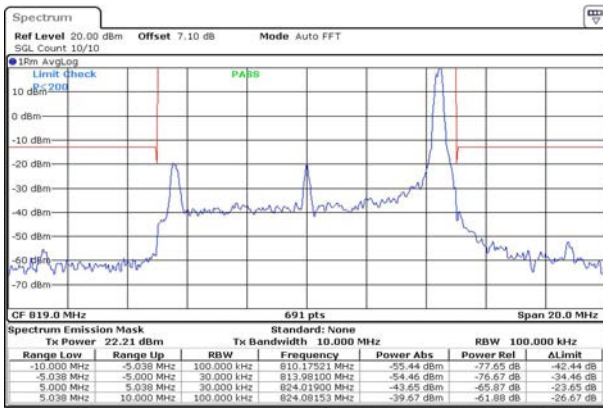

Date: 4.MAR.2021 15:06:02

Fig.15

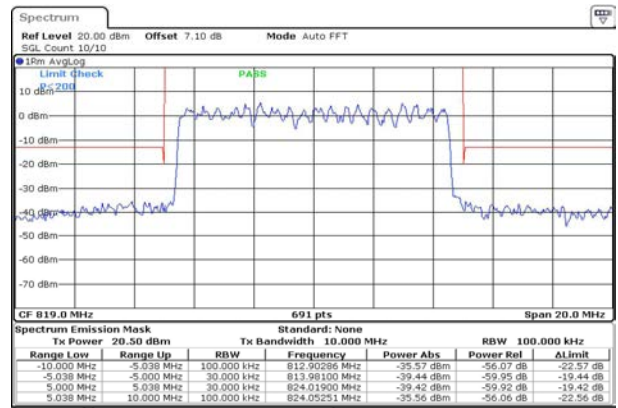

Date: 4.MAR.2021 15:06:20

Fig.16

### 3.6.5. Uncertainty

$$U_{lab}=2.46\text{dB} (k=2)$$

### 3.7 Frequency Stability

#### 3.7.1. Limit

FCC 47 CFR Part 90 Subpart S - §90.213

Frequency Range (MHz)	Fixed and Base Stations	Mobile Stations	
		Over 2 watts output Power	2 watts or less output Power
809 ~ 824	1.5ppm	2.5ppm	2.5ppm

#### 3.7.2. Test Setup

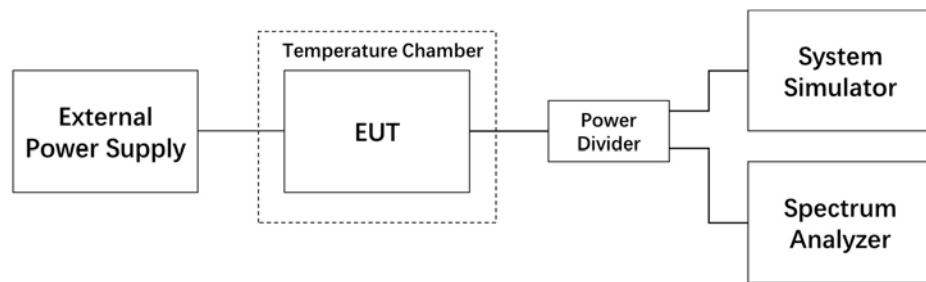

#### 3.7.3. Test Procedures

- 1) The measurement procedure follows ANSI C63.26-2015, clause 5.6.3.
- 2) Frequency Stability over variations in temperature:
  - a) The EUT can power on and work in rated supply voltage via an external power supply.
  - b) The EUT is configured to transmit RF power via a communication test set.
  - c) The EUT is placed in temperature chamber.
  - d) Measure the result of frequency error at 10°C intervals of temperature from -10°C to +55°C.
- 3) Frequency stability when varying supply voltage
  - a) The EUT is placed in a temperature chamber. The temperature in chamber is set to +20°C.
  - b) The EUT is configured to transmit RF power via a communication test set.
  - c) Measure the result of frequency error in Low voltage and high voltage mode.

#### 3.7.4. Test Result

Test Engineer	Xu Dongxu	Test Date	2021/03/05
Temperature	18.5°C	Relative Humidity	48.1%
Pressure	105.2kPa	Test Sample Selected	No.1

1) Frequency Stability when varying temperature:

Temperature(°C)	Voltage	Test Result (ppm) @ Low Channel			
		1.4M	3M	5M	10M
-10	NV	0.00	0.04	0.01	-0.01
0	NV	0.00	0.04	0.00	-0.01
+10	NV	0.00	0.04	0.00	-0.01
+20	NV	0.00	0.00	0.00	0.00
+30	NV	-0.02	0.04	-0.01	0.00
+40	NV	0.01	0.04	0.00	0.00
+50	NV	0.01	0.04	-0.01	0.00
+55	NV	0.02	0.05	0.00	0.01

Temperature(°C)	Voltage	Test Result (ppm) @ High Channel			
		1.4M	3M	5M	10M
-10	NV	-0.01	-0.04	-0.01	0.00
0	NV	-0.01	-0.04	-0.01	0.00
+10	NV	0.00	-0.04	-0.01	0.00
+20	NV	0.00	0.00	0.00	0.00
+30	NV	-0.03	-0.04	-0.01	0.01
+40	NV	0.00	-0.04	-0.01	0.01
+50	NV	-0.02	-0.05	-0.02	0.01
+55	NV	-0.05	-0.04	-0.02	0.03

2) Frequency stability when varying supply voltage:

Temperature(°C)	Voltage	Test Result (ppm) @ Low Channel			
		1.4M	3M	5M	10M
+20	LV	-0.01	0.05	-0.01	0.00
+20	HV	0.00	0.05	0.00	0.01

Temperature(°C)	Voltage	Test Result (ppm) @ High Channel			
		1.4M	3M	5M	10M
+20	LV	-0.01	-0.04	-0.01	0.01
+20	HV	0.00	-0.04	0.00	0.02

### 3.7.5. Uncertainty

Frequency (MHz)	$U_{lab}$	$k$
814.7	71.15Hz	2
819.0	71.44Hz	2
823.3	71.73Hz	2
815.5	71.21Hz	2
822.5	71.68Hz	2
816.5	71.27Hz	2
821.5	71.61Hz	2

#### 4 Test Instruments

Description	Model Name	S/N	Manufacturer	Next Cal Date
Spectrum Analyzer	FSV40	101403	R&S	2022/01/11
Three-way Power Supply	E3646A	MY43007301	Agilent	2022/01/11
Base Station Simulator	CMW500	115895	R&S	2022/01/11
Power Divider	87302C	MY44300481	Agilent	2021/07/14
Temperature Chamber	HTLH-015/40	JT1906018	Shang Hai Jing Tian	2021/07/02
Hybrid Antenna	VULB9163	01266	SCHWARZBECK	2021/07/03
Pre-Amplifier	PE15A1009	V00140120181115 E822	Pasternack Enterprises	2022/01/11
Pre-Amplifier	QLAS-1000- 18000-45-30	20255003	Qualwave	2021/07/01
Double Ridged Broadband Horn Antenna	BBHA 9120D	1276	SCHWARZBECK	2021/03/17
Double-Ridged Waveguide Horn Antenna	HF907	100096	R&S	2021/03/17
Signal Generator	E8257D	MY46520023	Agilent	2022/01/11
Digital Display Temperature and Humidity Recorder	TM320	015080	DICKSON	2021/05/08
Aneroid Barometer	DYM3	00868	Shanghai Boji	2022/05/05

--- End of Test Report ---