FCC PART 90S TEST REPORT

Report Number	BWTR-2005-FCCPCE
FCC ID	SRQ-ZTE8010
Applicant	ZTE CORPORATION
Product Name	WCDMA/LTE Multi-mode Digital Mobile Phone
Marketing Name	ZTE Blade V2020 Smart
Brand Name	ZTE
Model Name	ZTE 8010
Serial Number	No.1: 867805050001761 No.2: 867805050001837
Test Standard	FCC 47 CFR Part 90 Subpart S
Tested Date	June. 29, 2020 - July. 03, 2020

CONTENTS

1	Summary of Test Result	4
2	General Information	5
2.1	Applicant.....	5
2.2	Manufacturer	5
2.3	Product Feature of Equipment Under Test	5
2.4	Ancillary Equipment.....	5
2.5	Description of Test Modes	6
2.6	Applicable Standards	7
2.7	Test Facilities.....	7
3	Test Result	8
3.1	RF Output Power.....	8
3.2	Peak to Average Power Ratio (PAPR).....	11
3.3	Effective Radiated Power	14
3.4	Occupied Bandwidth	16
3.5	Spurious Emission at Antenna Terminal	27
3.6	Field Strength of Spurious Radiation	28
3.7	Band Edge	30
3.8	Frequency Stability.....	34
4	Test Instruments	36

Revision History

Revision	Description	Issued Date
A	Initial issue of report	2020/7/9

1 Summary of Test Result

Report Section	FCC Section	Description	Result
3.1	90.635 (b)	RF Output Power	Pass
3.2	KDB 971168 D01 v03 - 5.7	Peak to Average Power Ratio (PARR)	Pass
3.3	90.635 (b)	Effective Radiated Power	Pass
3.4	90.209 (a)	Occupied Bandwidth	Pass
3.5	90.691	Spurious Emission at Antenna Terminal	Pass
3.6	90.691	Field Strength of Spurious Radiation	Pass
3.7	90.691	Band Edge	Pass
3.8	90.213	Frequency Stability	Pass

We, Beijing Boomwave Test Service Co. Ltd., would like to declare that the tested sample has been evaluated and in compliance with the requirements of applicable standards.

Prepared by:  2020.07.09
 19:12:50
 +08'00'

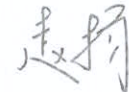
Reviewed by:  2020.07.09
 19:14:06 +08'00'

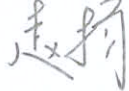
Approved by:  2020.07.09
 19:14:34 +08'00'

Rationale:

The test results in this report apply exclusively to the tested model / sample.
 The electrical copy of test report is invalid without the signatures. The hard copy is invalid without seal.
 The test report shall not be modified, republished or copied without the written authorization of the laboratory.

2 General Information

2.1 Applicant

ZTE CORPORATION

Electronic Testing Building, No. 43 Shahe Road, Xili street, Shenzhen, Guangdong, China

2.2 Manufacturer

ZTE CORPORATION

Electronic Testing Building, No. 43 Shahe Road, Xili street, Shenzhen, Guangdong, China

2.3 Product Feature of Equipment Under Test

Product Name	WCDMA/LTE Multi-mode Digital Mobile Phone
Marketing Name	ZTE Blade V2020 Smart
Model Name	ZTE 8010
Sample Status	Production
Operating Frequency Range	814MHz~824MHz
Type of Wireless Technology	FDD LTE - Band 26
Modulation Type	QPSK, 16QAM, 64QAM
Channel Bandwidth	1.4MHz, 3MHz, 5MHz, 10MHz
Antenna Type	Internal Antenna
Antenna Gain	-1.3dBi
Extreme Operating Temperature	Minimum: -10°C
	Maximum: +55°C
Power Supply	Normal Voltage: 3.85V
	Lowest Voltage: 3.40V
	Highest Voltage: 4.40V
Hardware Version	Z12A
Software Version	TEL_MX_ZTE_8010V1.0
Sample Received Date	2020/6/26

2.4 Ancillary Equipment

The EUT has been tested as an independent unit together with other necessary accessories or support units. The following ancillary equipment were used to form a representative test configuration during the tests.

Support Unit	Adapter
Manufacturer	JIANGSU CHENYANG ELECTRON CO LTD
Model Name	STC-A520A-Z
Input Power	100-240Vac, 50/60Hz, 400mA
Output Power	5V, 2A
Power Line	1m non-shielded AC cable without core attached on
Serial Number	G02004090365314120

Support Unit	Headset
Manufacturer	Shenzhen FDC Electronic Co.,Ltd
Model Name	DEM-66
Serial Number	---

2.5 Description of Test Modes

The EUT was linked by base station simulator to work in continuous transmitting and receiving mode. Pre-Scan has been conducted to determine the worst-case mode from all possible combinations between available modulations, bandwidth, resource block (RB) and RB offset.

Following channels were selected for test:

Channel Bandwidth	Low Channel		Mid Channel		High Channel	
	Frequency (MHz)	Channel No.	Frequency (MHz)	Channel No.	Frequency (MHz)	Channel No.
1.4MHz	814.7	26697	819.0	26740	823.3	26783
3MHz	815.5	26705	819.0	26740	822.5	26775
5MHz	816.5	26715	819.0	26740	821.5	26765
10MHz	---		819.0	26740	---	

Following modes were selected as the worst case configuration for each test:

Test Items	Channel	BW (MHz)	RB Size	RB Offset	Modulation	Antenna Orientation
RF Output Power	L\M\H	1.4	1\3\6	0\5\2	QPSK,16QAM,64QAM	N/A
		3	1\8\15	0\14\4		
		5	1\12\25	0\24\6		
		10	1\24\50	0\49\12		
Peak to Average Power Ratio	M	1.4\3\5\10	1	0	QPSK,16QAM,64QAM	N/A
Effective Radiated Power	L\M\H	1.4\3\5\10	1	0	QPSK,16QAM,64QAM	X axis
Occupied Bandwidth	L\M\H	1.4	6	0	QPSK,16QAM,64QAM	N/A
		3	15			
		5	25			
		10	50			
Spurious Emission at Antenna Terminal	M	10	1	0	QPSK	N/A
Field Strength of Spurious Radiation	M	10	1	0	QPSK	X axis
Band Edge	L\H	1.4	1\6	0\5	QPSK	N/A
		3	1\15	0\14		
		5	1\25	0\24		
		10	1\50	0\49		
Frequency Stability	L\H	10	1	0	QPSK	N/A

2.6 Applicable Standards

Standard	Version	Title
FCC 47 CFR Part 90 Subpart S	2019	Regulations Governing Licensing and Use of Frequencies in the 806-824, 851-869, 896-901, and 935-940 MHz Bands
ANSI C63.26	2015	American National Standard for Compliance Testing of Transmitters Used in Licensed Radio Services

2.7 Test Facilities

Company Name: Beijing Boomwave Test Service Co. Ltd

Address: EMC Building, No.1 Wang Jing East Road, Chao Yang District Beijing, P.R. China 100102

CNAS Registration Number: CNAS L12797

FCC Test Firm Registration Number: 613197

ISED Canada Registration No.: 24289 (CAB Identifier: CN0010)

VCCI Registration No.: R-20062, G-20063, C-20050, T-20049

Test Site	Description	Dimension	Ground Plane Size
<input type="checkbox"/> SAC10	10m semi-anechoic chamber	19.5m×12.9m×8.6m	4m×4m
<input checked="" type="checkbox"/> SAC3	3m semi-anechoic chamber	9.6m×6.4m×6.0m	9.6m×6.4m
<input type="checkbox"/> SR#1	Shielding Room for EMS test	8.1m×4.05m×2.755m	8.1m×4.05m
<input checked="" type="checkbox"/> SR#2	Shielding Room for RF test	8.1m×4.05m×2.755m	---

3 Test Result

3.1 RF Output Power

3.1.1. Limit

FCC 47 CFR Part 90 Subpart S - §90.635(b)
The maximum output power of the transmitter for mobile station is 100 watts (20dBw).

3.1.2. Test Setup

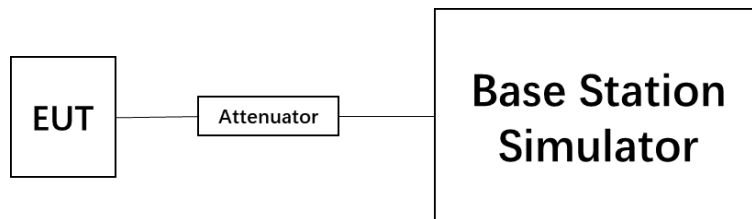

3.1.3. Test Procedures

- 1) The measurement procedure follows ANSI C63.26-2015, clause 5.2.
- 2) The RF output of EUT and BS simulator are connected via a sufficient attenuation.
- 3) EUT is configured to transmit the maximum output power while the measurement is performed.

3.1.4. Test Result

Test Engineer	Xu Dongxu	Test Date	2020.06.29
Temperature	21.8°C	Relative Humidity	50.1%
Pressure	101.5kPa	Test Sample Selected	No.1

Modulation Type	Frequency (MHz)	BW (MHz)	RB Size	RB Offset	Output Power (dBm)
QPSK	814.7	1.4	1	0	24.98
			1	5	24.98
			3	2	23.89
			6	0	23.85
	819.0		1	0	25.09
			1	5	25.07
			3	2	23.73
			6	0	23.80
	823.3		1	0	24.79
			1	5	24.81
			3	2	23.79
			6	0	23.74
16QAM	814.7	1.4	1	0	24.41
			1	5	24.36
			3	2	22.90
			6	0	22.83
	819.0		1	0	24.37
			1	5	24.36
			3	2	22.86
			6	0	22.84
	823.3		1	0	24.31
			1	5	24.23
			3	2	22.81
			6	0	22.76

Modulation Type	Frequency (MHz)	BW (MHz)	RB Size	RB Offset	Output Power (dBm)
64QAM	814.7	1.4	1	0	24.00
			1	5	23.93
			3	2	22.82
			6	0	22.89
	819.0		1	0	23.90
			1	5	23.92
			3	2	22.83
			6	0	22.79
	823.3		1	0	23.71
			1	5	23.74
			3	2	22.80
			6	0	22.92

Modulation Type	Frequency (MHz)	BW (MHz)	RB Size	RB Offset	Output Power (dBm)
QPSK	815.5	3	1	0	24.91
			1	14	24.94
			8	4	23.87
			15	0	23.82
	819.0		1	0	25.07
			1	14	25.12
			8	4	23.76
			15	0	23.88
	822.5		1	0	24.88
			1	14	24.93
			8	4	23.82
			15	0	23.67
16QAM	815.5	3	1	0	24.36
			1	14	24.28
			8	4	23.02
			15	0	22.86
	819.0		1	0	24.34
			1	14	24.25
			8	4	22.92
			15	0	22.86
	822.5		1	0	24.23
			1	14	24.29
			8	4	22.81
			15	0	22.78
64QAM	815.5	3	1	0	23.92
			1	14	23.94
			8	4	22.82
			15	0	22.91
	819.0		1	0	23.96
			1	14	23.84
			8	4	22.85
			15	0	22.76
	822.5		1	0	23.82
			1	14	23.69
			8	4	22.78
			15	0	22.91

Modulation Type	Frequency (MHz)	BW (MHz)	RB Size	RB Offset	Output Power (dBm)
QPSK	816.5	5	1	0	25.04
			1	24	25.05
			12	6	23.93
			25	0	23.90
	819.0		1	0	25.21
			1	24	25.16
			12	6	23.84
			25	0	23.91
	821.5		1	0	24.91
			1	24	24.94
			12	6	23.90
			25	0	23.82
16QAM	816.5	5	1	0	24.49
			1	24	24.41
			12	6	23.03
			25	0	22.93
	819.0		1	0	24.41
			1	24	24.38
			12	6	23.01
			25	0	22.88
	821.5		1	0	24.34
			1	24	24.31
			12	6	22.92
			25	0	22.80
64QAM	816.5	5	1	0	24.06
			1	24	23.97
			12	6	22.88
			25	0	23.02
	819.0		1	0	23.98
			1	24	23.97
			12	6	22.89
			25	0	22.90
	821.5		1	0	23.86
			1	24	23.84
			12	6	22.81
			25	0	23.03

Modulation Type	Frequency (MHz)	BW (MHz)	RB Size	RB Offset	Output Power (dBm)
QPSK	819.0	10	1	0	25.21
			1	49	25.16
			24	12	23.84
			50	0	23.91
16QAM	819.0	10	1	0	24.41
			1	49	24.38
			24	12	23.01
			50	0	22.88
64QAM	819.0	10	1	0	23.98
			1	49	23.97
			24	12	22.89
			50	0	22.90

3.1.5. Uncertainty

$$U_{lab}=1.48\text{dB} (k=2)$$

3.2 Peak to Average Power Ratio (PAPR)

3.2.1. Limit

In measuring transmissions in this band using an average power technique, the peak-to-average ratio (PAR) of the transmission may not exceed 13dB.

3.2.2. Test Setup

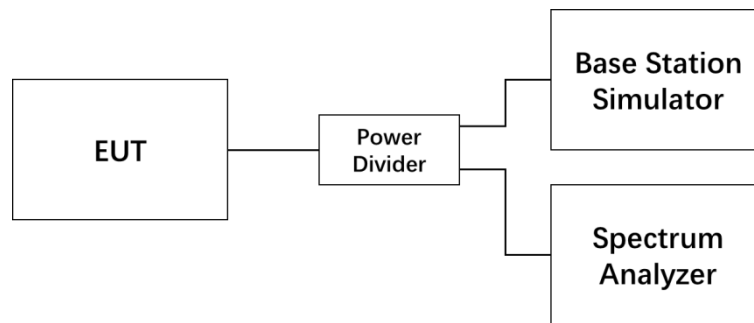

3.2.3. Test Procedures

- 1) The measurement procedure follows ANSI C63.26-2015, clause 5.2.6.
- 2) The RF output of the EUT, BS simulator and spectrum analyzer are connected via a power divider.
- 3) Measure the total peak power and record as P_{Pk} .
- 4) Measure the total average power and record as P_{Avg} .
- 5) Calculate the PAPR from: $PAPR (dB) = P_{Pk} (dBm) - P_{Avg} (dBm)$.

3.2.4. Test Result

Test Engineer	Xu Dongxu	Test Date	2020.06.29
Temperature	21.8°C	Relative Humidity	50.1%
Pressure	101.5kPa	Test Sample Selected	No.1

Frequency (MHz)	Channel No.	BW (MHz)	RB Size	RB Offset	QPSK	16-QAM	64-QAM
819.0	26740	1.4	1	0	Fig.1	Fig.2	Fig.3
		3	1	0	Fig.4	Fig.5	Fig.6
		5	1	0	Fig.7	Fig.8	Fig.9
		10	1	0	Fig.10	Fig.11	Fig.12

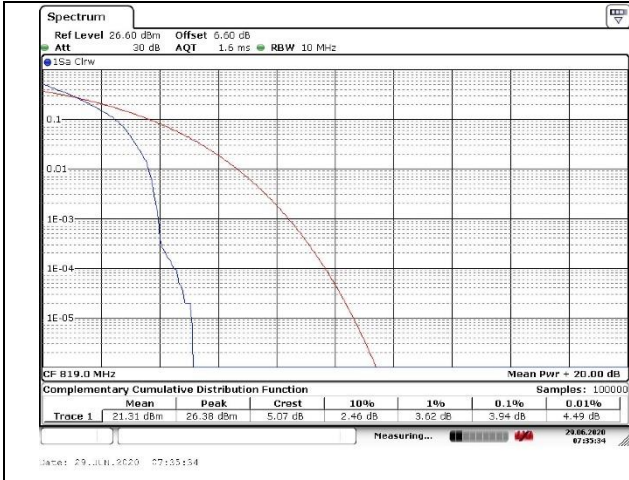

Fig.1



Fig.2

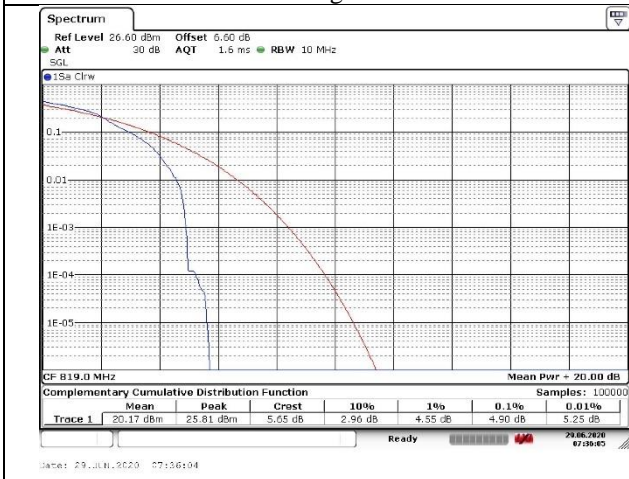

Fig.3

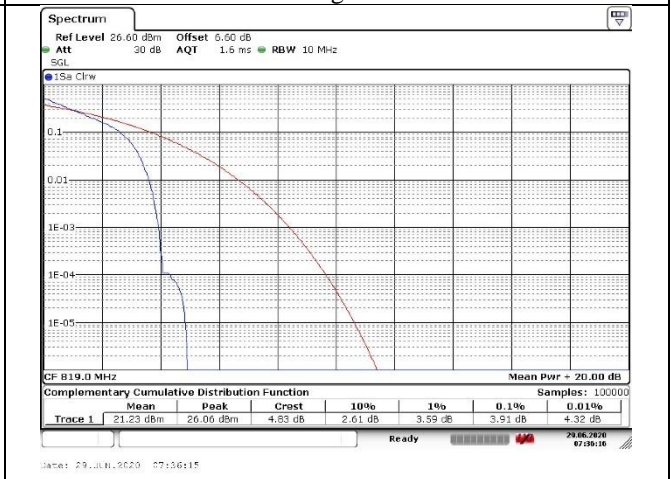

Fig.4

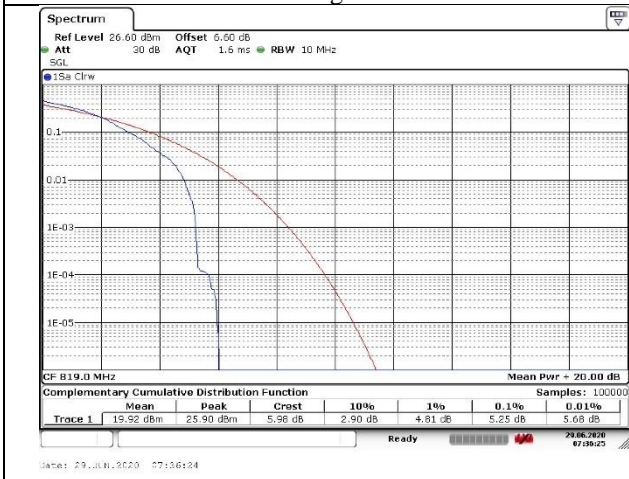

Fig.5



Fig.6

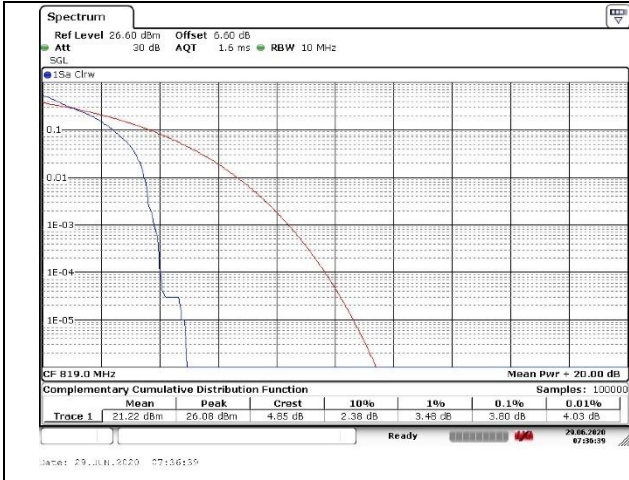

Fig.7



Fig.8

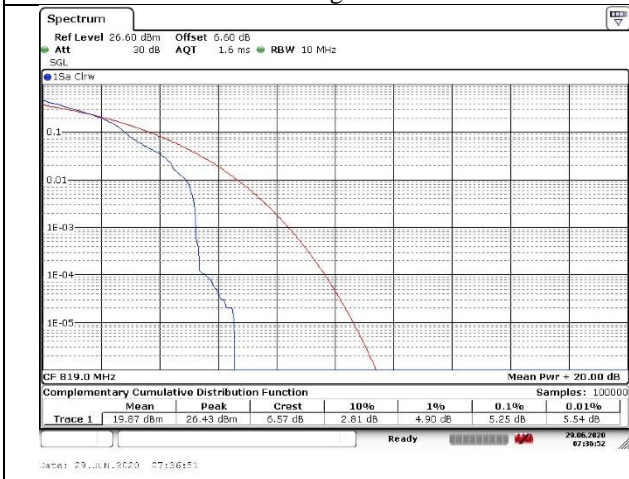

Fig.9

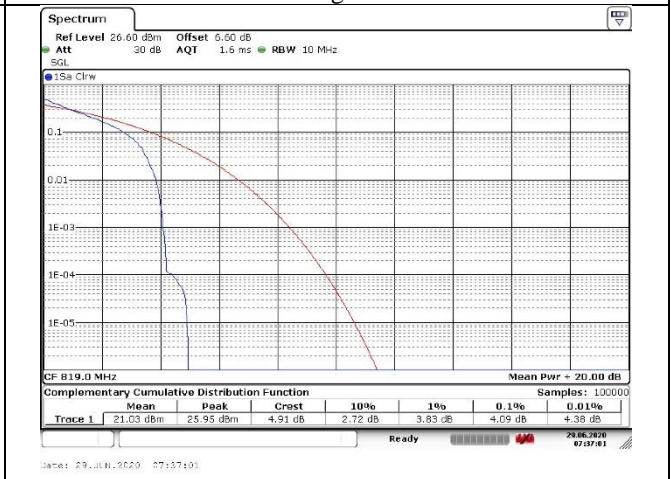

Fig.10

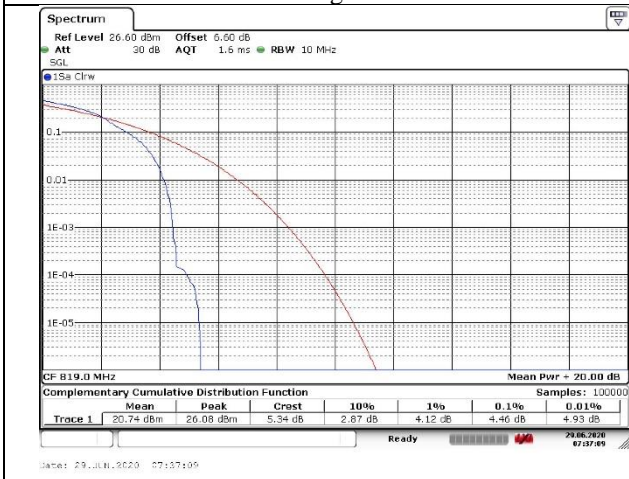

Fig.11



Fig.12

3.2.5. Uncertainty

$$U_{lab}=1.48\text{dB} (k=2)$$

3.3 Effective Radiated Power

3.3.1. Limit

FCC 47 CFR Part 90 Subpart S - §90.635 (b)

The maximum output power of the transmitter for mobile station is 100 watts (20dBw).

3.3.2. Test Setup

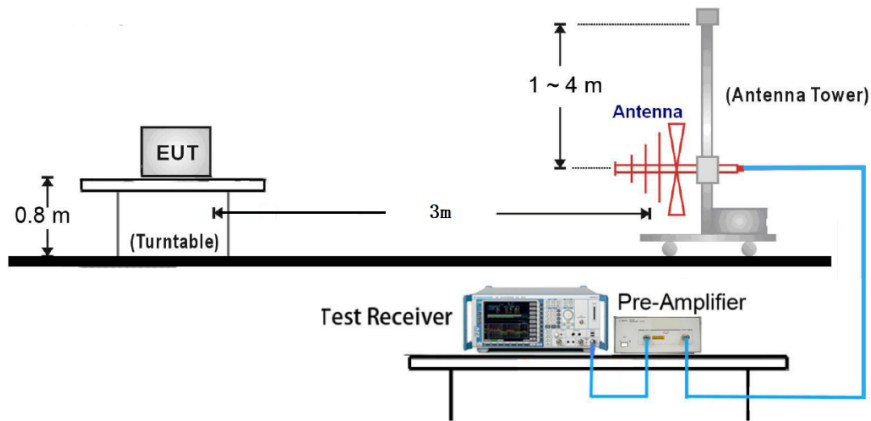

3.3.3. Test Procedures

- 1) The measurement procedure follows ANSI C63.26-2015, clause 5.2.7.
- 2) Connect the equipment as illustrated. Mount the equipment with the manufacturer specified antenna in a vertical orientation on a manufacturer specified mounting surface located on a non-conducting rotating platform of a RF anechoic chamber (preferred) or a standard radiation site.
- 3) Key the transmitter, then rotate the EUT 360° azimuthally and record spectrum analyzer power level (LVL) measurements at angular increments that are sufficiently small to permit resolution of all peaks. If a standard radiation test site is used, raise and lower the test antenna to obtain a maximum reading at each angular increment. (Note: several batteries may be needed to offset the effect of battery voltage droop, which should not exceed 5% of the manufactured specified battery voltage during transmission).
- 4) Replace the transmitter under test with a vertically polarized half-wave dipole (or an antenna whose gain is known relative to an ideal half-wave dipole). The center of the antenna should be at the same location as the center of the antenna under test.
- 5) Connect the antenna to a signal generator with a known output power and record the path loss (in dB) as LOSS. If a standard radiation test site is used, raise and lower the test antenna to obtain a maximum reading. $LOSS = \text{Generator Output Power (dBm)} - \text{Analyzer reading (dBm)}$.
- 6) Determine the effective radiated output power at each angular position from the readings in steps 2) and 4) using the following equation: $ERP \text{ (dBm)} = LVL \text{ (dBm)} + LOSS \text{ (dB)}$
- 7) The maximum ERP is the maximum value determined in the preceding step.
- 8) When calculating ERP, in addition to knowing the antenna radiation and matching characteristics, it is necessary to know the loss values of all elements (e.g. transmission line attenuation, mismatches, filters, combiners) interposed between the point where transmitter output power is measured, and the point where power is applied to the antenna. ERP can then be calculated as follows:

$$EIRP \text{ (dBm)} = \text{Output Power (dBm)} - \text{Losses (dB)} + \text{Antenna Gain (dBi)}$$

where: dB refers to gain relative to an ideal dipole.

$$EIRP \text{ (dBm)} = ERP \text{ (dBm)} + 2.15 \text{ (dB)}$$

The RB allocation refers the configuration of maximum output power.

3.3.4. Test Result

Test Engineer	Gao Yanan	Test Date	2020.7.3
Temperature	24.2°C	Relative Humidity	51.6%
Pressure	103.2kPa	Test Sample Selected	No.2

Modulation	BW (MHz)	Frequency (MHz)	RB/RB offset	EIRP/ERP (dBm)	EIRP/ERP (W)
QPSK	1.4	814.7	1#0	25.95	0.39
QPSK	1.4	819.0	1#0	25.13	0.33
QPSK	1.4	823.3	1#0	25.22	0.33
16QAM	1.4	814.7	1#0	25.10	0.32
16QAM	1.4	819.0	1#0	25.20	0.33
16QAM	1.4	823.3	1#0	25.17	0.33
64QAM	1.4	814.7	1#0	24.76	0.30
64QAM	1.4	819.0	1#0	24.84	0.30
64QAM	1.4	823.3	1#0	24.69	0.29
QPSK	3	815.5	1#0	25.31	0.34
QPSK	3	819.0	1#0	25.12	0.32
QPSK	3	822.5	1#0	25.70	0.37
16QAM	3	815.5	1#0	24.39	0.27
16QAM	3	819.0	1#0	24.73	0.30
16QAM	3	822.5	1#0	25.21	0.33
64QAM	3	815.5	1#0	24.90	0.31
64QAM	3	819.0	1#0	24.12	0.26
64QAM	3	822.5	1#0	24.04	0.25
QPSK	5	816.5	1#0	25.40	0.35
QPSK	5	819.0	1#0	25.37	0.34
QPSK	5	821.5	1#0	25.79	0.38
16QAM	5	816.5	1#0	24.72	0.30
16QAM	5	819.0	1#0	25.18	0.33
16QAM	5	821.5	1#0	25.02	0.32
64QAM	5	816.5	1#0	24.71	0.30
64QAM	5	819.0	1#0	24.56	0.29
64QAM	5	821.5	1#0	24.41	0.28
QPSK	10	819.0	1#0	25.55	0.36
16QAM	10	819.0	1#0	24.44	0.28
64QAM	10	819.0	1#0	24.76	0.30

3.3.5. Uncertainty

$$U_{lab}=3.24\text{dB} (k=2)$$