



EMC TEST REPORT

Applicant ZTE Corporation
FCC ID SRQ-ZTEMF971V
Product LTE Ufi
Model MF971V
Marketing MF971V
Report No. R1808A0375-E1
Issue Date September 18, 2018

TA Technology (Shanghai) Co., Ltd. tested the above equipment in accordance with the requirements in **FCC Code CFR47 Part15B (2018)/ ANSI C63.4 (2014)**. The test results show that the equipment tested is capable of demonstrating compliance with the requirements as documented in this report.

Wei Liu

Guangchang Fan

Performed by: Wei Liu/ Manager

Approved by: Guangchang Fan/ Director

TA Technology (Shanghai) Co., Ltd.

No.145, Jintang Rd, Tangzhen Industry Park, Pudong Shanghai, China

TEL: +86-021-50791141/2/3

FAX: +86-021-50791141/2/3-8000



Table of Contents

1	Test Laboratory.....	4
1.1	Notes of the Test Report.....	4
1.2	Test facility.....	4
1.3	Testing Location.....	5
2	General Description of Equipment under Test.....	6
2.1	Client Information.....	6
2.2	General information.....	6
2.3	Applied Standards.....	8
2.4	Test Mode.....	9
3	Test Case Results.....	10
3.1	Radiated Emission.....	10
3.2	Conducted Emission.....	16
4	Main Test Instrument.....	18



Summary of measurement results

Number	Test Case	Clause in FCC Rules	Conclusion
1	Radiated Emission	15.109, ANSI C63.4-2014	PASS
2	Conducted Emission	15.107, ANSI C63.4-2014	PASS
Test Date: August 16, 2018~ September 17, 2018			

1 Test Laboratory

1.1 Notes of the Test Report

This report shall not be reproduced in full or partial, without the written approval of **TA technology (shanghai) co., Ltd.** The results documented in this report apply only to the tested sample, under the conditions and modes of operation as described herein .Measurement Uncertainties were not taken into account and are published for informational purposes only. This report is written to support regulatory compliance of the applicable standards stated above.

1.2 Test facility

CNAS (accreditation number: L2264)

TA Technology (Shanghai) Co., Ltd. has obtained the accreditation of China National Accreditation Service for Conformity Assessment (CNAS).

FCC (Designation number: CN1179, Test Firm Registration Number: 446626)

TA Technology (Shanghai) Co., Ltd. has been listed on the US Federal Communications Commission list of test facilities recognized to perform electromagnetic emissions measurements.

IC (recognition number is 8510A)

TA Technology (Shanghai) Co., Ltd. has been listed by industry Canada to perform electromagnetic emission measurement.

VCCI (recognition number is C-4595, T-2154, R-4113, G-10766)

TA Technology (Shanghai) Co., Ltd. has been listed by industry Japan to perform electromagnetic emission measurement.

A2LA (Certificate Number: 3857.01)

TA Technology (Shanghai) Co., Ltd. has been listed by American Association for Laboratory Accreditation to perform electromagnetic emission measurement.



1.3 Testing Location

Company: TA Technology (Shanghai) Co., Ltd.
Address: No.145, Jintang Rd, Tangzhen Industry Park, Pudong Shanghai, China
City: Shanghai
Post code: 201201
Country: P. R. China
Contact: Xu Kai
Telephone: +86-021-50791141/2/3
Fax: +86-021-50791141/2/3-8000
Website: <http://www.ta-shanghai.com>
E-mail: xukai@ta-shanghai.com

2 General Description of Equipment under Test

2.1 Client Information

Applicant	ZTE Corporation
Applicant address	ZTE Plaza, Keji Road South, Hi-Tech, Industrial Park, Nanshan District, Shenzhen, Guangdong, 518057, P.R.China
Manufacturer	ZTE Corporation
Manufacturer address	ZTE Plaza, Keji Road South, Hi-Tech, Industrial Park, Nanshan District, Shenzhen, Guangdong, 518057, P.R.China

2.2 General information

EUT Description			
Device Type:	Portable Device		
Model Number:	MF971V		
IMEI:	869626020917268		
HW Version:	drnA		
SW Version:	BD_MF971VV1.0.0B05		
Antenna Type:	Internal Antenna		
Frequency:	Band	Tx (MHz)	Rx (MHz)
	GSM 850	824 ~ 849	869 ~ 894
	GSM 1900	1850 ~ 1910	1930 ~ 1990
	WCDMA Band II	1850 ~ 1910	1930 ~ 1990
	WCDMA Band V	824 ~ 849	869 ~ 894
	LTE Band 2	1850 ~ 1910	1930 ~ 1990
	LTE Band 4	1710 ~ 1755	2110 ~ 2155
	LTE Band 5	824 ~ 849	869 ~ 894
	LTE Band 7	2500 ~ 2570	2620 ~ 2690
	WIFI 2.4G:	2412 ~ 2462	2412 ~ 2462
	WIFI 5G(U-NII-1):	5150 ~ 5250	5150 ~ 5250
	WIFI 5G(U-NII-3):	5725 ~ 5825	5725 ~ 5825
Modulation:	GPRS: GMSK EGPRS: GMSK/8PSK WCDMA RMC: QPSK HSDPA: QPSK HSUPA: QPSK		



	DC-HSDPA:64QAM LTE: QPSK / 16QAM WLAN 802.11b: DSSS WLAN 802.11a/g/n/ac: OFDM
Test Mode:	Transfer Data Mode
EUT Accessory	
Adapter 1	Manufacturer: SHENZHEN RUIJING INDUSTRIAL CO LTD Model: STC-A51A-Z
Adapter 2	Manufacturer: Jiangsu Chenyang Electron Co., Ltd. Model: STC-A51A-Z
Battery	Manufacturer: Zhongshan Tianmao Battery Co.,Ltd Model: Li3820T43P3h715345
USB Cable	98cm Cable, Shielded
Auxiliary test equipment	
PC	PC Manufacturer: Dell Model: E5430 (SN : R98M9 A02)
Note: The information of the EUT is declared by the manufacturer. 2. There is more than one Adapter, each one should be applied throughout the compliance test respectively, and however, only the worst case (Adapter 1) will be recorded in this report.	



2.3 Applied Standards

According to the specifications of the manufacturer, it must comply with the requirements of the following standards:

Test standards

FCC Code CFR47 Part15B (2018)

ANSI C63.4 (2014)



2.4 Test Mode

Test Mode	
Mode 1	USB Copy(EUT with PC) + USB cable +Idle

3 Test Case Results

3.1 Radiated Emission

Ambient condition

Temperature	Relative humidity	Pressure
24°C~26°C	45%~50%	102.5kPa

Methods of Measurement

The EUT is placed on a non-metallic table 0.8m above the horizontal metal reference ground plane. The distance between EUT and receive antenna should be 3 meters. During the test, the EUT was operating in its typical mode. The test method is according to ANSI C63.4-2014. Sweep the whole frequency band through the range from 30MHz to the 5th harmonic of the carrier. During the test, the height of receive antenna shall be moved from 1 to 4 meters, and the antenna shall be performed under horizontal and vertical polarization. The turn table shall be rotated from 0 to 360 degrees for detecting the maximum of radiated signal level.

The data of cable loss and antenna factor has been calibrated in full testing frequency range before the testing. During the test, the EUT is worked at maximum output power.

Set the spectrum analyzer in the following:

Below 1GHz:

RBW=100 kHz / VBW=300 kHz / Sweep=AUTO

Above 1GHz:

(a) PEAK: RBW=1MHz / VBW=3MHz/ Sweep=AUTO

(b) AVERAGE: RBW=1MHz / VBW=1Hz / Sweep=AUTO

The radiated emission was measured in the following position: EUT stand-up position (Z axis), lie-down position (X, Y axis). The worst emission was found in lie-down position (X axis) and the worst case was recorded.

During the test, EUT is connected to a laptop via a USB cable in the case of Transfer Data mode. The EUT is used as the peripheral equipment of the PC. The data is transferred from EUT to PC; PC is connected to server via a long LAN cable.

Test Setup

Below 1GHz

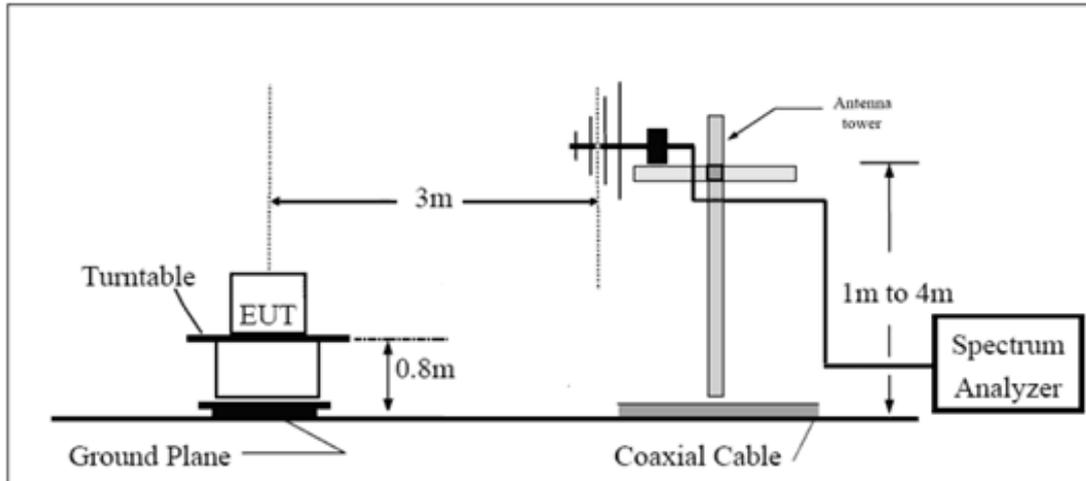

Above 1GHz

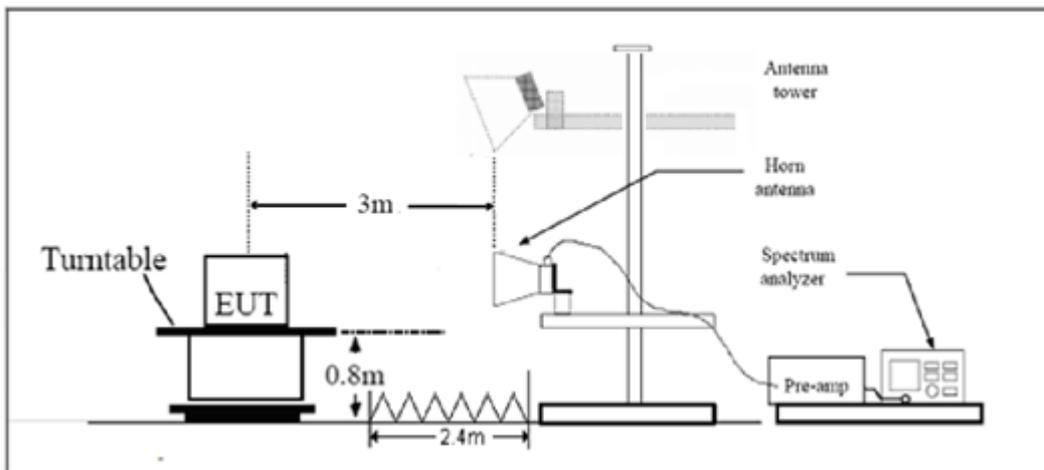

Note: Area side:2.4mX3.6m

Antenna Tower meets ANSI C63.4 requirements for measurements above 1 GHz by keeping the antenna aimed at the EUT during the antenna's ascent/ descent along the antenna mast.

Limits

Frequency (MHz)	Field Strength (dB μ V/m)	Detector
30 -88	40.0	Quasi-peak
88-216	43.5	Quasi-peak
216 – 960	46.0	Quasi-peak
960-1000	54.0	Quasi-peak
1000-5 th harmonic of the highest frequency or 40GHz, which is lower	54 74	Average Peak

Measurement Uncertainty

The assessed measurement uncertainty to ensure 95% confidence level for the normal distribution is with the coverage factor $k = 1.96$. $U = 3.704$ dB.

Test Results

The following graphs display the maximum values of horizontal and vertical by software.
 For above 1GHz, Blue trace uses the peak detection, Green trace uses the average detection.

RE 30M-1GHz QP

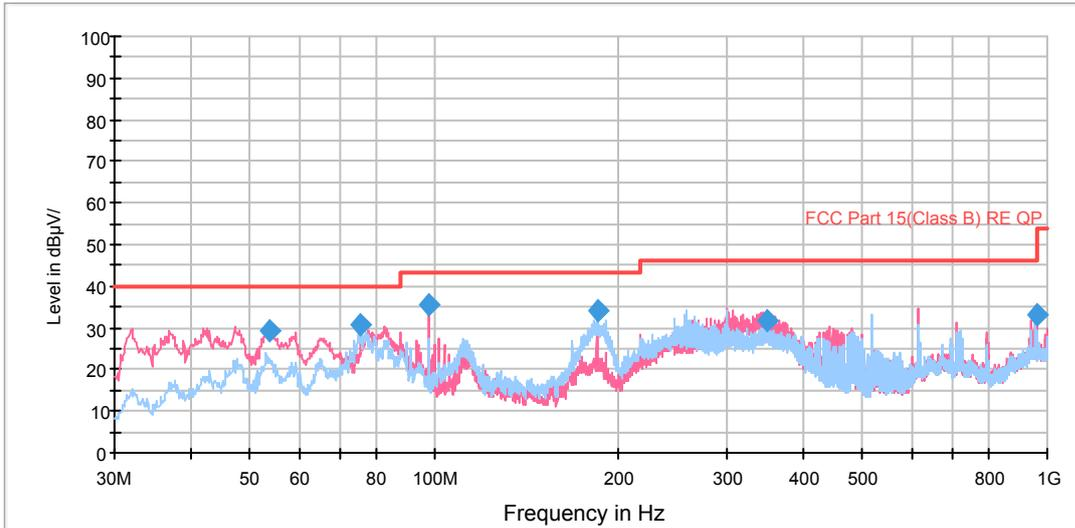

Radiated Emission from 30MHz to 1GHz

Frequency (MHz)	Quasi-Peak (dBuV/m)	Reading value (dBuV/m)	Height (cm)	Polarization	Azimuth (deg)	Correct Factor (dB)	Margin (dB)	Limit (dBuV/m)
53.669640	29.4	49.1	100.0	V	109.0	-19.72	10.6	40.0
75.761972	30.6	57.7	225.0	H	327.0	-27.13	9.4	40.0
97.734303	35.6	59.4	100.0	V	296.0	-23.81	7.9	43.5
184.249425	34.1	60.8	225.0	H	202.0	-26.67	9.4	43.5
348.169500	31.7	52.4	100.0	V	177.0	-20.69	14.3	46.0
959.665500	33.1	43.8	120.0	V	22.0	-10.69	12.9	46.0

- Remark:**
1. Quasi-Peak = Reading value + Correction factor
 2. Correction Factor = Antenna factor+ Insertion loss(cable loss+amplifier gain)
 3. Margin = Limit – Quasi-Peak

RE 1G-3GHz PK+AV

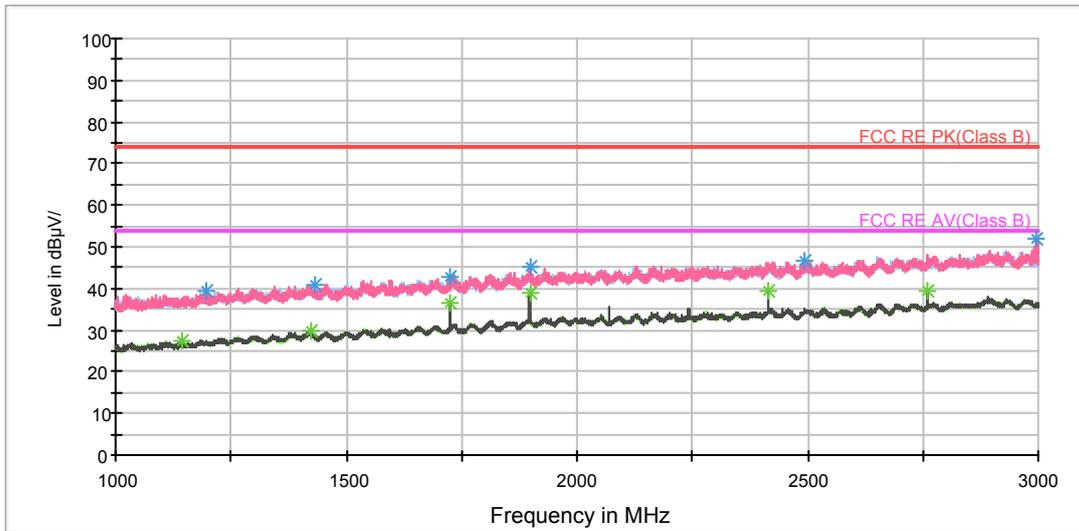

Radiated Emission from 1GHz to 3GHz

Frequency (MHz)	Peak (dBuV/m)	Reading value (dBuV/m)	Height (cm)	Polarization	Azimuth (deg)	Correct Factor (dB)	Margin (dB)	Limit (dBuV/m)
1195.500000	39.3	48.3	100.0	V	211.0	-9.0	34.7	74
1432.750000	41.1	48.6	100.0	V	195.0	-7.5	32.9	74
1725.000000	43.0	48.1	200.0	V	141.0	-5.1	31.0	74
1897.500000	45.0	48.6	100.0	V	95.0	-3.6	29.0	74
2495.000000	46.4	46.9	100.0	H	327.0	-0.5	27.6	74
2994.250000	52.0	50.6	100.0	V	32.0	1.4	22.0	74

Frequency (MHz)	Average (dBuV/m)	Reading value (dBuV/m)	Height (cm)	Polarization	Azimuth (deg)	Correct Factor (dB)	Margin (dB)	Limit (dBuV/m)
1144.500000	27.6	37.0	100.0	V	101.0	-9.4	26.4	54
1423.000000	29.8	37.3	100.0	H	213.0	-7.5	24.2	54
1725.000000	36.6	41.7	200.0	V	141.0	-5.1	17.4	54
1897.500000	38.8	42.4	200.0	V	261.0	-3.6	15.2	54
2415.000000	39.3	40.3	100.0	V	84.0	-1.0	14.7	54
2760.250000	39.5	39.4	100.0	V	90.0	0.1	14.5	54

RE 3-18GHz PK+AV

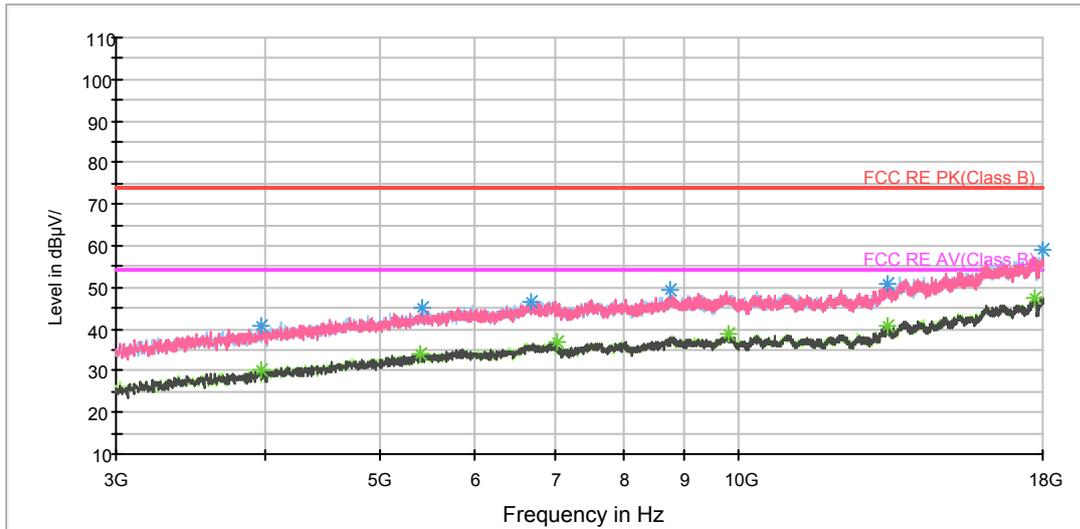

Radiated Emission from 3GHz to 18GHz

Frequency (MHz)	Peak (dBuV/m)	Reading value (dBuV/m)	Height (cm)	Polarization	Azimuth (deg)	Correct Factor (dB)	Margin (dB)	Limit (dBuV/m)
3965.625000	40.9	41.3	100.0	H	349.0	-0.4	33.1	74
5424.375000	45.1	42.5	100.0	V	276.0	2.6	28.9	74
6697.500000	46.7	41.4	100.0	H	216.0	5.3	27.3	74
8761.875000	49.4	42.3	200.0	H	57.0	7.1	24.6	74
13329.375000	50.8	39.5	100.0	H	338.0	11.3	23.2	74
17975.625000	59.0	40.0	200.0	H	101.0	19.0	15.0	74

Frequency (MHz)	Average (dBuV/m)	Reading value (dBuV/m)	Height (cm)	Polarization	Azimuth (deg)	Correct Factor (dB)	Margin (dB)	Limit (dBuV/m)
3967.500000	30.4	30.8	100.0	H	250.0	-0.4	23.6	54
5407.500000	33.9	31.3	100.0	H	185.0	2.6	20.1	54
7027.500000	36.9	31.4	200.0	H	188.0	5.5	17.1	54
9787.500000	39.0	31.2	200.0	H	68.0	7.8	15.0	54
13327.500000	41.0	29.7	100.0	H	316.0	11.3	13.0	54
17743.125000	47.6	29.0	200.0	V	188.0	18.6	6.4	54

3.2 Conducted Emission

Ambient condition

Temperature	Relative humidity	Pressure
24°C ~26°C	50%~55%	102.5kPa

Methods of Measurement

The EUT is placed on a non-metallic table of 80cm height above the horizontal metal reference ground plane. During the test, the EUT was operating in its typical mode. The test method is according to ANSI C63.4-2014. Connect the AC power line of the EUT to the L.I.S.N. Use EMI receiver to detect the average and Quasi-peak value. RBW is set to 9 kHz, VBW is set to 30kHz. The measurement result should include both L line and N line.

During the test, EUT is connected to a laptop via a USB cable in the case of Transfer Data mode. The EUT is used as the peripheral equipment of the PC. The data is transferred from EUT to PC; PC is connected to server via a long LAN cable.

Test Setup

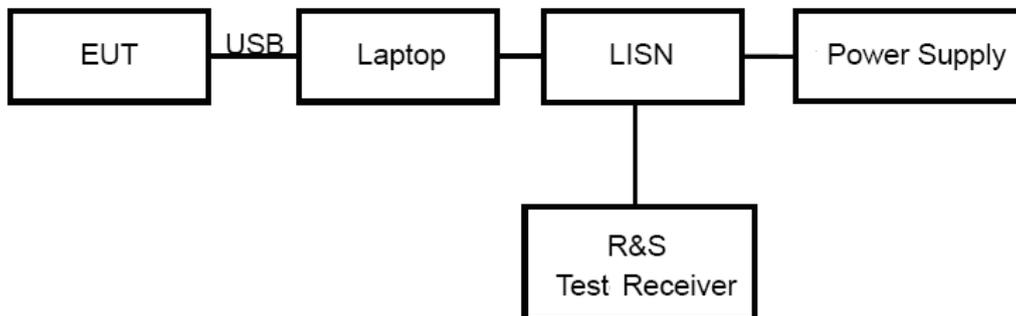

Note: Power Supply is AC Power source and it is used to change the voltage 120V/60Hz.

Limits

Frequency (MHz)	Conducted Limits(dBμV)	
	Quasi-peak	Average
0.15 - 0.5	66 to 56 *	56 to 46 *
0.5 - 5	56	46
5 - 30	60	50

*: Decreases with the logarithm of the frequency.

Measurement Uncertainty

The assessed measurement uncertainty to ensure 95% confidence level for the normal distribution is with the coverage factor $k = 1.96$. $U = 2.57$ dB.

Test Results

Following plots, Blue trace uses the peak detection; Green trace uses the average detection.

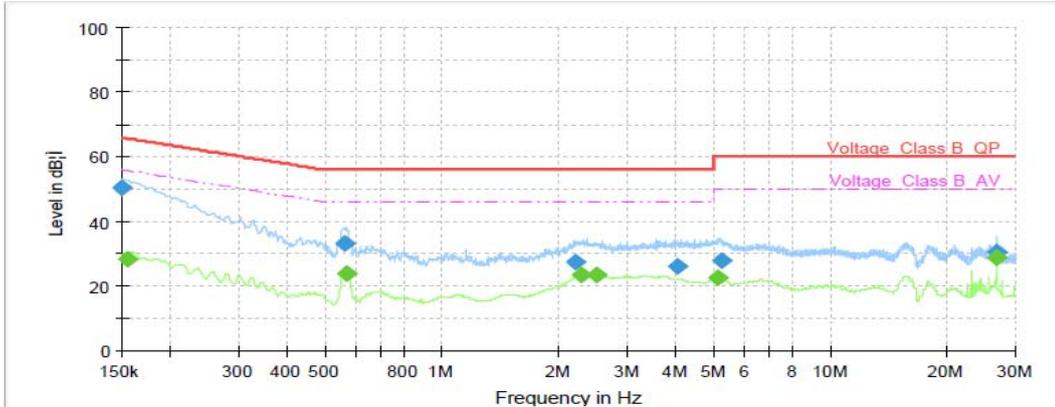

Frequency (MHz)	QuasiPeak (dB; i V)	Average (dB; i V)	Limit (dB; i V)	Margin (dB)	Meas. Time (ms)	Bandwidth (kHz)	Line	Filter	Corr. (dB)
0.150000	50.32	---	66.00	15.68	1000.0	9.000	L1	ON	19.1
0.154500	---	28.37	55.75	27.38	1000.0	9.000	L1	ON	19.1
0.564000	33.28	---	56.00	22.72	1000.0	9.000	L1	ON	19.3
0.568500	---	23.74	46.00	22.26	1000.0	9.000	L1	ON	19.3
2.220000	27.60	---	56.00	28.40	1000.0	9.000	L1	ON	19.1
2.292000	---	23.33	46.00	22.67	1000.0	9.000	L1	ON	19.0
2.503500	---	23.29	46.00	22.71	1000.0	9.000	L1	ON	19.0
4.047000	26.25	---	56.00	29.75	1000.0	9.000	L1	ON	19.1
5.142750	---	22.37	50.00	27.63	1000.0	9.000	L1	ON	19.1
5.223750	27.83	---	60.00	32.17	1000.0	9.000	L1	ON	19.1
26.623500	---	28.80	50.00	21.20	1000.0	9.000	L1	ON	20.0
26.623500	30.45	---	60.00	29.55	1000.0	9.000	L1	ON	20.0

L line

Conducted Emission from 150 KHz to 30 MHz

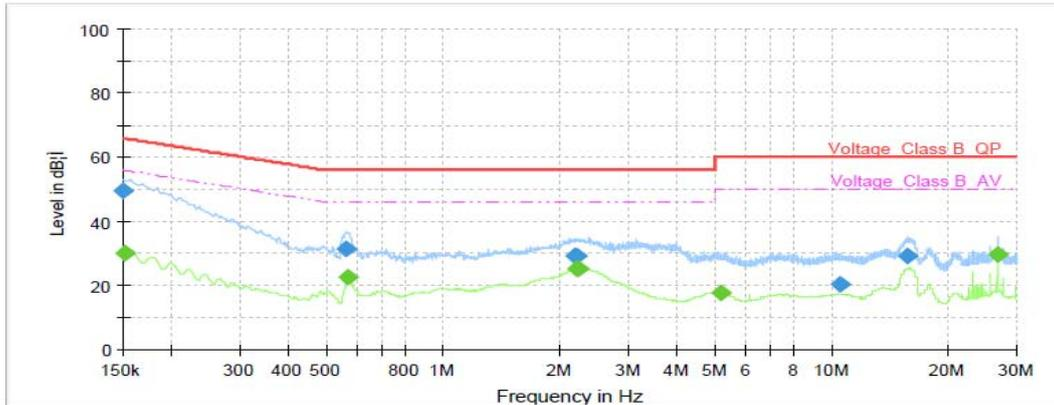

Frequency (MHz)	QuasiPeak (dB; i V)	Average (dB; i V)	Limit (dB; i V)	Margin (dB)	Meas. Time (ms)	Bandwidth (kHz)	Line	Filter	Corr. (dB)
0.150000	49.77	---	66.00	16.23	1000.0	9.000	N	ON	19.1
0.152250	---	30.06	55.88	25.81	1000.0	9.000	N	ON	19.1
0.564000	31.54	---	56.00	24.46	1000.0	9.000	N	ON	19.3
0.568500	---	22.58	46.00	23.42	1000.0	9.000	N	ON	19.3
2.181748	29.11	---	56.00	26.89	1000.0	9.000	N	ON	19.1
2.199746	29.27	---	56.00	26.73	1000.0	9.000	N	ON	19.1
2.206493	---	25.17	46.00	20.83	1000.0	9.000	N	ON	19.1
2.224496	---	25.25	46.00	20.75	1000.0	9.000	N	ON	19.1
5.189990	---	17.87	50.00	32.13	1000.0	9.000	N	ON	19.1
10.468483	20.33	---	60.00	39.67	1000.0	9.000	N	ON	19.4
15.690750	29.36	---	60.00	30.64	1000.0	9.000	N	ON	19.4
26.625016	---	29.66	50.00	20.34	1000.0	9.000	N	ON	19.8

N line

Conducted Emission from 150 KHz to 30 MHz

4 Main Test Instrument

Name	Manufacturer	Type	Serial Number	Last Cal.	Cal. Due Date
Signal Analyzer	R&S	FSV30	100815	2017-12-17	2018-12-16
EMI Test Receiver	R&S	ESCI	100948	2018-05-20	2019-05-19
Trilog Antenna	SCHWARZBECK	VULB 9163	9163-201	2017-11-18	2019-11-17
Horn Antenna	R&S	HF907	100126	2018-07-07	2020-07-06
Horn Antenna	ETS-Lindgren	3160-09	00102643	2018-06-20	2019-06-19
EMI Test Receiver	R&S	ESR	101667	2018-05-20	2019-05-19
LISN	R&S	ENV216	101171	2016-12-16	2019-12-15
Bore Sight Antenna mast	ETS	2171B	00058752	/	/
Test software	EMC32	R&S	9.26.0	/	/

*****END OF REPORT *****