



FCC RF Test Report

APPLICANT : ZTE CORPORATION
EQUIPMENT : WCDMA/LTE Multi-mode Digital Mobile Phone
BRAND NAME : ZTE
MODEL NAME : Z916BL
FCC ID : SRQ-Z916BL
STANDARD : FCC 47 CFR Part 2, 22(H), 24(E), 27(L)
CLASSIFICATION : PCS Licensed Transmitter Held to Ear (PCE)

The product was received on Apr. 01, 2016 and testing was completed on Apr. 21, 2016. We, SPORTON INTERNATIONAL (KUNSHAN) INC., would like to declare that the tested sample has been evaluated in accordance with the test procedures given in ANSI / TIA / EIA-603-D-2010 and has been in compliance with the applicable technical standards.

The test results in this report apply exclusively to the tested model / sample. Without written approval of SPORTON INTERNATIONAL (KUNSHAN) INC., the test report shall not be reproduced except in full.

Prepared by: James Huang / Manager

Approved by: Jones Tsai / Manager



SPORTON INTERNATIONAL (KUNSHAN) INC.
No. 3-2, PingXiang Road, Kunshan, Jiangsu Province, P. R. China



TABLE OF CONTENTS

- 1 GENERAL DESCRIPTION6**
 - 1.1 Applicant.....6
 - 1.2 Manufacturer6
 - 1.3 Product Feature of Equipment Under Test6
 - 1.4 Product Specification of Equipment Under Test7
 - 1.5 Modification of EUT7
 - 1.6 Maximum ERP/EIRP Power, Frequency Tolerance, and Emission Designator8
 - 1.7 Testing Location8
 - 1.8 Applicable Standards8
- 2 TEST CONFIGURATION OF EQUIPMENT UNDER TEST9**
 - 2.1 Test Mode.....9
 - 2.2 Connection Diagram of Test System10
 - 2.3 Support Unit used in test configuration11
 - 2.4 Measurement Results Explanation Example11
- 3 CONDUCTED TEST RESULT12**
 - 3.1 Measuring Instruments.....12
 - 3.2 Test Setup12
 - 3.3 Test Result of Conducted Test.....12
 - 3.4 Conducted Output Power13
 - 3.5 Peak-to-Average Ratio13
 - 3.6 99% Occupied Bandwidth and 26dB Bandwidth Measurement.....14
 - 3.7 Conducted Band Edge15
 - 3.8 Conducted Spurious Emission16
 - 3.9 Frequency Stability.....17
- 4 RADIATED TEST ITEMS18**
 - 4.1 Measuring Instruments.....18
 - 4.2 Test Setup18
 - 4.3 Test Result of Radiated Test.....18
 - 4.4 Effective Radiated Power and Effective Isotropic Radiated Power Measurement19
 - 4.5 Field Strength of Spurious Radiation Measurement21
- 5 LIST OF MEASURING EQUIPMENT22**
- 6 UNCERTAINTY OF EVALUATION23**

APPENDIX A. TEST RESULTS OF CONDUCTED TEST

APPENDIX B. TEST RESULTS OF RADIATED TEST

APPENDIX C. TEST SETUP PHOTOGRAPHS



SUMMARY OF TEST RESULT

Report Section	FCC Rule	Description	Limit	Result	Remark
3.4	§2.1046	Conducted Output Power	Reporting Only	PASS	-
3.5	§24.232(d)	Peak-to-Average Ratio	< 13 dB	PASS	-
3.6	§2.1049 §22.917(b) §24.238(b) §27.53(g)	Occupied Bandwidth	Reporting Only	PASS	-
3.7	§2.1051 §22.917(a) §24.238(a) §27.53(h)	Band Edge Measurement	< 43+10log10(P[Watts])	PASS	-
3.8	§2.1051 §22.917(a) §24.238(a) §27.53(h)	Conducted Emission	< 43+10log10(P[Watts])	PASS	-
3.9	§2.1055 §22.355	Frequency Stability for Temperature & Voltage	< 2.5 ppm for Part 22H	PASS	-
	§2.1055 §24.235 §27.54		Within Authorized Band		



Report Section	FCC Rule	Description	Limit	Result	Remark
4.4	§22.913(a)(2)	Effective Radiated Power	< 7 Watts	PASS	-
	§24.232(c)	Equivalent Isotropic Radiated Power	< 2 Watts	PASS	-
	§27.50(d)(4)	Equivalent Isotropic Radiated Power	< 1 Watts	PASS	-
4.5	§2.1053 §22.917(a) §24.238(a) §27.53(h)	Field Strength of Spurious Radiation	< 43+10log10(P[Watts])	PASS	Under limit 30.27 dB at 2510.000 MHz



1 General Description

1.1 Applicant

ZTE CORPORATION

ZTE Plaza, Keji Road South, Hi-Tech Industrial Park, Nanshan District, Shenzhen, Guangdong, 518057, P.R.China

1.2 Manufacturer

ZTE CORPORATION

ZTE Plaza, Keji Road South, Hi-Tech Industrial Park, Nanshan District, Shenzhen, Guangdong, 518057, P.R.China

1.3 Product Feature of Equipment Under Test

Product Feature	
Equipment	WCDMA/LTE Multi-mode Digital Mobile Phone
Brand Name	ZTE
Model Name	Z916BL
FCC ID	SRQ-Z916BL
EUT supports Radios application	GSM/GPRS/EGPRS/WCDMA/HSPA/HSPA+(16QAM uplink is not supported)/LTE/ WLAN2.4GHz 802.11b/g/n HT20/ Bluetooth v2.1+EDR/Bluetooth v4.1 LE
IMEI Code	Conducted:860747030005289 Radiation:860747030005024 ERP/EIRP: 860747030005024
HW Version	Z916BLHVV1.0
SW Version	Z916BLV1.0.0B06
EUT Stage	Identical Prototype

Remark: The above EUT's information was declared by manufacturer. Please refer to the specifications or user's manual for more detailed description.



1.4 Product Specification of Equipment Under Test

Standards-related Product Specification	
Tx Frequency	GSM/GPRS/EDGE: 850: 824.2 MHz ~ 848.8 MHz 1900: 1850.2 MHz ~ 1909.8MHz WCDMA: Band V: 826.4 MHz ~ 846.6 MHz Band II: 1852.4 MHz ~ 1907.6 MHz Band IV: 1712.4 MHz ~ 1752.6 MHz
Rx Frequency	GSM/GPRS/EDGE: 850: 869.2 MHz ~ 893.8 MHz 1900: 1930.2 MHz ~ 1989.8 MHz WCDMA: Band V: 871.4 MHz ~ 891.6 MHz Band II: 1932.4 MHz ~ 1987.6 MHz Band IV: 2112.4 MHz ~ 2152.6 MHz
Maximum Output Power to Antenna	GSM/GPRS/EDGE: 850: 32.81 dBm 1900: 29.63 dBm WCDMA: Band V: 23.45 dBm Band II: 23.55 dBm Band IV: 23.51 dBm
Antenna Type	PIFA Antenna
Type of Modulation	GSM: GMSK GPRS: GMSK EDGE: GMSK / 8PSK WCDMA: QPSK (Uplink) HSDPA: QPSK (Uplink) HSUPA: QPSK (Uplink) HSPA+: 16QAM (Uplink is not supported)

1.5 Modification of EUT

No modifications are made to the EUT during all test items.

1.6 Maximum ERP/EIRP Power, Frequency Tolerance, and Emission Designator

FCC Rule	System	Type of Modulation	Maximum ERP/EIRP (W)	Frequency Tolerance (ppm)	Emission Designator
Part 22H	GSM850 GSM	GMSK	0.5188	0.0191 ppm	242KGXW
Part 22H	GSM850 EDGE class 8	8PSK	0.1294	0.0096 ppm	249KG7W
Part 22H	WCDMA Band V RMC 12.2Kbps	QPSK	0.0675	0.0167 ppm	4M14F9W
Part 24E	GSM1900 GSM	GMSK	1.1455	0.0144 ppm	245KGXW
Part 24E	GSM1900 EDGE class 8	8PSK	0.4613	0.0186 ppm	246KG7W
Part 24E	WCDMA Band II RMC 12.2Kbps	QPSK	0.3396	0.0064 ppm	4M16F9W
Part 27L	WCDMA Band IV RMC 12.2Kbps	QPSK	0.1687	0.0110 ppm	4M16F9W

1.7 Testing Location

Test Site	SPORTON INTERNATIONAL (KUNSHAN) INC.		
Test Site Location	No. 3-2, PingXiang Road, Kunshan, Jiangsu Province, P. R. China TEL: +86-0512-5790-0158 FAX: +86-0512-5790-0958		
Test Site No.	Sporton Site No.		FCC Registration No.
	TH01-KS	03CH02-KS	418269

1.8 Applicable Standards

According to the specifications of the manufacturer, the EUT must comply with the requirements of the following standards:

- 47 CFR Part 2, 22(H), 24(E), 27(L)
- ANSI / TIA / EIA-603-D-2010
- FCC KDB 971168 D01 Power Meas. License Digital Systems v02r02

Remark:

1. All test items were verified and recorded according to the standards and without any deviation during the test.
2. This EUT has also been tested and complied with the requirements of FCC Part 15, Subpart B, recorded in a separate test report.



2 Test Configuration of Equipment Under Test

2.1 Test Mode

Antenna port conducted and radiated test items were performed according to KDB 971168 D01 Power Meas. License Digital Systems v02r02 with maximum output power.

Radiated measurements were performed with rotating EUT in different three orthogonal test planes to find the maximum emission.

Radiated emissions were investigated as following frequency range:

1. 30 MHz to 10th harmonic for GSM850 and WCDMA Band V.
2. 30 MHz to 10th harmonic for WCDMA Band IV.
3. 30 MHz to 10th harmonic for GSM1900 and WCDMA Band II.

All modes and data rates and positions were investigated.

Test modes are chosen to be reported as the worst case configuration below:

Test Modes		
Band	Radiated TCs	Conducted TCs
GSM 850	<ul style="list-style-type: none"> ■ GSM Link ■ EDGE class 8 Link 	<ul style="list-style-type: none"> ■ GSM Link ■ EDGE class 8 Link
GSM 1900	<ul style="list-style-type: none"> ■ GSM Link ■ EDGE class 8 Link 	<ul style="list-style-type: none"> ■ GSM Link ■ EDGE class 8 Link
WCDMA Band V	<ul style="list-style-type: none"> ■ RMC 12.2Kbps Link 	<ul style="list-style-type: none"> ■ RMC 12.2Kbps Link
WCDMA Band II	<ul style="list-style-type: none"> ■ RMC 12.2Kbps Link 	<ul style="list-style-type: none"> ■ RMC 12.2Kbps Link
WCDMA Band IV	<ul style="list-style-type: none"> ■ RMC 12.2Kbps Link 	<ul style="list-style-type: none"> ■ RMC 12.2Kbps Link

2.2 Connection Diagram of Test System

22(H)

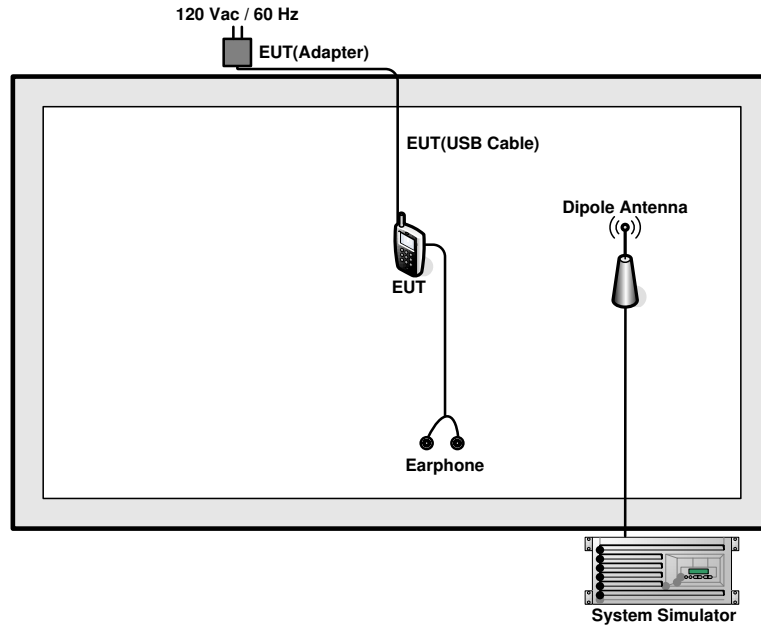

24(E), 27(L)

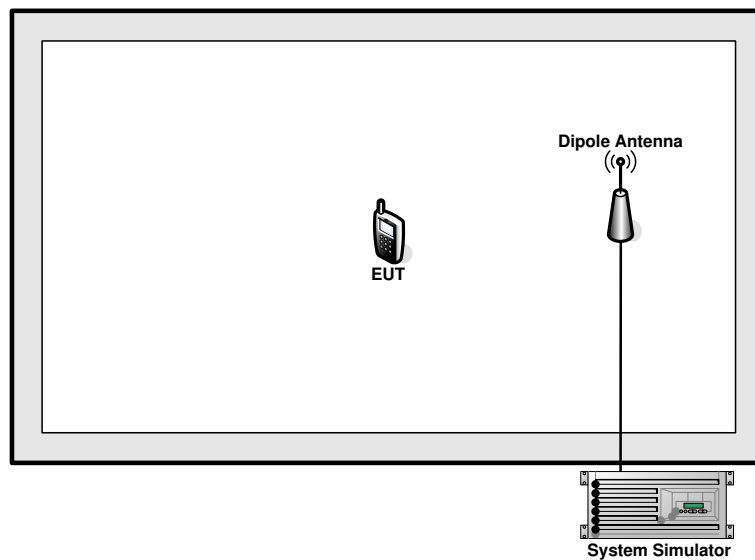



2.3 Support Unit used in test configuration

Item	Equipment	Trade Name	Model No.	FCC ID	Data Cable	Power Cord
1.	System Simulator	R&S	CMU 200	N/A	N/A	Unshielded, 1.8 m
2.	DC Power Supply	GW INSTEK	GPS-3030D	N/A	N/A	Unshielded, 1.8 m
3.	Earphone	Lenovo	SH100	N/A	Unshielded, 1.2 m	N/A

2.4 Measurement Results Explanation Example

For all conducted test items:

The offset level is set in the spectrum analyzer to compensate the RF cable loss and attenuator factor between RF conducted output port and spectrum analyzer. With the offset compensation, the spectrum analyzer reading level will be exactly the RF output level.

The spectrum analyzer offset is derived from RF cable loss and attenuator factor.

$$\text{Offset} = \text{RF cable loss} + \text{attenuator factor}.$$

The following shows an offset computation example with RF cable loss 4.3 dB and a 10dB attenuator.

Example :

$$\begin{aligned} \text{Offset(dB)} &= \text{RF cable loss(dB)} + \text{attenuator factor(dB)}. \\ &= 4.3 + 10 = 14.3 \text{ (dB)} \end{aligned}$$

3 Conducted Test Result

3.1 Measuring Instruments

See list of measuring instruments of this test report.

3.2 Test Setup

3.2.1 Conducted Output Power

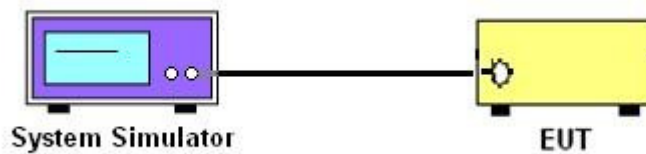

3.2.2 Peak-to-Average Ratio, Occupied Bandwidth, Conducted Band-Edge and Conducted Spurious Emission

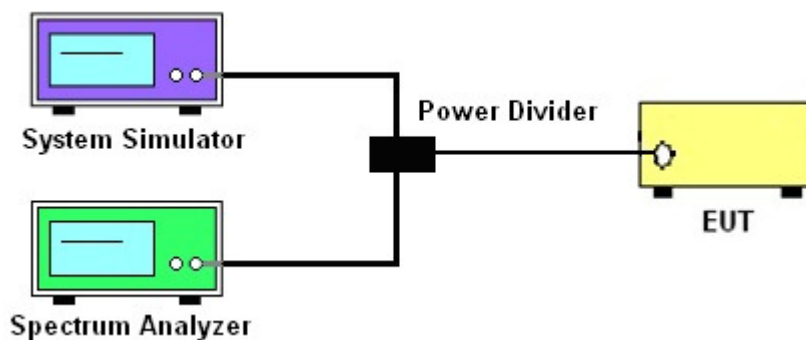

3.2.3 Frequency Stability

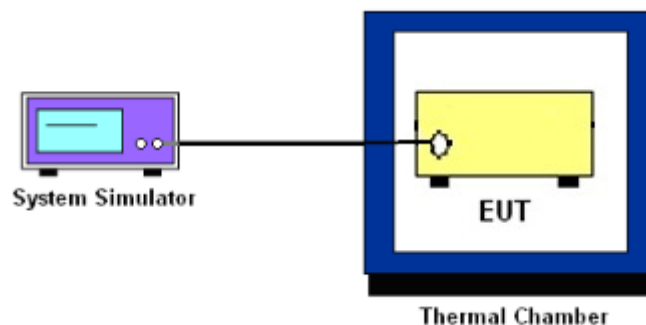

3.3 Test Result of Conducted Test

Please refer to Appendix A.



3.4 Conducted Output Power

3.4.1 Description of the Conducted Output Power

A system simulator was used to establish communication with the EUT. Its parameters were set to enforce EUT transmitting at the maximum power. The measured power in the radio frequency on the transmitter output terminals shall be reported.

3.4.2 Test Procedures

1. The transmitter output port was connected to the system simulator.
2. Set EUT at maximum power through system simulator.
3. Select lowest, middle, and highest channels for each band and different modulation.
4. Measure the maximum burst average power for GSM and maximum average power for other modulation signal.

3.5 Peak-to-Average Ratio

3.5.1 Description of the PAR Measurement

The peak-to-average ratio (PAR) of the transmission may not exceed 13 dB.

3.5.2 Test Procedures

1. The testing follows FCC KDB 971168 D01 v02r02 Section 5.7.1.
2. The EUT was connected to spectrum analyzer and system simulator via a power divider.
3. Set EUT to transmit at maximum output power.
4. When the duty cycle is less than 98%, then signal gating will be implemented on the spectrum analyzer by triggering from the system simulator.
5. Set the CCDF (Complementary Cumulative Distribution Function) option of the spectrum analyzer.
Record the maximum PAPR level associated with a probability of 0.1%.



3.6 99% Occupied Bandwidth and 26dB Bandwidth Measurement

3.6.1 Description of 99% Occupied Bandwidth and 26dB Bandwidth Measurement

The occupied bandwidth is the width of a frequency band such that, below the lower and above the upper frequency limits, the mean powers emitted are each equal to a specified percentage 0.5% of the total mean transmitted power.

The 26 dB emission bandwidth is defined as the frequency range between two points, one above and one below the carrier frequency, at which the spectral density of the emission is attenuated 26 dB below the maximum in-band spectral density of the modulated signal. Spectral density (power per unit bandwidth) is to be measured with a detector of resolution bandwidth equal to approximately 1.0% of the emission bandwidth.

3.6.2 Test Procedures

1. The testing follows FCC KDB 971168 v02r02 Section 4.2.
2. The EUT was connected to spectrum analyzer and system simulator via a power divider.
3. The spectrum analyzer center frequency is set to the nominal EUT channel center frequency. The span range for the spectrum analyzer shall be between two and five times the anticipated OBW.
4. The nominal resolution bandwidth (RBW) shall be in the range of 1 to 5 % of the anticipated OBW, and the VBW shall be at least 3 times the RBW.
5. Set the detection mode to peak, and the trace mode to max hold.
6. Determine the reference value: Set the EUT to transmit a modulated signal. Allow the trace to stabilize. Set the spectrum analyzer marker to the highest level of the displayed trace.
(this is the reference value)
7. Determine the “-26 dB down amplitude” as equal to (Reference Value – X).
8. Place two markers, one at the lowest and the other at the highest frequency of the envelope of the spectral display such that each marker is at or slightly below the “-X dB down amplitude” determined in step 6. If a marker is below this “-X dB down amplitude” value it shall be placed as close as possible to this value. The OBW is the positive frequency difference between the two markers.
9. Use the 99 % power bandwidth function of the spectrum analyzer and report the measured bandwidth.



3.7 Conducted Band Edge

3.7.1 Description of Conducted Band Edge Measurement

The power of any emission outside of the authorized operating frequency ranges must be lower than the transmitter power (P) by a factor of at least $43 + 10 \log (P)$ dB.

3.7.2 Test Procedures

1. The testing follows FCC KDB 971168 D01 v02r02 Section 6.0.
2. The EUT was connected to the spectrum analyzer and system simulator via a power divider.
3. The RF output of EUT was connected to the spectrum analyzer by an RF cable and attenuator. The path loss was compensated to the results for each measurement.
4. The band edges of low and high channels for the highest RF powers were measured.
5. The RF fundamental frequency should be excluded against the limit line in the operating frequency band.
6. The limit line is derived from $43 + 10\log(P)$ dB below the transmitter power P(Watts)
= $P(W) - [43 + 10\log(P)]$ (dB)
= $[30 + 10\log(P)]$ (dBm) - $[43 + 10\log(P)]$ (dB)
= -13dBm.



3.8 Conducted Spurious Emission

3.8.1 Description of Conducted Spurious Emission Measurement

The power of any emission outside of the authorized operating frequency ranges must be lower than the transmitter power (P) by a factor of at least $43 + 10 \log (P)$ dB.

It is measured by means of a calibrated spectrum analyzer and scanned from 30 MHz up to a frequency including its 10th harmonic.

3.8.2 Test Procedures

1. The testing follows FCC KDB 971168 D01 v02r02 Section 6.0.
2. The EUT was connected to the spectrum analyzer and system simulator via a power divider.
3. The RF output of EUT was connected to the spectrum analyzer by an RF cable and attenuator. The path loss was compensated to the results for each measurement.
4. The middle channel for the highest RF power within the transmitting frequency was measured.
5. The conducted spurious emission for the whole frequency range was taken.
6. The RF fundamental frequency should be excluded against the limit line in the operating frequency band.
7. The limit line is derived from $43 + 10\log(P)$ dB below the transmitter power P(Watts)
= $P(W) - [43 + 10\log(P)]$ (dB)
= $[30 + 10\log(P)]$ (dBm) - $[43 + 10\log(P)]$ (dB)
= -13dBm.



3.9 Frequency Stability

3.9.1 Description of Frequency Stability Measurement

The frequency stability shall be measured by variation of ambient temperature and variation of primary supply voltage to ensure that the fundamental emission stays within the authorized frequency block. The frequency stability of the transmitter shall be maintained within $\pm 0.00025\%$ ($\pm 2.5\text{ppm}$) of the center frequency.

3.9.2 Test Procedures for Temperature Variation

1. The testing follows FCC KDB 971168 D01 v02r02 Section 9.0.
2. The EUT was set up in the thermal chamber and connected with the system simulator.
3. With power OFF, the temperature was decreased to -30°C and the EUT was stabilized before testing. Power was applied and the maximum change in frequency was recorded within one minute.
4. With power OFF, the temperature was raised in 10°C steps up to 50°C . The EUT was stabilized at each step for at least half an hour. Power was applied and the maximum frequency change was recorded within one minute.

3.9.3 Test Procedures for Voltage Variation

1. The testing follows FCC KDB 971168 D01 v02r02 Section 9.0.
2. The EUT was placed in a temperature chamber at $25\pm 5^{\circ}\text{C}$ and connected with the system simulator.
3. The power supply voltage to the EUT was varied from 85% to 115% of the nominal value measured at the input to the EUT.
4. The variation in frequency was measured for the worst case.

4 Radiated Test Items

4.1 Measuring Instruments

See list of measuring instruments of this test report.

4.2 Test Setup

4.2.1 For radiated test from 30MHz to 1GHz

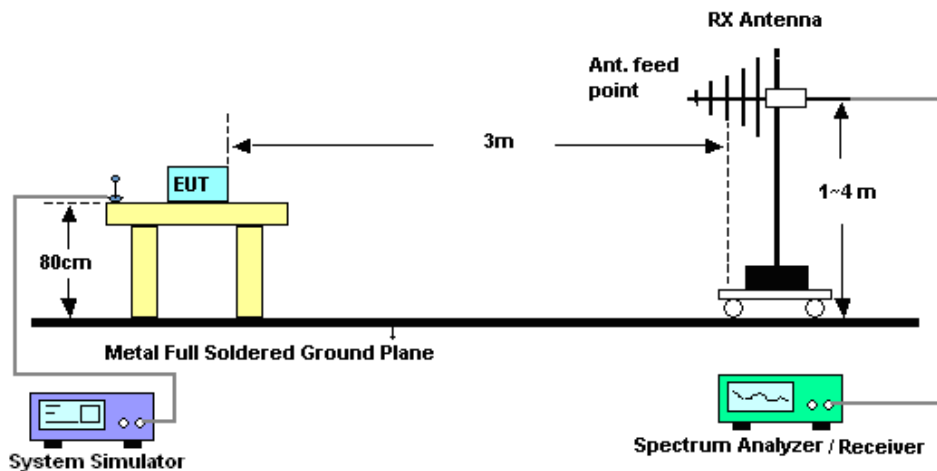

4.2.2 For radiated test above 1GHz

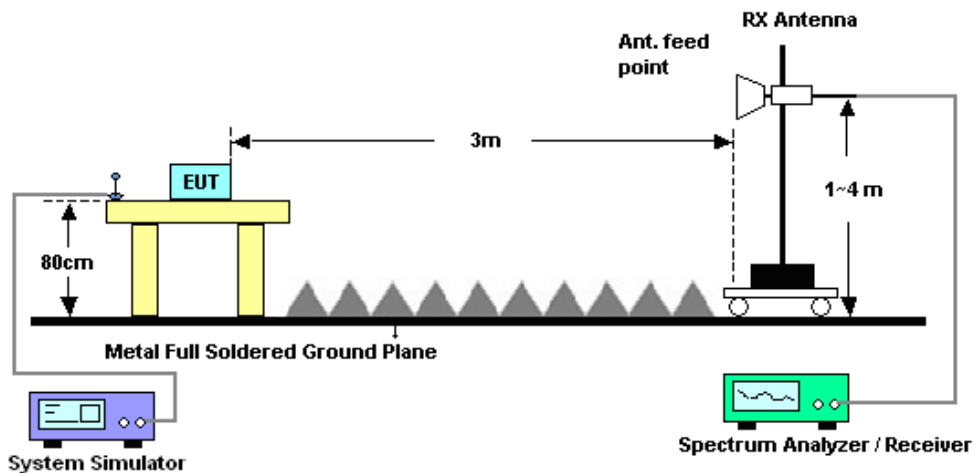

4.3 Test Result of Radiated Test

Please refer to Appendix B.



4.4 Effective Radiated Power and Effective Isotropic Radiated Power Measurement

4.4.1 Description of the ERP/EIRP Measurement

The substitution method, in ANSI / TIA / EIA-603-D-2010, was used for ERP/EIRP measurement, and the spectrum analyzer configuration follows KDB 971168 D01 Power Meas. License Digital Systems v02r02. The ERP of mobile transmitters must not exceed 7 Watts (Cellular Band) and the EIRP of mobile transmitters are limited to 2 Watts (PCS Band) and 1 Watts (AWS Band).

4.4.2 Test Procedures

1. The testing follows FCC KDB 971168 D01 v02r02 Section 5.2.1. (for CDMA/WCDMA), Section 5.2.2.2 (for GSM/GPRS/EDGE) and ANSI / TIA-603-D-2010 Section 2.2.17.
2. The EUT was placed on a non-conductive rotating platform 0.8 meters high in a semi-anechoic chamber. The radiated emission at the fundamental frequency was measured at 3 m with a test antenna and a spectrum analyzer with RMS detector per section 5. of KDB 971168 D01.
3. During the measurement, the system simulator parameters were set to force the EUT transmitting at maximum output power. The maximum emission was recorded from analyzer power level (LVL) from the 360 degrees rotation of the turntable and the test antenna raised and lowered over a range from 1 to 4 meters in both horizontally and vertically polarized orientations.
4. Effective Isotropic Radiated Power (EIRP) was measured by substitution method according to TIA/EIA-603-D. The EUT was replaced by the substitution antenna at same location, and then a known power from S.G. was applied into the dipole antenna through a Tx cable, and then recorded the maximum Analyzer reading through raised and lowered the test antenna. The correction factor (in dB) = S.G. - Tx Cable loss + Substitution antenna gain - Analyzer reading. Then the EUT's EIRP was calculated with the correction factor, $EIRP = LVL + \text{Correction factor}$ and $ERP = EIRP - 2.15$. Take the record of the output power at substitution antenna.



	GSM/GPRS/EDGE	WCDMA/HSPA
SPAN	500kHz	10MHz
RBW	10kHz	100kHz
VBW	30kHz	300kHz
Detector	RMS	RMS
Trace	Average	Average
Average Type	Power	Power
Sweep Count	100	100



4.5 Field Strength of Spurious Radiation Measurement

4.5.1 Description of Field Strength of Spurious Radiated Measurement

The power of any emission outside of the authorized operating frequency ranges must be attenuated below the transmitter power (P) by a factor of at least $43 + 10 \log (P)$ dB. The spectrum is scanned from 30 MHz up to a frequency including its 10th harmonic.

4.5.2 Test Procedures

1. The testing follows FCC KDB 971168 D01 v02r02 Section 5.8 and ANSI / TIA-603-D-2010 Section 2.2.12.
2. The EUT was placed on a rotatable wooden table 0.8 meters above the ground.
3. The EUT was set 3 meters from the receiving antenna, which was mounted on the antenna tower.
4. The table was rotated 360 degrees to determine the position of the highest spurious emission.
5. The height of the receiving antenna is varied between one meter and four meters to search for the maximum spurious emission for both horizontal and vertical polarizations.
6. Make the measurement with the spectrum analyzer's RBW = 1MHz, VBW = 3MHz, taking record of maximum spurious emission.
7. A horn antenna was substituted in place of the EUT and was driven by a signal generator.
8. Tune the output power of signal generator to the same emission level with EUT maximum spurious emission.
9. Taking the record of output power at antenna port.
10. Repeat step 7 to step 8 for another polarization.
11. $EIRP \text{ (dBm)} = S.G. \text{ Power} - Tx \text{ Cable Loss} + Tx \text{ Antenna Gain}$
12. $ERP \text{ (dBm)} = EIRP - 2.15$
13. The RF fundamental frequency should be excluded against the limit line in the operating frequency band.
14. The limit line is derived from $43 + 10\log(P)$ dB below the transmitter power P(Watts)
= $P(W) - [43 + 10\log(P)] \text{ (dB)}$
= $[30 + 10\log(P)] \text{ (dBm)} - [43 + 10\log(P)] \text{ (dB)}$
= -13dBm.



5 List of Measuring Equipment

Instrument	Manufacturer	Model No.	Serial No.	Characteristics	Calibration Date	Test Date	Due Date	Remark
Spectrum Analyzer	R&S	FSV40	101040	10Hz~40GHz	Sep. 10, 2015	Apr. 15, 2016~ Apr. 16, 2016	Sep. 09, 2016	Conducted (TH01-KS)
Thermal Chamber	Ten Billion	TTC-B3S	TBN-960502	-40~+150°C	Oct. 24, 2015	Apr. 15, 2016~ Apr. 16, 2016	Oct. 23, 2016	Conducted (TH01-KS)
Spectrum Analyzer	R&S	FSV40	101040	10kHz~40GHz;Ma x 30dBm	Sep. 10, 2015	Apr. 20, 2016~ Apr. 21, 2016	Sep. 09, 2016	Radiation (03CH02-KS)
Bilog Antenna	TeseQ	CBL6112D	23182	25MHz-2GHz	Mar. 12, 2016	Apr. 20, 2016~ Apr. 21, 2016	Mar. 11, 2017	Radiation (03CH02-KS)
Double Ridge Horn Antenna	ETS-Lindgren	3117	75957	1GHz~18GHz	Nov. 07, 2015	Apr. 20, 2016~ Apr. 21, 2016	Nov. 06, 2016	Radiation (03CH02-KS)
SHF-EHF Horn	com-power	AH-840	101070	18GHz~40Ghz	Oct. 10, 2015	Apr. 20, 2016~ Apr. 21, 2016	Oct. 09, 2016	Radiation (03CH02-KS)
Amplifier	com-power	PA-103A	161069	1kHz~1000MHz / 32 dB	May 04, 2015	Apr. 20, 2016~ Apr. 21, 2016	May 03, 2016	Radiation (03CH02-KS)
Amplifier	Agilent	8449B	3008A02384	1-26.5GHz Gain 30dB	Oct. 24, 2015	Apr. 20, 2016~ Apr. 21, 2016	Oct. 23, 2016	Radiation (03CH02-KS)
AC Power Source	Chroma	61601	61601000247 3	N/A	NCR	Apr. 20, 2016~ Apr. 21, 2016	NCR	Radiation (03CH02-KS)
Turn Table	MF	MF7802	N/A	0~360 degree	NCR	Apr. 20, 2016~ Apr. 21, 2016	NCR	Radiation (03CH02-KS)
Antenna Mast	MF	MF7802	N/A	1 m~4 m	NCR	Apr. 20, 2016~ Apr. 21, 2016	NCR	Radiation (03CH02-KS)

NCR: No Calibration Required



6 Uncertainty of Evaluation

Uncertainty of Radiated Emission Measurement (30 MHz ~ 1000 MHz)

Measuring Uncertainty for a Level of Confidence of 95% ($U = 2Uc(y)$)	5.1 dB
---	--------



Appendix A. Test Results of Conducted Test

Conducted Output Power(Average power)

Conducted Power (*Unit: dBm)						
Band	GSM850			GSM1900		
Channel	128	189	251	512	661	810
Frequency	824.2	836.4	848.8	1850.2	1880.0	1909.8
GSM	32.45	32.56	32.81	29.25	29.53	29.63
GPRS class 8	32.43	32.51	32.75	29.22	29.45	29.60
GPRS class 10	31.27	31.32	31.50	27.88	27.76	27.90
EGPRS class 8	26.14	26.10	26.21	24.81	24.84	25.08
EGPRS class 10	26.00	25.94	26.04	23.20	23.22	23.41

Conducted Power (*Unit: dBm)									
Band	WCDMA Band V			WCDMA Band II			WCDMA Band IV		
Channel	4132	4182	4233	9262	9400	9538	1312	1413	1513
Frequency	826.4	836.4	846.6	1852.4	1880	1907.6	1712.4	1732.6	1752.6
AMR 12.2Kbps	23.35	23.38	23.44	23.31	23.40	23.54	23.25	23.34	23.50
RMC 12.2Kbps	23.36	23.39	23.45	23.34	23.43	23.55	23.36	23.35	23.51
HSDPA Subtest-1	22.35	22.37	22.45	22.42	22.50	22.67	22.36	22.35	22.58
HSDPA Subtest-2	22.28	22.30	22.37	22.40	22.49	22.66	22.35	22.34	22.51
HSDPA Subtest-3	21.95	22.00	22.03	21.92	22.00	22.15	21.93	21.92	21.87
HSDPA Subtest-4	21.90	21.98	22.01	21.89	21.98	22.07	21.95	21.93	21.89
HSUPA Subtest-1	21.80	21.81	21.87	21.56	21.65	21.76	21.65	21.63	21.58
HSUPA Subtest-2	21.30	21.35	21.40	21.35	21.40	21.50	21.03	21.02	21.08
HSUPA Subtest-3	20.75	20.80	20.89	21.00	21.06	21.14	21.16	21.13	21.24
HSUPA Subtest-4	21.48	21.50	21.55	21.80	21.86	21.93	21.48	21.45	21.58
HSUPA Subtest-5	21.02	21.05	21.08	21.50	21.56	21.63	21.38	21.36	21.45



A1. GSM

Peak-to-Average Ratio

Mode	GSM850		Limit: 13dB
Mod.	GSM	EDGE class 8	Result
Lowest CH	0.17	3.16	PASS
Middle CH	0.14	3.57	
Highest CH	0.17	3.36	

Mode	GSM1900		Limit: 13dB
Mod.	GSM	EDGE class 8	Result
Lowest CH	0.20	3.28	PASS
Middle CH	0.14	3.30	
Highest CH	0.20	3.39	

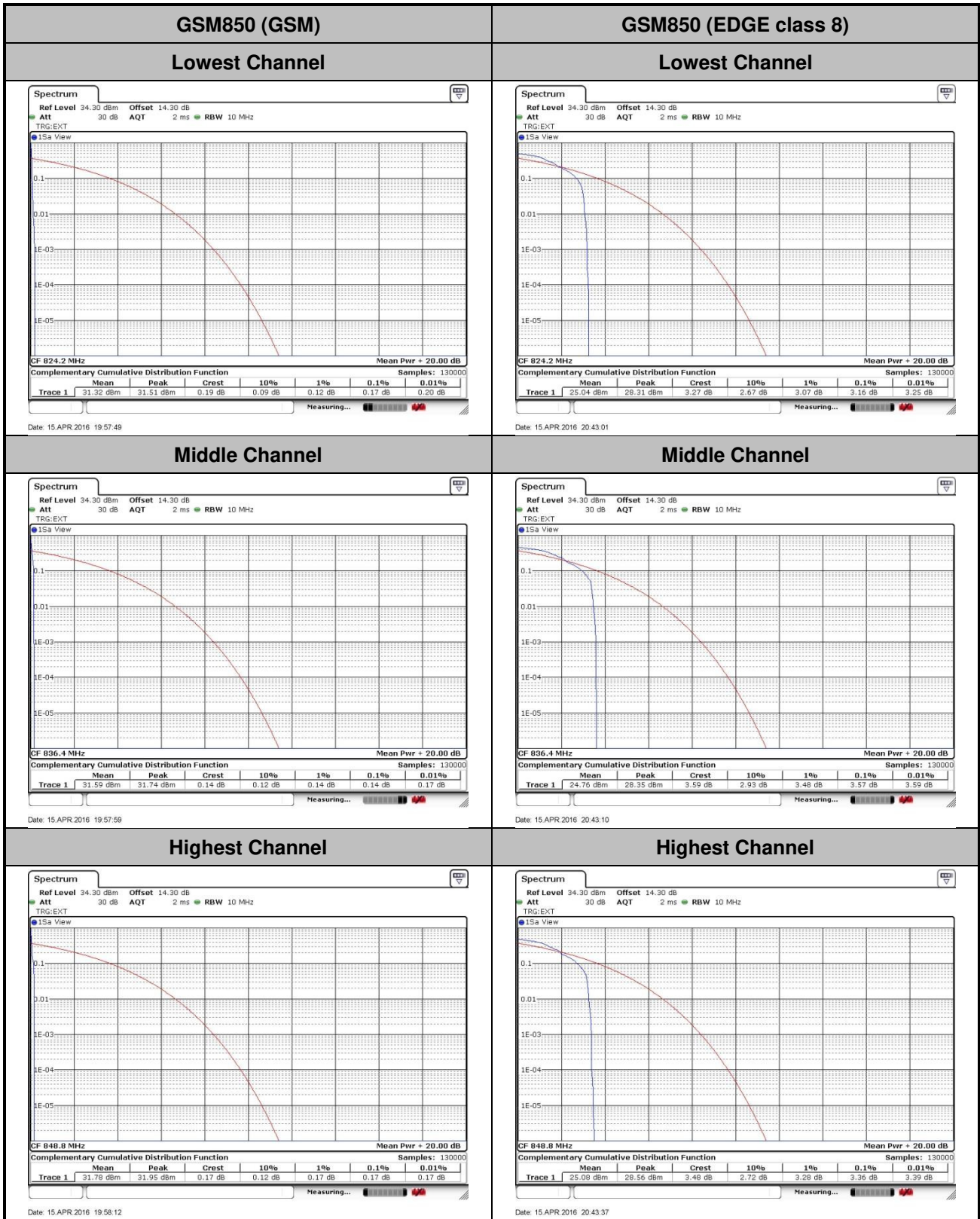

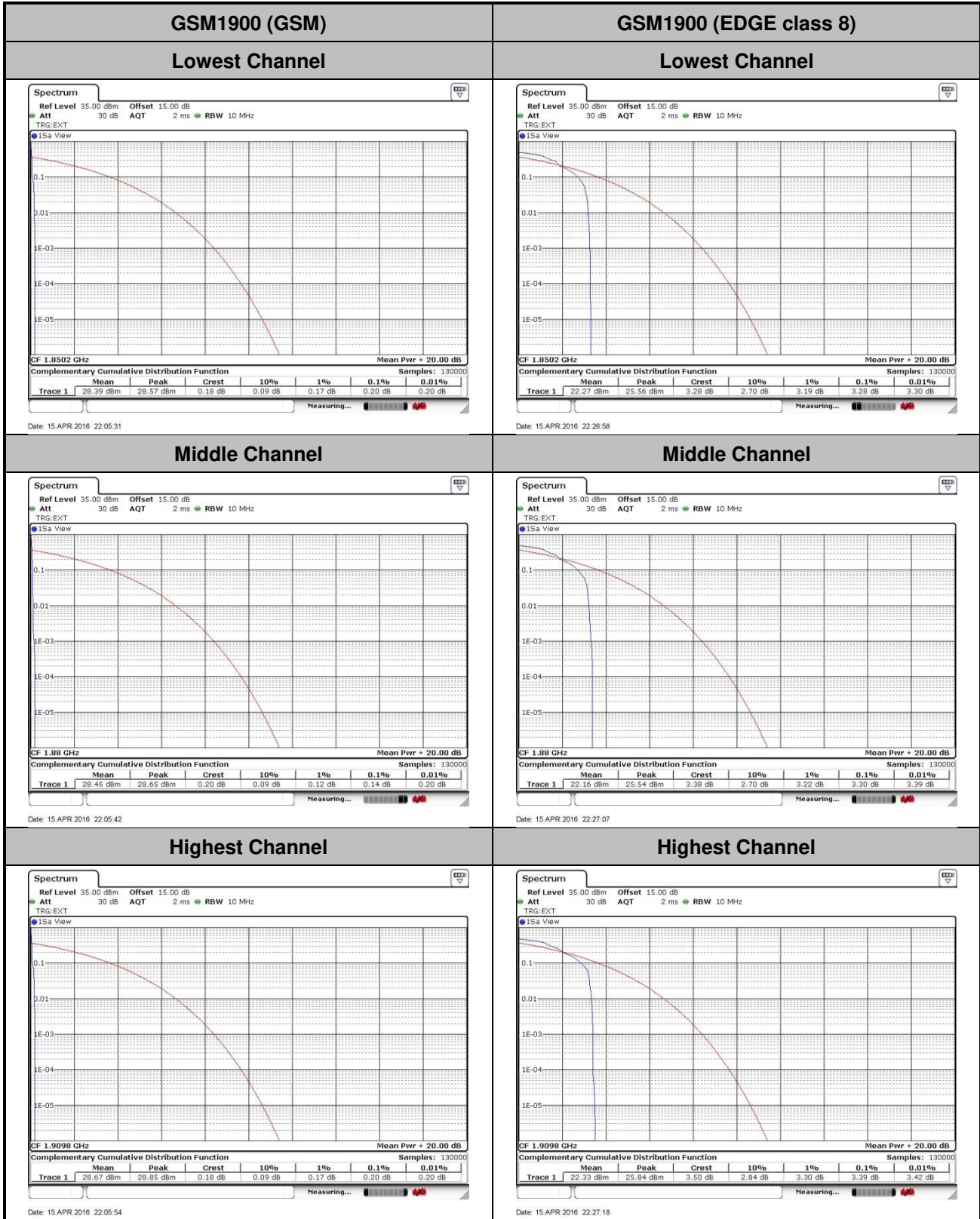



26dB Bandwidth

Mode	GSM850 (MHz)	
Mod.	GSM	EDGE class 8
Lowest CH	0.316	0.312
Middle CH	0.315	0.313
Highest CH	0.315	0.310

Mode	GSM1900 (MHz)	
Mod.	GSM	EDGE class 8
Lowest CH	0.316	0.313
Middle CH	0.317	0.314
Highest CH	0.316	0.309



GSM850 (GSM)

Lowest Channel

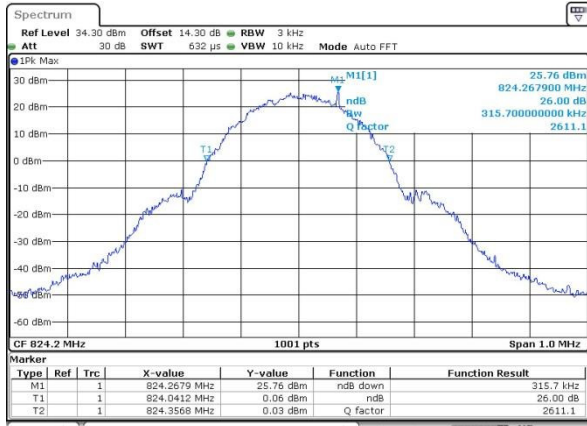

Date: 15 APR 2016 19:40:08

GSM850 (EDGE class 8)

Lowest Channel

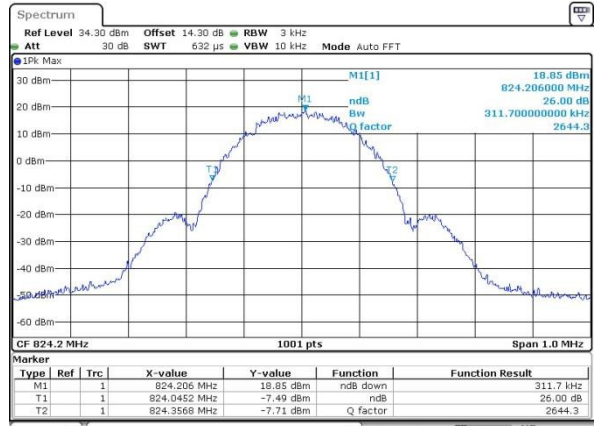

Date: 15 APR 2016 20:24:09

Middle Channel

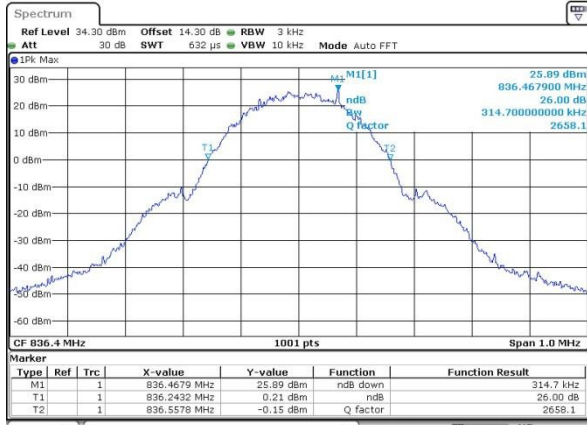

Date: 15 APR 2016 19:40:36

Middle Channel

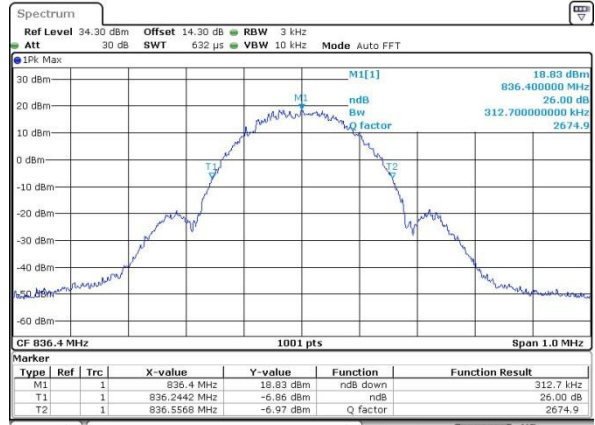

Date: 15 APR 2016 20:24:57

Highest Channel

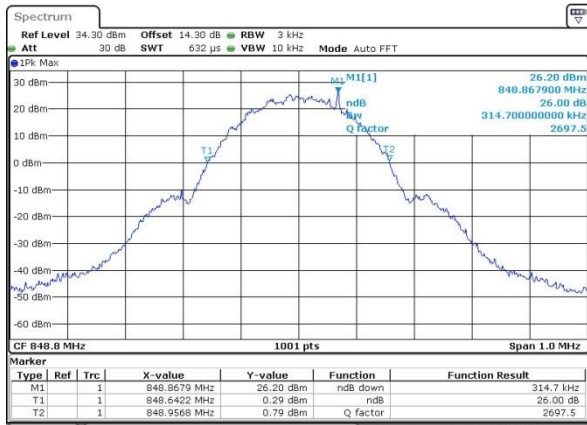

Date: 15 APR 2016 19:41:05

Highest Channel

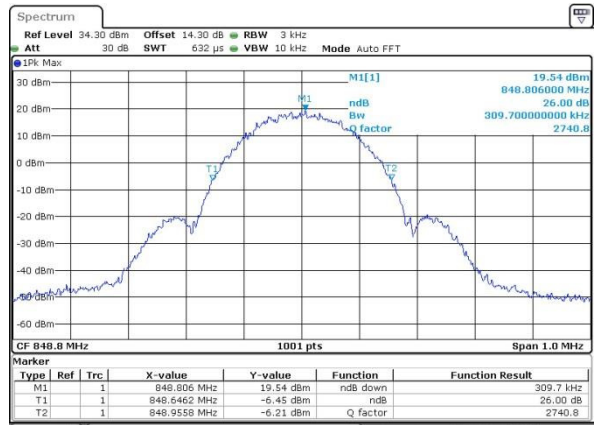

Date: 15 APR 2016 20:25:43



GSM1900 (GSM)

Lowest Channel

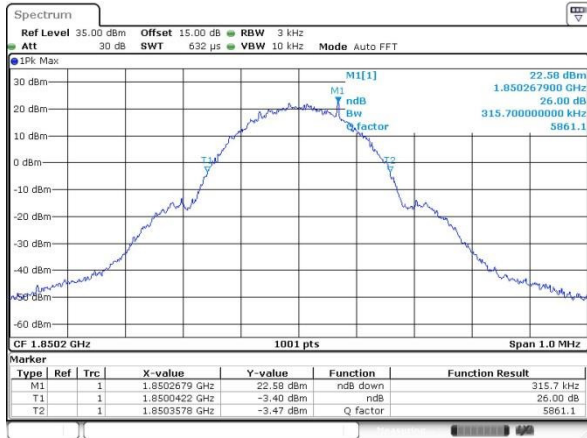

Date: 15 APR 2016 21:50:12

GSM1900 (EDGE class 8)

Lowest Channel

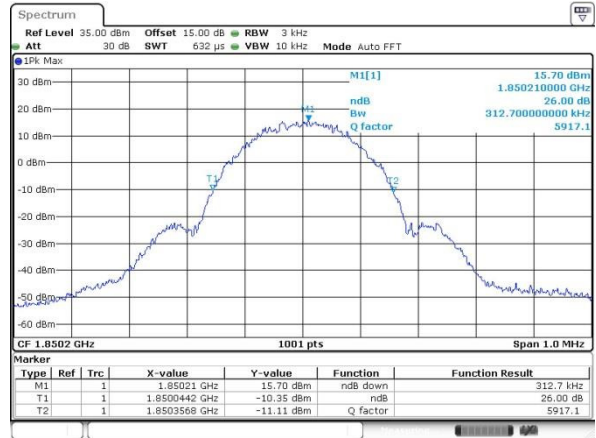

Date: 15 APR 2016 22:13:13

Middle Channel

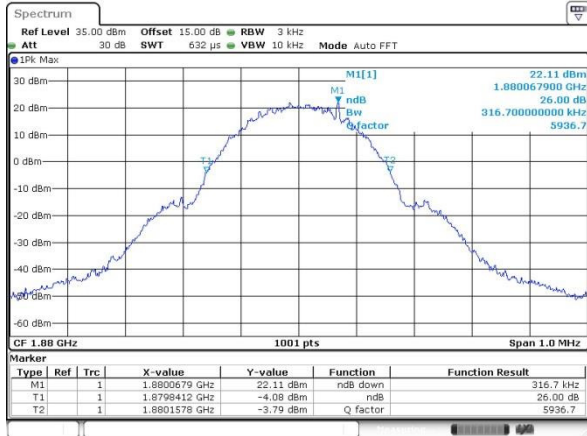

Date: 15 APR 2016 21:50:41

Middle Channel

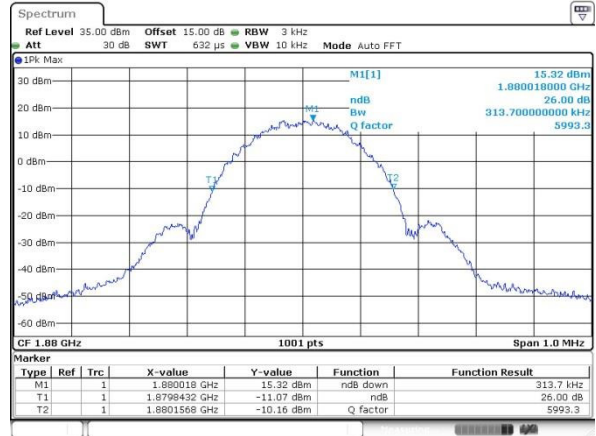

Date: 15 APR 2016 22:13:49

Highest Channel

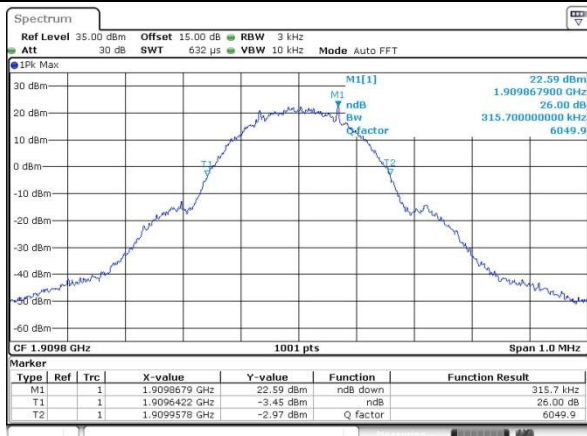

Date: 15 APR 2016 21:51:09

Highest Channel

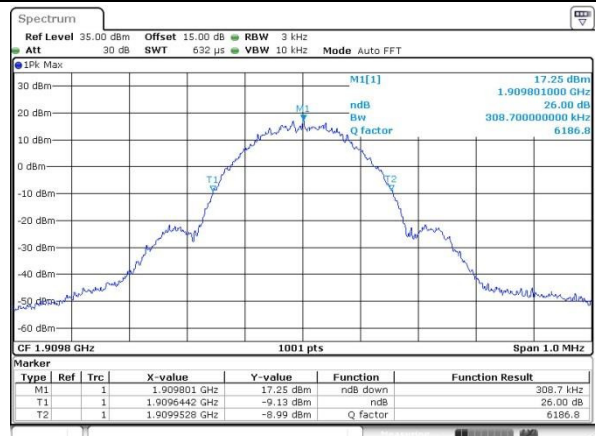

Date: 15 APR 2016 22:14:24



Occupied Bandwidth

Mode	GSM850 (MHz)	
Mod.	GSM	EDGE class 8
Lowest CH	0.242	0.242
Middle CH	0.242	0.245
Highest CH	0.242	0.249

Mode	GSM1900 (MHz)	
Mod.	GSM	EDGE class 8
Lowest CH	0.245	0.245
Middle CH	0.241	0.246
Highest CH	0.244	0.245



GSM850 (GSM)

Lowest Channel

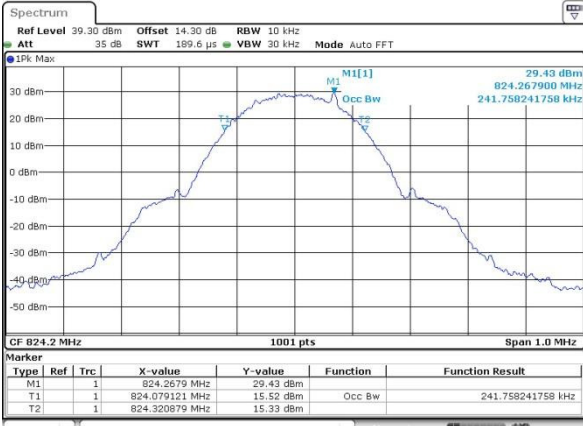

Date: 15 APR 2016 19:45:09

GSM850 (EDGE class 8)

Lowest Channel

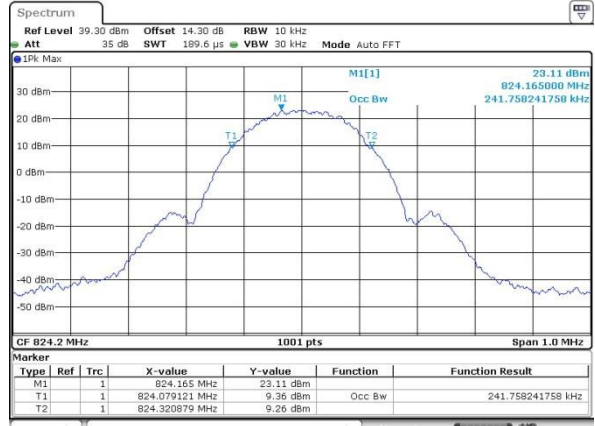

Date: 15 APR 2016 22:32:25

Middle Channel

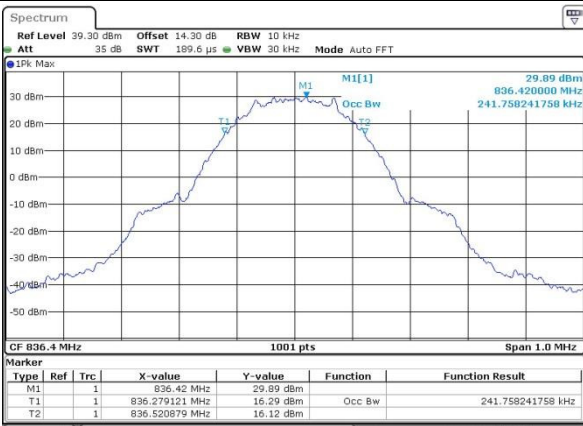

Date: 15 APR 2016 19:45:37

Middle Channel

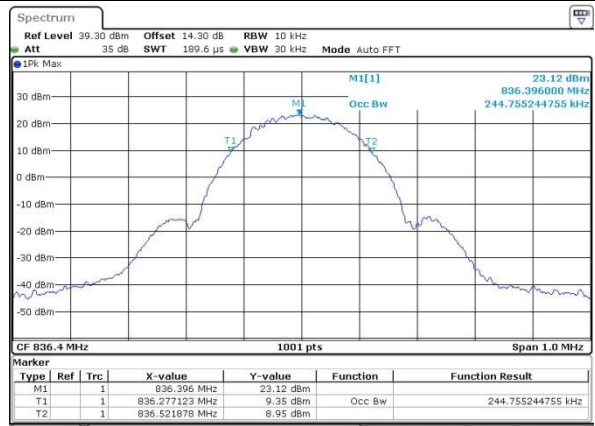

Date: 15 APR 2016 22:32:57

Highest Channel

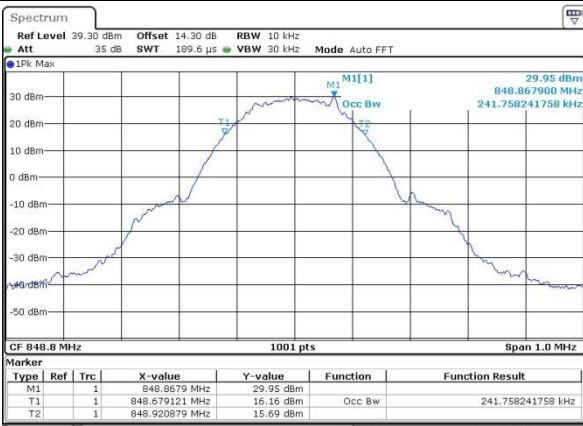

Date: 15 APR 2016 19:46:06

Highest Channel

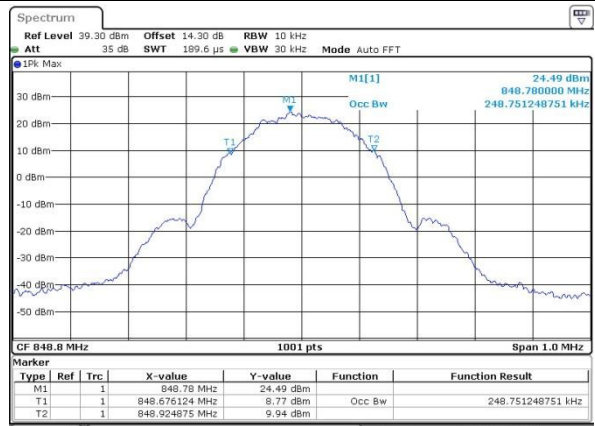

Date: 15 APR 2016 22:33:46



GSM1900 (GSM)

Lowest Channel

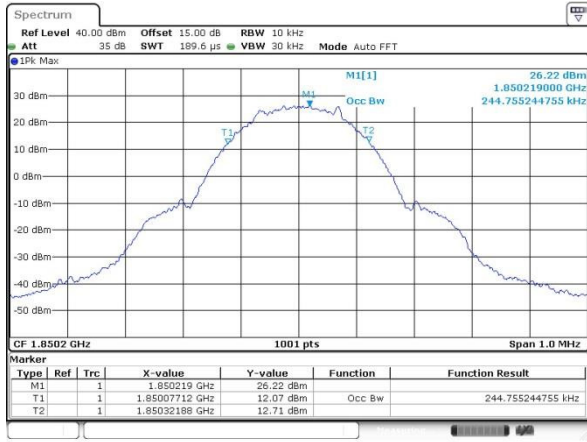

Date: 15 APR 2016 21:55:21

GSM1900 (EDGE class 8)

Lowest Channel

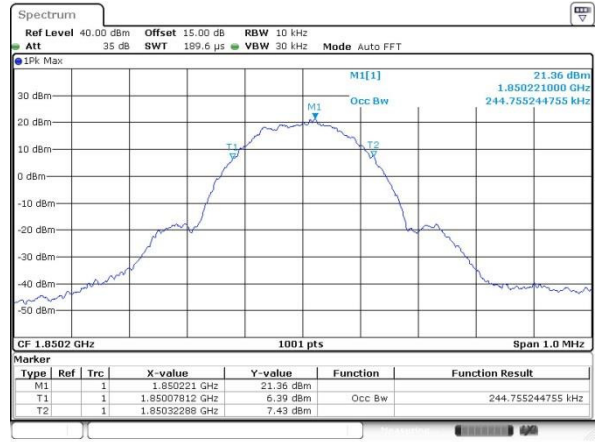

Date: 15 APR 2016 22:17:54

Middle Channel

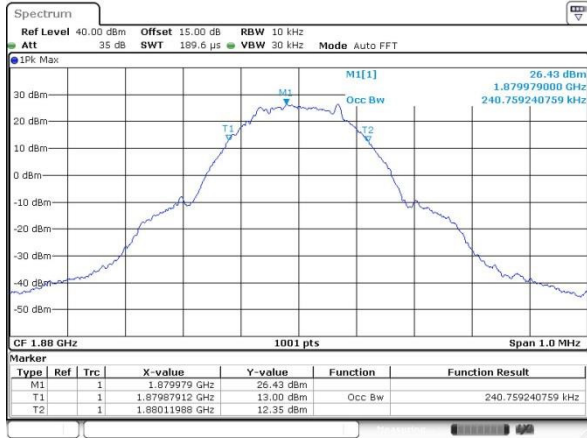

Date: 15 APR 2016 21:55:50

Middle Channel

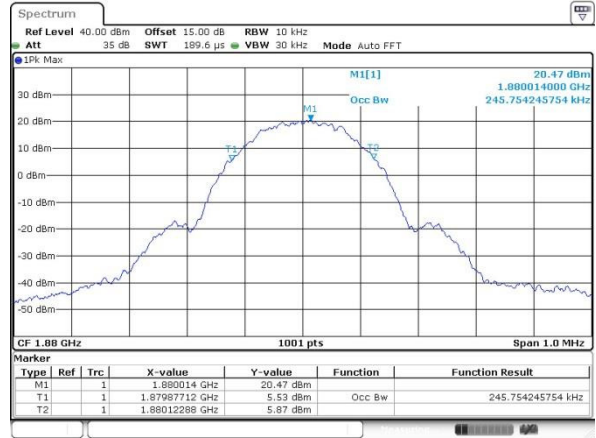

Date: 15 APR 2016 22:18:25

Highest Channel

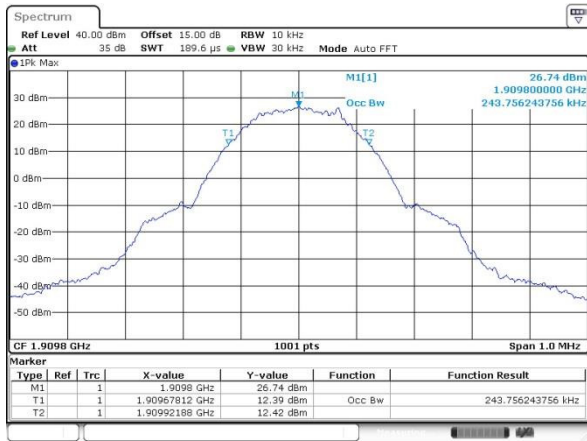

Date: 15 APR 2016 21:56:18

Highest Channel

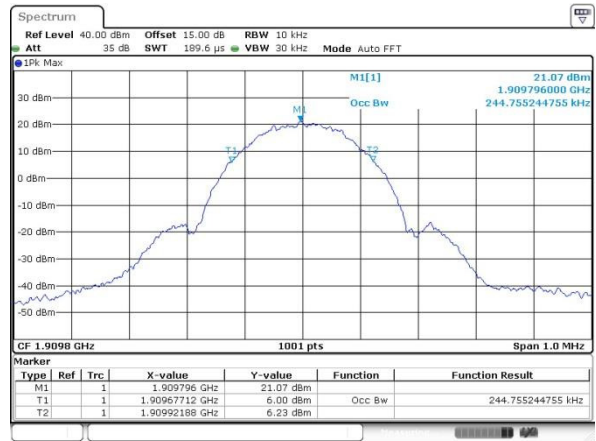

Date: 15 APR 2016 22:19:00



Conducted Band Edge

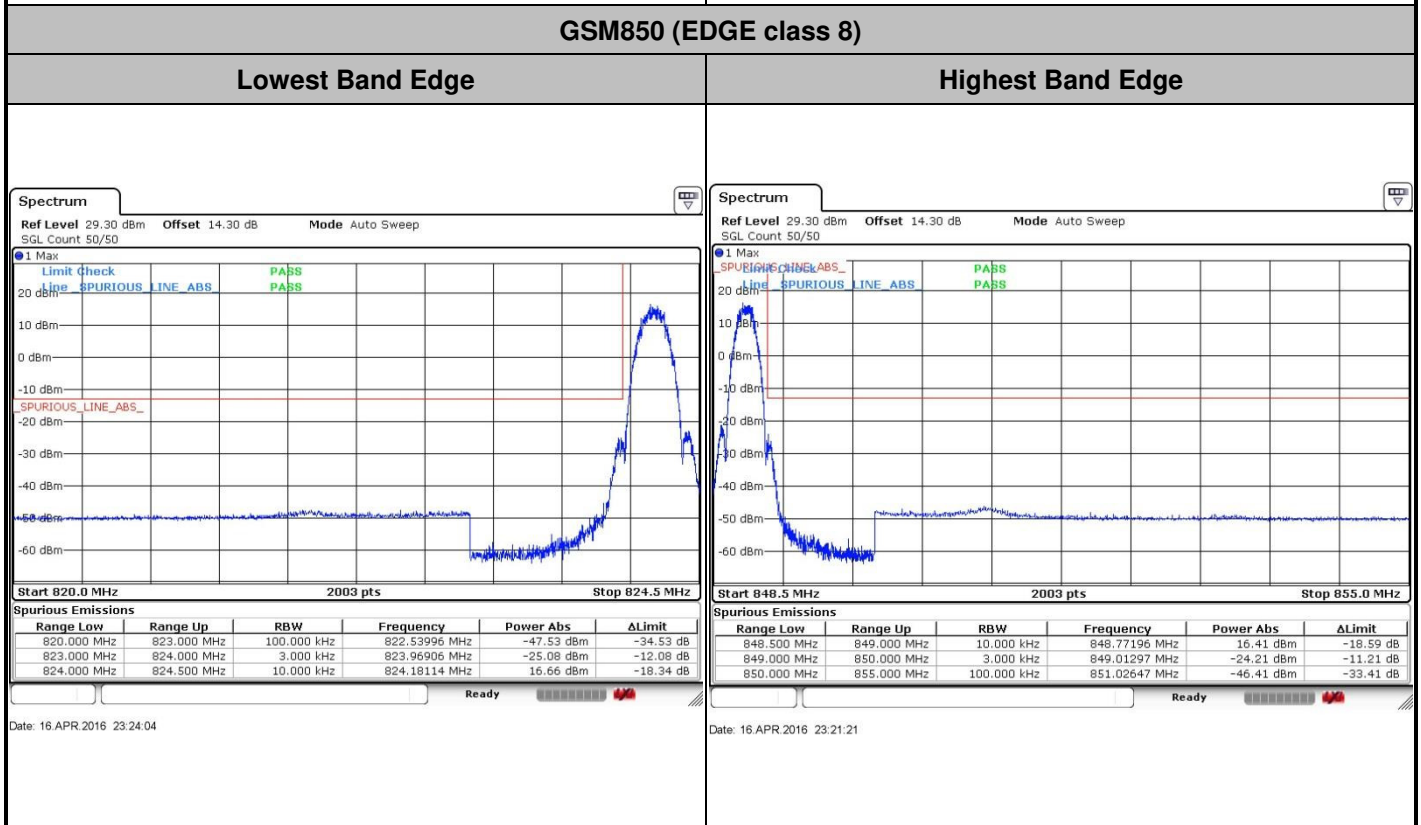
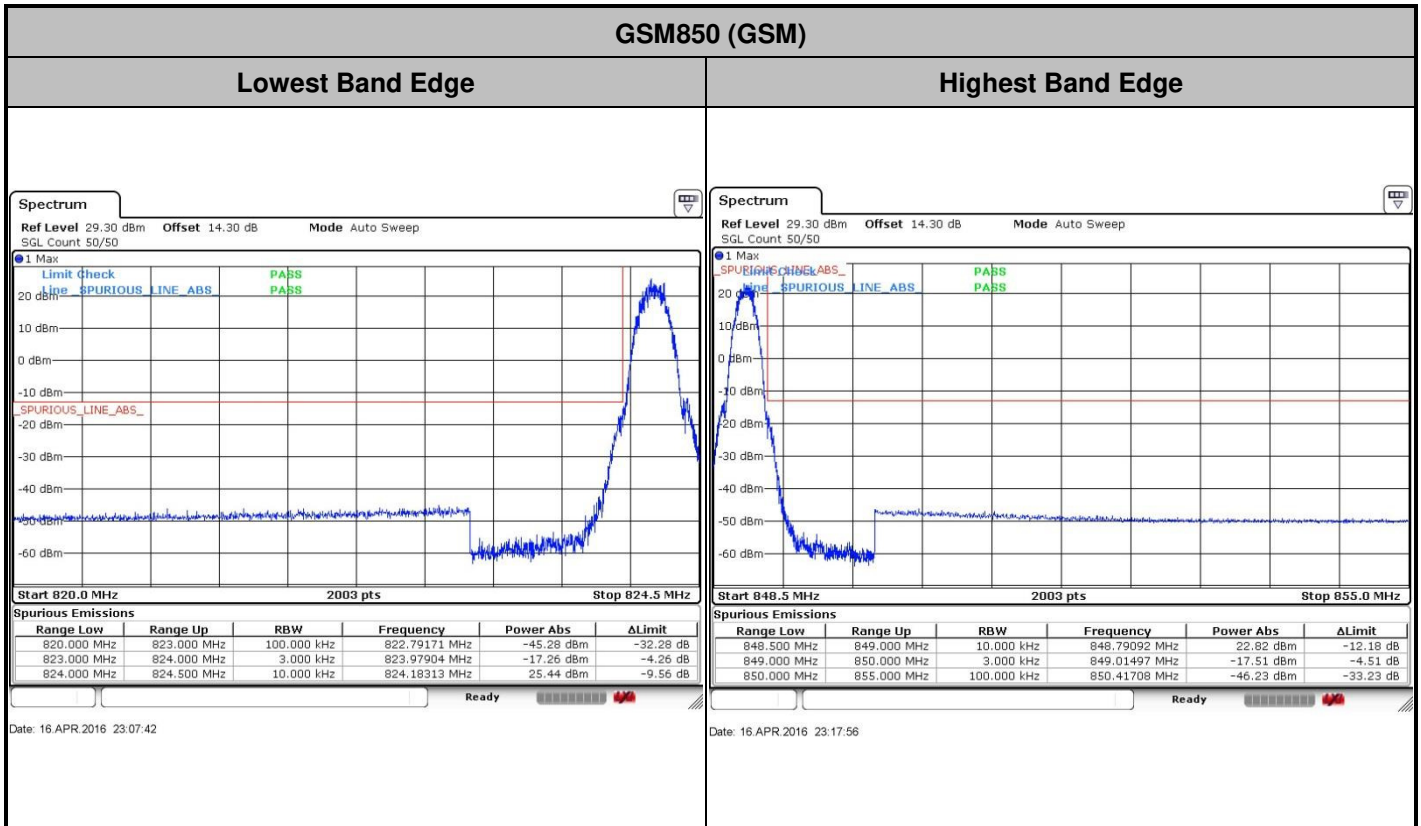



GSM1900 (GSM)

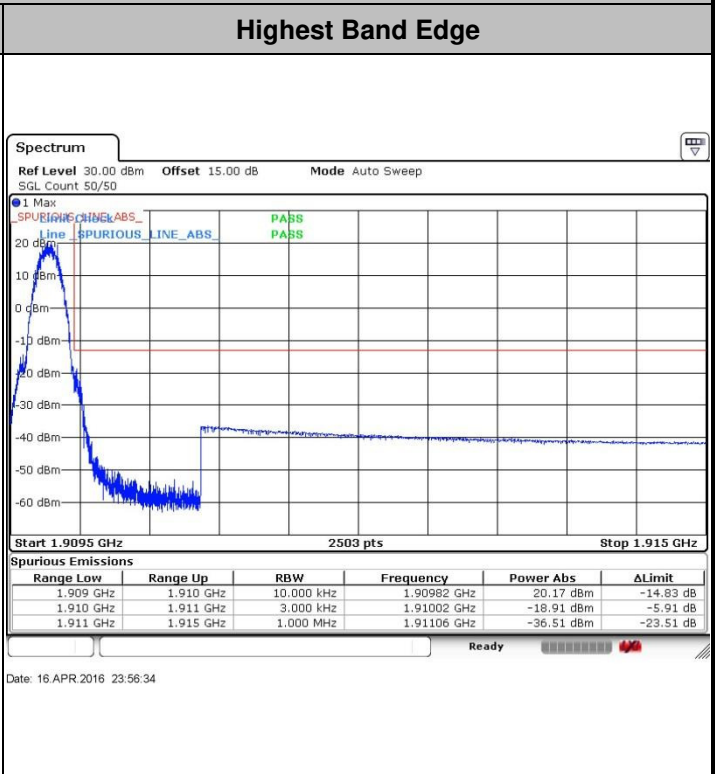
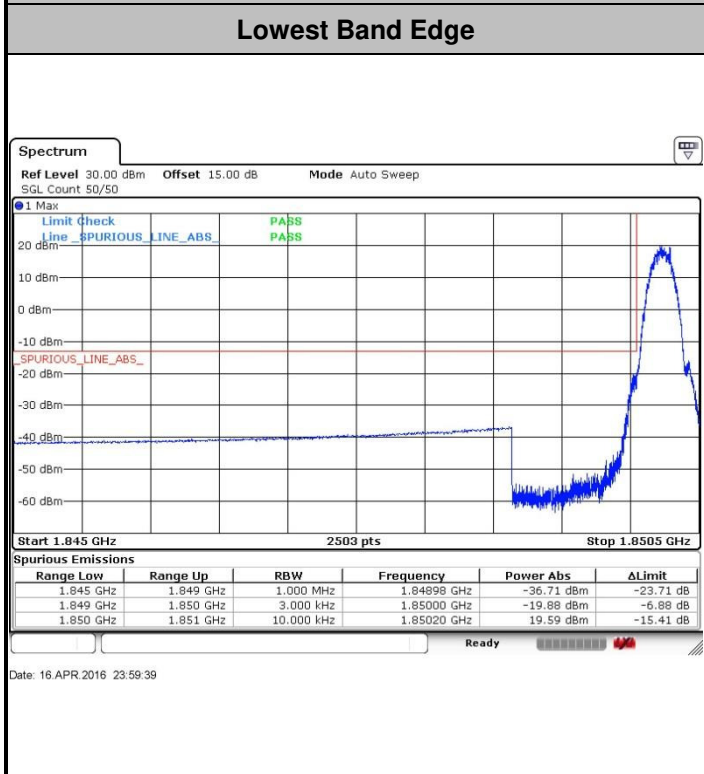

GSM1900 (EDGE class 8)

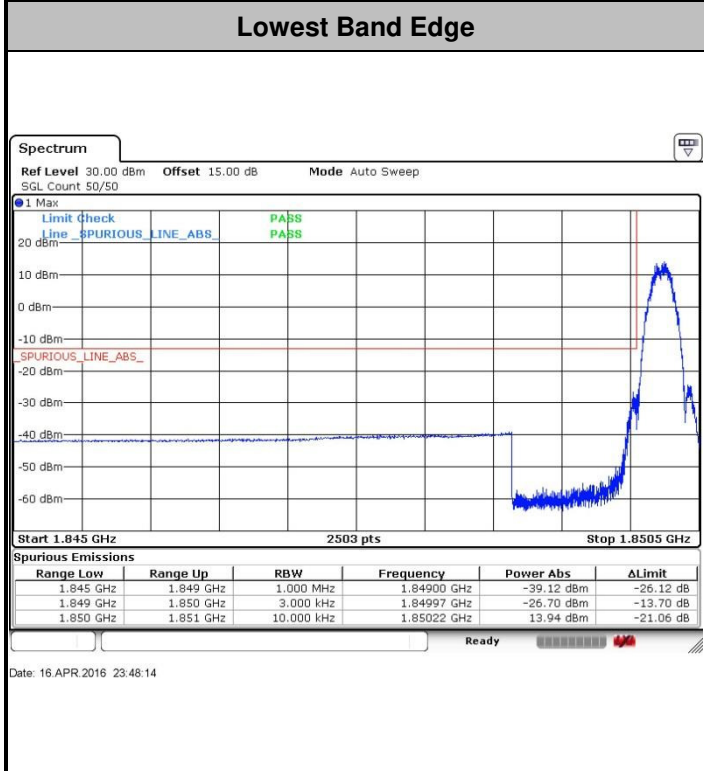



Conducted Spurious Emission

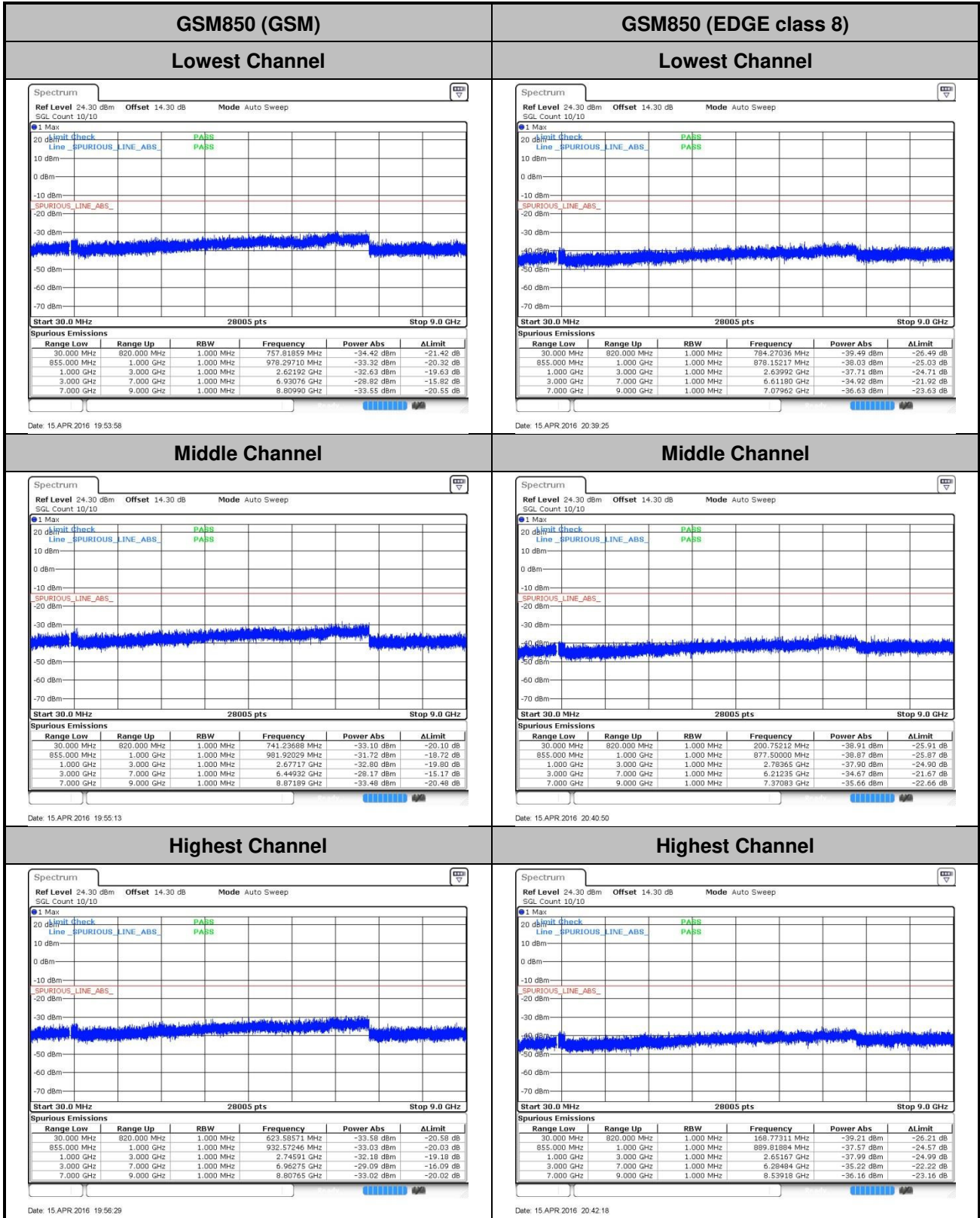

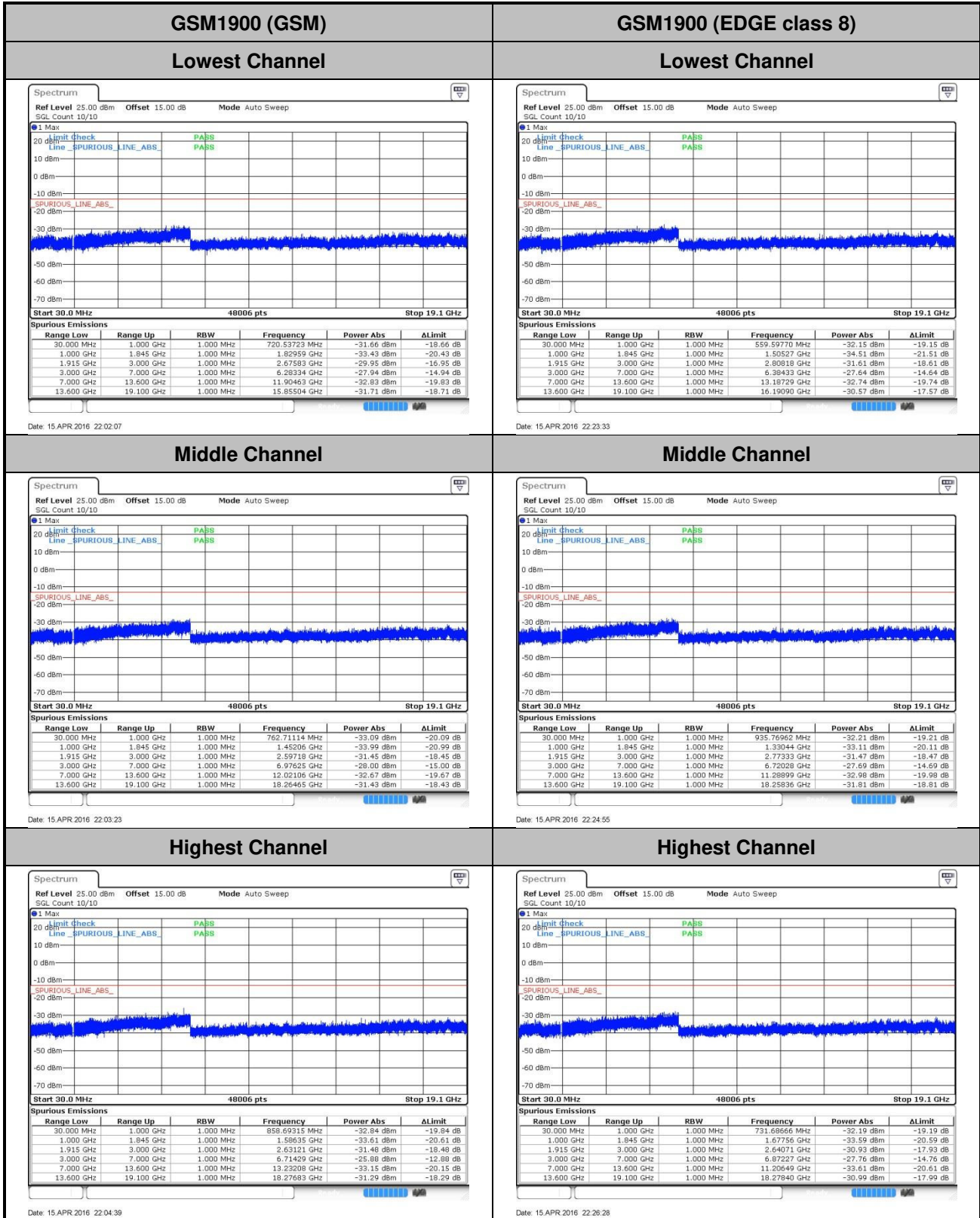



Frequency Stability

Test Conditions	Middle Channel	GSM850 (GSM)	GSM850 (EDGE class 8)	Limit 2.5ppm
Temperature (°C)	Voltage (Volt)	Deviation (ppm)		Result
50	Normal Voltage	0.0072	0.0048	PASS
40	Normal Voltage	0.0084	0.0024	
30	Normal Voltage	0.0024	0.0024	
20(Ref.)	Normal Voltage	0.0000	0.0000	
10	Normal Voltage	0.0048	0.0012	
0	Normal Voltage	0.0012	0.0048	
-10	Normal Voltage	0.0024	0.0024	
-20	Normal Voltage	0.0155	0.0072	
-30	Normal Voltage	0.0191	0.0096	
20	Maximum Voltage	0.0012	0.0060	
20	Normal Voltage	0.0167	0.0048	
20	Battery End Point	0.0000	0.0012	

Note: Normal Voltage = 3.8V. ; Battery End Point (BEP) = 3.6V. ; Maximum Voltage =4.35 V

Test Conditions	Middle Channel	GSM1900 (GSM)	GSM1900 (EDGE class 8)	Limit Note 2.
Temperature (°C)	Voltage (Volt)	Deviation (ppm)		Result
50	Normal Voltage	0.0106	0.0170	PASS
40	Normal Voltage	0.0112	0.0186	
30	Normal Voltage	0.0005	0.0011	
20(Ref.)	Normal Voltage	0.0000	0.0000	
10	Normal Voltage	0.0016	0.0005	
0	Normal Voltage	0.0048	0.0016	
-10	Normal Voltage	0.0016	0.0005	
-20	Normal Voltage	0.0144	0.0170	
-30	Normal Voltage	0.0138	0.0165	
20	Maximum Voltage	0.0080	0.0011	
20	Normal Voltage	0.0016	0.0005	
20	Battery End Point	0.0005	0.0005	

Note:

1. Normal Voltage = 3.8V. ; Battery End Point (BEP) = 3.6V. ; Maximum Voltage =4.35V
2. The frequency fundamental emissions stay within the authorized frequency block based on the frequency deviation measured is small.



A2. WCDMA

Peak-to-Average Ratio

Mode	WCDMA Band V	WCDMA Band II	WCDMA Band IV	Limit: 13dB
Mod.	RMC 12.2Kbps	RMC 12.2Kbps	RMC 12.2Kbps	Result
Lowest CH	3.62	3.25	2.90	PASS
Middle CH	3.71	3.30	2.93	
Highest CH	3.83	3.33	2.87	

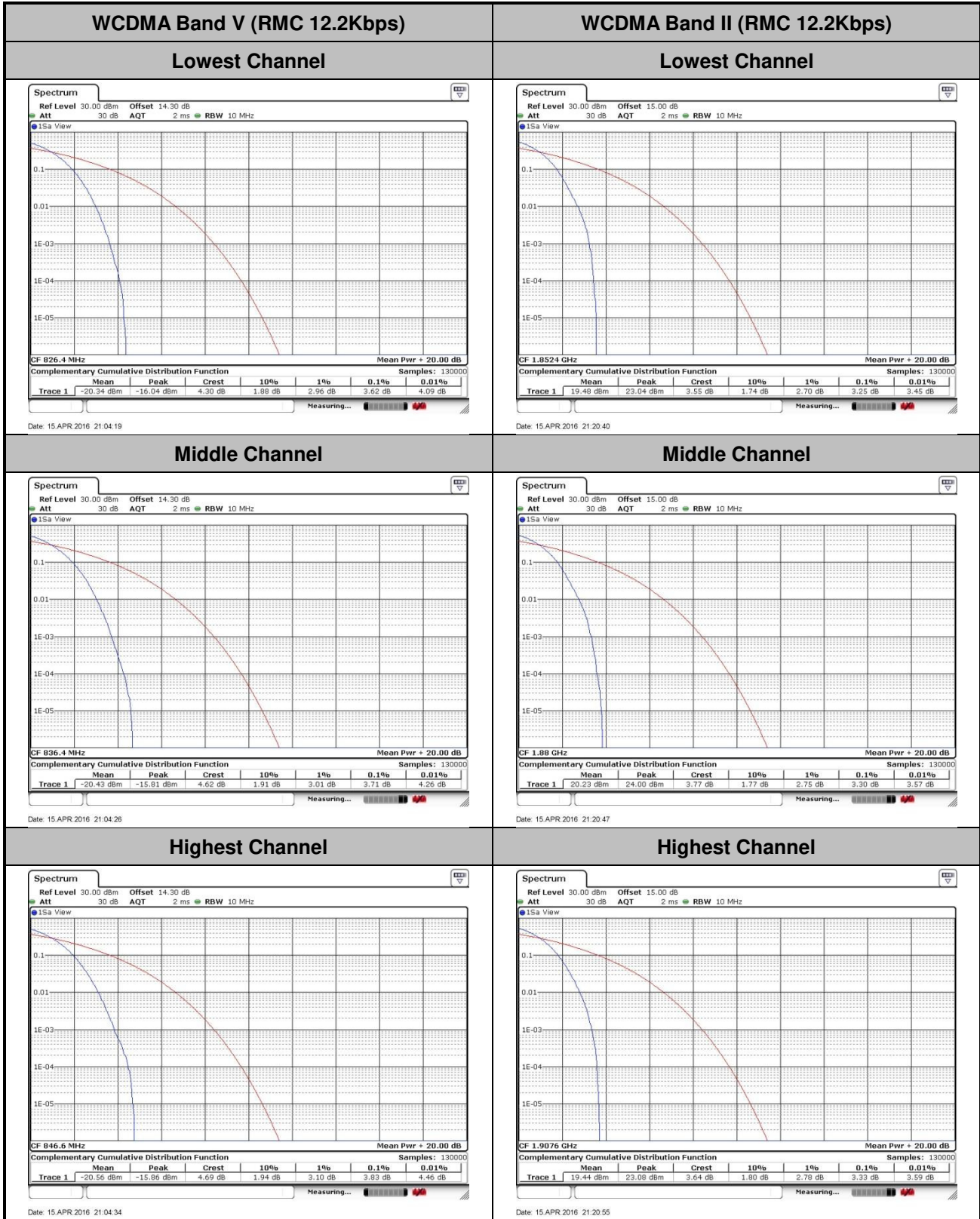



WCDMA Band IV (RMC 12.2Kbps)

Lowest Channel



Date: 15 APR 2016 21:43:22

Middle Channel

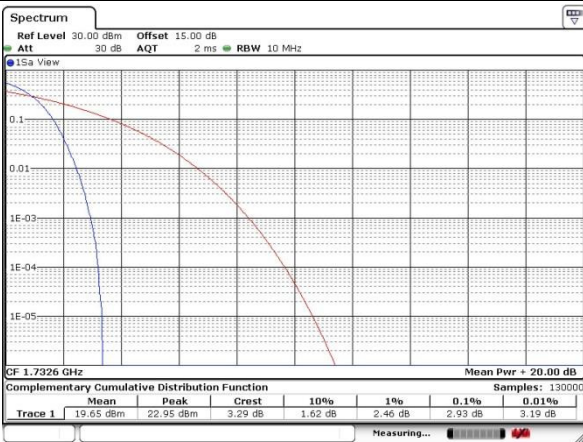

Date: 15 APR 2016 21:43:29

Highest Channel

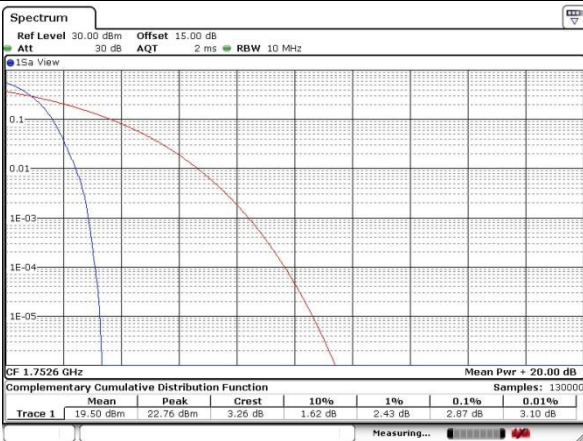

Date: 15 APR 2016 21:43:37



26dB Bandwidth

Mode	WCDMA Band V (MHz)	WCDMA Band II (MHz)	WCDMA Band IV (MHz)
Mod.	RMC 12.2Kbps	RMC 12.2Kbps	RMC 12.2Kbps
Lowest CH	4.71	4.72	4.73
Middle CH	4.73	4.72	4.75
Highest CH	4.69	4.74	4.74



WCDMA Band V (RMC 12.2Kbps)

Lowest Channel

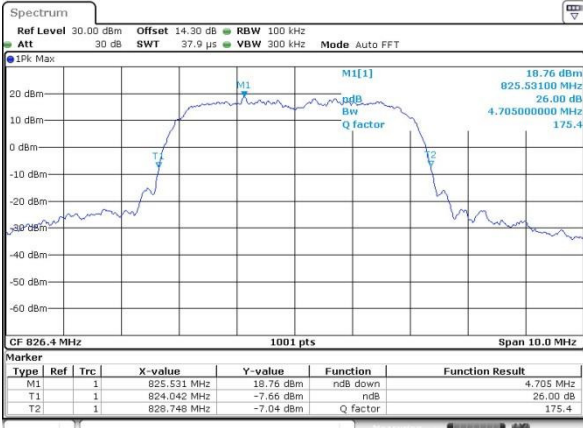

Date: 15 APR 2016 20:46:41

WCDMA Band II (RMC 12.2Kbps)

Lowest Channel

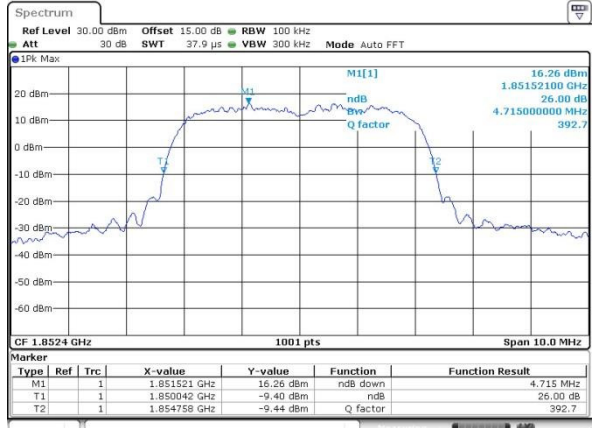

Date: 15 APR 2016 21:10:05

Middle Channel

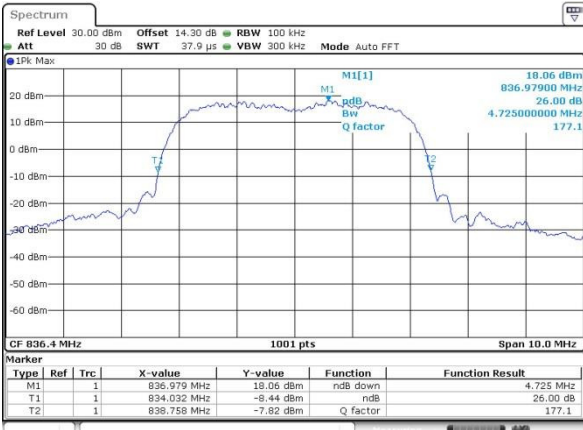

Date: 15 APR 2016 20:47:10

Middle Channel

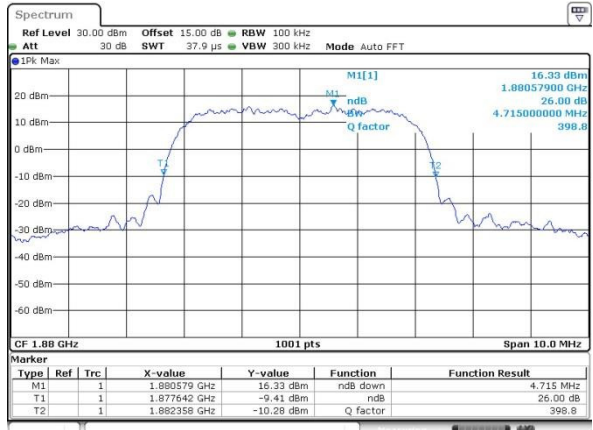

Date: 15 APR 2016 21:10:33

Highest Channel

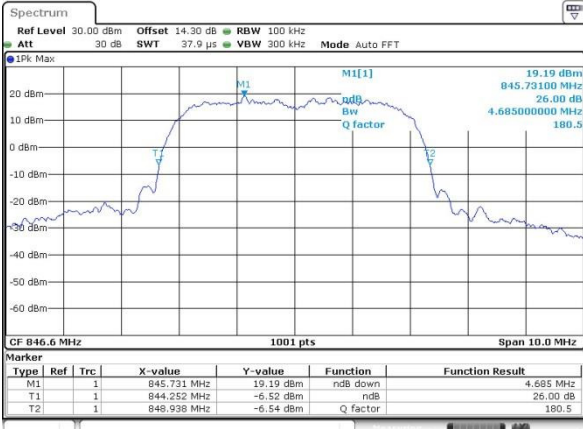

Date: 15 APR 2016 20:47:38

Highest Channel

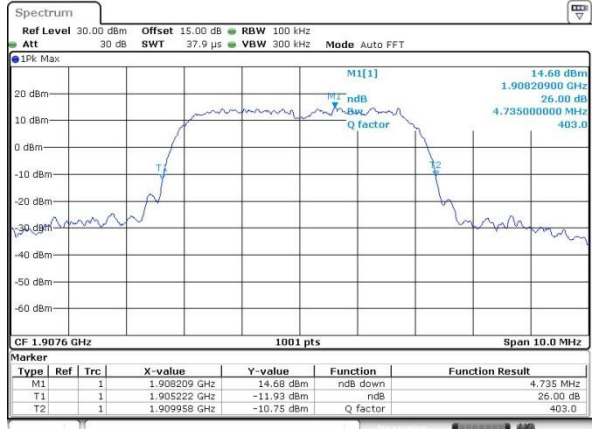

Date: 15 APR 2016 21:11:02



WCDMA Band IV (RMC 12.2Kbps)

Lowest Channel

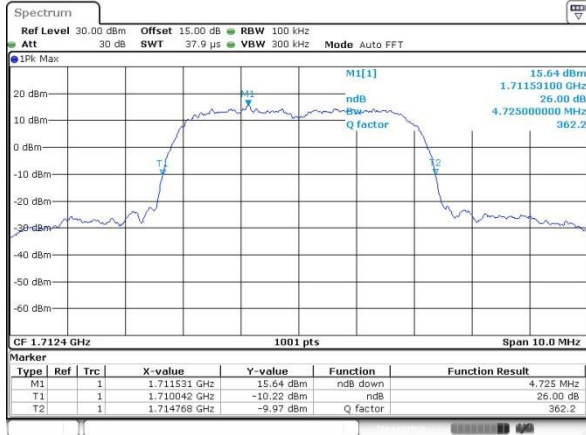

Date: 15 APR 2016 21:33:26

Middle Channel

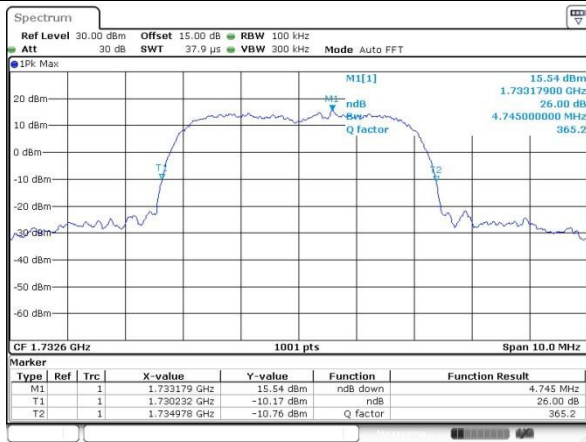

Date: 15 APR 2016 21:33:54

Highest Channel

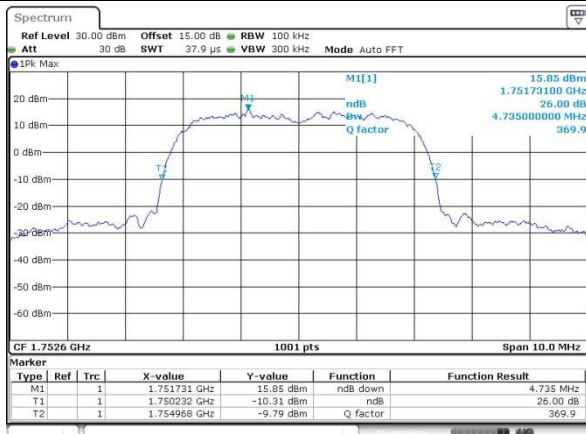

Date: 15 APR 2016 21:34:22



Occupied Bandwidth

Mode	WCDMA Band V	WCDMA Band II	WCDMA Band IV
Mod.	RMC 12.2Kbps	RMC 12.2Kbps	RMC 12.2Kbps
Lowest CH	4.14	4.15	4.15
Middle CH	4.14	4.16	4.16
Highest CH	4.14	4.14	4.16