



**Glossary:**

TSL	tissue simulating liquid
ConvF	sensitivity in TSL / NORM <sub>x,y,z</sub>
N/A	not applicable or not measured

**Calibration is Performed According to the Following Standards:**

- IEEE Std 1528-2013, "IEEE Recommended Practice for Determining the Peak Spatial-Averaged Specific Absorption Rate (SAR) in the Human Head from Wireless Communications Devices: Measurement Techniques", June 2013
- IEC 62209-1, "Procedure to measure the Specific Absorption Rate (SAR) For hand-held devices used in close proximity to the ear (frequency range of 300MHz to 3GHz)", February 2005
- IEC 62209-2, "Procedure to measure the Specific Absorption Rate (SAR) For wireless communication devices used in close proximity to the human body (frequency range of 30MHz to 6GHz)", March 2010
- KDB865664, SAR Measurement Requirements for 100 MHz to 6 GHz

**Additional Documentation:**

- DASY4/5 System Handbook

**Methods Applied and Interpretation of Parameters:**

- Measurement Conditions:* Further details are available from the Validation Report at the end of the certificate. All figures stated in the certificate are valid at the frequency indicated.
- Antenna Parameters with TSL:* The dipole is mounted with the spacer to position its feed point exactly below the center marking of the flat phantom section, with the arms oriented parallel to the body axis.
- Feed Point Impedance and Return Loss:* These parameters are measured with the dipole positioned under the liquid filled phantom. The impedance stated is transformed from the measurement at the SMA connector to the feed point. The Return Loss ensures low reflected power. No uncertainty required.
- Electrical Delay:* One-way delay between the SMA connector and the antenna feed point. No uncertainty required.
- SAR measured:* SAR measured at the stated antenna input power.
- SAR normalized:* SAR as measured, normalized to an input power of 1 W at the antenna connector.
- SAR for nominal TSL parameters:* The measured TSL parameters are used to calculate the nominal SAR result.

The reported uncertainty of measurement is stated as the standard uncertainty of Measurement multiplied by the coverage factor  $k=2$ , which for a normal distribution Corresponds to a coverage probability of approximately 95%.



### Measurement Conditions

DASY system configuration, as far as not given on page 1.

<b>DASY Version</b>	DASY52	52.8.8.1258
<b>Extrapolation</b>	Advanced Extrapolation	
<b>Phantom</b>	Triple Flat Phantom 5.1C	
<b>Distance Dipole Center - TSL</b>	10 mm	with Spacer
<b>Zoom Scan Resolution</b>	dx, dy, dz = 5 mm	
<b>Frequency</b>	2450 MHz ± 1 MHz	

### Head TSL parameters

The following parameters and calculations were applied.

	Temperature	Permittivity	Conductivity
<b>Nominal Head TSL parameters</b>	22.0 °C	39.2	1.80 mho/m
<b>Measured Head TSL parameters</b>	(22.0 ± 0.2) °C	39.0 ± 6 %	1.77 mho/m ± 6 %
<b>Head TSL temperature change during test</b>	<1.0 °C	----	----

### SAR result with Head TSL

<b>SAR averaged over 1 cm<sup>3</sup> (1 g) of Head TSL</b>	Condition	
SAR measured	250 mW input power	13.2 mW / g
SAR for nominal Head TSL parameters	normalized to 1W	<b>53.2 mW / g ± 20.8 % (k=2)</b>
<b>SAR averaged over 10 cm<sup>3</sup> (10 g) of Head TSL</b>	Condition	
SAR measured	250 mW input power	6.13 mW / g
SAR for nominal Head TSL parameters	normalized to 1W	<b>24.6 mW / g ± 20.4 % (k=2)</b>

### Body TSL parameters

The following parameters and calculations were applied.

	Temperature	Permittivity	Conductivity
<b>Nominal Body TSL parameters</b>	22.0 °C	52.7	1.95 mho/m
<b>Measured Body TSL parameters</b>	(22.0 ± 0.2) °C	52.3 ± 6 %	1.93 mho/m ± 6 %
<b>Body TSL temperature change during test</b>	<1.0 °C	----	----

### SAR result with Body TSL

<b>SAR averaged over 1 cm<sup>3</sup> (1 g) of Body TSL</b>	Condition	
SAR measured	250 mW input power	12.7 mW / g
SAR for nominal Body TSL parameters	normalized to 1W	<b>50.9 mW / g ± 20.8 % (k=2)</b>
<b>SAR averaged over 10 cm<sup>3</sup> (10 g) of Body TSL</b>	Condition	
SAR measured	250 mW input power	5.88 mW / g
SAR for nominal Body TSL parameters	normalized to 1W	<b>23.6 mW / g ± 20.4 % (k=2)</b>



### Appendix (Additional assessments outside the scope of CNAS L0570)

#### Antenna Parameters with Head TSL

Impedance, transformed to feed point	55.5Ω+ 2.35jΩ
Return Loss	- 24.9dB

#### Antenna Parameters with Body TSL

Impedance, transformed to feed point	52.5Ω+ 2.12jΩ
Return Loss	- 30.0dB

#### General Antenna Parameters and Design

Electrical Delay (one direction)	1.261 ns
----------------------------------	----------

After long term use with 100W radiated power, only a slight warming of the dipole near the feedpoint can be measured.

The dipole is made of standard semirigid coaxial cable. The center conductor of the feeding line is directly connected to the second arm of the dipole. The antenna is therefore short-circuited for DC-signals. On some of the dipoles, small end caps are added to the dipole arms in order to improve matching when loaded according to the position as explained in the "Measurement Conditions" paragraph. The SAR data are not affected by this change. The overall dipole length is still according to the Standard. No excessive force must be applied to the dipole arms, because they might bend or the soldered connections near the feedpoint may be damaged.

#### Additional EUT Data

Manufactured by	SPEAG
-----------------	-------



Add: No.51 Xueyuan Road, Haidian District, Beijing, 100191, China  
Tel: +86-10-62304633-2079 Fax: +86-10-62304633-2504  
E-mail: cttl@chinattl.com http://www.chinattl.cn

### DASY5 Validation Report for Head TSL

Date: 03.21.2017

Test Laboratory: CTTL, Beijing, China

**DUT: Dipole 2450 MHz; Type: D2450V2; Serial: D2450V2 - SN: 908**

Communication System: UID 0, CW; Frequency: 2450 MHz; Duty Cycle: 1:1

Medium parameters used:  $f = 2450$  MHz;  $\sigma = 1.768$  S/m;  $\epsilon_r = 39.02$ ;  $\rho = 1000$  kg/m<sup>3</sup>

Phantom section: Right Section

Measurement Standard: DASY5 (IEEE/IEC/ANSI C63.19-2007)

DASY5 Configuration:

- Probe: EX3DV4 - SN3617; ConvF(7.74, 7.74, 7.74); Calibrated: 1/23/2017;
- Sensor-Surface: 1.4mm (Mechanical Surface Detection)
- Electronics: DAE4 Sn777; Calibrated: 8/22/2016
- Phantom: Triple Flat Phantom 5.1C; Type: QD 000 P51 CA; Serial: 1161/1
- Measurement SW: DASY52, Version 52.8 (8); SEMCAD X Version 14.6.10 (7372)

**Dipole Calibration/Zoom Scan (7x7x7) (7x7x7)/Cube 0:** Measurement grid: dx=5mm, dy=5mm, dz=5mm

Reference Value = 104.7 V/m; Power Drift = 0.04 dB

Peak SAR (extrapolated) = 27.4 W/kg

**SAR(1 g) = 13.2 W/kg; SAR(10 g) = 6.13 W/kg**

Maximum value of SAR (measured) = 22.0 W/kg

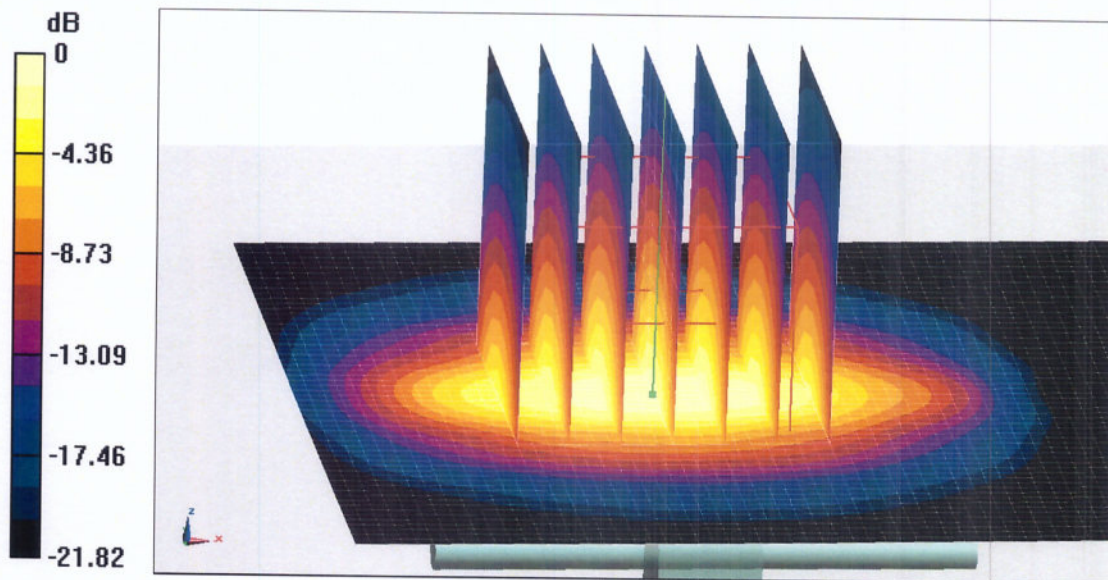

0 dB = 22.0 W/kg = 13.42 dBW/kg



Add: No.51 Xueyuan Road, Haidian District, Beijing, 100191, China  
Tel: +86-10-62304633-2079 Fax: +86-10-62304633-2504  
E-mail: cttl@chinattl.com http://www.chinattl.cn

### Impedance Measurement Plot for Head TSL

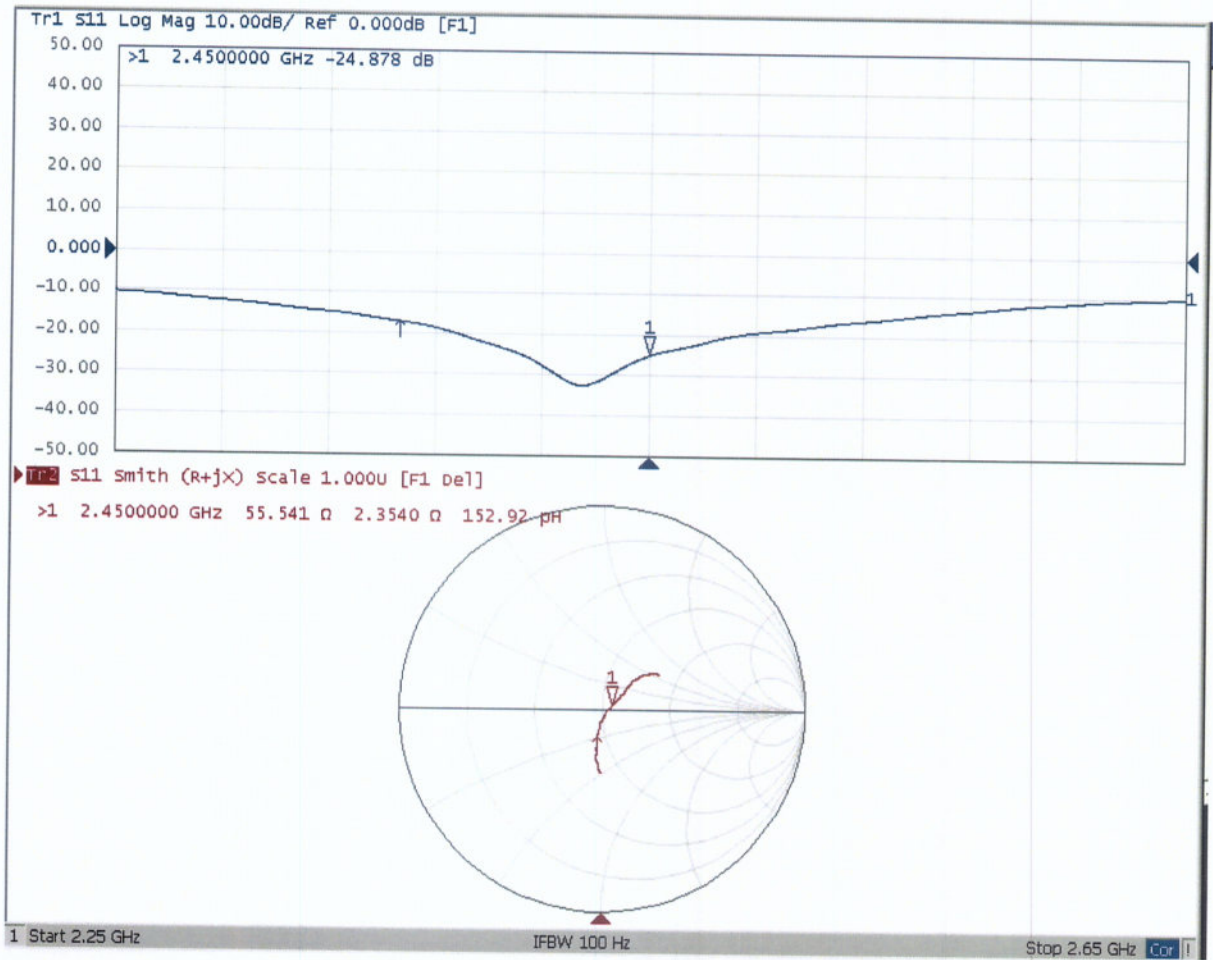



Add: No.51 Xueyuan Road, Haidian District, Beijing, 100191, China  
Tel: +86-10-62304633-2079 Fax: +86-10-62304633-2504  
E-mail: cttl@chinattl.com http://www.chinattl.cn

**DASY5 Validation Report for Body TSL**

Date: 03.21.2017

Test Laboratory: CTTL, Beijing, China

**DUT: Dipole 2450 MHz; Type: D2450V2; Serial: D2450V2 - SN: 908**

Communication System: UID 0, CW; Frequency: 2450 MHz; Duty Cycle: 1:1

Medium parameters used:  $f = 2450$  MHz;  $\sigma = 1.931$  S/m;  $\epsilon_r = 52.27$ ;  $\rho = 1000$  kg/m<sup>3</sup>

Phantom section: Center Section

Measurement Standard: DASY5 (IEEE/IEC/ANSI C63.19-2007)

DASY5 Configuration:

- Probe: EX3DV4 - SN3617; ConvF(7.8, 7.8, 7.8); Calibrated: 1/23/2017;
- Sensor-Surface: 1.4mm (Mechanical Surface Detection)
- Electronics: DAE4 Sn777; Calibrated: 8/22/2016
- Phantom: Triple Flat Phantom 5.1C; Type: QD 000 P51 CA; Serial: 1161/1
- Measurement SW: DASY52, Version 52.8 (8); SEMCAD X Version 14.6.10 (7372)

**Dipole Calibration/Zoom Scan (7x7x7) (7x7x7)/Cube 0:** Measurement grid: dx=5mm, dy=5mm, dz=5mm

Reference Value = 97.13 V/m; Power Drift = 0.01 dB

Peak SAR (extrapolated) = 27.0 W/kg

**SAR(1 g) = 12.7 W/kg; SAR(10 g) = 5.88 W/kg**

Maximum value of SAR (measured) = 21.7 W/kg

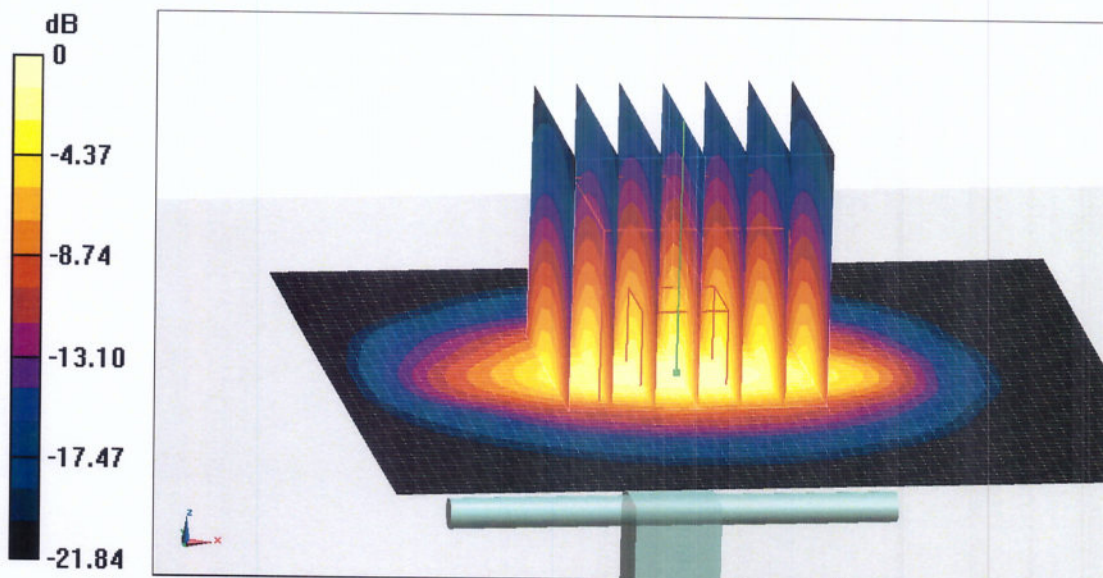

**0 dB = 21.7 W/kg = 13.36 dBW/kg**



Add: No.51 Xueyuan Road, Haidian District, Beijing, 100191, China  
Tel: +86-10-62304633-2079 Fax: +86-10-62304633-2504  
E-mail: cttl@chinattl.com http://www.chinattl.cn

### Impedance Measurement Plot for Body TSL

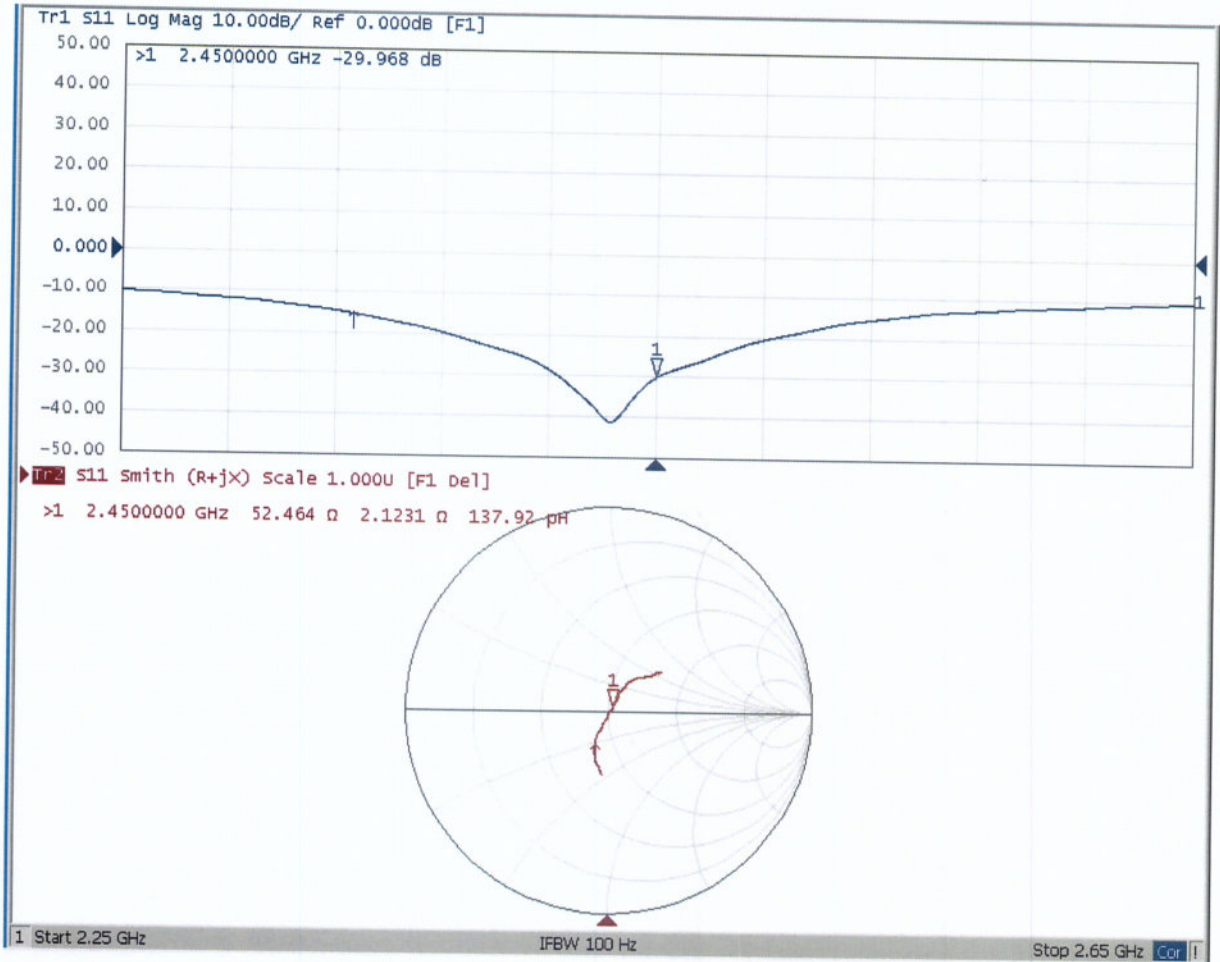



In Collaboration with  
**s p e a g**  
**CALIBRATION LABORATORY**



中国认可  
 国际互认  
 校准  
**CALIBRATION**  
**CNAS L0570**

Add: No.51 Xueyuan Road, Haidian District, Beijing, 100191, China  
 Tel: +86-10-62304633-2218 Fax: +86-10-62304633-2209  
 E-mail: cttl@chinattl.com [Http://www.chinattl.cn](http://www.chinattl.cn)

Client : **Sporton\_XA**

Certificate No: **Z16-97144**

## CALIBRATION CERTIFICATE

Object **DAE4 - SN: 1358**

Calibration Procedure(s) **FD-Z11-2-002-01**  
**Calibration Procedure for the Data Acquisition Electronics (DAEx)**

Calibration date: **September 05, 2016**

This calibration Certificate documents the traceability to national standards, which realize the physical units of measurements(SI). The measurements and the uncertainties with confidence probability are given on the following pages and are part of the certificate.

All calibrations have been conducted in the closed laboratory facility: environment temperature(22±3)°C and humidity<70%.

Calibration Equipment used (M&TE critical for calibration)

Primary Standards	ID #	Cal Date(Calibrated by, Certificate No.)	Scheduled Calibration
Process Calibrator 753	1971018	27-June-16 (CTTL, No:J16X04778)	June-17

	Name	Function	Signature
Calibrated by:	Yu Zongying	SAR Test Engineer	
Reviewed by:	Qi Dianyuan	SAR Project Leader	
Approved by:	Lu Bingsong	Deputy Director of the laboratory	

Issued: September 06, 2016

This calibration certificate shall not be reproduced except in full without written approval of the laboratory.





### **Glossary:**

DAE data acquisition electronics  
Connector angle information used in DASY system to align probe sensor X to the robot coordinate system.

### **Methods Applied and Interpretation of Parameters:**

- *DC Voltage Measurement:* Calibration Factor assessed for use in DASY system by comparison with a calibrated instrument traceable to national standards. The figure given corresponds to the full scale range of the voltmeter in the respective range.
- *Connector angle:* The angle of the connector is assessed measuring the angle mechanically by a tool inserted. Uncertainty is not required.
- The report provide only calibration results for DAE, it does not contain other performance test results.



Add: No.51 Xueyuan Road, Haidian District, Beijing, 100191, China  
 Tel: +86-10-62304633-2218 Fax: +86-10-62304633-2209  
 E-mail: cttl@chinattl.com Http://www.chinattl.cn

### DC Voltage Measurement

A/D - Converter Resolution nominal

High Range: 1LSB = 6.1 $\mu$ V, full range = -100...+300 mV

Low Range: 1LSB = 61nV, full range = -1.....+3mV

DASY measurement parameters: Auto Zero Time: 3 sec; Measuring time: 3 sec

Calibration Factors	X	Y	Z
High Range	403.508 $\pm$ 0.15% (k=2)	403.540 $\pm$ 0.15% (k=2)	403.540 $\pm$ 0.15% (k=2)
Low Range	3.96197 $\pm$ 0.7% (k=2)	3.98804 $\pm$ 0.7% (k=2)	3.99223 $\pm$ 0.7% (k=2)

### Connector Angle

Connector Angle to be used in DASY system	134 $^{\circ}$ $\pm$ 1 $^{\circ}$
---	-----------------------------------



Accredited by the Swiss Accreditation Service (SAS)  
The Swiss Accreditation Service is one of the signatories to the EA  
Multilateral Agreement for the recognition of calibration certificates

Accreditation No.: **SCS 0108**

Client **Sporton-XA (Auden)**

Certificate No: **EX3-3935\_Nov16**

**CALIBRATION CERTIFICATE**

Object: **EX3DV4 - SN:3935**

Calibration procedure(s): **QA CAL-01.v9, QA CAL-14.v4, QA CAL-23.v5, QA CAL-25.v6  
Calibration procedure for dosimetric E-field probes**

Calibration date: **November 28, 2016**

This calibration certificate documents the traceability to national standards, which realize the physical units of measurements (SI).  
The measurements and the uncertainties with confidence probability are given on the following pages and are part of the certificate.

All calibrations have been conducted in the closed laboratory facility: environment temperature (22 ± 3)°C and humidity < 70%.

Calibration Equipment used (M&TE critical for calibration)

Primary Standards	ID	Cal Date (Certificate No.)	Scheduled Calibration
Power meter NRP	SN: 104778	06-Apr-16 (No. 217-02288/02289)	Apr-17
Power sensor NRP-Z91	SN: 103244	06-Apr-16 (No. 217-02288)	Apr-17
Power sensor NRP-Z91	SN: 103245	06-Apr-16 (No. 217-02289)	Apr-17
Reference 20 dB Attenuator	SN: S5277 (20x)	05-Apr-16 (No. 217-02293)	Apr-17
Reference Probe ES3DV2	SN: 3013	31-Dec-15 (No. ES3-3013_Dec15)	Dec-16
DAE4	SN: 660	23-Dec-15 (No. DAE4-660_Dec15)	Dec-16
Secondary Standards	ID	Check Date (in house)	Scheduled Check
Power meter E4419B	SN: GB41293874	06-Apr-16 (in house check Jun-16)	In house check: Jun-18
Power sensor E4412A	SN: MY41498087	06-Apr-16 (in house check Jun-16)	In house check: Jun-18
Power sensor E4412A	SN: 000110210	06-Apr-16 (in house check Jun-16)	In house check: Jun-18
RF generator HP 8648C	SN: US3642U01700	04-Aug-99 (in house check Jun-16)	In house check: Jun-18
Network Analyzer HP 8753E	SN: US37390585	18-Oct-01 (in house check Oct-16)	In house check: Oct-17

Calibrated by:	Name <b>Leif Klysner</b>	Function <b>Laboratory Technician</b>	Signature 
Approved by:	Name <b>Katja Pokovic</b>	Function <b>Technical Manager</b>	Signature 

Issued: November 28, 2016

This calibration certificate shall not be reproduced except in full without written approval of the laboratory.



Accredited by the Swiss Accreditation Service (SAS)

Accreditation No.: **SCS 0108**

The Swiss Accreditation Service is one of the signatories to the EA  
Multilateral Agreement for the recognition of calibration certificates

### Glossary:

TSL	tissue simulating liquid
NORM <sub>x,y,z</sub>	sensitivity in free space
ConvF	sensitivity in TSL / NORM <sub>x,y,z</sub>
DCP	diode compression point
CF	crest factor (1/duty_cycle) of the RF signal
A, B, C, D	modulation dependent linearization parameters
Polarization $\varphi$	$\varphi$ rotation around probe axis
Polarization $\vartheta$	$\vartheta$ rotation around an axis that is in the plane normal to probe axis (at measurement center), i.e., $\vartheta = 0$ is normal to probe axis
Connector Angle	information used in DASY system to align probe sensor X to the robot coordinate system

### Calibration is Performed According to the Following Standards:

- IEEE Std 1528-2013, "IEEE Recommended Practice for Determining the Peak Spatial-Averaged Specific Absorption Rate (SAR) in the Human Head from Wireless Communications Devices: Measurement Techniques", June 2013
- IEC 62209-1, "Procedure to measure the Specific Absorption Rate (SAR) for hand-held devices used in close proximity to the ear (frequency range of 300 MHz to 3 GHz)", February 2005
- IEC 62209-2, "Procedure to determine the Specific Absorption Rate (SAR) for wireless communication devices used in close proximity to the human body (frequency range of 30 MHz to 6 GHz)", March 2010
- KDB 865664, "SAR Measurement Requirements for 100 MHz to 6 GHz"

### Methods Applied and Interpretation of Parameters:

- NORM<sub>x,y,z</sub>**: Assessed for E-field polarization  $\vartheta = 0$  ( $f \leq 900$  MHz in TEM-cell;  $f > 1800$  MHz: R22 waveguide). NORM<sub>x,y,z</sub> are only intermediate values, i.e., the uncertainties of NORM<sub>x,y,z</sub> does not affect the E<sup>2</sup>-field uncertainty inside TSL (see below ConvF).
- NORM(f)<sub>x,y,z</sub>** = NORM<sub>x,y,z</sub> \* frequency\_response (see Frequency Response Chart). This linearization is implemented in DASY4 software versions later than 4.2. The uncertainty of the frequency response is included in the stated uncertainty of ConvF.
- DCP<sub>x,y,z</sub>**: DCP are numerical linearization parameters assessed based on the data of power sweep with CW signal (no uncertainty required). DCP does not depend on frequency nor media.
- PAR**: PAR is the Peak to Average Ratio that is not calibrated but determined based on the signal characteristics
- A<sub>x,y,z</sub>; B<sub>x,y,z</sub>; C<sub>x,y,z</sub>; D<sub>x,y,z</sub>; VR<sub>x,y,z</sub>**: A, B, C, D are numerical linearization parameters assessed based on the data of power sweep for specific modulation signal. The parameters do not depend on frequency nor media. VR is the maximum calibration range expressed in RMS voltage across the diode.
- ConvF and Boundary Effect Parameters**: Assessed in flat phantom using E-field (or Temperature Transfer Standard for  $f \leq 800$  MHz) and inside waveguide using analytical field distributions based on power measurements for  $f > 800$  MHz. The same setups are used for assessment of the parameters applied for boundary compensation (alpha, depth) of which typical uncertainty values are given. These parameters are used in DASY4 software to improve probe accuracy close to the boundary. The sensitivity in TSL corresponds to NORM<sub>x,y,z</sub> \* ConvF whereby the uncertainty corresponds to that given for ConvF. A frequency dependent ConvF is used in DASY version 4.4 and higher which allows extending the validity from  $\pm 50$  MHz to  $\pm 100$  MHz.
- Spherical isotropy (3D deviation from isotropy)**: in a field of low gradients realized using a flat phantom exposed by a patch antenna.
- Sensor Offset**: The sensor offset corresponds to the offset of virtual measurement center from the probe tip (on probe axis). No tolerance required.
- Connector Angle**: The angle is assessed using the information gained by determining the NORM<sub>x</sub> (no uncertainty required).

# Probe EX3DV4

## SN:3935

Manufactured: July 24, 2013  
Calibrated: November 28, 2016

**Calibrated for DASY/EASY Systems**  
(Note: non-compatible with DASY2 system!)

## DASY/EASY - Parameters of Probe: EX3DV4 - SN:3935

### Basic Calibration Parameters

	Sensor X	Sensor Y	Sensor Z	Unc (k=2)
Norm ( $\mu\text{V}/(\text{V}/\text{m})^2$ ) <sup>A</sup>	0.48	0.52	0.47	$\pm 10.1 \%$
DCP (mV) <sup>B</sup>	103.3	100.8	106.1	

### Modulation Calibration Parameters

UID	Communication System Name		A dB	B dB $\sqrt{\mu\text{V}}$	C	D dB	VR mV	Unc <sup>E</sup> (k=2)
0	CW	X	0.0	0.0	1.0	0.00	134.4	$\pm 3.5 \%$
		Y	0.0	0.0	1.0		144.8	
		Z	0.0	0.0	1.0		133.6	

The reported uncertainty of measurement is stated as the standard uncertainty of measurement multiplied by the coverage factor k=2, which for a normal distribution corresponds to a coverage probability of approximately 95%.

<sup>A</sup> The uncertainties of Norm X,Y,Z do not affect the E<sup>2</sup>-field uncertainty inside TSL (see Pages 5 and 6).

<sup>B</sup> Numerical linearization parameter: uncertainty not required.

<sup>E</sup> Uncertainty is determined using the max. deviation from linear response applying rectangular distribution and is expressed for the square of the field value.

## DASY/EASY - Parameters of Probe: EX3DV4 - SN:3935

### Calibration Parameter Determined in Head Tissue Simulating Media

f (MHz) <sup>C</sup>	Relative Permittivity <sup>F</sup>	Conductivity (S/m) <sup>F</sup>	ConvF X	ConvF Y	ConvF Z	Alpha <sup>G</sup>	Depth <sup>G</sup> (mm)	Unc (k=2)
750	41.9	0.89	10.92	10.92	10.92	0.41	1.07	± 12.0 %
835	41.5	0.90	10.61	10.61	10.61	0.24	1.49	± 12.0 %
900	41.5	0.97	10.52	10.52	10.52	0.23	1.56	± 12.0 %
1750	40.1	1.37	9.03	9.03	9.03	0.38	0.80	± 12.0 %
1900	40.0	1.40	8.64	8.64	8.64	0.38	0.80	± 12.0 %
2000	40.0	1.40	8.48	8.48	8.48	0.37	0.80	± 12.0 %
2300	39.5	1.67	8.18	8.18	8.18	0.38	0.81	± 12.0 %
2450	39.2	1.80	7.81	7.81	7.81	0.28	1.00	± 12.0 %
2600	39.0	1.96	7.60	7.60	7.60	0.36	0.80	± 12.0 %
3500	37.9	2.91	7.37	7.37	7.37	0.26	1.20	± 13.1 %
5250	35.9	4.71	5.32	5.32	5.32	0.35	1.80	± 13.1 %
5600	35.5	5.07	4.84	4.84	4.84	0.40	1.80	± 13.1 %
5750	35.4	5.22	4.78	4.78	4.78	0.40	1.80	± 13.1 %

<sup>C</sup> Frequency validity above 300 MHz of ± 100 MHz only applies for DASY v4.4 and higher (see Page 2), else it is restricted to ± 50 MHz. The uncertainty is the RSS of the ConvF uncertainty at calibration frequency and the uncertainty for the indicated frequency band. Frequency validity below 300 MHz is ± 10, 25, 40, 50 and 70 MHz for ConvF assessments at 30, 64, 128, 150 and 220 MHz respectively. Above 5 GHz frequency validity can be extended to ± 110 MHz.

<sup>F</sup> At frequencies below 3 GHz, the validity of tissue parameters ( $\epsilon$  and  $\sigma$ ) can be relaxed to ± 10% if liquid compensation formula is applied to measured SAR values. At frequencies above 3 GHz, the validity of tissue parameters ( $\epsilon$  and  $\sigma$ ) is restricted to ± 5%. The uncertainty is the RSS of the ConvF uncertainty for indicated target tissue parameters.

<sup>G</sup> Alpha/Depth are determined during calibration. SPEAG warrants that the remaining deviation due to the boundary effect after compensation is always less than ± 1% for frequencies below 3 GHz and below ± 2% for frequencies between 3-6 GHz at any distance larger than half the probe diameter from the boundary.

## DASY/EASY - Parameters of Probe: EX3DV4 - SN:3935

### Calibration Parameter Determined in Body Tissue Simulating Media

f (MHz) <sup>C</sup>	Relative Permittivity <sup>F</sup>	Conductivity (S/m) <sup>F</sup>	ConvF X	ConvF Y	ConvF Z	Alpha <sup>G</sup>	Depth <sup>G</sup> (mm)	Unc (k=2)
750	55.5	0.96	10.68	10.68	10.68	0.44	0.85	± 12.0 %
835	55.2	0.97	10.48	10.48	10.48	0.41	0.80	± 12.0 %
1750	53.4	1.49	8.46	8.46	8.46	0.45	0.80	± 12.0 %
1900	53.3	1.52	8.18	8.18	8.18	0.45	0.80	± 12.0 %
2300	52.9	1.81	7.99	7.99	7.99	0.41	0.80	± 12.0 %
2450	52.7	1.95	7.89	7.89	7.89	0.39	0.80	± 12.0 %
2600	52.5	2.16	7.67	7.67	7.67	0.36	0.80	± 12.0 %
3500	51.3	3.31	7.13	7.13	7.13	0.26	1.20	± 13.1 %
5250	48.9	5.36	4.84	4.84	4.84	0.35	1.90	± 13.1 %
5600	48.5	5.77	4.00	4.00	4.00	0.50	1.90	± 13.1 %
5750	48.3	5.94	4.23	4.23	4.23	0.50	1.90	± 13.1 %

<sup>C</sup> Frequency validity above 300 MHz of ± 100 MHz only applies for DASY v4.4 and higher (see Page 2), else it is restricted to ± 50 MHz. The uncertainty is the RSS of the ConvF uncertainty at calibration frequency and the uncertainty for the indicated frequency band. Frequency validity below 300 MHz is ± 10, 25, 40, 50 and 70 MHz for ConvF assessments at 30, 64, 128, 150 and 220 MHz respectively. Above 5 GHz frequency validity can be extended to ± 110 MHz.

<sup>F</sup> At frequencies below 3 GHz, the validity of tissue parameters ( $\epsilon$  and  $\sigma$ ) can be relaxed to ± 10% if liquid compensation formula is applied to measured SAR values. At frequencies above 3 GHz, the validity of tissue parameters ( $\epsilon$  and  $\sigma$ ) is restricted to ± 5%. The uncertainty is the RSS of the ConvF uncertainty for indicated target tissue parameters.

<sup>G</sup> Alpha/Depth are determined during calibration. SPEAG warrants that the remaining deviation due to the boundary effect after compensation is always less than ± 1% for frequencies below 3 GHz and below ± 2% for frequencies between 3-6 GHz at any distance larger than half the probe tip diameter from the boundary.



### Frequency Response of E-Field (TEM-Cell:ifi110 EXX, Waveguide: R22)

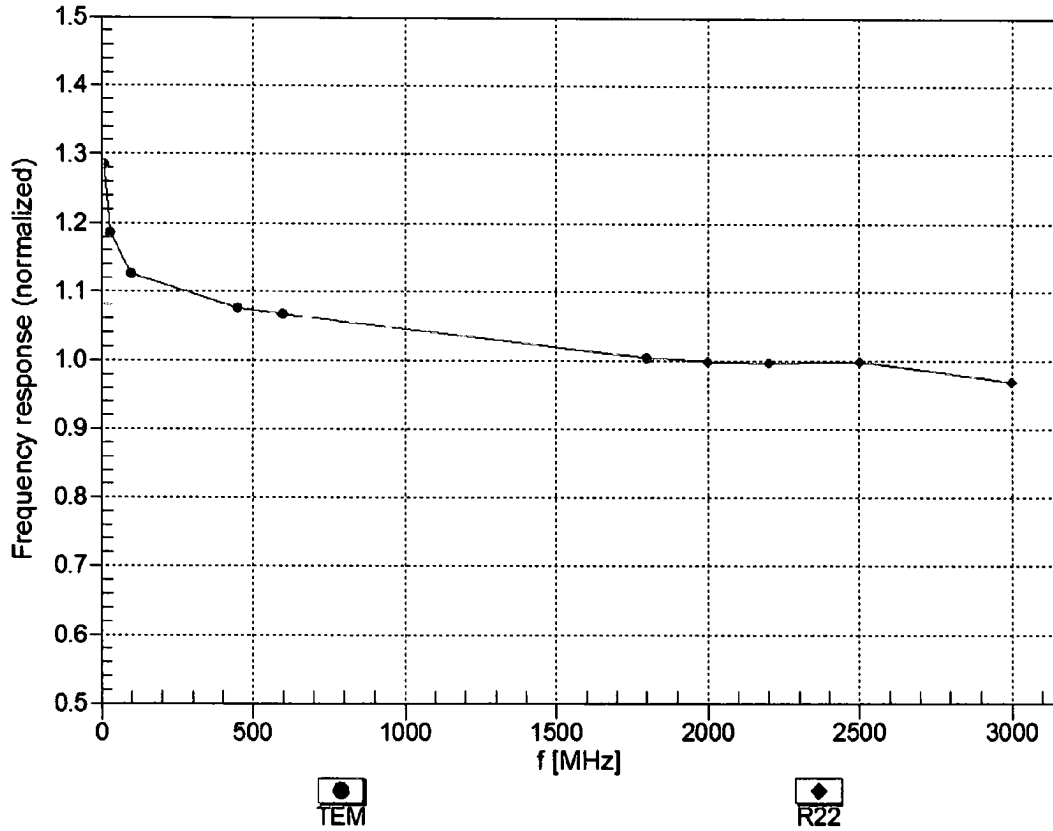

Uncertainty of Frequency Response of E-field:  $\pm 6.3\%$  (k=2)

### Receiving Pattern ( $\phi$ ), $\vartheta = 0^\circ$

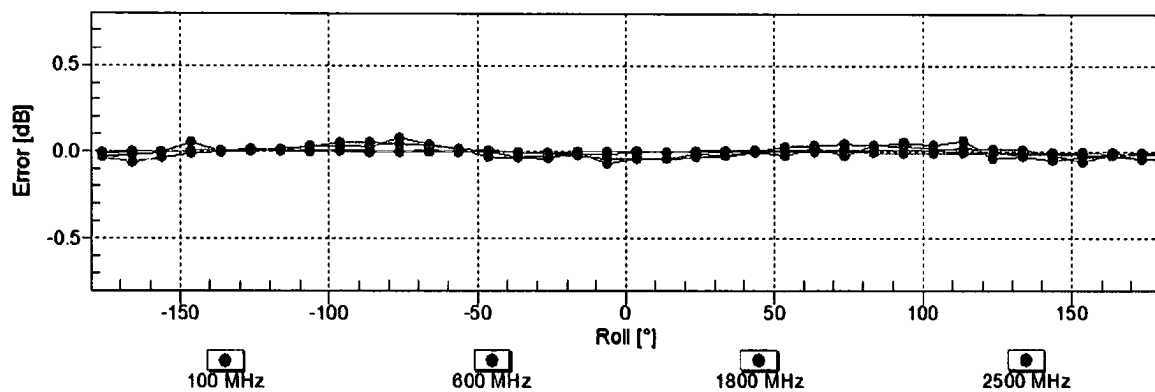
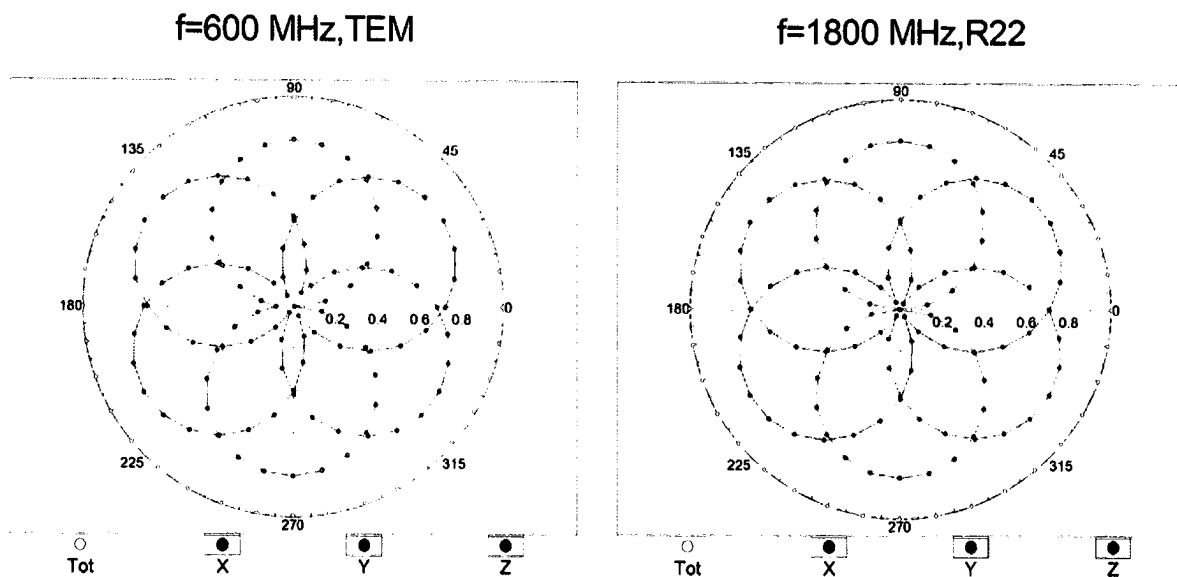

Uncertainty of Axial Isotropy Assessment:  $\pm 0.5\%$  ( $k=2$ )

## Dynamic Range $f(\text{SAR}_{\text{head}})$ (TEM cell , $f_{\text{eval}} = 1900 \text{ MHz}$ )

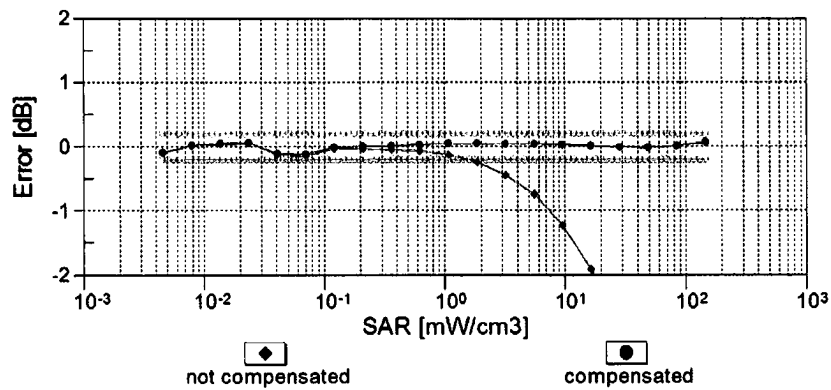
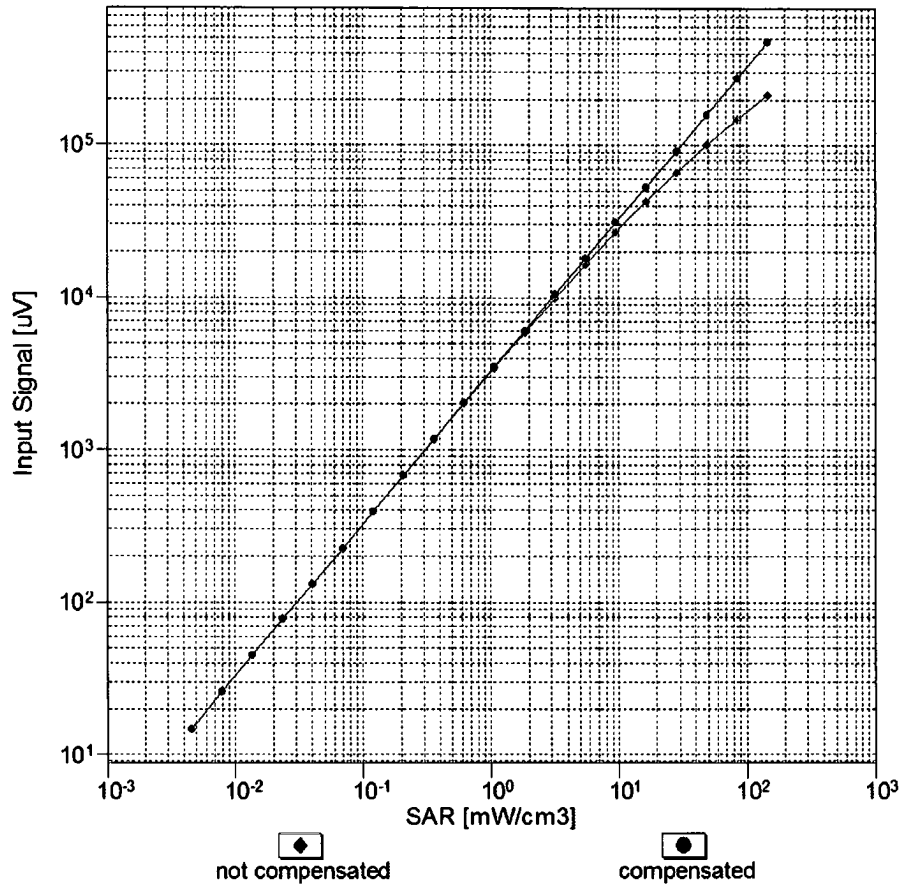

**Uncertainty of Linearity Assessment:  $\pm 0.6\%$  ( $k=2$ )**

# Conversion Factor Assessment

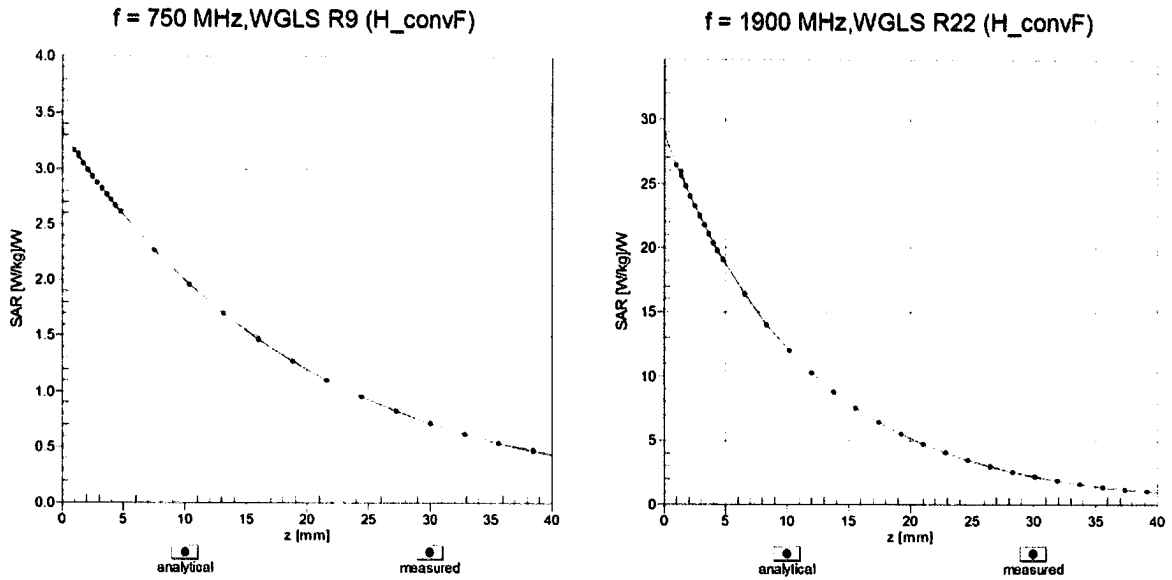

## Deviation from Isotropy in Liquid Error ( $\phi, \theta$ ), f = 900 MHz

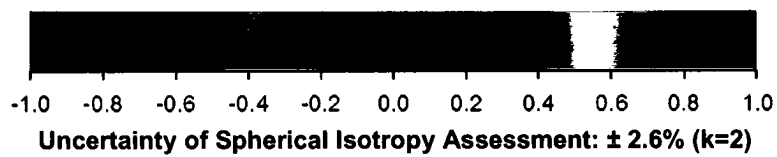
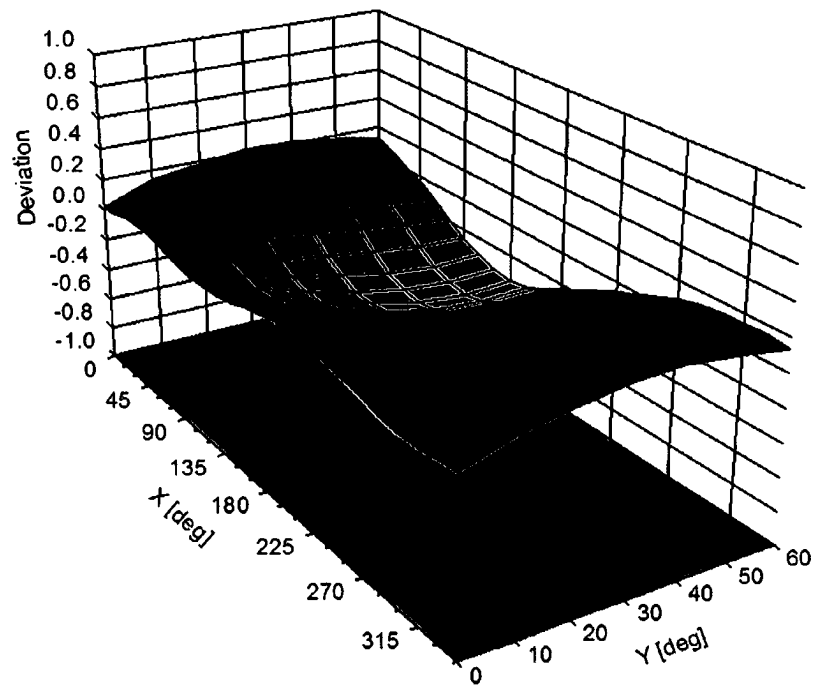

## DASY/EASY - Parameters of Probe: EX3DV4 - SN:3935

### Other Probe Parameters

Sensor Arrangement	Triangular
Connector Angle (°)	43.7
Mechanical Surface Detection Mode	enabled
Optical Surface Detection Mode	disabled
Probe Overall Length	337 mm
Probe Body Diameter	10 mm
Tip Length	9 mm
Tip Diameter	2.5 mm
Probe Tip to Sensor X Calibration Point	1 mm
Probe Tip to Sensor Y Calibration Point	1 mm
Probe Tip to Sensor Z Calibration Point	1 mm
Recommended Measurement Distance from Surface	1.4 mm