



RF TEST REPORT

Applicant ZTE Corporation
FCC ID SRQ-Z7540
Product 5G NR Multi-Mode Digital Mobile Phone
Model Z7540
Report No. R2202A0144-R6
Issue Date March 12, 2022

TA Technology (Shanghai) Co., Ltd. tested the above equipment in accordance with the requirements in **FCC CFR47 Part 15E (2021)**. The test results show that the equipment tested is capable of demonstrating compliance with the requirements as documented in this report.

Prepared by: Peng Tao

Approved by: Kai Xu

TA Technology (Shanghai) Co., Ltd.

No.145, Jintang Rd, Tangzhen Industry Park, Pudong Shanghai, China

TEL: +86-021-50791141/2/3

FAX: +86-021-50791141/2/3-8000



TABLE OF CONTENT

1. Test Laboratory	4
1.1. Notes of the test report.....	4
1.2. Test facility	4
1.3. Testing Location.....	4
2. General Description of Equipment under Test.....	5
2.1. Applicant and Manufacturer Information.....	5
2.2. General information.....	5
3. Applied Standards	7
4. Test Configuration	8
5. Test Case Results	10
5.1. Occupied Bandwidth	10
5.2. Average Power Output.....	21
5.3. Frequency Stability.....	25
5.4. Power Spectral Density.....	28
5.5. Unwanted Emission	36
5.6. Conducted Emission	84
6. Main Test Instruments.....	87
ANNEX A: The EUT Appearance	88
ANNEX B: Test Setup Photos	89



Summary of measurement results

Number	Test Case	Clause in FCC rules	Verdict
1	Average output power	15.407(a)	PASS
2	Occupied bandwidth	15.407(e)	PASS
3	Frequency stability	15.407(g)	PASS
4	Power spectral density	15.407(a)	PASS
5	Unwanted Emissions	15.407(b)	PASS
6	Conducted Emissions	15.207	PASS

Date of Testing: March 1, 2022 ~ March 9, 2022
Date of Sample Received: February 14, 2022

Note: PASS: The EUT complies with the essential requirements in the standard.
FAIL: The EUT does not comply with the essential requirements in the standard.
All indications of Pass/Fail in this report are opinions expressed by TA Technology (Shanghai) Co., Ltd. based on interpretations and/or observations of test results. Measurement Uncertainties were not taken into account and are published for informational purposes only.



1. Test Laboratory

1.1. Notes of the test report

This report shall not be reproduced in full or partial, without the written approval of **TA technology (shanghai) co., Ltd.** The results documented in this report apply only to the tested sample, under the conditions and modes of operation as described herein. Measurement Uncertainties were not taken into account and are published for informational purposes only. This report is written to support regulatory compliance of the applicable standards stated above.

1.2. Test facility

FCC (Designation number: CN1179, Test Firm Registration Number: 446626)

TA Technology (Shanghai) Co., Ltd. has been listed on the US Federal Communications Commission list of test facilities recognized to perform electromagnetic emissions measurements.

A2LA (Certificate Number: 3857.01)

TA Technology (Shanghai) Co., Ltd. has been listed by American Association for Laboratory Accreditation to perform electromagnetic emission measurement.

1.3. Testing Location

Company: TA Technology (Shanghai) Co., Ltd.
Address: No.145, Jintang Rd, Tangzhen Industry Park, Pudong
City: Shanghai
Post code: 201201
Country: P. R. China
Contact: Xu Kai
Telephone: +86-021-50791141/2/3
Fax: +86-021-50791141/2/3-8000
Website: <http://www.ta-shanghai.com>
E-mail: xukai@ta-shanghai.com

2. General Description of Equipment under Test

2.1. Applicant and Manufacturer Information

Applicant	ZTE Corporation
Applicant address	ZTE Plaza, Keji Road South, Hi-Tech, Industrial Park, Nanshan District, Shenzhen, Guangdong, 518057, P.R.China
Manufacturer	ZTE Corporation
Manufacturer address	ZTE Plaza, Keji Road South, Hi-Tech, Industrial Park, Nanshan District, Shenzhen, Guangdong, 518057, P.R.China

2.2. General information

EUT Description	
Model	Z7540
IMEI	866787060002008
Hardware Version	Z7540HW1.0
Software Version	Z7540_CC1.0.0B02
Power Supply	Battery / AC adapter
Antenna Type	FPC Antenna
Antenna Gain	1.96dBi
Operating Frequency Range(s)	U-NII-1: 5150MHz-5250MHz U-NII-3: 5725MHz -5850MHz
Modulation Type	802.11a/n (HT20/HT40) : OFDM 802.11ac (VHT20/VHT40/VHT80): OFDM
Max. Conducted Power	15.39 dBm
Testing temperature range:	-20 ° C to 50° C
Operating temperature range:	-10 ° C to 60° C
Operating voltage range:	3.4V to 4.4V
State DC voltage:	3.85V
EUT Accessory	
Adapter 1	Manufacturer: Shenzhen Ruijing Industrial Co Ltd Model: STC-A51030A2-Z
Adapter 2	Manufacturer: Jiangsu Chenyang Electron Co., Ltd. Model: STC-A51030A2-Z
Battery	Manufacturer: SCUD (Fujian) Electronics Co., LTD. Model: Li3949T44P8h906450
USB Cable 1	Manufacturer: kingpower-tech Model: USB-TC20-W-100-M-L-HF



USB Cable 2	Manufacturer: Shenzhen Luxshare Precision Industry Co.,Ltd. Model: USB-TC20-W-100-M-L-HF
<p>Note: 1. The EUT is sent from the applicant to TA and the information of the EUT is declared by the applicant.</p> <p>2. This device support automatically discontinue transmission, while the device is not transmitting any information, the device can automatically discontinue transmission and become standby mode for power saving. The device can detect the controlling signal of ACK message transmitting from remote device and verify whether it shall resend or discontinue transmission.</p> <p>2. There is more than one Adapter / USB cable, each one should be applied throughout the compliance test respectively, and however, only the worst case (Adapter 1 / USB Cable 2) will be recorded in this report.</p>	



3. Applied Standards

According to the specifications of the manufacturer, it must comply with the requirements of the following standards:

Test standards:

FCC CFR47 Part 15E (2021) Unlicensed National Information Infrastructure Devices

ANSI C63.10 (2013)

Reference standard:

KDB 789033 D02 General UNII Test Procedures New Rules v02r01

4. Test Configuration

Test Mode

The EUT has been associated with peripherals and configuration operated in a manner tended to maximize its emission characteristics in a typical application.

The radiated emission was measured in the following position: EUT stand-up position (Z axis), lie-down position (X, Y axis). The worst emission was found in stand-up position (Z axis) and the worst case was recorded.

In order to find the worst case condition, Pre-tests are needed at the presence of different data rate. Preliminary tests have been done on all the configuration for confirming worst case. Data rate below means worst-case rate of each test item.

Worst-case data rates are shown as following table.

Mode	Data Rate
802.11a	6 Mbps
802.11n HT20	MCS0
802.11n HT40	MCS0
802.11ac VHT20	MCS0
802.11ac VHT40	MCS0
802.11ac VHT80	MCS0

**Wireless Technology and Frequency Range**

Wireless Technology		Bandwidth	Channel	Frequency
Wi-Fi	U-NII-1	20 MHz	36	5180MHz
			40	5200MHz
			44	5220MHz
			48	5240MHz
		40 MHz	38	5190MHz
			46	5230MHz
	U-NII-3	20 MHz	42	5210MHz
			149	5745MHz
			153	5765MHz
			157	5785MHz
			161	5805MHz
			165	5825MHz
		40 MHz	151	5755MHz
			159	5795MHz
80 MHz	155	5775MHz		

Does this device support TPC Function? Yes No

5. Test Case Results

5.1. Occupied Bandwidth

Ambient condition

Temperature	Relative humidity	Pressure
23°C ~25°C	45%~50%	101.5kPa

Method of Measurement

The EUT was connected to the spectrum analyzer through an external attenuator (20dB) and a known loss cable.

For U-NII-1, set RBW \approx 1% OCB kHz, VBW \geq 3 \times RBW, measure the maximum width of the emission that is constrained by the frequencies associated with the two outermost amplitude points (upper and lower frequencies) that are attenuated by 26 dB relative to the maximum level measured in the fundamental emission.

For U-NII-3, Set RBW = 100 kHz, VBW \geq 3 \times RBW, measure the maximum width of the emission that is constrained by the frequencies associated with the two outermost amplitude points (upper and lower frequencies) that are attenuated by 6 dB relative to the maximum level measured in the fundamental emission.

Note: The automatic bandwidth measurement capability of a spectrum analyzer or EMI receiver may be employed if it implements the functionality described above.

Use the 99 % power bandwidth function of the instrument

Test Setup

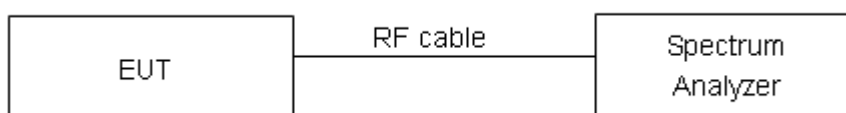

Limits

Rule FCC Part §15.407(e)

Within the 5.725-5.85 GHz band, the minimum 6 dB bandwidth of U-NII devices shall be at least 500 kHz.

Measurement Uncertainty

The assessed measurement uncertainty to ensure 95% confidence level for the normal distribution is with the coverage factor $k = 2$, $U = 936$ Hz.

**Test Results:****U-NII-1**

Mode	Carrier frequency (MHz)	99% bandwidth (MHz)	Minimum 26 dB bandwidth (MHz)	Conclusion
802.11a	5180	16.38	19.87	PASS
	5200	16.39	19.49	PASS
	5240	16.38	19.73	PASS
802.11n HT20	5180	17.55	19.85	PASS
	5200	17.56	19.96	PASS
	5240	17.56	19.99	PASS
802.11n HT40	5190	35.97	41.19	PASS
	5230	35.98	40.82	PASS
802.11ac VHT20	5180	17.54	19.89	PASS
	5200	17.54	19.93	PASS
	5240	17.55	20.00	PASS
802.11ac VHT40	5190	35.87	40.28	PASS
	5230	35.95	39.89	PASS
802.11ac VHT80	5210	75.14	80.28	PASS

U-NII-3

Mode	Carrier frequency (MHz)	99% bandwidth (MHz)	Minimum 6 dB bandwidth (MHz)	Limit (kHz)	Conclusion
802.11a	5745	16.43	15.75	500	PASS
	5785	16.39	15.63	500	PASS
	5825	16.40	14.94	500	PASS
802.11n HT20	5745	17.56	15.03	500	PASS
	5785	17.53	15.02	500	PASS
	5825	17.55	13.87	500	PASS
802.11n HT40	5755	36.05	33.82	500	PASS
	5795	35.97	35.00	500	PASS
802.11ac VHT20	5745	17.51	14.44	500	PASS
	5785	17.56	16.25	500	PASS
	5825	17.54	15.01	500	PASS
802.11ac VHT40	5755	35.96	32.58	500	PASS
	5795	35.86	32.59	500	PASS
802.11ac VHT80	5775	75.20	75.11	500	PASS

U-NII-1, 802.11a
Carrier frequency (MHz): 5180



U-NII-1, 802.11n HT20
Carrier frequency (MHz): 5180



U-NII-1, 802.11a
Carrier frequency (MHz): 5200

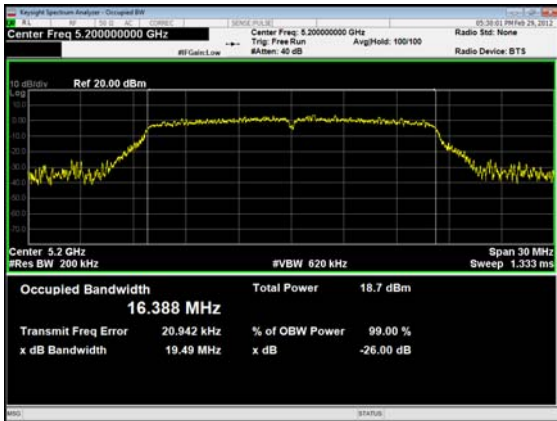

U-NII-1, 802.11n HT20
Carrier frequency (MHz): 5200

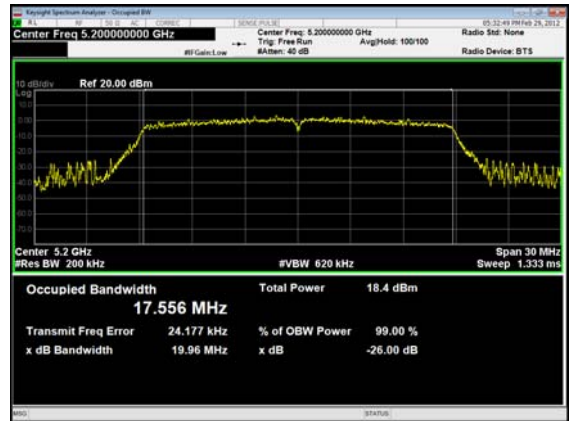

U-NII-1, 802.11a
Carrier frequency (MHz):5240

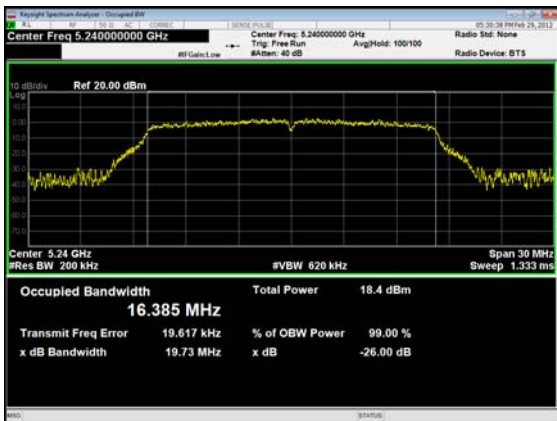

U-NII-1, 802.11n HT20
Carrier frequency (MHz):5240



U-NII-1, 802.11n HT40
Carrier frequency (MHz): 5190



U-NII-1, 802.11ac VHT20
Carrier frequency (MHz): 5180

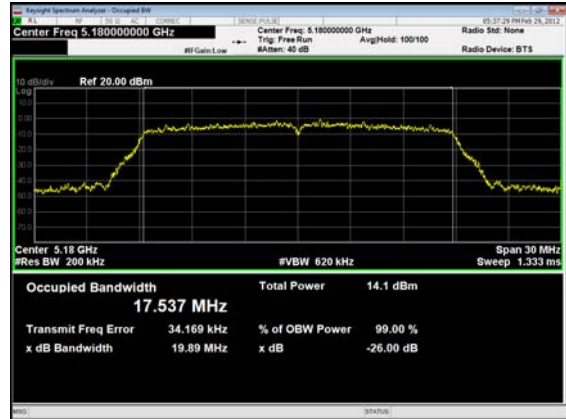

U-NII-1, 802.11n HT40
Carrier frequency (MHz): 5230

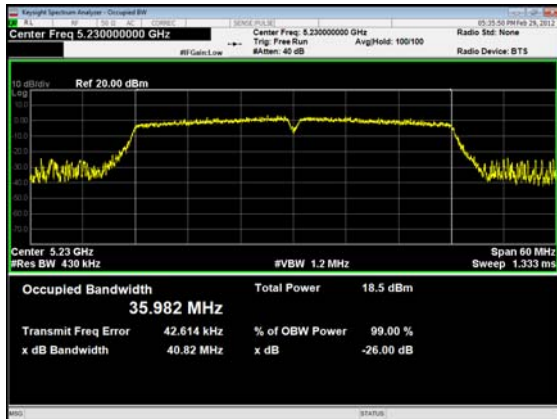

U-NII-1, 802.11ac VHT20
Carrier frequency (MHz): 5200



U-NII-1, 802.11ac VHT40
Carrier frequency (MHz): 5190

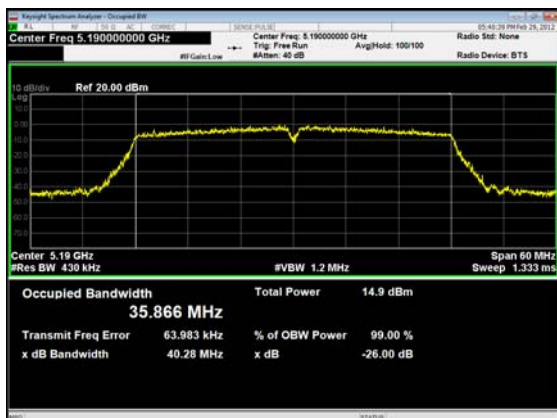

U-NII-1, 802.11ac VHT20
Carrier frequency (MHz): 5240



U-NII-1, 802.11ac VHT40
Carrier frequency (MHz): 5230



U-NII-1, 802.11ac VHT80
Carrier frequency (MHz): 5210

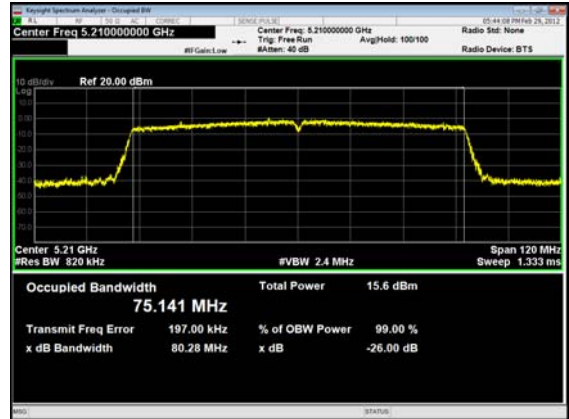



99% bandwidth

U-NII-3, 802.11a
Carrier frequency (MHz): 5745

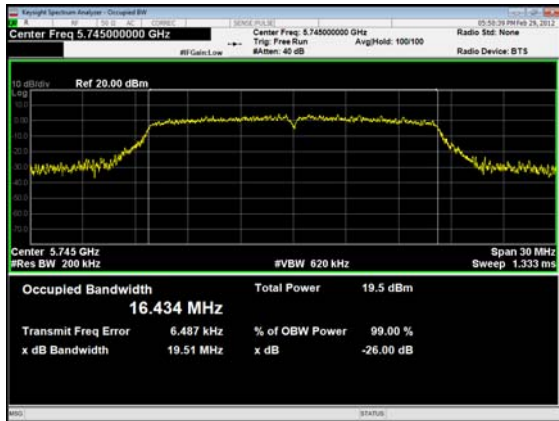

U-NII-3, 802.11n HT20
Carrier frequency (MHz): 5745

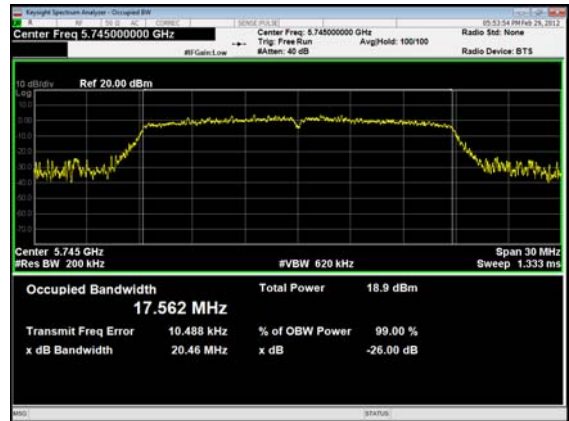

U-NII-3, 802.11a
Carrier frequency (MHz): 5785

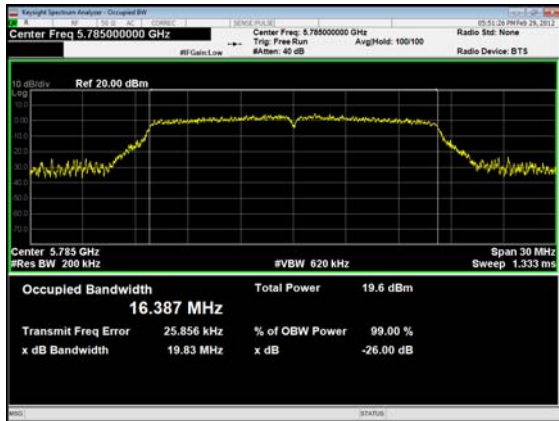

U-NII-3, 802.11n HT20
Carrier frequency (MHz): 5785

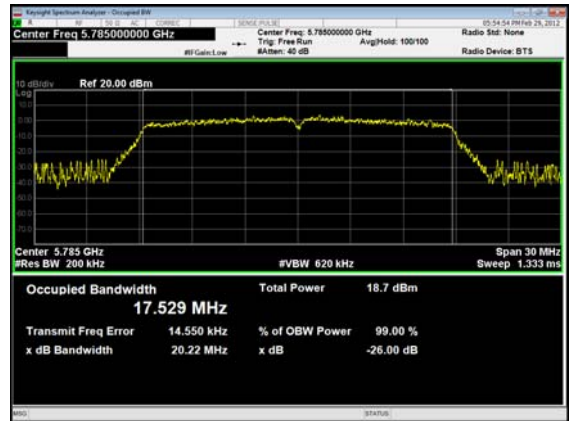

U-NII-3, 802.11a
Carrier frequency (MHz): 5825

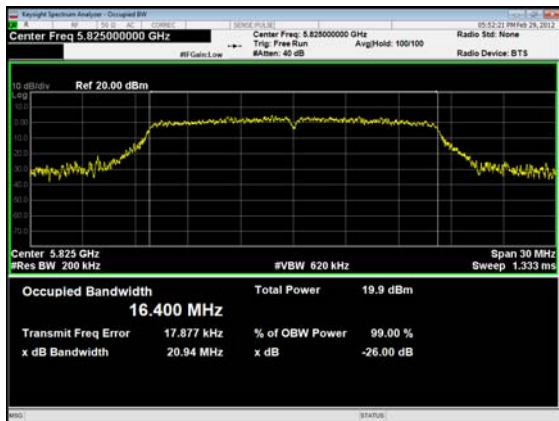

U-NII-3, 802.11n HT20
Carrier frequency (MHz): 5825

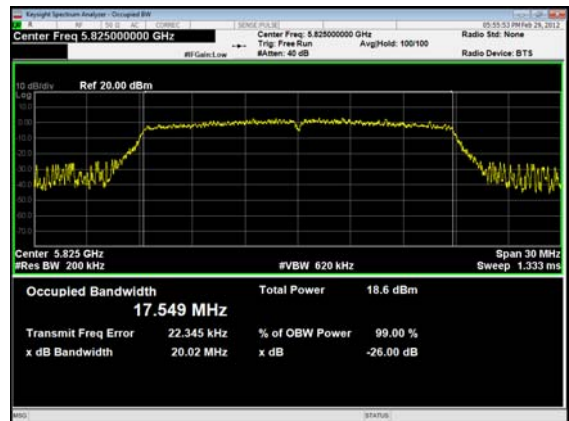

U-NII-3, 802.11n HT40
Carrier frequency (MHz): 5755

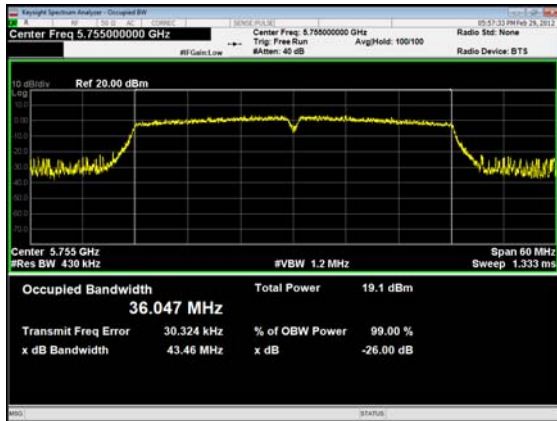

U-NII-3, 802.11ac VHT20
Carrier frequency (MHz): 5745

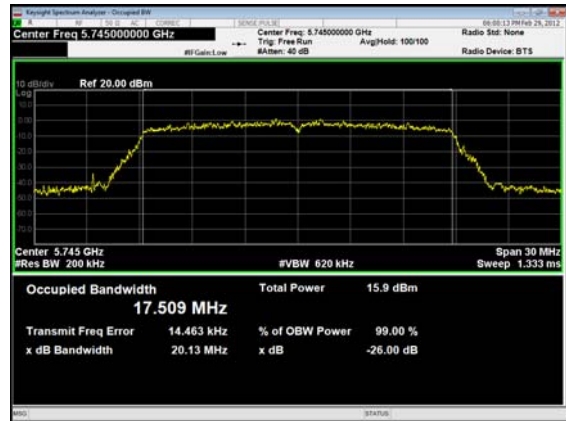

U-NII-3, 802.11n HT40
Carrier frequency (MHz): 5795

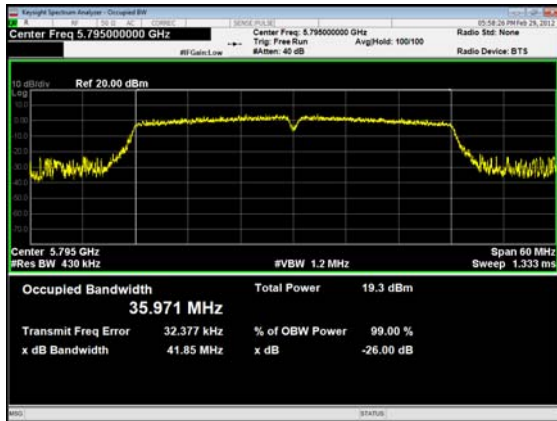

U-NII-3, 802.11ac VHT20
Carrier frequency (MHz): 5785

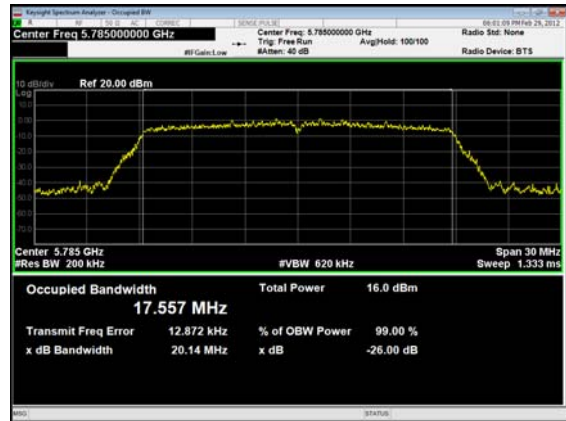

U-NII-3, 802.11ac VHT40
Carrier frequency (MHz): 5755



U-NII-3, 802.11ac VHT20
Carrier frequency (MHz): 5825



U-NII-3, 802.11ac VHT40
Carrier frequency (MHz): 5795

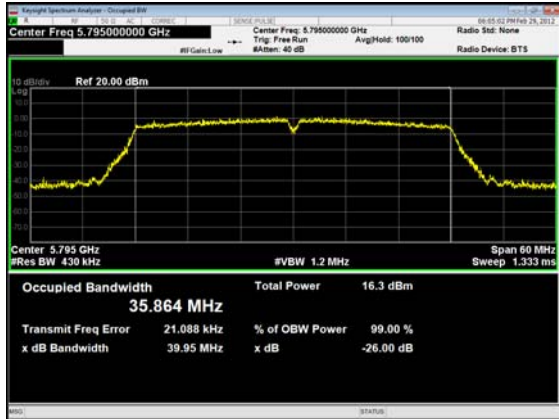

U-NII-3, 802.11ac VHT80
Carrier frequency (MHz): 5775

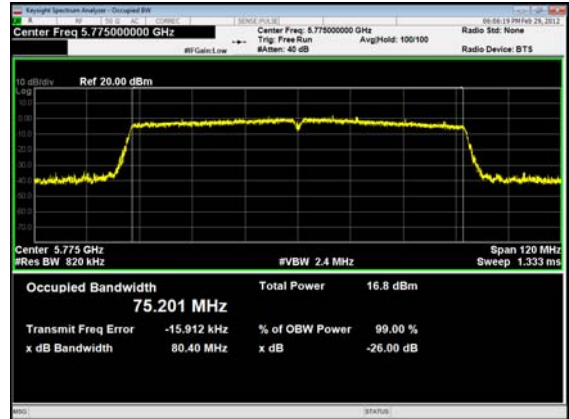



Minimum 6 dB bandwidth

U-NII-3, 802.11a
Carrier frequency (MHz): 5745



U-NII-3, 802.11n HT20
Carrier frequency (MHz): 5745



U-NII-3, 802.11a
Carrier frequency (MHz): 5785

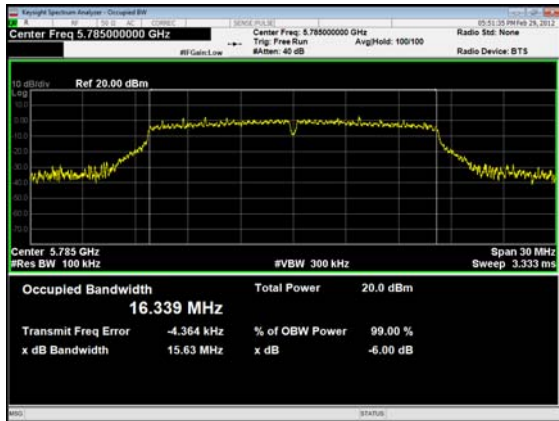

U-NII-3, 802.11n HT20
Carrier frequency (MHz): 5785



U-NII-3, 802.11a
Carrier frequency (MHz): 5825

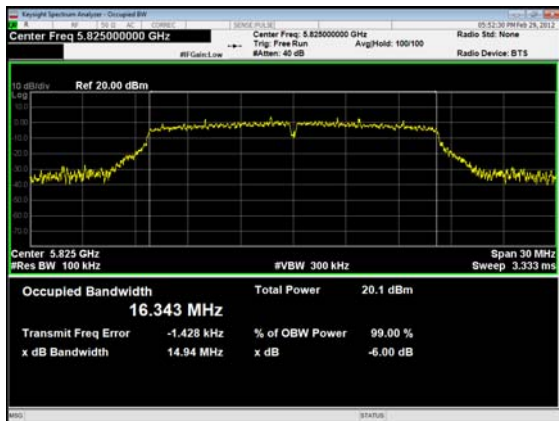

U-NII-3, 802.11n HT20
Carrier frequency (MHz): 5825

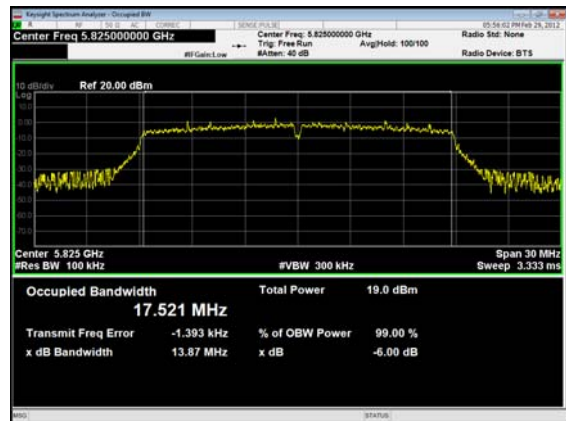

U-NII-3, 802.11n HT40
Carrier frequency (MHz): 5755



U-NII-3, 802.11ac VHT20
Carrier frequency (MHz): 5745

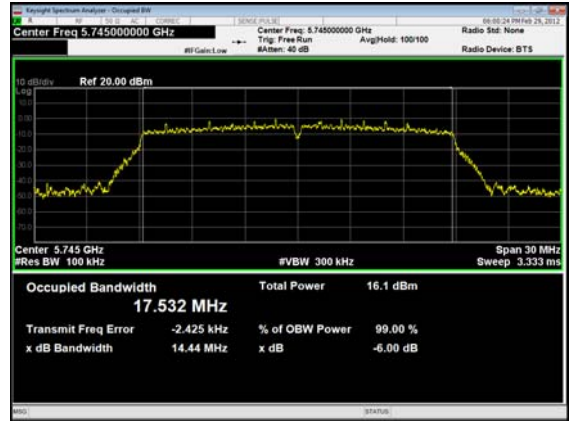

U-NII-3, 802.11n HT40
Carrier frequency (MHz): 5795

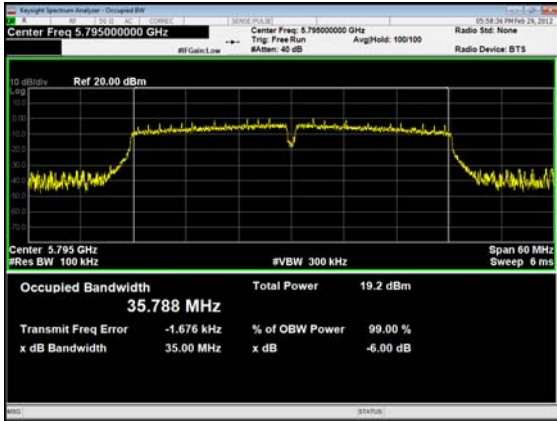

U-NII-3, 802.11ac VHT20
Carrier frequency (MHz): 5785



U-NII-3, 802.11ac VHT40
Carrier frequency (MHz): 5755

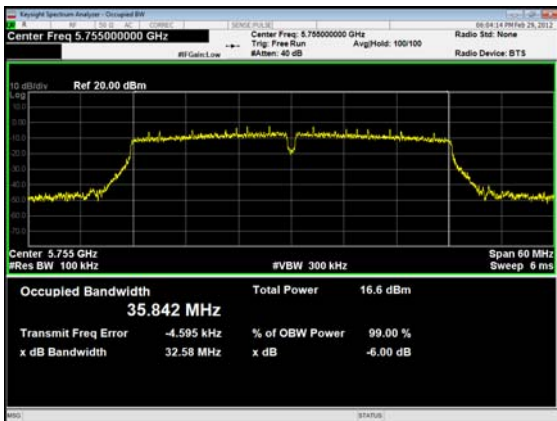

U-NII-3, 802.11ac VHT20
Carrier frequency (MHz): 5825



U-NII-3, 802.11ac VHT40
Carrier frequency (MHz): 5795



U-NII-3, 802.11ac VHT80
Carrier frequency (MHz): 5775

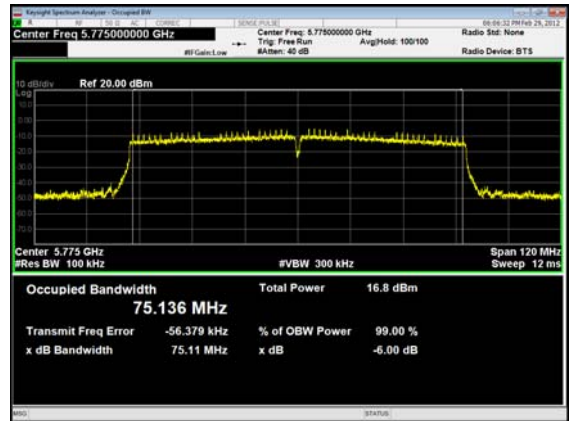

5.2. Average Power Output

Ambient condition

Temperature	Relative humidity	Pressure
23°C ~25°C	45%~50%	101.5kPa

Methods of Measurement

During the process of the testing, The EUT was connected to the average power meter through an external attenuator and a known loss cable. The EUT is max power transmission with proper modulation. We use Maximum average Conducted Output Power Level Method in KDB789033 for this test

Test Setup

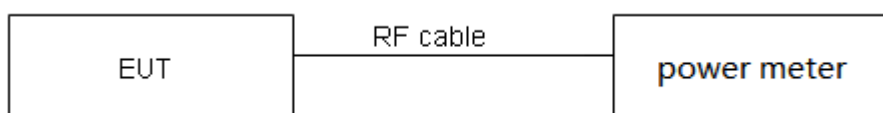

Limits

Rule FCC Part 15.407(a)(1) (3)

(1) For the band 5.15-5.25 GHz.

(i) For an outdoor access point operating in the band 5.15-5.25 GHz, the maximum conducted output power over the frequency band of operation shall not exceed 1 W provided the maximum antenna gain does not exceed 6 dBi. In addition, the maximum power spectral density shall not exceed 17 dBm in any 1 megahertz band. If transmitting antennas of directional gain greater than 6 dBi are used, both the maximum conducted output power and the maximum power spectral density shall be reduced by the amount in dB that the directional gain of the antenna exceeds 6 dBi. The maximum e.i.r.p. at any elevation angle above 30 degrees as measured from the horizon must not exceed 125 mW (21 dBm).

(ii) For an indoor access point operating in the band 5.15-5.25 GHz, the maximum conducted output power over the frequency band of operation shall not exceed 1 W provided the maximum antenna gain does not exceed 6 dBi. In addition, the maximum power spectral density shall not exceed 17 dBm in any 1 megahertz band. If transmitting antennas of directional gain greater than 6 dBi are used, both the maximum conducted output power and the maximum power spectral density shall be reduced by the amount in dB that the directional gain of the antenna exceeds 6 dBi.

(iii) For fixed point-to-point access points operating in the band 5.15-5.25 GHz, the maximum conducted output power over the frequency band of operation shall not exceed 1 W. In addition, the maximum power spectral density shall not exceed 17 dBm in any 1 megahertz band. Fixed point-to-point U-NII devices may employ antennas with directional gain up to 23 dBi without any corresponding reduction in the maximum conducted output power or maximum power spectral density. For fixed point-to-point transmitters that employ a directional antenna gain greater than 23 dBi, a 1 dB reduction in maximum conducted output power and maximum power spectral density is required for each 1 dB of antenna gain in excess of 23 dBi. Fixed, point-to-point operations exclude



the use of point-to-multipoint systems, omnidirectional applications, and multiple collocated transmitters transmitting the same information. The operator of the U-NII device, or if the equipment is professionally installed, the installer, is responsible for ensuring that systems employing high gain directional antennas are used exclusively for fixed, point-to-point operations.

(iv) For client devices in the 5.15-5.25 GHz band, the maximum conducted output power over the frequency band of operation shall not exceed 250 mW provided the maximum antenna gain does not exceed 6 dBi. In addition, the maximum power spectral density shall not exceed 11 dBm in any 1 megahertz band. If transmitting antennas of directional gain greater than 6 dBi are used, both the maximum conducted output power and the maximum power spectral density shall be reduced by the amount in dB that the directional gain of the antenna exceeds 6 dBi.

(3) For the band 5.725-5.85 GHz, the maximum conducted output power over the frequency band of operation shall not exceed 1 W. In addition, the maximum power spectral density shall not exceed 30 dBm in any 500-kHz band. If transmitting antennas of directional gain greater than 6 dBi are used, both the maximum conducted output power and the maximum power spectral density shall be reduced by the amount in dB that the directional gain of the antenna exceeds 6 dBi.

Measurement Uncertainty

The assessed measurement uncertainty to ensure 95% confidence level for the normal distribution is with the coverage factor $k = 2$, $U = 0.44$ dB.

Test Results

Mode	T _{on} (ms)	T _(on+off) (ms)	Duty cycle	Duty cycle correction Factor(dB)
802.11a	1.39	1.42	0.98	0.00
802.11n HT20	1.30	1.34	0.97	0.13
802.11n HT40	0.65	0.68	0.96	0.20
802.11ac VHT20	1.31	1.34	0.98	0.10
802.11ac VHT40	0.65	0.69	0.94	0.26
802.11ac VHT80	0.32	0.36	0.89	0.51

Note: when Duty cycle ≥ 0.98 , Duty cycle correction Factor not required.

Power Index								
Channel	802.11a	802.11n HT20	802.11ac VHT20	Channel	802.11n HT40	802.11ac VHT40	Channel	802.11ac VHT80
CH36	17	17	13	CH38	17	13	CH42	13
CH40	17	17	13	CH46	17	13	/	/
CH48	17	17	13	/	/	/	/	/
CH149	17	16	13	CH151	16	13	CH155	13
CH157	17	16	13	CH159	16	13	/	/
CH165	17	16	13	/	/	/	/	/



U-NII-1

Test Mode	Channel/ Frequency (MHz)	Average Power Measured (dBm)	Average Power with duty factor (dBm)	Limit (dBm)	Conclusion
802.11a	36/5180	14.20	14.20	24	PASS
	40/5200	14.18	14.18	24	PASS
	48/5240	14.41	14.41	24	PASS
802.11n HT20	36/5180	14.38	14.51	24	PASS
	40/5200	14.51	14.64	24	PASS
	48/5240	14.76	14.89	24	PASS
802.11n HT40	38/5190	14.36	14.56	24	PASS
	46/5230	14.50	14.70	24	PASS
802.11ac VHT20	36/5180	10.38	10.48	24	PASS
	40/5200	10.39	10.49	24	PASS
	48/5240	10.60	10.70	24	PASS
802.11ac VHT40	38/5190	9.98	10.24	24	PASS
	46/5230	10.07	10.33	24	PASS
802.11ac VHT80	42/5210	9.51	10.02	24	PASS

Note: Average Power with duty factor = Average Power Measured +Duty cycle correction factor

U-NII-3

Test Mode	Channel/ Frequency (MHz)	Average Power Measured (dBm)	Average Power with duty factor (dBm)	Limit (dBm)	Conclusion
802.11a	149/5745	15.21	15.21	30	PASS
	157/5785	15.38	15.38	30	PASS
	165/5825	15.39	15.39	30	PASS
802.11n HT20	149/5745	14.64	14.77	30	PASS
	157/5785	14.85	14.98	30	PASS
	165/5825	14.23	14.36	30	PASS
802.11n HT40	151/5755	14.46	14.66	30	PASS
	159/5795	14.67	14.87	30	PASS
802.11ac VHT20	149/5745	11.46	11.56	30	PASS
	157/5785	11.68	11.78	30	PASS
	165/5825	11.11	11.21	30	PASS
802.11ac VHT40	151/5755	11.40	11.66	30	PASS
	159/5795	11.56	11.82	30	PASS
802.11ac VHT80	155/5775	9.88	10.39	30	PASS

Note: Average Power with duty factor = Average Power Measured +Duty cycle correction factor

5.3. Frequency Stability

Ambient condition

Temperature	Relative humidity	Pressure
23°C ~25°C	45%~50%	101.5kPa

Method of Measurement

1. Frequency stability with respect to ambient temperature

a) Supply the EUT with a nominal ac voltage or install a new or fully charged battery in the EUT. If possible, a dummy load shall be connected to the EUT because an antenna near the metallic walls of an environmental test chamber could affect the output frequency of the EUT. If the EUT is equipped with a permanently attached, adjustable-length antenna, then the EUT shall be placed in the center of the chamber with the antenna adjusted to the shortest length possible. Turn ON the EUT and tune it to one of the number of frequencies shown in 5.6.

b) Couple the unlicensed wireless device output to the measuring instrument by connecting an antenna to the measuring instrument with a suitable length of coaxial cable and placing the measuring antenna near the EUT (e.g., 15 cm away), or by connecting a dummy load to the measuring instrument, through an attenuator if necessary.

c) Adjust the location of the measurement antenna and the controls on the measurement instrument to obtain a suitable signal level (i.e., a level that will not overload the measurement instrument but is strong enough to allow measurement of the operating or fundamental frequency of the EUT).

d) Turn the EUT OFF and place it inside the environmental temperature chamber. For devices that have oscillator heaters, energize only the heater circuit.

e) Set the temperature control on the chamber to the highest specified in the regulatory requirements for the type of device and allow the oscillator heater and the chamber temperature to stabilize.

f) While maintaining a constant temperature inside the environmental chamber, turn the EUT ON and record the operating frequency at startup, and at 2 minutes, 5 minutes, and 10 minutes after the EUT is energized. Four measurements in total are made.

g) Measure the frequency at each of frequencies specified in 5.6.

h) Switch OFF the EUT but do not switch OFF the oscillator heater.

i) Lower the chamber temperature by not more than 10°C, and allow the temperature inside the chamber to stabilize.

j) Repeat step f) through step i) down to the lowest specified temperature.

2. Frequency stability when varying supply voltage

Unless otherwise specified, these tests shall be made at ambient room temperature (+15°C to +25 °C). An antenna shall be connected to the antenna output terminals of the EUT if possible. If the EUT is equipped with or uses an adjustable-length antenna, then it shall be fully extended.

a) Supply the EUT with nominal voltage or install a new or fully charged battery in the EUT. Turn ON the EUT and couple its output to a frequency counter or other frequency-measuring instrument.



- b) Tune the EUT to one of the number of frequencies required in 5.6. Adjust the location of the measurement antenna and the controls on the measurement instrument to obtain a suitable signal level (i.e., a level that will not overload the measurement instrument but is strong enough to allow measurement of the operating or fundamental frequency of the EUT).
- c) Measure the frequency at each of the frequencies specified in 5.6.
- d) Repeat the above procedure at 85% and 115% of the nominal supply voltage.

Limit

Manufacturers of U-NII devices are responsible for ensuring frequency stability such that an emission is maintained within the band of operation under all conditions of normal operation as specified in the users manual.

Measurement Uncertainty

The assessed measurement uncertainty to ensure 95% confidence level for the normal distribution is with the coverage factor $k = 2$, $U = 936\text{Hz}$

**Test Results**

Voltage (V)	Temperature (°C)	U-NII-1 Test Results			
		5200MHz			
		1min	2min	5min	10min
3.85	-20	5199.998485	5199.996269	5199.995452	5199.987559
3.85	-10	5199.995360	5199.990360	5199.986449	5199.983356
3.85	0	5199.993151	5199.983066	5199.980970	5199.976444
3.85	10	5199.989737	5199.977046	5199.976738	5199.972635
3.85	20	5199.980312	5199.971922	5199.967105	5199.966827
3.85	30	5199.975361	5199.969144	5199.966873	5199.961083
3.85	40	5199.971329	5199.959374	5199.965088	5199.951303
3.85	50	5199.964923	5199.952464	5199.958840	5199.942704
3.40	20	5199.955087	5199.945713	5199.957497	5199.938435
4.40	20	5199.945882	5199.942914	5199.948046	5199.929446
Max. ΔMHz		-0.054118	-0.057086	-0.051954	-0.070554
PPM		-10.407367	-10.978152	-9.991164	-13.567994

Voltage (V)	Temperature (°C)	U-NII-3 Test Results			
		5785MHz			
		1min	2min	5min	10min
3.85	-20	5785.006800	5785.005599	5785.000307	5784.991359
3.85	-10	5784.998981	5785.002163	5784.993937	5784.983808
3.85	0	5784.991058	5785.001325	5784.987918	5784.981605
3.85	10	5784.981105	5784.993589	5784.986395	5784.976735
3.85	20	5784.976308	5784.993152	5784.977590	5784.973829
3.85	30	5784.969045	5784.990484	5784.970677	5784.970971
3.85	40	5784.960972	5784.981870	5784.964259	5784.969766
3.85	50	5784.956774	5784.975307	5784.963392	5784.962699
3.40	20	5784.951199	5784.965827	5784.955450	5784.960726
4.40	20	5784.946212	5784.957785	5784.953002	5784.957916
3.85	-20	5785.006800	5785.005599	5785.000307	5784.991359
Max. ΔMHz		-0.053788	-0.042215	-0.046998	-0.042084
PPM		-9.297902	-7.297356	-8.124154	-7.274717

5.4. Power Spectral Density

Ambient condition

Temperature	Relative humidity	Pressure
23°C ~25°C	45%~50%	101.5kPa

Method of Measurement

The EUT was connected to the spectrum analyzer through an external attenuator (20dB) and a known loss cable.

Set RBW = 1MHz, VBW =3MHz for the band 5.150-5.250GHz
 Set RBW = 470kHz, VBW =1.5MHz for the band 5.725-5.850GHz

The conducted PSD is measured at each antenna port. The measured results at the various antenna ports are then summed mathematically.

Test setup

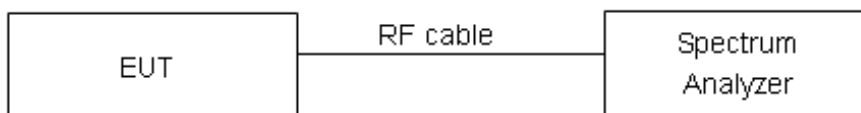

Limits

Rule FCC Part 15.407(a)(1) / Part 15.407(a)(3)

For an indoor access point operating in the band 5.15-5.25 GHz, the maximum power spectral density shall not exceed 17 dBm in any 1 megahertz band. If transmitting antennas of directional gain greater than 6 dBi are used, both the maximum conducted output power and the maximum power spectral density shall be reduced by the amount in dB that the directional gain of the antenna exceeds 6 dBi.

For client devices in the 5.15-5.25 GHz band, the maximum conducted output power over the frequency band of operation shall not exceed 250 mW provided the maximum antenna gain does not exceed 6 dBi. In addition, the maximum power spectral density shall not exceed 11 dBm in any 1 megahertz band. If transmitting antennas of directional gain greater than 6 dBi are used, both the maximum conducted output power and the maximum power spectral density shall be reduced by the amount in dB that the directional gain of the antenna exceeds 6 dBi.

For the band 5.725-5.85 GHz, the maximum power spectral density shall not exceed 30 dBm in any 500kHz band. If transmitting antennas of directional gain greater than 6 dBi are used, both the maximum conducted output power and the maximum power spectral density shall be reduced by the amount in dB that the directional gain of the antenna exceeds 6 dBi.

Frequency Bands/MHz	Limits
5150-5250	11dBm/MHz
5725-5850	30dBm/500kHz



Measurement Uncertainty

The assessed measurement uncertainty to ensure 95% confidence level for the normal distribution is with the coverage factor $k = 2$, $U = 0.75\text{dB}$.

**Test Results:**

Note: Power Spectral Density =Read Value+Duty cycle correction factor

U-NII-1

Mode	Channel Number	Read Value (dBm /MHz)	Power Spectral Density (dBm /MHz)	Limit (dBm /MHz)	Conclusion
802.11a	36	5.41	5.41	11	PASS
	40	5.22	5.22	11	PASS
	48	5.39	5.39	11	PASS
802.11n HT20	36	4.84	4.97	11	PASS
	40	5.03	5.16	11	PASS
	48	5.09	5.22	11	PASS
802.11n HT40	38	1.97	2.17	11	PASS
	46	1.89	2.09	11	PASS
802.11ac VHT20	36	0.56	0.66	11	PASS
	40	0.52	0.62	11	PASS
	48	0.63	0.73	11	PASS
802.11ac VHT40	38	-1.73	-1.47	11	PASS
	46	-1.99	-1.73	11	PASS
802.11ac VHT80	42	-4.89	-4.38	11	PASS

U-NII-3

Mode	Channel Number	Read Value (dBm/470kHz)	Power Spectral Density (dBm/500kHz)	Limit (dBm/500kHz)	Conclusion
802.11a	149	3.08	3.35	30	PASS
	157	3.48	3.75	30	PASS
	165	3.56	3.83	30	PASS
802.11n HT20	149	1.85	2.25	30	PASS
	157	1.83	2.23	30	PASS
	165	2.36	2.76	30	PASS
802.11n HT40	151	-0.70	-0.23	30	PASS
	159	-0.48	-0.01	30	PASS
802.11ac VHT20	149	-0.76	-0.39	30	PASS
	157	-0.45	-0.08	30	PASS
	165	-0.33	0.04	30	PASS
802.11ac VHT40	151	-3.86	-3.33	30	PASS
	159	-3.46	-2.93	30	PASS
802.11ac VHT80	155	-7.08	-6.30	30	PASS

Note: PSD=Read Value+Duty cycle correction factor+10*LOG10(500/470)

U-NII-1, 802.11a, Channel No.: 36

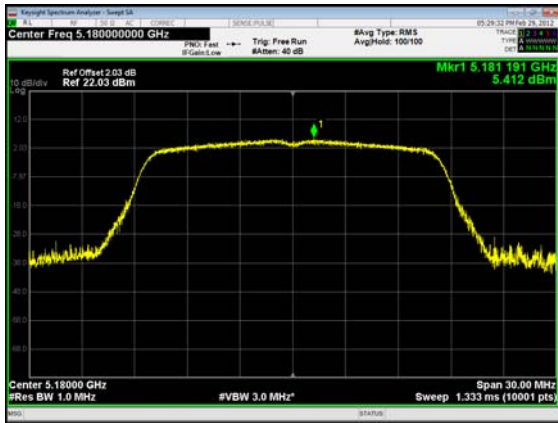

U-NII-1, 802.11n HT20, Channel No.: 36

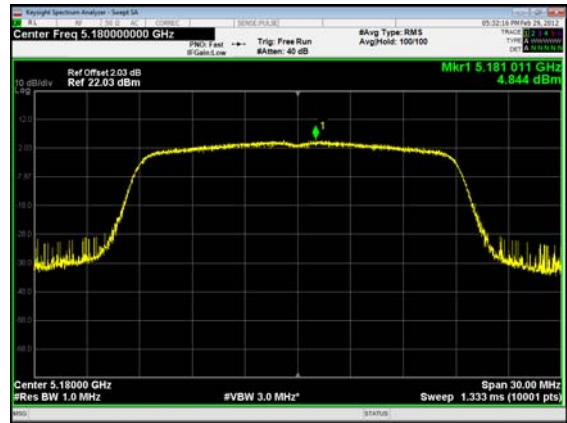

U-NII-1, 802.11a, Channel No.: 40

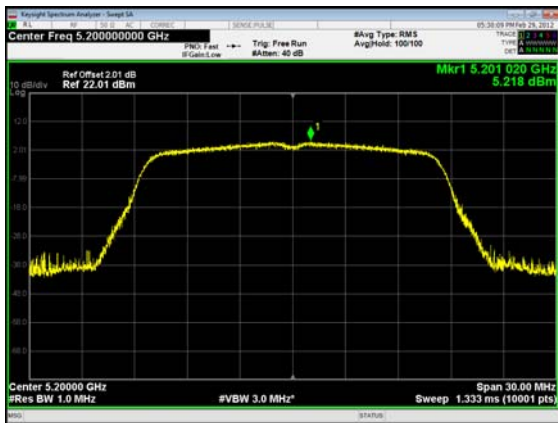

U-NII-1, 802.11n HT20, Channel No.: 40

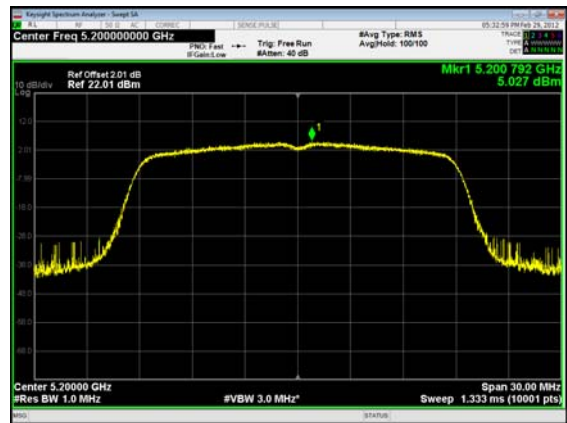

U-NII-1, 802.11a, Channel No.: 48

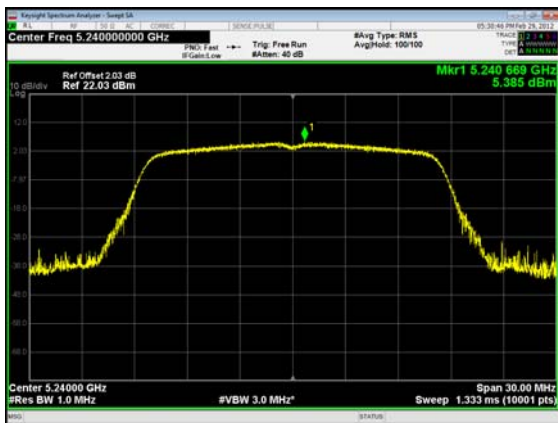

U-NII-1, 802.11n HT20, Channel No.: 48

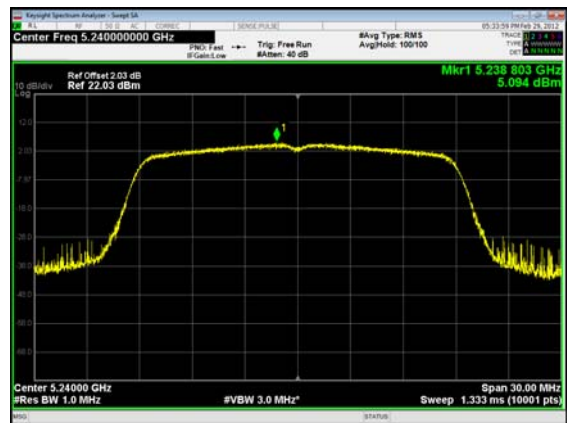

U-NII-1, 802.11n HT40, Channel No.: 38

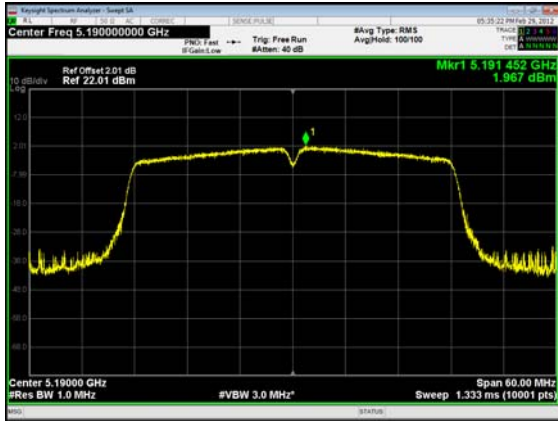

U-NII-1, 802.11ac VHT20, Channel No.: 36

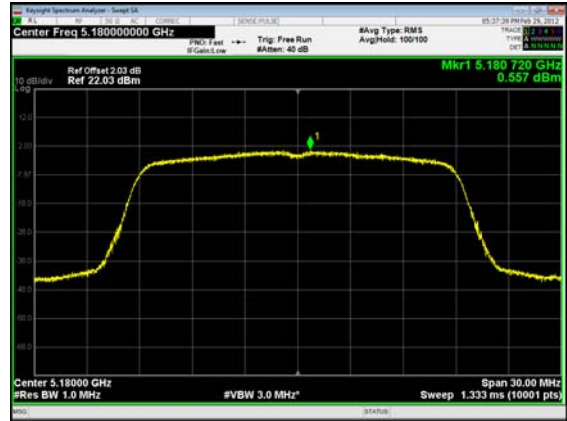

U-NII-1, 802.11n HT40, Channel No.: 46

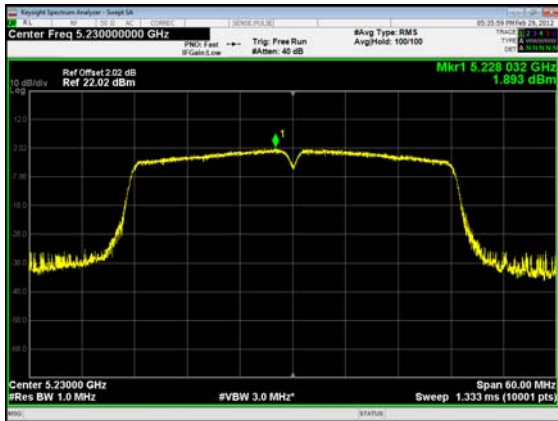

U-NII-1, 802.11ac VHT20, Channel No.: 40

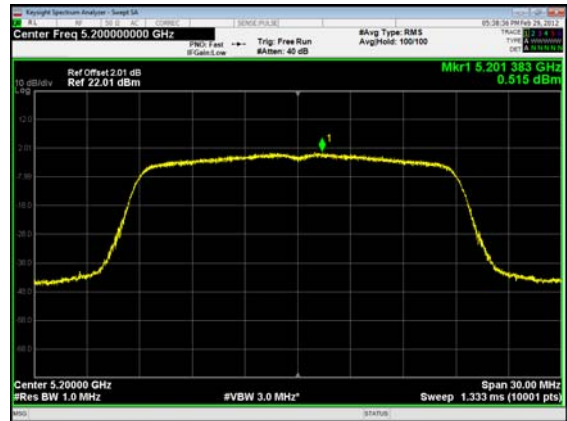

U-NII-1, 802.11ac VHT40, Channel No.: 38

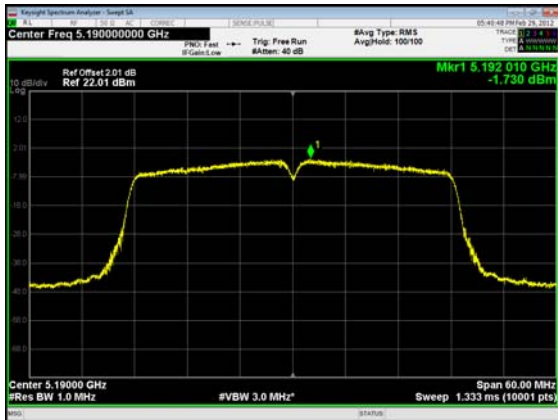

U-NII-1, 802.11ac VHT20, Channel No.: 48

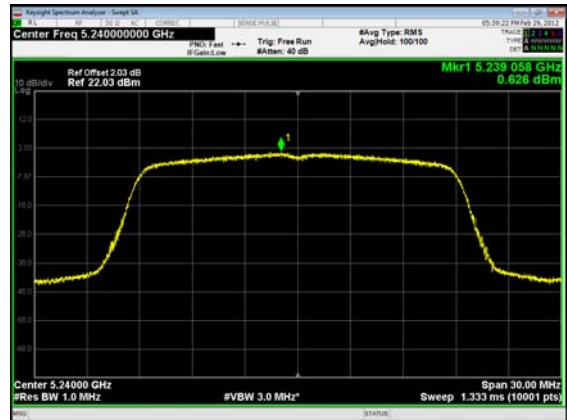

U-NII-1, 802.11ac VHT40, Channel No.: 46

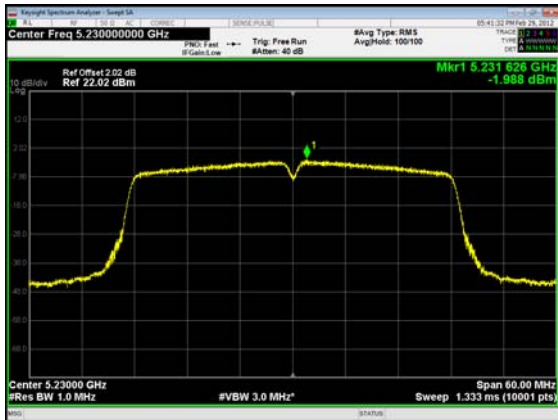

U-NII-1, 802.11ac VHT80, Channel No.: 42



U-NII-3, 802.11a, Channel No.: 149

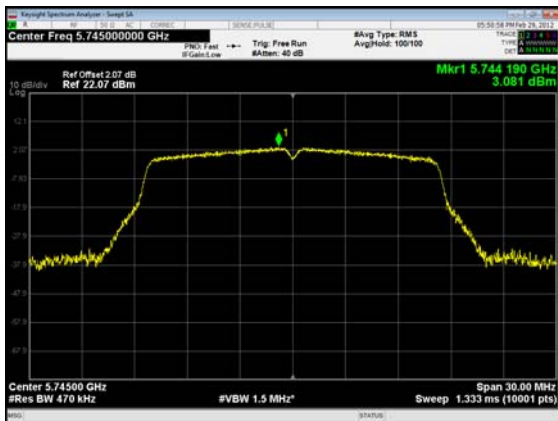

U-NII-3, 802.11n HT20, Channel No.: 149

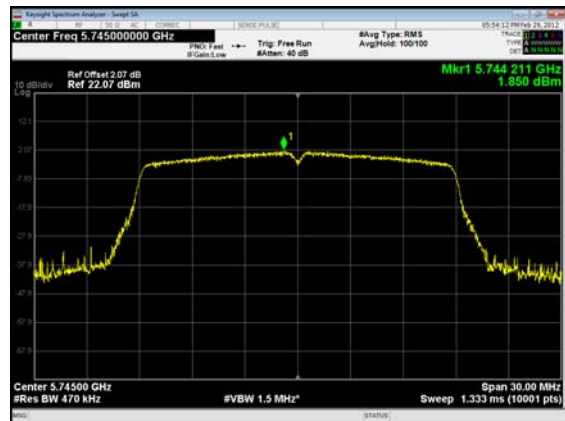

U-NII-3, 802.11a, Channel No.: 157

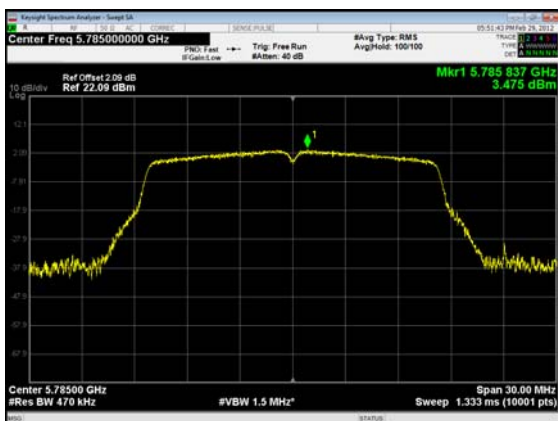

U-NII-3, 802.11n HT20, Channel No.: 157

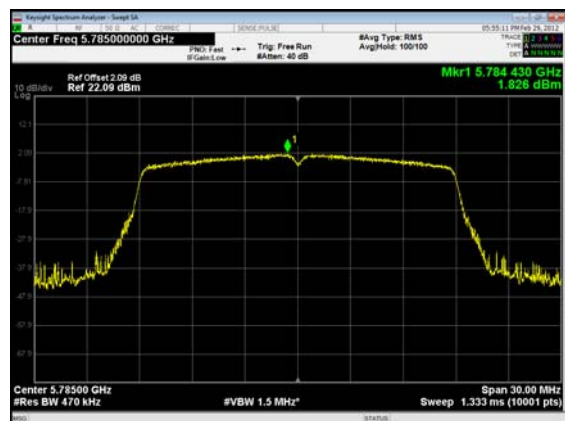



U-NII-3, 802.11a, Channel No.: 165

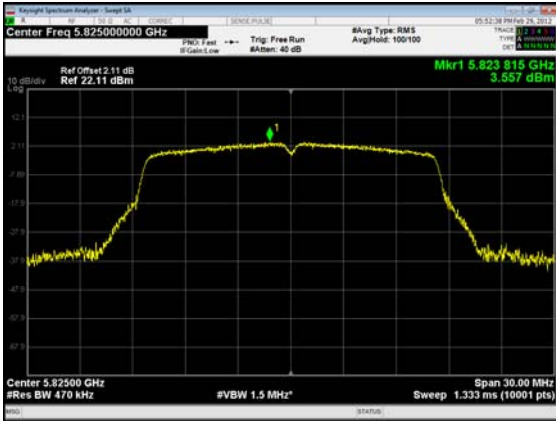

U-NII-3, 802.11n HT20, Channel No.: 165

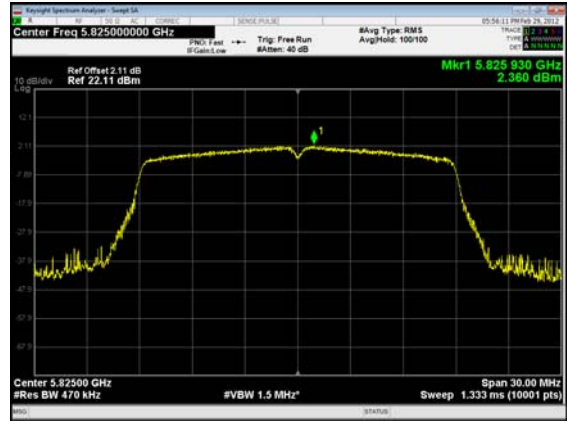

U-NII-3, 802.11n HT40, Channel No.: 151

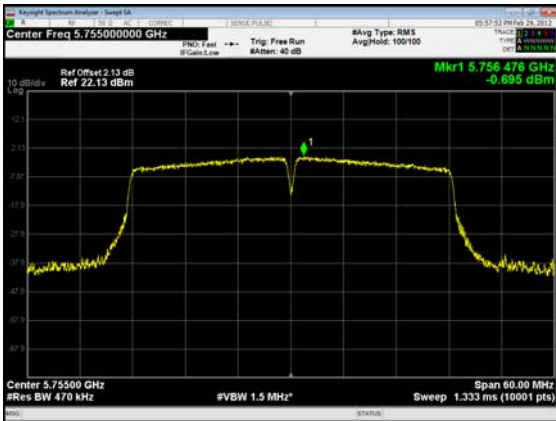

U-NII-3, 802.11ac VHT20, Channel No.: 149

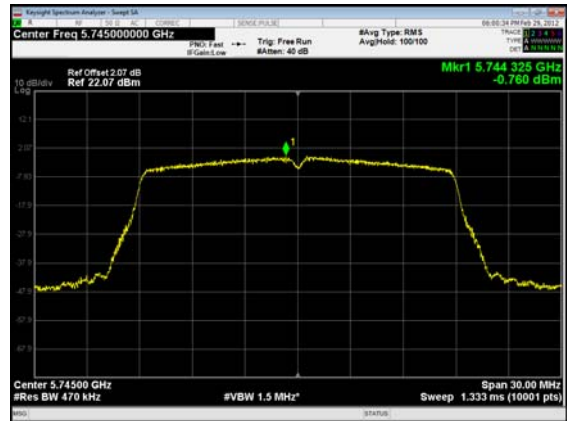

U-NII-3, 802.11n HT40, Channel No.: 159

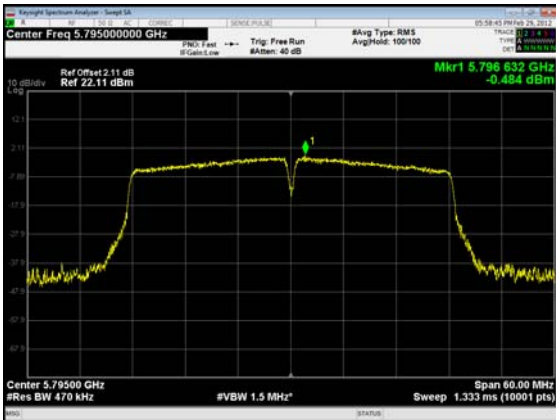

U-NII-3, 802.11ac VHT20, Channel No.: 157

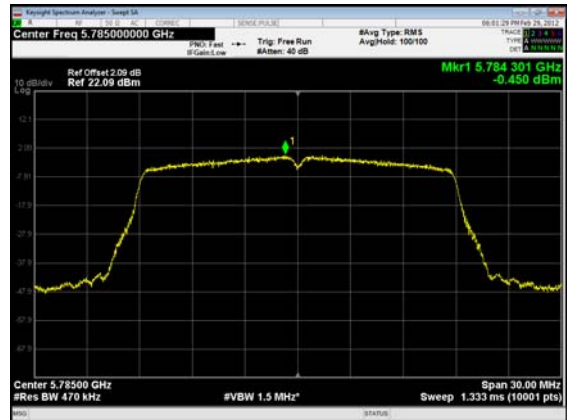



U-NII-3, 802.11ac VHT40, Channel No.: 151

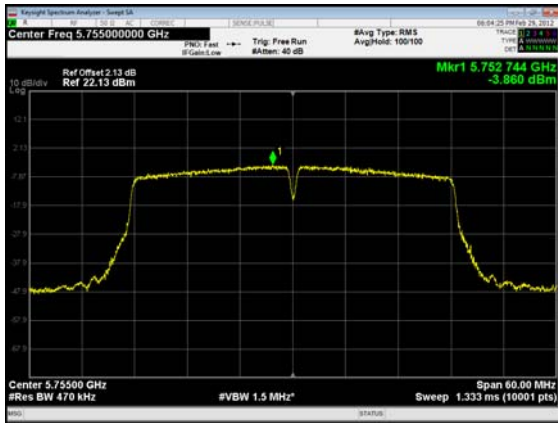

U-NII-3, 802.11ac VHT20, Channel No.: 165

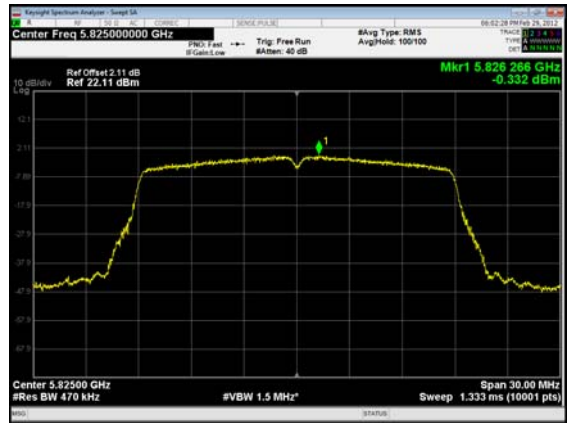

U-NII-3, 802.11ac VHT40, Channel No.: 159

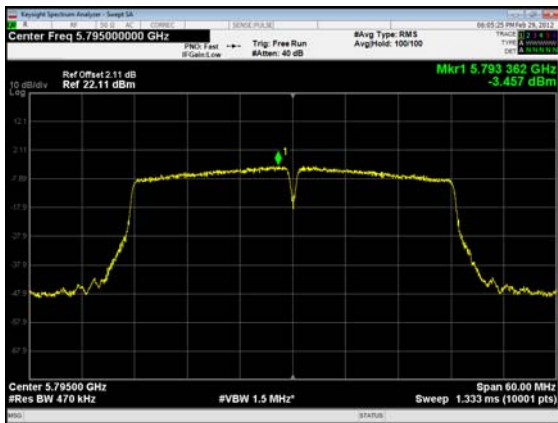

U-NII-3, 802.11ac VHT80, Channel No.: 155

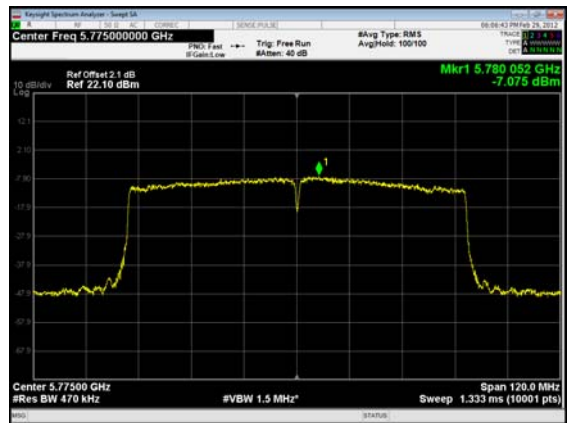

5.5. Unwanted Emission

Ambient condition

Temperature	Relative humidity	Pressure
23°C ~25°C	45%~50%	101.5kPa

Method of Measurement

The test set-up was made in accordance to the general provisions of ANSI C63.10. The Equipment Under Test (EUT) was set up on a non-conductive table in the semi-anechoic chamber. The test was performed at the distance of 3 m between the EUT and the receiving antenna. The radiated emissions measurements were made in a typical installation configuration.

Sweep the whole frequency band range from 9kHz to the 10th harmonic of the carrier, and the emissions less than 20 dB below the permissible value are reported.

During the test, the height of receive antenna shall be moved from 1 to 4 meters, and the antenna shall be performed under horizontal and vertical polarization. The turntable shall be rotated from 0 to 360 degrees for detecting the maximum of radiated spurious signal level. The measurements shall be repeated with orthogonal polarization of the test antenna. The data of cable loss and antenna factor has been calibrated in full testing frequency range before the testing.

Set the spectrum analyzer in the following:

9kHz~150 kHz

RBW=200Hz, VBW=1kHz/ Sweep=AUTO

150 kHz~30MHz

RBW=9KHz, VBW=30KHz,/ Sweep=AUTO

Below 1GHz

RBW=100kHz / VBW=300kHz / Sweep=AUTO

a) Peak emission levels are measured by setting the instrument as follows:

Above 1GHz

PEAK: RBW=1MHz VBW=3MHz/ Sweep=AUTO

b) Average emission levels are measured by setting the instrument as follows:

Above 1GHz

AVERAGE: RBW=1MHz / VBW=3MHz / Sweep=AUTO

c) Detector: The measurements employing a CISPR quasi-peak detector except for the frequency bands 9-90 kHz, 110-490 kHz and above 1000 MHz. Radiated emission limits in these three bands are based on measurements employing an average detector.

d) Averaging type = power (i.e., rms) (As an alternative, the detector and averaging type may be set for linear voltage averaging. Some instruments require linear display mode to use linear voltage averaging. Log or dB averaging shall not be used.)

e) Sweep time = auto.

f) Perform a trace average of at least 100 traces if the transmission is continuous. If the transmission is not continuous, then the number of traces shall be increased by a factor of $1 / D$, where D is the duty cycle. For example, with 50% duty cycle, at least 200 traces shall be averaged. (If a specific



emission is demonstrated to be continuous—i.e., 100% duty cycle—then rather than turning ON and OFF with the transmit cycle, at least 100 traces shall be averaged.)

g) If tests are performed with the EUT transmitting at a duty cycle less than 98%, then a correction factor shall be added to the measurement results prior to comparing with the emission limit, to compute the emission level that would have been measured had the test been performed at 100% duty cycle. The correction factor is computed as follows:

1) If power averaging (rms) mode was used in the preceding step e), then the correction factor is $[10 \log (1 / D)]$, where D is the duty cycle. For example, if the transmit duty cycle was 50%, then 3 dB shall be added to the measured emission levels.

2) If linear voltage averaging mode was used in the preceding step e), then the correction factor is $[20 \log (1 / D)]$, where D is the duty cycle. For example, if the transmit duty cycle was 50%, then 6 dB shall be added to the measured emission levels.

3) If a specific emission is demonstrated to be continuous (100% duty cycle) rather than turning ON and OFF with the transmit cycle, then no duty cycle correction is required for that emission.

Reduce the video bandwidth until no significant variations in the displayed signal are observed in subsequent traces, provided the video bandwidth is no less than 1 Hz. For regulatory requirements that specify averaging only over the transmit duration (e.g., digital transmission system [DTS] and Unlicensed National Information Infrastructure [U-NII]), the video bandwidth shall be greater than $[1 / (\text{minimum transmitter on time})]$ and no less than 1 Hz.

The field strength of spurious emission was measured in the following position: EUT stand-up position (Z axis), lie-down position (X, Y axis). The worst emission was found in stand-up position (Z axis) and the loop antenna is vertical, others antenna are vertical and horizontal.

The test is in transmitting mode.

9KHz~~~30MHz

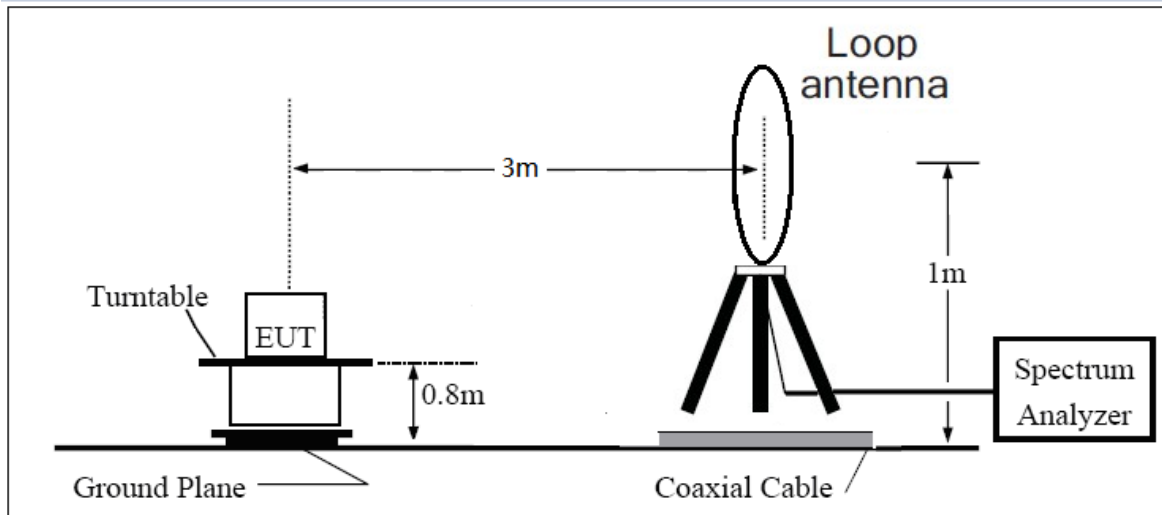

30MHz~~~ 1GHz

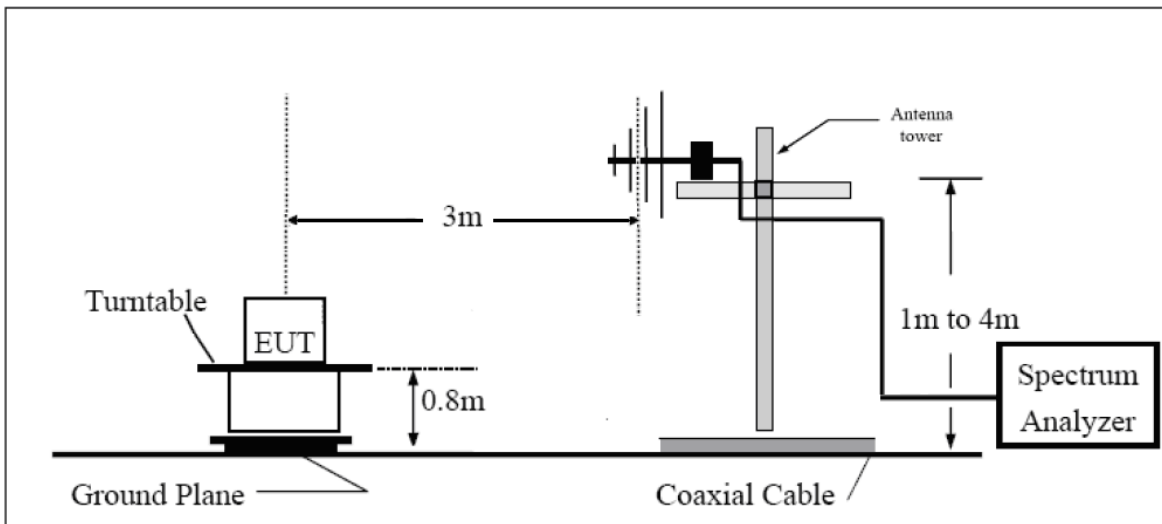

Above 1GHz

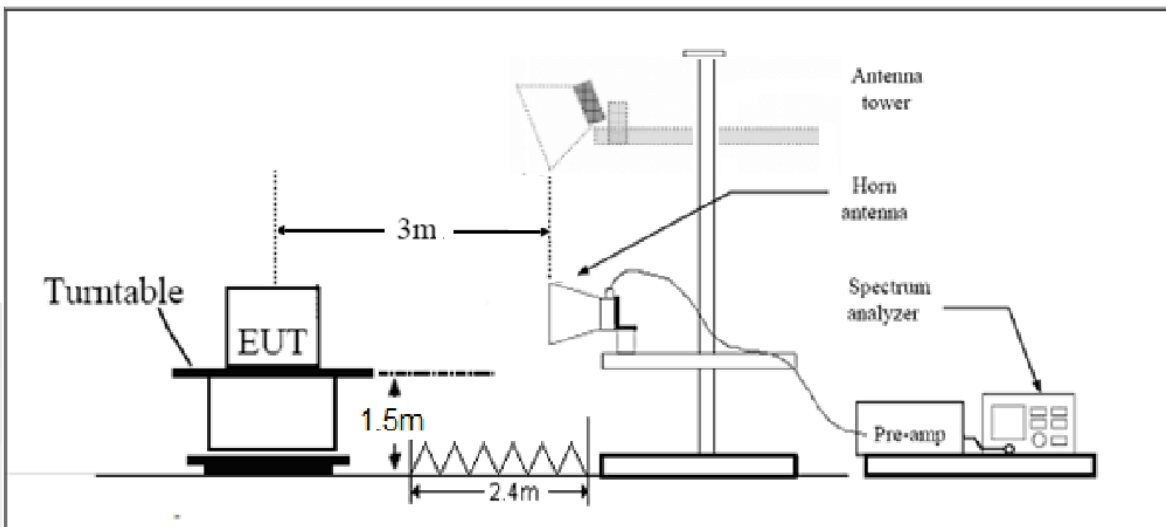

Note: Area side:2.4mX3.6m

Limits

- (1) For transmitters operating in the 5725-5850 MHz band: All emissions shall be limited to a level of -27 dBm/MHz at 75 MHz or more above or below the band edge increasing linearly to 10 dBm/MHz at 25 MHz above or below the band edge, and from 25 MHz above or below the band edge increasing linearly to a level of 15.6 dBm/MHz at 5 MHz above or below the band edge, and from 5 MHz above or below the band edge increasing linearly to a level of 27 dBm/MHz at the band edge.
- (2) For transmitters operating in the 5.15-5.25 GHz band: All emissions outside of the 5.15-5.35 GHz band shall not exceed an e.i.r.p. of -27 dBm/MHz(68.2dBμV/m).

Note: the following formula is used to convert the EIRP to field strength

§1、 $E[\text{dB}\mu\text{V}/\text{m}] = \text{EIRP}[\text{dBm}] - 20 \log(d[\text{meters}]) + 104.77$, where E = field strength and

d = distance at which field strength limit is specified in the rules;

§2、 $E[\text{dB}\mu\text{V}/\text{m}] = \text{EIRP}[\text{dBm}] + 95.2$, for d = 3 meters

- (3) Unwanted spurious emissions fallen in restricted bands per FCC Part15.205 shall comply with the general field strength limits set forth in § 15.209 as below table.

Frequency of emission (MHz)	Field strength(uV/m)	Field strength(dBuV/m)
0.009–0.490	2400/F(kHz)	/
0.490–1.705	24000/F(kHz)	/
1.705–30.0	30	/
30-88	100	40
88-216	150	43.5
216-960	200	46
Above960	500	54

MHz	MHz	MHz	GHz
0.090 - 0.110	16.42 - 16.423	399.9 - 410	4.5 - 5.15
0.495 - 0.505	16.69475 - 16.69525	608 - 614	5.35 - 5.46
2.1735 - 2.1905	16.80425 - 16.80475	960 - 1240	7.25 - 7.75
4.125 - 4.128	25.5 - 25.67	1300 - 1427	8.025 - 8.5
4.17725 - 4.17775	37.5 - 38.25	1435 - 1626.5	9.0 - 9.2
4.20725 - 4.20775	73 - 74.6	1645.5 - 1646.5	9.3 - 9.5
6.215 - 6.218	74.8 - 75.2	1660 - 1710	10.6 - 12.7
6.26775 - 6.26825	108 - 121.94	1718.8 - 1722.2	13.25 - 13.4
6.31175 - 6.31225	123 - 138	2200 - 2300	14.47 - 14.5
8.291 - 8.294	149.9 - 150.05	2310 - 2390	15.35 - 16.2
8.362 - 8.366	156.52475 - 156.52525	2483.5 - 2500	17.7 - 21.4
8.37625 - 8.38675	156.7 - 156.9	2690 - 2900	22.01 - 23.12
8.41425 - 8.41475	162.0125 - 167.17	3260 - 3267	23.6 - 24.0
12.29 - 12.293	167.72 - 173.2	3332 - 3339	31.2 - 31.8
12.51975 - 12.52025	240 - 285	3345.8 - 3358	36.43 - 36.5
12.57675 - 12.57725	322 - 335.4	3600 - 4400	(²)
13.36 - 13.41			

Measurement Uncertainty

The assessed measurement uncertainty to ensure 95% confidence level for the normal distribution is with the coverage factor $k = 1.96$.

Frequency	Uncertainty
9KHz-30MHz	3.55 dB
30MHz-200MHz	4.17 dB
200MHz-1GHz	4.84 dB
1-18GHz	4.35 dB
18-26.5GHz	5.90 dB
26.5GHz~40GHz	5.92 dB



Test Results:

The modulation and bandwidth are similar for 802.11n mode for 20MHz/40MHz and 802.11ac mode for V20MHz/V40MHz, therefore investigated worst case to representative mode in test report.

A font (dB μ V/m) in the test plot =(dB μ V/m)

The signal beyond the limit is carrier.

U-NII-1

802.11a-Channel 36: Peak + Average

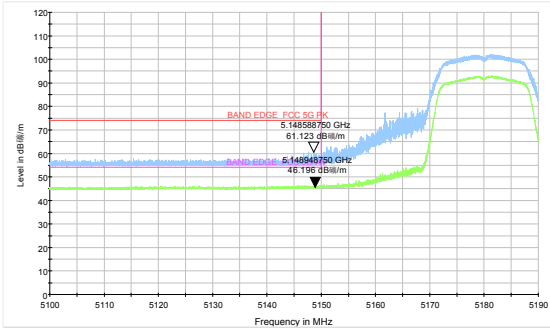

802.11a-Channel 48: Peak + Average

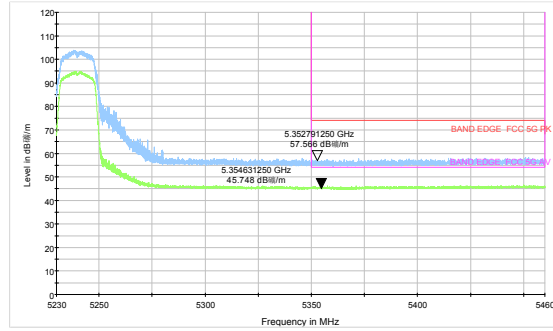

802.11n HT20-Channel 36: Peak + Average

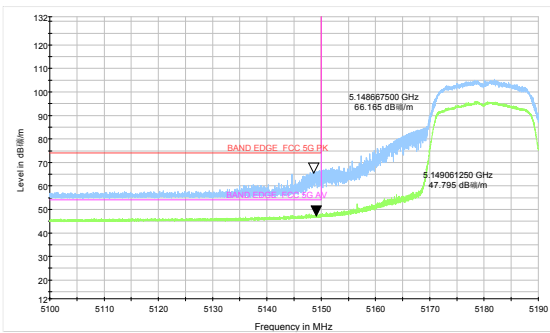

802.11n HT20-Channel 48: Peak + Average

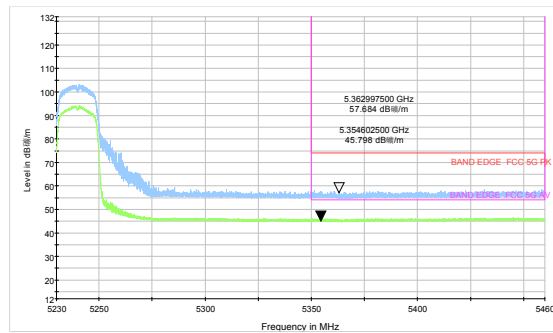

802.11n HT40-Channel 38: Peak + Average

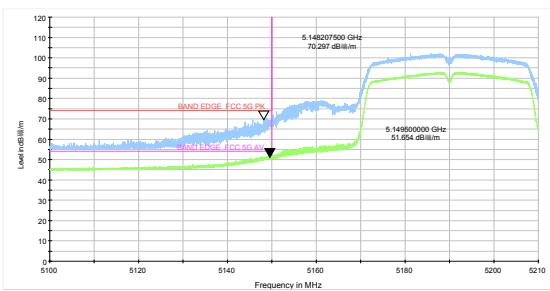

802.11n HT40-Channel 46: Peak + Average

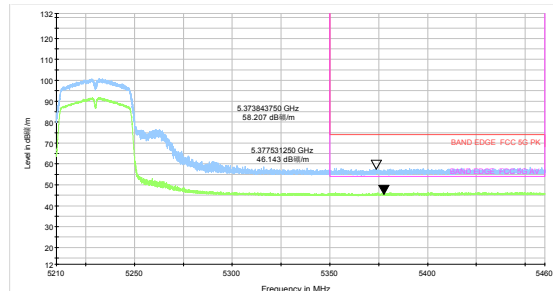

802.11ac VHT80 -Channel 42: Peak + Average

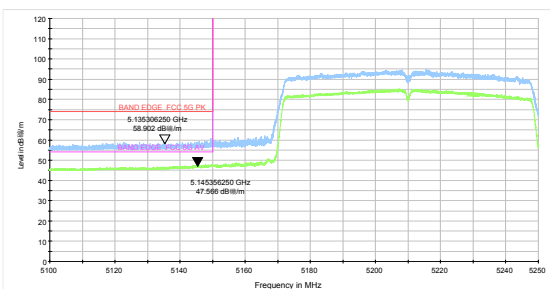



U-NII-3

802.11a-Channel 149: Peak

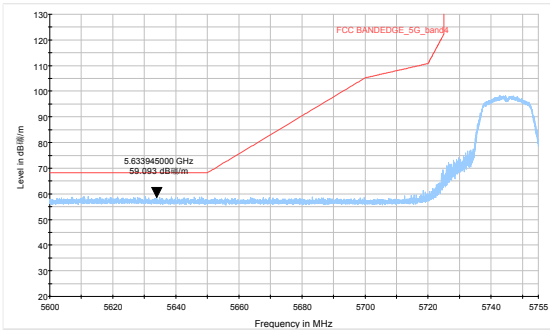

802.11a-Channel 165: Peak

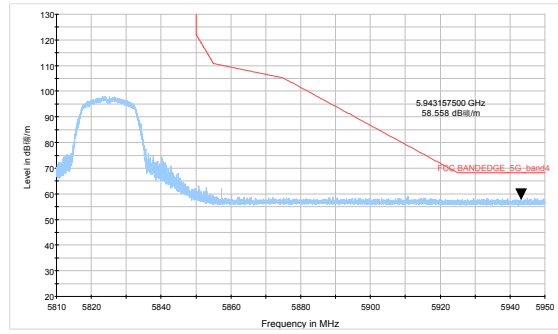

802.11n HT20-Channel 149: Peak

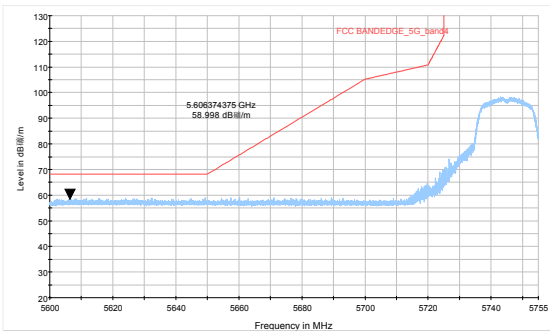

802.11n HT20-Channel 165: Peak

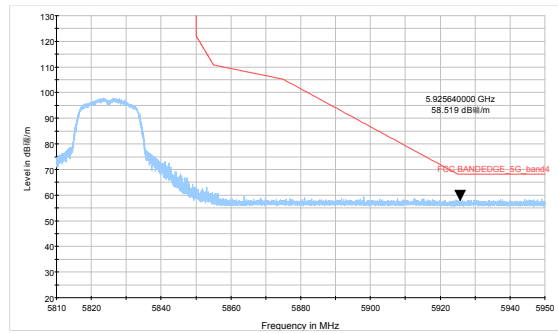

802.11n HT40-Channel 151: Peak

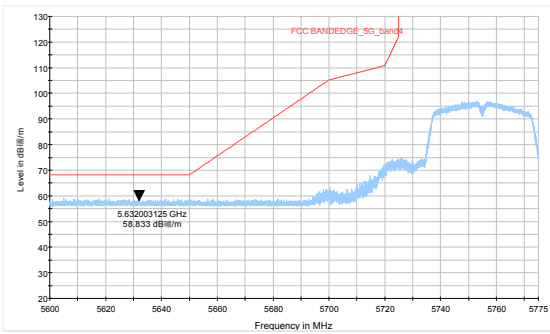

802.11n HT40-Channel 159: Peak

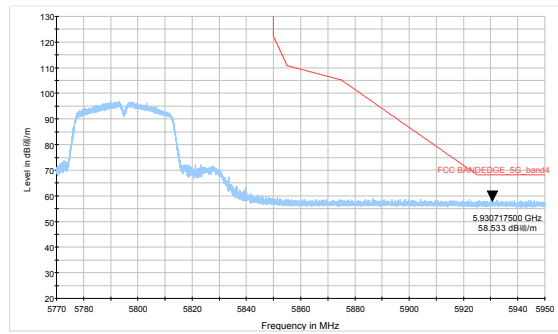

802.11ac VHT80- Channel 155: Peak

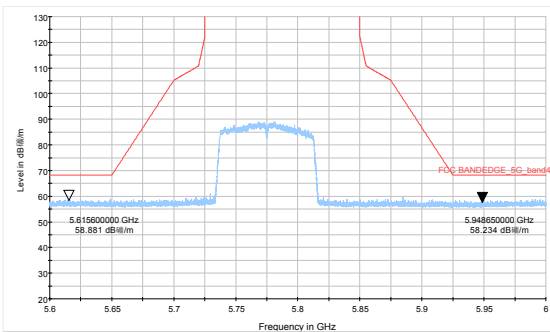

Result of RE

Test result

Sweep the whole frequency band through the range from 9kHz to the 10th harmonic of the carrier, the Emissions in the frequency band 9kHz-30MHz and 26.5GHz-40GHz are more than 20dB below the limit are not reported.

A font (Level in dB μ V/m) in the test plot = (level in dB μ V/m)

A font (Level in dB V/) in the test plot = (level in dB μ V/m)

A font (Level in dB μ V/) in the test plot = (level in dB μ V/m)

During the test, the Radiates Emission from 30MHz to 1GHz was performed in all modes with all channels, 802.11n (HT20) CH157 are selected as the worst condition. The test data of the worst-case condition was recorded in this report.

Continuous TX mode:

FCC RE 9K-90KHz AV

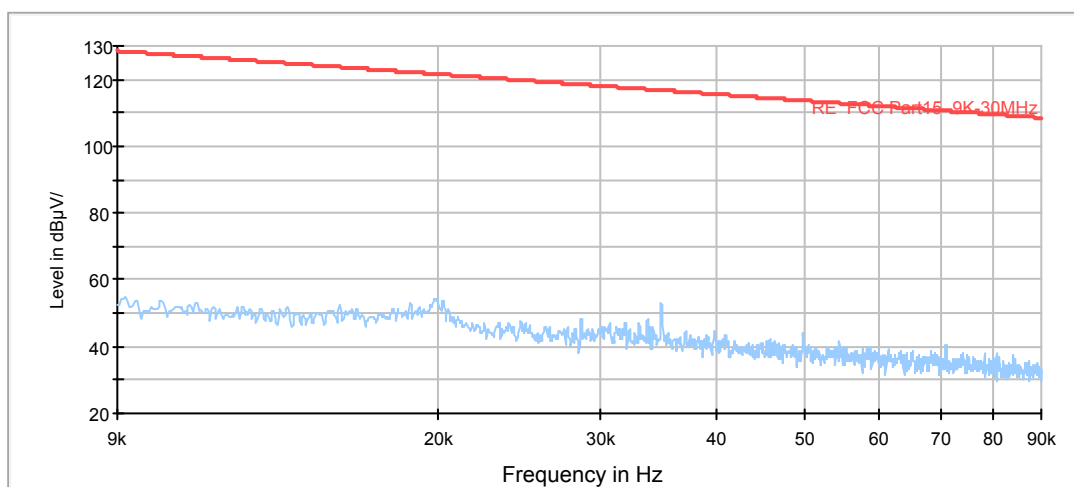

Radiates Emission from 9KHz to 90KHz

FCC RE 90K-110KHz QP

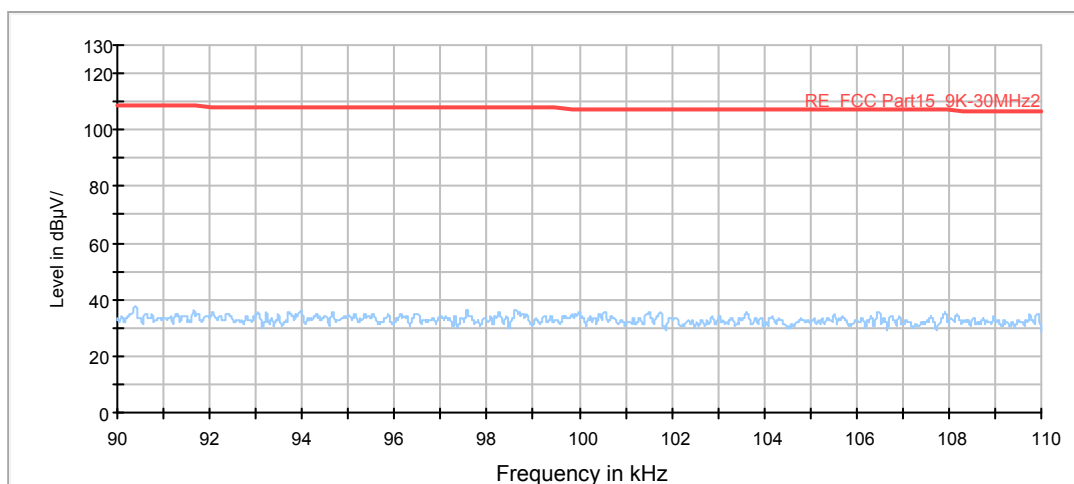

Radiates Emission from 90KHz to 110KHz

FCC RE 110K-490KHz AV

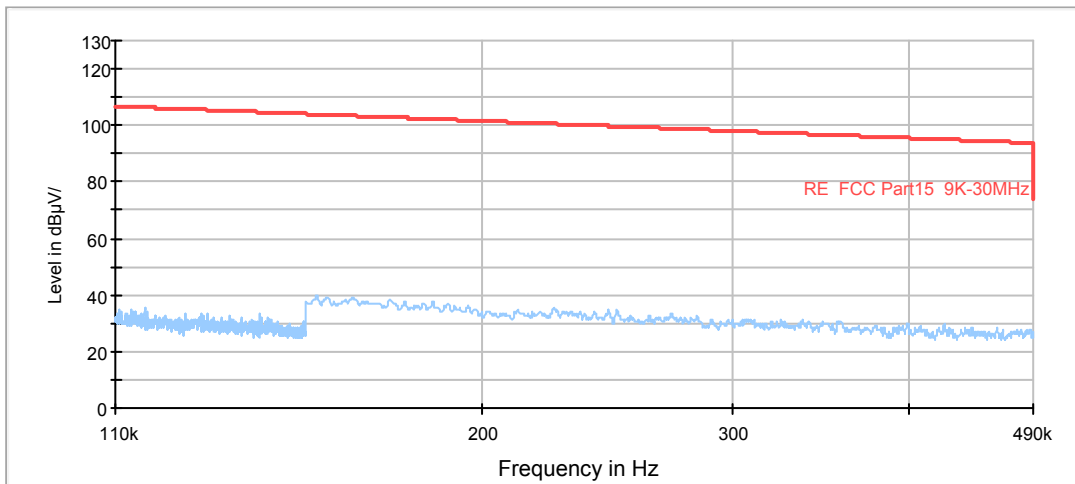

Radiates Emission from 110KHz to 490KHz

FCC RE 490K-30MHz QP

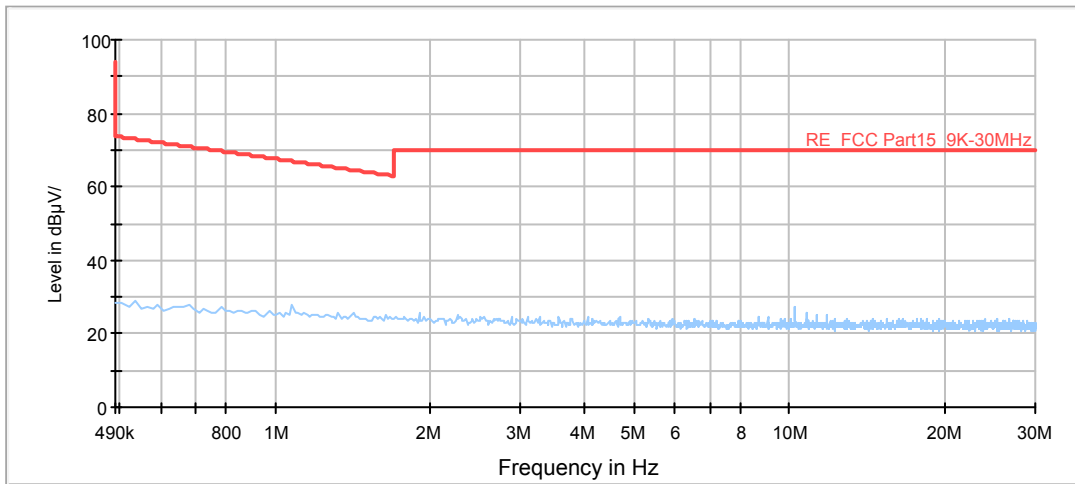

Radiates Emission from 490KHz to 30MHz

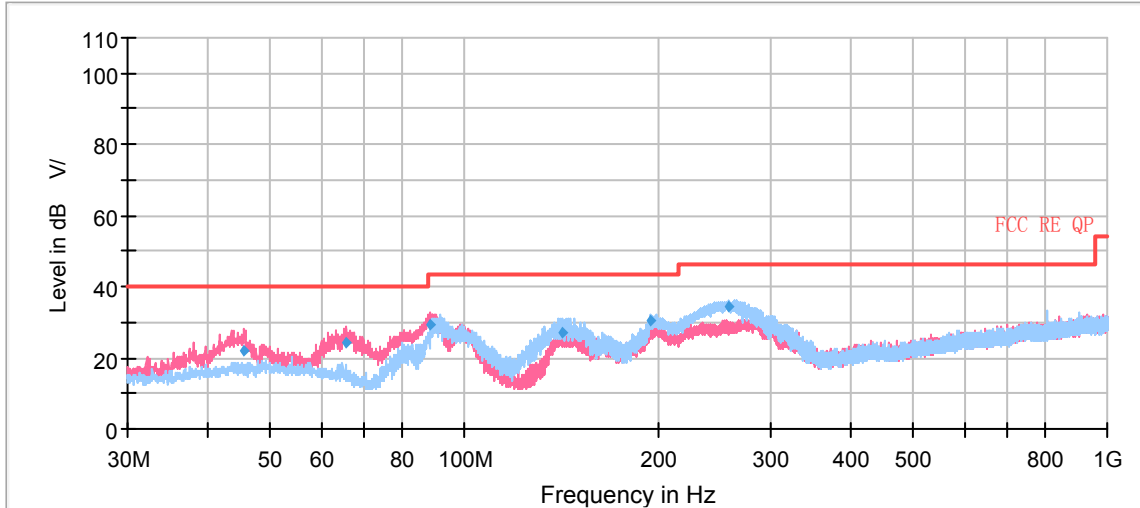

Radiates Emission from 30MHz to 1GHz

Frequency (MHz)	Quasi-Peak (dBuV/m)	Height (cm)	Polarization	Azimuth (deg)	Correct Factor (dB)	Margin (dB)	Limit (dBuV/m)
45.62	22.20	100.0	V	9.00	20	17.80	40.00
65.51	24.19	100.0	V	351.00	18	15.81	40.00
88.48	29.55	125.0	V	240.00	16	13.95	43.50
142.63	27.00	225.0	H	283.00	15	16.50	43.50
195.54	30.18	175.0	H	102.00	19	13.32	43.50
257.52	34.30	125.0	H	256.00	20	11.70	46.00

- Remark: 1. Correction Factor = Antenna factor+ Insertion loss(cable loss+amplifier gain)
 2. Margin = Limit – Quasi-Peak



802.11a CH36

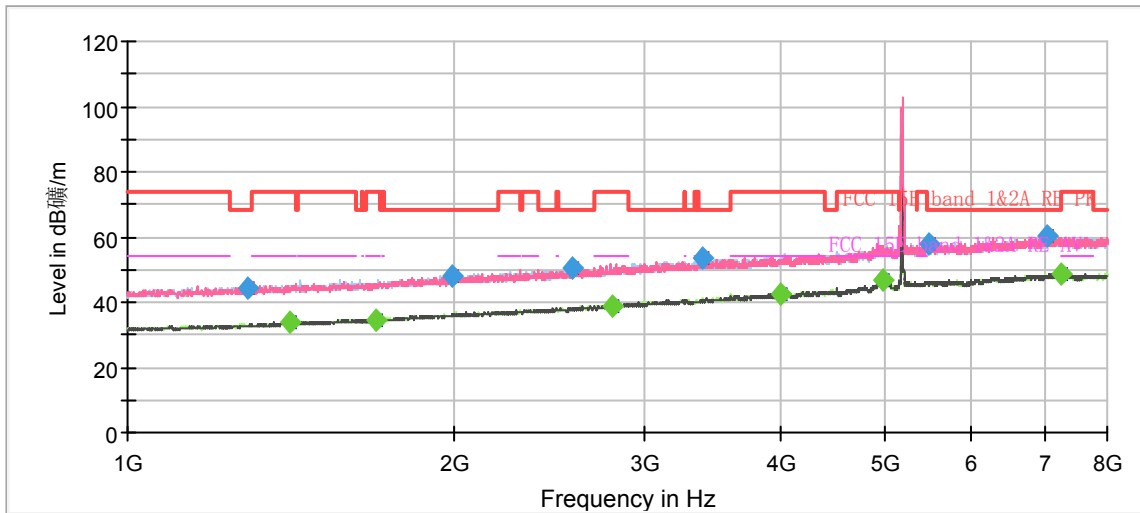

Radiates Emission from 1GHz to 8GHz
 Note: The signal beyond the limit is carrier.

Frequency (MHz)	Peak (dBuV/m)	Average (dBuV/m)	Limit (dBuV/m)	Margin (dB)	Height (cm)	Polarization	Azimuth (deg)	Correct Factor (dB)
1293.125000	44.55	---	68.20	23.65	200.0	V	65.0	-15.8
1413.000000	---	33.66	54.00	20.34	200.0	V	175.0	-15.3
1696.500000	---	34.75	54.00	19.25	200.0	H	278.0	-14.0
1987.875000	48.29	---	68.20	19.91	200.0	V	57.0	-12.6
2575.000000	50.24	---	68.20	17.96	200.0	V	216.0	-10.9
2799.875000	---	39.04	54.00	14.96	200.0	H	311.0	-9.9
3381.750000	53.38	---	68.20	14.82	200.0	H	294.0	-7.5
3993.375000	---	42.51	54.00	11.49	200.0	V	239.0	-5.4
4961.125000	---	46.50	54.00	7.50	200.0	H	347.0	-1.6
5483.500000	57.82	---	68.20	10.38	200.0	V	41.0	-0.5
7046.250000	60.28	---	68.20	7.92	200.0	H	145.0	2.4
7266.750000	---	48.76	54.00	5.24	100.0	V	48.0	2.9

Remark: 1. Correction Factor = Antenna factor+ Insertion loss (cable loss + amplifier gain)

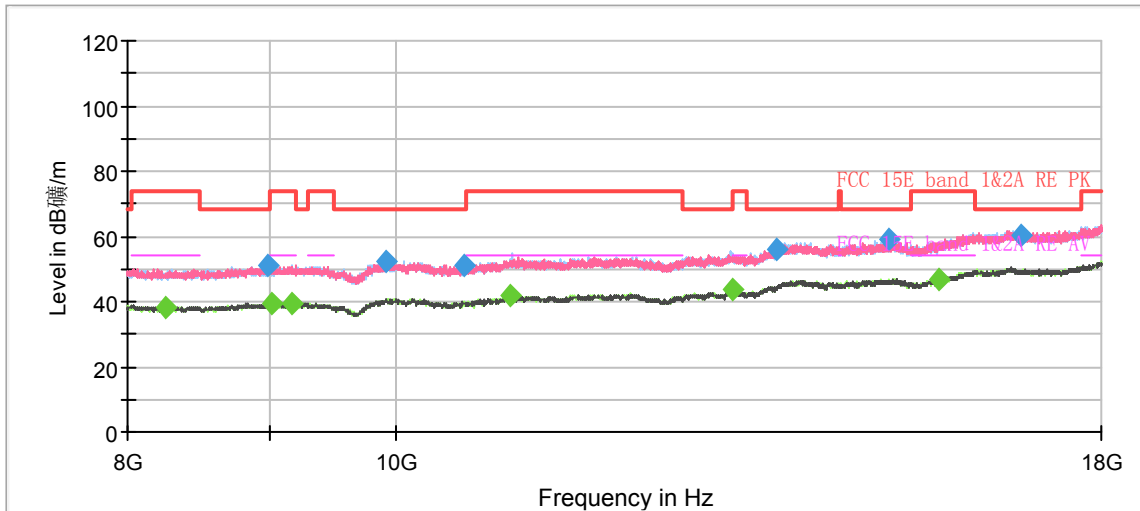

Radiates Emission from 8GHz to 18GHz

Frequency (MHz)	Peak (dBuV/m)	Average (dBuV/m)	Limit (dBuV/m)	Margin (dB)	Height (cm)	Polarization	Azimuth (deg)	Correct Factor (dB)
8255.000000	---	37.96	54.00	16.04	100.0	H	89.0	-7.5
8990.000000	51.12	---	68.20	17.08	100.0	V	274.0	-6.8
9018.750000	---	39.57	54.00	14.43	100.0	H	89.0	-6.7
9175.000000	---	39.28	54.00	14.72	200.0	V	159.0	-6.6
9921.250000	52.38	---	68.20	15.82	100.0	V	280.0	-5.3
10595.000000	51.04	---	68.20	17.16	100.0	H	10.0	-4.8
11006.250000	---	42.11	54.00	11.89	100.0	H	124.0	-4.8
13251.250000	---	43.40	54.00	10.60	200.0	V	221.0	-2.2
13735.000000	55.79	---	68.20	12.41	200.0	H	247.0	-0.2
15092.500000	58.80	---	68.20	9.40	200.0	V	89.0	1.7
15722.500000	---	46.61	54.00	7.39	200.0	V	332.0	2.7
16828.750000	60.28	---	68.20	7.92	200.0	V	299.0	5.4

Remark: 1. Correction Factor = Antenna factor+ Insertion loss (cable loss + amplifier gain)



802.11a CH40

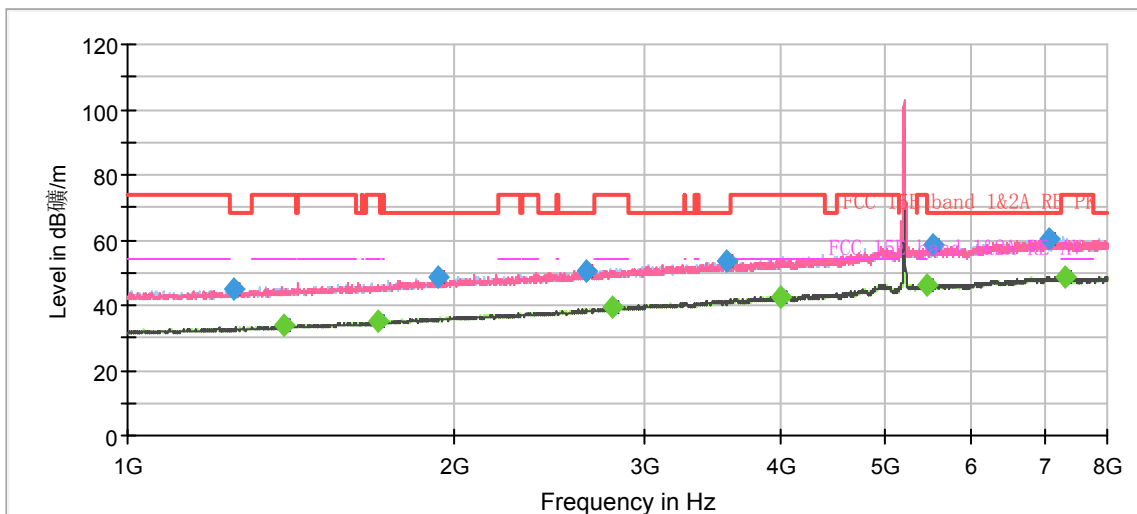

Radiates Emission from 1GHz to 8GHz
 Note: The signal beyond the limit is carrier.

Frequency (MHz)	Peak (dBuV/m)	Average (dBuV/m)	Limit (dBuV/m)	Margin (dB)	Height (cm)	Polarization	Azimuth (deg)	Correct Factor (dB)
1250.250000	44.84	---	68.20	23.36	200.0	V	80.0	-16.0
1394.625000	---	33.59	54.00	20.41	100.0	H	0.0	-15.4
1702.625000	---	34.84	54.00	19.16	200.0	H	1.0	-13.9
1937.125000	48.51	---	68.20	19.69	200.0	H	304.0	-12.9
2648.500000	50.51	---	68.20	17.69	200.0	H	312.0	-10.6
2802.500000	---	39.09	54.00	14.91	200.0	V	296.0	-9.9
3560.250000	53.32	---	68.20	14.88	100.0	H	290.0	-7.0
3994.250000	---	42.55	54.00	11.45	200.0	V	97.0	-5.4
5445.000000	---	46.16	54.00	7.84	200.0	H	264.0	-0.6
5519.375000	58.27	---	68.20	9.93	100.0	H	266.0	-0.4
7065.500000	60.16	---	68.20	8.04	200.0	V	359.0	2.4
7323.625000	---	48.58	54.00	5.42	100.0	H	306.0	2.9

Remark: 1. Correction Factor = Antenna factor+ Insertion loss (cable loss + amplifier gain)

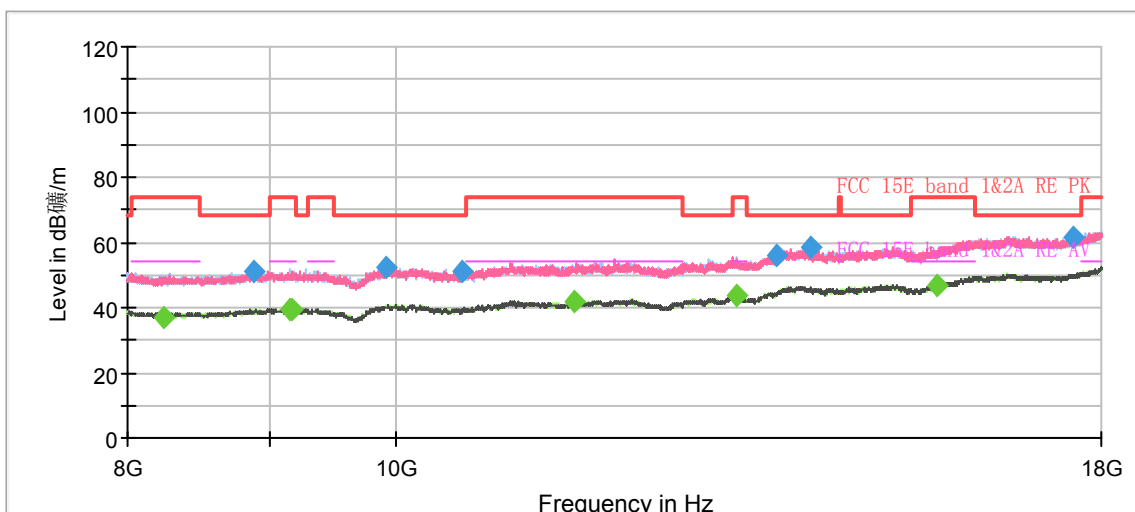

Radiates Emission from 8GHz to 18GHz

Frequency (MHz)	Peak (dBuV/m)	Average (dBuV/m)	Limit (dBuV/m)	Margin (dB)	Height (cm)	Polarization	Azimuth (deg)	Correct Factor (dB)
8243.750000	---	37.17	54.00	16.83	200.0	H	252.0	-7.5
8885.000000	51.15	---	68.20	17.05	200.0	V	136.0	-6.9
9156.250000	---	39.61	54.00	14.39	200.0	V	80.0	-6.6
9170.000000	---	39.44	54.00	14.56	100.0	V	49.0	-6.6
9926.250000	52.13	---	68.20	16.07	200.0	V	10.0	-5.3
10576.250000	51.29	---	68.20	16.91	100.0	H	10.0	-4.8
11597.500000	---	41.99	54.00	12.01	200.0	V	241.0	-3.4
13291.250000	---	43.39	54.00	10.61	200.0	V	234.0	-2.1
13736.250000	56.16	---	68.20	12.04	200.0	H	274.0	-0.2
14135.000000	58.44	---	68.20	9.76	100.0	H	233.0	0.6
15703.750000	---	46.77	54.00	7.23	200.0	H	239.0	2.6
17571.250000	61.80	---	68.20	6.40	100.0	V	296.0	5.3

Remark: 1. Correction Factor = Antenna factor+ Insertion loss (cable loss + amplifier gain)



802.11a CH48

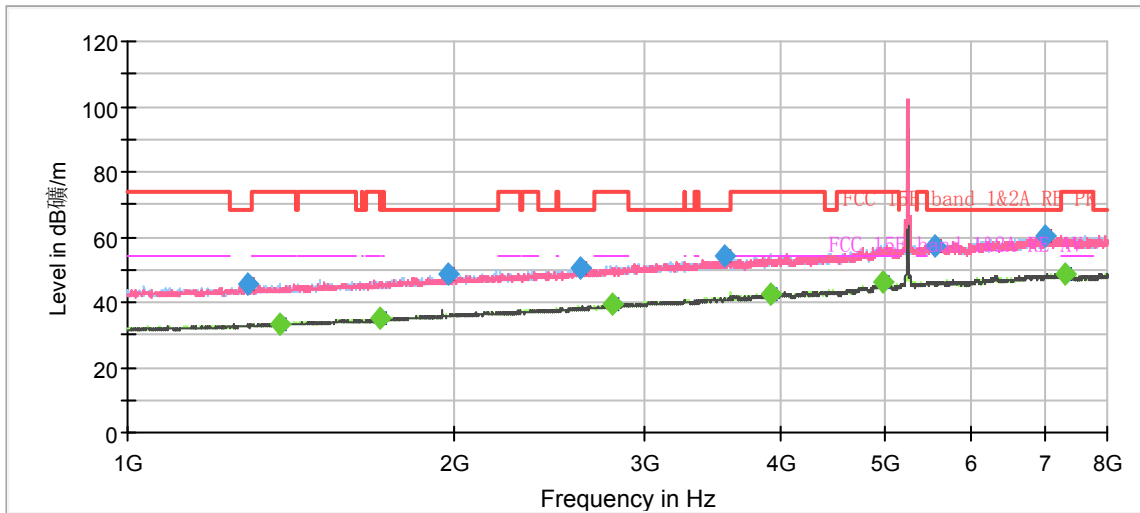

Radiates Emission from 1GHz to 8GHz
 Note: The signal beyond the limit is carrier.

Frequency (MHz)	Peak (dBuV/m)	Average (dBuV/m)	Limit (dBuV/m)	Margin (dB)	Height (cm)	Polarization	Azimuth (deg)	Correct Factor (dB)
1290.500000	45.74	---	68.20	22.46	200.0	H	359.0	-15.8
1383.250000	---	33.52	54.00	20.48	200.0	V	114.0	-15.4
1709.625000	---	34.79	54.00	19.21	200.0	H	329.0	-13.9
1972.125000	48.85	---	68.20	19.35	100.0	H	353.0	-12.7
2615.250000	50.58	---	68.20	17.62	100.0	V	6.0	-10.7
2802.500000	---	39.28	54.00	14.72	200.0	V	131.0	-9.9
3557.625000	53.93	---	68.20	14.27	200.0	H	248.0	-7.0
3919.000000	---	42.70	54.00	11.30	200.0	V	0.0	-5.9
4959.375000	---	46.24	54.00	7.76	200.0	H	329.0	-1.6
5542.125000	57.46	---	68.20	10.74	200.0	V	106.0	-0.4
7022.625000	60.56	---	68.20	7.64	200.0	H	264.0	2.3
7321.000000	---	48.64	54.00	5.36	200.0	H	240.0	2.9

Remark: 1. Correction Factor = Antenna factor+ Insertion loss (cable loss + amplifier gain)

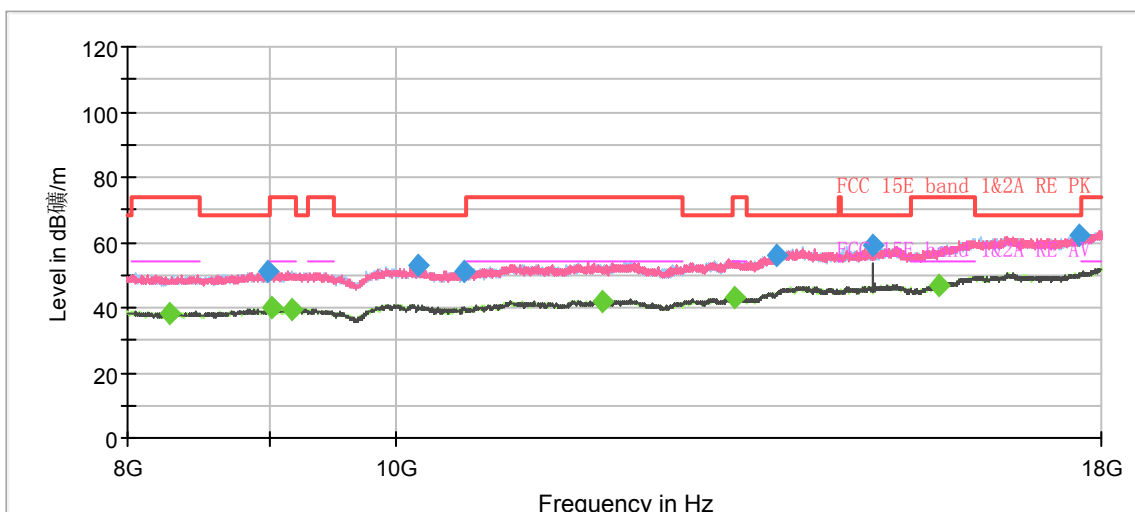

Radiates Emission from 8GHz to 18GHz

Frequency (MHz)	Peak (dBuV/m)	Average (dBuV/m)	Limit (dBuV/m)	Margin (dB)	Height (cm)	Polarization	Azimuth (deg)	Correct Factor (dB)
8286.250000	---	37.94	54.00	16.06	200.0	V	347.0	-7.5
8997.500000	51.18	---	68.20	17.02	200.0	H	250.0	-6.8
9017.500000	---	39.83	54.00	14.17	100.0	H	80.0	-6.7
9177.500000	---	39.39	54.00	14.61	100.0	H	0.0	-6.6
10191.250000	52.77	---	68.20	15.43	200.0	V	0.0	-5.3
10592.500000	51.28	---	68.20	16.92	100.0	V	0.0	-4.8
11873.750000	---	42.05	54.00	11.95	100.0	H	142.0	-3.8
13261.250000	---	43.34	54.00	10.66	100.0	H	191.0	-2.1
13732.500000	56.01	---	68.20	12.19	200.0	H	333.0	-0.2
14881.250000	59.19	---	68.20	9.01	100.0	V	0.0	1.8
15722.500000	---	46.70	54.00	7.30	200.0	H	298.0	2.7
17681.250000	61.88	---	68.20	6.32	100.0	V	0.0	5.2

Remark: 1. Correction Factor = Antenna factor+ Insertion loss (cable loss + amplifier gain)



802.11a CH149

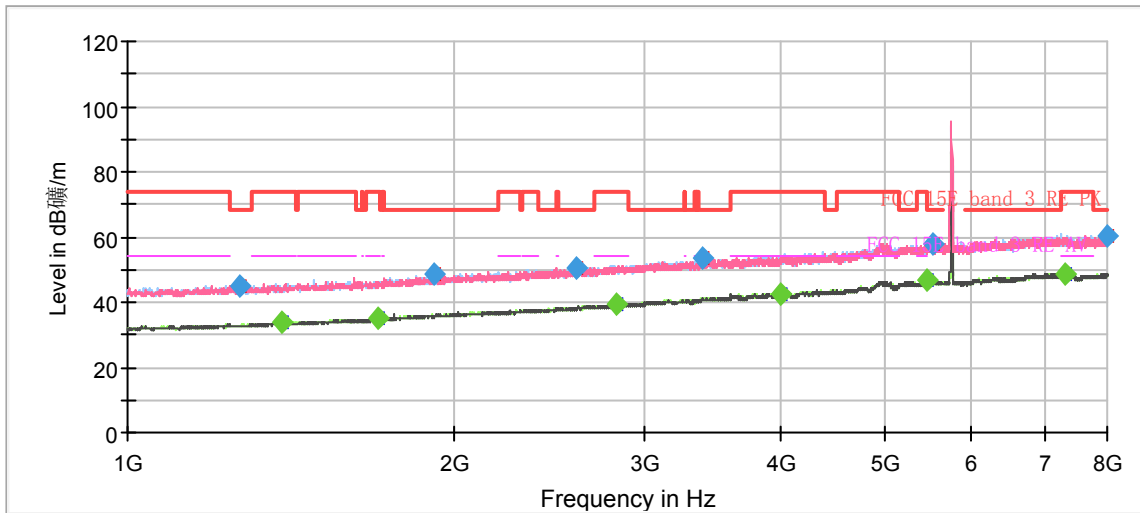

Radiates Emission from 1GHz to 8GHz
 Note: The signal beyond the limit is carrier.

Frequency (MHz)	Peak (dBuV/m)	Average (dBuV/m)	Limit (dBuV/m)	Margin (dB)	Height (cm)	Polarization	Azimuth (deg)	Correct Factor (dB)
1271.250000	44.69	---	68.20	23.51	200.0	V	203.0	-15.9
1390.250000	---	33.59	54.00	20.41	200.0	H	10.0	-15.4
1700.000000	---	34.98	54.00	19.02	200.0	H	238.0	-14.0
1917.875000	48.34	---	68.20	19.86	200.0	V	283.0	-12.9
2589.875000	50.73	---	68.20	17.47	200.0	H	180.0	-10.8
2821.750000	---	39.16	54.00	14.84	100.0	H	162.0	-9.8
3387.000000	53.65	---	68.20	14.55	200.0	H	106.0	-7.5
3999.500000	---	42.66	54.00	11.34	200.0	V	359.0	-5.4
5455.500000	---	46.53	54.00	7.47	200.0	H	33.0	-0.6
5536.000000	58.08	---	68.20	10.12	100.0	H	40.0	-0.4
7316.625000	---	48.57	54.00	5.43	200.0	V	348.0	2.9
7996.500000	60.41	---	68.20	7.79	200.0	H	106.0	2.5

Remark: 1. Correction Factor = Antenna factor+ Insertion loss (cable loss + amplifier gain)

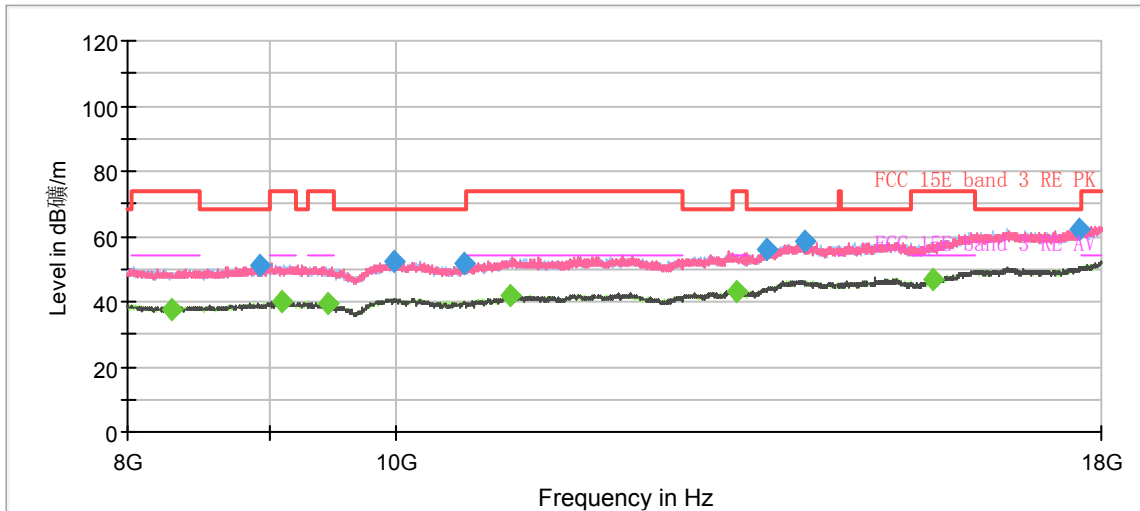

Radiates Emission from 8GHz to 18GHz

Frequency (MHz)	Peak (dBuV/m)	Average (dBuV/m)	Limit (dBuV/m)	Margin (dB)	Height (cm)	Polarization	Azimuth (deg)	Correct Factor (dB)
8303.750000	---	37.74	54.00	16.26	100.0	H	34.0	-7.5
8932.500000	50.81	---	68.20	17.39	200.0	V	215.0	-6.9
9095.000000	---	39.95	54.00	14.05	200.0	H	329.0	-6.7
9445.000000	---	39.67	54.00	14.33	200.0	V	48.0	-5.8
9990.000000	52.24	---	68.20	15.96	100.0	V	182.0	-5.4
10580.000000	51.49	---	68.20	16.71	200.0	H	315.0	-4.8
11008.750000	---	42.08	54.00	11.92	100.0	V	308.0	-4.8
13285.000000	---	43.29	54.00	10.71	100.0	H	82.0	-2.1
13630.000000	55.84	---	68.20	12.36	200.0	V	68.0	-0.6
14050.000000	58.24	---	68.20	9.96	200.0	V	26.0	0.7
15645.000000	---	46.91	54.00	7.09	100.0	H	264.0	2.3
17682.500000	62.22	---	68.20	5.98	200.0	V	20.0	5.2

Remark: 1. Correction Factor = Antenna factor+ Insertion loss (cable loss + amplifier gain)



802.11a CH157

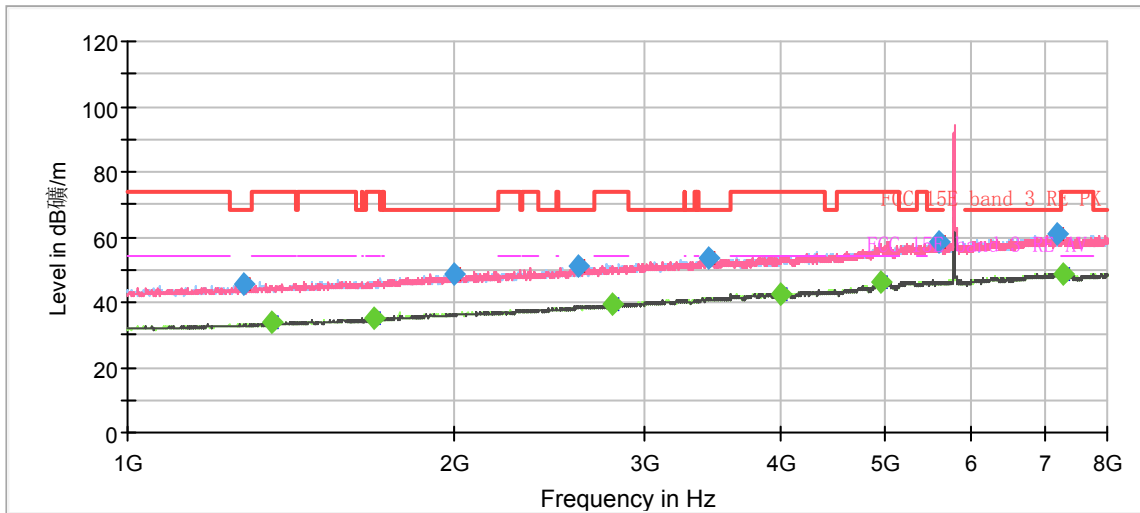

Radiates Emission from 1GHz to 8GHz
 Note: The signal beyond the limit is carrier.

Frequency (MHz)	Peak (dBuV/m)	Average (dBuV/m)	Limit (dBuV/m)	Margin (dB)	Height (cm)	Polarization	Azimuth (deg)	Correct Factor (dB)
1277.375000	45.32	---	68.20	22.88	200.0	H	10.0	-15.9
1357.875000	---	33.72	54.00	20.28	100.0	H	125.0	-15.5
1684.250000	---	35.04	54.00	18.96	200.0	H	0.0	-14.0
1996.625000	48.41	---	68.20	19.79	200.0	H	51.0	-12.5
2604.750000	51.33	---	68.20	16.87	200.0	H	92.0	-10.8
2797.250000	---	39.28	54.00	14.72	100.0	V	157.0	-9.9
3434.250000	53.57	---	68.20	14.63	200.0	H	67.0	-7.3
3996.000000	---	42.65	54.00	11.35	200.0	V	272.0	-5.4
4946.250000	---	46.31	54.00	7.69	200.0	V	320.0	-1.7
5599.000000	58.58	---	68.20	9.62	200.0	V	353.0	-0.4
7195.875000	60.65	---	68.20	7.55	200.0	V	141.0	2.7
7289.500000	---	48.58	54.00	5.42	100.0	V	214.0	2.9

Remark: 1. Correction Factor = Antenna factor+ Insertion loss (cable loss + amplifier gain)

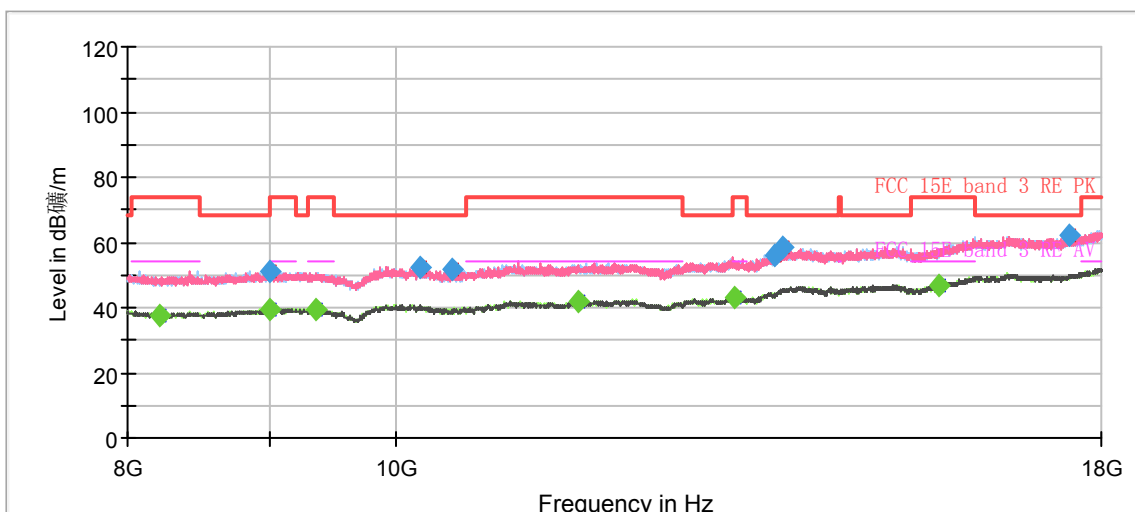

Radiates Emission from 8GHz to 18GHz

Frequency (MHz)	Peak (dBuV/m)	Average (dBuV/m)	Limit (dBuV/m)	Margin (dB)	Height (cm)	Polarization	Azimuth (deg)	Correct Factor (dB)
8220.000000	---	37.73	54.00	16.27	100.0	H	117.0	-7.5
8998.750000	51.00	---	68.20	17.20	100.0	V	168.0	-6.8
9011.250000	---	39.59	54.00	14.41	100.0	V	97.0	-6.7
9356.250000	---	39.36	54.00	14.64	200.0	V	192.0	-5.9
10203.750000	52.48	---	68.20	15.72	200.0	V	25.0	-5.3
10491.250000	51.82	---	68.20	16.38	200.0	V	25.0	-5.2
11646.250000	---	41.79	54.00	12.21	200.0	V	349.0	-3.4
13265.000000	---	43.28	54.00	10.72	100.0	H	76.0	-2.1
13706.250000	56.25	---	68.20	11.95	200.0	H	244.0	-0.3
13802.500000	58.47	---	68.20	9.73	100.0	H	83.0	0.2
15723.750000	---	46.83	54.00	7.17	200.0	V	136.0	2.7
17517.500000	61.90	---	68.20	6.30	200.0	V	46.0	5.2

Remark: 1. Correction Factor = Antenna factor+ Insertion loss (cable loss + amplifier gain)



802.11a CH165

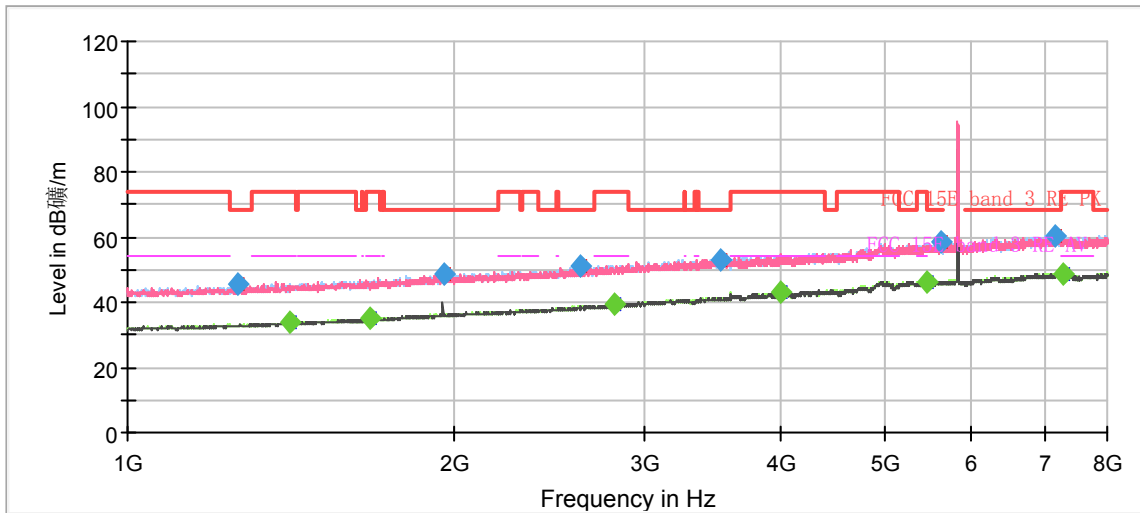

Radiates Emission from 1GHz to 8GHz
 Note: The signal beyond the limit is carrier.

Frequency (MHz)	Peak (dBuV/m)	Average (dBuV/m)	Limit (dBuV/m)	Margin (dB)	Height (cm)	Polarization	Azimuth (deg)	Correct Factor (dB)
1261.625000	45.28	---	68.20	22.92	100.0	V	126.0	-16.0
1413.875000	---	33.71	54.00	20.29	100.0	H	290.0	-15.3
1672.000000	---	34.87	54.00	19.13	200.0	V	228.0	-14.1
1956.375000	48.35	---	68.20	19.85	200.0	H	215.0	-12.8
2611.750000	50.80	---	68.20	17.40	200.0	H	158.0	-10.7
2805.125000	---	39.22	54.00	14.78	100.0	H	322.0	-9.9
3527.875000	53.19	---	68.20	15.01	200.0	V	179.0	-7.0
3998.625000	---	42.86	54.00	11.14	200.0	V	49.0	-5.4
5450.250000	---	46.34	54.00	7.66	100.0	H	355.0	-0.6
5609.500000	58.36	---	68.20	9.85	200.0	V	359.0	-0.4
7172.250000	60.45	---	68.20	7.75	100.0	H	0.0	2.6
7286.000000	---	48.72	54.00	5.28	100.0	H	186.0	2.9

Remark: 1. Correction Factor = Antenna factor+ Insertion loss (cable loss + amplifier gain)

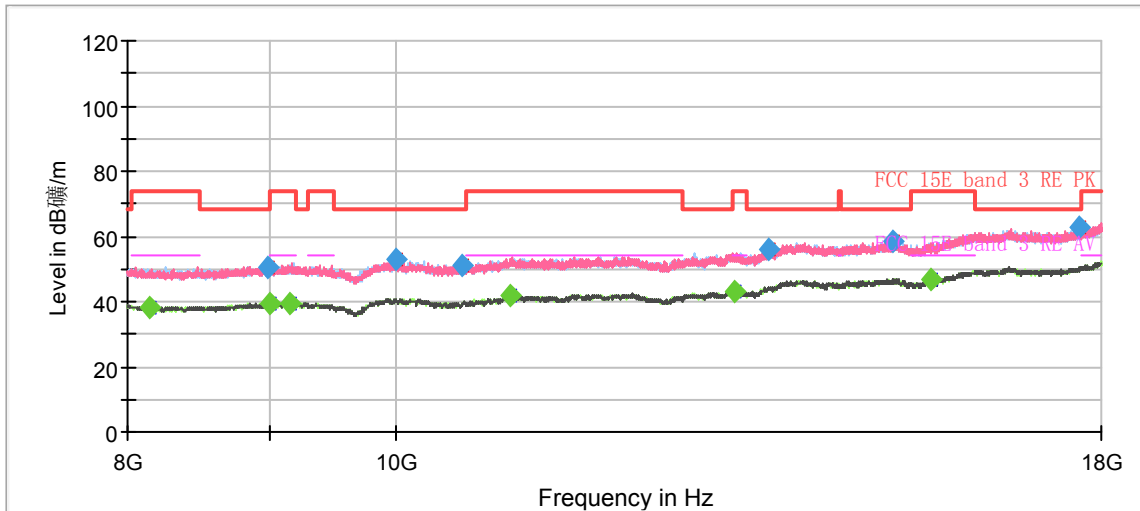

Radiates Emission from 8GHz to 18GHz

Frequency (MHz)	Peak (dBuV/m)	Average (dBuV/m)	Limit (dBuV/m)	Margin (dB)	Height (cm)	Polarization	Azimuth (deg)	Correct Factor (dB)
8147.500000	---	38.01	54.00	15.99	100.0	H	7.0	-7.6
8985.000000	50.74	---	68.20	17.46	200.0	V	4.0	-6.8
9006.250000	---	39.57	54.00	14.43	200.0	V	185.0	-6.7
9161.250000	---	39.44	54.00	14.56	200.0	H	318.0	-6.6
10005.000000	53.04	---	68.20	15.16	100.0	H	154.0	-5.4
10572.500000	51.27	---	68.20	16.93	200.0	H	332.0	-4.9
11006.250000	---	41.92	54.00	12.08	200.0	H	293.0	-4.8
13255.000000	---	43.28	54.00	10.72	100.0	V	296.0	-2.2
13646.250000	56.02	---	68.20	12.18	200.0	H	352.0	-0.6
15141.250000	58.29	---	68.20	9.91	200.0	H	325.0	1.8
15616.250000	---	46.73	54.00	7.27	100.0	H	147.0	2.1
17680.000000	62.88	---	68.20	5.32	100.0	H	91.0	5.2

Remark: 1. Correction Factor = Antenna factor+ Insertion loss (cable loss + amplifier gain)



802.11n (HT20) CH36

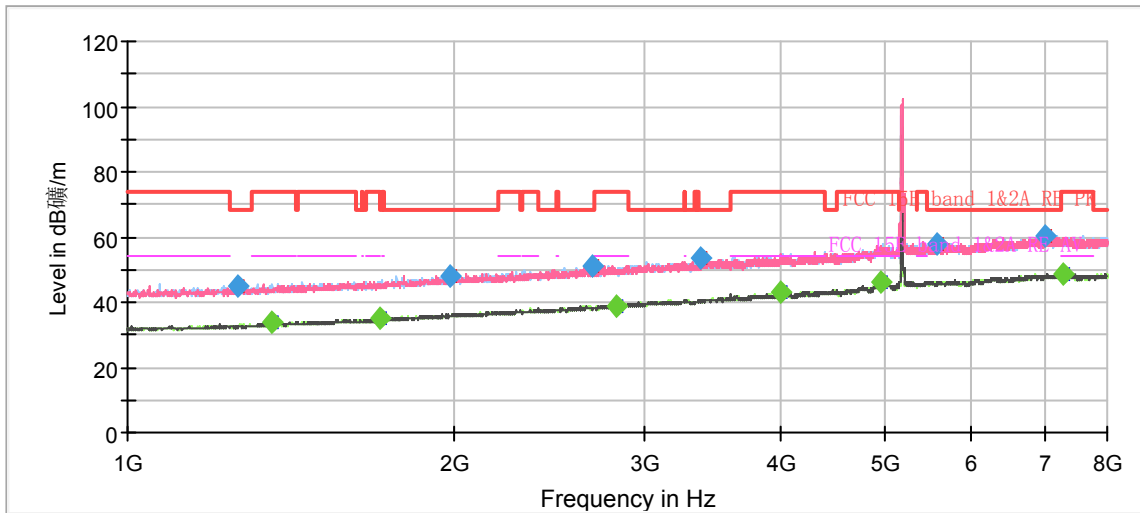

Radiates Emission from 1GHz to 8GHz
 Note: The signal beyond the limit is carrier.

Frequency (MHz)	Peak (dBuV/m)	Average (dBuV/m)	Limit (dBuV/m)	Margin (dB)	Height (cm)	Polarization	Azimuth (deg)	Correct Factor (dB)
1261.625000	45.23	---	68.20	22.97	200.0	H	288.0	-16.0
1359.625000	---	33.61	54.00	20.39	200.0	H	228.0	-15.5
1708.750000	---	34.96	54.00	19.04	200.0	H	0.0	-13.9
1979.125000	47.96	---	68.20	20.24	100.0	H	190.0	-12.7
2686.125000	50.85	---	68.20	17.35	200.0	H	305.0	-10.4
2827.875000	---	39.04	54.00	14.96	100.0	H	302.0	-9.8
3380.000000	53.55	---	68.20	14.65	200.0	H	0.0	-7.5
3999.500000	---	42.89	54.00	11.11	200.0	H	272.0	-5.4
4950.625000	---	46.32	54.00	7.68	100.0	H	0.0	-1.6
5573.625000	57.72	---	68.20	10.48	100.0	H	358.0	-0.4
7017.375000	60.61	---	68.20	7.59	100.0	V	30.0	2.3
7290.375000	---	48.45	54.00	5.55	100.0	V	241.0	2.9

Remark: 1. Correction Factor = Antenna factor+ Insertion loss (cable loss + amplifier gain)

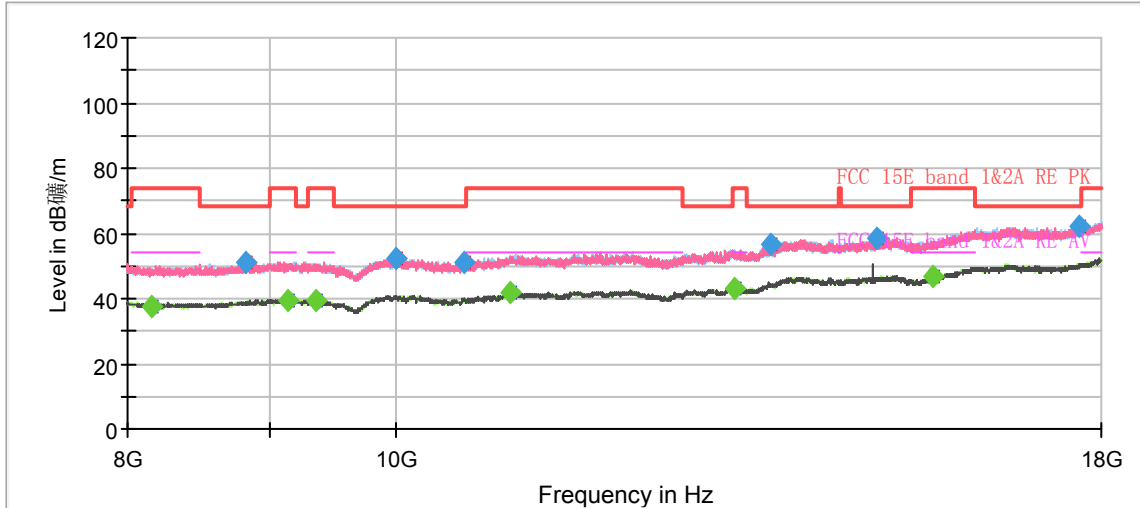

Radiates Emission from 8GHz to 18GHz

Frequency (MHz)	Peak (dBuV/m)	Average (dBuV/m)	Limit (dBuV/m)	Margin (dB)	Height (cm)	Polarization	Azimuth (deg)	Correct Factor (dB)
8163.750000	---	37.80	54.00	16.20	200.0	H	241.0	-7.6
8835.000000	51.03	---	68.20	17.17	100.0	H	13.0	-6.9
9146.250000	---	39.52	54.00	14.48	100.0	H	251.0	-6.6
9353.750000	---	39.61	54.00	14.39	100.0	V	111.0	-5.9
9998.750000	52.11	---	68.20	16.09	100.0	H	313.0	-5.4
10582.500000	50.82	---	68.20	17.38	100.0	V	181.0	-4.8
10998.750000	---	41.99	54.00	12.01	200.0	H	45.0	-4.8
13257.500000	---	43.29	54.00	10.71	100.0	H	251.0	-2.2
13667.500000	56.41	---	68.20	11.79	100.0	H	292.0	-0.5
14928.750000	58.65	---	68.20	9.55	100.0	V	348.0	1.6
15640.000000	---	46.69	54.00	7.31	200.0	H	206.0	2.2
17675.000000	62.40	---	68.20	5.80	100.0	H	188.0	5.2

Remark: 1. Correction Factor = Antenna factor+ Insertion loss (cable loss + amplifier gain)



802.11n (HT20) CH40

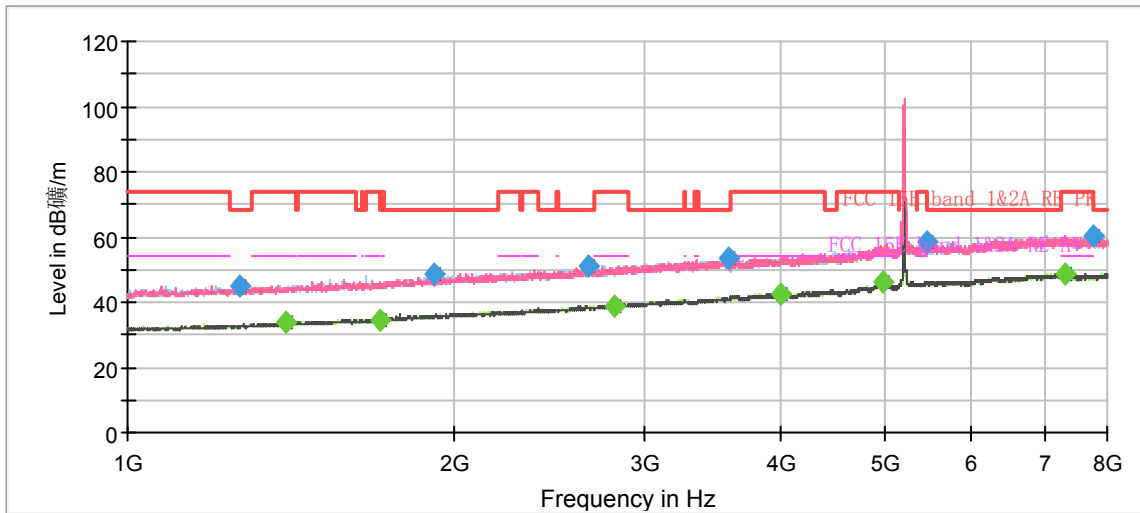

Radiates Emission from 1GHz to 8GHz
 Note: The signal beyond the limit is carrier.

Frequency (MHz)	Peak (dBuV/m)	Average (dBuV/m)	Limit (dBuV/m)	Margin (dB)	Height (cm)	Polarization	Azimuth (deg)	Correct Factor (dB)
1269.500000	45.19	---	68.20	23.01	200.0	H	272.0	-15.9
1397.250000	---	33.73	54.00	20.27	200.0	H	280.0	-15.4
1705.250000	---	34.73	54.00	19.27	200.0	V	81.0	-13.9
1917.000000	48.53	---	68.20	19.67	100.0	V	188.0	-12.9
2663.375000	51.04	---	68.20	17.16	200.0	V	0.0	-10.5
2810.375000	---	39.06	54.00	14.94	200.0	H	305.0	-9.9
3583.000000	53.68	---	68.20	14.52	200.0	H	0.0	-6.8
3998.625000	---	42.55	54.00	11.45	200.0	H	1.0	-5.4
4963.750000	---	46.17	54.00	7.83	200.0	V	97.0	-1.5
5464.250000	58.26	---	68.20	9.94	200.0	H	10.0	-0.6
7301.750000	---	48.54	54.00	5.46	200.0	H	178.0	2.9
7752.375000	60.01	---	68.20	8.19	200.0	V	0.0	2.4

Remark: 1. Correction Factor = Antenna factor+ Insertion loss (cable loss + amplifier gain)

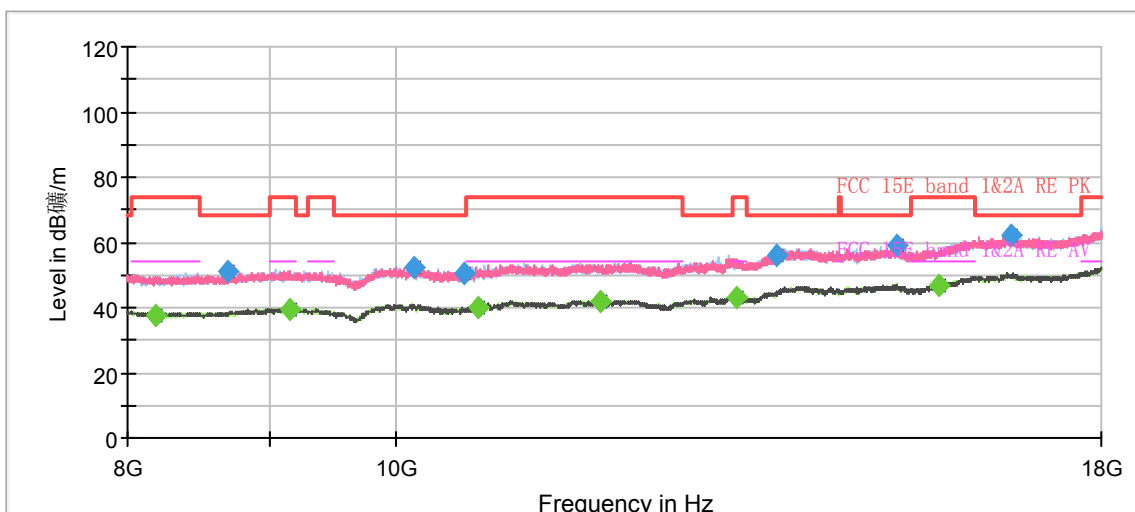

Radiates Emission from 8GHz to 18GHz

Frequency (MHz)	Peak (dBuV/m)	Average (dBuV/m)	Limit (dBuV/m)	Margin (dB)	Height (cm)	Polarization	Azimuth (deg)	Correct Factor (dB)
8182.500000	---	37.77	54.00	16.23	200.0	H	9.0	-7.5
8702.500000	51.05	---	68.20	17.15	200.0	H	228.0	-7.2
9158.750000	---	39.54	54.00	14.46	100.0	V	219.0	-6.6
10155.000000	52.30	---	68.20	15.90	100.0	V	57.0	-5.4
10587.500000	50.77	---	68.20	17.43	200.0	H	202.0	-4.8
10710.000000	---	40.12	54.00	13.88	200.0	H	0.0	-4.8
11868.750000	---	42.05	54.00	11.95	200.0	H	189.0	-3.8
13277.500000	---	43.34	54.00	10.66	100.0	V	0.0	-2.1
13733.750000	55.79	---	68.20	12.41	100.0	V	199.0	-0.2
15188.750000	59.04	---	68.20	9.16	100.0	V	71.0	1.8
15720.000000	---	46.53	54.00	7.47	200.0	V	338.0	2.7
16711.250000	61.99	---	68.20	6.21	100.0	V	22.0	5.6

Remark: 1. Correction Factor = Antenna factor+ Insertion loss (cable loss + amplifier gain)



802.11n (HT20) CH48

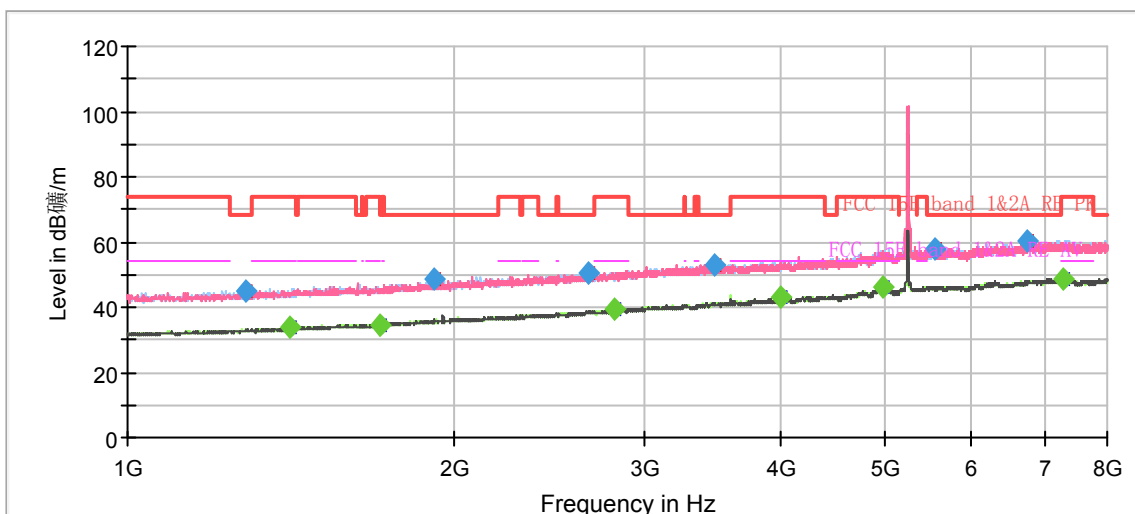

Radiates Emission from 1GHz to 8GHz

Note: The signal beyond the limit is carrier.

Frequency (MHz)	Peak (dBuV/m)	Average (dBuV/m)	Limit (dBuV/m)	Margin (dB)	Height (cm)	Polarization	Azimuth (deg)	Correct Factor (dB)
1286.125000	44.65	---	68.20	23.55	200.0	V	98.0	-15.8
1409.500000	---	33.63	54.00	20.37	100.0	H	311.0	-15.3
1708.750000	---	34.72	54.00	19.28	100.0	H	295.0	-13.9
1915.250000	48.88	---	68.20	19.32	200.0	V	40.0	-12.9
2659.000000	50.40	---	68.20	17.80	200.0	H	177.0	-10.5
2806.875000	---	39.15	54.00	14.85	200.0	H	208.0	-9.9
3479.750000	53.09	---	68.20	15.11	200.0	V	90.0	-7.1
3991.625000	---	42.86	54.00	11.14	200.0	V	57.0	-5.4
4960.250000	---	46.18	54.00	7.82	200.0	H	262.0	-1.6
5553.500000	57.60	---	68.20	10.60	100.0	V	175.0	-0.4
6744.375000	60.21	---	68.20	7.99	100.0	H	335.0	2.2
7294.750000	---	48.58	54.00	5.42	200.0	H	160.0	2.9

Remark: 1. Correction Factor = Antenna factor+ Insertion loss (cable loss + amplifier gain)

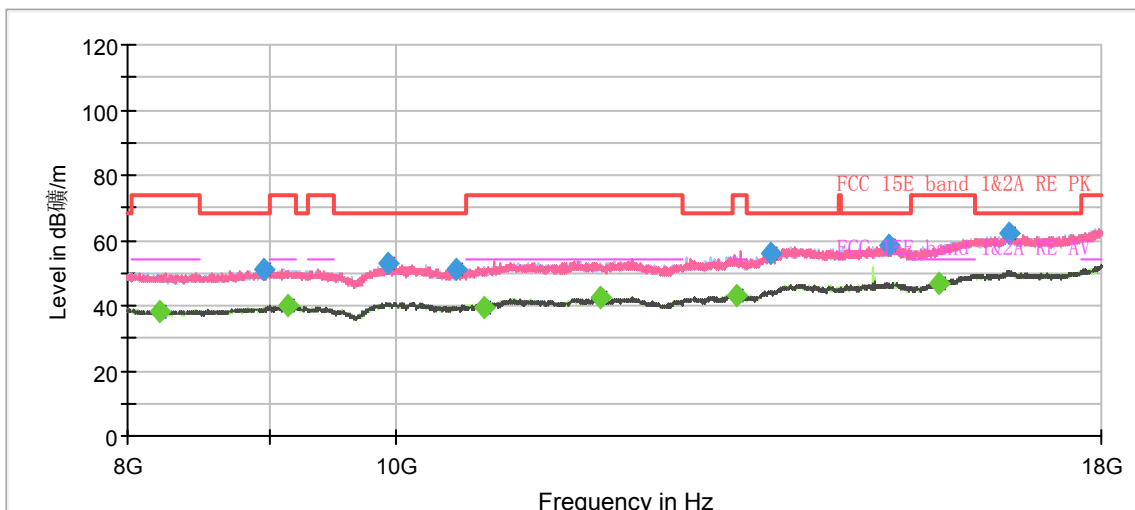

Radiates Emission from 8GHz to 18GHz

Frequency (MHz)	Peak (dBuV/m)	Average (dBuV/m)	Limit (dBuV/m)	Margin (dB)	Height (cm)	Polarization	Azimuth (deg)	Correct Factor (dB)
8211.250000	---	37.89	54.00	16.11	100.0	V	73.0	-7.5
8956.250000	50.90	---	68.20	17.30	200.0	H	28.0	-6.9
9136.250000	---	39.92	54.00	14.08	200.0	V	314.0	-6.7
9938.750000	52.62	---	68.20	15.58	200.0	H	3.0	-5.3
10512.500000	51.12	---	68.20	17.08	100.0	H	65.0	-5.1
10765.000000	---	39.62	54.00	14.38	200.0	H	250.0	-4.7
11865.000000	---	42.18	54.00	11.82	100.0	V	17.0	-3.8
13280.000000	---	43.18	54.00	10.82	200.0	V	252.0	-2.1
13668.750000	56.07	---	68.20	12.13	100.0	V	104.0	-0.5
15076.250000	58.47	---	68.20	9.73	100.0	V	279.0	1.7
15721.250000	---	46.66	54.00	7.34	200.0	H	138.0	2.7
16668.750000	61.87	---	68.20	6.33	200.0	V	70.0	5.6

Remark: 1. Correction Factor = Antenna factor+ Insertion loss (cable loss + amplifier gain)



802.11n (HT20) CH149

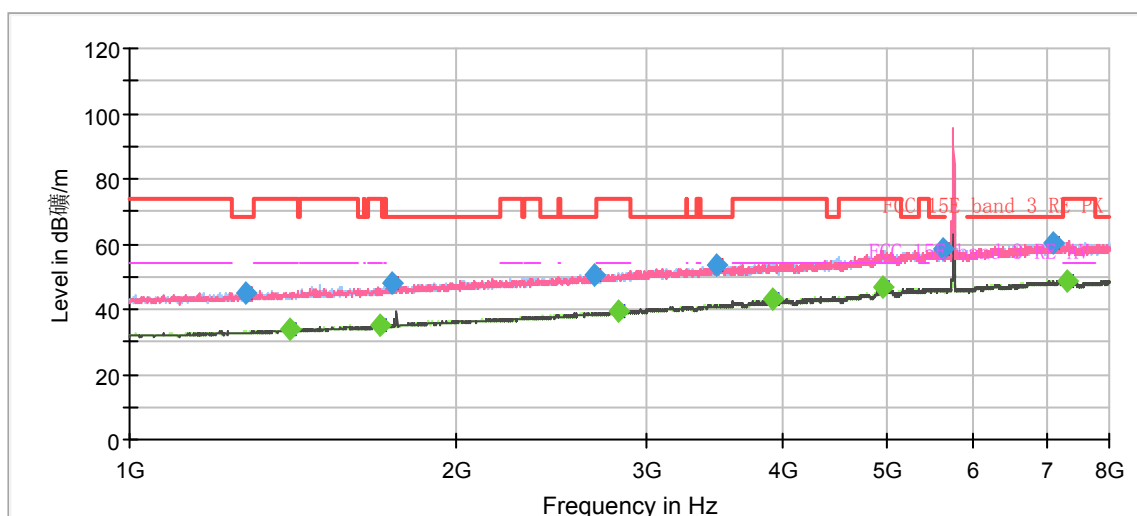

Radiates Emission from 1GHz to 8GHz
 Note: The signal beyond the limit is carrier.

Frequency (MHz)	Peak (dBuV/m)	Average (dBuV/m)	Limit (dBuV/m)	Margin (dB)	Height (cm)	Polarization	Azimuth (deg)	Correct Factor (dB)
1278.250000	44.69	---	68.20	23.51	200.0	H	34.0	-15.9
1406.875000	---	33.70	54.00	20.30	200.0	H	46.0	-15.3
1700.000000	---	34.87	54.00	19.13	200.0	H	70.0	-14.0
1748.125000	48.21	---	68.20	19.99	200.0	V	279.0	-13.7
2678.250000	50.56	---	68.20	17.64	100.0	V	148.0	-10.4
2826.125000	---	39.14	54.00	14.86	200.0	H	3.0	-9.8
3471.000000	53.49	---	68.20	14.71	100.0	V	35.0	-7.1
3911.125000	---	42.79	54.00	11.21	200.0	V	57.0	-5.9
4950.625000	---	46.65	54.00	7.35	200.0	H	0.0	-1.6
5625.250000	58.31	---	68.20	9.89	200.0	V	198.0	-0.3
7091.750000	60.42	---	68.20	7.78	200.0	H	126.0	2.4
7313.125000	---	48.68	54.00	5.32	200.0	H	78.0	2.9

Remark: 1. Correction Factor = Antenna factor+ Insertion loss (cable loss + amplifier gain)

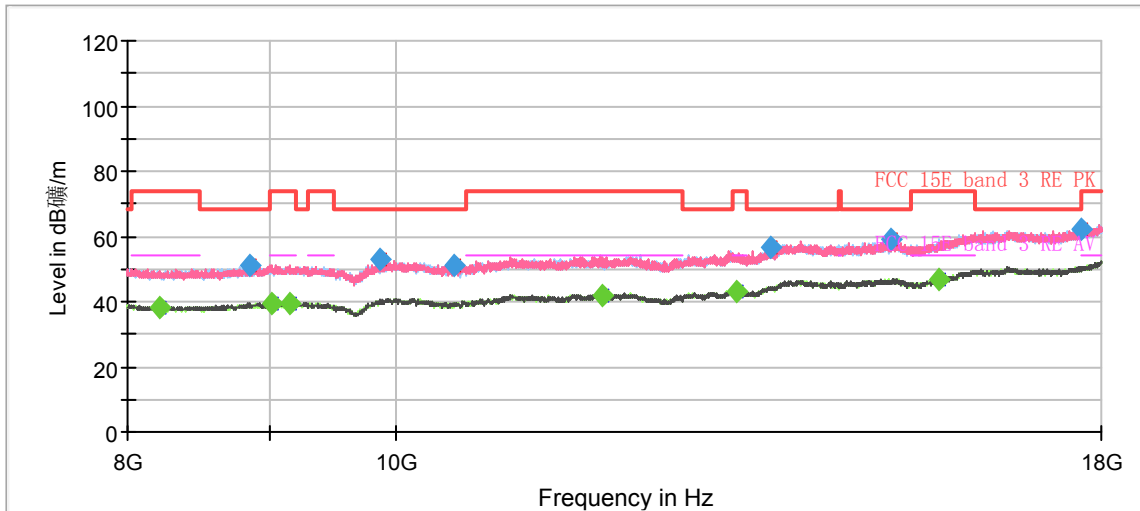

Radiates Emission from 8GHz to 18GHz

Frequency (MHz)	Peak (dBuV/m)	Average (dBuV/m)	Limit (dBuV/m)	Margin (dB)	Height (cm)	Polarization	Azimuth (deg)	Correct Factor (dB)
8222.500000	---	37.92	54.00	16.08	100.0	H	246.0	-7.5
8855.000000	51.23	---	68.20	16.97	100.0	V	20.0	-6.9
9018.750000	---	39.58	54.00	14.42	200.0	H	192.0	-6.7
9161.250000	---	39.55	54.00	14.45	200.0	V	357.0	-6.6
9878.750000	52.88	---	68.20	15.32	100.0	H	301.0	-5.4
10502.500000	51.12	---	68.20	17.08	100.0	V	13.0	-5.1
11876.250000	---	42.08	54.00	11.92	200.0	V	125.0	-3.8
13283.750000	---	43.20	54.00	10.80	100.0	H	301.0	-2.1
13658.750000	56.37	---	68.20	11.83	100.0	V	130.0	-0.5
15113.750000	58.98	---	68.20	9.23	200.0	V	202.0	1.7
15723.750000	---	46.72	54.00	7.28	100.0	H	273.0	2.7
17692.500000	61.94	---	68.20	6.26	200.0	V	139.0	5.1

Remark: 1. Correction Factor = Antenna factor+ Insertion loss (cable loss + amplifier gain)



802.11n (HT20) CH157

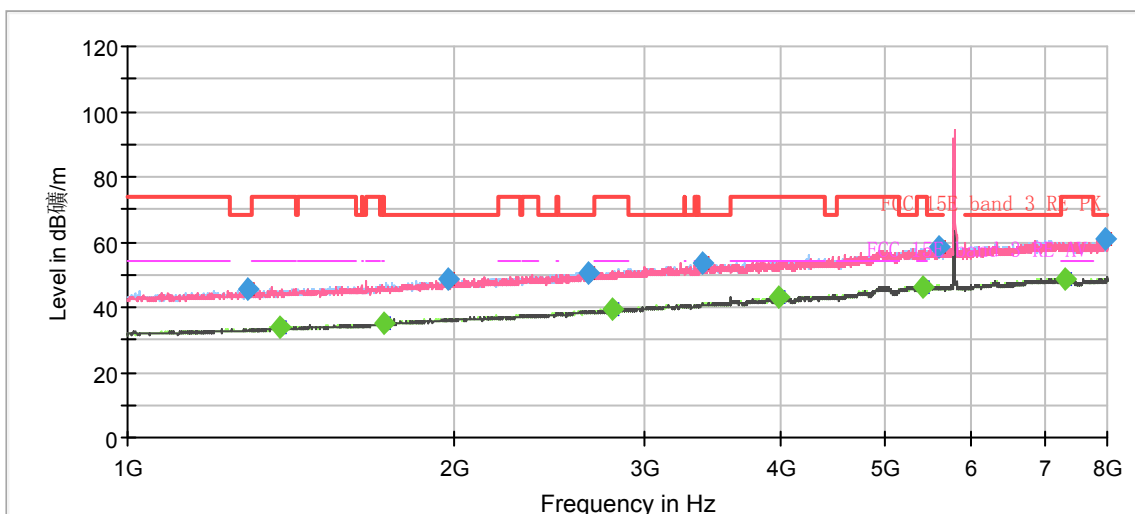

Radiates Emission from 1GHz to 8GHz
 Note: The signal beyond the limit is carrier.

Frequency (MHz)	Peak (dBuV/m)	Average (dBuV/m)	Limit (dBuV/m)	Margin (dB)	Height (cm)	Polarization	Azimuth (deg)	Correct Factor (dB)
1292.250000	45.55	---	68.20	22.65	100.0	H	235.0	-15.8
1383.250000	---	33.80	54.00	20.20	200.0	V	287.0	-15.4
1720.125000	---	34.86	54.00	19.14	200.0	V	130.0	-13.8
1973.000000	48.42	---	68.20	19.78	200.0	H	136.0	-12.7
2655.500000	50.52	---	68.20	17.68	200.0	V	235.0	-10.5
2793.750000	---	39.29	54.00	14.71	100.0	H	267.0	-9.9
3395.750000	53.56	---	68.20	14.64	100.0	H	73.0	-7.5
3989.875000	---	42.98	54.00	11.02	200.0	V	0.0	-5.5
5410.875000	---	46.25	54.00	7.75	100.0	V	163.0	-0.8
5591.125000	58.64	---	68.20	9.56	100.0	V	0.0	-0.4
7311.375000	---	48.74	54.00	5.26	200.0	V	279.0	2.9
7965.000000	60.83	---	68.20	7.37	100.0	H	340.0	2.5

Remark: 1. Correction Factor = Antenna factor+ Insertion loss (cable loss + amplifier gain)

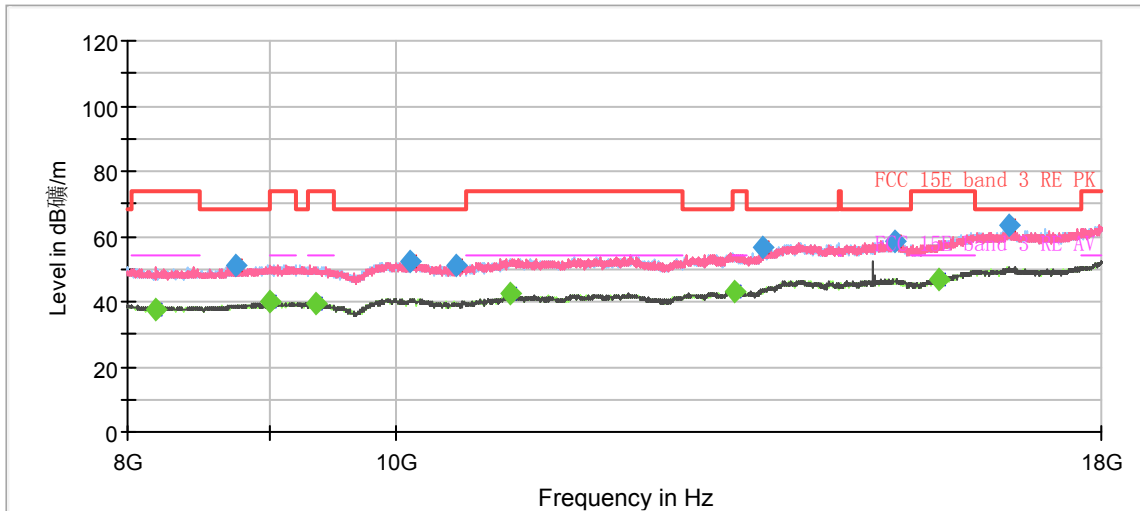

Radiates Emission from 8GHz to 18GHz

Frequency (MHz)	Peak (dBuV/m)	Average (dBuV/m)	Limit (dBuV/m)	Margin (dB)	Height (cm)	Polarization	Azimuth (deg)	Correct Factor (dB)
8186.250000	---	37.76	54.00	16.24	100.0	H	205.0	-7.5
8748.750000	51.19	---	68.20	17.01	100.0	H	310.0	-7.1
9003.750000	---	39.73	54.00	14.27	200.0	V	0.0	-6.7
9357.500000	---	39.62	54.00	14.38	100.0	V	80.0	-5.9
10130.000000	52.08	---	68.20	16.12	100.0	V	0.0	-5.4
10523.750000	51.24	---	68.20	16.96	100.0	V	192.0	-5.1
11005.000000	---	42.28	54.00	11.72	100.0	H	0.0	-4.8
13258.750000	---	43.34	54.00	10.66	100.0	V	23.0	-2.2
13583.750000	56.46	---	68.20	11.74	100.0	H	282.0	-0.8
15157.500000	58.63	---	68.20	9.57	200.0	H	266.0	1.8
15721.250000	---	46.86	54.00	7.14	100.0	V	30.0	2.7
16663.750000	63.19	---	68.20	5.01	100.0	H	111.0	5.6

Remark: 1. Correction Factor = Antenna factor+ Insertion loss (cable loss + amplifier gain)



802.11n (HT20) CH165

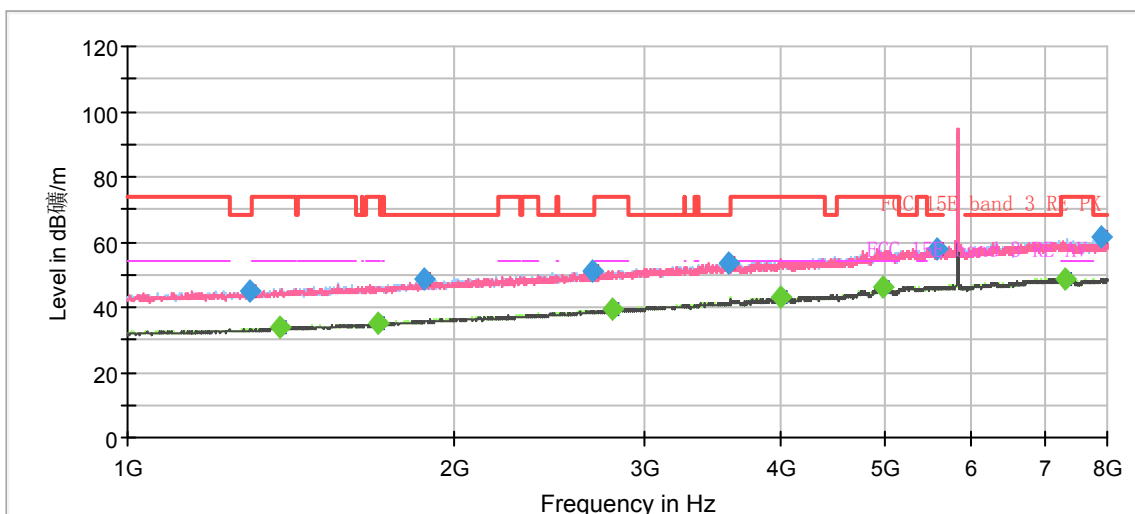

Radiates Emission from 1GHz to 8GHz
 Note: The signal beyond the limit is carrier.

Frequency (MHz)	Peak (dBuV/m)	Average (dBuV/m)	Limit (dBuV/m)	Margin (dB)	Height (cm)	Polarization	Azimuth (deg)	Correct Factor (dB)
1295.750000	45.13	---	68.20	23.07	200.0	H	3.0	-15.8
1379.750000	---	33.71	54.00	20.29	100.0	H	112.0	-15.4
1703.500000	---	35.20	54.00	18.80	200.0	H	207.0	-13.9
1878.500000	48.36	---	68.20	19.84	100.0	H	290.0	-13.1
2686.125000	50.80	---	68.20	17.40	200.0	V	327.0	-10.4
2800.750000	---	39.39	54.00	14.61	200.0	H	3.0	-9.9
3579.500000	53.34	---	68.20	14.86	200.0	V	246.0	-6.9
3996.000000	---	43.04	54.00	10.96	200.0	H	110.0	-5.4
4960.250000	---	46.29	54.00	7.71	200.0	H	118.0	-1.6
5568.375000	57.96	---	68.20	10.24	200.0	H	35.0	-0.4
7312.250000	---	48.49	54.00	5.51	200.0	H	10.0	2.9
7894.125000	61.41	---	68.20	6.79	200.0	V	157.0	2.5

Remark: 1. Correction Factor = Antenna factor+ Insertion loss (cable loss + amplifier gain)

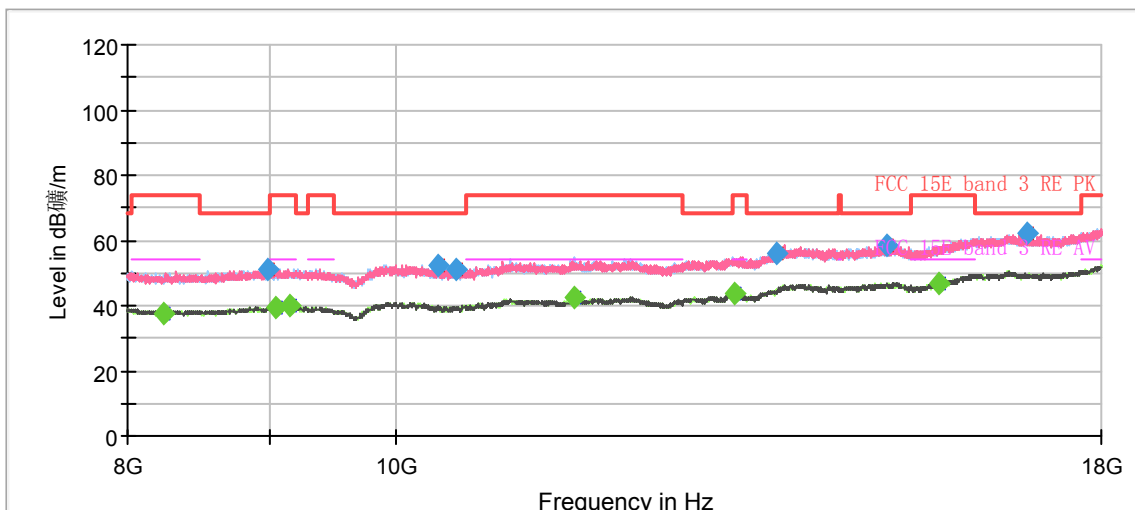

Radiates Emission from 8GHz to 18GHz

Frequency (MHz)	Peak (dBuV/m)	Average (dBuV/m)	Limit (dBuV/m)	Margin (dB)	Height (cm)	Polarization	Azimuth (deg)	Correct Factor (dB)
8241.250000	---	37.73	54.00	16.27	100.0	V	0.0	-7.5
8991.250000	51.18	---	68.20	17.02	200.0	V	0.0	-6.8
9047.500000	---	39.63	54.00	14.37	100.0	H	238.0	-6.6
9160.000000	---	39.72	54.00	14.28	200.0	H	215.0	-6.6
10365.000000	52.44	---	68.20	15.76	100.0	V	21.0	-5.2
10513.750000	51.00	---	68.20	17.20	100.0	V	200.0	-5.1
11606.250000	---	42.16	54.00	11.84	200.0	V	42.0	-3.4
13260.000000	---	43.47	54.00	10.53	100.0	H	300.0	-2.2
13731.250000	55.74	---	68.20	12.46	200.0	H	215.0	-0.2
15048.750000	58.57	---	68.20	9.63	200.0	V	105.0	1.6
15716.250000	---	46.76	54.00	7.24	200.0	V	350.0	2.6
16920.000000	62.03	---	68.20	6.17	100.0	V	96.0	5.2

Remark: 1. Correction Factor = Antenna factor+ Insertion loss (cable loss + amplifier gain)



802.11n (HT40) CH38

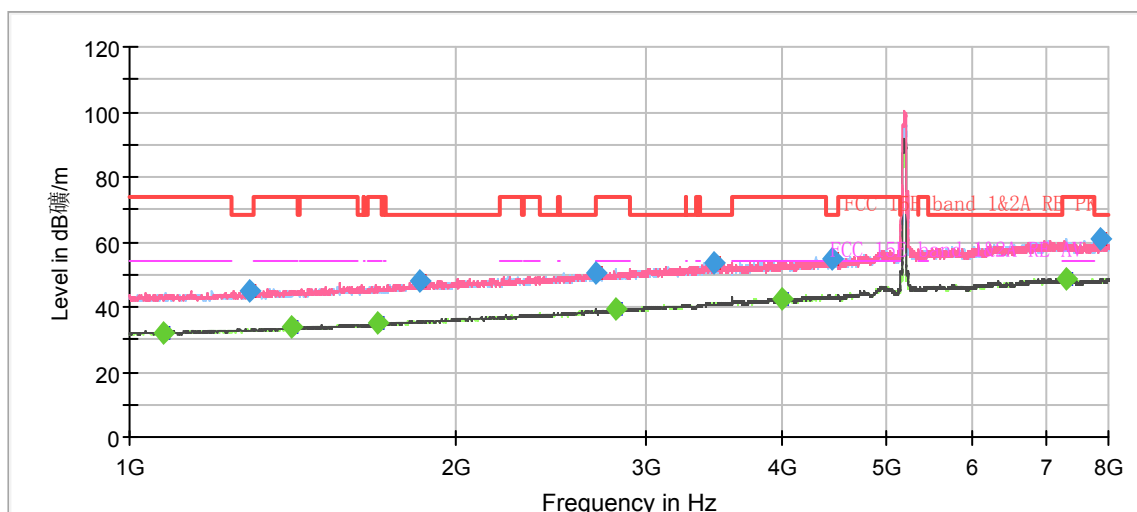

Radiates Emission from 1GHz to 8GHz

Note: The signal beyond the limit is carrier.

Frequency (MHz)	Peak (dBuV/m)	Average (dBuV/m)	Limit (dBuV/m)	Margin (dB)	Height (cm)	Polarization	Azimuth (deg)	Correct Factor (dB)
1074.375000	---	32.08	54.00	21.92	200.0	H	288.0	-16.8
1292.250000	44.99	---	68.20	23.21	200.0	V	296.0	-15.8
1409.500000	---	33.69	54.00	20.31	200.0	V	236.0	-15.3
1694.750000	---	34.81	54.00	19.19	100.0	H	0.0	-14.0
1851.375000	48.25	---	68.20	19.95	100.0	V	50.0	-13.2
2689.625000	50.48	---	68.20	17.72	200.0	H	79.0	-10.4
2806.000000	---	39.17	54.00	14.83	200.0	H	239.0	-9.9
3461.375000	53.63	---	68.20	14.57	200.0	V	261.0	-7.2
3998.625000	---	42.72	54.00	11.28	100.0	H	0.0	-5.4
4446.625000	54.52	---	68.20	13.68	200.0	H	200.0	-4.2
7301.750000	---	48.65	54.00	5.35	200.0	V	73.0	2.9
7860.000000	60.94	---	68.20	7.26	200.0	H	184.0	2.6

Remark: 1. Correction Factor = Antenna factor+ Insertion loss (cable loss + amplifier gain)

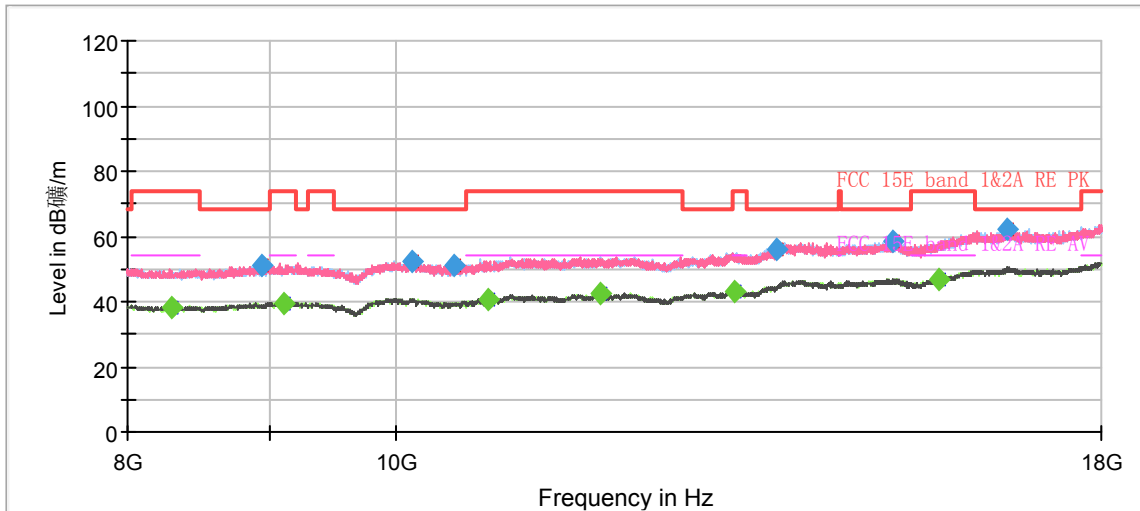

Radiates Emission from 8GHz to 18GHz

Frequency (MHz)	Peak (dBuV/m)	Average (dBuV/m)	Limit (dBuV/m)	Margin (dB)	Height (cm)	Polarization	Azimuth (deg)	Correct Factor (dB)
8293.750000	---	38.02	54.00	15.98	100.0	V	312.0	-7.5
8951.250000	51.11	---	68.20	17.09	100.0	H	263.0	-6.9
9116.250000	---	39.60	54.00	14.40	100.0	V	80.0	-6.7
10146.250000	52.16	---	68.20	16.04	200.0	H	227.0	-5.4
10506.250000	50.96	---	68.20	17.24	200.0	V	180.0	-5.1
10800.000000	---	40.73	54.00	13.27	100.0	H	115.0	-4.7
11865.000000	---	42.31	54.00	11.69	200.0	V	271.0	-3.8
13261.250000	---	43.18	54.00	10.82	100.0	H	192.0	-2.1
13733.750000	55.92	---	68.20	12.28	100.0	H	143.0	-0.2
15143.750000	58.28	---	68.20	9.92	200.0	V	98.0	1.8
15712.500000	---	46.76	54.00	7.24	100.0	V	25.0	2.6
16638.750000	62.02	---	68.20	6.18	100.0	H	298.0	5.6

Remark: 1. Correction Factor = Antenna factor+ Insertion loss (cable loss + amplifier gain)



802.11n (HT40) CH46

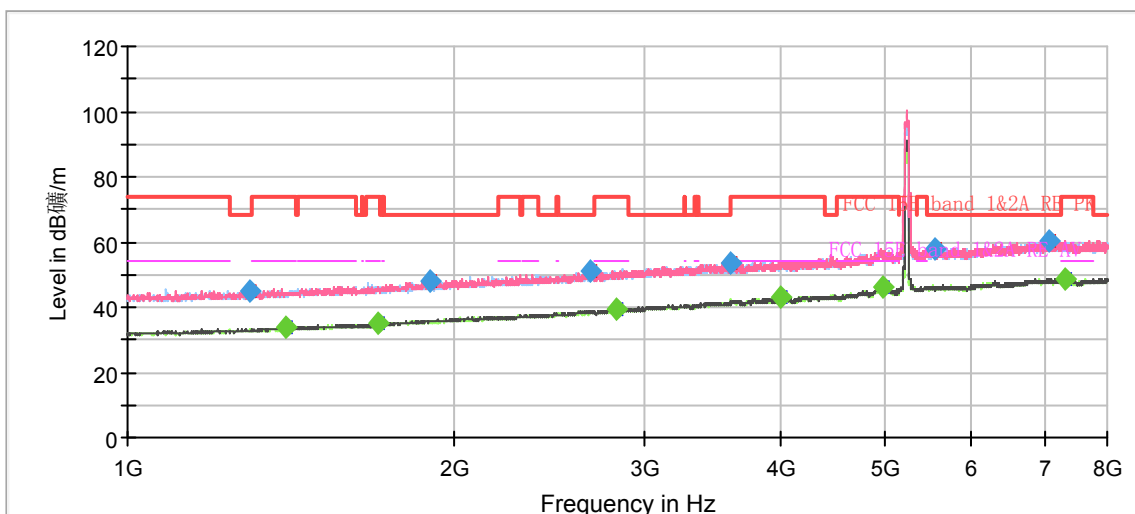

Radiates Emission from 1GHz to 8GHz

Note: The signal beyond the limit is carrier.

Frequency (MHz)	Peak (dBuV/m)	Average (dBuV/m)	Limit (dBuV/m)	Margin (dB)	Height (cm)	Polarization	Azimuth (deg)	Correct Factor (dB)
1298.375000	44.65	---	68.20	23.55	200.0	V	326.0	-15.8
1401.625000	---	33.60	54.00	20.40	200.0	V	253.0	-15.3
1702.625000	---	34.78	54.00	19.22	200.0	V	98.0	-13.9
1903.000000	48.03	---	68.20	20.17	200.0	H	1.0	-13.0
2670.375000	51.14	---	68.20	17.06	200.0	V	146.0	-10.5
2820.875000	---	39.19	54.00	14.81	200.0	V	277.0	-9.8
3590.875000	53.71	---	68.20	14.49	200.0	V	318.0	-6.8
3998.625000	---	42.97	54.00	11.03	200.0	V	342.0	-5.4
4968.125000	---	46.29	54.00	7.71	200.0	V	212.0	-1.5
5550.000000	57.92	---	68.20	10.28	100.0	H	350.0	-0.4
7076.000000	60.56	---	68.20	7.64	200.0	V	302.0	2.4
7314.875000	---	48.61	54.00	5.39	200.0	V	236.0	2.9

Remark: 1. Correction Factor = Antenna factor+ Insertion loss (cable loss + amplifier gain)

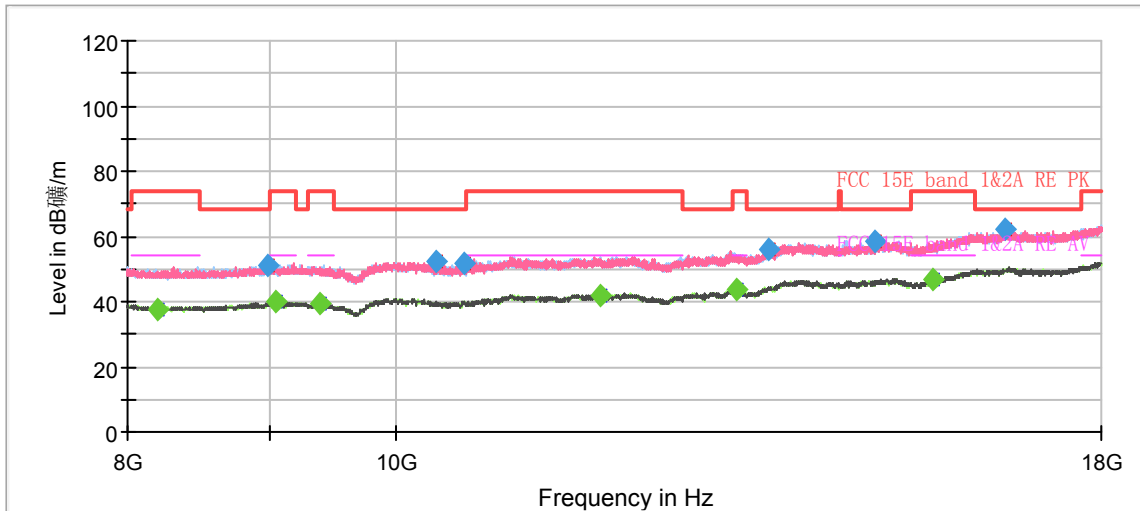

Radiates Emission from 8GHz to 18GHz

Frequency (MHz)	Peak (dBuV/m)	Average (dBuV/m)	Limit (dBuV/m)	Margin (dB)	Height (cm)	Polarization	Azimuth (deg)	Correct Factor (dB)
8202.500000	---	37.83	54.00	16.17	200.0	V	336.0	-7.5
8991.250000	50.93	---	68.20	17.27	200.0	H	132.0	-6.8
9048.750000	---	39.81	54.00	14.19	200.0	V	218.0	-6.6
9388.750000	---	39.44	54.00	14.56	200.0	V	336.0	-5.8
10350.000000	52.12	---	68.20	16.08	200.0	H	125.0	-5.2
10590.000000	51.79	---	68.20	16.41	200.0	H	181.0	-4.8
11868.750000	---	42.03	54.00	11.97	100.0	H	267.0	-3.8
13280.000000	---	43.48	54.00	10.52	100.0	V	88.0	-2.1
13653.750000	55.77	---	68.20	12.44	100.0	H	232.0	-0.5
14910.000000	58.50	---	68.20	9.70	100.0	V	40.0	1.7
15643.750000	---	46.96	54.00	7.04	200.0	H	20.0	2.3
16622.500000	62.16	---	68.20	6.04	100.0	H	0.0	5.5

Remark: 1. Correction Factor = Antenna factor+ Insertion loss (cable loss + amplifier gain)



802.11n (HT40) CH151

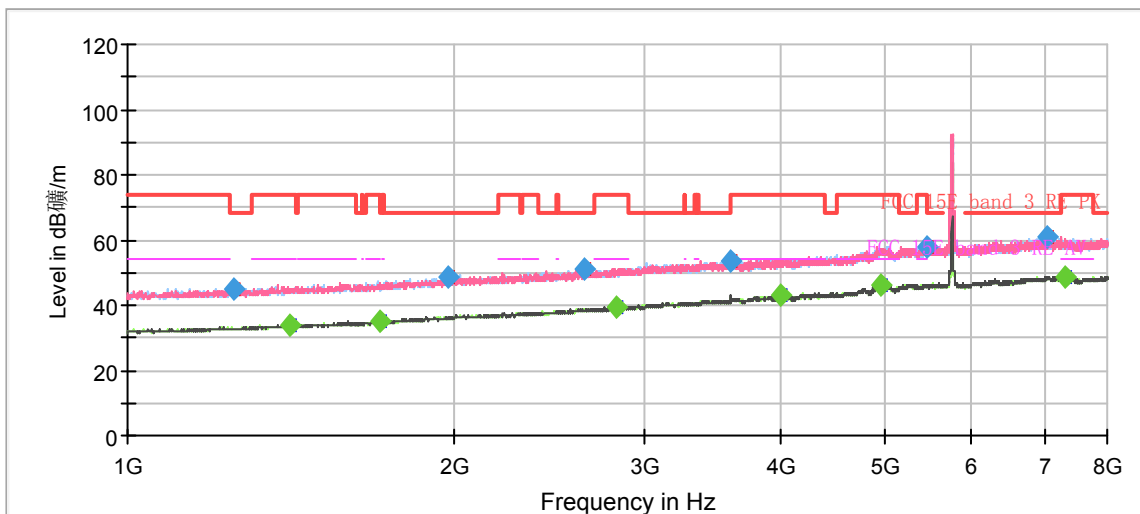

Radiates Emission from 1GHz to 8GHz
 Note: The signal beyond the limit is carrier.

Frequency (MHz)	Peak (dBuV/m)	Average (dBuV/m)	Limit (dBuV/m)	Margin (dB)	Height (cm)	Polarization	Azimuth (deg)	Correct Factor (dB)
1252.000000	45.20	---	68.20	23.00	100.0	V	196.0	-16.0
1412.125000	---	33.86	54.00	20.14	200.0	H	60.0	-15.3
1706.125000	---	35.07	54.00	18.93	200.0	H	247.0	-13.9
1973.000000	48.72	---	68.20	19.48	200.0	V	352.0	-12.7
2634.500000	51.01	---	68.20	17.19	200.0	V	262.0	-10.6
2820.000000	---	39.22	54.00	14.78	100.0	H	246.0	-9.8
3597.000000	53.42	---	68.20	14.78	100.0	V	154.0	-6.7
3991.625000	---	42.93	54.00	11.07	100.0	V	286.0	-5.4
4941.875000	---	46.33	54.00	7.67	100.0	H	173.0	-1.7
5464.250000	57.73	---	68.20	10.47	200.0	V	41.0	-0.6
7041.875000	60.93	---	68.20	7.27	200.0	V	335.0	2.4
7327.125000	---	48.65	54.00	5.35	100.0	V	179.0	2.8

Remark: 1. Correction Factor = Antenna factor+ Insertion loss (cable loss + amplifier gain)

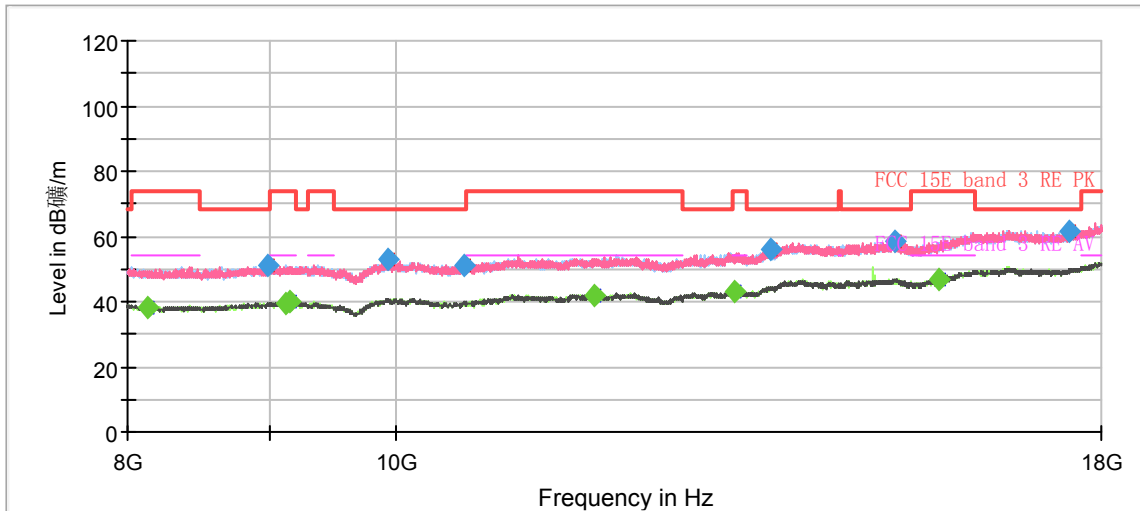

Radiates Emission from 8GHz to 18GHz

Frequency (MHz)	Peak (dBuV/m)	Average (dBuV/m)	Limit (dBuV/m)	Margin (dB)	Height (cm)	Polarization	Azimuth (deg)	Correct Factor (dB)
8136.250000	---	37.95	54.00	16.05	200.0	H	198.0	-7.6
8991.250000	50.99	---	68.20	17.21	200.0	H	204.0	-6.8
9131.250000	---	39.47	54.00	14.53	200.0	V	238.0	-6.7
9163.750000	---	39.95	54.00	14.05	200.0	V	104.0	-6.6
9933.750000	52.78	---	68.20	15.42	200.0	H	178.0	-5.3
10592.500000	51.35	---	68.20	16.85	100.0	H	258.0	-4.8
11802.500000	---	42.01	54.00	11.99	100.0	H	174.0	-3.8
13256.250000	---	43.29	54.00	10.71	200.0	H	146.0	-2.2
13675.000000	56.13	---	68.20	12.07	100.0	H	355.0	-0.5
15153.750000	58.61	---	68.20	9.59	200.0	V	335.0	1.8
15723.750000	---	46.64	54.00	7.36	200.0	H	198.0	2.7
17537.500000	61.84	---	68.20	6.36	100.0	H	342.0	5.2

Remark: 1. Correction Factor = Antenna factor+ Insertion loss (cable loss + amplifier gain)



802.11n (HT40) CH159

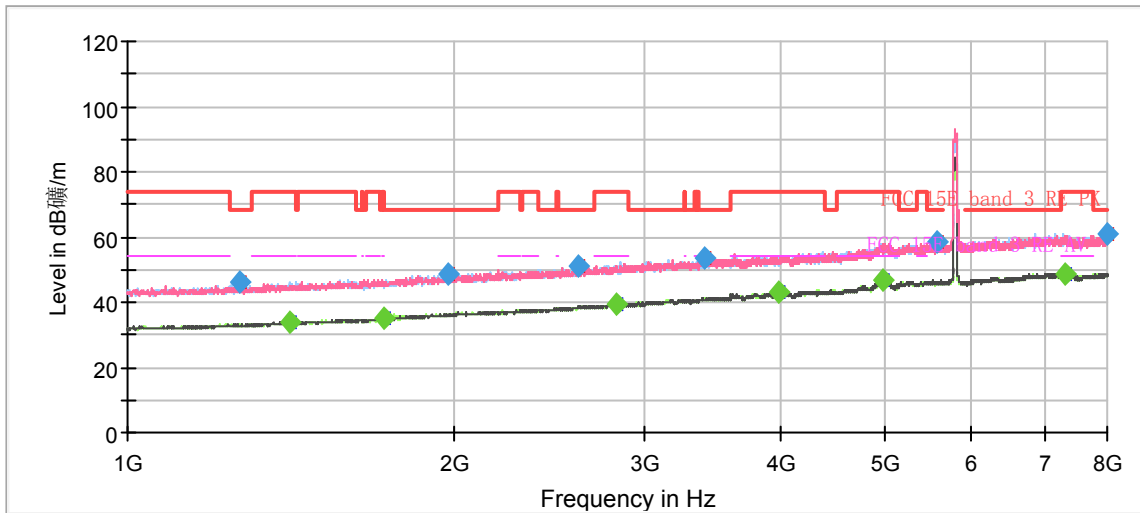

Radiates Emission from 1GHz to 8GHz
 Note: The signal beyond the limit is carrier.

Frequency (MHz)	Peak (dBuV/m)	Average (dBuV/m)	Limit (dBuV/m)	Margin (dB)	Height (cm)	Polarization	Azimuth (deg)	Correct Factor (dB)
1267.750000	45.96	---	68.20	22.24	100.0	V	16.0	-15.9
1411.250000	---	33.73	54.00	20.27	200.0	H	2.0	-15.3
1721.000000	---	34.98	54.00	19.02	200.0	V	302.0	-13.8
1977.375000	48.67	---	68.20	19.53	200.0	H	86.0	-12.7
2606.500000	50.77	---	68.20	17.43	100.0	V	125.0	-10.7
2816.500000	---	39.21	54.00	14.79	200.0	H	126.0	-9.8
3397.500000	53.65	---	68.20	14.55	100.0	V	133.0	-7.5
3989.000000	---	42.85	54.00	11.15	100.0	H	348.0	-5.5
4959.375000	---	46.50	54.00	7.50	200.0	V	197.0	-1.6
5578.875000	58.38	---	68.20	9.82	200.0	V	302.0	-0.4
7328.875000	---	48.82	54.00	5.18	100.0	V	206.0	2.8
7999.125000	60.70	---	68.20	7.50	100.0	V	24.0	2.5

Remark: 1. Correction Factor = Antenna factor+ Insertion loss (cable loss + amplifier gain)

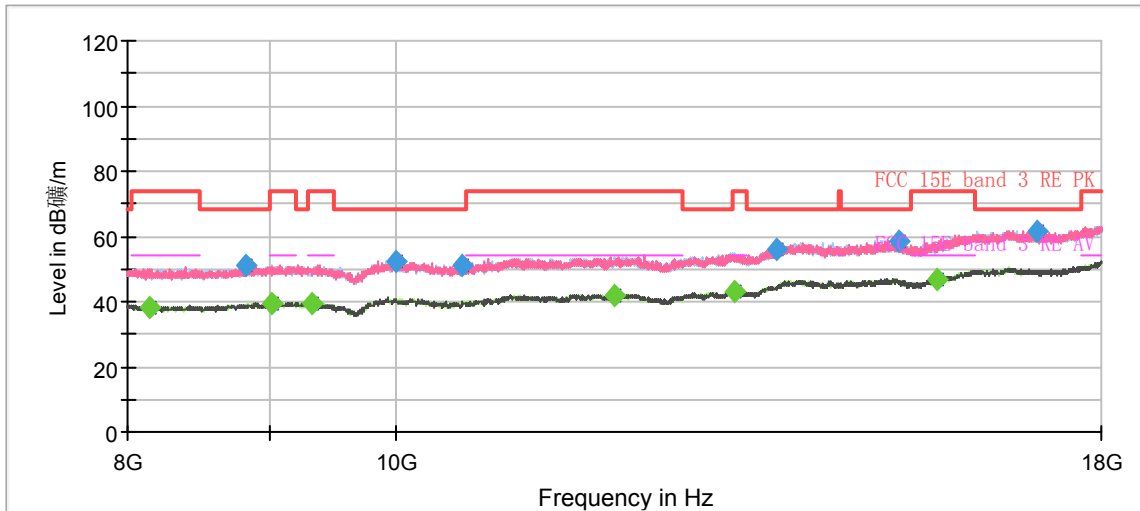

Radiates Emission from 8GHz to 18GHz

Frequency (MHz)	Peak (dBuV/m)	Average (dBuV/m)	Limit (dBuV/m)	Margin (dB)	Height (cm)	Polarization	Azimuth (deg)	Correct Factor (dB)
8145.000000	---	38.34	54.00	15.66	100.0	V	0.0	-7.6
8823.750000	50.93	---	68.20	17.27	200.0	H	118.0	-7.0
9017.500000	---	39.62	54.00	14.38	100.0	H	112.0	-6.7
9333.750000	---	39.48	54.00	14.52	100.0	H	288.0	-6.0
10003.750000	52.53	---	68.20	15.67	100.0	V	262.0	-5.4
10575.000000	51.35	---	68.20	16.85	200.0	H	292.0	-4.9
11990.000000	---	41.95	54.00	12.05	200.0	V	240.0	-3.8
13258.750000	---	43.21	54.00	10.79	100.0	H	119.0	-2.2
13733.750000	55.94	---	68.20	12.26	200.0	V	156.0	-0.2
15201.250000	58.75	---	68.20	9.45	100.0	H	175.0	1.8
15710.000000	---	46.60	54.00	7.40	200.0	V	261.0	2.6
17065.000000	61.79	---	68.20	6.41	200.0	H	132.0	5.0

Remark: 1. Correction Factor = Antenna factor+ Insertion loss (cable loss + amplifier gain)



802.11ac (VHT80) CH42

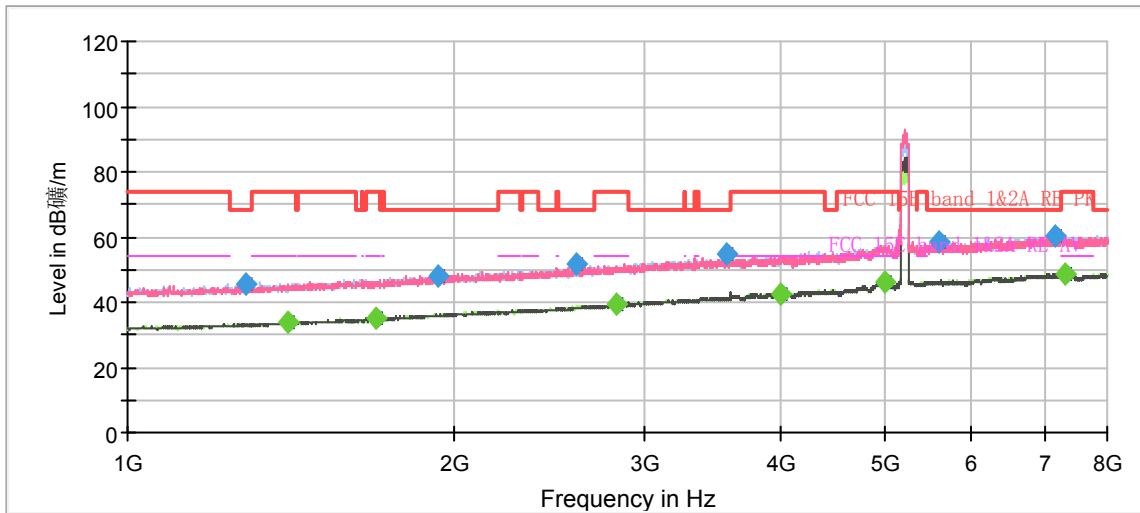

Radiates Emission from 1GHz to 8GHz
 Note: The signal beyond the limit is carrier.

Frequency (MHz)	Peak (dBuV/m)	Average (dBuV/m)	Limit (dBuV/m)	Margin (dB)	Height (cm)	Polarization	Azimuth (deg)	Correct Factor (dB)
1285.250000	45.56	---	68.20	22.64	200.0	H	0.0	-15.8
1407.750000	---	33.84	54.00	20.16	100.0	V	303.0	-15.3
1696.500000	---	35.01	54.00	18.99	100.0	H	187.0	-14.0
1936.250000	48.11	---	68.20	20.09	200.0	V	0.0	-12.9
2593.375000	51.71	---	68.20	16.49	200.0	H	0.0	-10.8
2823.500000	---	39.30	54.00	14.70	200.0	V	1.0	-9.8
3562.875000	54.64	---	68.20	13.56	100.0	V	181.0	-6.9
3997.750000	---	42.72	54.00	11.28	100.0	H	40.0	-5.4
4991.750000	---	46.30	54.00	7.70	200.0	V	284.0	-1.5
5590.250000	58.64	---	68.20	9.56	100.0	H	335.0	-0.4
7168.750000	60.56	---	68.20	7.64	100.0	H	98.0	2.6
7321.000000	---	48.63	54.00	5.37	100.0	H	260.0	2.9

Remark: 1. Correction Factor = Antenna factor+ Insertion loss (cable loss + amplifier gain)

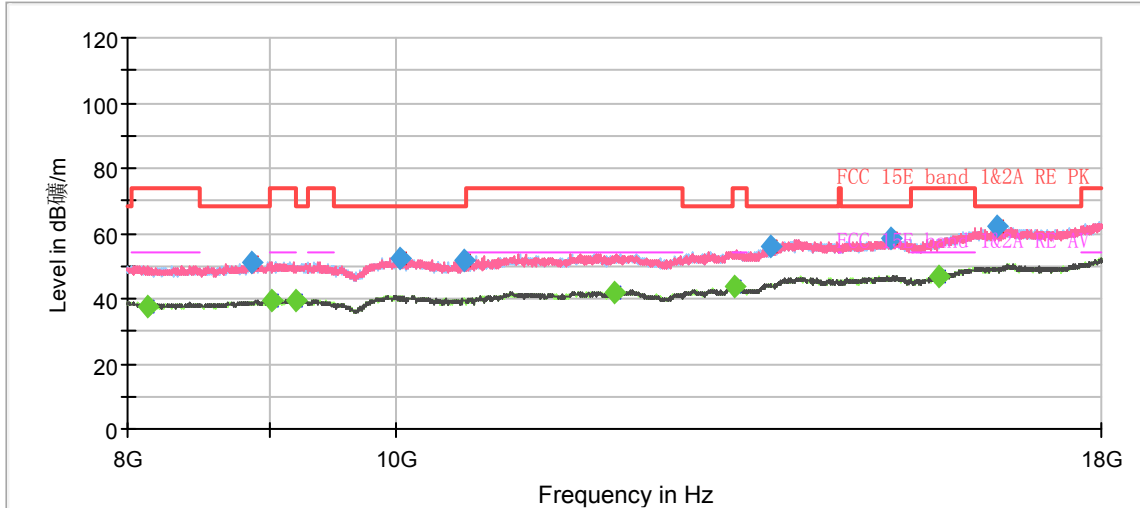

Radiates Emission from 8GHz to 18GHz

Frequency (MHz)	Peak (dBuV/m)	Average (dBuV/m)	Limit (dBuV/m)	Margin (dB)	Height (cm)	Polarization	Azimuth (deg)	Correct Factor (dB)
8136.250000	---	37.76	54.00	16.24	100.0	H	258.0	-7.6
8873.750000	50.92	---	68.20	17.28	200.0	H	16.0	-6.9
9013.750000	---	39.54	54.00	14.46	200.0	H	0.0	-6.7
9196.250000	---	39.47	54.00	14.53	200.0	V	168.0	-6.5
10041.250000	52.53	---	68.20	15.67	100.0	V	94.0	-5.4
10591.250000	51.58	---	68.20	16.62	200.0	H	234.0	-4.8
11997.500000	---	42.12	54.00	11.88	100.0	V	38.0	-3.8
13263.750000	---	43.42	54.00	10.58	200.0	H	241.0	-2.1
13675.000000	55.99	---	68.20	12.21	100.0	H	223.0	-0.5
15118.750000	58.23	---	68.20	9.97	200.0	H	151.0	1.7
15723.750000	---	46.63	54.00	7.37	200.0	H	151.0	2.7
16493.750000	62.02	---	68.20	6.18	100.0	V	10.0	5.1

Remark: 1. Correction Factor = Antenna factor+ Insertion loss (cable loss + amplifier gain)



802.11ac (VHT80) CH155

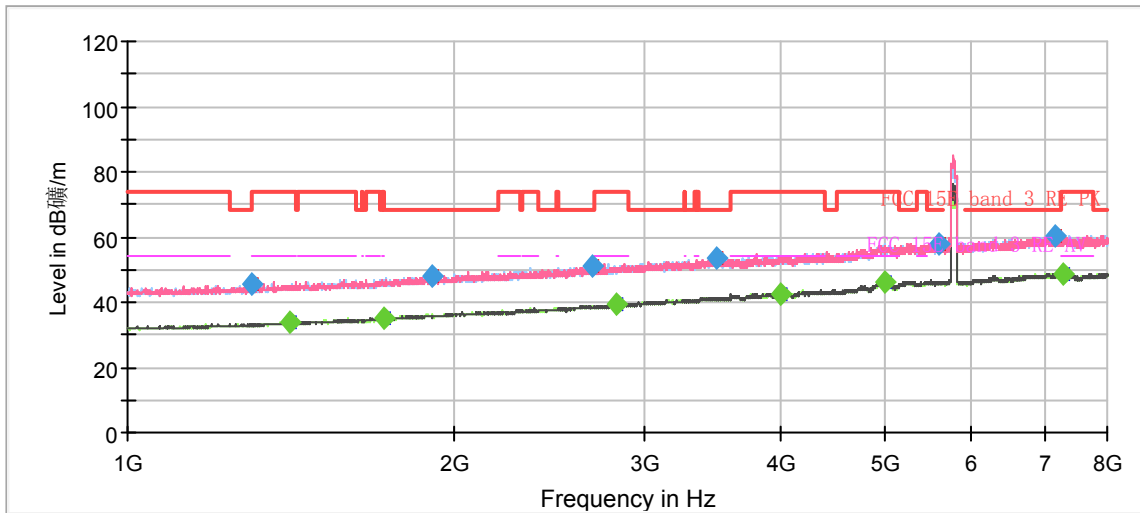

Radiates Emission from 1GHz to 8GHz
 Note: The signal beyond the limit is carrier.

Frequency (MHz)	Peak (dBuV/m)	Average (dBuV/m)	Limit (dBuV/m)	Margin (dB)	Height (cm)	Polarization	Azimuth (deg)	Correct Factor (dB)
1299.250000	45.69	---	68.20	22.51	200.0	H	215.0	-15.8
1408.625000	---	33.82	54.00	20.18	100.0	V	151.0	-15.3
1721.875000	---	35.07	54.00	18.93	200.0	V	301.0	-13.8
1906.500000	48.22	---	68.20	19.98	200.0	V	325.0	-13.0
2684.375000	50.98	---	68.20	17.22	200.0	V	64.0	-10.4
2821.750000	---	39.38	54.00	14.62	100.0	V	127.0	-9.8
3495.500000	53.37	---	68.20	14.83	100.0	V	75.0	-7.1
3993.375000	---	42.76	54.00	11.24	100.0	H	122.0	-5.4
4988.250000	---	46.35	54.00	7.65	100.0	V	60.0	-1.5
5599.875000	57.97	---	68.20	10.23	200.0	V	48.0	-0.4
7175.750000	60.54	---	68.20	7.66	200.0	V	325.0	2.7
7272.000000	---	48.87	54.00	5.13	200.0	H	182.0	2.9

Remark: 1. Correction Factor = Antenna factor+ Insertion loss (cable loss + amplifier gain)

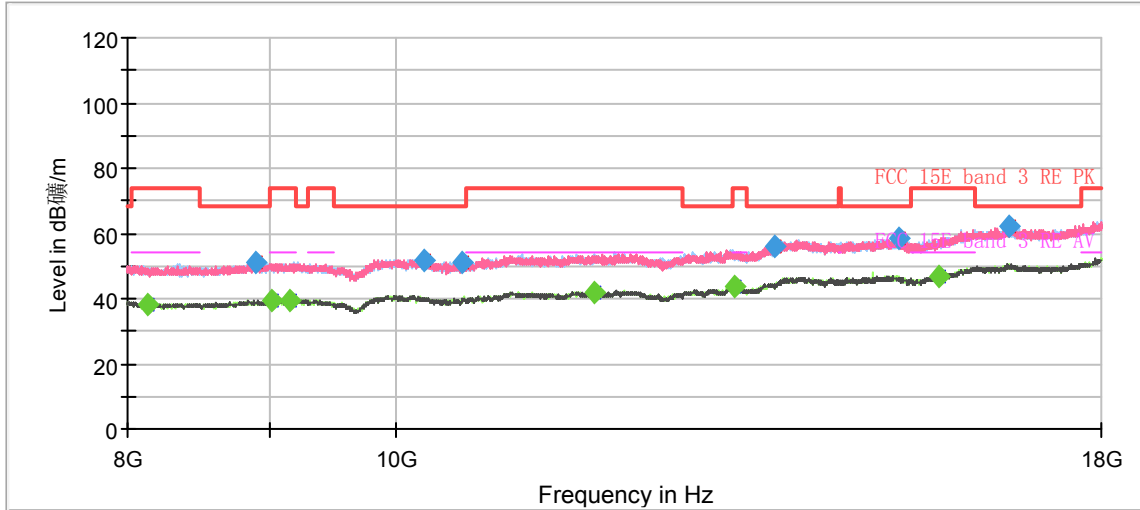

Radiates Emission from 8GHz to 18GHz

Frequency (MHz)	Peak (dBuV/m)	Average (dBuV/m)	Limit (dBuV/m)	Margin (dB)	Height (cm)	Polarization	Azimuth (deg)	Correct Factor (dB)
8136.250000	---	38.28	54.00	15.72	200.0	H	200.0	-7.6
8908.750000	50.96	---	68.20	17.24	100.0	V	52.0	-6.9
9016.250000	---	39.64	54.00	14.36	100.0	H	0.0	-6.7
9160.000000	---	39.58	54.00	14.42	200.0	H	16.0	-6.6
10237.500000	51.90	---	68.20	16.30	200.0	V	279.0	-5.3
10575.000000	51.00	---	68.20	17.20	100.0	V	312.0	-4.9
11808.750000	---	42.12	54.00	11.88	100.0	H	265.0	-3.8
13255.000000	---	43.62	54.00	10.38	100.0	H	251.0	-2.2
13710.000000	56.14	---	68.20	12.06	100.0	V	95.0	-0.3
15207.500000	58.28	---	68.20	9.92	100.0	V	95.0	1.8
15718.750000	---	46.66	54.00	7.34	200.0	V	286.0	2.7
16661.250000	62.45	---	68.20	5.75	200.0	V	300.0	5.6

Remark: 1. Correction Factor = Antenna factor+ Insertion loss (cable loss + amplifier gain)



During the test, the Radiates Emission from 18GHz to 40GHz was performed in all modes with all channels, 802.11n (HT20) CH157 are selected as the worst condition. The test data of the worst-case condition was recorded in this report.

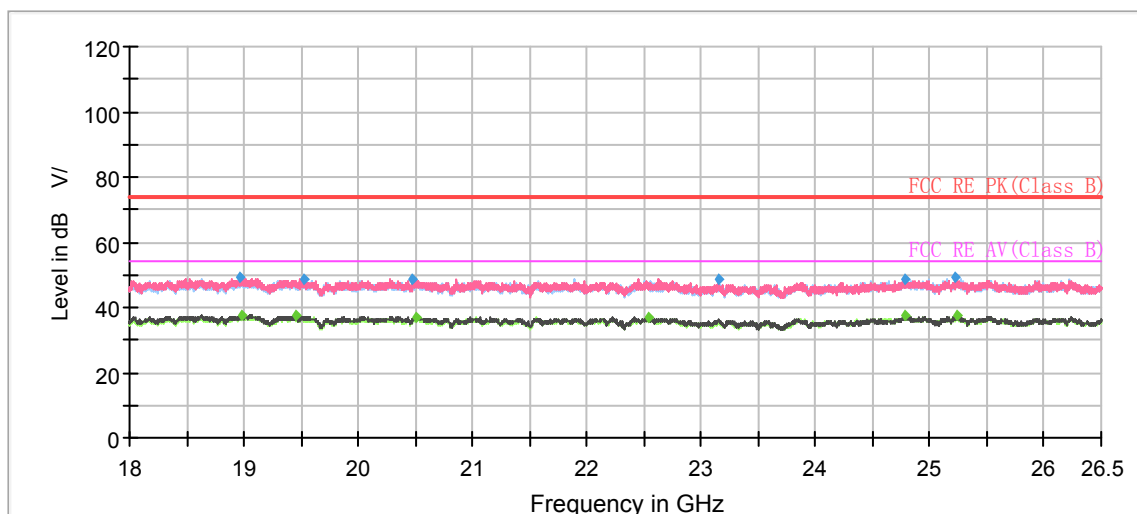

Radiates Emission from 18GHz to 26.5GHz

Frequency (MHz)	Peak (dBuV/m)	Average (dBuV/m)	Limit (dBuV/m)	Margin (dB)	Height (cm)	Polarization	Azimuth (deg)	Correct Factor (dB)
18960.50	48.95	---	74.00	25.05	200.0	V	136.00	-1
18986.00	---	37.54	54.00	16.46	200.0	V	186.00	-1
19463.06	---	37.24	54.00	16.76	100.0	V	0.00	-1
19523.63	48.84	---	74.00	25.16	100.0	V	273.00	-1
20478.81	48.84	---	74.00	25.16	200.0	V	192.00	0
20503.25	---	37.02	54.00	16.98	200.0	V	43.00	0
22532.63	---	36.81	54.00	17.19	100.0	H	115.00	2
23152.06	48.46	---	74.00	25.54	100.0	H	2.00	2
24783.00	48.55	---	74.00	25.45	100.0	H	38.00	3
24789.38	---	37.44	54.00	16.56	100.0	H	190.00	3
25226.06	49.06	---	74.00	24.94	100.0	H	225.00	3
25230.31	---	37.41	54.00	16.59	100.0	V	195.00	3

Remark: 1. Correction Factor = Antenna factor+ Insertion loss (cable loss + amplifier gain)

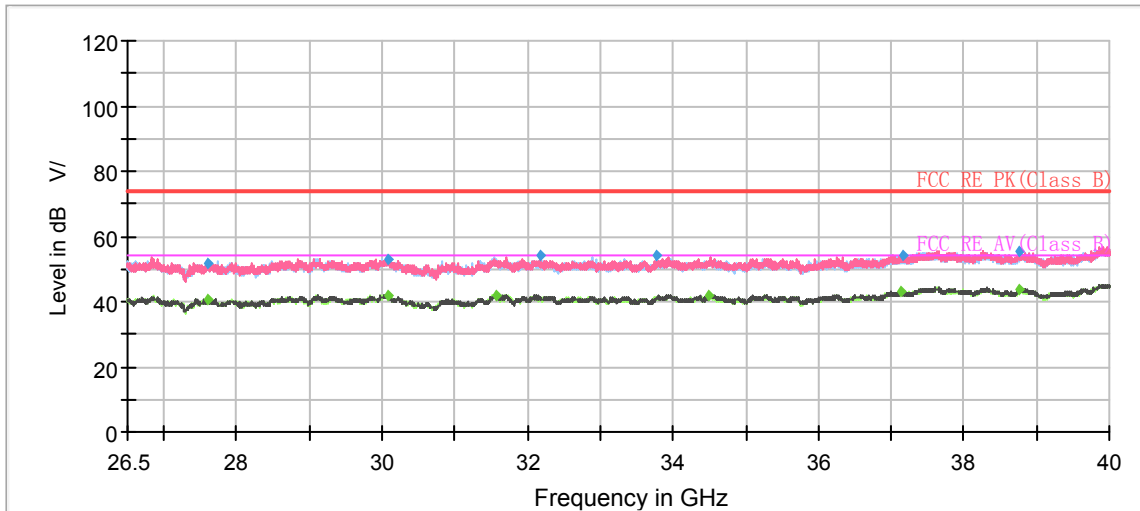

Radiates Emission from 26.5GHz to 40GHz

Frequency (MHz)	Peak (dBuV/m)	Average (dBuV/m)	Limit (dBuV/m)	Margin (dB)	Height (cm)	Polarization	Azimuth (deg)	Correct Factor (dB)
27595.19	---	40.68	54.00	13.32	100.0	H	217.00	6
27595.19	51.51	---	74.00	22.49	100.0	V	343.00	6
30069.06	---	42.06	54.00	11.94	100.0	H	232.00	7
30070.75	53.21	---	74.00	20.79	100.0	V	261.00	7
31559.13	---	42.14	54.00	11.86	100.0	H	0.00	8
32168.31	54.10	---	74.00	19.90	200.0	V	196.00	8
33781.56	53.87	---	74.00	20.13	100.0	H	123.00	8
34497.06	---	42.02	54.00	11.98	100.0	V	206.00	8
37148.13	---	43.11	54.00	10.89	100.0	V	235.00	10
37156.56	54.37	---	74.00	19.63	100.0	H	144.00	10
38758.00	55.29	---	74.00	18.71	200.0	V	29.00	10
38759.69	---	43.56	54.00	10.44	200.0	V	180.00	10

Remark: 1. Correction Factor = Antenna factor+ Insertion loss (cable loss + amplifier gain)

5.6. Conducted Emission

Ambient condition

Temperature	Relative humidity	Pressure
23°C ~25°C	45%~50%	101.5kPa

Methods of Measurement

The EUT IS placed on a non-metallic table of 80cm height above the horizontal metal reference ground plane. During the test, the EUT was operating in its typical mode. The test method is according to ANSI C63.10. Connect the AC power line of the EUT to the LISN Use EMI receiver to detect the average and Quasi-peak value. RBW is set to 9kHz, VBW is set to 30kHz The measurement result should include both L line and N line.

The test is in transmitting mode.

Test Setup

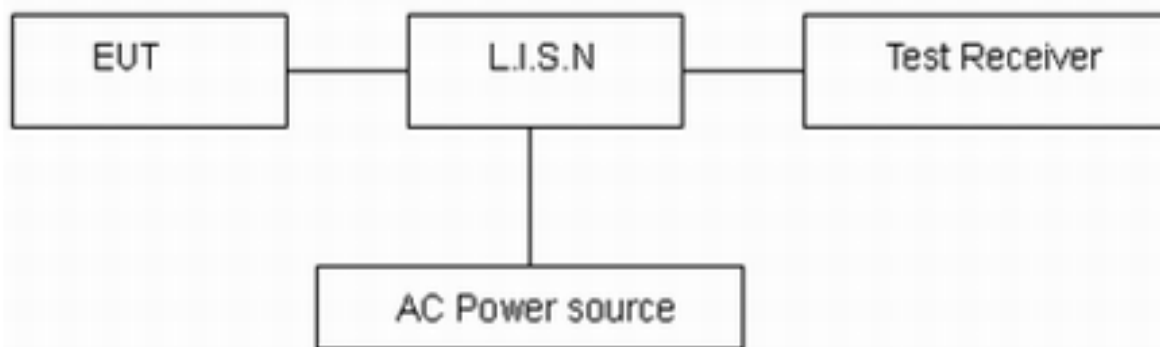

Note: AC Power source is used to change the voltage 110V/60Hz.

Limits

Frequency (MHz)	Conducted Limits(dBμV)	
	Quasi-peak	Average
0.15 - 0.5	66 to 56 *	56 to 46 *
0.5 - 5	56	46
5 - 30	60	50

*: Decreases with the logarithm of the frequency.

Measurement Uncertainty

The assessed measurement uncertainty to ensure 95% confidence level for the normal distribution is with the coverage factor $k = 1.96$, $U = 2.69$ dB.

Test Results:

Following plots, Blue trace uses the peak detection and Green trace uses the average detection. During the test, the Conducted Emission was performed in all modes with all channels, 802.11n (HT20) CH157 are selected as the worst condition. The test data of the worst-case condition was recorded in this report.

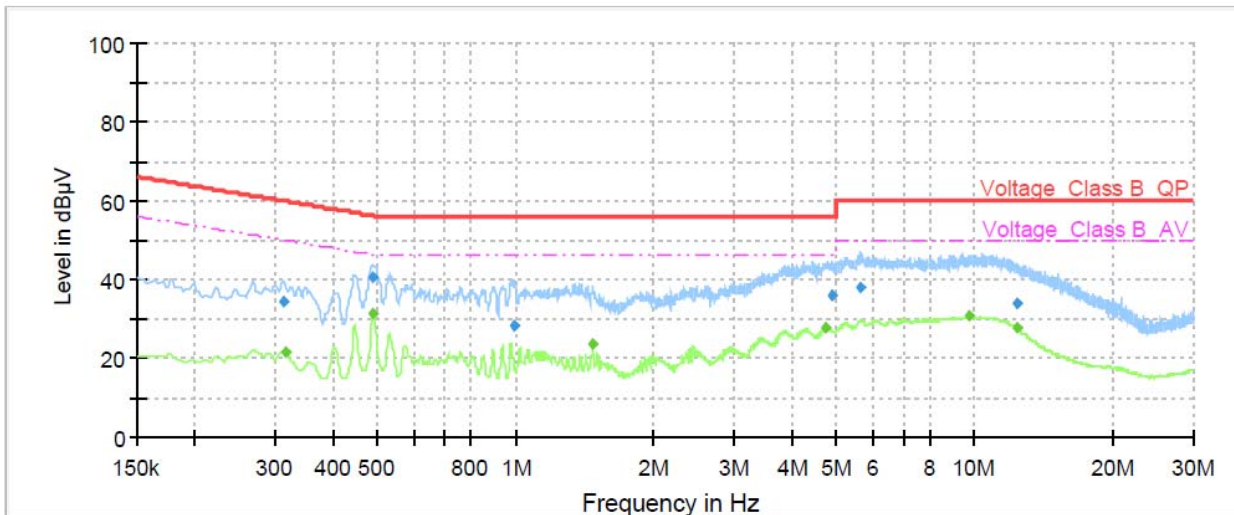

Frequency (MHz)	QuasiPeak (dBµV)	Average (dBµV)	Limit (dBµV)	Margin (dB)	Meas. Time (ms)	Bandwidth (kHz)	Line	Filter	Corr. (dB)
0.31	34.31	---	59.92	25.61	1000.00	9.000	L1	ON	21
0.31	---	21.43	49.86	28.43	1000.00	9.000	L1	ON	21
0.49	---	31.39	46.17	14.78	1000.00	9.000	L1	ON	20
0.49	40.56	---	56.17	15.61	1000.00	9.000	L1	ON	20
0.99	28.24	---	56.00	27.76	1000.00	9.000	L1	ON	20
1.48	---	23.64	46.00	22.36	1000.00	9.000	L1	ON	20
4.73	---	27.94	46.00	18.06	1000.00	9.000	L1	ON	19
4.87	36.03	---	56.00	19.97	1000.00	9.000	L1	ON	19
5.67	38.08	---	60.00	21.92	1000.00	9.000	L1	ON	19
9.79	---	30.62	50.00	19.38	1000.00	9.000	L1	ON	20
12.41	---	27.44	50.00	22.56	1000.00	9.000	L1	ON	20
12.43	33.73	---	60.00	26.27	1000.00	9.000	L1	ON	20

Remark: Correct factor=cable loss + LISN factor

L line Conducted Emission from 150 KHz to 30 MHz

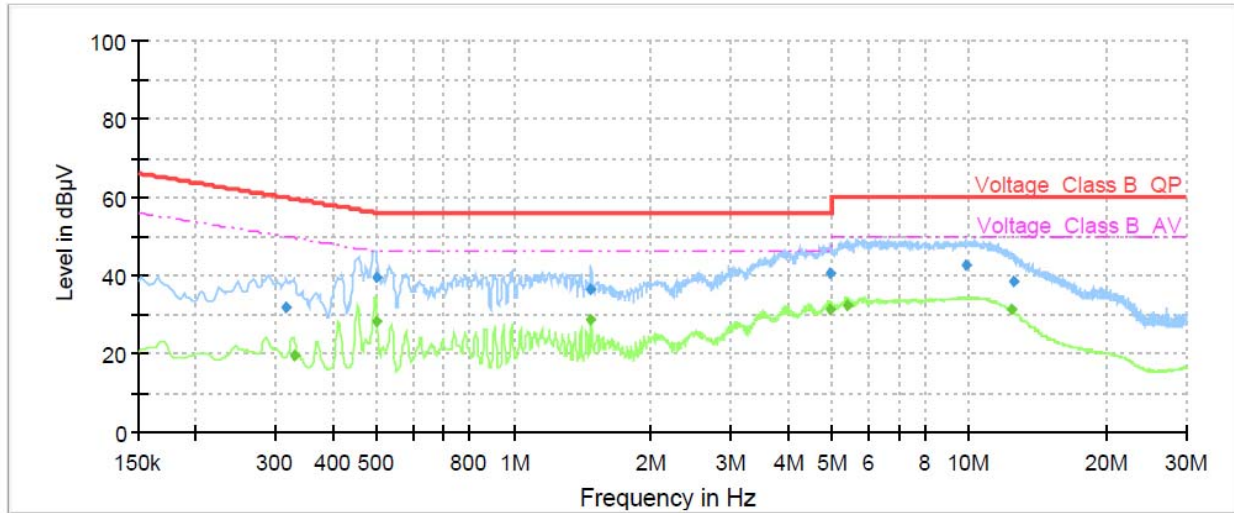

Frequency (MHz)	QuasiPeak (dBµV)	Average (dBµV)	Limit (dBµV)	Margin (dB)	Meas. Time (ms)	Bandwidth (kHz)	Line	Filter	Corr. (dB)
0.32	32.05	---	59.80	27.75	1000.00	9.000	N	ON	21
0.33	---	19.64	49.51	29.87	1000.00	9.000	N	ON	21
0.50	---	28.25	46.06	17.81	1000.00	9.000	N	ON	20
0.50	39.46	---	56.06	16.60	1000.00	9.000	N	ON	20
1.48	36.31	---	56.00	19.69	1000.00	9.000	N	ON	20
1.48	---	28.81	46.00	17.19	1000.00	9.000	N	ON	20
4.96	40.66	---	56.00	15.34	1000.00	9.000	N	ON	19
4.96	---	31.07	46.00	14.93	1000.00	9.000	N	ON	19
5.41	---	32.52	50.00	17.48	1000.00	9.000	N	ON	19
9.83	42.60	---	60.00	17.40	1000.00	9.000	N	ON	20
12.43	---	31.04	50.00	18.96	1000.00	9.000	N	ON	20
12.48	38.62	---	60.00	21.38	1000.00	9.000	N	ON	20

Remark: Correct factor=cable loss + LISN factor

N line Conducted Emission from 150 KHz to 30 MHz



6. Main Test Instruments

Name	Manufacturer	Type	Serial Number	Calibration Date	Expiration Date
Power probe	R&S	NRP18S	101954	2021-05-15	2022-05-14
Spectrum Analyzer	KEYSIGHT	N9020A	MY54420163	2021-12-12	2022-12-11
Climate Chamber	ESPEC	SU-242	93000506	2021-12-12	2022-12-11
EMI Test Receiver	R&S	ESR	102389	2021-06-04	2022-06-03
Spectrum Analyzer	R&S	FSV40	100816	2021-05-15	2022-05-14
TRILOG Broadband Antenna	SCHWARZBEC K	VULB 9163	1023	2020-05-05	2023-05-04
Horn Antenna	R&S	HF907	102723	2020-08-11	2023-08-10
Horn Antenna	ETS-Lindgren	3160-09	00102643	2021-10-10	2024-10-09
Horn Antenna	STEATITE	QSH-SL-26 -40-K-15	16779	2019-12-24	2022-12-23
Software	R&S	EMC32	9.26.01	/	/

*****END OF REPORT *****



ANNEX A: The EUT Appearance

The EUT Appearance are submitted separately.



ANNEX B: Test Setup Photos

The Test Setup Photos are submitted separately.