



# RF TEST REPORT

**Applicant** ZTE Corporation  
**FCC ID** SRQ-Z6400C  
**Product** WCDMA/LTE Multi-mode  
Digital Mobile Phone  
**Model** Z6400C  
**Report No.** R1801A0019-R6  
**Issue Date** March 19, 2018

TA Technology (Shanghai) Co., Ltd. tested the above equipment in accordance with the requirements in **FCC CFR47 Part 2 (2017)/ FCC CFR 47 Part 90R (2017)**. The test results show that the equipment tested is capable of demonstrating compliance with the requirements as documented in this report.

*Jiang peng Lan*

Performed by: Xianqing Li

*Kai Xu*

Approved by: Kai Xu

## TA Technology (Shanghai) Co., Ltd.

No.145, Jintang Rd, Tangzhen Industry Park, Pudong Shanghai, China

TEL: +86-021-50791141/2/3

FAX: +86-021-50791141/2/3-8000



# TABLE OF CONTENT

- 1. Test Laboratory .....4
  - 1.1. Notes of the Test Report ..... 4
  - 1.2. Test facility.....4
  - 1.3. Testing Location ..... 5
- 2. General Description of Equipment under Test.....6
- 3. Applied Standards.....7
- 4. Test Configuration.....8
- 5. Test Case Results.....9
  - 5.1. RF Power Output..... 9
  - 5.2. Effective Radiated Power ..... 11
  - 5.3. Occupied Bandwidth ..... 14
  - 5.4. Band Edge Compliance ..... 17
  - 5.5. Peak-to-Average Power Ratio (PAPR)..... 23
  - 5.6. Frequency Stability ..... 25
  - 5.7. Spurious Emissions at Antenna Terminals ..... 28
  - 5.8. Radiates Spurious Emission..... 32
- 6. Main Test Instruments .....39



### Summary of measurement results

No.	Test Type	Clause in FCC rules	Verdict
1	RF power output	2.1046/90.635 (b)	PASS
2	Effective Radiated Power	90.542	PASS
3	Occupied Bandwidth	2.1049/ 90.209	PASS
4	Emission Masks	2.1051 / 90.543	PASS
5	Peak-to-Average Power Ratio	KDB 971168 D01(5.7)	PASS
6	Frequency Stability	90.539 (c)	PASS
7	Spurious Emissions at Antenna Terminals	90.543 (e)	PASS
8	Radiates Spurious Emission	90.543 (e)	PASS
Date of Testing: January 13, 2018~ March 10, 2018			
Note: PASS: The EUT complies with the essential requirements in the standard. FAIL: The EUT does not comply with the essential requirements in the standard.			



## 1. Test Laboratory

### 1.1. Notes of the Test Report

This report shall not be reproduced in full or partial, without the written approval of **TA technology (shanghai) co., Ltd.** The results documented in this report apply only to the tested sample, under the conditions and modes of operation as described herein .Measurement Uncertainties were not taken into account and are published for informational purposes only. This report is written to support regulatory compliance of the applicable standards stated above.

### 1.2. Test facility

#### **CNAS (accreditation number:L2264)**

TA Technology (Shanghai) Co., Ltd. has obtained the accreditation of China National Accreditation Service for Conformity Assessment (CNAS).

#### **FCC (Designation number: CN1179, Test Firm Registration Number: 446626)**

TA Technology (Shanghai) Co., Ltd. has been listed on the US Federal Communications Commission list of test facilities recognized to perform electromagnetic emissions measurements.

#### **IC (recognition number is 8510A)**

TA Technology (Shanghai) Co., Ltd. has been listed by industry Canada to perform electromagnetic emission measurement.

#### **VCCI (recognition number is C-4595, T-2154, R-4113, G-10766)**

TA Technology (Shanghai) Co., Ltd. has been listed by industry Japan to perform electromagnetic emission measurement.

#### **A2LA (Certificate Number: 3857.01)**

TA Technology (Shanghai) Co., Ltd. has been listed by American Association for Laboratory Accreditation to perform electromagnetic emission measurement.



### 1.3. Testing Location

Company: TA Technology (Shanghai) Co., Ltd.  
Address: No.145, Jintang Rd, Tangzhen Industry Park, Pudong  
City: Shanghai  
Post code: 201201  
Country: P. R. China  
Contact: Xu Kai  
Telephone: +86-021-50791141/2/3  
Fax: +86-021-50791141/2/3-8000  
Website: <http://www.ta-shanghai.com>  
E-mail: [xukai@ta-shanghai.com](mailto:xukai@ta-shanghai.com)

## 2. General Description of Equipment under Test

### Client Information

Applicant	ZTE Corporation
Applicant address	ZTE Plaza, Keji Road South, Hi-Tech, Industrial Park, Nanshan District, Shenzhen, Guangdong, 518057, P.R.China
Manufacturer	ZTE Corporation
Manufacturer address	ZTE Plaza, Keji Road South, Hi-Tech, Industrial Park, Nanshan District, Shenzhen, Guangdong, 518057, P.R.China

### General Information

EUT Description			
Model	Z6400C		
Product IMEI	867466030005743		
Hardware Version	Z6400CHW1.0		
Software Version	Z6400CV1.0.1		
Power Supply	Battery/AC adapter		
Antenna Type	Internal Antenna		
Test Mode(s)	LTE Band 14;		
Test Modulation	QPSK 16QAM;		
Maximum E.R.P.	LTE Band 14: 19.17dBm		
Rated Power Supply Voltage	3.85V		
Extreme Voltage	Minimum: 3.6V    Maximum: 4.4V		
Extreme Temperature	Lowest: -10°C    Highest: +55°C		
Operating Frequency Range(s)	Band	Tx (MHz)	Rx (MHz)
	LTE Band 14	788 ~ 798	758 ~ 768
EUT Accessory			
Adapter	Manufacturer: Salcomp (Shenzhen) Co., Ltd. Model: STC-A5915A-Z		
Battery	Model: Li3940T44P8h937238		
USB Cable	100cm Cable, Shielded		
Note: The information of the EUT is declared by the manufacturer.			



### **3. Applied Standards**

According to the specifications of the manufacturer, it must comply with the requirements of the following standards:

**FCC CFR47 Part 2 (2017)**

**FCC CFR 47 Part 90R (2017)**

**ANSI/TIA-603-E (2016)**

**KDB 971168 D01 Power Meas License Digital Systems v03**

### 4. Test Configuration

Radiated measurements are performed by rotating the EUT in three different orthogonal test planes. EUT stand-up position (Z axis), lie-down position (X, Y axis). Receiver antenna polarization (horizontal and vertical), the worst emission was found in position (Z axis, vertical polarization) and the worst case was recorded.

All mode and data rates and positions were investigated.

The following testing in LTE is set based on the maximum RF Output Power.

Test modes are chosen as the worst case configuration below for LTE Band 14

Test items	Bandwidth (MHz)		Modulation		RB			Test Channel		
	5	10	QPSK	16QAM	1	50%	100%	L	M	H
RF power output	O	O	O	O	O	O	O	O	O	O
Effective Isotropic Radiated power	O	O	O	O	-	-	O	O	O	O
Occupied Bandwidth	O	O	O	O	-	-	O	O	O	O
Band Edge Compliance	O	O	O	O	-	-	O	O	-	O
Peak-to-Average Power Ratio	O	O	O	O	-	-	O	O	O	O
Frequency Stability	O	O	O	O	-	-	O	-	O	-
Spurious Emissions at Antenna Terminals	O	O	O	-	O	-	-	O	O	O
Radiates Spurious Emission	O	O	O	-	O	-	-	O	O	O
Note	1. The mark "O" means that this configuration is chosen for testing. 2. The mark "-" means that this configuration is not testing.									



## 5. Test Case Results

### 5.1. RF Power Output

#### Ambient condition

Temperature	Relative humidity	Pressure
23°C ~25°C	45%~50%	101.5kPa

#### Methods of Measurement

During the process of the testing, The EUT is controlled by the Base Station Simulator to ensure max power transmission and proper modulation.

#### Test Setup

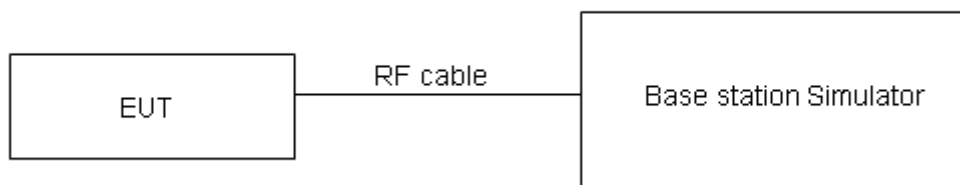

The loss between RF output port of the EUT and the input port of the tester has been taken into consideration.

#### Limits

Part 90.635 (b) the maximum output power of the transmitter for mobile stations is 100 watts.

#### Measurement Uncertainty

The assessed measurement uncertainty to ensure 95% confidence level for the normal distribution is with the coverage factor  $k = 2$ ,  $U = 0.4$  dB.

**Test Results**

LTE Band 14				Conducted Power(dBm)		
Bandwidth	Modulation	RB size	RB offset	Channel/Frequency (MHz)		
				23305/790.5	23330/793	23355/795.5
5MHz	QPSK	1	0	23.49	23.55	23.52
		1	13	23.55	23.47	23.51
		1	24	23.48	23.53	23.49
		12	0	22.59	22.51	22.60
		12	6	22.46	22.53	22.57
		12	13	22.51	22.57	22.65
	16QAM	25	0	22.53	22.52	22.63
		1	0	22.39	22.63	22.81
		1	13	22.46	22.57	22.92
		1	24	22.44	22.55	22.84
		12	0	21.49	21.47	21.63
		12	6	21.47	21.43	21.71
		12	13	21.54	21.61	21.66
		25	0	21.51	21.55	21.65
Bandwidth	Modulation	RB size	RB offset	Channel/Frequency (MHz)		
				/	23330/793	/
10MHz	QPSK	1	0	/	23.75	/
		1	25	/	23.54	/
		1	49	/	23.65	/
		25	0	/	22.59	/
		25	13	/	22.47	/
		25	25	/	22.61	/
		50	0	/	22.57	/
	16QAM	1	0	/	22.91	/
		1	25	/	22.57	/
		1	49	/	22.68	/
		25	0	/	21.21	/
		25	13	/	21.13	/
		25	25	/	21.19	/
		50	0	/	21.18	/

## 5.2. Effective Radiated Power

### Ambient condition

Temperature	Relative humidity	Pressure
23°C ~25°C	45%~50%	101.5kPa

### Methods of Measurement

1. The testing follows FCC KDB 971168 v03 Section 5.8 and **ANSI/TIA-603-E-2016**.

a) Connect the equipment as illustrated. Mount the equipment with the manufacturer specified antenna in a vertical orientation on a manufacturer specified mounting surface located on a non-conducting rotating platform of a RF anechoic chamber (preferred) or a standard radiation site.

b) Key the transmitter, then rotate the EUT 360° azimuthally and record spectrum analyzer power level (LVL) measurements at angular increments that are sufficiently small to permit resolution of all peaks. If a standard radiation test site is used, raise and lower the test antenna to obtain a maximum reading at each angular increment. (Note: several batteries may be needed to offset the effect of battery voltage droop, which should not exceed 5% of the manufactured specified battery voltage during transmission).

c) Replace the transmitter under test with a vertically polarized half-wave dipole (or an antenna whose gain is known relative to an ideal half-wave dipole). The center of the antenna should be at the same location as the center of the antenna under test.

d) Connect the antenna to a signal generator with a known output power and record the path loss (in dB) as LOSS. If a standard radiation test site is used, raise and lower the test antenna to obtain a maximum reading.  $LOSS = \text{Generator Output Power (dBm)} - \text{Analyzer reading (dBm)}$

e) Determine the effective radiated output power at each angular position from the readings in steps b) and d) using the following equation:  $ERP \text{ (dBm)} = LVL \text{ (dBm)} + LOSS \text{ (dB)}$

f) The maximum ERP is the maximum value determined in the preceding step.

g) When calculating ERP, in addition to knowing the antenna radiation and matching characteristics, it is necessary to know the loss values of all elements (e.g. transmission line attenuation, mismatches, filters, combiners) interposed between the point where transmitter output power is measured, and the point where power is applied to the antenna. ERP can then be calculated as follows:

$$ERP \text{ (dBm)} = \text{Output Power (dBm)} - \text{Losses (dB)} + \text{Antenna Gain (dBd)}$$

where: dBd refers to gain relative to an ideal dipole.

$$EIRP \text{ (dBm)} = ERP \text{ (dBm)} + 2.15 \text{ (dB.)}$$

**Test setup**

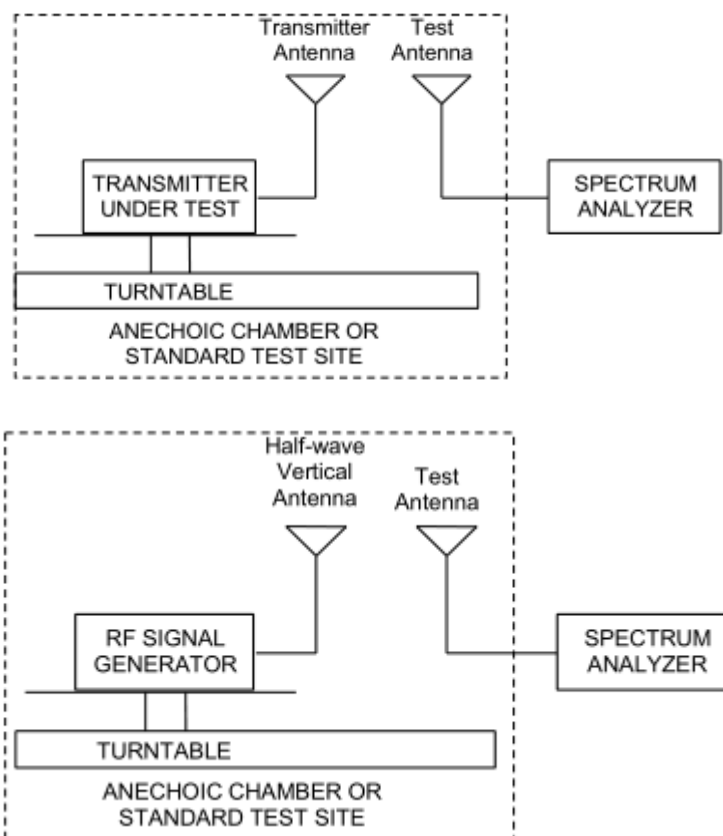

Note: Area side:2.4mX3.6m

The radiated emission was measured in the following position: EUT stand-up position (Z axis), lie-down position (X, Y axis). The worst emission was found in stand-up position (Z axis) and the worst case was recorded.

**Limits**

90.542(7) Portable stations (hand-held devices) transmitting in the 758-768 MHz band and the 788-798 MHz band are limited to 3 watts ERP.

**Measurement Uncertainty**

The assessed measurement uncertainty to ensure 95% confidence level for the normal distribution is with the coverage factor  $k = 2$ ,  $U = 1.19$  dB

**Test Results:**

The measurement is performed for both of horizontal and vertical antenna Polarization, and only the data of worst mode is recorded in this report.

LTE Band 14									
Bandwidth	Channel	Frequency (MHz)	Polarization	Output Power (dBm)	Losses (dB)	Antenna Gain (dBd)	ERP (dBm)	Limit (dBm)	Conclusion
5MHz (QPSK)	Low	790.5	Horizontal	-31.69	-49.41	1.13	18.84	34.77	Pass
	Mid	793	Horizontal	-31.93	-49.63	1.24	18.93	34.77	Pass
	High	795.5	Horizontal	-32.79	-49.95	1.38	18.55	34.77	Pass
10MHz (QPSK)	Mid	793	Horizontal	-31.30	-49.23	1.13	19.07	34.77	Pass
5MHz (16QAM)	Low	790.5	Horizontal	-32.00	-49.41	1.13	18.53	34.77	Pass
	Mid	793	Horizontal	-32.07	-49.63	1.24	18.80	34.77	Pass
	High	795.5	Horizontal	-32.54	-49.95	1.38	18.80	34.77	Pass
10MHz (16QAM)	Mid	793	Horizontal	-31.20	-49.23	1.13	19.17	34.77	Pass

### 5.3. Occupied Bandwidth

#### Ambient condition

Temperature	Relative humidity	Pressure
23°C ~25°C	45%~50%	101.5kPa

#### Method of Measurement

The EUT was connected to Spectrum Analyzer and Base Station Simulator via power Splitter. The occupied bandwidth is measured using spectrum analyzer.

RBW is set to 100 kHz, VBW is set to 300 kHz for LTE Band 14 (5MHz).

RBW is set to 300 kHz, VBW is set to 1MHz for LTE Band 14 (10MHz).

99% power and -26dBc occupied bandwidths are recorded. Spectrum analyzer plots are included on the following pages.

#### Test Setup

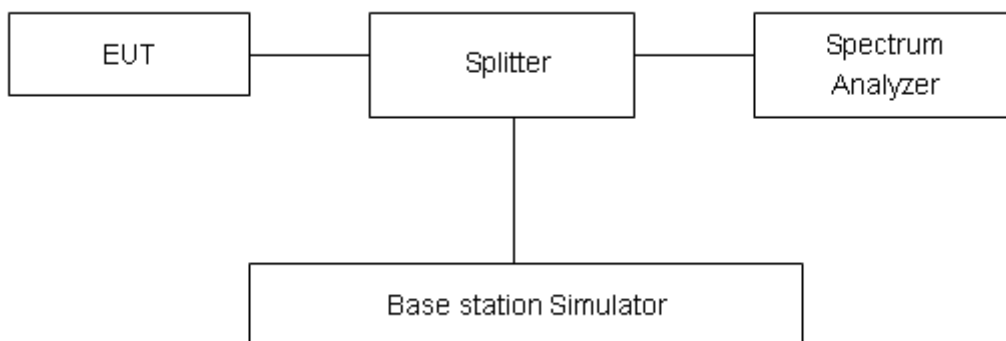

#### Limits

No specific occupied bandwidth requirements in part 2.1049.

Part 90.209 (a) Each authorization issued to a station licensed under this part will show an emission designator representing the class of emission authorized. The designator will be prefixed by a specified necessary bandwidth. This number does not necessarily indicate the bandwidth occupied by the emission at any instant. In those cases where part 2.202 of this chapter does not provide a formula for the computation of necessary bandwidth, the occupied bandwidth, as defined in part 2 of this chapter, may be used in lieu of the necessary bandwidth.

#### Measurement Uncertainty

The assessed measurement uncertainty to ensure 95% confidence level for the normal distribution is with the coverage factor  $k = 2$ ,  $U = 624\text{Hz}$ .



Test Result

LTE Band 14						
RB	Modulation	Bandwidth (MHz)	Channel	Frequency (MHz)	99% Power Bandwidth(MHz)	-26dBc Bandwidth(MHz)
100%	QPSK	5	23305	790.5	4.5188	5.019
			23330	793	4.5063	5.009
			23355	795.5	4.5030	4.933
		10	23330	793	8.9978	10.140
	16QAM	5	23305	790.5	4.4931	4.985
			23330	793	4.5126	5.005
			23355	795.5	4.5084	5.031
		10	23330	793	9.0277	10.030

LTE Band 14 QPSK 5MHz CH-Low

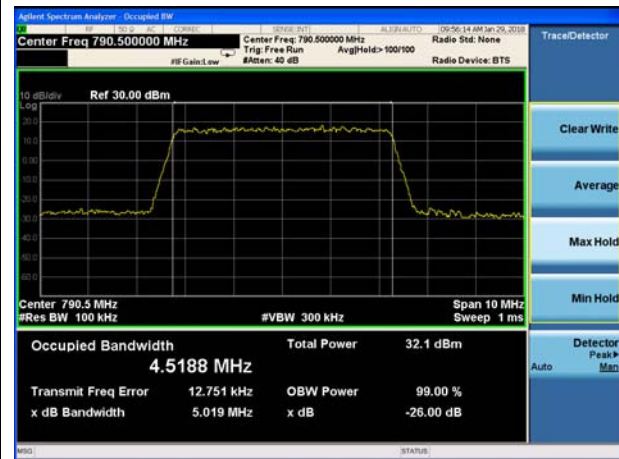

LTE Band 14 QPSK 5MHz CH-Middle



LTE Band 14 QPSK 5MHz CH-High

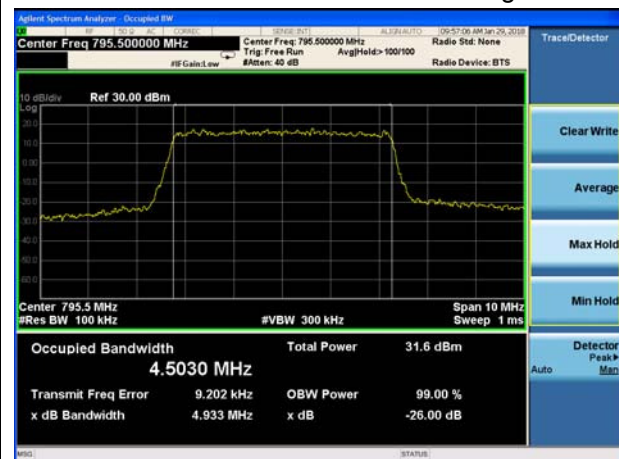

LTE Band 14 QPSK 10MHz CH-Middle

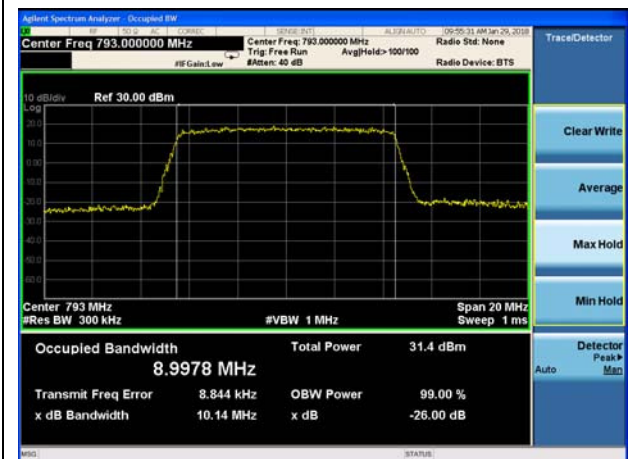



### LTE Band 14 16QAM 5MHz CH-Low



### LTE Band 14 16QAM 5MHz CH-Middle



### LTE Band 14 16QAM 5MHz CH-High



### LTE Band 14 16QAM 10MHz CH-Middle





### 5.4. Band Edge Compliance

#### Ambient condition

Temperature	Relative humidity	Pressure
23°C ~25°C	45%~50%	101.5kPa

#### Method of Measurement

The EUT was connected to Spectrum Analyzer and Base Station Simulator via power Splitter. The band edge of the lowest and highest channels were measured.

The testing follows KDB 971168 v03 Section 6.0

- 1.The EUT was connected to spectrum analyzer and system simulator via a power divider.
2. The band edges of low and high channels for the highest RF powers were measured. RBW is set to 51 kHz, VBW is set to 160 kHz for LTE Band 14 (5MHz). RBW is set to 100 kHz, VBW is set to 300kHz for LTE Band14 (10MHz).
3. Set spectrum analyzer with RMS detector.
4. The RF fundamental frequency should be excluded against the limit line in the operating frequency band.
5. Checked that all the results comply with the emission limit line.

#### Test Setup

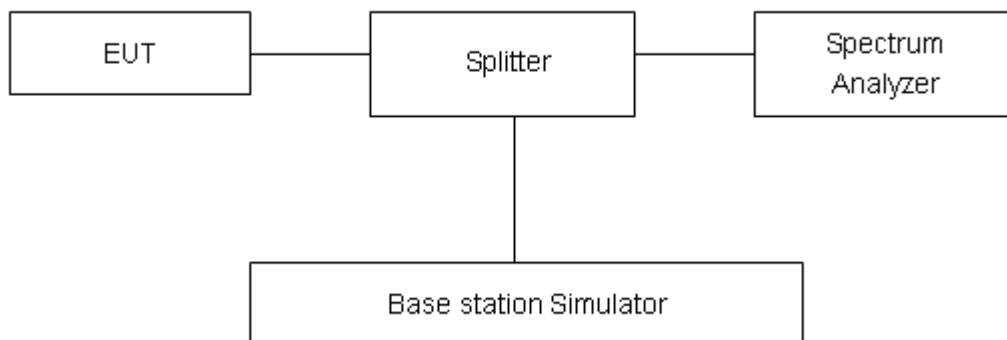

#### Limits

90.543 Emission limitations (e) For operations in the 758-768 MHz and the 788-798 MHz bands, the power of any emission outside the licensee's frequency band(s) of operation shall be attenuated below the transmitter power (P) within the licensed band(s) of operation, measured in watts, in accordance with the following:

- (1) On all frequencies between 769-775 MHz and 799-805 MHz, by a factor not less than  $76 + 10 \log(P)$  dB in a 6.25 kHz band segment, for base and fixed stations.



(2) On all frequencies between 769-775 MHz and 799-805 MHz, by a factor not less than  $65 + 10 \log(P)$  dB in a 6.25 kHz band segment, for mobile and portable stations.

(3) On any frequency between 775-788 MHz, above 805 MHz, and below 758 MHz, by at least  $43 + 10 \log(P)$  dB.

(4) Compliance with the provisions of paragraphs (e)(1) and (2) of this section is based on the use of measurement instrumentation such that the reading taken with any resolution bandwidth setting should be adjusted to indicate spectral energy in a 6.25 kHz segment.

(5) Compliance with the provisions of paragraph (e)(3) of this section is based on the use of measurement instrumentation employing a resolution bandwidth of 100 kHz or greater. However, in the 100 kHz bands immediately outside and adjacent to the frequency block, a resolution bandwidth of 30 kHz may be employed.

(f) For operations in the 758-775 MHz and 788-805 MHz bands, all emissions including harmonics in the band 1559-1610 MHz shall be limited to  $-70$  dBW/MHz equivalent isotropically radiated power (EIRP) for wideband signals, and  $-80$  dBW EIRP for discrete emissions of less than 700 Hz bandwidth. For the purpose of equipment authorization, a transmitter shall be tested with an antenna that is representative of the type that will be used with the equipment in normal operation.

### Measurement Uncertainty

The assessed measurement uncertainty to ensure 95% confidence level for the normal distribution is with the coverage factor  $k = 1.96$ ,  $U=0.684$ dB.



Test Result:

LTE Band 14 QPSK 5MHz 1 RB (769MHz ~775MHz)

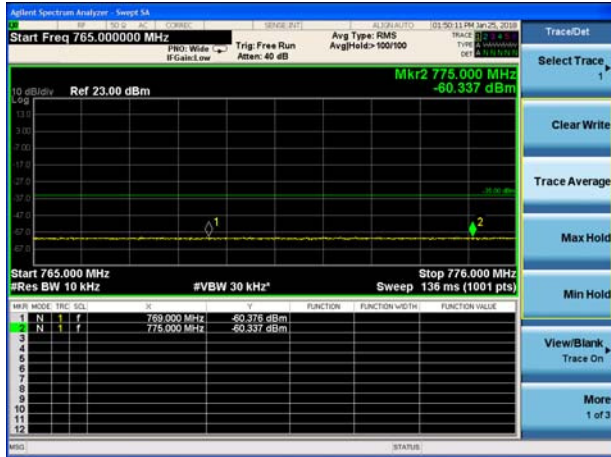

LTE Band 14 QPSK 10MHz 1 RB (769MHz ~775MHz)

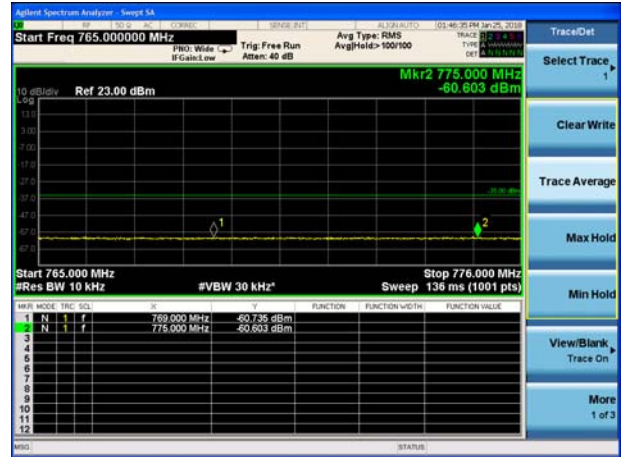

LTE Band 14 QPSK 5MHz 1 RB (775MHz ~788MHz)

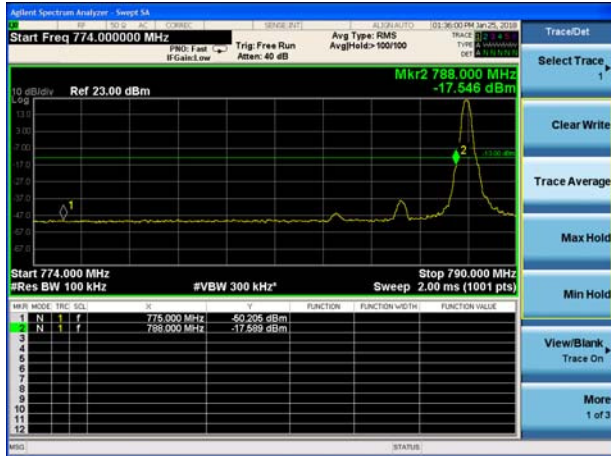

LTE Band 14 QPSK 10MHz 1 RB (775MHz ~788MHz)

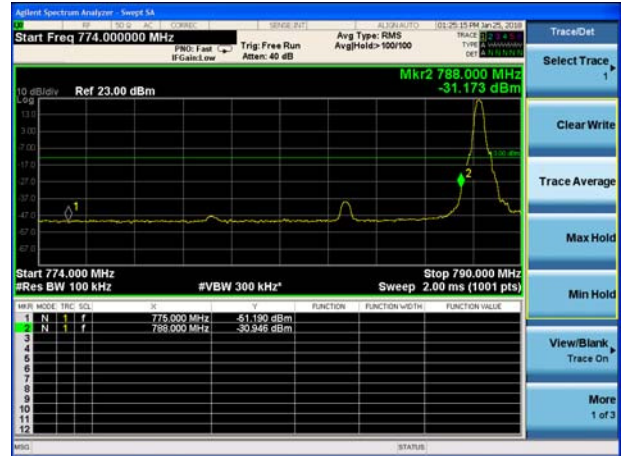

LTE Band 14 QPSK 5MHz 1 RB (799MHz ~805MHz)



LTE Band 14 QPSK 10MHz 1 RB (799MHz ~805MHz)





LTE Band 14 QPSK 5MHz 100%RB (769MHz ~775MHz)

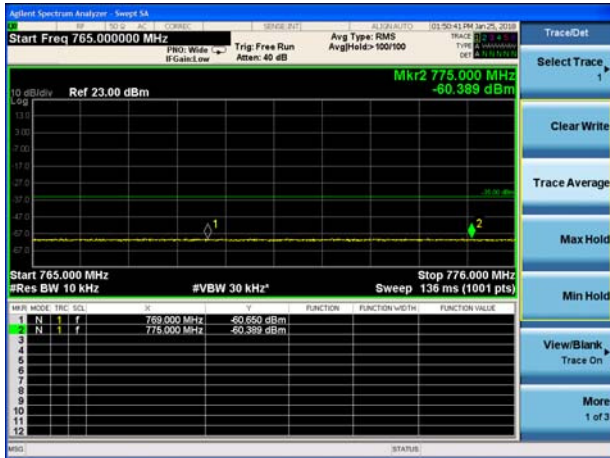

LTE Band 14 QPSK 10MHz 100%RB (769MHz ~775MHz)

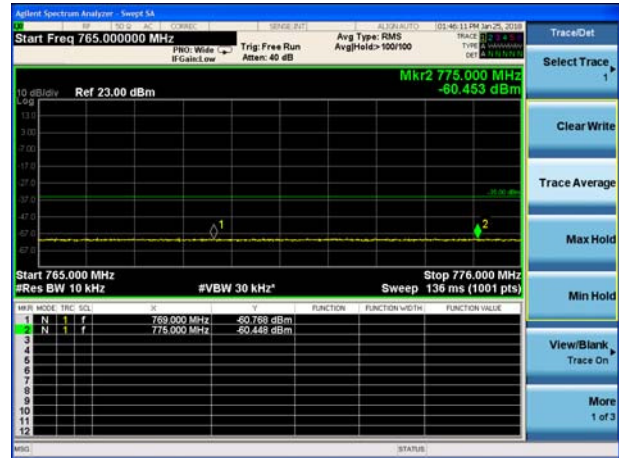

LTE Band 14 QPSK 5MHz 100%RB (775MHz ~788MHz)



LTE Band 14 QPSK 10MHz 100%RB (775MHz ~788MHz)



LTE Band 14 QPSK 5MHz 100%RB (799MHz ~805MHz)



LTE Band 14 QPSK 10MHz 100%RB (799MHz ~805MHz)

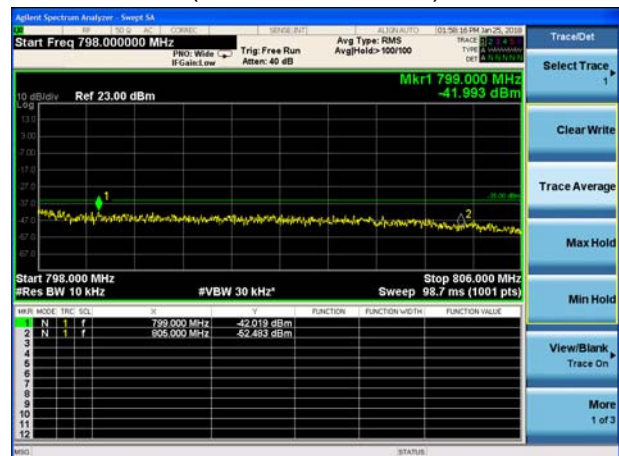



LTE Band 14 16QAM 5MHz 1 RB (769MHz ~775MHz)

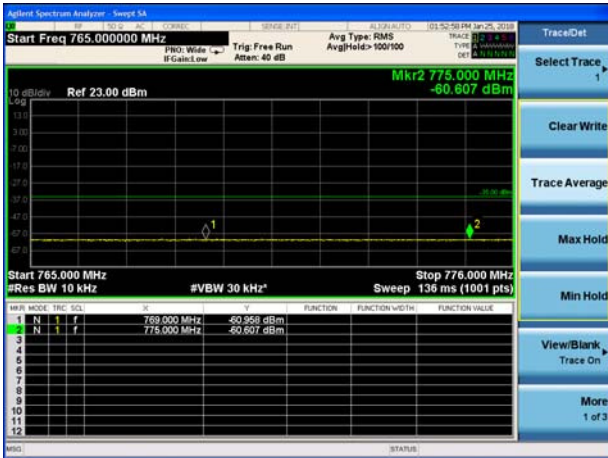

LTE Band 14 16QAM 10MHz 1 RB (769MHz ~775MHz)

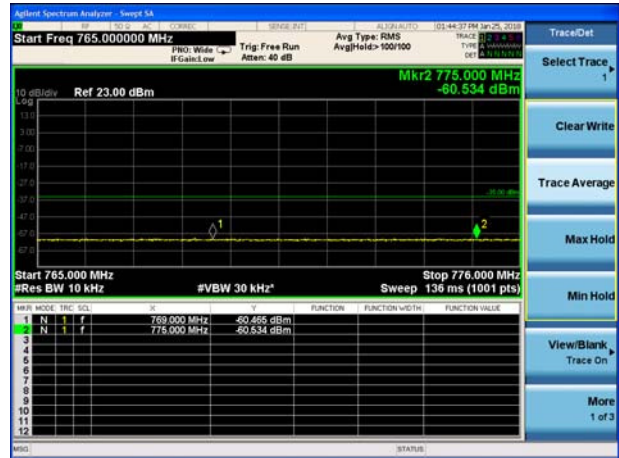

LTE Band 14 16QAM 5MHz 1 RB (775MHz ~788MHz)

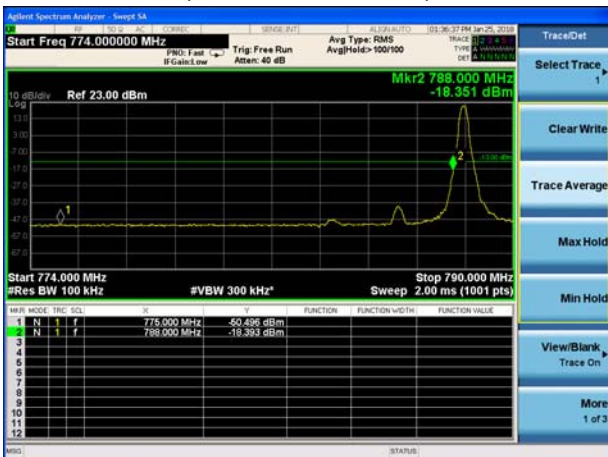

LTE Band 14 16QAM 10MHz 1 RB (775MHz ~788MHz)



LTE Band 14 16QAM 5MHz 1 RB (799MHz ~805MHz)



LTE Band 14 16QAM 10MHz 1 RB (799MHz ~805MHz)







LTE Band 14 16QAM 5MHz 100%RB  
(769MHz ~775MHz)

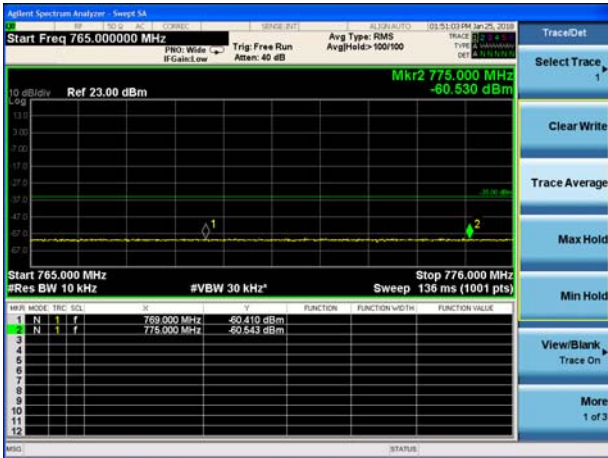

LTE Band 14 16QAM 10MHz 100%RB  
(769MHz ~775MHz)

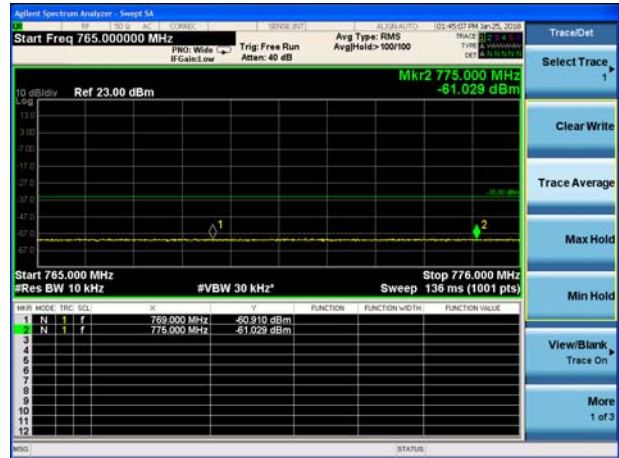

LTE Band 14 16QAM 5MHz 100%RB  
(775MHz ~788MHz)



LTE Band 14 16QAM 10MHz 100%RB  
(775MHz ~788MHz)



LTE Band 14 16QAM 5MHz 100%RB  
(799MHz ~805MHz)



LTE Band 14 16QAM 10MHz 100%RB  
(799MHz ~805MHz)

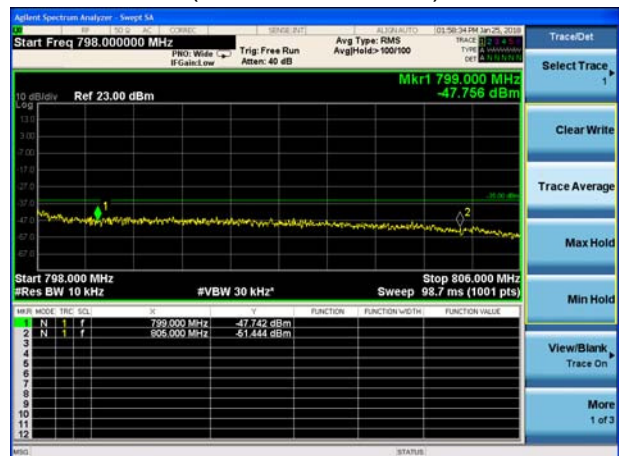

### 5.5. Peak-to-Average Power Ratio (PAPR)

#### Ambient condition

Temperature	Relative humidity	Pressure
23°C ~25°C	45%~50%	101.5kPa

#### Methods of Measurement

Measure the total peak power and record as PPK. And measure the total average power and record as PAvg. Both the peak and average power levels must be expressed in the same logarithmic units (e.g., dBm). Determine the PAPR from:

$$PAPR (dB) = PPK (dBm) - PAvg (dBm).$$

#### Test Setup

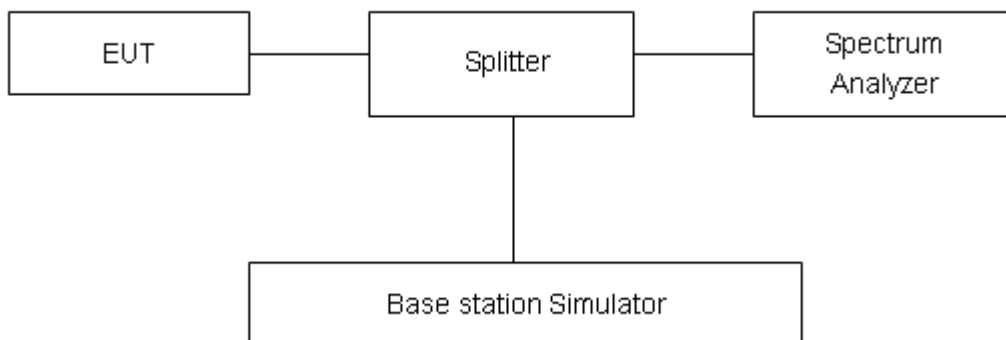

#### Limits

In measuring transmissions in this band using an average power technique, the peak-to-average ratio (PAR) of the transmission may not exceed 13 dB in 24.232(d).

#### Measurement Uncertainty

The assessed measurement uncertainty to ensure 95% confidence level for the normal distribution is with the coverage factor  $k = 2$ ,  $U = 0.4$  dB.

**Test Results**

LTE Band 14								
Modulation	Bandwidth (MHz)	Channel	Frequency (MHz)	Peak (dBm)	Avg (dBm)	PAPR (dB)	Limit (dB)	Conclusion
QPSK	5	23305	790.5	27.55	22.53	5.02	≤13	PASS
		23330	793	27.50	22.52	4.98	≤13	PASS
		23355	795.5	27.63	22.63	5.00	≤13	PASS
	10	23330	793	27.65	22.57	5.08	≤13	PASS
16QAM	5	23305	790.5	27.32	21.51	5.81	≤13	PASS
		23330	793	27.40	21.55	5.85	≤13	PASS
		23355	795.5	27.47	21.65	5.82	≤13	PASS
	10	23330	793	27.46	21.58	5.88	≤13	PASS



## 5.6. Frequency Stability

### Ambient condition

Temperature	Relative humidity	Pressure
23°C ~25°C	45%~50%	101.5kPa

### Method of Measurement

#### 1. Frequency Stability (Temperature Variation)

The temperature inside the climate chamber is varied from -30°C to +55°C in 10°C step size,

(1) With all power removed, the temperature was decreased to 0°C and permitted to stabilize for three hours.

(2) Measure the carrier frequency with the test equipment in a “call mode”. These measurements should be made within 1 minute of powering up the mobile station, to prevent significant self warming.

(3) Repeat the above measurements at 10°C increments from -30°C to +55°C. Allow at least 1.5 hours at each temperature, un-powered, before making measurements.

#### 2. Frequency Stability (Voltage Variation)

The frequency stability shall be measured with variation of primary supply voltage as follows:

(1) Vary primary supply voltage from 85 to 115 percent of the nominal value for other than hand carried battery equipment.

(2) For hand carried, battery powered equipment, reduce primary supply voltage to the battery-operating end point which shall be specified by the manufacturer.

This transceiver is specified to operate with an input voltage of between 3.6 V and 4.4 V, with a nominal voltage of 3.85V.

### Test setup

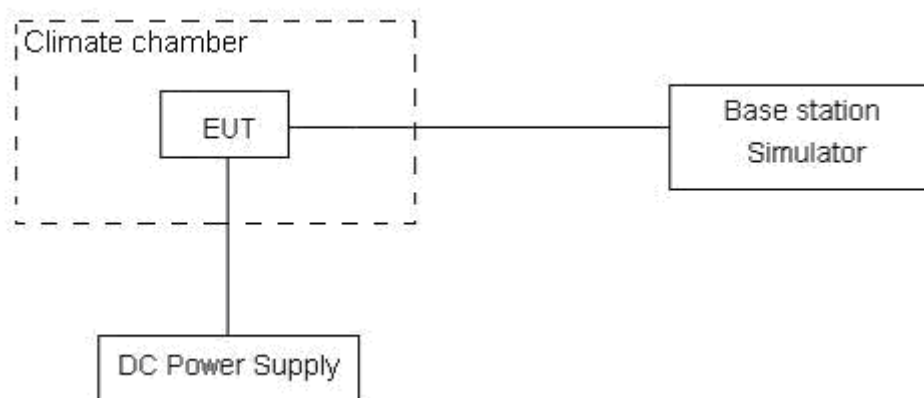

**Limits**

90.539 (c) The frequency stability of mobile, portable, and control transmitters operating in the narrowband segment must be 400 parts per billion or better when AFC is locked to the base station. When AFC is not locked to the base station, the frequency stability must be at least 1.0 ppm for 6.25 kHz, 1.5 ppm for 12.5 kHz (2 channel aggregate), and 2.5 ppm for 25 kHz (4 channel aggregate).

**Measurement Uncertainty**

The assessed measurement uncertainty to ensure 99.75% confidence level for the normal distribution is with the coverage factor  $k = 3$ ,  $U = 0.01\text{ppm}$ .

**Test Result**

Bandwidth	Test status	LTE Band 14 Channel 23330 Test Results (ppm)	
		QPSK	16QAM
5MHz	-30°C/Normal Voltage	0.00810	0.00367
	-20°C/Normal Voltage	0.00681	-0.00555
	-10°C/Normal Voltage	0.00436	0.00665
	0°C/Normal Voltage	0.00087	-0.00405
	10°C/Normal Voltage	0.00634	-0.00707
	20°C/Normal Voltage	0.01010	-0.00458
	30°C/Normal Voltage	0.00914	-0.00443
	40°C/Normal Voltage	0.00807	-0.00342
	50°C/Normal Voltage	-0.00058	0.00952
	55°C/Normal Voltage	0.00311	0.00542
	20°C/Min Voltage	0.00226	-0.01359
	20°C/Max Voltage	-0.00309	0.00612
10MHz	-30°C/Normal Voltage	0.00058	-0.00216
	-20°C/Normal Voltage	0.00409	0.00576
	-10°C/Normal Voltage	0.00247	0.00028
	0°C/Normal Voltage	0.00646	0.00446
	10°C/Normal Voltage	0.00120	0.00487
	20°C/Normal Voltage	-0.00262	-0.00303
	30°C/Normal Voltage	-0.01102	-0.00393
	40°C/Normal Voltage	0.00760	0.00006
	50°C/Normal Voltage	-0.00353	0.00604
	55°C/Normal Voltage	0.00890	0.00290
	20°C/Min Voltage	0.00743	0.00223
	20°C/Max Voltage	-0.00294	0.00335

## 5.7. Spurious Emissions at Antenna Terminals

### Ambient condition

Temperature	Relative humidity	Pressure
23°C ~25°C	45%~50%	101.5kPa

### Method of Measurement

The EUT was connected to Spectrum Analyzer and Base Station Simulator via power Splitter. The measurement is carried out using a spectrum analyzer. The spectrum analyzer scans from 30MHz to the 10th harmonic of the carrier. The peak detector is used. Set RBW 1MHz and VBW 3MHz, Sweep is set to ATUO.

Of those disturbances below (limit – 20 dB), the mark is not required for the EUT.

### Test setup

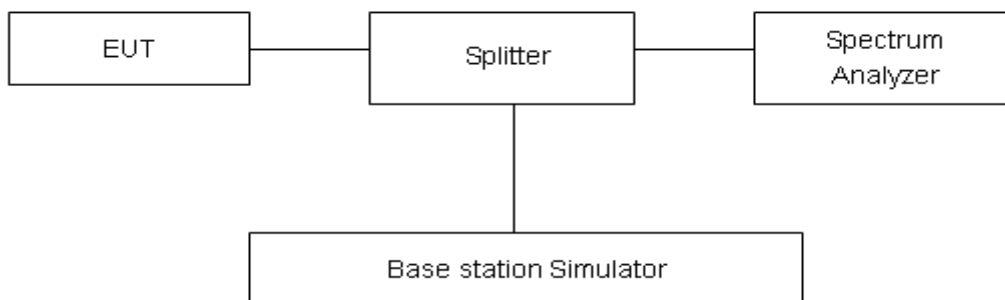

### Limits

90.543 Emission limitations (e) For operations in the 758-768 MHz and the 788-798 MHz bands, the power of any emission outside the licensee's frequency band(s) of operation shall be attenuated below the transmitter power (P) within the licensed band(s) of operation, measured in watts, in accordance with the following:

- (1) On all frequencies between 769-775 MHz and 799-805 MHz, by a factor not less than  $76 + 10 \log (P)$  dB in a 6.25 kHz band segment, for base and fixed stations.
- (2) On all frequencies between 769-775 MHz and 799-805 MHz, by a factor not less than  $65 + 10 \log (P)$  dB in a 6.25 kHz band segment, for mobile and portable stations.
- (3) On any frequency between 775-788 MHz, above 805 MHz, and below 758 MHz, by at least  $43 + 10 \log (P)$  dB.
- (4) Compliance with the provisions of paragraphs (e)(1) and (2) of this section is based on the use of measurement instrumentation such that the reading taken with any resolution bandwidth setting should be adjusted to indicate spectral energy in a 6.25 kHz segment.



(5) Compliance with the provisions of paragraph (e)(3) of this section is based on the use of measurement instrumentation employing a resolution bandwidth of 100 kHz or greater. However, in the 100 kHz bands immediately outside and adjacent to the frequency block, a resolution bandwidth of 30 kHz may be employed.

(f) For operations in the 758-775 MHz and 788-805 MHz bands, all emissions including harmonics in the band 1559-1610 MHz shall be limited to  $-70$  dBW/MHz equivalent isotropically radiated power (EIRP) for wideband signals, and  $-80$  dBW EIRP for discrete emissions of less than 700 Hz bandwidth. For the purpose of equipment authorization, a transmitter shall be tested with an antenna that is representative of the type that will be used with the equipment in normal operation.

### Measurement Uncertainty

The assessed measurement uncertainty to ensure 99.75% confidence level for the normal distribution is with the coverage factor  $k = 1.96$ .

Frequency	Uncertainty
100kHz-1GHz	0.684 dB
1GHz-12.75GHz	1.407 dB



### Test Result

If disturbances were found more than 20dB below limit line, the mark is not required for the EUT.  
The signal beyond the limit is carrier.

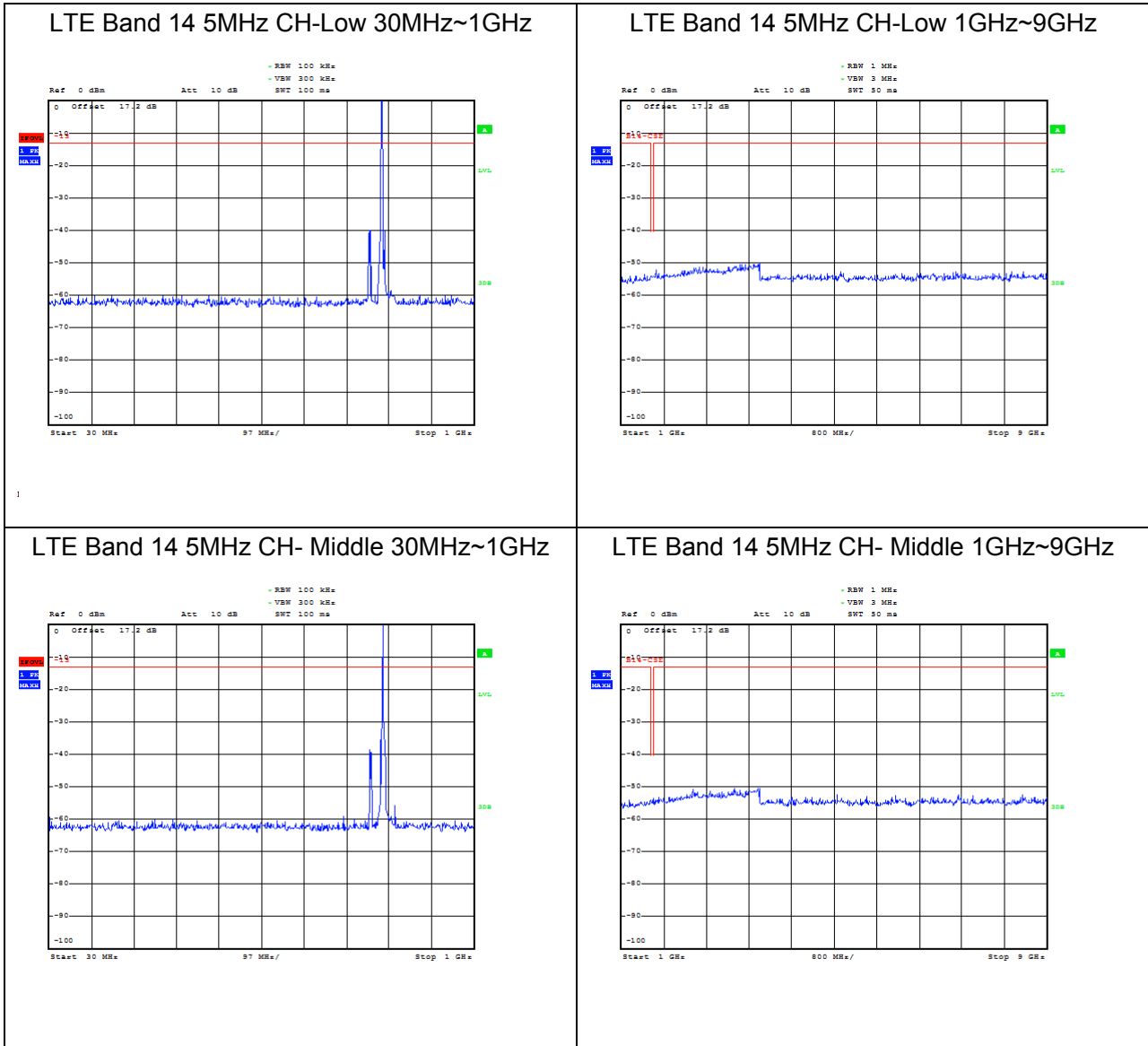

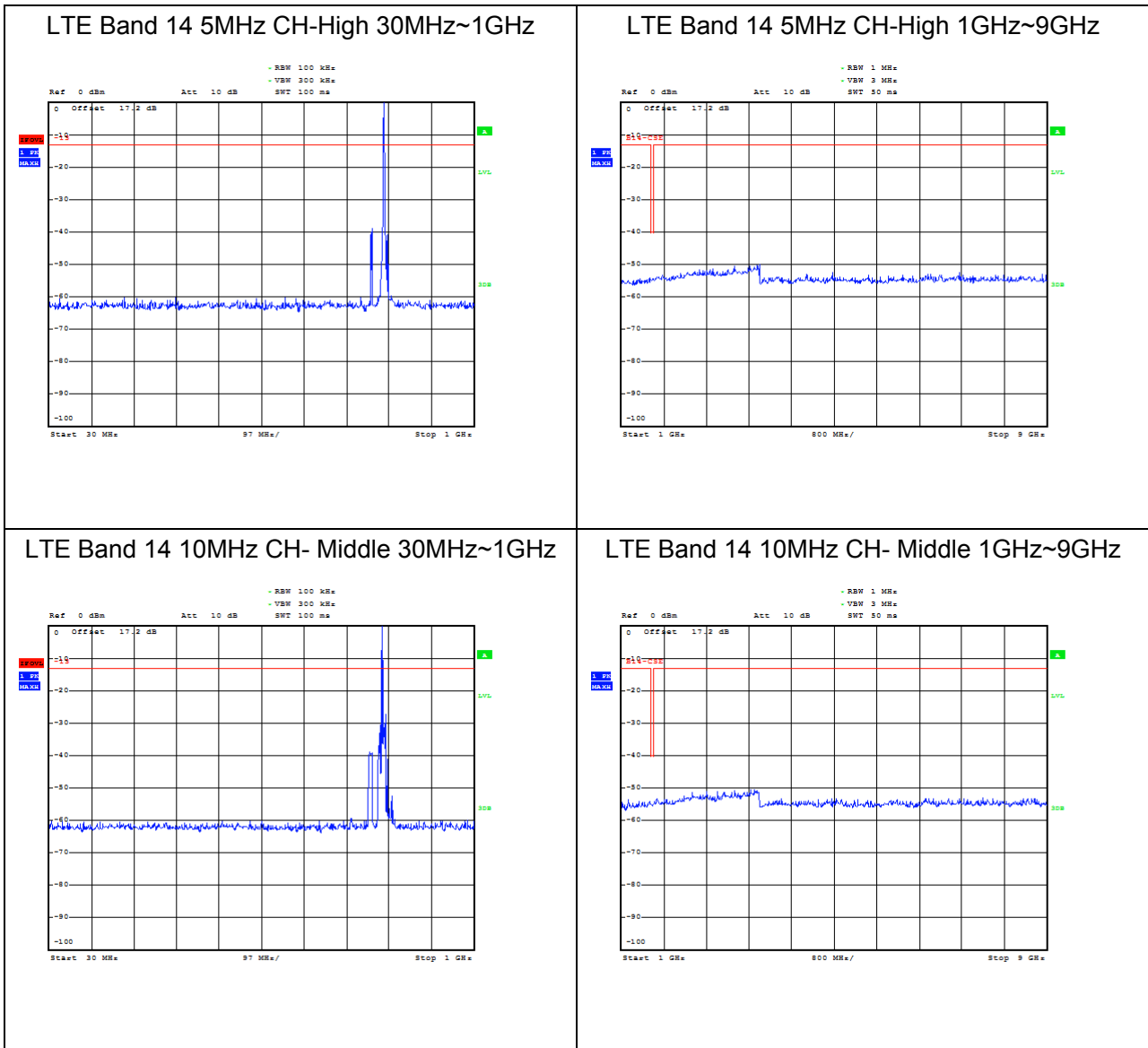

If disturbances were found more than 20dB below limit line, the mark is not required for the EUT. The signal beyond the limit is carrier in the following plots.

Test Data File Name	Frequency (MHz)	Level (dBm)	Limit (dBm)	Margin (dB)
B14_CHLOW_5M_RB1_1-9GHz	1571.4	-30.637	-13	17.637
B14_CHMID_5M_RB1_1-9GHz	1571.8	-29.987	-13	16.987
B14_CHHIGH_5M_RB1_1-9GHz	1576.0	-29.215	-13	16.215
B14_10M_RB1_1-9GHz	1574.0	-30.105	-13	17.105

## 5.8. Radiates Spurious Emission

### Ambient condition

Temperature	Relative humidity	Pressure
23°C ~25°C	45%~50%	101.5kPa

### Method of Measurement

1. The testing follows FCC KDB 971168 v03 Section 5.8 and **ANSI/TIA-603-E-2016**.
2. The EUT is placed on a turntable 0.8 meters above the ground in the chamber, 3 meter away from the antenna. The maximal emission value is acquired by adjusting the antenna height, polarisation and turntable azimuth. Normally, the height range of antenna is 1 m to 4 m, the azimuth range of turntable is 0° to 360°, and the receive antenna has two polarizations Vertical (V) and Horizontal (H).
3. A log-periodic antenna or double-ridged waveguide horn antenna shall be substituted in place of the EUT. The log-periodic antenna will be driven by a signal generator and the level will be adjusted till the same power value on the spectrum analyzer or receiver. The level of the spurious emissions can be calculated through the level of the signal generator, cable loss, the gain of the substitution antenna and the reading of the spectrum analyzer or receiver.
4. The EUT is then put into continuously transmitting mode at its maximum power level during the test. Set Test Receiver or Spectrum RBW=1MHz, VBW=3MHz, And the maximum value of the receiver should be recorded as (Pr).
5. The EUT shall be replaced by a substitution antenna. In the chamber, an substitution antenna for the frequency band of interest is placed at the reference point of the chamber. An RF Signal source for the frequency band of interest is connected to the substitution antenna with a cable that has been constructed to not interfere with the radiation pattern of the antenna. A power (PMea) is applied to the input of the substitution antenna, and adjust the level of the signal generator output until the value of the receiver reach the previously recorded (Pr). The power of signal source (PMea) is recorded. The test should be performed by rotating the test item and adjusting the receiving antenna polarization.
6. A amplifier should be connected to the Signal Source output port. And the cable should be connect between the Amplifier and the Substitution Antenna. The cable loss (Pcl), the Substitution Antenna Gain (Ga) and the Amplifier Gain (PAg) should be recorded after test.
7. The measurement results are obtained as described below:  
Power(EIRP)=PMea- PAg - Pcl + Ga  
The measurement results are amend as described below:  
Power(EIRP)=PMea- Pcl + Ga
8. This value is EIRP since the measurement is calibrated using an antenna of known gain (2.15 dBi) and known input power. ERP can be calculated from EIRP by subtracting the gain of the dipole, ERP = EIRP-2.15dBi.



**Test setup**

**30MHz~~~ 1GHz**

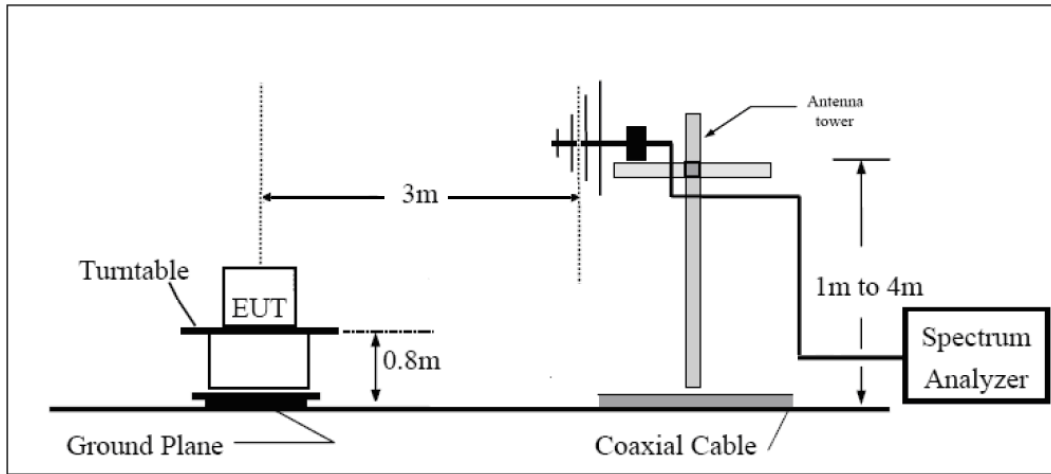

**Above 1GHz**

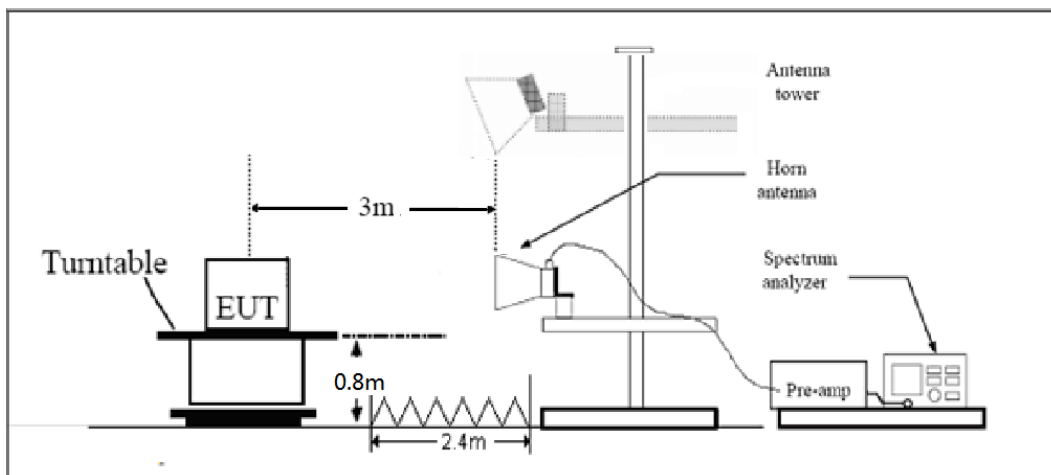

Note: Area side:2.4mX3.6m

The radiated emission was measured in the following position: EUT stand-up position (Z axis), lie-down position (X, Y axis). The worst emission was found in stand-up position (Z axis) and the worst case was recorded.

**Limits**

90.543 Emission limitations (e) For operations in the 758-768 MHz and the 788-798 MHz bands, the power of any emission outside the licensee's frequency band(s) of operation shall be attenuated below the transmitter power (P) within the licensed band(s) of operation, measured in watts, in accordance with the following:

- (1) On all frequencies between 769-775 MHz and 799-805 MHz, by a factor not less than  $76 + 10 \log(P)$  dB in a 6.25 kHz band segment, for base and fixed stations.



(2) On all frequencies between 769-775 MHz and 799-805 MHz, by a factor not less than  $65 + 10 \log (P)$  dB in a 6.25 kHz band segment, for mobile and portable stations.

(3) On any frequency between 775-788 MHz, above 805 MHz, and below 758 MHz, by at least  $43 + 10 \log (P)$  dB.

(4) Compliance with the provisions of paragraphs (e)(1) and (2) of this section is based on the use of measurement instrumentation such that the reading taken with any resolution bandwidth setting should be adjusted to indicate spectral energy in a 6.25 kHz segment.

(5) Compliance with the provisions of paragraph (e)(3) of this section is based on the use of measurement instrumentation employing a resolution bandwidth of 100 kHz or greater. However, in the 100 kHz bands immediately outside and adjacent to the frequency block, a resolution bandwidth of 30 kHz may be employed.

(f) For operations in the 758-775 MHz and 788-805 MHz bands, all emissions including harmonics in the band 1559-1610 MHz shall be limited to  $-70$  dBW/MHz equivalent isotropically radiated power (EIRP) for wideband signals, and  $-80$  dBW EIRP for discrete emissions of less than 700 Hz bandwidth. For the purpose of equipment authorization, a transmitter shall be tested with an antenna that is representative of the type that will be used with the equipment in normal operation.

### Measurement Uncertainty

The assessed measurement uncertainty to ensure 95% confidence level for the normal distribution is with the coverage factor  $k = 1.96$ ,  $U = 3.55$  dB.

**Test Result**

- Note: 1.Receiver antenna polarization (horizontal and vertical), the worst emission was found in vertical polarization, and the worst case in vertical polarization was recorded.  
2. The other Spurious RF Radiated emissions level is no more than noise floor.

LTE Band 14 QPSK 5MHz CH-Low, RB 1

Harmonic	Frequency (MHz)	SG (dBm)	Cable Loss (dB)	Gain (dBi)	Antenna Polarization	ERP Level (dBm)	Limit (dBm)	Margin (dB)	Azimuth (deg)
2	1576.5	-52.23	2.00	10.15	Horizontal	-46.23	-40.00	6.23	135
3	2371.5	-57.25	2.50	11.35	Horizontal	-50.55	-13.00	37.55	90
4	3162.0	-53.83	4.20	10.85	Horizontal	-49.33	-13.00	36.33	225
5	3952.5	-53.47	5.20	11.35	Horizontal	-49.47	-13.00	36.47	270
6	4743.0	-51.36	5.50	11.95	Horizontal	-47.06	-13.00	34.06	0
7	5533.5	-50.48	5.70	13.55	Horizontal	-44.78	-13.00	31.78	45
8	6324.0	-50.80	6.30	13.75	Horizontal	-45.50	-13.00	32.50	225
9	7114.5	-46.20	6.80	13.85	Horizontal	-41.30	-13.00	28.30	180
10	7905.0	-46.85	6.90	14.25	Horizontal	-41.65	-13.00	28.65	90

- Note: 1.The other Spurious RF Radiated emissions level is no more than noise floor.  
2. The worst emission was found in the antenna is Horizontal position.

LTE Band 14 QPSK 5MHz CH-Middle, RB 1

Harmonic	Frequency (MHz)	SG (dBm)	Cable Loss (dB)	Gain (dBi)	Antenna Polarization	ERP Level (dBm)	Limit (dBm)	Margin (dB)	Azimuth (deg)
2	1581.6	-49.12	2.00	10.75	Horizontal	-42.52	-40	2.52	135
3	2379.0	-55.26	2.51	11.05	Horizontal	-48.87	-13.00	35.87	225
4	3172.0	-54.26	4.20	11.15	Horizontal	-49.46	-13.00	36.46	270
5	3965.0	-52.43	5.20	11.15	Horizontal	-48.63	-13.00	35.63	90
6	4758.0	-49.56	5.50	11.95	Horizontal	-45.26	-13.00	32.26	180
7	5551.0	-51.86	5.70	13.55	Horizontal	-46.16	-13.00	33.16	225
8	6344.0	-48.08	6.30	13.75	Horizontal	-42.78	-13.00	29.78	45
9	7137.0	-44.23	6.80	13.85	Horizontal	-39.33	-13.00	26.33	180
10	7930.0	-45.15	6.90	14.25	Horizontal	-39.95	-13.00	26.95	270

Note: 1.The other Spurious RF Radiated emissions level is no more than noise floor.  
 2. The worst emission was found in the antenna is Horizontal position.

LTE Band 14 QPSK 5MHz CH-High, RB 1

Harmonic	Frequency (MHz)	SG (dBm)	Cable Loss (dB)	Gain (dBi)	Antenna Polarization	ERP Level (dBm)	Limit (dBm)	Margin (dB)	Azimuth (deg)
2	1586.4	-48.99	2.00	10.15	Horizontal	-42.99	-40	2.99	135
3	2386.5	-56.66	2.51	11.05	Horizontal	-50.27	-13.00	37.27	270
4	3182.0	-54.95	4.20	11.15	Horizontal	-50.15	-13.00	37.15	180
5	3977.5	-53.26	5.20	11.15	Horizontal	-49.46	-13.00	36.46	225
6	4773.0	-51.60	5.50	11.95	Horizontal	-47.30	-13.00	34.30	315
7	5568.5	-50.99	5.70	13.55	Horizontal	-45.29	-13.00	32.29	270
8	6364.0	-50.08	6.30	13.75	Horizontal	-44.78	-13.00	31.78	135
9	7159.5	-46.03	6.80	13.85	Horizontal	-41.13	-13.00	28.13	180
10	7955.0	-46.47	6.90	14.25	Horizontal	-41.27	-13.00	28.27	315

Note: 1.The other Spurious RF Radiated emissions level is no more than noise floor.  
 2. The worst emission was found in the antenna is Horizontal position.



## LTE Band 14 QPSK 10MHz CH-Low, RB 1

Harmonic	Frequency (MHz)	SG (dBm)	Cable Loss (dB)	Gain (dBi)	Antenna Polarization	ERP Level (dBm)	Limit (dBm)	Margin (dB)	Azimuth (deg)
2	1576.9	-52.82	2.00	10.15	Horizontal	-46.82	-40	6.82	135
3	2379.0	-56.72	2.51	11.35	Horizontal	-50.03	-13.00	37.03	225
4	3172.0	-54.16	4.20	10.85	Horizontal	-49.66	-13.00	36.66	225
5	3965.0	-52.43	5.20	11.35	Horizontal	-48.43	-13.00	35.43	45
6	4758.0	-50.99	5.50	11.95	Horizontal	-46.69	-13.00	33.69	0
7	5551.0	-52.25	5.70	13.55	Horizontal	-46.55	-13.00	33.55	270
8	6344.0	-49.55	6.30	13.75	Horizontal	-44.25	-13.00	31.25	180
9	7137.0	-45.98	6.80	13.85	Horizontal	-41.08	-13.00	28.08	90
10	7930.0	-54.72	6.90	14.25	Horizontal	-49.52	-13.00	36.52	135

Note: 1. The other Spurious RF Radiated emissions level is no more than noise floor.  
2. The worst emission was found in the antenna is Horizontal position.

## LTE Band 14 QPSK 10MHz CH-Middle, RB 1

Harmonic	Frequency (MHz)	SG (dBm)	Cable Loss (dB)	Gain (dBi)	Antenna Polarization	ERP Level (dBm)	Limit (dBm)	Margin (dB)	Azimuth (deg)
2	1577.1	-52.81	2.00	10.75	Horizontal	-46.21	-40	6.21	135
3	2378.4	-57.00	2.51	11.05	Horizontal	-50.61	-13.00	37.61	225
4	3172.0	-53.60	4.20	11.15	Horizontal	-48.80	-13.00	35.80	90
5	3965.0	-52.44	5.20	11.15	Horizontal	-48.64	-13.00	35.64	45
6	4758.0	-51.70	5.50	11.95	Horizontal	-47.40	-13.00	34.40	270
7	5551.0	-52.27	5.70	13.55	Horizontal	-46.57	-13.00	33.57	180
8	6344.0	-50.01	6.30	13.75	Horizontal	-44.71	-13.00	31.71	270
9	7137.0	-45.75	6.80	13.85	Horizontal	-40.85	-13.00	27.85	45
10	7930.0	-46.28	6.90	14.25	Horizontal	-41.08	-13.00	28.08	180

Note: 1. The other Spurious RF Radiated emissions level is no more than noise floor.  
2. The worst emission was found in the antenna is Horizontal position.



## LTE Band 14 QPSK 10MHz CH-High, RB 1

Harmonic	Frequency (MHz)	SG (dBm)	Cable Loss (dB)	Gain (dBi)	Antenna Polarization	ERP Level (dBm)	Limit (dBm)	Margin (dB)	Azimuth (deg)
2	1577.3	-51.49	2.00	10.15	Horizontal	-45.49	-40	5.49	135
3	2375.6	-56.42	2.51	11.05	Horizontal	-50.03	-13.00	37.03	270
4	3172.0	-53.52	4.20	11.15	Horizontal	-48.72	-13.00	35.72	180
5	3965.0	-53.00	5.20	11.15	Horizontal	-49.20	-13.00	36.20	90
6	4758.0	-51.90	5.50	11.95	Horizontal	-47.60	-13.00	34.60	225
7	5551.0	-52.88	5.70	13.55	Horizontal	-47.18	-13.00	34.18	270
8	6344.0	-50.71	6.30	13.75	Horizontal	-45.41	-13.00	32.41	135
9	7137.0	-46.75	6.80	13.85	Horizontal	-41.85	-13.00	28.85	180
10	7930.0	-45.48	6.90	14.25	Horizontal	-40.28	-13.00	27.28	315

Note: 1. The other Spurious RF Radiated emissions level is no more than noise floor.

2. The worst emission was found in the antenna is Horizontal position.

## 6. Main Test Instruments

Name	Manufacturer	Type	Serial Number	Calibration Date	Expiration Date
Base Station Simulator	R&S	CMW500	113645	2017-05-14	2018-05-13
Power Splitter	Hua Xiang	SHX-GF2-2-13	10120101	NA	NA
Spectrum Analyzer	Agilent	N9010A	MY47191109	2017-05-20	2018-05-19
Universal Radio Communication Tester	Agilent	E5515C	MY48367192	2017-05-20	2018-05-19
Signal Analyzer	R&S	FSV30	100815	2017-12-17	2018-12-16
EMI Test Receiver	R&S	ESCI	100948	2017-05-20	2018-05-19
Trilog Antenna	SCHWARZBECK	VUBL 9163	9163-201	2017-11-18	2020-11-17
Horn Antenna	R&S	HF907	100126	2014-12-06	2019-12-05
Signal generator	R&S	SMB 100A	102594	2017-05-14	2018-05-13
Climatic Chamber	Re Ce	PT-30B	20101891	2015-07-18	2018-07-17
RF Cable	Agilent	SMA 15cm	0001	2017-08-04	2019-02-03

\*\*\*\*\*END OF REPORT \*\*\*\*\*