Test Report FOR HAC T-coil

Report No.: SRTC2020-9004(F)-20122901(M)

Product Name: LTE Digital Mobile Phone

Product Model: Z6251V

Applicant: ZTE Corporation.

Manufacturer: ZTE Corporation.

Specification: FCC Part 20.19

ANSI C63.19

FCC ID: SRQ-Z6251V

The State Radio_monitoring_center Testing Center (SRTC)

15th Building, No.30, Shixing Street, Shijingshan District, Beijing, P.R.China

Tel: 86-10-57996183 Fax: 86-10-57996388

Contents

1 GENERAL INFORMATION	2
1.1 Notes of the test report.....	2
1.2 Information about the testing laboratory	2
1.3 Applicant’s details.....	2
1.4 Manufacturer’s details	2
1.5 Test Environment.....	3
2 DESCRIPTION OF THE DEVICE UNDER TEST	4
2.1 Final Equipment Build Status	4
2.2 Support Equipment.....	5
3 REFERENCE SPECIFICATIONS	6
4 RESULT SUMMAR.....	7
5 Test Procedures for all Technologies.....	9
6 Audio Level and Gain Measurements	14
7 Description of the test Position.....	17
7.1 Test positions.....	17
7.2 T-coil Requirements and Category Limits	18
8 Measurement uncertainty.....	20
9 T-Coil Testing for Standard Phone Application.....	21
9 .1 VOLTE Test Result	22
9 .2 VOWIFI Test Result	25
10 T-Coil testing for OTT Application.....	27
11 Test Equipments.....	30
11.1 Audio Magnetic Probe AM1DV2.....	31
11.2 Audio Magnetic Measurement Instrument AMMI	31
11.3 Audio Magnetic calibration Coil AMCC	31
ANNEX A: TEST PLOTS	32
A.1 Test Plot for Standard Phone Application	32
A.2 Test Plot for OTT Application.....	59

1 GENERAL INFORMATION

1.1 Notes of the test report

The test report may only be reproduced or published in full. Reproduction or publication of extracts from the report requires the prior written permission of The State Radio_monitoring_center Testing Center (SRTC).

The test results relate only to individual items of the samples which have been tested.

The certification and accreditation identifiers used in this report shall not be applicable to the tested or calibrated samples thereof. The manufacturer shall not mark the tested samples or items (or a separate part of the item) with the identifiers of certification and accreditation to mislead relevant parties about the tested samples or items.

1.2 Information about the testing laboratory

Company:	The State Radio_monitoring_center Testing Center (SRTC)
Address:	15th Building, No.30 Shixing Street, Shijingshan District, Beijing P.R.China
City:	Beijing
Country or Region:	P.R.China
Contacted person:	Liu Jia
Tel:	+86 10 57996183
Fax:	+86 10 57996388
Email:	liujiaf@srtc.org.cn

1.3 Applicant's details

Company:	ZTE Corporation.
Address:	ZTE Plaza, Keji Road South, Hi-Tech, Industrial Park, Nanshan District, Shenzhen, Guangdong, P.R.China
City:	Shenzhen
Country or Region:	China
Contacted person:	Gong Yu
Tel:	021-68895397
Fax:	---
Email:	gongyu@zte.com.cn

1.4 Manufacturer's details

Company:	ZTE Corporation.
Address:	ZTE Plaza, Keji Road South, Hi-Tech, Industrial Park, Nanshan District, Shenzhen, Guangdong, P.R.China
City:	Shenzhen
Country or Region:	China
Contacted person:	Gong Yu
Tel:	021-68895397
Fax:	---
Email:	gongyu@zte.com.cn

1.5 Test Environment

Date of Receipt of test sample at SRTC:	2020-12-29
Testing Start Date:	2020-12-29
Testing End Date:	2021-01-25

Environmental Data:	Temperature(°C)	Humidity (%)
Ambient	22	40

Normal Supply Voltage (V d.c.):	3.82
---------------------------------	------

2 DESCRIPTION OF THE DEVICE UNDER TEST

2.1 Final Equipment Build Status

Wireless Technology and Frequency Bands	<input checked="" type="checkbox"/> LTE Band: 2/4/5/12/13/66 <input checked="" type="checkbox"/> Bluetooth Band: 2.4GHz <input checked="" type="checkbox"/> Wi-Fi Band: 2.4GHz ,5GHz(U-NII-1,U-NII-3)
Mode	GSM <input type="checkbox"/> Voice (GMSK) <input type="checkbox"/> GPRS (GMSK) <input type="checkbox"/> EGPRS (GMSK/8PSK) WCDMA <input type="checkbox"/> UMTS Rel. 99 (Voice & Data) <input type="checkbox"/> HSDPA (Rel. 5) <input type="checkbox"/> HSUPA (Rel. 6) <input type="checkbox"/> HSPA+ (Rel.7) <input type="checkbox"/> DC-HSDPA (Rel.8) Wi-Fi (802.11b/g/n/ac) <input checked="" type="checkbox"/> 802.11a <input checked="" type="checkbox"/> 802.11b <input checked="" type="checkbox"/> 802.11g <input checked="" type="checkbox"/> 802.11n (20MHz) <input type="checkbox"/> 802.11n (40MHz) <input checked="" type="checkbox"/> 802.11ac (20MHz) <input checked="" type="checkbox"/> 802.11ac (40MHz) <input checked="" type="checkbox"/> 802.11ac (80MHz) <input type="checkbox"/> 802.11ac (160MHz) Bluetooth <input checked="" type="checkbox"/> BR(GFSK) <input checked="" type="checkbox"/> EDR($\pi/4$ DQPSK , 8-DPSK) <input checked="" type="checkbox"/> BLE(GFSK) LTE <input checked="" type="checkbox"/> QPSK <input checked="" type="checkbox"/> 16QAM <input checked="" type="checkbox"/> 64QAM

2.2 Support Equipment

The following support equipment was used to exercise the DUT during testing:

H/W Version	Z6251VHW1.0
S/W Version	Z6251VV1.0.0B01
IMEI	861381050002676
Normal	operation
Back	The Back Cover is not removable
Notes	---
Equipment	Battery 1
Manufacturer	Jiade Energy Technology (Zhuhai) Co., Ltd.
Model Number	Li3839T44P8h866445
Equipment	Charger 1
Manufacturer	SHENZHEN RUIJING INDUSTRIAL CO LTD
Model Number	STC-A520A-Z
Equipment	Charger 2
Manufacturer	Jiangsu Chenyang Electron Co.,Ltd.
Model Number	STC-A520A-Z
Equipment	USB Cable 1
Manufacturer	Dongguan Kingpower Electronics Co.,Ltd.
Model Number	USB-TC20-W-100-M-L
Equipment	USB Cable 2
Manufacturer	Guangdong Luxshare Ltd. Co
Model Number	USB-TC20-W-100-M-L

3 REFERENCE SPECIFICATIONS

Specification	Version	Title
Part 20.19	2019	Hearing aid-compatible mobile handsets.
C63.19	2011	American National Standard Methods of Measurement of Compatibility between Wireless Communications Devices and Hearing Aids
285076 D01	v05r01	Equipment Authorization Guidance for Hearing Aid Compatibility
285076 D02	v03	Guidance For Performing T-Coil Test for Aid Interfaces Supporting Voice Over IP to Support CMRS Based Telephone Services

4 RESULT SUMMAR

Air Interfaces and Operating Mode

Air interface	Bands (MHz)	Type	ANSI C63.19 Tested	Simultaneous Transmitter	Voice Service	Power Reduction
LTE (FDD)	Band2/4/5/12/13/66	VO	YES	WLAN, BT	VoLTE	NA
	Band2/4/5/12/13/66	VD	YES	WLAN, BT	Google duo	NA
WLAN	2.4GHz	VO	YES	WWAN	VoWiFi	NA
	5GHz(U-NII-1)			WWAN,BT		NA
	5GHz(U-NII-3)					NA
	2.4GHz	VD	YES	WWAN	Google duo	NA
	5GHz(U-NII-1)			WWAN,BT		NA
	5GHz(U-NII-3)					NA
BT	2.4G	DT	No	WWAN, WLAN	NA	NA

Abbreviation Type

VO=CMRS Voice Service

DT = Digital Transport

VD= IP Voice Service over Digital Transport



BT=Bluetooth (include BLE)

Note:

1). For Simultaneous transmission, WLAN and BT share the same antenna, so they can't work together at the same time.

Result summary

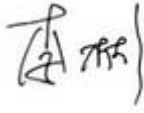
Band	Category assessment T-coil signal quality	Pass/Fail
LTE BAND2	T4	PASS
LTE BAND4	T4	PASS
LTE BAND5	T4	PASS
LTE BAND12	T4	PASS
LTE BAND13	T4	PASS
LTE BAND66	T4	PASS
WIFI 2.4GHz	T4	PASS
WIFI 5GHz UNII-1	T4	PASS
WIFI 5GHz UNII-3	T4	PASS
Final T Category	T4	PASS

This Test Report Is Issued by: Mr. Peng Zhen 	Checked by: Mr. Li Bin 
Tested by: Mr. Tong Daocheng 	Issued date: 20210127

5 Test Procedures for all Technologies

Referenced to ANSI C63.19, Section 7.4,

This section describes the describes the procedures used to measure the ABM (T-Coil) performance of the WD. In addition to measuring the absolute signal levels, the A-weighted magnitude of the unintended signal shall also be determined. In order to assure that the required signal quality is measured, the measurement of the intended signal and the measurement of the unintended signal must be made at the same location for all measurement positions. In addition, the RF field strength at each measurement location must be at or below that required for the assigned category.

Measurements shall not include undesired properties from the WD's RF field; therefore, use of a coaxial connection to a base station simulator or non-radiating load may be necessary. However, even then with a coaxial connection to a base station simulator or non-radiating load there may still be RF leakage from the WD, which may interfere with the desired measurement. Pre-measurement checks should be made to avoid this possibility. All measurements shall be done with the WD operating on battery power with an appropriate normal speech audio signal input level given in Table 7.1. If the device display can be turned off during a phone call then that may be done during the measurement as well.

Measurements shall be performed at two locations specified in A.3, with the correct probe orientation for a particular location, in a multistage sequence by first measuring the field intensity of the desired T-Coil signal (ABM1) that is useful to a hearing aid T-Coil. The undesired magnetic components (ABM2) must be measured at the same location as the desired ABM or T-Coil signal (ABM1), and the ratio of desired to undesired ABM signals must be calculated. For the perpendicular field location, only the ABM1 frequency response shall be determined in a third measurement stage. The flow chart in Figure 7.3 illustrates this three-stage, two orientation process.

The following steps summarize the basic test flow for determining ABM1 and ABM2. These steps assume that a sine wave or narrowband 1/3 octave signal can be used for the measurement of ABM1.

- a. A validation of the test setup and instrumentation may be performed using a TMFS or Helmholtz coil. Measure the emissions and confirm that they are within the specified tolerance.
- b. Position the WD in the test setup and connect the WD RF connector to a base station simulator or a non-radiating load as shown in Figure 7.1 or Figure 7.2. Confirm that equipment that requires calibration has been calibrated, and that the noise level meets the requirements given in 7.3.1.
- c. The drive level to the WD is set such that the reference input level specified in Table 7.1 is input to the base station simulator (or manufacturer's test mode equivalent) in the 1 kHz, 1/3 octave band. This drive level shall be used for the T-Coil signal test (ABM1) at $f = 1$ kHz. Either a sine wave at 1025 Hz or a voice-like signal, band-limited to the 1 kHz 1/3 octave, as defined in 7.4.2, shall be used for the reference audio signal. If interference is found at 1025 Hz an alternative nearby reference audio signal frequency may be used.⁴⁶ The same drive level will be used for the ABM1 frequency response

measurements at each 1/3 octave band center frequency. The WD volume control may be set at any level up to maximum, provided that a signal at any frequency at maximum modulation would not result in clipping or signal overload.

- d. Determine the magnetic measurement locations for the WD device (A.3), if not already specified by the manufacturer, as described in 7.4.4.1.1 and 7.4.4.2.
- e. At each measurement location, measure and record the desired T-Coil magnetic signals (ABM1 at f_i) as described in 7.4.4.2 in each individual ISO 266-1975 R10 standard 1/3 octave band. The desired audio band input frequency (f_i) shall be centered in each 1/3 octave band maintaining the same drive level as determined in item c) and the reading taken for that band.
- f. Equivalent methods of determining the frequency response may also be employed, such as fast Fourier transform (FFT) analysis using noise excitation or input-output comparison using simulated speech. The full-band integrated probe output, as specified in D.9, may be used, as long as the appropriate calibration curve is applied to the measured result, so as to yield an accurate measurement of the field magnitude. (The resulting measurement shall be an accurate measurement in dB A/m.)
- g. All Measurements of the desired signal shall be shown to be of the desired signal and not of an undesired signal. This may be shown by turning the desired signal ON and OFF with the probe measuring the same location. If the scanning method is used the scans shall show that all measurement points selected for the ABM1 measurement meet the ambient and test system noise criteria in ANSI C63.19 clause 7.3.1.
- h. At the measurement location for each orientation, measure and record the undesired broadband audio magnetic signal (ABM2) as specified in 7.4.4.4 with no audio signal applied (or digital zero applied, if appropriate) using A-weighting and the half-band integrator. Calculate the ratio of the desired to undesired signal strength (i.e., signal quality).
- i. Obtain the data from the postprocessor, SEMCAD, and determine the category that properly classifies the signal quality based on Table 8.5.

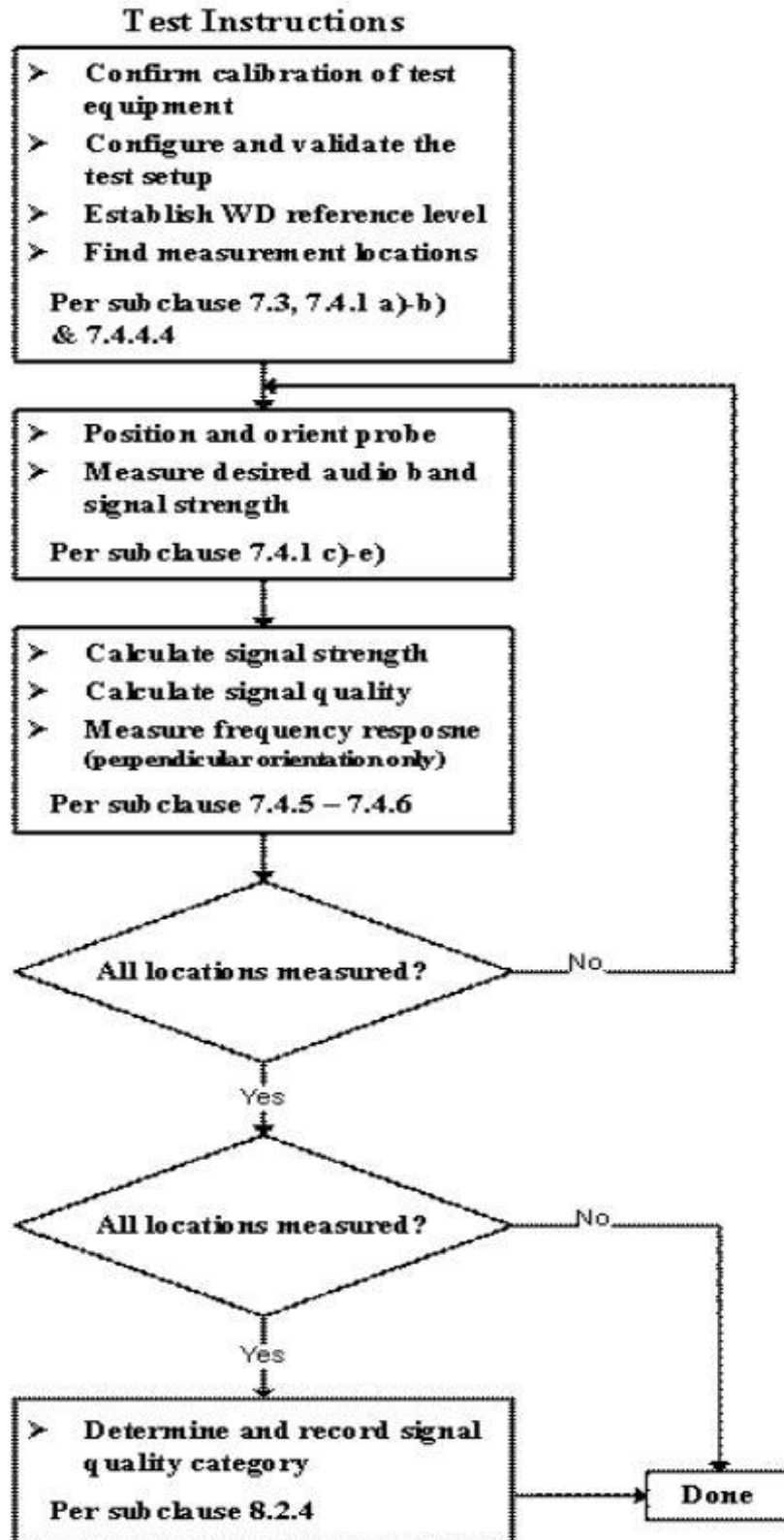

WD T-Coil signal test flowchart

Test Setup Diagram

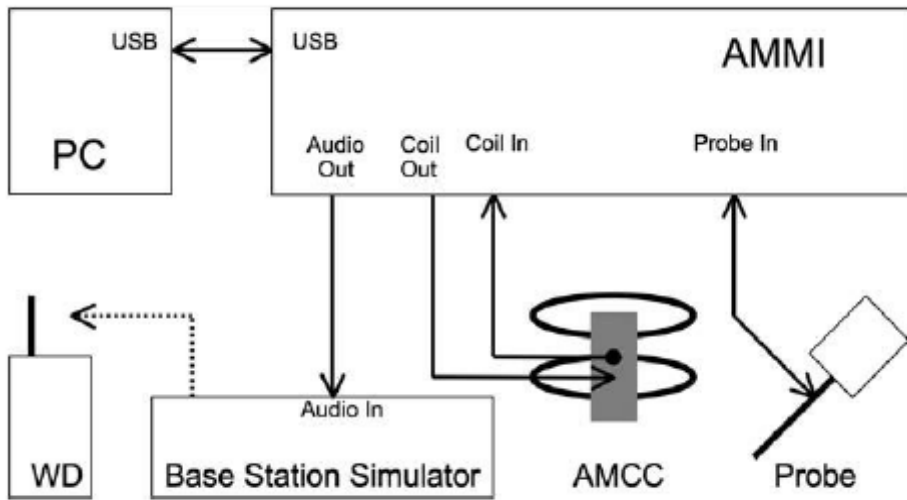

Test setup for VoLTE/VoWiFi CMRS service

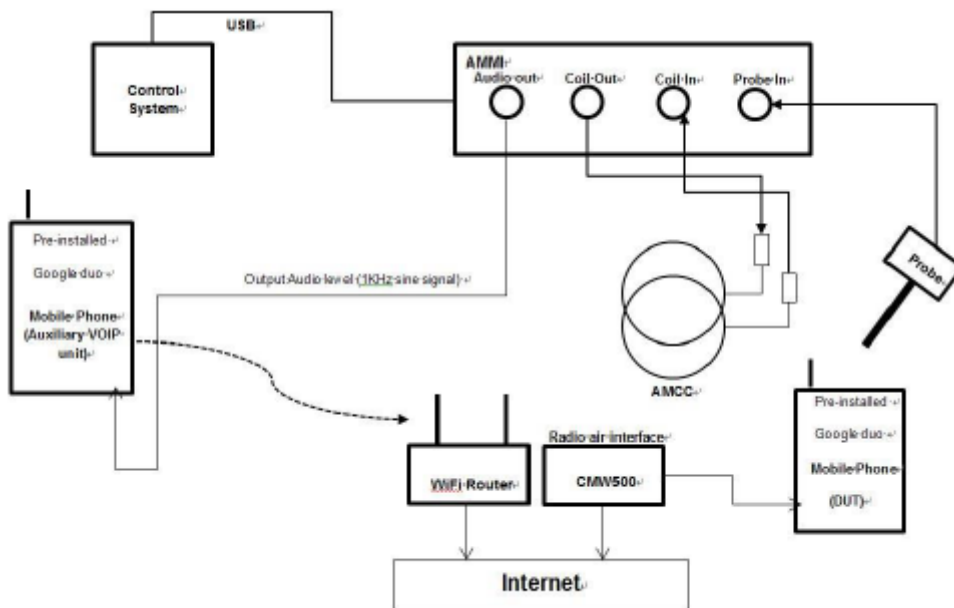

Test setup for OTT VoIP calling

For VoLTE and VoWiFi the test setup used is via the callbox of CMW500 for T-coil measurement, The DAU of the CMW500 was used to simulate the IMS(CDMA2000 do not need IMS registration). The CMW500 can be manually configured to ensure and control the speech input level result is -16dBm0 for VoLTE, -20dBm0 for VoWiFi when the device during the IMS connection.

The following options units on **CMW500** were used to simulate the VoLTE /VOWIFI /VOIP(IMS,EPDG,DNS inside DAU with Audio Board) for testing.

Firmware License Keys Software Name

CMW-PS505	Basic Assembly
CMW-S052S	SSD Driver
CMW-S100D	Baseband Measurement Unit
CMW-S550N	Flexible Internal Connection
CMW-S570B	RF Converter
CMW-S590D	Advanced Frontend
CMW-S600B	Front Panel with Display
CMW-PS505	Basic Assembly
CMW-S052S	SSD Driver

Hardware Options and Accessory:

CMW-B400B	Audio Board
CMW-B405A	CODEC Board
CMW-B500I	Signaling Unit for LTE and WLAN
CMW-B612A	GPIB Connector
CMW-B660H	Option Carrier
CMW-B661H	Ethernet Switch Board
CMW-B690B	OXCO
CMW-KB036	6 GHz Extension
CMW-Z06	Test USIM Card
CMW-B450H	Data Application Unit (DAU) for IMS Server and IP Emulation

Software Options:

CMW-K0	
CMW-KS104	Software License for EVS
CMW-PK45	Software License Package for IP Network Emulation
CMW-PK45	
CMW-PK45	
CMW-PK50	Software License Package for LTE
CMW-PK65	Software License Package for WLAN

6 Audio Level and Gain Measurements

According to C63 .19 and KDB 285076 , the input audio level showing below:

- VoLTE input level: -16dBm0

- VoWiFi input level: -20dBm0

- OTT VoIP input Level: -20dBm0

CMRS voice gain setting(VOLTE/WOWIFI)

The table of **Required gain** showing below is given by SPEAG, And we used these parameters to determine the **Gain setting** on the software DASY52 perform HAC T-coil test.

Signal [file name]	Duration [s]	Peak-to-RMS [dB]	RMS [dB]	Required gain factor *)	Gain setting
1kHz sine	---	3.0	0.0	1.00	
48k_1.025kHz_10s.wav	10	3.0	0.0	1.00	
48k_1kHz_3.15kHz_10s.wav	10	6.0	-3.0	1.42	
48k_315Hz_1kHz_10s.wav	10	6.0	-2.9	1.40	
48k_csek_8k_441_white_10s.wav	10	13.8	-10.5	3.34	
48k_multisine_50-5000_10s.wav	10	11.1	-7.9	2.49	
48k_multisine_50-10000_10s.wav	10	10.8	-7.7	2.42	
48k_voice_1kHz_1s.wav	1	16.2	-12.7	4.33	
48k_voice_300-3000_2s.wav	2	21.6	-18.6	8.48	
48k_normal (example)	51	25.4	-22.42	13.21	

(*) The gain for the specific signal shall typically be multiplied by this factor to achieve approx. the same level as for the 1kHz sine signal.

Note: For protocols not listed in Table 7.1 of ANSI C63.19 or the ANSI C63.19 VoLTE interpretation, the average speech level of -20 dBm0 should be used

For VoLTE/VoWIFI test, we use simulators with calibrated inputs CMW500 where the input sensitivity dBm0 per input voltage is known or can be set, the relation between the analog input voltage and the internal level in dBm0 can be determined.

The gain level determination to obtain a specific level in dBm0 with CMW500 describe as following procedure.

Step1: Define CMW500 analog input voltage on the CMW500.

The value of Speech_In Sensitivity is 1.8V_fullscale is equal to the reference input level of 3.14dBm0, Full scale input level converted to dBV_RMS is 2.10

Step2: Connect AMMI “Audio Out” to “AMMI Coil In” via BNC-XLR adapter.

Measure the AMMI 1KHz sine with gain 100(40dB) "Coil_In' signal reading is 3.37 dBV ,Impedence corrected "Coil_In' signal reading is 3.37 dBV -0.15dB= 3.22dBV corresponds to a level 4.26 dBm0

Step3: Calculate the required gain for a '1 kHz Sine'.

When the desire input level is -16dBm0 for LTE, the **required gain** is (-16dBm0) – (4.26dBm0) + 40 dB=19.74 dB (gain dB)= 9.70 (gain linear)

When the desire input level is -20dBm0 for WIFI, the **required gain** is (-20dBm0) – (4.26dBm0) + 40 dB=15.74 dB (gain dB)= 6.12 (gain linear)

Step4: Gain setting for several audio files (required gain* gain factor).

Mode	Signal Type	Duration (s)	Peak to RMS (dB)	Peak to RMS (dB)	Required Gain Factor	Calculated Gain Setting
LTE (-16dBm0)	48k_voice_1kHz	1	16.2	-12.7	4.33	42.00
	48k_voice_300 Hz ~ 3kHz	2	21.6	-18.6	8.48	82.26
WIFI (-20dBm0)	48k_voice_1kHz	1	16.2	-12.7	4.33	26.50
	48k_voice_300 Hz ~ 3kHz	2	21.6	-18.6	8.48	51.90

VOIP gain setting(LTE/WIFI OTT mode)

Audio Level Settings

According to KDB 285076 D02, the average speech level of -20dBm0 shall be used for protocols not specifically listed in Table 7.1 of ANSI C63.19-2011.

Determine Input Audio level is based on the Added additional dBFS level readout by Google Duo customize application and five steps need to do.

1. According to the test setup for OTT VoIP calling to build link environment. Adjust the gain value through DASY5 software until the full scale digital level is monitored on the auxiliary phone. The auxiliary phone's full scale digital level is 0dBFS.

2.However, digital saturation is generally not 0 dBm0.OPUS is kind of A-law codec, For A-law codec, 0 dBm0 is 3.14 dB below digital full scale(0dBFS). Determining audio input level of auxiliary phone reach to -20dBm0, digital audio signal level is around -23.14dBFS.

3.Input a gain value on DASY,and to readout the -23dBFS on GoogleDuo of the Auxiliary phone.

4. Adjust gain level to readout the dBFS level until it changes to -24dBFS.

5. Based on the step 3 and 4, and then calculate the gain value(dB) by interpolation to get the - 20dBm0 corresponding gain value.

Mode	Signal Type	Calculated Gain Setting
OTT(LTE/WALN) (-20dBm0)	48k_voice_1kHz	19.75
	48k_voice_300Hz ~ 3kHz	38.48

7 Description of the test Position

7.1 Test positions

The device was positioned such that Device Reference plane was touching the bottom of the Test Arch. The scan is centered at the acoustic output by aligning the acoustic output with the intersection of the Test Arch's middle bar and dielectric wire. The WD is positioned always this way to ensure repeatability of the measurements. Coordinate system depicted below is used to define exact locations of measurement points relative to the center of the acoustic output.

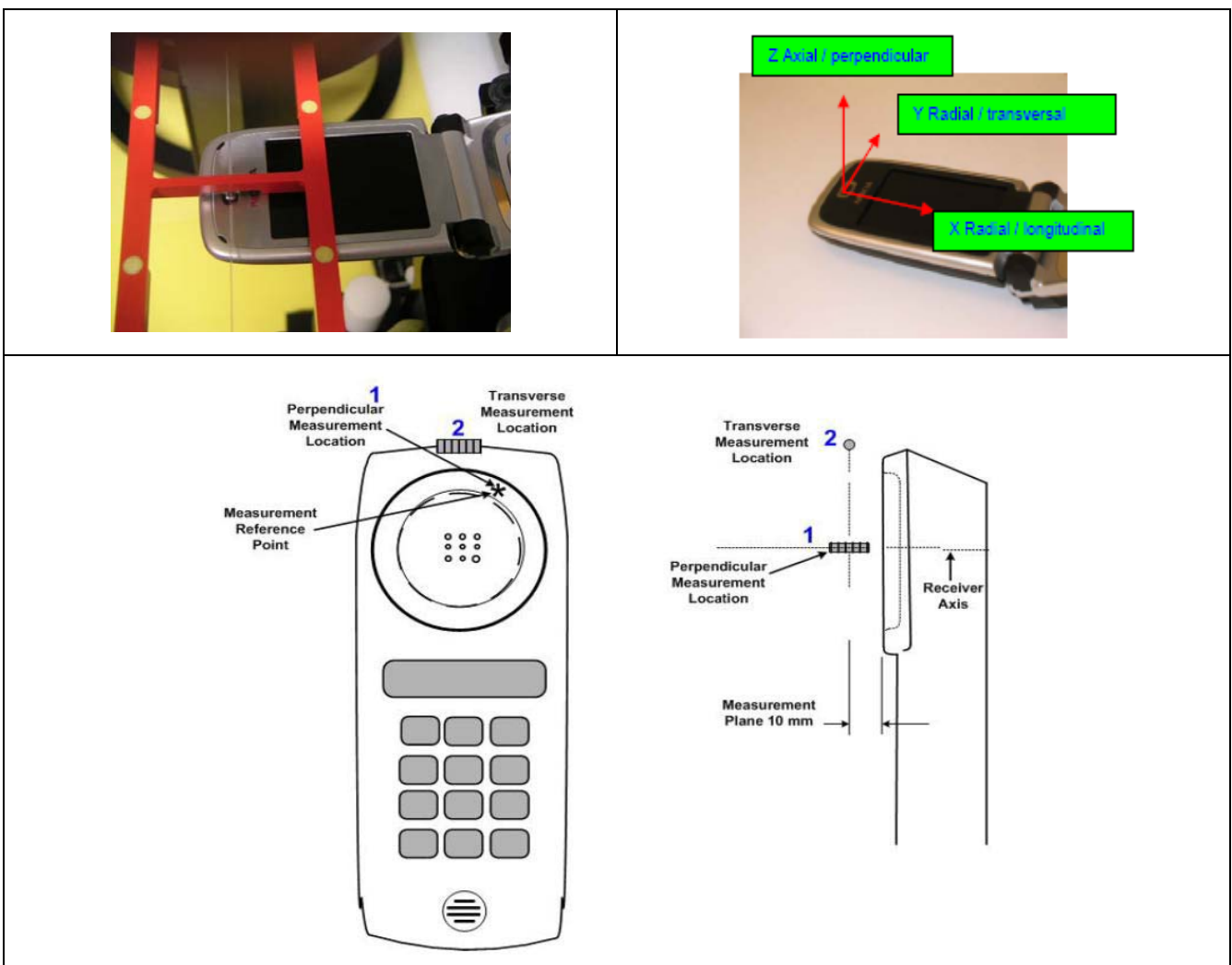

Photo of the device positioned under Test Arch and coordinate system (The EUT in picture is generic phone sample and does not represent the actual equipment under test)

7.2 T-coil Requirements and Category Limits

Signal to Noise :This section provides the signal quality requirement for the intended T-Coil signal from a WD. Only the RF immunity of the hearing aid is measured in T-Coil mode. It is assumed that a hearing aid can have no immunity to an interference signal in the audio band, which is the intended reception band for this mode. So, the only criterion that can be measured is the RF immunity in T-Coil Mode. The RF measurements made for the T-Coil evaluation are used to assign the category T1 through T4.

Category	Telephone parameters WD signal quality [(signal + noise)-to-noise ratio in decibels]
Category T1	0 dB to 10 dB
Category T2	10 dB to 20 dB
Category T3	20 dB to 30 dB
Category T4	> 30 dB

Frequency Response

The frequency response of the perpendicular component of the magnetic field, measured in 1/3 octave bands, shall follow the response curve specified in this sub-clause, over the frequency range 300 Hz to 3000 Hz.

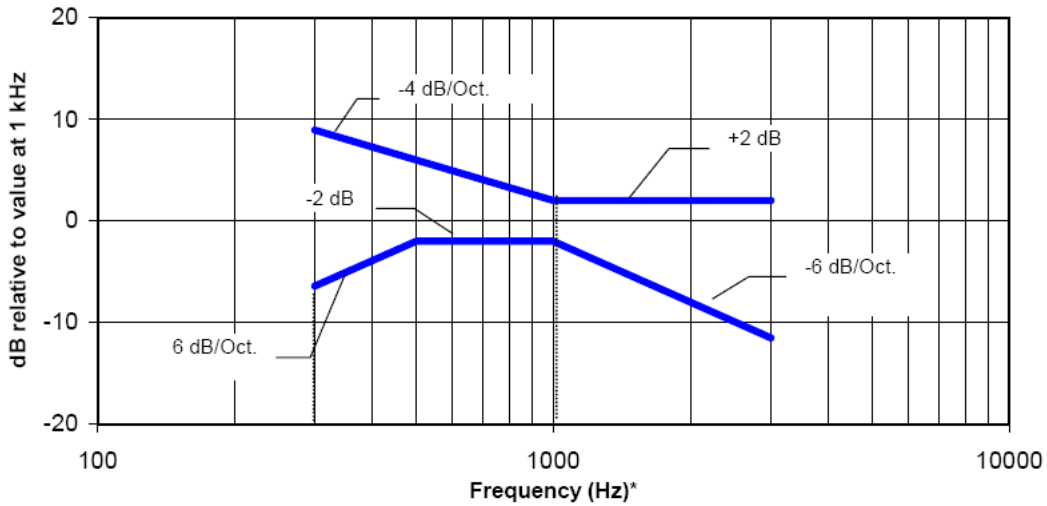

NOTE—Frequency response is between 300 Hz and 3000 Hz.

Magnetic field frequency response for WDs with a field ≤ -15 dB(A/m) at 1 kHz

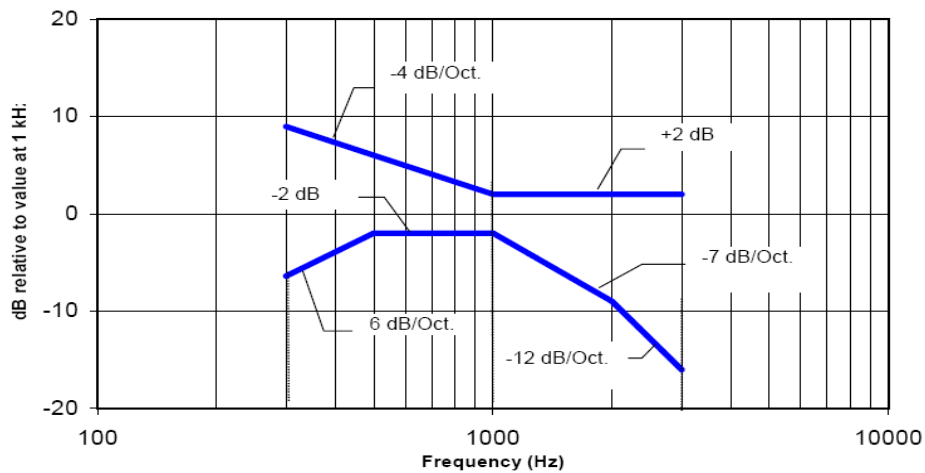

NOTE—Frequency response is between 300 Hz and 3000 Hz.

Magnetic field frequency response for WDs with a field that exceeds -15 dB(A/m) at 1 kHz

8 Measurement uncertainty

Uncertainty of Audio Band Magnetic Measurements							
Error Description	Unc. Value	Prob. Dist.	Div.	(c_1) ABM1	(c_2) ABM2	Std. Unc. ABM1	Std. Unc. ABM2
Probe Sensitivity							
Reference Level	±3.0 %	N	1	1	1	±3.0 %	±3.0 %
AMCC Geometry	±0.4 %	R	$\sqrt{3}$	1	1	±0.2 %	±0.2 %
AMCC Current	±1.0 %	R	$\sqrt{3}$	1	1	±0.6 %	±0.6 %
Probe Positioning during Calibr.	±0.1 %	R	$\sqrt{3}$	1	1	±0.1 %	±0.1 %
Noise Contribution	±0.7 %	R	$\sqrt{3}$	0.0143	1	±0.0 %	±0.4 %
Frequency Slope	±5.9 %	R	$\sqrt{3}$	0.1	1.0	±0.3 %	±3.5 %
Probe System							
Repeatability / Drift	±1.0 %	R	$\sqrt{3}$	1	1	±0.6 %	±0.6 %
Linearity / Dynamic Range	±0.6 %	R	$\sqrt{3}$	1	1	±0.4 %	±0.4 %
Acoustic Noise	±1.0 %	R	$\sqrt{3}$	0.1	1	±0.1 %	±0.6 %
Probe Angle	±2.3 %	R	$\sqrt{3}$	1	1	±1.4 %	±1.4 %
Spectral Processing	±0.9 %	R	$\sqrt{3}$	1	1	±0.5 %	±0.5 %
Integration Time	±0.6 %	N	1	1	5	±0.6 %	±3.0 %
Field Disturbation	±0.2 %	R	$\sqrt{3}$	1	1	±0.1 %	±0.1 %
Test Signal							
Ref. Signal Spectral Response	±0.6 %	R	$\sqrt{3}$	0	1	±0.0 %	±0.4 %
Positioning							
Probe Positioning	±1.9 %	R	$\sqrt{3}$	1	1	±1.1 %	±1.1 %
Phantom Thickness	±0.9 %	R	$\sqrt{3}$	1	1	±0.5 %	±0.5 %
DUT Positioning	±1.9 %	R	$\sqrt{3}$	1	1	±1.1 %	±1.1 %
External Contributions							
RF Interference	±0.0 %	R	$\sqrt{3}$	1	0.3	±0.0 %	±0.0 %
Test Signal Variation	±2.0 %	R	$\sqrt{3}$	1	1	±1.2 %	±1.2 %
Combined Uncertainty							
Combined Std. Uncertainty (ABM Field)						±4.1 %	±6.1 %
Expanded Std. Uncertainty						±8.1 %	±12.3 %

9 T-Coil Testing for Standard Phone Application

General illustration:

1. The middle channel of each frequency band is used for T-Coil testing according ANSI C63.19.
2. For VoLTE or VoWiFi ,Codec investigation is choose either one radio configuration and an investigation was performed, the following tests use worst codec for the handset.
3. For VoLTE or VoWiFi, Radio configuration investigation is choose worst codec from codec investigation to determine the worst radio configuration on all frequency band, data rates and modulations and RB configuration,
4. All the data showing on the section “Tests Results” used the worst features (codec and radio configuration) determined by codec investigation (illustration2) and Radio configuration investigation (illustration3).
5. According to 3GPP 36.211 Table 4.2-2, TDD-LTE supports uplink-downlink configuration from 0 to 6, an additional parameter investigation was performed to determine the worst-case uplink-downlink and with the FDD-LTE worst case radio configuration.
6. Phone Condition: Mute on; Backlight off; Max Volume

9.1 VOLTE Test Result

Codec Investigation

Codec Investigation

codec	AMR -NB 4.75 Kbps	AMR -NB 12.2 Kbps	AMR -WB 6.6 Kbps	AMR -WB 23.85 Kbps	EVS -NB 5.9 Kbps	EVS -NB 13.2 Kbps	EVS -WB 5.9 Kbps	EVS -WB 13.2 Kbps	Worst Orientati on	Band/ BW/ channel/ Modulati on
ABM1 [dB A/m]	-5.59	-5.35	-5.27	-5.73	-5.32	-5.84	-5.77	-5.81	Axial(Z)	LTE BAND2 / 20MHz/ CH1890 0/QPSK
ABM2 [dB A/m]	-48.23	-48.16	-48.38	-49.05	-48.25	-49.17	-49.22	-49.66		
SNR [dB]	42.64	42.81	43.11	43.32	42.93	43.33	43.45	43.85		

Radio Configuration Investigation

For the radio configuration investigation (FDD-LTE), we use codec **AMR -NB4.75Kbps** determined by Codec Investigation which represents the worst codec future.

Air interface	BW	Modulation	RB Size/offset	Channel	Power Class	ABM1 with Worst Orientation [dB A/m]	ABM2 with Worst Orientation [dB A/m]	Signal Quality dB
FDD-LTE BAND2	1.4	QPSK	1/0	18900	3	-5.67	-50.43	44.76
	3	QPSK	1/0	18900	3	-5.40	-49.93	44.53
	5	QPSK	1/0	18900	3	-5.45	-49.67	44.22
	10	QPSK	1/0	18900	3	-5.73	-49.86	44.13
	15	QPSK	1/0	18900	3	-5.37	-49.26	43.89
	20	QPSK	1/0	18900	3	-5.59	-48.23	42.64
	20	16QAM	1/0	18900	3	-5.85	-50.02	44.17
	20	64QAM	1/0	18900	3	-5.37	-49.97	44.60
	20	QPSK	50/0	18900	3	-5.32	-48.43	43.11
	20	QPSK	100/0	18900	3	-5.75	-49.29	43.54

FDD:

Step1: SRTC evaluate the worst bandwidth.

Step2: then evaluate the worst modulation type based on step1.

Step3: and finally evaluate the RB allocation based on previous steps.

Summary Tests Results

Refers to previous investigation, we use the worst codec **AMR –NB 4.75Kbps** and the worst configuration showing below perform all the test for each LTE bands.

Configuration for FDD-LTE:

MAX Bandwidth, QPSK,1RB@0

Air interface	Channel	Orientation	ABM1 dB(A/m)	ABM2 dB(A/m)	Signal Quality dB	T-Rating ANSI C63.19	Freq. Response
FDD-LTE BAND2	18900	Radial (Y)	-5.59	-48.23	42.64	T4	---
		Axial (Z)	-1.60	-47.34	45.74	T4	Pass
FDD-LTE BAND4	20175	Radial (Y)	-8.05	-49.68	41.63	T4	---
		Axial (Z)	-2.81	-44.86	42.05	T4	Pass
FDD-LTE BAND5	20525	Radial (Y)	-8.06	-51.15	43.09	T4	---
		Axial (Z)	-1.29	-46.37	45.08	T4	Pass
FDD-LTE BAND12	23095	Radial (Y)	-8.04	-50.98	42.94	T4	---
		Axial (Z)	-1.32	-47.06	45.74	T4	Pass
FDD-LTE BAND13	23230	Radial (Y)	-7.85	-49.80	41.95	T4	---
		Axial (Z)	-0.54	-46.37	45.83	T4	Pass
FDD-LTE BAND66	132322	Radial (Y)	-5.57	-46.87	41.30	T4	---
		Axial (Z)	-2.73	-48.47	45.74	T4	Pass

9.2 VOWIFI Test Result

Codec Investigation

AMR Codec Investigation

codec	AMR -NB 4.75Kbps	AMR -NB 12.2Kbps	AMR-WB 6.6Kbps	AMR -WB 23.85Kbps	Worst Orientation	Band/channel/Rate
ABM1 [dB A/m]	-4.78	-3.66	-4.03	-3.89	Axial(Y)	802.11b 2.4GHz/6/1Mbps
ABM2 [dB A/m]	-52.96	-52.64	-52.05	-53.22		
SNR [dB]	48.18	48.98	48.02	49.33		

Radio Configuration Investigation

For WIFI radio configuration investigation, we use codec **AMR-WB6.6 Kbps** determined by Codec Investigation which represents the worst codec future.

Air interface		BW	Data rate	Channel	ABM1 [dB A/m] Axial(Y)	ABM2[dB A/m] Axial(Y)	Signal Quality dB
WLAN 2.4GHz	802.11b	20	1M	6	-4.03	-52.05	48.02
	802.11b	20	11M	6	-3.67	-52.45	48.78
	802.11g	20	6M	6	-3.98	-53.22	49.24
	802.11g	20	54M	6	-3.73	-53.14	49.41
	802.11n-HT20	20	MCS0	6	-2.79	-52.68	49.89
	802.11n-HT20	20	MCS7	6	-2.63	-52.59	49.96
WLAN 5GHz	802.11a	20	6M	40	-8.95	-47.87	38.92
	802.11a	20	54M	40	-7.42	-47.19	39.77
	802.11n-HT20	20	MCS0	40	-7.34	-47.21	39.87
	802.11n-HT20	20	MCS7	40	-6.89	-46.99	40.10
	802.11n-HT40	40	MCS0	38	-7.07	-46.37	39.30
	802.11n-HT40	40	MCS7	38	-7.88	-47.59	39.71
	802.11ac-VHT20	20	MCS0	40	-7.22	-47.25	40.03
	802.11ac-HVT20	20	MCS8	40	-7.21	-47.42	40.21
	802.11ac-VHT40	40	MCS0	38	-7.02	-47.13	40.11
	802.11ac-VHT40	40	MCS9	38	-7.32	-47.99	40.67
	802.11ac-VHT80	80	MCS0	42	-7.34	-48.65	41.31
	802.11ac-VHT80	80	MCS9	42	-7.11	-48.54	41.43

Summary Tests Results

We use codec **AMR-WB 6.6 Kbps** and the worst configuration describe as below perform the test for each WIFI bands.

Configuration for WIFI 2.4GHz use **802.11b 1Mbps**

Configuration for WIFI 5GHz use **802.11a 6Mbps**

Air interface	Mode	Channel	Orientation	ABM1 dB(A/m)	ABM2 dB(A/m)	Signal Quality dB	T-Rating ANSI C63.19	Freq. Response
WIFI2.4GHz	802.11b 1Mbps	6	Radial(Y)	-4.03	-52.05	48.02	T4	---
			Axial (Z)	-0.59	-53.78	53.19	T4	Pass
WIFI5GHz U-NII-1	802.11a 6Mbps	40	Radial(Y)	-8.95	-47.87	38.92	T4	---
			Axial (Z)	-0.93	-47.22	46.29	T4	Pass
WIFI5GHz U-NII-3	802.11a 6Mbps	157	Radial(Y)	-11.31	-51.08	39.77	T4	---
			Axial (Z)	-1.50	-48.27	46.77	T4	Pass

10 T-Coil testing for OTT Application

General illustration:

1.The Google DuoVoIP call software is pre-installed on this device and head-to-ear scenario should be consideration. According to KDB 285076 D02, all air interfaces via a data connection with Google DuoVoIP calling would be consideration to be tested.

2. The test setup used for OTT VoIP call is via the data application unit on CMW500 connection to the Internet, also connection to the other auxiliary VoIP(Smart Phone FCC ID:R38YLCP3669AS) unit which is used to configure the audio codec and bit rate and also monitor the audio input level of -20dBm0.

3. The codec used by special "Google duo" is (OPUS codec), and the bit rates could be changed from 6kbps up to 75kbps, so SRTC perform codec investigation for different bit rates (6kbps, 32kbps, 76kbps) as well as wireless interface investigation mentioned in test report.All air interfaces capable of a data connection were evaluated with Google Duo. When HAC testing we are using the Google Duo version is 26.0.179825522.alpha.DEV and the bit rate configuration can find at settings → Voice call parameters settings → Audio codec bit rate(6-75kbps).

4.The information of router is as follows:

Name:TD-LTE wireless data terminal

Model:B311As-853

S/N:UNL7S18403002257

Manufacturer :Huawei Technology Co., Ltd

5. Through RF air interface, OTT service initialized VoIP through equipment (Smart Phone FCC ID:R38YLCP3669AS), starting from CMW500 call connection, then use IP network emulator and SIP SOFTWARE to switch to OTT google duo mode. Due to OTT service and CMRS voice service are all be established over the internet protocol for the voice service, and on both services use the identical RF air interface for the WIFI and LTE, therefore according to VoLTE and VoWiFi radio configuration air interface investigation, choose the worst-case radio configuration LTE, WIFI air interface for OTT service.

-LTE FDD worst configuration and band: LTE Band 66/20MHz/QPSK/1RB Size

-WLAN2.4GHz worst configuration: 802.11b /1Mbps

-WLAN5GHz worst configuration and Band: WLAN 5.2GHz /11a/6Mbps

Codec Investigation

LTE FDD

codec	OPUS 6Kbps	OPUS 32Kbps	OPUS 75Kbps	Worst Orientation	Band/channel
ABM1 [dB A/m]	-6.28	-5.43	-5.18	Axial(Y)	LTE Band2/CH18900
ABM2 [dB A/m]	-49.28	-49.54	-49.61		
SNR [dB]	43.00	44.11	44.43		

Remark: According to codec investigation, the worst codec bitrate is OPUS 6Kbit/s

WLAN

codec	OPUS 6Kbps	OPUS 32Kbps	OPUS 75Kbps	Worst Orientation	Band/channel
ABM1 [dB A/m]	-11.83	-10.87	-10.38	Axial(Y)	WLAN 2.4G/CH6
ABM2 [dB A/m]	-53.78	-53.06	-53.27		
SNR [dB]	41.95	42.78	42.89		

Remark: According to codec investigation, the worst codec bitrate is OPUS 6Kbit/s

Summary Tests Results

Air interface	Mode	Channel	Orientation	ABM1 dB(A/m)	ABM2 dB(A/m)	Signal Quality dB	T-Rating ANSI C63.19	Freq. Response
FDD-LTE BAND6	QPSK	132322	Radial (Y)	-6.87	-49.80	42.93	T4	---
			Axial (Z)	4.01	-47.00	51.01	T4	Pass
WIFI2.4GHz	802.11b 1Mbps	6	Radial(Y)	-11.83	-53.78	41.95	T4	---
			Axial (Z)	4.80	-47.92	52.72	T4	Pass
WIFI5GHz U-NII-1	802.11a 1Mbps	40	Radial(Y)	-1.78	-41.98	40.20	T4	---
			Axial (Z)	3.09	-47.44	50.53	T4	Pass

11 Test Equipments

The measurements were performed using an automated near-field scanning system, DASY5, manufactured by Schmid & Partner Engineering AG (SPEAG) in Switzerland.

The following table lists calibration dates of components:

Test equipment	Model	S/N	Cal Date	Cal Due Date
DAE	DAE4	720	2020.09.30	2021.09.29
Audio Magnetic Probe	AM1DV2	1021	2020.10.22	2021.10.21
Audio Magnetic Measurement Instrument	TMFS	1013	2020.10.27	2021.10.26
Radio Tester	CMW500	161702	2020.08.20	2021.08.19

Support equipment	S/N
AMMI	1045
HAC Phantom part1	1080
HAC Phantom part2	1042

11.1 Audio Magnetic Probe AM1DV2

Construction	Fully RF shielded metal construction (RF sensitivity<-100 dB)
System Calibration	Calibrated using Helmholtz coil according to manufacturers instructions
Frequency	0.1-20kHz(HOX!test signal is limited to required BW of 300 to 3000Hz,ANSI C63.19);
Sensitivity	<-50dB A/m
Dimensions	Overall length:290mm; Tip diameter:6mm

11.2 Audio Magnetic Measurement Instrument AMMI

Sampling rate	48kHz/24bit
Dynamic Range	85dB
Test Signal generation	User selectable and predefined(via pc)
System calibration	Auto-calibration/full system calibration using AMCC with monitor output

11.3 Audio Magnetic calibration Coil AMCC

Dimensions	370 x 370 x 196 mm (ANSI-C63.19 compliant)
------------	--

ANNEX A: TEST PLOTS

A.1 Test Plot for Standard Phone Application

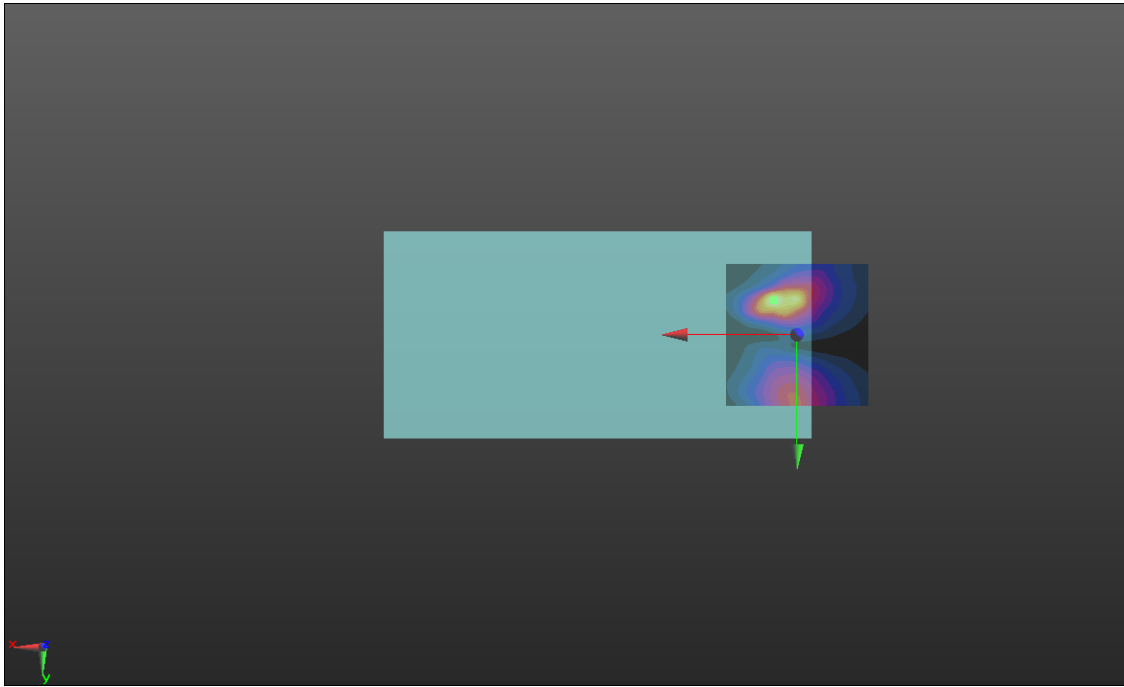
LTE BAND2	Axial Y										
<p>Communication System: UID 10169 - CAE, LTE-FDD (SC-FDMA, 1 RB, 20 MHz, QPSK); Frequency: 1880 MHz; Medium parameters used: $\sigma = 0$ S/m, $\epsilon_r = 1$; $\rho = 0$ kg/m³ Phantom section: TCoil Section</p> <p>DASY5 Configuration:</p> <ul style="list-style-type: none"> • Probe: AM1DV2 - 1021; ; Calibrated: 10/22/2020 • Sensor-Surface: 0mm (Fix Surface) • Electronics: DAE4 Sn720; Calibrated: 9/30/2020 • Phantom: HAC Test Arch with AMCC; Type: SD HAC P01 BA; • Measurement SW: DASY52, Version 52.10 (4); SEMCAD X Version 14.6.14 (7483) <p>T-Coil scan (scan for ANSI C63.19-2011 compliance)/General Scans_LTE 2_T-Coil_HAC AMR NB/y (transversal) 4.2mm 50 x 50/ABM Interpolated SNR(x,y,z) (121x121x1): Interpolated grid: dx=1.000 mm, dy=1.000 mm Signal Type: Audio File (.wav) 48k_voice_1kHz_1s.wav Output Gain: 42 Measure Window Start: 300ms Measure Window Length: 1000ms BWC applied: 0.14 dB Device Reference Point: 0, 0, -6.3 mm</p> <table border="1" style="margin-left: auto; margin-right: auto; border-collapse: collapse;"> <thead> <tr> <th style="text-align: left;">Category</th> <th style="text-align: center;">Telephone parameters WD signal quality [(signal+noise)-to-noise ratio in decibels]</th> </tr> </thead> <tbody> <tr> <td>Category T1</td> <td style="text-align: center;">0 dB to 10 dB</td> </tr> <tr> <td>Category T2</td> <td style="text-align: center;">10 dB to 20 dB</td> </tr> <tr> <td>Category T3</td> <td style="text-align: center;">20 dB to 30 dB</td> </tr> <tr> <td>Category T4</td> <td style="text-align: center;">> 30 dB</td> </tr> </tbody> </table> <p>Cursor: ABM1/ABM2 = 42.64 dB ABM1 comp = -5.59 dBA/m BWC Factor = 0.14 dB Location: 7.9, -12.1, 3.7 mm</p> <div style="text-align: center; margin-top: 20px;">  </div>		Category	Telephone parameters WD signal quality [(signal+noise)-to-noise ratio in decibels]	Category T1	0 dB to 10 dB	Category T2	10 dB to 20 dB	Category T3	20 dB to 30 dB	Category T4	> 30 dB
Category	Telephone parameters WD signal quality [(signal+noise)-to-noise ratio in decibels]										
Category T1	0 dB to 10 dB										
Category T2	10 dB to 20 dB										
Category T3	20 dB to 30 dB										
Category T4	> 30 dB										

LTE BAND2	Axial Z & Frequency Resp.
<p>Communication System: UID 10169 - CAE, LTE-FDD (SC-FDMA, 1 RB, 20 MHz, QPSK); Frequency: 1880 MHz; Medium parameters used: $\sigma = 0$ S/m, $\epsilon_r = 1$; $\rho = 0$ kg/m³ Phantom section: TCoil Section</p>	
<p>DASY5 Configuration:</p> <ul style="list-style-type: none"> • Probe: AM1DV2 - 1021; ; Calibrated: 10/22/2020 • Sensor-Surface: 0mm (Fix Surface) • Electronics: DAE4 Sn720; Calibrated: 9/30/2020 • Phantom: HAC Test Arch with AMCC; Type: SD HAC P01 BA; • Measurement SW: DASY52, Version 52.10 (4); SEMCAD X Version 14.6.14 (7483) 	
<p>T-Coil scan (scan for ANSI C63.19-2011 compliance)/General Scans_LTE 2_T-Coil_HAC AMR NB/z (axial) 4.2mm 50 x 50/ABM Interpolated SNR(x,y,z) (121x121x1): Interpolated grid: dx=1.000 mm, dy=1.000 mm Signal Type: Audio File (.wav) 48k_voice_1kHz_1s.wav Output Gain: 42 Measure Window Start: 300ms Measure Window Length: 1000ms BWC applied: 0.14 dB Device Reference Point: 0, 0, -6.3 mm Cursor: ABM1/ABM2 = 45.74 dB ABM1 comp = -1.60 dBA/m BWC Factor = 0.14 dB Location: 4.6, 0.4, 3.7 mm</p>	
<p>T-Coil scan (scan for ANSI C63.19-2011 compliance)/General Scans_LTE 2_T-Coil_HAC AMR NB/z (axial) wideband at best S/N/ABM Freq Resp(x,y,z,f) (1x1x1): Measurement grid: dx=10mm, dy=10mm Signal Type: Audio File (.wav) 48k_voice_300-3000_2s.wav Output Gain: 82.26 Measure Window Start: 300ms Measure Window Length: 2000ms BWC applied: 10.78 dB Device Reference Point: 0, 0, -6.3 mm Cursor: Diff = 1.67 dB BWC Factor = 10.78 dB Location: 4.5, 0.5, 3.7 mm</p>	

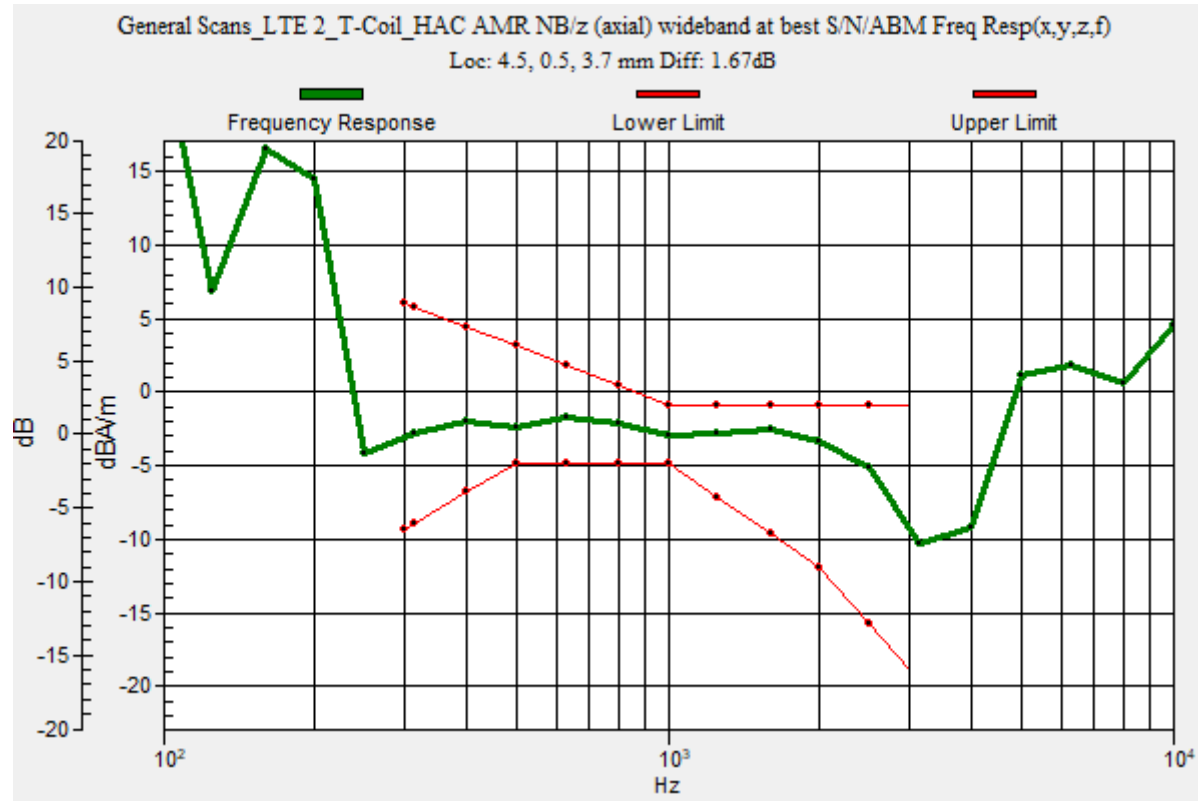

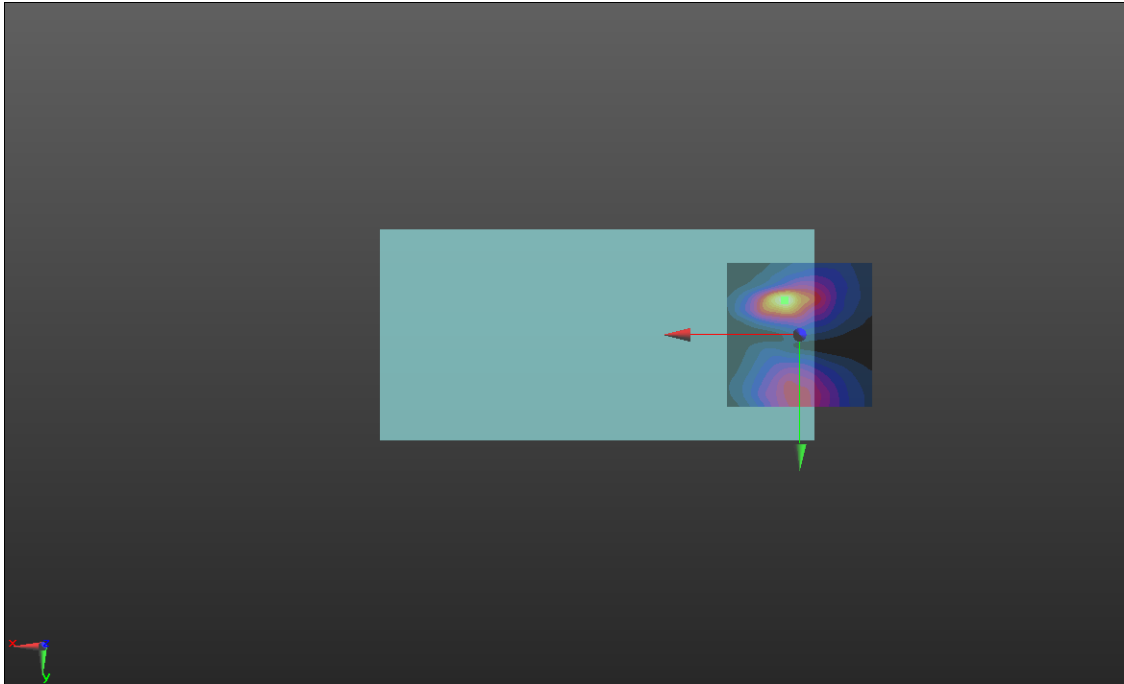
LTE BAND4	Axial Y
<p>Communication System: UID 10175 - CAG, LTE-FDD (SC-FDMA, 1 RB, 10 MHz, QPSK); Frequency: 1732.5 MHz; Medium parameters used: $\sigma = 0$ S/m, $\epsilon_r = 1$; $\rho = 0$ kg/m³ Phantom section: TCoil Section</p> <p>DASY5 Configuration:</p> <ul style="list-style-type: none"> Probe: AM1DV2 - 1021; ; Calibrated: 10/22/2020 Sensor-Surface: 0mm (Fix Surface) Electronics: DAE4 Sn720; Calibrated: 9/30/2020 Phantom: HAC Test Arch with AMCC; Type: SD HAC P01 BA; Measurement SW: DASY52, Version 52.10 (4); SEMCAD X Version 14.6.14 (7483) <p>T-Coil scan (scan for ANSI C63.19-2011 compliance)/General Scans_LTE 4_T-Coil_HAC AMR NB/y (transversal) 4.2mm 50 x 50/ABM Interpolated SNR(x,y,z) (121x121x1): Interpolated grid: dx=1.000 mm, dy=1.000 mm Signal Type: Audio File (.wav) 48k_voice_1kHz_1s.wav Output Gain: 42 Measure Window Start: 300ms Measure Window Length: 1000ms BWC applied: 0.14 dB Device Reference Point: 0, 0, -6.3 mm</p> <p>Cursor: ABM1/ABM2 = 41.63 dB ABM1 comp = -8.05 dBA/m BWC Factor = 0.14 dB Location: 5, -12.1, 3.7 mm</p>	
	

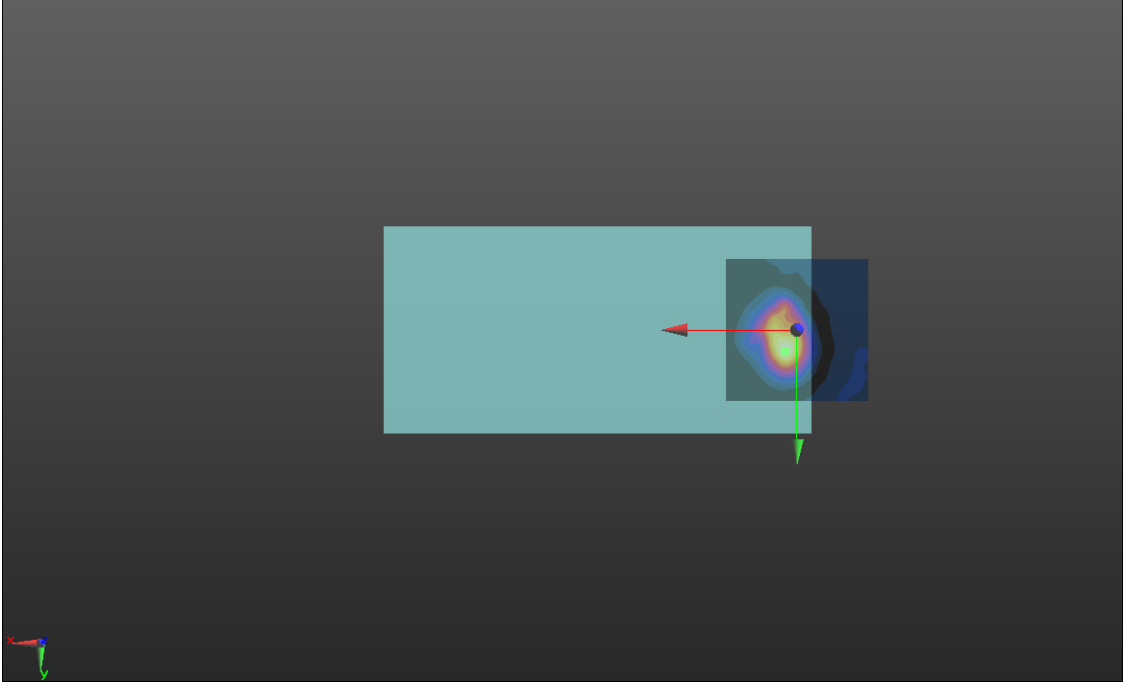
LTE BAND4	Axial Z & Frequency Resp.
<p>Communication System: UID 10175 - CAG, LTE-FDD (SC-FDMA, 1 RB, 10 MHz, QPSK); Frequency: 1732.5 MHz; Medium parameters used: $\sigma = 0$ S/m, $\epsilon_r = 1$; $\rho = 0$ kg/m³ Phantom section: TCoil Section</p>	
<p>DASY5 Configuration:</p> <ul style="list-style-type: none"> • Probe: AM1DV2 - 1021; ; Calibrated: 10/22/2020 • Sensor-Surface: 0mm (Fix Surface) • Electronics: DAE4 Sn720; Calibrated: 9/30/2020 • Phantom: HAC Test Arch with AMCC; Type: SD HAC P01 BA; • Measurement SW: DASY52, Version 52.10 (4); SEMCAD X Version 14.6.14 (7483) 	
<p>T-Coil scan (scan for ANSI C63.19-2011 compliance)/General Scans_LTE 4_T-Coil_HAC AMR NB/z (axial) 4.2mm 50 x 50/ABM Interpolated SNR(x,y,z) (121x121x1): Interpolated grid: dx=1.000 mm, dy=1.000 mm Signal Type: Audio File (.wav) 48k_voice_1kHz_1s.wav Output Gain: 42 Measure Window Start: 300ms Measure Window Length: 1000ms BWC applied: 0.14 dB Device Reference Point: 0, 0, -6.3 mm</p>	
<p>Cursor: ABM1/ABM2 = 42.05 dB ABM1 comp = -2.81 dBA/m BWC Factor = 0.14 dB Location: 4.2, 7.5, 3.7 mm</p>	
<p>T-Coil scan (scan for ANSI C63.19-2011 compliance)/General Scans_LTE 4_T-Coil_HAC AMR NB/z (axial) wideband at best S/N/ABM Freq Resp(x,y,z,f) (1x1x1): Measurement grid: dx=10mm, dy=10mm Signal Type: Audio File (.wav) 48k_voice_300-3000_2s.wav Output Gain: 82.26 Measure Window Start: 300ms Measure Window Length: 2000ms BWC applied: 10.78 dB Device Reference Point: 0, 0, -6.3 mm</p>	
<p>Cursor: Diff = 1.14 dB BWC Factor = 10.78 dB Location: 4, 7.4, 3.7 mm</p>	
	

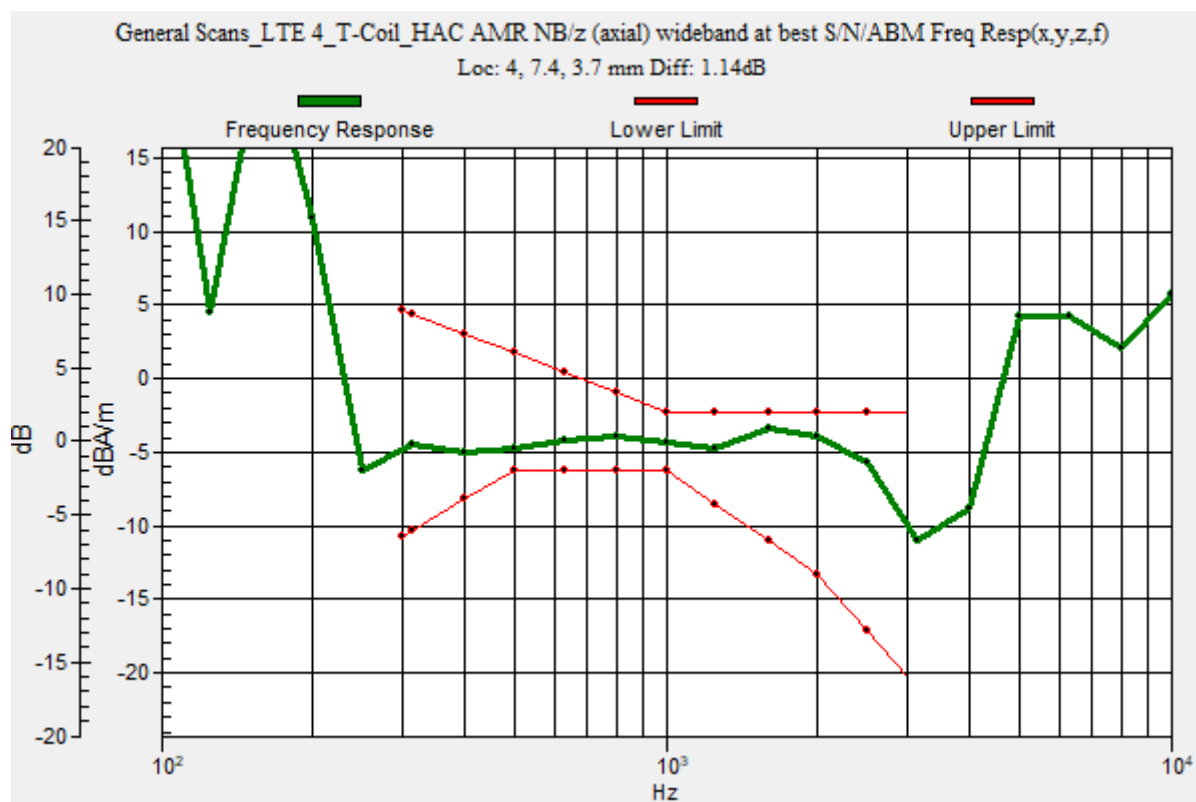

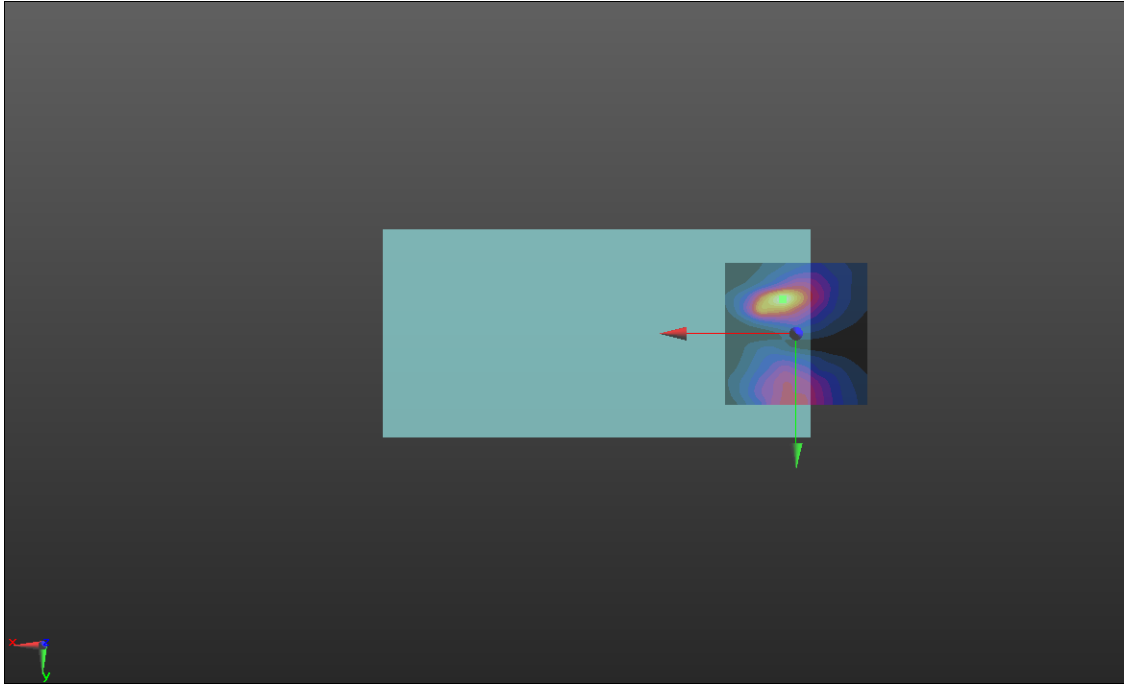
LTE BAND5	Axial Y
<p>Communication System: UID 10175 - CAG, LTE-FDD (SC-FDMA, 1 RB, 10 MHz, QPSK); Frequency: 836.5 MHz; Medium parameters used: $\sigma = 0$ S/m, $\epsilon_r = 1$; $\rho = 0$ kg/m³ Phantom section: TCoil Section</p>	
<p>DASY5 Configuration:</p> <ul style="list-style-type: none"> • Probe: AM1DV2 - 1021; ; Calibrated: 10/22/2020 • Sensor-Surface: 0mm (Fix Surface) • Electronics: DAE4 Sn720; Calibrated: 9/30/2020 • Phantom: HAC Test Arch with AMCC; Type: SD HAC P01 BA; • Measurement SW: DASY52, Version 52.10 (4); SEMCAD X Version 14.6.14 (7483) 	
<p>T-Coil scan (scan for ANSI C63.19-2011 compliance)/General Scans_LTE 5_T-Coil_HAC AMR NB/y (transversal) 4.2mm 50 x 50/ABM Interpolated SNR(x,y,z) (121x121x1): Interpolated grid: dx=1.000 mm, dy=1.000 mm Signal Type: Audio File (.wav) 48k_voice_1kHz_1s.wav Output Gain: 42 Measure Window Start: 300ms Measure Window Length: 1000ms BWC applied: 0.13 dB Device Reference Point: 0, 0, -6.3 mm</p>	
<p>Cursor: ABM1/ABM2 = 43.09 dB ABM1 comp = -8.06 dBA/m BWC Factor = 0.13 dB Location: 4.6, -12.1, 3.7 mm</p>	
	

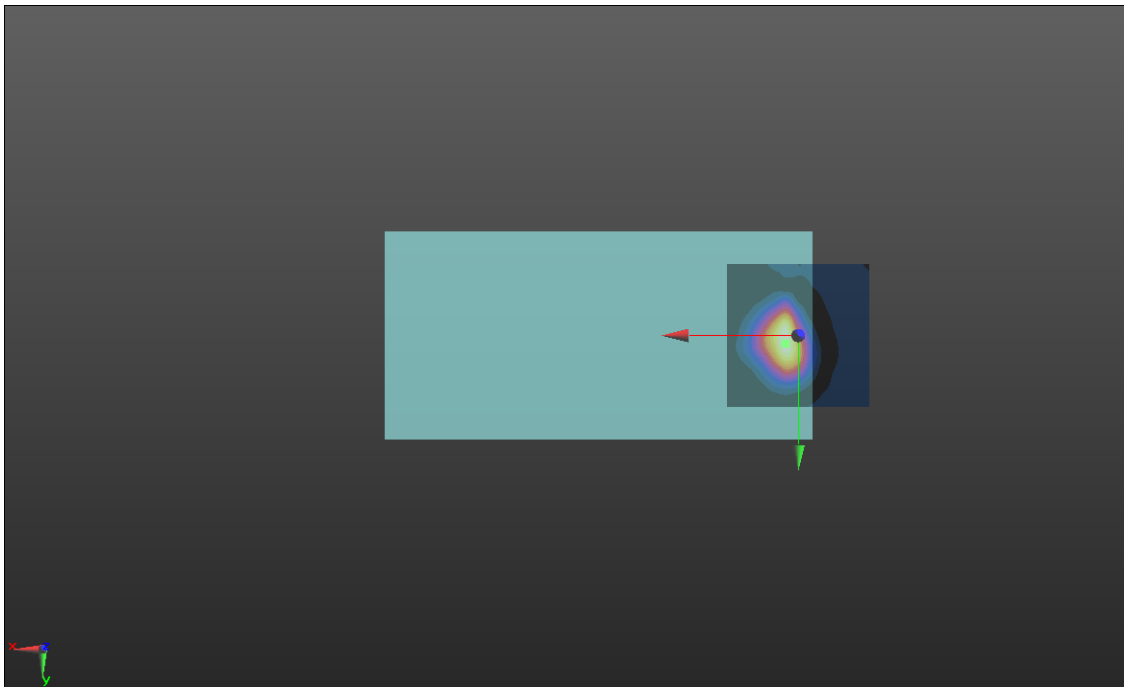
LTE BAND5	Axial Z & Frequency Resp.
<p>Communication System: UID 10175 - CAG, LTE-FDD (SC-FDMA, 1 RB, 10 MHz, QPSK); Frequency: 836.5 MHz; Medium parameters used: $\sigma = 0$ S/m, $\epsilon_r = 1$; $\rho = 0$ kg/m³ Phantom section: TCoil Section</p>	
<p>DASY5 Configuration:</p> <ul style="list-style-type: none"> Probe: AM1DV2 - 1021; ; Calibrated: 10/22/2020 Sensor-Surface: 0mm (Fix Surface) Electronics: DAE4 Sn720; Calibrated: 9/30/2020 Phantom: HAC Test Arch with AMCC; Type: SD HAC P01 BA; Measurement SW: DASY52, Version 52.10 (4); SEMCAD X Version 14.6.14 (7483) 	
<p>T-Coil scan (scan for ANSI C63.19-2011 compliance)/General Scans_LTE 5_T-Coil_HAC AMR NB/z (axial) 4.2mm 50 x 50/ABM Interpolated SNR(x,y,z) (121x121x1): Interpolated grid: dx=1.000 mm, dy=1.000 mm Signal Type: Audio File (.wav) 48k_voice_1kHz_1s.wav Output Gain: 42 Measure Window Start: 300ms Measure Window Length: 1000ms BWC applied: 0.13 dB Device Reference Point: 0, 0, -6.3 mm</p>	
<p>Cursor: ABM1/ABM2 = 45.08 dB ABM1 comp = -1.29 dBA/m BWC Factor = 0.13 dB Location: 4.6, 2.9, 3.7 mm</p>	
<p>T-Coil scan (scan for ANSI C63.19-2011 compliance)/General Scans_LTE 5_T-Coil_HAC AMR NB/z (axial) wideband at best S/N/ABM Freq Resp(x,y,z,f) (1x1x1): Measurement grid: dx=10mm, dy=10mm Signal Type: Audio File (.wav) 48k_voice_300-3000_2s.wav Output Gain: 82.26 Measure Window Start: 300ms Measure Window Length: 2000ms BWC applied: 10.78 dB Device Reference Point: 0, 0, -6.3 mm</p>	
<p>Cursor: Diff = 1.56 dB BWC Factor = 10.78 dB Location: 4.4, 2.8, 3.7 mm</p>	
	

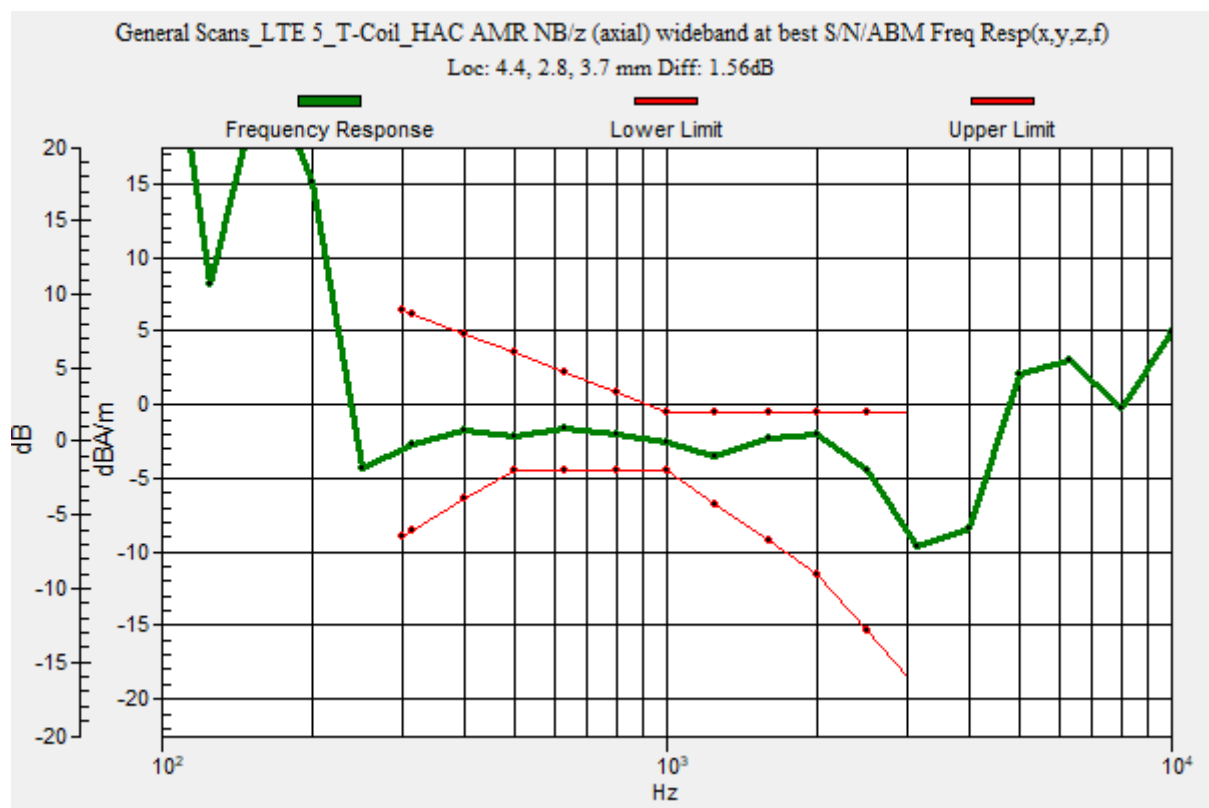

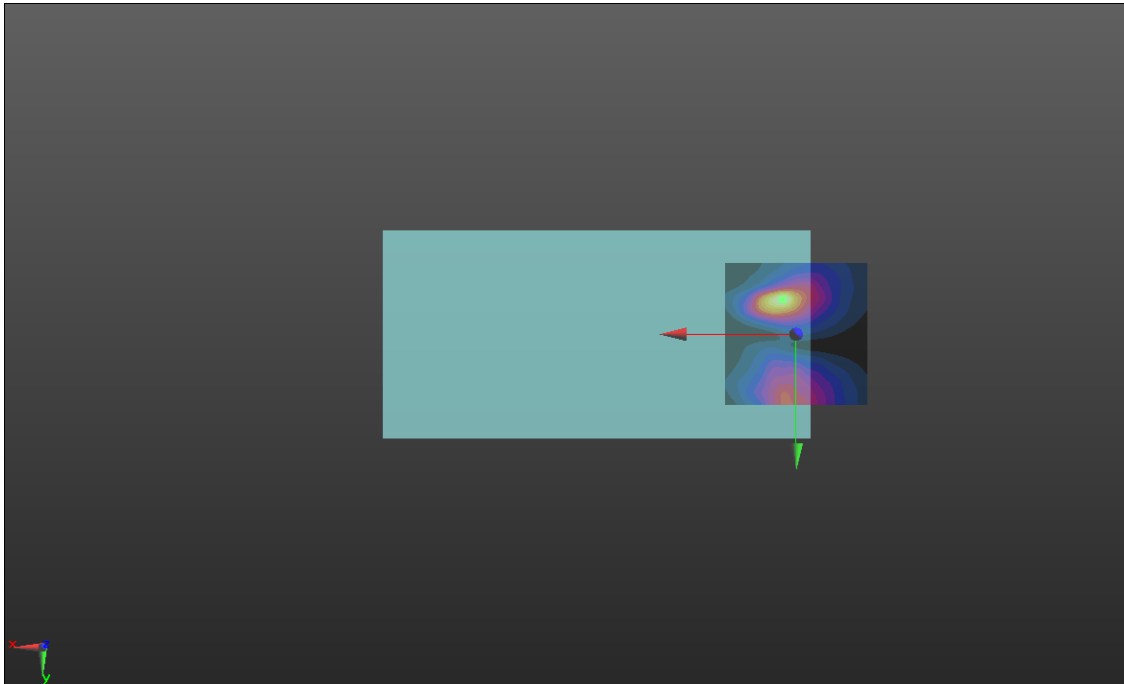
LTE BAND12	Axial Y
<p>Communication System: UID 10175 - CAG, LTE-FDD (SC-FDMA, 1 RB, 10 MHz, QPSK); Frequency: 707.5 MHz; Medium parameters used: $\sigma = 0$ S/m, $\epsilon_r = 1$; $\rho = 0$ kg/m³ Phantom section: TCoil Section</p>	
<p>DASY5 Configuration:</p> <ul style="list-style-type: none"> • Probe: AM1DV2 - 1021; ; Calibrated: 10/22/2020 • Sensor-Surface: 0mm (Fix Surface) • Electronics: DAE4 Sn720; Calibrated: 9/30/2020 • Phantom: HAC Test Arch with AMCC; Type: SD HAC P01 BA; • Measurement SW: DASY52, Version 52.10 (4); SEMCAD X Version 14.6.14 (7483) 	
<p>T-Coil scan (scan for ANSI C63.19-2011 compliance)/General Scans_LTE 12_T-Coil_HAC AMR NB/y (transversal) 4.2mm 50 x 50/ABM Interpolated SNR(x,y,z) (121x121x1): Interpolated grid: dx=1.000 mm, dy=1.000 mm Signal Type: Audio File (.wav) 48k_voice_1kHz_1s.wav Output Gain: 42 Measure Window Start: 300ms Measure Window Length: 1000ms BWC applied: 0.13 dB Device Reference Point: 0, 0, -6.3 mm</p>	
<p>Cursor: ABM1/ABM2 = 42.94 dB ABM1 comp = -8.04 dBA/m BWC Factor = 0.13 dB Location: 4.6, -12.1, 3.7 mm</p>	
	

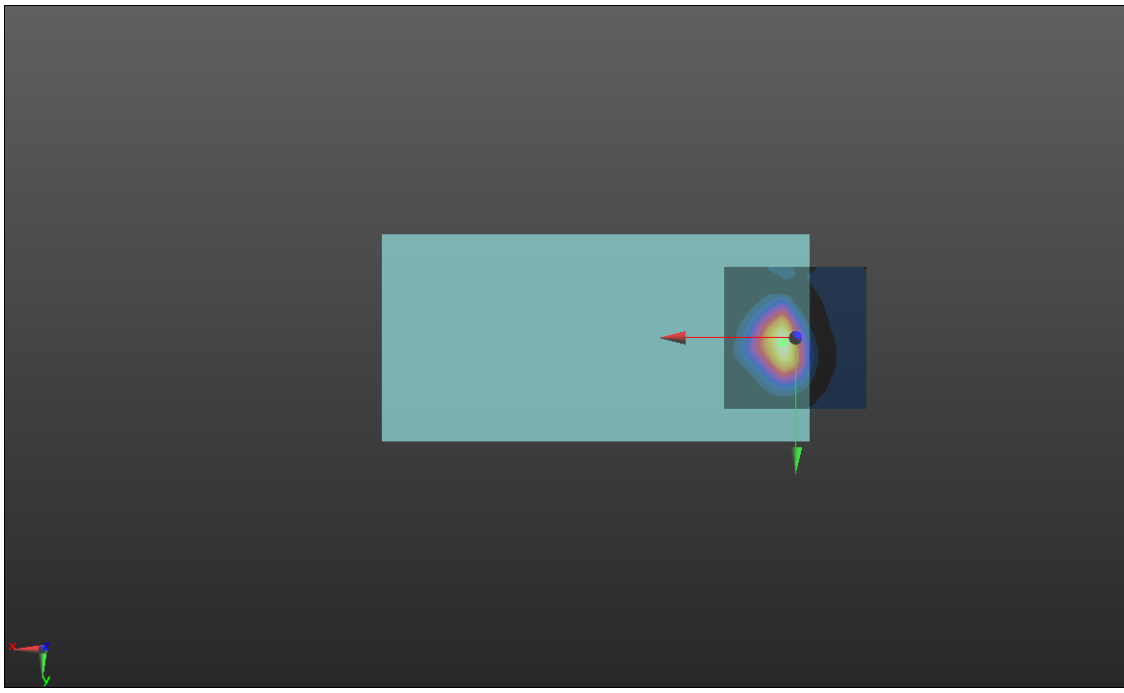
LTE BAND12	Axial Z & Frequency Resp.
<p>Communication System: UID 10175 - CAG, LTE-FDD (SC-FDMA, 1 RB, 10 MHz, QPSK); Frequency: 707.5 MHz; Medium parameters used: $\sigma = 0$ S/m, $\epsilon_r = 1$; $\rho = 0$ kg/m³ Phantom section: TCoil Section</p>	
<p>DASY5 Configuration:</p> <ul style="list-style-type: none"> Probe: AM1DV2 - 1021; ; Calibrated: 10/22/2020 Sensor-Surface: 0mm (Fix Surface) Electronics: DAE4 Sn720; Calibrated: 9/30/2020 Phantom: HAC Test Arch with AMCC; Type: SD HAC P01 BA; Measurement SW: DASY52, Version 52.10 (4); SEMCAD X Version 14.6.14 (7483) 	
<p>T-Coil scan (scan for ANSI C63.19-2011 compliance)/General Scans_LTE 12_T-Coil_HAC AMR NB/z (axial) 4.2mm 50 x 50/ABM Interpolated SNR(x,y,z) (121x121x1): Interpolated grid: dx=1.000 mm, dy=1.000 mm Signal Type: Audio File (.wav) 48k_voice_1kHz_1s.wav Output Gain: 42 Measure Window Start: 300ms Measure Window Length: 1000ms BWC applied: 0.13 dB Device Reference Point: 0, 0, -6.3 mm</p>	
<p>Cursor: ABM1/ABM2 = 45.74 dB ABM1 comp = -1.32 dBA/m BWC Factor = 0.13 dB Location: 4.6, 1.7, 3.7 mm</p>	
<p>T-Coil scan (scan for ANSI C63.19-2011 compliance)/General Scans_LTE 12_T-Coil_HAC AMR NB/z (axial) wideband at best S/N/ABM Freq Resp(x,y,z,f) (1x1x1): Measurement grid: dx=10mm, dy=10mm Signal Type: Audio File (.wav) 48k_voice_300-3000_2s.wav Output Gain: 82.26 Measure Window Start: 300ms Measure Window Length: 2000ms BWC applied: 10.77 dB Device Reference Point: 0, 0, -6.3 mm</p>	
<p>Cursor: Diff = 1.48 dB BWC Factor = 10.77 dB Location: 4.5, 1.7, 3.7 mm</p>	
	

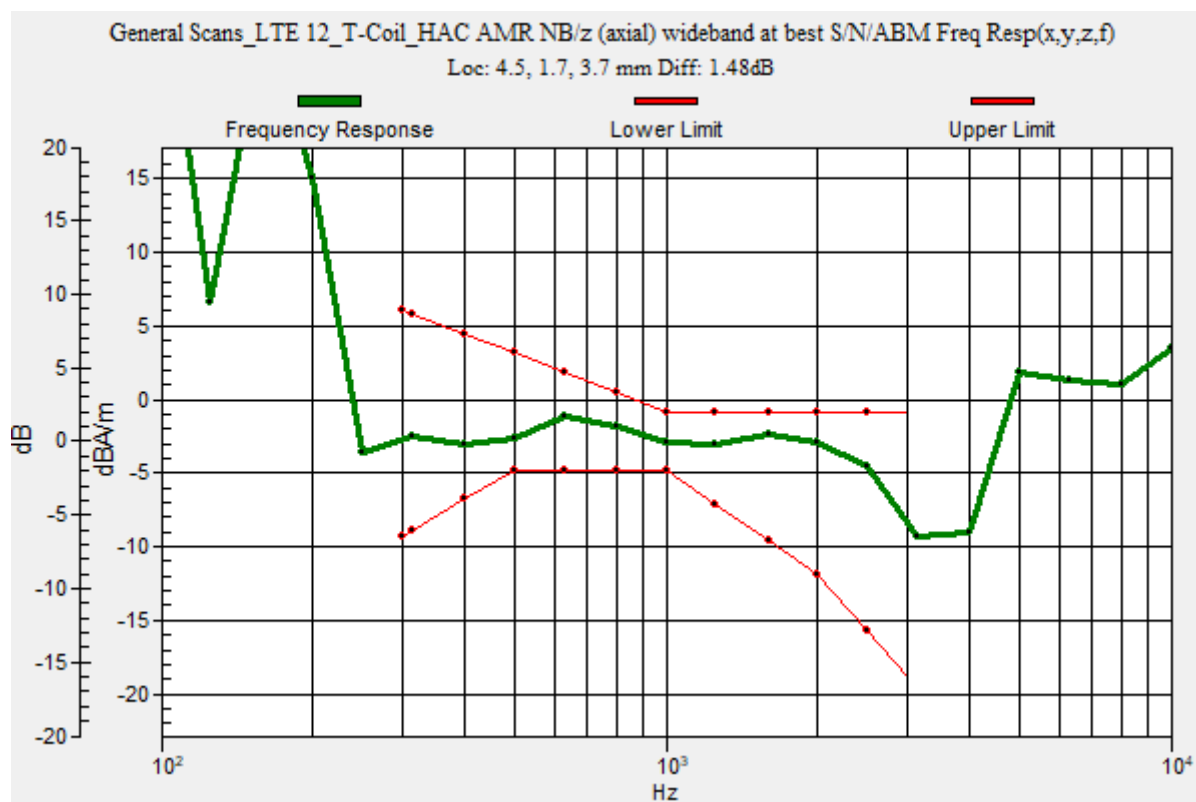

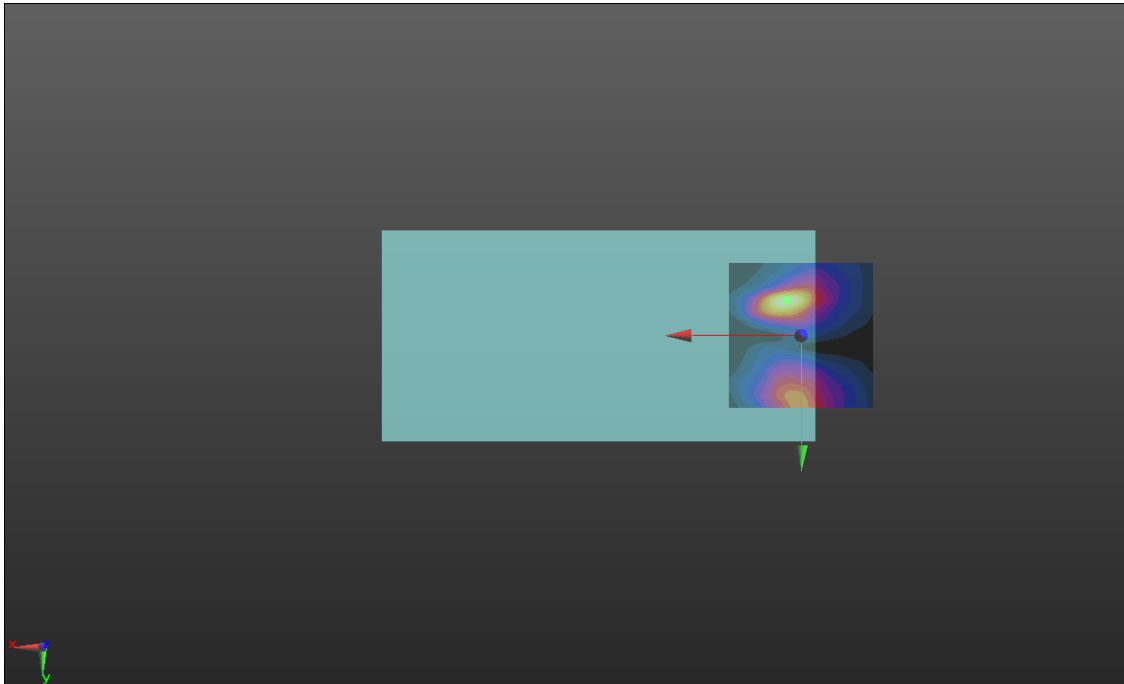
LTE BAND13	Axial Y
<p>Communication System: UID 10175 - CAG, LTE-FDD (SC-FDMA, 1 RB, 10 MHz, QPSK); Frequency: 782 MHz; Medium parameters used: $\sigma = 0$ S/m, $\epsilon_r = 1$; $\rho = 0$ kg/m³ Phantom section: TCoil Section</p> <p>DASY5 Configuration:</p> <ul style="list-style-type: none"> Probe: AM1DV2 - 1021; ; Calibrated: 10/22/2020 Sensor-Surface: 0mm (Fix Surface) Electronics: DAE4 Sn720; Calibrated: 9/30/2020 Phantom: HAC Test Arch with AMCC; Type: SD HAC P01 BA; Measurement SW: DASY52, Version 52.10 (4); SEMCAD X Version 14.6.14 (7483) <p>T-Coil scan (scan for ANSI C63.19-2011 compliance)/General Scans_LTE 13_T-Coil_HAC AMR NB/y (transversal) 4.2mm 50 x 50/ABM Interpolated SNR(x,y,z) (121x121x1): Interpolated grid: dx=1.000 mm, dy=1.000 mm Signal Type: Audio File (.wav) 48k_voice_1kHz_1s.wav Output Gain: 42 Measure Window Start: 300ms Measure Window Length: 1000ms BWC applied: 0.13 dB Device Reference Point: 0, 0, -6.3 mm</p> <p>Cursor: ABM1/ABM2 = 41.95 dB ABM1 comp = -7.85 dBA/m BWC Factor = 0.13 dB Location: 5, -12.1, 3.7 mm</p> 	

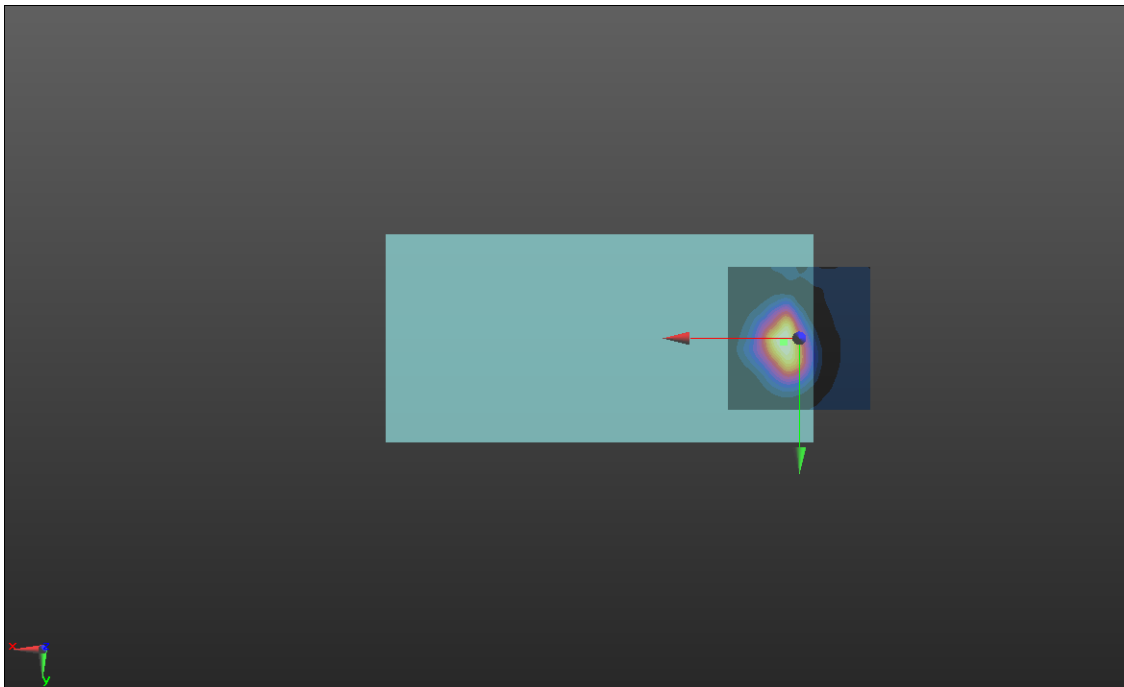
LTE BAND13	Axial Z & Frequency Resp.
<p>Communication System: UID 10175 - CAG, LTE-FDD (SC-FDMA, 1 RB, 10 MHz, QPSK); Frequency: 782 MHz; Medium parameters used: $\sigma = 0$ S/m, $\epsilon_r = 1$; $\rho = 0$ kg/m³ Phantom section: TCoil Section</p>	
<p>DASY5 Configuration:</p> <ul style="list-style-type: none"> Probe: AM1DV2 - 1021; ; Calibrated: 10/22/2020 Sensor-Surface: 0mm (Fix Surface) Electronics: DAE4 Sn720; Calibrated: 9/30/2020 Phantom: HAC Test Arch with AMCC; Type: SD HAC P01 BA; Measurement SW: DASY52, Version 52.10 (4); SEMCAD X Version 14.6.14 (7483) 	
<p>T-Coil scan (scan for ANSI C63.19-2011 compliance)/General Scans_LTE 13_T-Coil_HAC AMR NB/z (axial) 4.2mm 50 x 50/ABM Interpolated SNR(x,y,z) (121x121x1): Interpolated grid: dx=1.000 mm, dy=1.000 mm Signal Type: Audio File (.wav) 48k_voice_1kHz_1s.wav Output Gain: 42 Measure Window Start: 300ms Measure Window Length: 1000ms BWC applied: 0.13 dB Device Reference Point: 0, 0, -6.3 mm</p>	
<p>Cursor: ABM1/ABM2 = 45.83 dB ABM1 comp = -0.54 dBA/m BWC Factor = 0.13 dB Location: 5.4, 1.2, 3.7 mm</p>	
<p>T-Coil scan (scan for ANSI C63.19-2011 compliance)/General Scans_LTE 13_T-Coil_HAC AMR NB/z (axial) wideband at best S/N/ABM Freq Resp(x,y,z,f) (1x1x1): Measurement grid: dx=10mm, dy=10mm Signal Type: Audio File (.wav) 48k_voice_300-3000_2s.wav Output Gain: 82.26 Measure Window Start: 300ms Measure Window Length: 2000ms BWC applied: 10.78 dB Device Reference Point: 0, 0, -6.3 mm</p>	
<p>Cursor: Diff = 1.41 dB BWC Factor = 10.78 dB Location: 5.5, 1.2, 3.7 mm</p>	
	

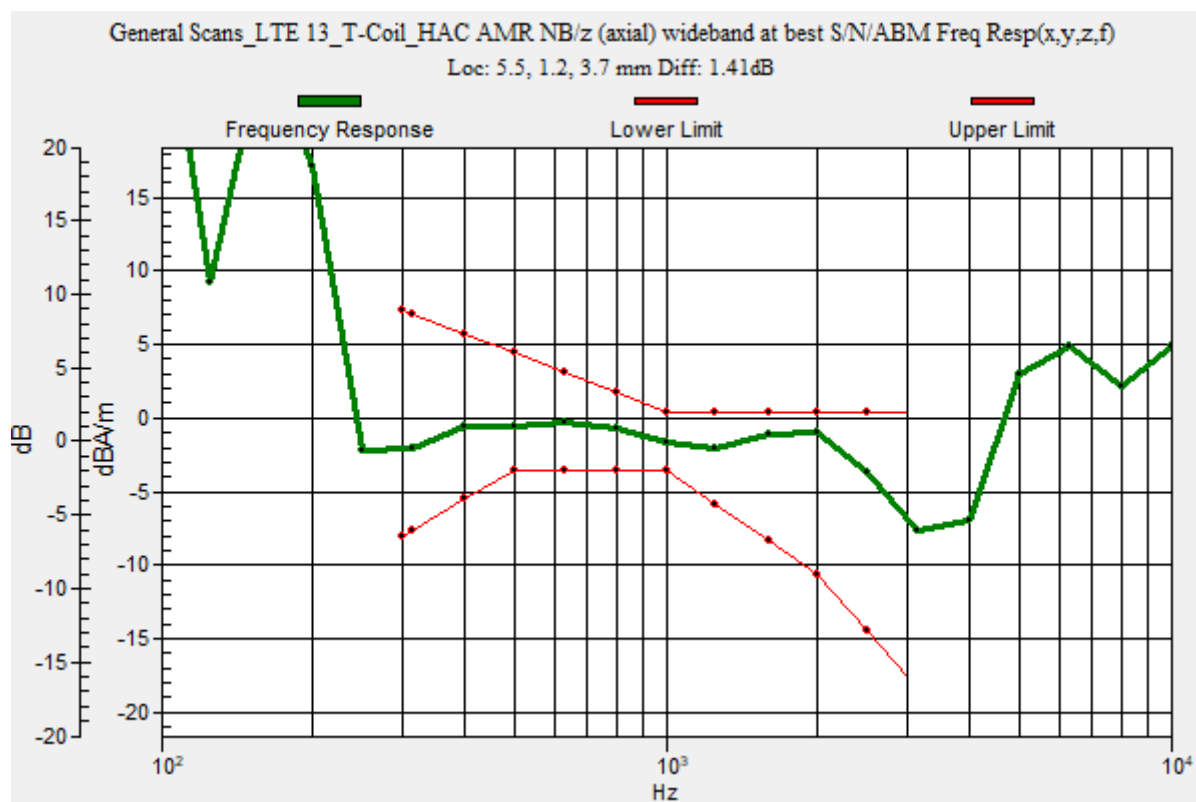

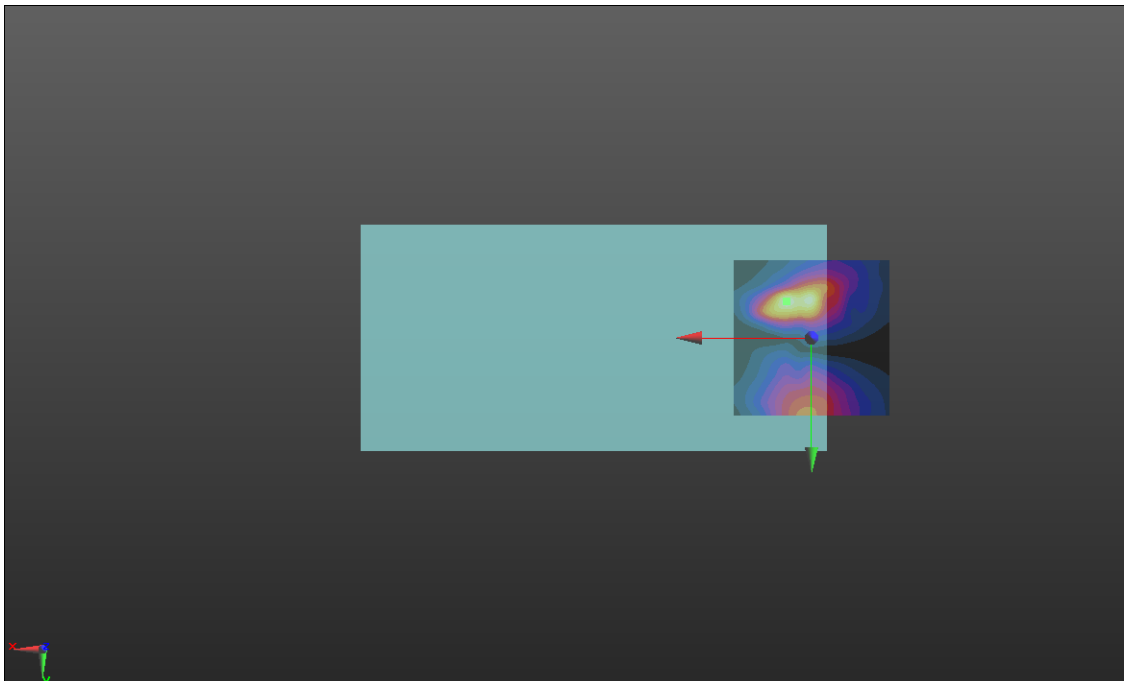
LTE BAND66	Axial Y
<p>Communication System: UID 10169 - CAE, LTE-FDD (SC-FDMA, 1 RB, 20 MHz, QPSK); Frequency: 1745 MHz; Medium parameters used: $\sigma = 0$ S/m, $\epsilon_r = 1$; $\rho = 0$ kg/m³ Phantom section: TCoil Section</p> <p>DASY5 Configuration:</p> <ul style="list-style-type: none"> • Probe: AM1DV2 - 1021; ; Calibrated: 10/22/2020 • Sensor-Surface: 0mm (Fix Surface) • Electronics: DAE4 Sn720; Calibrated: 9/30/2020 • Phantom: HAC Test Arch with AMCC; Type: SD HAC P01 BA; • Measurement SW: DASY52, Version 52.10 (4); SEMCAD X Version 14.6.14 (7483) <p>T-Coil scan (scan for ANSI C63.19-2011 compliance)/General Scans_LTE 66_T-Coil_HAC AMR NB/y (transversal) 4.2mm 50 x 50/ABM Interpolated SNR(x,y,z) (121x121x1): Interpolated grid: dx=1.000 mm, dy=1.000 mm Signal Type: Audio File (.wav) 48k_voice_1kHz_1s.wav Output Gain: 42 Measure Window Start: 300ms Measure Window Length: 1000ms BWC applied: 0.15 dB Device Reference Point: 0, 0, -6.3 mm</p> <p>Cursor: ABM1/ABM2 = 41.30 dB ABM1 comp = -5.57 dBA/m BWC Factor = 0.15 dB Location: 7.9, -11.7, 3.7 mm</p> 	

LTE BAND66

Axial Z & Frequency Resp.

Communication System: UID 10169 - CAE, LTE-FDD (SC-FDMA, 1 RB, 20 MHz, QPSK); Frequency: 1745 MHz;
Medium parameters used: $\sigma = 0$ S/m, $\epsilon_r = 1$; $\rho = 0$ kg/m³
Phantom section: TCoil Section

DASY5 Configuration:

- Probe: AM1DV2 - 1021; ; Calibrated: 10/22/2020
- Sensor-Surface: 0mm (Fix Surface)
- Electronics: DAE4 Sn720; Calibrated: 9/30/2020
- Phantom: HAC Test Arch with AMCC; Type: SD HAC P01 BA;
- Measurement SW: DASY52, Version 52.10 (4); SEMCAD X Version 14.6.14 (7483)

T-Coil scan (scan for ANSI C63.19-2011 compliance)/General Scans_LTE 66_T-Coil_HAC AMR NB/z (axial) 4.2mm 50 x 50/ABM

Interpolated SNR(x,y,z) (121x121x1): Interpolated grid: dx=1.000 mm, dy=1.000 mm

Signal Type: Audio File (.wav) 48k_voice_1kHz_1s.wav

Output Gain: 42

Measure Window Start: 300ms

Measure Window Length: 1000ms

BWC applied: 0.15 dB

Device Reference Point: 0, 0, -6.3 mm

Cursor:

ABM1/ABM2 = 45.70 dB

ABM1 comp = -2.73 dBA/m

BWC Factor = 0.15 dB

Location: 4.2, 0.4, 3.7 mm

T-Coil scan (scan for ANSI C63.19-2011 compliance)/General Scans_LTE 66_T-Coil_HAC AMR NB/z (axial) wideband at best

S/N/ABM Freq Resp(x,y,z,f) (1x1x1): Measurement grid: dx=10mm, dy=10mm

Signal Type: Audio File (.wav) 48k_voice_300-3000_2s.wav

Output Gain: 82.26

Measure Window Start: 300ms

Measure Window Length: 2000ms

BWC applied: 10.79 dB

Device Reference Point: 0, 0, -6.3 mm

Cursor:

Diff = 1.47 dB

BWC Factor = 10.79 dB

Location: 4.3, 0.5, 3.7 mm

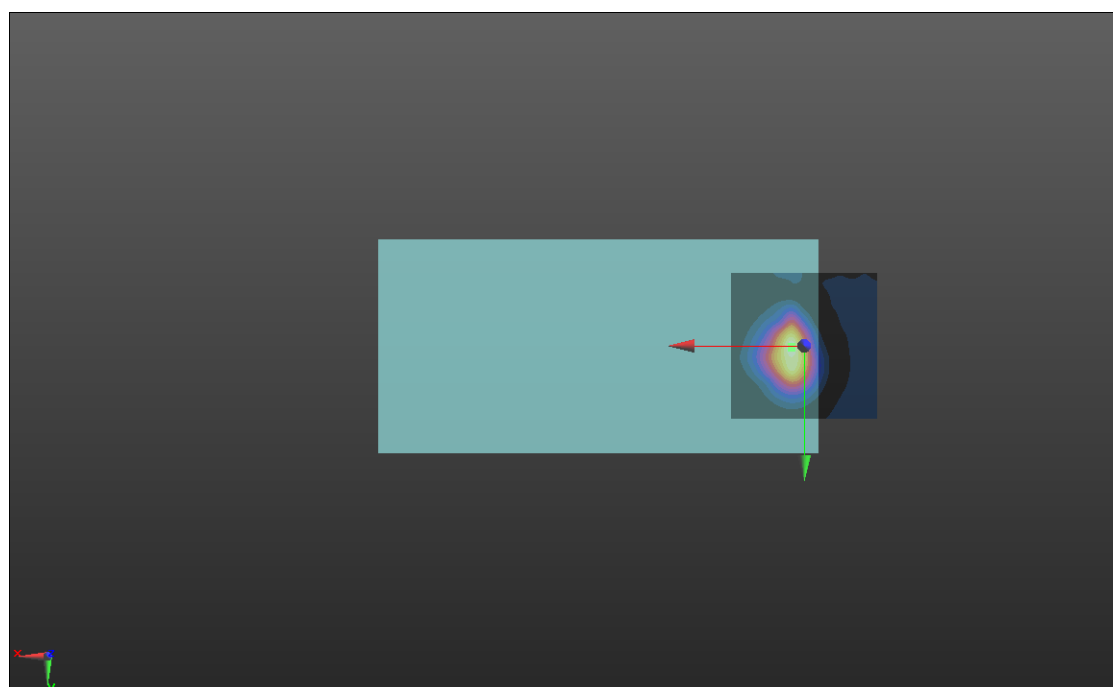

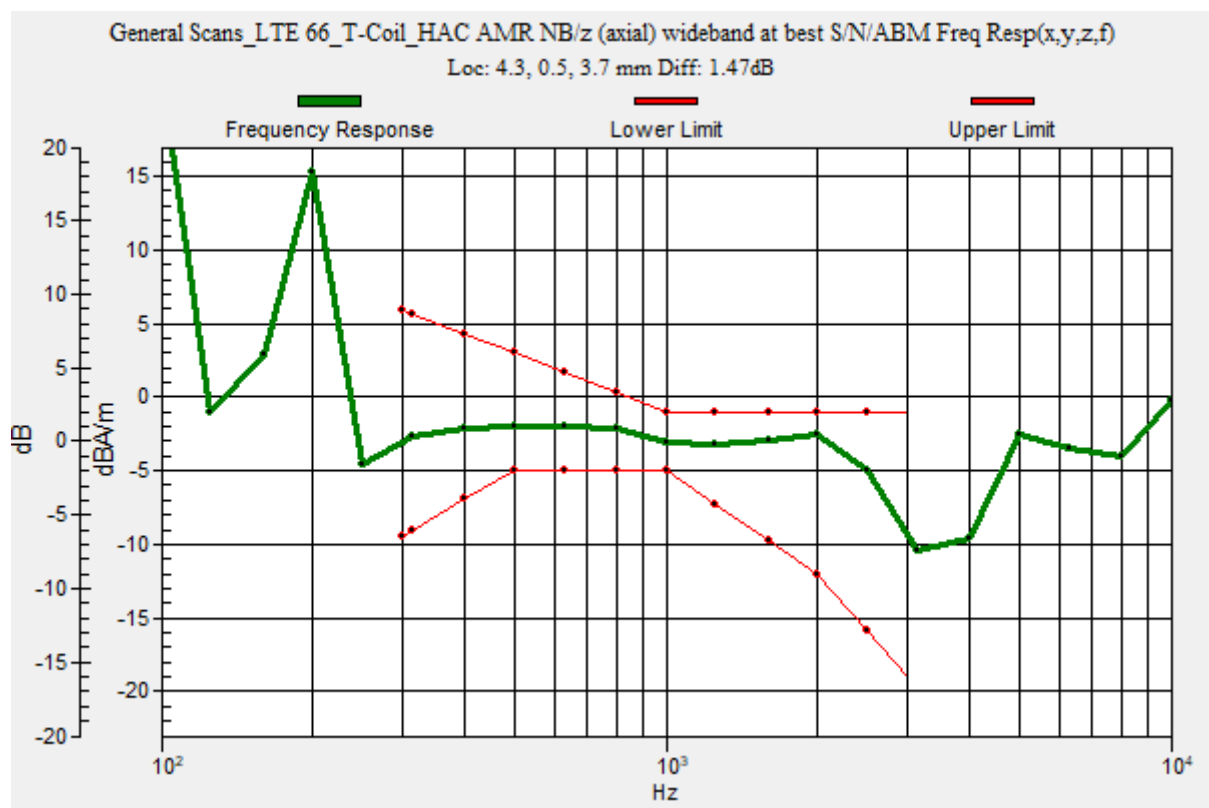

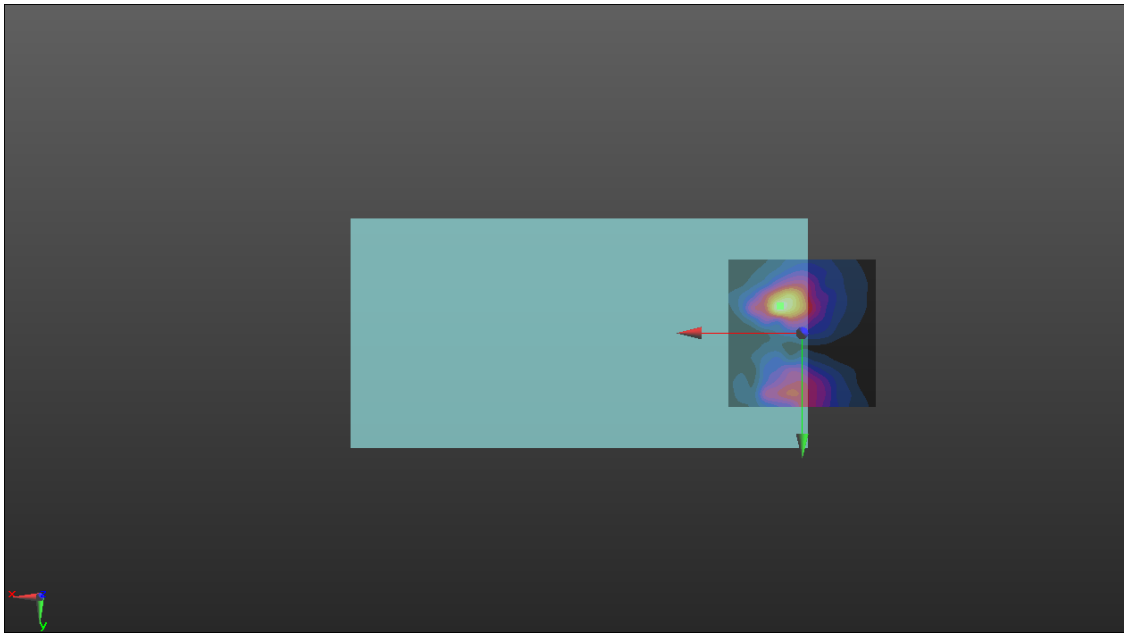
WIFI 2.4G 802.11b	Axial Y										
<p>Communication System: UID 10415 - AAA, IEEE 802.11b WiFi 2.4 GHz (DSSS, 1 Mbps, 99pc duty cycle); Frequency: 2437 MHz; Medium parameters used: $\sigma = 0$ S/m, $\epsilon_r = 1$; $\rho = 0$ kg/m³ Phantom section: TCoil Section</p> <p>DASY5 Configuration:</p> <ul style="list-style-type: none"> Probe: AM1DV2 - 1021; ; Calibrated: 2020/10/22 Sensor-Surface: 0mm (Fix Surface) Electronics: DAE4 Sn720; Calibrated: 2020/9/30 Phantom: HAC Test Arch with AMCC; Type: SD HAC P01 BA; Measurement SW: DASY52, Version 52.8 (8); SEMCAD X Version 14.6.10 (7373) <p>T-Coil scan (scan for ANSI C63.19-2011 compliance)/General Scans_WIFI2.4G 802.11b_T-Coil_HAC 3/y (transversal) 4.2mm 50 x 50/ABM Interpolated SNR(x,y,z) (121x121x1): Interpolated grid: dx=1.000 mm, dy=1.000 mm Signal Type: Audio File (.wav) 48k_voice_1kHz_1s.wav Output Gain: 26.5 Measure Window Start: 300ms Measure Window Length: 1000ms BWC applied: 0.15 dB Device Reference Point: 0, 0, -6.3 mm</p> <table border="1" style="margin-left: auto; margin-right: auto;"> <thead> <tr> <th style="text-align: center;">Category</th> <th style="text-align: center;">Telephone parameters WD signal quality [(signal+noise)-to-noise ratio in decibels]</th> </tr> </thead> <tbody> <tr> <td style="text-align: center;">Category T1</td> <td style="text-align: center;">0 dB to 10 dB</td> </tr> <tr> <td style="text-align: center;">Category T2</td> <td style="text-align: center;">10 dB to 20 dB</td> </tr> <tr> <td style="text-align: center;">Category T3</td> <td style="text-align: center;">20 dB to 30 dB</td> </tr> <tr> <td style="text-align: center;">Category T4</td> <td style="text-align: center;">> 30 dB</td> </tr> </tbody> </table> <p>Cursor: ABM1/ABM2 = 48.02 dB ABM1 comp = -4.03 dBA/m BWC Factor = 0.15 dB Location: 7.5, -9.2, 3.7 mm</p> <div style="text-align: center;">  </div>		Category	Telephone parameters WD signal quality [(signal+noise)-to-noise ratio in decibels]	Category T1	0 dB to 10 dB	Category T2	10 dB to 20 dB	Category T3	20 dB to 30 dB	Category T4	> 30 dB
Category	Telephone parameters WD signal quality [(signal+noise)-to-noise ratio in decibels]										
Category T1	0 dB to 10 dB										
Category T2	10 dB to 20 dB										
Category T3	20 dB to 30 dB										
Category T4	> 30 dB										

WIFI 2.4G 802.11b

Axial Z & Frequency Resp.

Communication System: UID 10415 - AAA, IEEE 802.11b WiFi 2.4 GHz (DSSS, 1 Mbps, 99pc duty cycle); Frequency: 2437 MHz;
Medium parameters used: $\sigma = 0$ S/m, $\epsilon_r = 1$; $\rho = 0$ kg/m³
Phantom section: TCoil Section

DASY5 Configuration:

- Probe: AM1DV2 - 1021; ; Calibrated: 2020/10/22
- Sensor-Surface: 0mm (Fix Surface)
- Electronics: DAE4 Sn720; Calibrated: 2020/9/30
- Phantom: HAC Test Arch with AMCC; Type: SD HAC P01 BA;
- Measurement SW: DASY52, Version 52.8 (8); SEMCAD X Version 14.6.10 (7373)

T-Coil scan (scan for ANSI C63.19-2011 compliance)/General Scans_WIFI2.4G 802.11b_T-Coil_HAC 3/z (axial) 4.2mm 50 x 50/ABM

Interpolated SNR(x,y,z) (121x121x1): Interpolated grid: dx=1.000 mm, dy=1.000 mm

Signal Type: Audio File (.wav) 48k_voice_1kHz_1s.wav

Output Gain: 26.5

Measure Window Start: 300ms

Measure Window Length: 1000ms

BWC applied: 0.15 dB

Device Reference Point: 0, 0, -6.3 mm

Cursor:

ABM1/ABM2 = 53.19 dB

ABM1 comp = -0.59 dBA/m

BWC Factor = 0.15 dB

Location: 4.2, 6.2, 3.7 mm

T-Coil scan (scan for ANSI C63.19-2011 compliance)/General Scans_WIFI2.4G 802.11b_T-Coil_HAC 3/z (axial) wideband at best

S/N/ABM Freq Resp(x,y,z,f) (1x1x1): Measurement grid: dx=10mm, dy=10mm

Signal Type: Audio File (.wav) 48k_voice_300-3000_2s.wav

Output Gain: 51.9

Measure Window Start: 300ms

Measure Window Length: 2000ms

BWC applied: 10.79 dB

Device Reference Point: 0, 0, -6.3 mm

Cursor:

Diff = 1.10 dB

BWC Factor = 10.79 dB

Location: 4.1, 6.3, 3.7 mm

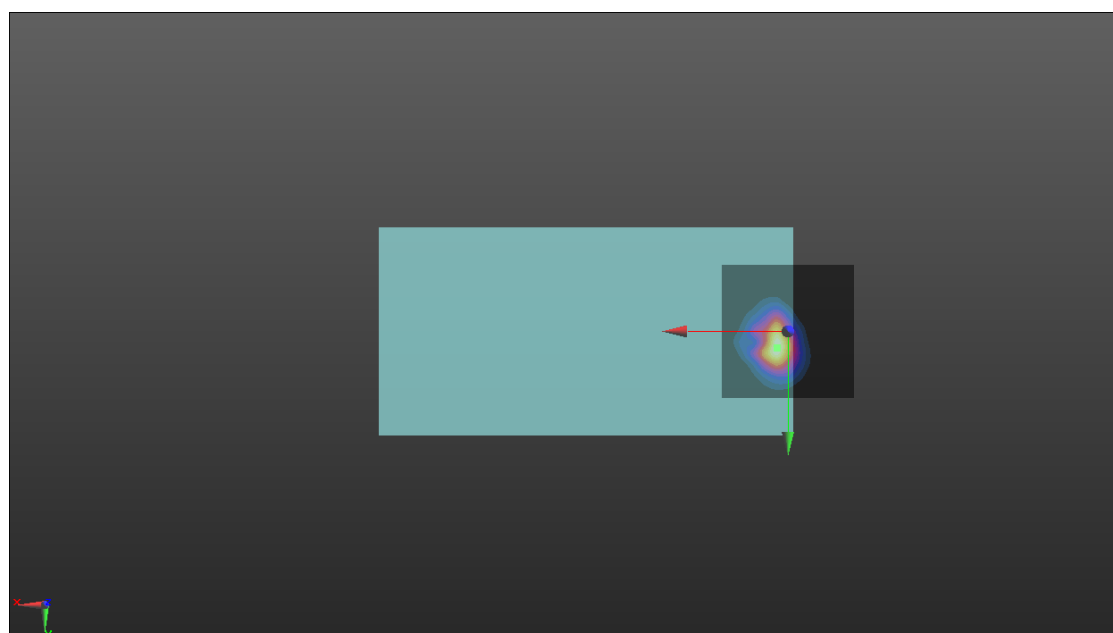

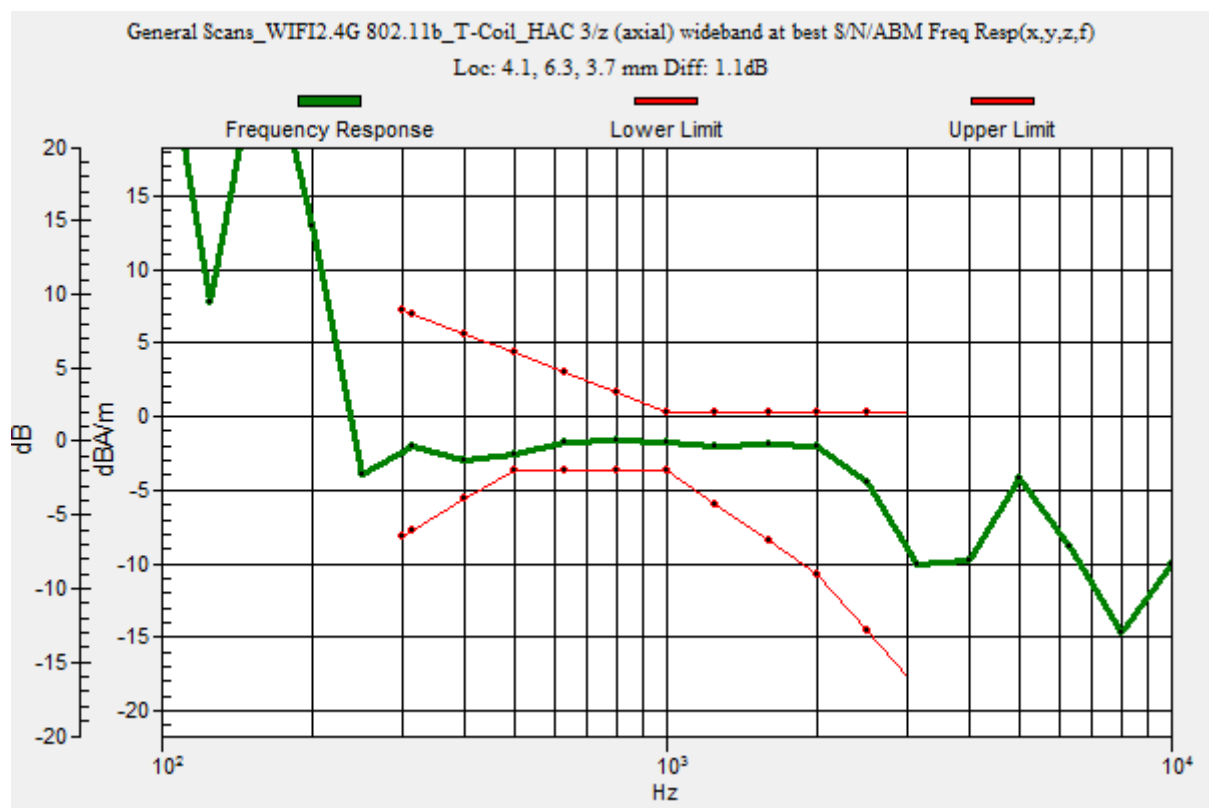

WIFI5GHz U-NII-1 802.11a	Axial Y
<p>Communication System: UID 10317 - AAC, IEEE 802.11a WiFi 5 GHz (OFDM, 6 Mbps, 96pc duty cycle); Frequency: 5200 MHz; Medium parameters used: $\sigma = 0$ S/m, $\epsilon_r = 1$; $\rho = 0$ kg/m³ Phantom section: TCoil Section</p>	
<p>DASY5 Configuration:</p> <ul style="list-style-type: none"> • Probe: AM1DV2 - 1021; ; Calibrated: 2020/10/22 • Sensor-Surface: 0mm (Fix Surface) • Electronics: DAE4 Sn720; Calibrated: 2020/9/30 • Phantom: HAC Test Arch with AMCC; Type: SD HAC P01 BA; • Measurement SW: DASY52, Version 52.8 (8); SEMCAD X Version 14.6.10 (7373) 	
<p>T-Coil scan (scan for ANSI C63.19-2011 compliance)/General Scans_WIFI5G UNII-1 802.11a T-Coil_HAC 3/y (transversal) 4.2mm 50 x 50/ABM Interpolated SNR(x,y,z) (121x121x1): Interpolated grid: dx=1.000 mm, dy=1.000 mm Signal Type: Audio File (.wav) 48k_voice_1kHz_1s.wav Output Gain: 26.5 Measure Window Start: 300ms Measure Window Length: 1000ms BWC applied: 0.15 dB Device Reference Point: 0, 0, -6.3 mm</p>	
<p>Cursor: ABM1/ABM2 = 38.92 dB ABM1 comp = -8.95 dBA/m BWC Factor = 0.15 dB Location: 3.3, 19.6, 3.7 mm</p>	

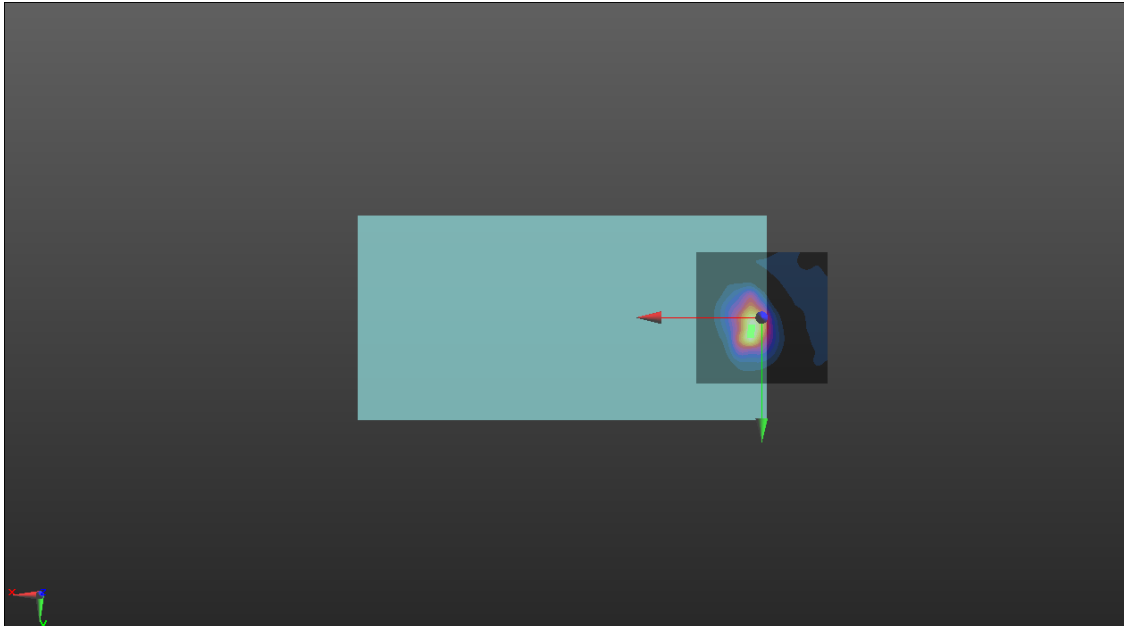
WIFI5GHz U-NII-1 802.11a	Axial Z & Frequency Resp.
<p>Communication System: UID 10317 - AAC, IEEE 802.11a WiFi 5 GHz (OFDM, 6 Mbps, 96pc duty cycle); Frequency: 5200 MHz; Medium parameters used: $\sigma = 0$ S/m, $\epsilon_r = 1$; $\rho = 0$ kg/m³ Phantom section: TCoil Section</p>	
<p>DASY5 Configuration:</p> <ul style="list-style-type: none"> • Probe: AM1DV2 - 1021; ; Calibrated: 2020/10/22 • Sensor-Surface: 0mm (Fix Surface) • Electronics: DAE4 Sn720; Calibrated: 2020/9/30 • Phantom: HAC Test Arch with AMCC; Type: SD HAC P01 BA; • Measurement SW: DASY52, Version 52.8 (8); SEMCAD X Version 14.6.10 (7373) 	
<p>T-Coil scan (scan for ANSI C63.19-2011 compliance)/General Scans_WIFI5G UNII-1 802.11a T-Coil_HAC 3/z (axial) 4.2mm 50 x 50/ABM Interpolated SNR(x,y,z) (121x121x1): Interpolated grid: dx=1.000 mm, dy=1.000 mm Signal Type: Audio File (.wav) 48k_voice_1kHz_1s.wav Output Gain: 26.5 Measure Window Start: 300ms Measure Window Length: 1000ms BWC applied: 0.15 dB Device Reference Point: 0, 0, -6.3 mm</p>	
<p>Cursor: ABM1/ABM2 = 46.29 dB ABM1 comp = -0.93 dBA/m BWC Factor = 0.15 dB Location: 4.2, 6.2, 3.7 mm</p>	
<p>T-Coil scan (scan for ANSI C63.19-2011 compliance)/General Scans_WIFI5G UNII-1 802.11a T-Coil_HAC 3/z (axial) wideband at best S/N/ABM Freq Resp(x,y,z,f) (1x1x1): Measurement grid: dx=10mm, dy=10mm Signal Type: Audio File (.wav) 48k_voice_300-3000_2s.wav Output Gain: 51.9 Measure Window Start: 300ms Measure Window Length: 2000ms BWC applied: 10.80 dB Device Reference Point: 0, 0, -6.3 mm</p>	
<p>Cursor: Diff = 1.35 dB BWC Factor = 10.80 dB Location: 4, 4, 3.7 mm</p>	
	

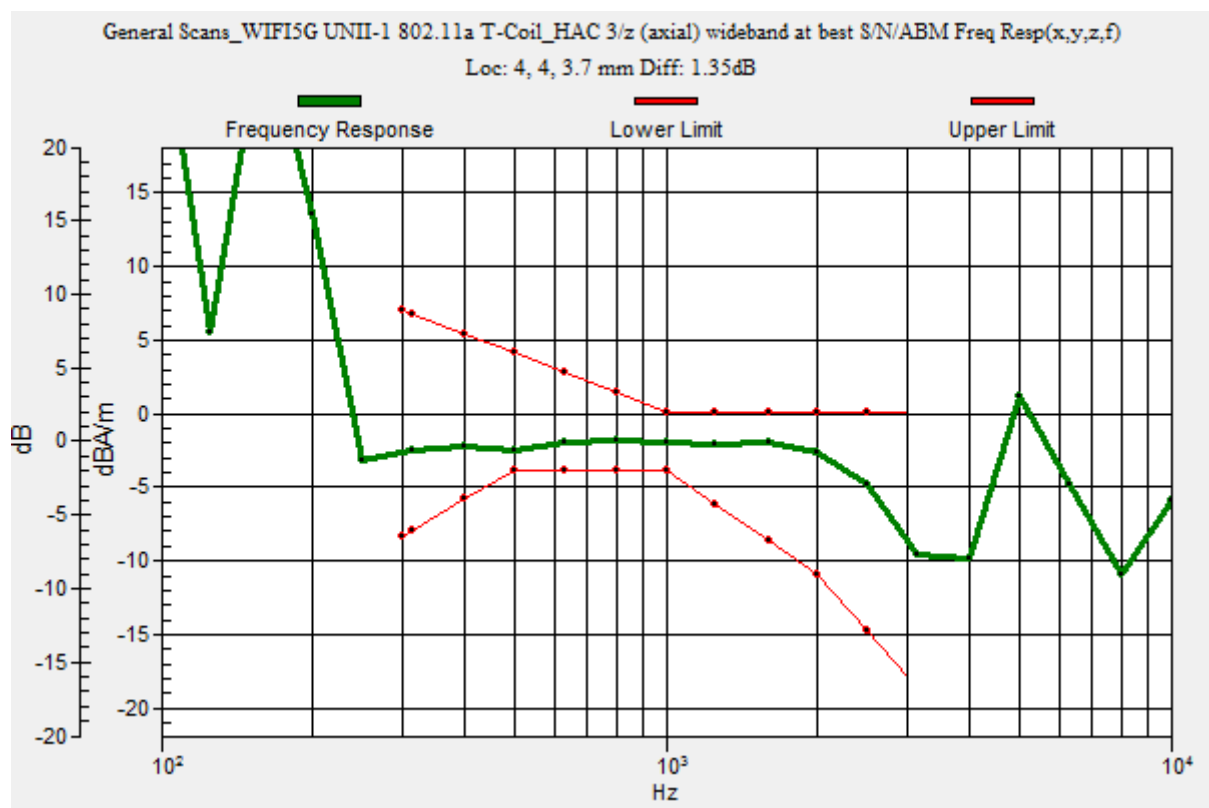

WIFI5GHz U-NII-3 802.11a	Axial Y
<p>Communication System: UID 10317 - AAD, IEEE 802.11a WiFi 5 GHz (OFDM, 6 Mbps, 96pc duty cycle); Frequency: 5785 MHz; Medium parameters used: $\sigma = 0$ S/m, $\epsilon_r = 1$; $\rho = 0$ kg/m³ Phantom section: TCoil Section</p>	
<p>DASY5 Configuration:</p> <ul style="list-style-type: none"> • Probe: AM1DV2 - 1021; ; Calibrated: 2020/10/22 • Sensor-Surface: 0mm (Fix Surface) • Electronics: DAE4 Sn720; Calibrated: 2020/9/30 • Phantom: HAC Test Arch with AMCC; Type: SD HAC P01 BA; • Measurement SW: DASY52, Version 52.8 (8); SEMCAD X Version 14.6.10 (7373) 	
<p>T-Coil scan (scan for ANSI C63.19-2011 compliance)/General Scans_WIFI5G UNII-3 802.11a T-Coil_HAC 2/y (transversal) 4.2mm 50 x 50/ABM Interpolated SNR(x,y,z) (121x121x1): Interpolated grid: dx=1.000 mm, dy=1.000 mm Signal Type: Audio File (.wav) 48k_voice_1kHz_1s.wav Output Gain: 26.5 Measure Window Start: 300ms Measure Window Length: 1000ms BWC applied: 0.15 dB Device Reference Point: 0, 0, -6.3 mm</p>	
<p>Cursor: ABM1/ABM2 = 39.77 dB ABM1 comp = -11.31 dBA/m BWC Factor = 0.15 dB Location: 0.4, 20.8, 3.7 mm</p>	

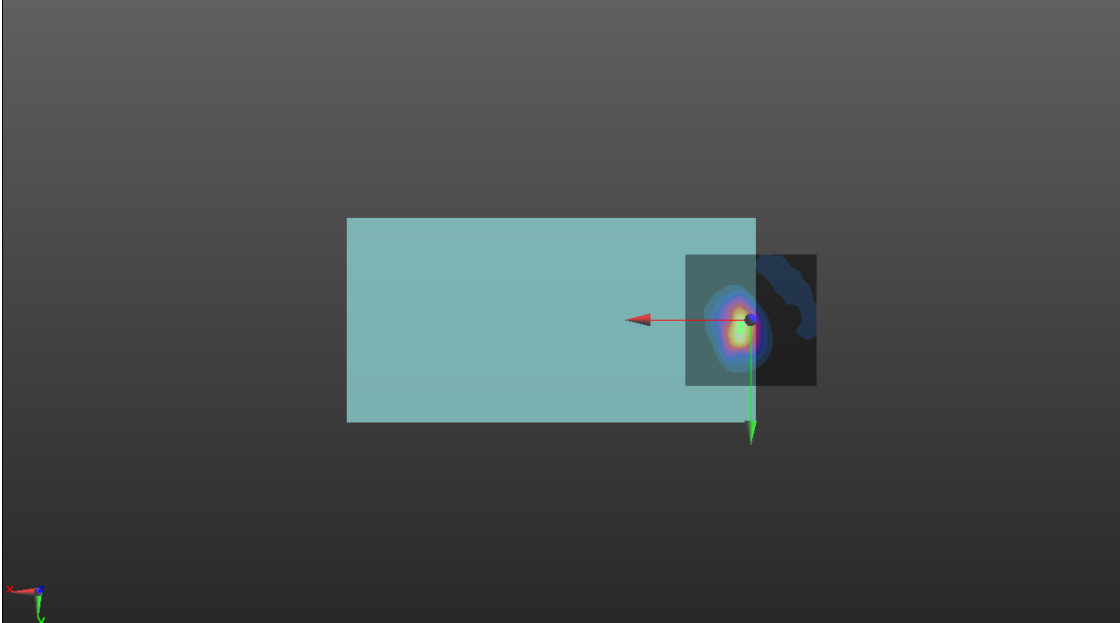
WIFI5GHz U-NII-3 802.11a	Axial Z & Frequency Resp.
<p>Communication System: UID 10317 - AAD, IEEE 802.11a WiFi 5 GHz (OFDM, 6 Mbps, 96pc duty cycle); Frequency: 5785 MHz; Medium parameters used: $\sigma = 0$ S/m, $\epsilon_r = 1$; $\rho = 0$ kg/m³ Phantom section: TCoil Section</p>	
<p>DASY5 Configuration:</p> <ul style="list-style-type: none"> • Probe: AM1DV2 - 1021; ; Calibrated: 2020/10/22 • Sensor-Surface: 0mm (Fix Surface) • Electronics: DAE4 Sn720; Calibrated: 2020/9/30 • Phantom: HAC Test Arch with AMCC; Type: SD HAC P01 BA; • Measurement SW: DASY52, Version 52.8 (8); SEMCAD X Version 14.6.10 (7373) 	
<p>T-Coil scan (scan for ANSI C63.19-2011 compliance)/General Scans_WIFI5G UNII-3 802.11a T-Coil_HAC 2/z (axial) 4.2mm 50 x 50/ABM Interpolated SNR(x,y,z) (121x121x1): Interpolated grid: dx=1.000 mm, dy=1.000 mm Signal Type: Audio File (.wav) 48k_voice_1kHz_1s.wav Output Gain: 26.5 Measure Window Start: 300ms Measure Window Length: 1000ms BWC applied: 0.15 dB Device Reference Point: 0, 0, -6.3 mm</p>	
<p>Cursor: ABM1/ABM2 = 46.77 dB ABM1 comp = -1.50 dBA/m BWC Factor = 0.15 dB Location: 3.8, 2.1, 3.7 mm</p>	
<p>T-Coil scan (scan for ANSI C63.19-2011 compliance)/General Scans_WIFI5G UNII-3 802.11a T-Coil_HAC 2/z (axial) wideband at best S/N/ABM Freq Resp(x,y,z,f) (1x1x1): Measurement grid: dx=10mm, dy=10mm Signal Type: Audio File (.wav) 48k_voice_300-3000_2s.wav Output Gain: 51.9 Measure Window Start: 300ms Measure Window Length: 2000ms BWC applied: 10.79 dB Device Reference Point: 0, 0, -6.3 mm</p>	
<p>Cursor: Diff = 1.06 dB BWC Factor = 10.79 dB Location: 4, 4, 3.7 mm</p>	
	

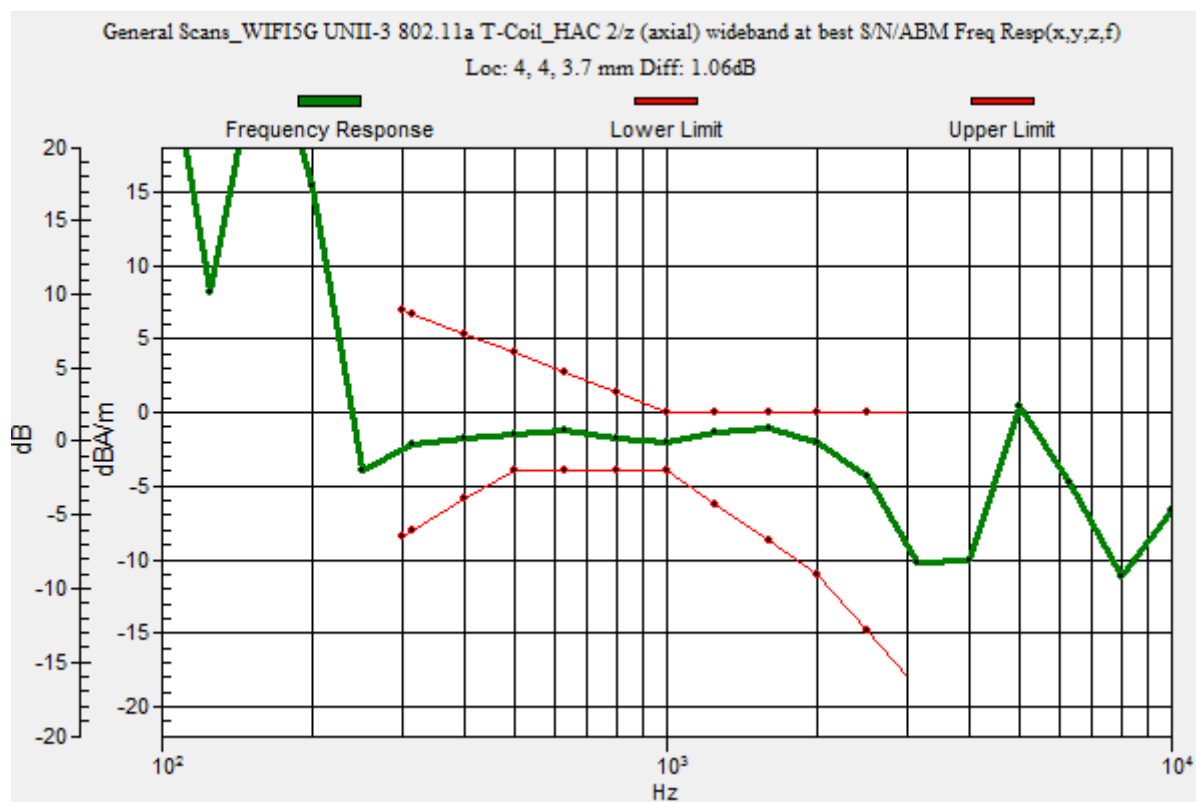

A.2 Test Plot for OTT Application

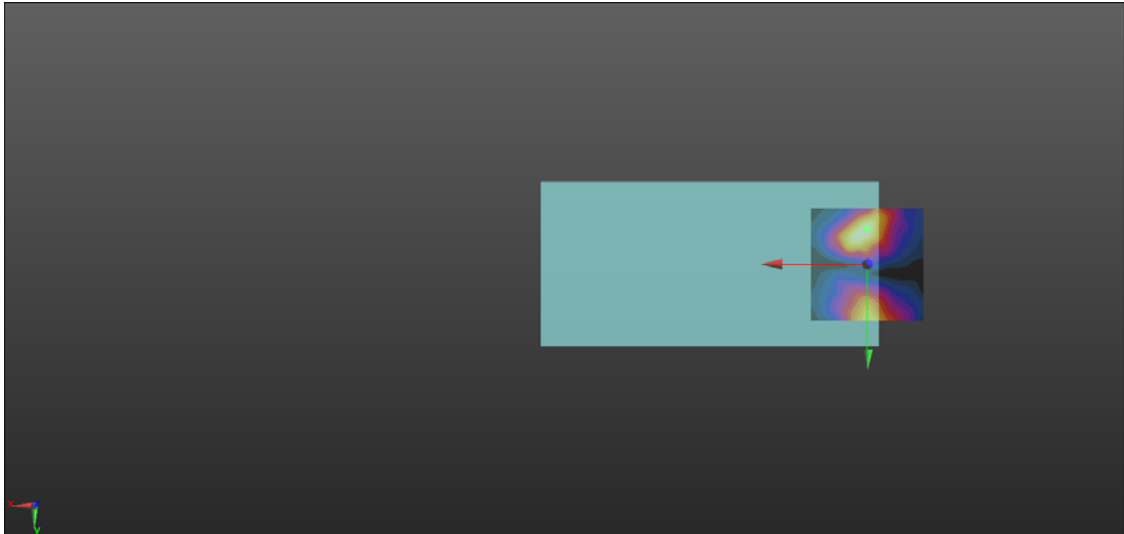
LTE BAND66	Axial Y
<p>Communication System: UID 10169 - CAE, LTE-FDD (SC-FDMA, 1 RB, 20 MHz, QPSK); Frequency: 1745 MHz; Medium parameters used: $\sigma = 0$ S/m, $\epsilon_r = 1$; $\rho = 0$ kg/m³ Phantom section: TCoil Section</p> <p>DASY5 Configuration:</p> <ul style="list-style-type: none"> • Probe: AM1DV2 - 1021; ; Calibrated: 10/22/2020 • Sensor-Surface: 0mm (Fix Surface) • Electronics: DAE4 Sn720; Calibrated: 9/30/2020 • Phantom: HAC Test Arch with AMCC; Type: SD HAC P01 BA; • Measurement SW: DASY52, Version 52.10 (4); SEMCAD X Version 14.6.14 (7483) <p>T-Coil scan (scan for ANSI C63.19-2011 compliance)/General Scans_LTE band66_T-Coil_HAC_OTT/y (transversal) 4.2mm 50 x 50/ABM Interpolated SNR(x,y,z) (121x121x1): Interpolated grid: dx=1.000 mm, dy=1.000 mm Signal Type: Audio File (.wav) 48k_voice_1kHz_1s.wav Output Gain: 19.75 Measure Window Start: 300ms Measure Window Length: 1000ms BWC applied: 0.14 dB Device Reference Point: 0, 0, -6.3 mm</p> <p>Cursor: ABM1/ABM2 = 42.93 dB ABM1 comp = -6.87 dBA/m BWC Factor = 0.14 dB Location: 0.4, -15.8, 3.7 mm</p> 	

LTE BAND66

Axial Z & Frequency Resp.

Communication System: UID 10169 - CAE, LTE-FDD (SC-FDMA, 1 RB, 20 MHz, QPSK); Frequency: 1745 MHz;
Medium parameters used: $\sigma = 0$ S/m, $\epsilon_r = 1$; $\rho = 0$ kg/m³
Phantom section: TCoil Section

DASY5 Configuration:

- Probe: AM1DV2 - 1021; ; Calibrated: 10/22/2020
- Sensor-Surface: 0mm (Fix Surface)
- Electronics: DAE4 Sn720; Calibrated: 9/30/2020
- Phantom: HAC Test Arch with AMCC; Type: SD HAC P01 BA;
- Measurement SW: DASY52, Version 52.10 (4); SEMCAD X Version 14.6.14 (7483)

T-Coil scan (scan for ANSI C63.19-2011 compliance)/General Scans_LTE band66_T-Coil_HAC_OTT/z (axial) 4.2mm 50 x 50/ABM

Interpolated SNR(x,y,z) (121x121x1): Interpolated grid: dx=1.000 mm, dy=1.000 mm

Signal Type: Audio File (.wav) 48k_voice_1kHz_1s.wav

Output Gain: 19.75

Measure Window Start: 300ms

Measure Window Length: 1000ms

BWC applied: 0.14 dB

Device Reference Point: 0, 0, -6.3 mm

Cursor:

ABM1/ABM2 = 51.01 dB

ABM1 comp = 4.01 dBA/m

BWC Factor = 0.14 dB

Location: 4.2, 3.3, 3.7 mm

T-Coil scan (scan for ANSI C63.19-2011 compliance)/General Scans_LTE band66_T-Coil_HAC_OTT/z (axial) wideband at best

S/N/ABM Freq Resp(x,y,z,f) (1x1x1): Measurement grid: dx=10mm, dy=10mm

Signal Type: Audio File (.wav) 48k_voice_300-3000_2s.wav

Output Gain: 38.48

Measure Window Start: 300ms

Measure Window Length: 2000ms

BWC applied: 10.77 dB

Device Reference Point: 0, 0, -6.3 mm

Cursor:

Diff = 1.92 dB

BWC Factor = 10.77 dB

Location: 4.2, 3.5, 3.7 mm

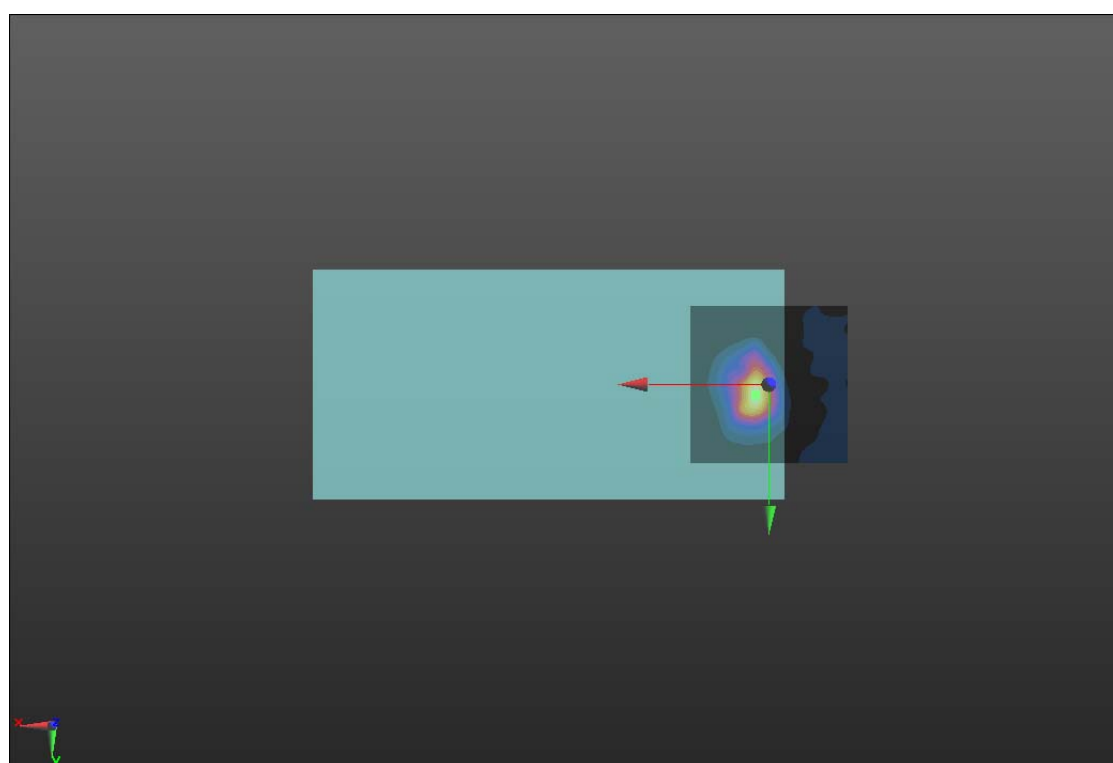

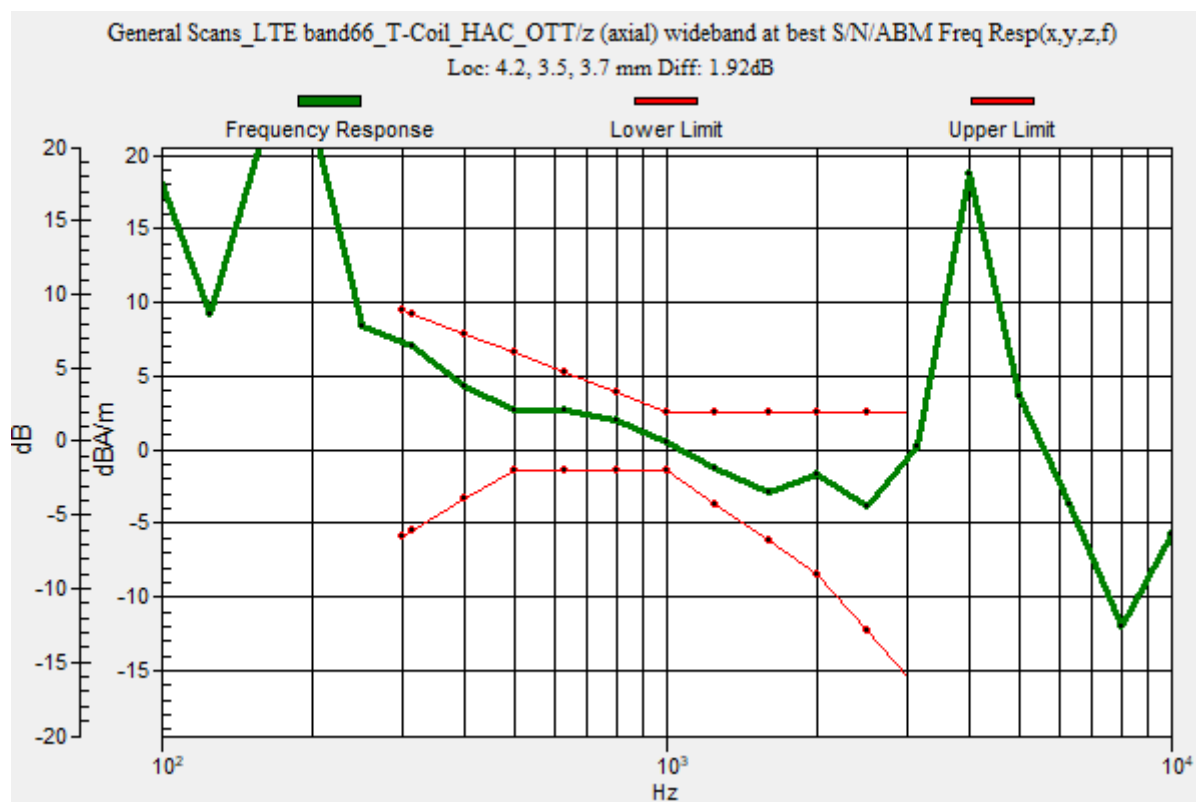

WIFI 2.4G 802.11b	Axial Y
<p>Communication System: UID 0, WIFI 2.4GHz (0); Frequency: 2437 MHz; Medium parameters used: $\sigma = 0$ S/m, $\epsilon_r = 1$; $\rho = 0$ kg/m³ Phantom section: TCoil Section</p>	
<p>DASY5 Configuration:</p> <ul style="list-style-type: none"> Probe: AM1DV2 - 1021; ; Calibrated: 10/22/2020 Sensor-Surface: 0mm (Fix Surface) Electronics: DAE4 Sn720; Calibrated: 9/30/2020 Phantom: HAC Test Arch with AMCC; Type: SD HAC P01 BA; Measurement SW: DASY52, Version 52.10 (4); SEMCAD X Version 14.6.14 (7483) 	
<p>T-Coil scan (scan for ANSI C63.19-2011 compliance)/General Scans_WIFI 2.4G 802.11b_T-Coil_HAC_OTT/y (transversal) 4.2mm 50 x 50/ABM Interpolated SNR(x,y,z) (121x121x1): Interpolated grid: dx=1.000 mm, dy=1.000 mm Signal Type: Audio File (.wav) 48k_voice_1kHz_1s.wav Output Gain: 19.75 Measure Window Start: 300ms Measure Window Length: 1000ms BWC applied: 0.13 dB Device Reference Point: 0, 0, -6.3 mm</p>	
<p>Cursor: ABM1/ABM2 = 41.95 dB ABM1 comp = -11.83 dBA/m BWC Factor = 0.13 dB Location: -2.9, 25, 3.7 mm</p>	

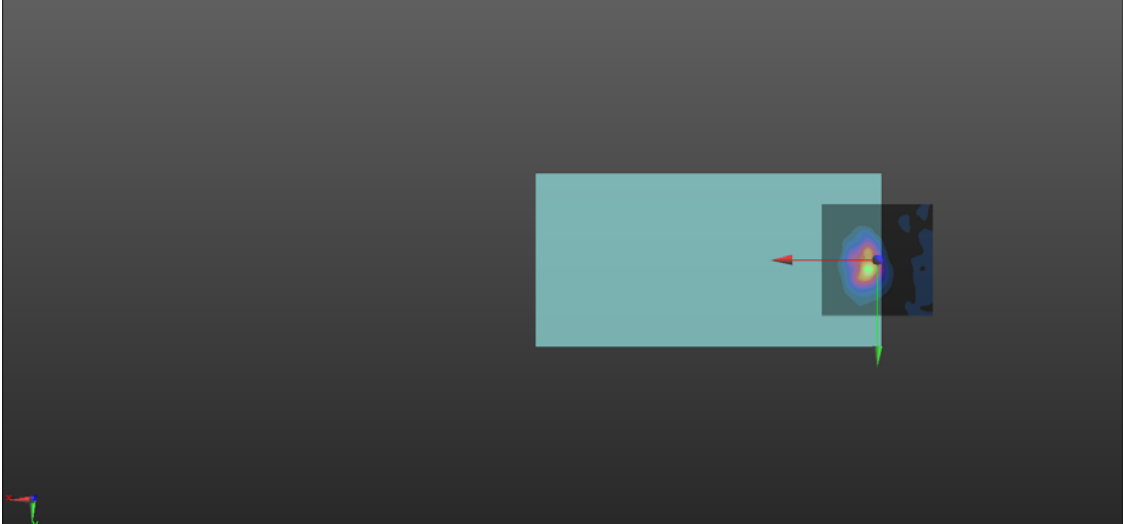
WIFI 2.4G 802.11b	Axial Z & Frequency Resp.
<p>Communication System: UID 0, WIFI 2.4GHz (0); Frequency: 2437 MHz; Medium parameters used: $\sigma = 0$ S/m, $\epsilon_r = 1$; $\rho = 0$ kg/m³ Phantom section: TCoil Section</p>	
<p>DASY5 Configuration:</p> <ul style="list-style-type: none"> • Probe: AM1DV2 - 1021; ; Calibrated: 10/22/2020 • Sensor-Surface: 0mm (Fix Surface) • Electronics: DAE4 Sn720; Calibrated: 9/30/2020 • Phantom: HAC Test Arch with AMCC; Type: SD HAC P01 BA; • Measurement SW: DASY52, Version 52.10 (4); SEMCAD X Version 14.6.14 (7483) 	
<p>T-Coil scan (scan for ANSI C63.19-2011 compliance)/General Scans_WIFI 2.4G 802.11b_T-Coil_HAC_OTT/z (axial) 4.2mm 50 x 50/ABM Interpolated SNR(x,y,z) (121x121x1): Interpolated grid: dx=1.000 mm, dy=1.000 mm Signal Type: Audio File (.wav) 48k_voice_1kHz_1s.wav Output Gain: 19.75 Measure Window Start: 300ms Measure Window Length: 1000ms BWC applied: 0.13 dB Device Reference Point: 0, 0, -6.3 mm</p>	
<p>Cursor: ABM1/ABM2 = 52.72 dB ABM1 comp = 4.80 dBA/m BWC Factor = 0.13 dB Location: 4.2, 4.2, 3.7 mm</p>	
<p>T-Coil scan (scan for ANSI C63.19-2011 compliance)/General Scans_WIFI 2.4G 802.11b_T-Coil_HAC_OTT/z (axial) wideband at best S/N/ABM Freq Resp(x,y,z,f) (1x1x1): Measurement grid: dx=10mm, dy=10mm Signal Type: Audio File (.wav) 48k_voice_300-3000_2s.wav Output Gain: 38.48 Measure Window Start: 300ms Measure Window Length: 2000ms BWC applied: 10.77 dB Device Reference Point: 0, 0, -6.3 mm</p>	
<p>Cursor: Diff = 0.75 dB BWC Factor = 10.77 dB Location: 4.1, 4.2, 3.7 mm</p>	
	

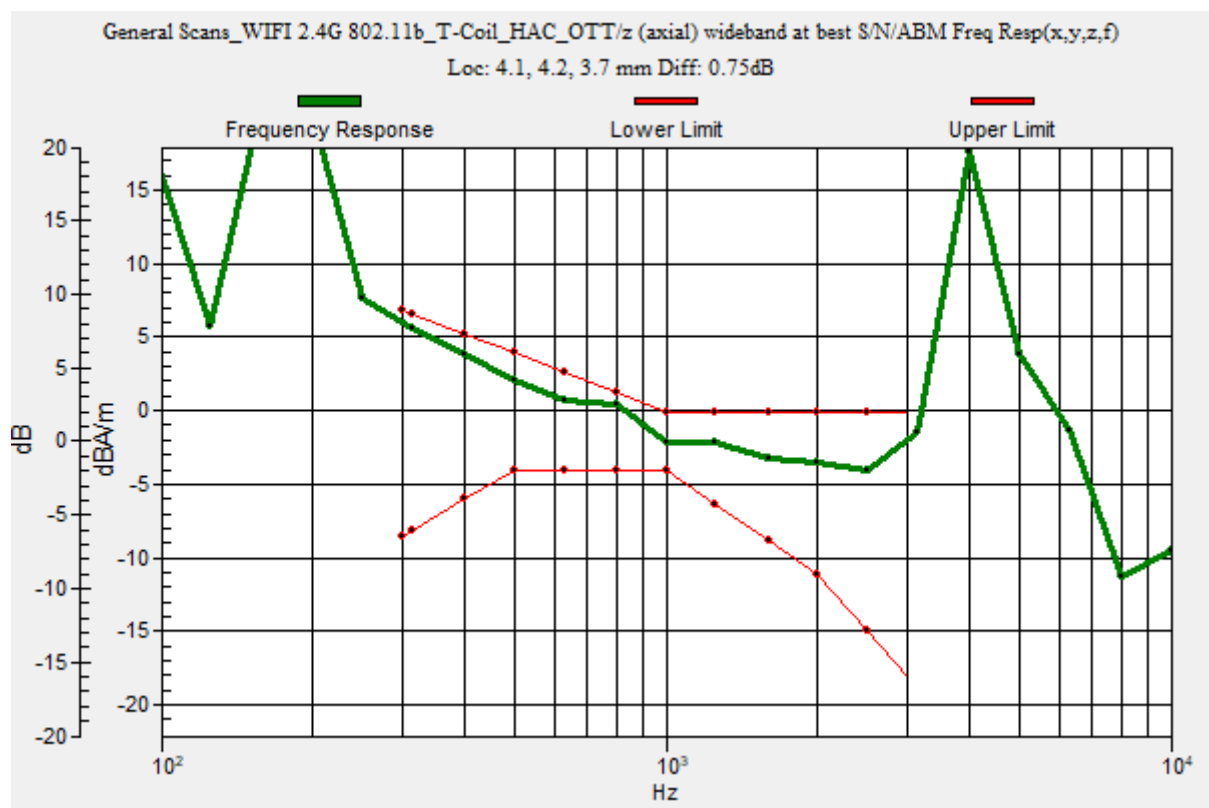

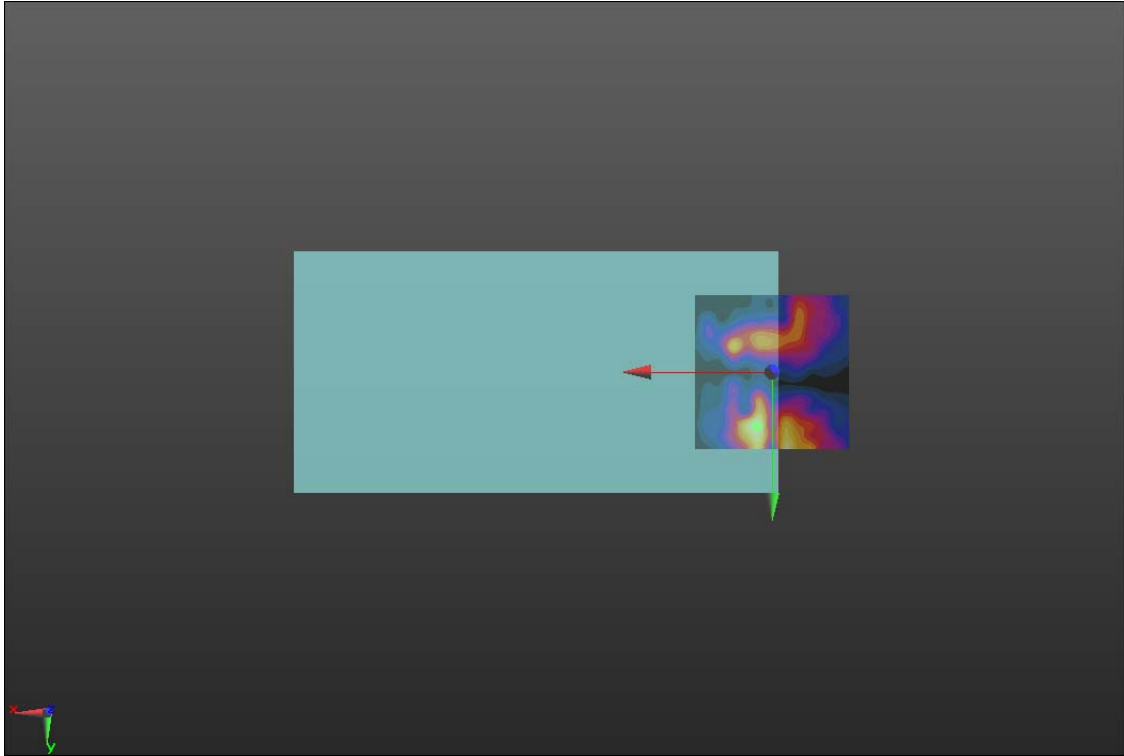
WIFI5GHz U-NII-1 802.11a	Axial Y
<p>Communication System: UID 10317 - AAC, IEEE 802.11a WiFi 5 GHz (OFDM, 6 Mbps, 96pc duty cycle); Frequency: 5200 MHz; Medium parameters used: $\sigma = 0$ S/m, $\epsilon_r = 1$; $\rho = 0$ kg/m³ Phantom section: TCoil Section</p>	
<p>DASY5 Configuration:</p> <ul style="list-style-type: none"> • Probe: AM1DV2 - 1021; ; Calibrated: 10/22/2020 • Sensor-Surface: 0mm (Fix Surface) • Electronics: DAE4 Sn720; Calibrated: 9/30/2020 • Phantom: HAC Test Arch with AMCC; Type: SD HAC P01 BA; • Measurement SW: DASY52, Version 52.10 (4); SEMCAD X Version 14.6.14 (7483) 	
<p>T-Coil scan (scan for ANSI C63.19-2011 compliance)/General Scans_WIFI 5G UNII-1 802.11a_T-Coil_HAC_OTT-1/y (transversal) 4.2mm 50 x 50/ABM Interpolated SNR(x,y,z) (121x121x1): Interpolated grid: dx=1.000 mm, dy=1.000 mm Signal Type: Audio File (.wav) 48k_voice_1kHz_1s.wav Output Gain: 19.75 Measure Window Start: 300ms Measure Window Length: 1000ms BWC applied: 0.13 dB Device Reference Point: 0, 0, -6.3 mm</p>	
<p>Cursor: ABM1/ABM2 = 40.20 dB ABM1 comp = -1.78 dBA/m BWC Factor = 0.13 dB Location: 5, 17.5, 3.7 mm</p>	
	

WIFI5GHz U-NII-1 802.11a	Axial Z & Frequency Resp.
<p>Communication System: UID 10317 - AAC, IEEE 802.11a WiFi 5 GHz (OFDM, 6 Mbps, 96pc duty cycle); Frequency: 5200 MHz; Medium parameters used: $\sigma = 0$ S/m, $\epsilon_r = 1$; $\rho = 0$ kg/m³ Phantom section: TCoil Section</p>	
<p>DASY5 Configuration:</p> <ul style="list-style-type: none"> • Probe: AM1DV2 - 1021; ; Calibrated: 10/22/2020 • Sensor-Surface: 0mm (Fix Surface) • Electronics: DAE4 Sn720; Calibrated: 9/30/2020 • Phantom: HAC Test Arch with AMCC; Type: SD HAC P01 BA; • Measurement SW: DASY52, Version 52.10 (4); SEMCAD X Version 14.6.14 (7483) 	
<p>T-Coil scan (scan for ANSI C63.19-2011 compliance)/General Scans_WIFI 5G UNII-1 802.11a_T-Coil_HAC_OTT-1/z (axial) 4.2mm 50 x 50/ABM Interpolated SNR(x,y,z) (121x121x1): Interpolated grid: dx=1.000 mm, dy=1.000 mm Signal Type: Audio File (.wav) 48k_voice_1kHz_1s.wav Output Gain: 19.75 Measure Window Start: 300ms Measure Window Length: 1000ms BWC applied: 0.13 dB Device Reference Point: 0, 0, -6.3 mm</p>	
<p>Cursor: ABM1/ABM2 = 50.53 dB ABM1 comp = 3.09 dBA/m BWC Factor = 0.13 dB Location: 3.8, 4.2, 3.7 mm</p>	
<p>T-Coil scan (scan for ANSI C63.19-2011 compliance)/General Scans_WIFI 5G UNII-1 802.11a_T-Coil_HAC_OTT-1/z (axial) wideband at best S/N/ABM Freq Resp(x,y,z,f) (1x1x1): Measurement grid: dx=10mm, dy=10mm Signal Type: Audio File (.wav) 48k_voice_300-3000_2s.wav Output Gain: 38.48 Measure Window Start: 300ms Measure Window Length: 2000ms BWC applied: 10.77 dB Device Reference Point: 0, 0, -6.3 mm</p>	
<p>Cursor: Diff = 1.35 dB BWC Factor = 10.77 dB Location: 3.7, 4.2, 3.7 mm</p>	
