TEST REPORT FOR HAC RF Emission

Report No.: SRTC2021-9004(F)-21070201(J)

Product Name: LTE/WCDMA/GSM Multi-Mode Digital Mobile

PhoneProduct Model: Z5158

Applicant: ZTE Corporation.

Manufacturer: ZTE Corporation.

Specification: FCC Part 20.19

ANSI C63.19

FCC ID: SRQ-Z5158

The State Radio_monitoring_center Testing Center (SRTC)

15th Building, No.30, Shixing Street, Shijingshan District, Beijing, P.R.China

Tel: 86-10-57996183 Fax: 86-10-57996388

Contents

1 GENERAL INFORMATION	2
1.1 Notes of the test report	2
1.2 Information about the testing laboratory	2
1.3 Applicant’s details	2
1.4 Manufacturer’s details	2
1.5 Test Environment	3
2 DESCRIPTION OF THE DEVICE UNDER TEST	4
2.1 Final Equipment Build Status	4
2.2 Support Equipment	5
3 REFERENCE SPECIFICATION	5
4 TEST CONDITIONS	6
4.1 Test Signal, Frequencies, and Output Power	6
4.2 Device Holder	6
4.3 Validation of the system	7
4.3.1 System check description	7
4.3.2 System validation E-field result	8
5 RESULT SUMMAR	9
6 AVERAGE ANTENNA INPUT POWER & EVALUATION FOR LOW-POWER EXEMPTION	10
7 AIR INTERFACES AND OPERATING MODE	12
8 MODULATION INTERFERENCE FACTOR (MIF)	13
9 HAC RF EMISSIONS TEST PROCEDURE	15
10 RF EMISSIONS MEASUREMENT CRITERIA	18
11 HAC RF EMISSIONS TEST RESULTS	19
12 MEASUREMENT UNCERTAINTY	20
13 TEST EQUIPMENTS	21
ANNEX A: SYSTEM CHECK	23
ANNEX B: TEST PLOT	26

1 GENERAL INFORMATION

1.1 Notes of the test report

The test report may only be reproduced or published in full. Reproduction or publication of extracts from the report requires the prior written permission of The State Radio_monitoring_center Testing Center (SRTC).

The test results relate only to individual items of the samples which have been tested.

The certification and accreditation identifiers used in this report shall not be applicable to the tested or calibrated samples thereof. The manufacturer shall not mark the tested samples or items (or a separate part of the item) with the identifiers of certification and accreditation to mislead relevant parties about the tested samples or items.

1.2 Information about the testing laboratory

Company:	The State Radio_monitoring_center Testing Center (SRTC)
Address:	15th Building, No.30 Shixing Street, Shijingshan District, Beijing P.R.China
City:	Beijing
Country or Region:	P.R.China
Contacted person:	Liu Jia
Tel:	+86 10 57996183
Fax:	+86 10 57996388
Email:	liujiaf@srtc.org.cn
Registration number	239125

1.3 Applicant's details

Company:	ZTE Corporation.
Address:	ZTE Plaza, Keji Road South, Hi-Tech, Industrial Park, Nanshan District ,Shenzhen, Guangdong, P.R.China
City:	Shenzhen
Country or Region:	China
Contacted person:	Gong Yu
Tel:	021-68895397
Email:	gongyu@zte.com.cn

1.4 Manufacturer's details

Company:	ZTE Corporation.
Address:	ZTE Plaza, Keji Road South, Hi-Tech, Industrial Park, Nanshan District, Shenzhen, Guangdong, P.R.China
City:	Shenzhen
Country or Region:	China
Contacted person:	Gong Yu
Tel:	021-68895397
Email:	gongyu@zte.com.cn

1.5 Test Environment

Date of Receipt of test sample at SRTC:	2021.07.02
Testing Start Date:	2021.07.20
Testing End Date:	2021.07.26

Environmental Data:	Temperature(°C)	Humidity (%)
Ambient	22~23	32~37

Normal Supply Voltage (V d.c.):	4
---------------------------------	---

2 DESCRIPTION OF THE DEVICE UNDER TEST

2.1 Final Equipment Build Status

Wireless Technology and Frequency Bands	<input checked="" type="checkbox"/> GSM Band: GSM850/PCS1900 <input checked="" type="checkbox"/> WCDMA Band: FDD2/4/5 <input checked="" type="checkbox"/> LTE Band: 2/4/5/12/41/66/71 <input checked="" type="checkbox"/> Bluetooth Band: 2.4GHz <input checked="" type="checkbox"/> Wi-Fi Band: 2.4GHz
Mode	GSM <input checked="" type="checkbox"/> Voice (GMSK) <input checked="" type="checkbox"/> GPRS (GMSK) <input checked="" type="checkbox"/> EGPRS (GMSK/8PSK) WCDMA <input checked="" type="checkbox"/> UMTS Rel. 99 (Voice & Data) <input checked="" type="checkbox"/> HSDPA (Rel. 5) <input checked="" type="checkbox"/> HSUPA (Rel. 6) <input checked="" type="checkbox"/> HSPA+ (Rel.7) <input checked="" type="checkbox"/> DC-HSDPA (Rel.8) Wi-Fi 2.4G (802.11b/g/n/ax) <input checked="" type="checkbox"/> 802.11b <input checked="" type="checkbox"/> 802.11g <input checked="" type="checkbox"/> 802.11n (20MHz) <input type="checkbox"/> 802.11ax (20MHz) Wi-Fi5GHz <input type="checkbox"/> 802.11a <input type="checkbox"/> 802.11n (20MHz/40MHz) <input type="checkbox"/> 802.11ac (20MHz/40MHz/80MHz) <input type="checkbox"/> 802.11ax (20MHz/40MHz/80MHz) Bluetooth <input checked="" type="checkbox"/> BR(GFSK) <input checked="" type="checkbox"/> EDR($\pi/4$ DQPSK , 8-DPSK) <input checked="" type="checkbox"/> BLE(GFSK) LTE <input checked="" type="checkbox"/> QPSK <input checked="" type="checkbox"/> 16QAM <input checked="" type="checkbox"/> 64QAM

2.2 Support Equipment

The following support equipment was used to exercise the DUT during testing:

State of sample	LTE/WCDMA Multi-Mode Digital Mobile Phone
Batteries	Jiade Energy Technology(zhuhai) CO., LTD
H/W Version	Z5158HW1.0
S/W Version	Z5158_CCv1.0.0B01
IMEI	865748050004561
Normal	operation
Back	The Back Cover is removable
Notes	---

3 REFERENCE SPECIFICATION

Specification	Version	Title
Part 20.19	2020	Hearing aid-compatible mobile handsets.
C63.19	2011	American National Standard Methods of Measurement of Compatibility between Wireless Communications Devices and Hearing Aids
285076 D01	v05r01 2020	EQUIPMENT AUTHORIZATION GUIDANCE FOR HEARING AID COMPATIBILITY

4 TEST CONDITIONS

4.1 Test Signal, Frequencies, and Output Power

The transmitter of the device was put into operation by using a call tester communications between the device and the call tester were established by air link.

For all tests the device output power was set to maximum power level; a fully charged battery was used for every test sequence.

The measurements were performed on low, middle, high channels.

4.2 Device Holder

The Device Holder and Test Arch are manufactured by Speag, Test arch is used for all tests i.e. for both validation testing and device testing. The holder and test arch conforms to requirements of ANSI C63.19.

The SPEAG device holder was used to position the test device in all tests.



4.3 Validation of the system

4.3.1 System check description

The input signal was an unmodulated continuous wave. The following points were taken into consideration in performing this check :

- Average Input Power $P=100\text{mW}$ RMS(20dBm RMS) after adjustment for return loss
- The test fixture must meet the 2 wavelength separation criterion
- The proper measurement of the 15 mm probe to dipole separation , which is measured from top surface of the dipole to the calibration reference point of the sensor , defined by probe manufacturer is shown in the following diagram:

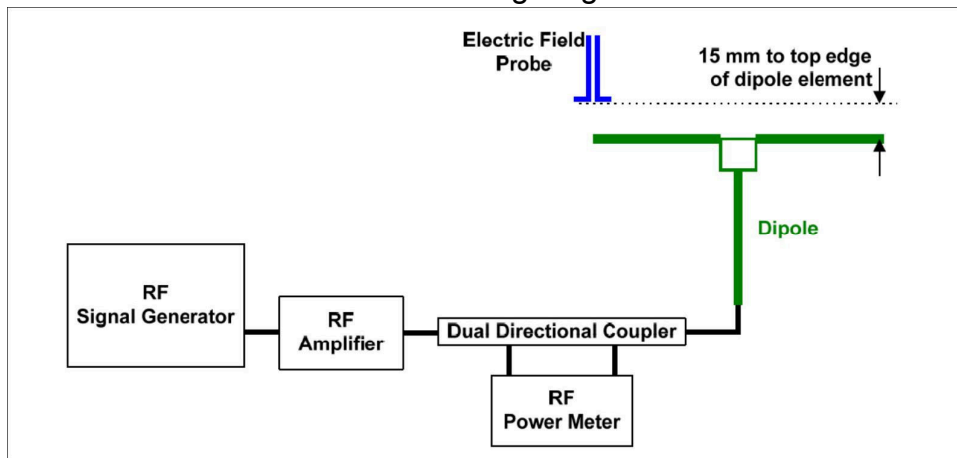

Separation distance from dipole to field-probe

Scan the length of the dipole with the E-field probe and record the two maximum values found near the dipole ends. Average the two readings and compare the reading to the expected value in the calibration certificate or the expected value in this standard.

4.3.2 System validation E-field result



Date	f(MHz)	Input power (mW)	Max. measured from		Average	E-field Target Values (From SPEAG)	Deviation (%)
			E-Field above high end (V/m)	E-Field above low end (V/m)	V/m	V/m	
2021/07/20	835	100	110.15	110.15	110.15	107.7	2.3
2021/07/23	1880	100	90.05	88.21	89.13	86.4	3.2
2021/07/26	2450	100	92.04	83.85	87.95	84.3	4.3

Notes:

- 1) Deviation = ((Average E-field Value) – (Target value)) / (Target value) * 100%. Deltas within ±25% are acceptable, of which 12% is deviation and 13% is measurement uncertainty.
- 2) The maximum E-field was evaluated and compared to the target values provided by SPEAG in the calibration certificate of specific dipoles.
- 3) dBV/m convert to V/m for example : $40.84 \text{ dBV/m} = 10^{(40.84/20)} = 110.15 \text{ V/m}$
- 4) Please refer to the appendix for detailed measurement data and plots. Plots of the system validation scans are given in Appendix A

5 RESULT SUMMARY

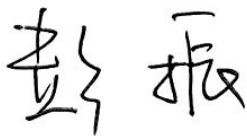
Band	E-Field M Rating	Pass/Fail
GSM(850/1900)	M4	PASS
TDD-LTE Band41 (Power Class2/3)	M4	PASS
FDD-LTE(Band 2/4/5/12/66/71)	These applicable air-interfaces are exempt from testing in accordance with C63.19 Clause 4.4 and rated M4.	PASS
Final M Category	M4	PASS

This Test Report Is Approved by: Mr. Peng Zhen 	Review by: Mr. Li Bin 
Tested by: Ms.LiJlin 	Issued date: 2021.08.02

6 AVERAGE ANTENNA INPUT POWER & EVALUATION FOR LOW-POWER EXEMPTION

Full power without any sensor scheme active (adjust to tune up tolerance)

Air-Interface		Max Interface Average Antenna Input Power (dBm)	Worst Case MIF (dB)	Input Power plus its MIF (dBm)	HAC Tested
GSM 850		26.00	3.63	29.63	YES
GSM 1900		22.50	3.63	26.13	YES
WCDMA II		20.50	-27.23	-6.73	NO
WCDMA IV		24.00	-27.23	-3.23	NO
WCDMA V		24.00	-27.23	-3.23	NO
LTE Band 2		24.00	-9.76	14.24	NO
LTE Band 4		24.00	-9.76	14.24	NO
LTE Band 5		24.50	-9.76	14.74	NO
LTE Band 12		24.00	-9.76	14.24	NO
LTE Band 41 PC2	QPSK	26.50	-1.62	24.88	YES
	16QAM	26.00	-1.44	24.56	YES
	64QAM	25.00	-1.54	23.46	YES
LTE Band 41 PC3	QPSK	23.50	-1.62	21.88	YES
	16QAM	23.00	-1.44	21.56	YES
	64QAM	22.00	-1.54	20.46	YES
LTE Band 66		24.00	-9.76	14.24	NO
LTE Band 71		24.00	-9.76	14.24	NO
802.11b 2.4GHz		16.00	-2.02	13.98	NO
802.11g 2.4GHz		13.00	0.12	13.12	NO
802.11n-HT20 2.4GHz		11.00	-5.61	5.39	NO

Note:

1): TDD 16QAM/64QAM are not necessary due to TDD QPSK with class2 (HPUE) is the worst case. both MIF and conducted power for each modulation are very similar and we list these three modulation types.

2): According to ANSI C63.19, a device is exempt from testing when its average antenna input power plus its MIF is ≤ 17 dBm for any of its operating modes. If a device supports multiple RF air interfaces, each RF air interface shall be evaluated individually.

3): HAC RF rating is M4 for the air interface which meets the low power exemption.

7 AIR INTERFACES AND OPERATING MODE

Air interface	Bands (MHz)	Type	ANSI C63.19 Tested	Simultaneous Transmitter	Voice Service	Power Reduction
GSM	850	VO	YES	WLAN, BT	CMRS Voice	NA
	1900					NA
GPRS/EDGE	850	VD	YES		NA	NA
	1900					NA
WCDMA (UMTS)	Band 2/4/5	VO	YES	WLAN, BT	CMRS Voice	NA
HSPA+	Band 2/4/5	VD	YES		NA	NA
LTE (FDD)	Band2/4/5/12/66/71	VO	YES	WLAN, BT	VoLTE	NA
	Band2/4/5/7/12/66/71	VD	YES	WLAN, BT	NA	NA
LTE (TDD)	Band41	VO	YES	WLAN, BT	VoLTE	NA
	Band41	VD	YES	WLAN, BT	NA	NA
WLAN	2.4GHz	VO	YES	WWAN	VoWiFi	NA
	2.4GHz	VD	YES	WWAN	NA	NA
BT	2.4G	DT	NA	WWAN, WLAN	NA	NA

Abbreviation Type

VO=CMRS Voice Service

DT = Digital Transport only

VD= IP Voice Service over Digital Transport

BT=Bluetooth (include BLE)

8 MODULATION INTERFERENCE FACTOR (MIF)

The HAC Standard ANSI C63.19 defines a new scaling using the Modulation Interference Factor (MIF) which replaces the need for the Articulation Weighting Factor (AWF) during the evaluation and is applicable to any modulation scheme.

The Modulation Interference factor (MIF, in dB) is added to the measured average E-field (in dBV/m) and converts it to the RF Audio Interference level (in dBV/m). This level considers the audible amplitude modulation components in the RF E-field. CW fields without amplitude modulation are assumed to not interfere with the hearing aid electronics. Modulations without time slots and low fluctuations at low frequencies have low MIF values, TDMA modulations with narrow transmission and repetition rates of few 100 Hz have high MIF values and give similar classifications as ANSI C63-19. Definitions ER3D, E-field probes have a bandwidth <10 kHz and can therefore not evaluate the RF envelope in the full audio band. DASY52 is therefore using the “indirect” measurement method according to ANSI C63.19 which is the primary method. These near field probes read the averaged E-field measurement. Especially for the new high peak-to-average (PAR) signal types, the probes shall be linearized by probe modulation response (PMR) calibration in order to not overestimate the field reading.

The evaluation method of the MIF is defined in ANSI C63.19 section D.7. An RMS demodulated RF signal is fed to a spectral filter (similar to an A weighting filter) and forwarded to a temporal filter acting as a quasi-peak detector. The averaged output of these filtering is called to a 1 kHz 80% AM signal as reference. MIF measurement requires additional instrumentation and is not well suited for evaluation by the end user with reasonable uncertainty. It may alternatively be determined through analysis and simulation, because it is constraint and characteristic for a communication signal. DASY52 uses well defined signals for PMR calibration. The MIF of these signals has been determined by simulation and is automatically applied.

MIF values were not tested by a probe or as specified in the standards but are based on analysis provided by SPEAG for all the air interfaces (GSM, WCDMA, CDMA, LTE, WIFI).

MIF values applied in this test report were provided by the HAC equipment provider of SPEAG, and the values for all air interfaces are listed below to determine the Low-power Exemption.

SPEAG test files		
UID	Communication system name	MIF(dB)
10021	GSM-FDD(TDMA,GMSK)	3.63
10011	UMTS-FDD (WCDMA)	-27.23
10170	LTE-FDD (SC-FDMA, 1 RB, 20 MHz, 16-QAM)	-9.76
10182	LTE-FDD (SC-FDMA, 1 RB, 15 MHz, 16-QAM)	-9.76
10176	LTE-FDD (SC-FDMA, 1 RB, 10 MHz, 16-QAM)	-9.76
10172	LTE-TDD (SC-FDMA, 1 RB, 20 MHz, QPSK)	-1.62
10173	LTE-TDD (SC-FDMA, 1 RB, 20 MHz, 16-QAM)	-1.44
10174	LTE-TDD (SC-FDMA, 1 RB, 20 MHz, 64QAM)	-1.54
10061	IEEE 802.11b WiFi 2.4 GHz (DSSS, 11 Mbps)	-2.02
10069	IEEE 802.11a/h WiFi 5 GHz (OFDM, 54 Mbps)	-3.15
10077	IEEE 802.11g WiFi 2.4 GHz (DSSS/OFDM, 54 Mbps)	0.12
10591	IEEE 802.11n (HT Mixed, 20MHz, MCS0, 90pc duty cycle)	-5.59
10599	IEEE 802.11n (HT Mixed, 40MHz, MCS0, 90pc duty cycle)	-5.59
10607	IEEE 802.11ac WiFi (20MHz, MCS0, 90pc duty cycle)	-5.60
10616	IEEE 802.11ac WiFi (40MHz, MCS0, 90pc duty cycle)	-5.57
10626	IEEE 802.11ac WiFi (80MHz, MCS0, 90pc duty cycle)	-5.64

Note: The nominal MIF values for PMR calibration waveforms has been determined from sampled RF signals with numerical evaluation. AIA measurements were used to verify these results. The correlation allows to quantify the uncertainty of the nominal MIF: **0.2 dB for MIF in the range -7 to +5 dB**, 0.5 dB in the range -13 to +11 dB, 1.0 dB for MIF > -20 dB. Modulation with low MIF, low modulation frequency (< 50 Hz) or high dynamic range (PAR > 10 dB) result in higher uncertainties for the measurement.

9 HAC RF EMISSIONS TEST PROCEDURE

The following are step-by-step test procedures.

- a) Confirm proper operation of the field probe, probe measurement system and other instrumentation and the positioning system.
- b) Position the WD in its intended test position.
- c) Set the WD to transmit a fixed and repeatable combination of signal power and modulation characteristic that is representative of the worst case (highest interference potential) encountered in normal use. Transiently occurring start-up, changeover, or termination conditions, or other operations likely to occur less than 1% of the time during normal operation, may be excluded from consideration.
- d) The center sub-grid shall be centered on the T-Coil mode perpendicular measurement point or the acoustic output, as appropriate. Locate the field probe at the initial test position in the 50 mm by 50 mm grid, which is contained in the measurement plane, refer to illustrated in Figure 1. If the field alignment method is used, align the probe for maximum field reception.
- e) Record the reading at the output of the measurement system
- f) Scan the entire 50 mm by 50 mm region in equally spaced increments and record the reading at each measurement point. The distance between measurement points shall be sufficient to assure the identification of the maximum reading.
- g) Identify the five contiguous sub-grids around the center sub-grid whose maximum reading is the lowest of all available choices. This eliminates the three sub-grids with the maximum readings. Thus, the six areas to be used to determine the WD's highest emissions are identified.
- h) Identify the maximum reading within the non-excluded sub-grids identified in step g).
- i) Convert the highest field reading within identified in step h) to RF audio interference level, in V/m, by taking the square root of the reading and then dividing it by the measurement system transfer function, established in 5.5.1.1 Convert this result to dB(V/m) by taking the base-10 logarithm and multiplying by 20.

Indirect measurement method

Replacing step i), the RF audio interference level in dB (V/m) is obtained by adding the MIF (in dB) to the maximum steady-state rms field-strength reading, in dB (V/m), from step h).

Use this result to determine the category rating

- j) Compare this RF audio interference level with the categories in Clause 8 (ANSI C63.19) and record the resulting WD category rating
- k) For the T-Coil mode M-rating assessment, determine whether the chosen perpendicular measurement point is contained in an included sub-grid of the first scan. If so, then a second scan is not necessary. The first scan and resultant category rating may be used for the T-Coil mode M rating.



WD reference and plane for RF emission measurements

Test Instructions

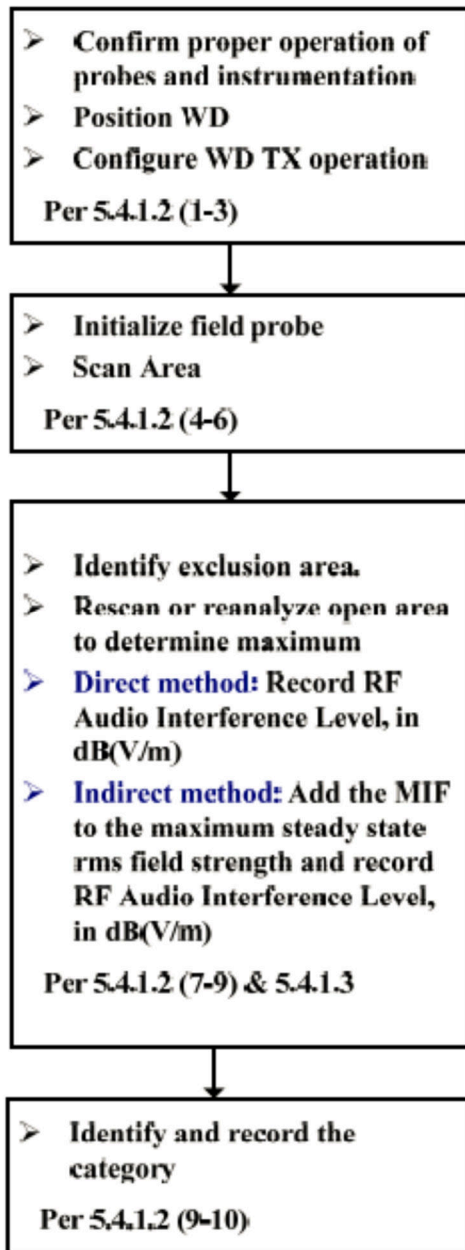

Test flowchart Per ANSI-C63.19

10 RF EMISSIONS MEASUREMENT CRITERIA

WD RF audio interference level categories in logarithmic units

Emission categories	<960 MHz	
	E-field emissions	
Category M1	50 to 55	dB (V/m)
Category M2	45 to 50	dB (V/m)
Category M3	40 to 45	dB (V/m)
Category M4	<40	dB (V/m)

Emission categories	>960 MHz	
	E-field emissions	
Category M1	40 to 45	dB (V/m)
Category M2	35 to 40	dB (V/m)
Category M3	30 to 35	dB (V/m)
Category M4	<30	dB (V/m)

11 HAC RF EMISSIONS TEST RESULTS

Air-interface	Mode	Channel	E-Field (dBV/m)	E-Field plus 0.2db measurement Uncertainty (dBV/m)*	M-Rating
GSM850	GSM-FDD (TDMA,GMSK)	128	37.09	37.29	M4
		189	36.35	36.55	M4
		251	37.06	37.26	M4
GSM1900		512	27.57	27.77	M4
		661	29.38	29.58	M4
		810	28.04	28.24	M4
LTE Band41 (power class 2)	LTE-TDD (SC-FDMA, 1 RB, 20 MHz, QPSK)	39750	23.04	23.24	M4
		40620	22.02	22.22	M4
		41490	23.31	23.51	M4

Note:

1): The following MIF values used for each communication system in this report, and 0.2 dB uncertainty for MIF in the range -7 to +5 dB

Mode	MIF
GSM-FDD(TDMA,GMSK)	3.63
LTE-TDD (SC-FDMA, 1 RB, 20 MHz, QPSK)	-1.62

2): The HAC measurement system applies MIF value onto the measured RMS E-field, which is indirect method in ANSI C63.19 version, and reports the RF audio interference level.

3): Phone Condition: Mute on; Backlight off; Max Volume.

4): LTE Band41 with power class 3 is not the worst case. Power class 2 with M4 could fulfill power class 3.

5): Testing for all UL CA is not required because it uses same Tx band, modulations, and output power is equal or less than non-CA modes.

6): For GSM bands, EDGE modes were not evaluated as Voice modes were found to the worst case modes for the GSM air interface.

12 MEASUREMENT UNCERTAINTY

HAC Uncertainty Budget According to ANSI C63.19 [1], [2]							
Error Description	Uncert. value	Prob. Dist.	Div.	(c ₁) E	(c ₁) H	Std. Unc. E	Std. Unc. H
Measurement System							
Probe Calibration	±5.1 %	N	1	1	1	±5.1 %	±5.1 %
Axial Isotropy	±4.7 %	R	$\sqrt{3}$	1	1	±2.7 %	±2.7 %
Sensor Displacement	±16.5 %	R	$\sqrt{3}$	1	0.145	±9.5 %	±1.4 %
Boundary Effects	±2.4 %	R	$\sqrt{3}$	1	1	±1.4 %	±1.4 %
Phantom Boundary Effect	±7.2 %	R	$\sqrt{3}$	1	0	±4.1 %	±0.0 %
Linearity	±4.7 %	R	$\sqrt{3}$	1	1	±2.7 %	±2.7 %
Sealing with PMR calibration	±10.0 %	R	$\sqrt{3}$	1	1	±5.8 %	±5.8 %
System Detection Limit	±1.0 %	R	$\sqrt{3}$	1	1	±0.6 %	±0.6 %
Readout Electronics	±0.3 %	N	1	1	1	±0.3 %	±0.3 %
Response Time	±0.8 %	R	$\sqrt{3}$	1	1	±0.5 %	±0.5 %
Integration Time	±2.6 %	R	$\sqrt{3}$	1	1	±1.5 %	±1.5 %
RF Ambient Conditions	±3.0 %	R	$\sqrt{3}$	1	1	±1.7 %	±1.7 %
RF Reflections	±12.0 %	R	$\sqrt{3}$	1	1	±6.9 %	±6.9 %
Probe Positioner	±1.2 %	R	$\sqrt{3}$	1	0.67	±0.7 %	±0.5 %
Probe Positioning	±4.7 %	R	$\sqrt{3}$	1	0.67	±2.7 %	±1.8 %
Extrap. and Interpolation	±1.0 %	R	$\sqrt{3}$	1	1	±0.6 %	±0.6 %
Test Sample Related							
Device Positioning Vertical	±4.7 %	R	$\sqrt{3}$	1	0.67	±2.7 %	±1.8 %
Device Positioning Lateral	±1.0 %	R	$\sqrt{3}$	1	1	±0.6 %	±0.6 %
Device Holder and Phantom	±2.4 %	R	$\sqrt{3}$	1	1	±1.4 %	±1.4 %
Power Drift	±5.0 %	R	$\sqrt{3}$	1	1	±2.9 %	±2.9 %
Phantom and Setup Related							
Phantom Thickness	±2.4 %	R	$\sqrt{3}$	1	0.67	±1.4 %	±0.9 %
Combined Std. Uncertainty						±16.3 %	±12.3 %
Expanded Std. Uncertainty on Power						±32.6 %	±24.6 %
Expanded Std. Uncertainty on Field						±16.3 %	±12.3 %

13 TEST EQUIPMENTS

The measurements were performed using an automated near-field scanning system, DASY5, manufactured by Schmid & Partner Engineering AG (SPEAG) in Switzerland.

The following table lists calibration dates of SPEAG components:

Test equipment	Model	S/N	Cal Date	Cal Due Date
DAE	DAE 4	720	2020.09.30	2021.09.29
E-field probe	ER3DV6	2368	2020.10.23	2021.10.22
Dipole	CD835V3	1106	2020.10.23	2021.10.22
Dipole	CD1880V3	1075	2020.10.23	2021.10.22
Dipole	CD2450V3	1069	2020.10.23	2021.10.22

Additional test equipment used in testing and validation:

Test equipment	Model	S/N	Cal Date	Cal Due Date
Signal generator	E4428C	MY45280865	2020.08.20	2021.08.19
Power meter	E4417A	MY45101004	2020.08.20	2021.08.19
Power sensor	E9300B	MY41496001	2020.08.20	2021.08.19
Power sensor	E9300B	MY41496003	2020.08.20	2021.08.19
Radio Tester	CMU200	114666	2020.08.20	2021.08.19
Radio Tester	CMW500	161702	2020.08.20	2021.08.19

Test Arch Phantom

The specially designed Test Arch allows high precision positioning of both the device and any of the validation dipoles.

ER3DV6 E-Field Probe Description

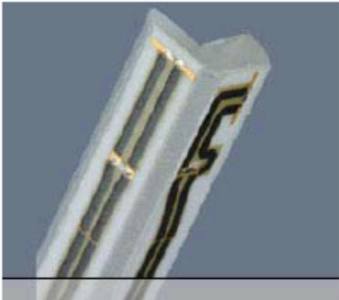
Construction:	One dipole parallel, two dipoles normal to probe axis .Built-in shielding against static charges PEEK enclosure material
Calibration:	In air from 100 MHz to 3.0 GHz (absolute accuracy $\pm 6.0\%$, k=2)
Frequency:	100 MHz to > 6 GHz; Linearity: ± 0.2 dB (100 MHz to 3 GHz)
Directivity	± 0.2 dB in air (rotation around probe axis) ± 0.4 dB in air (rotation normal to probe axis)
Dynamic Range:	2 V/m to > 1000 V/m (M3 or better device readings fall well below diode compression point)
Linearity:	± 0.2 dB
Dimensions	Overall length:330 mm (Tip: 16 mm) Tip diameter: 8 mm (Body: 12 mm) Distance from probe tip to dipole centers: 2.5 mm
Application:	General near-field measurements up to 6GHz Field component measurements Fast automatic scanning in phantoms
E-field Free-space probe	

ANNEX A: SYSTEM CHECK

System validation 835MHz

Communication System: UID 0, CW (0); Frequency: 835 MHz;
Medium parameters used: $\sigma = 0$ S/m, $\epsilon_r = 1$; $\rho = 0$ kg/m³
Phantom section: RF Section

DASY5 Configuration:

- Probe: ER3DV6 - SN2368; ConvF(1, 1, 1); Calibrated: 2020/10/23;
- Sensor-Surface: (Fix Surface)
- Electronics: DAE4 Sn720; Calibrated: 2020.09.30
- Phantom: HAC Test Arch; Type: SD HAC P01 BA;
- Measurement SW: DASY52, Version 52.8 (8); SEMCAD X Version 14.6.10 (7373)

system check 835MHz/E Scan - measurement distance from the probe sensor center to CD835 15mm/Hearing Aid Compatibility Test at 15mm distance (41x361x1): Interpolated grid: dx=0.5000 mm, dy=0.5000 mm

Device Reference Point: 0, 0, -6.3 mm

Reference Value = 111.0 V/m; Power Drift = 0.04 dB

E-field emissions = 40.84 V/m

Emission category: M4

PMF scaled E-field

Grid 1 M4 40.66 dBV/m	Grid 2 M4 40.84 dBV/m	Grid 3 M4 40.71 dBV/m
Grid 4 M4 36.55 dBV/m	Grid 5 M4 35.65 dBV/m	Grid 6 M4 36.48 dBV/m
Grid 7 M4 40.52 dBV/m	Grid 8 M4 40.84 dBV/m	Grid 9 M4 40.79 dBV/m

Cursor:

Total = 40.84 V/m

E Category: M4

Location: 0, -69.5, 9.7 mm

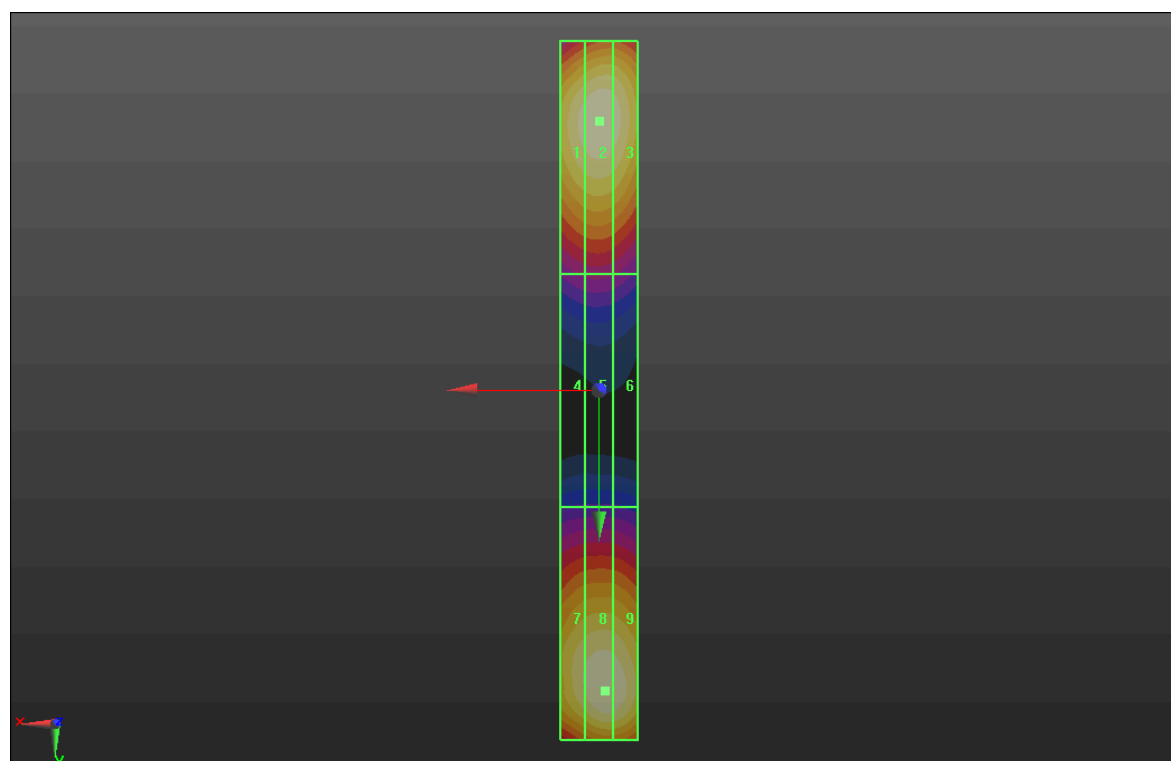
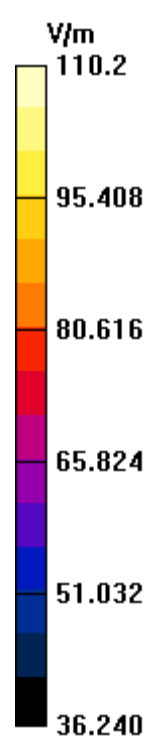

System validation 1880MHz

Communication System: UID 0, CW (0); Frequency: 1880 MHz;
Medium parameters used: $\sigma = 0$ S/m, $\epsilon_r = 1$; $\rho = 0$ kg/m³
Phantom section: RF Section

DASY5 Configuration:

- Probe: ER3DV6 - SN2368; ConvF(1, 1, 1); Calibrated: 2020/10/23;
- Sensor-Surface: (Fix Surface)
- Electronics: DAE4 Sn720; Calibrated: 2020.09.30
- Phantom: HAC Test Arch; Type: SD HAC P01 BA;
- Measurement SW: DASY52, Version 52.8 (8); SEMCAD X Version 14.6.10 (7373)

system check 1880MHz/E Scan - measurement distance from the probe sensor center to CD1880 15mm/Hearing Aid Compatibility Test at 15mm distance (41x181x1): Interpolated grid: dx=0.5000 mm, dy=0.5000 mm

Device Reference Point: 0, 0, -6.3 mm
Reference Value = 152.8 V/m; Power Drift = 0.09 dB
RF audio interference level = 39.09 dBV/m

Emission category: M2

MIF scaled E-field

Grid 1 M2 38.91 dBV/m	Grid 2 M2 39.09 dBV/m	Grid 3 M2 38.95 dBV/m
Grid 4 M2 37.1 dBV/m	Grid 5 M2 37.19 dBV/m	Grid 6 M2 37.06 dBV/m
Grid 7 M2 38.66 dBV/m	Grid 8 M2 38.91 dBV/m	Grid 9 M2 38.89 dBV/m

Cursor:

Total = 39.09 dBV/m
E Category: M2
Location: 0, -30.5, 9.7 mm

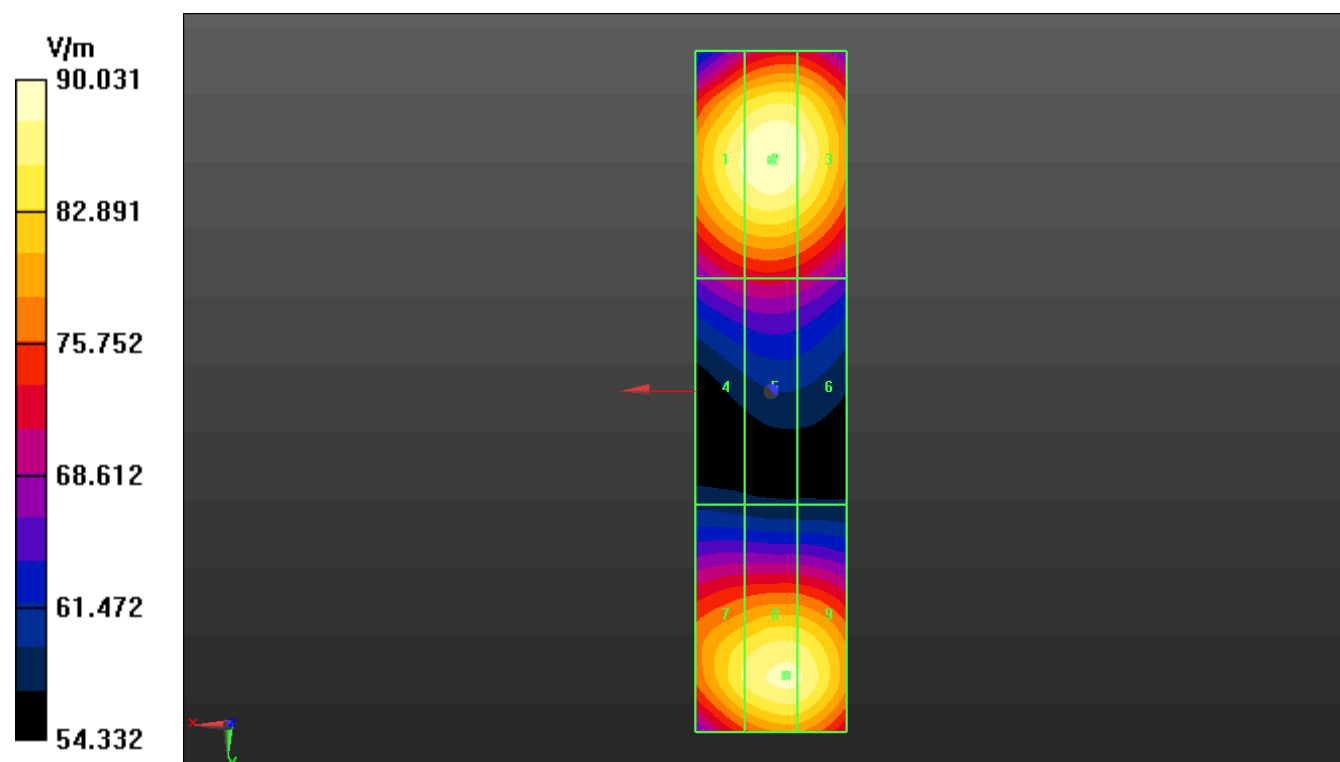

System validation 2450MHz

Communication System: UID 0, CW (0); Frequency: 2450 MHz;
Medium parameters used: $\sigma = 0$ S/m, $\epsilon_r = 1$; $\rho = 0$ kg/m³
Phantom section: RF Section

DASY5 Configuration:

- Probe: ER3DV6 - SN2368; ConvF(1, 1, 1); Calibrated: 2020/10/23;
- Sensor-Surface: (Fix Surface)
- Electronics: DAE4 Sn720; Calibrated: 2020.09.30
- Phantom: HAC Test Arch; Type: SD HAC P01 BA;
- Measurement SW: DASY52, Version 52.8 (8); SEMCAD X Version 14.6.10 (7373)

system check 2450MHz/E Scan - measurement distance from the probe sensor center to CD2450 15mm/Hearing Aid Compatibility Test at 15mm distance (41x181x1): Interpolated grid: dx=0.5000 mm, dy=0.5000 mm

Device Reference Point: 0, 0, -6.3 mm

Reference Value = 84.90 V/m; Power Drift = -0.04 dB

RF audio interference level = 39.28 dBV/m

Emission category: M2

MIF scaled E-field

Grid 1 M2 39.1 dBV/m	Grid 2 M2 39.28 dBV/m	Grid 3 M2 39.18 dBV/m
Grid 4 M2 38.71 dBV/m	Grid 5 M2 38.86 dBV/m	Grid 6 M2 38.74 dBV/m
Grid 7 M2 38.32 dBV/m	Grid 8 M2 38.47 dBV/m	Grid 9 M2 38.43 dBV/m

Cursor:

Total = 39.28 dBV/m

E Category: M2

Location: -0.5, -22, 9.7 mm

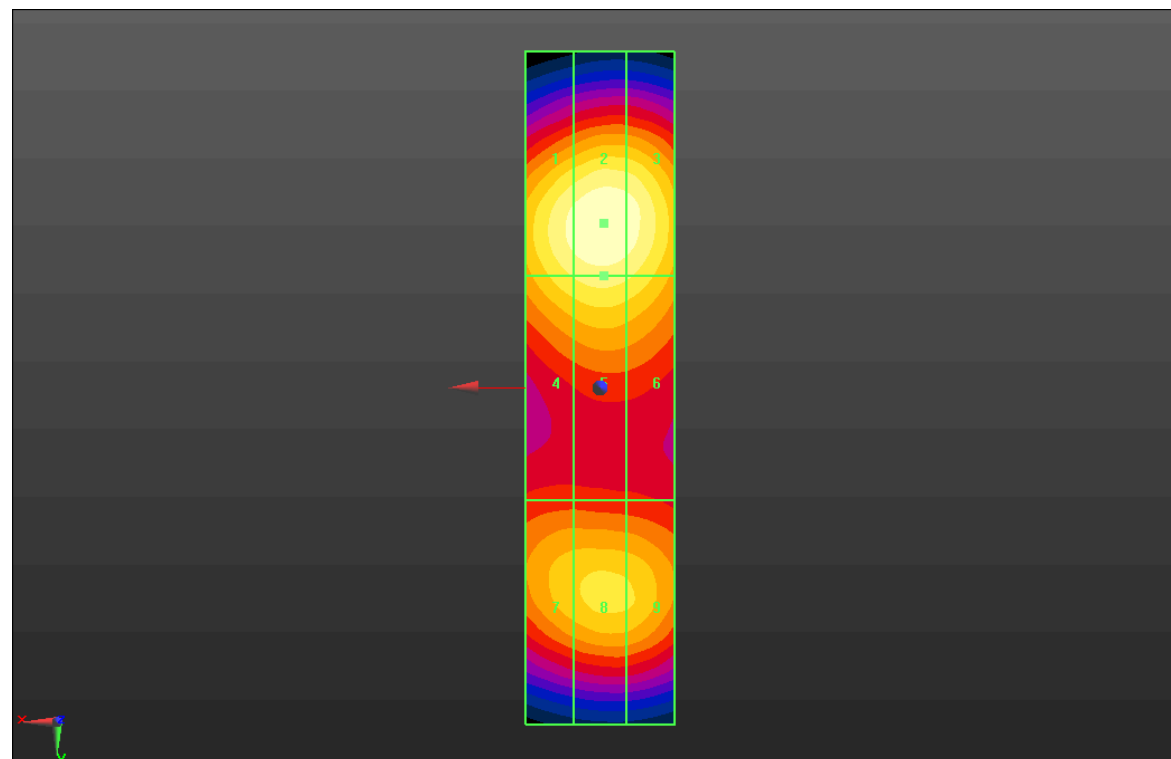
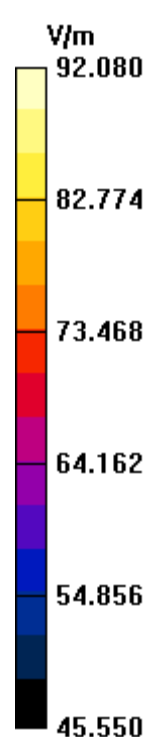

ANNEX B: TEST PLOT

GSM850

Communication System: UID 10021 - DAB, GSM-FDD (TDMA, GMSK); Frequency: 824.2 MHz;
Medium parameters used: $\sigma = 0$ S/m, $\epsilon_r = 1$; $\rho = 0$ kg/m³
Phantom section: RF Section

DASY Configuration:

- Probe: ER3DV6 - SN2368; ConvF(1, 1, 1); Calibrated: 2020/10/23;
- Sensor-Surface: (Fix Surface)
- Electronics: DAE4 Sn720; Calibrated: 2020.09.30
- Phantom: HAC Test Arch; Type: SD HAC P01 BA;
- DASY52 52.8.8(1258); SEMCAD X 14.6.10(7373)

Device E-Field measurement (E-field scan for ANSI C63.192011 compliance)/E Scan - ER3D: 15 mm from Probe Center to the Device 128/Hearing Aid Compatibility Test (101x101x1): Interpolated grid: dx=0.5000 mm, dy=0.5000 mm

Device Reference Point: 0, 0, -6.3 mm

Reference Value = 60.44 V/m; Power Drift = 0.21 dB

Applied MIF = 3.63 dB

RF audio interference level = 37.09 dBV/m

Emission category: M4

MIF scaled E-field

Grid 1 M4 35.81 dBV/m	Grid 2 M4 36.78 dBV/m	Grid 3 M4 36.62 dBV/m
Grid 4 M4 36.26 dBV/m	Grid 5 M4 37.09 dBV/m	Grid 6 M4 36.91 dBV/m
Grid 7 M4 36.16 dBV/m	Grid 8 M4 37.03 dBV/m	Grid 9 M4 36.88 dBV/m

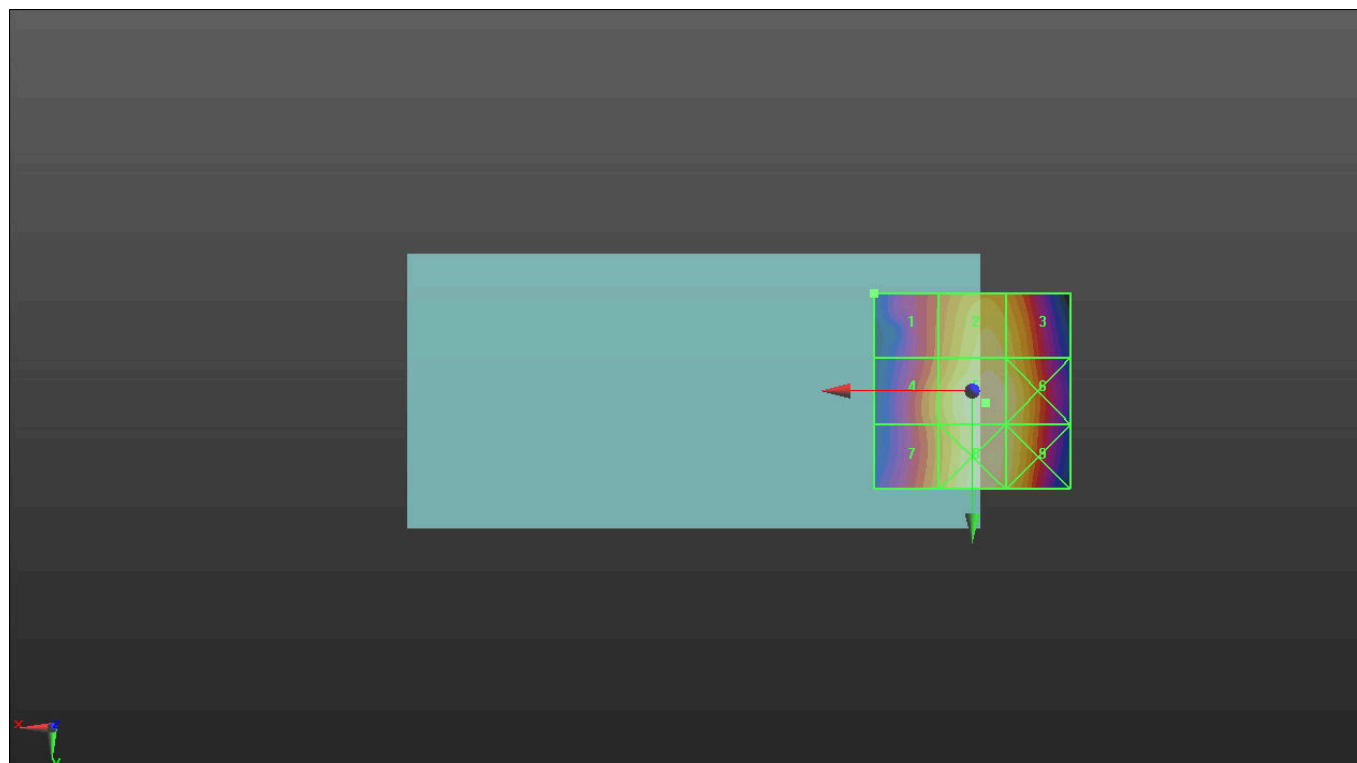

GSM850

Communication System: UID 10021 - DAB, GSM-FDD (TDMA, GMSK); Frequency: 836.6 MHz;
Medium parameters used: $\sigma = 0$ S/m, $\epsilon_r = 1$; $\rho = 0$ kg/m³
Phantom section: RF Section

DASY Configuration:

- Probe: ER3DV6 - SN2368; ConvF(1, 1, 1); Calibrated: 2020/10/23;
- Sensor-Surface: (Fix Surface)
- Electronics: DAE4 Sn720; Calibrated:2020.09.30
- Phantom: HAC Test Arch; Type: SD HAC P01 BA;
- DASY52 52.8.8(1258); SEMCAD X 14.6.10(7373)

Device E-Field measurement (E-field scan for ANSI C63.192011 compliance)/E Scan - ER3D: 15 mm from Probe Center to the Device 189/Hearing Aid Compatibility Test (101x101x1): Interpolated grid: dx=0.5000 mm, dy=0.5000 mm

Device Reference Point: 0, 0, -6.3 mm

Reference Value = 58.70 V/m; Power Drift = -0.25 dB

Applied MIF = 3.63 dB

RF audio interference level = 36.35 dBV/m

Emission category: M4

MIF scaled E-field

Grid 1 M4 35.29 dBV/m	Grid 2 M4 36.17 dBV/m	Grid 3 M4 36.03 dBV/m
Grid 4 M4 35.49 dBV/m	Grid 5 M4 36.35 dBV/m	Grid 6 M4 36.2 dBV/m
Grid 7 M4 35.35 dBV/m	Grid 8 M4 36.25 dBV/m	Grid 9 M4 36.1 dBV/m

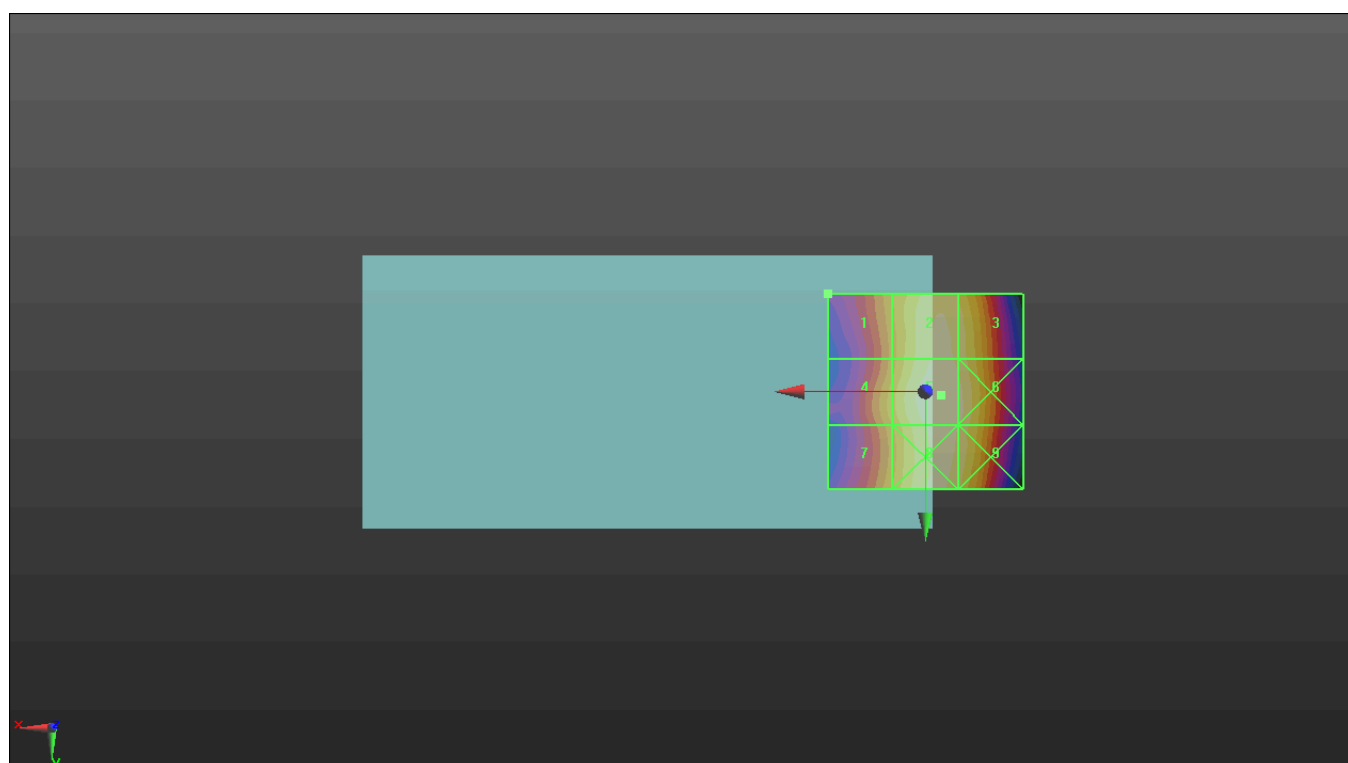

GSM850

Communication System: UID 10021 - DAB, GSM-FDD (TDMA, GMSK); Frequency: 848.6 MHz;
Medium parameters used: $\sigma = 0$ S/m, $\epsilon_r = 1$; $\rho = 0$ kg/m³
Phantom section: RF Section

DASY Configuration:

- Probe: ER3DV6 - SN2368; ConvF(1, 1, 1); Calibrated: 2020/10/23;
- Sensor-Surface: (Fix Surface)
- Electronics: DAE4 Sn720; Calibrated: 2020.09.30
- Phantom: HAC Test Arch; Type: SD HAC P01 BA;
- DASY52 52.8.8(1258); SEMCAD X 14.6.10(7373)

Device E-Field measurement (E-field scan for ANSI C63.192011 compliance)/E Scan - ER3D: 15 mm from Probe Center to the Device 251/Hearing Aid Compatibility Test (101x101x1): Interpolated grid: dx=0.5000 mm, dy=0.5000 mm

Device Reference Point: 0, 0, -6.3 mm

Reference Value = 62.19 V/m; Power Drift = 0.03 dB

Applied MIF = 3.63 dB

RF audio interference level = 37.06 dBV/m

Emission category: M4

MIF scaled E-field

Grid 1 M4 36.04 dBV/m	Grid 2 M4 36.82 dBV/m	Grid 3 M4 36.62 dBV/m
Grid 4 M4 36.44 dBV/m	Grid 5 M4 37.06 dBV/m	Grid 6 M4 36.84 dBV/m
Grid 7 M4 36.32 dBV/m	Grid 8 M4 36.95 dBV/m	Grid 9 M4 36.76 dBV/m

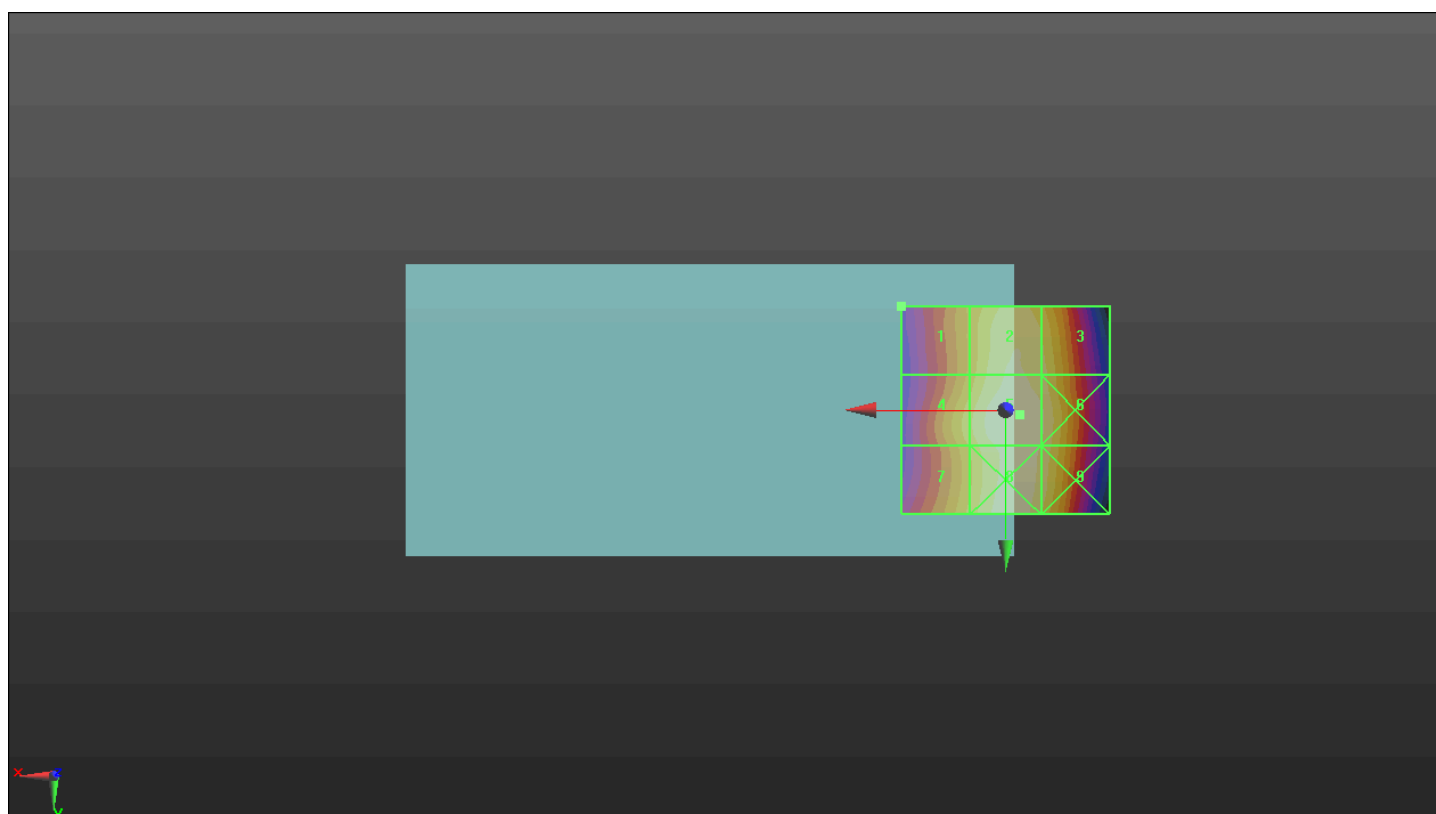

GSM1900

Communication System: UID 10021 - DAB, GSM-FDD (TDMA, GMSK); Frequency: 1850.2 MHz;
Medium parameters used: $\sigma = 0$ S/m, $\epsilon_r = 1$; $\rho = 0$ kg/m³
Phantom section: RF Section

DASY Configuration:

- Probe: ER3DV6 - SN2368; ConvF(1, 1, 1); Calibrated: 2020/10/23;
- Sensor-Surface: (Fix Surface)
- Electronics: DAE4 Sn720; Calibrated: 2020.09.30
- Phantom: HAC Test Arch; Type: SD HAC P01 BA;
- DASY52 52.8.8(1258); SEMCAD X 14.6.10(7373)

Device E-Field measurement (E-field scan for ANSI C63.192011 compliance)/E Scan - ER3D: 15 mm from Probe Center to the Device 512/Hearing Aid Compatibility Test (101x101x1): Interpolated grid: dx=0.5000 mm, dy=0.5000 mm

Device Reference Point: 0, 0, -6.3 mm

Reference Value = 6.008 V/m; Power Drift = -0.94 dB

Applied MIF = 3.63 dB

RF audio interference level = 27.57 dBV/m

Emission category: M4

MIF scaled E-field

Grid 1 M4 26.61 dBV/m	Grid 2 M4 27.57 dBV/m	Grid 3 M4 27.11 dBV/m
Grid 4 M4 22.12 dBV/m	Grid 5 M4 24.78 dBV/m	Grid 6 M4 24.78 dBV/m
Grid 7 M4 28.09 dBV/m	Grid 8 M4 29.27 dBV/m	Grid 9 M4 28.94 dBV/m

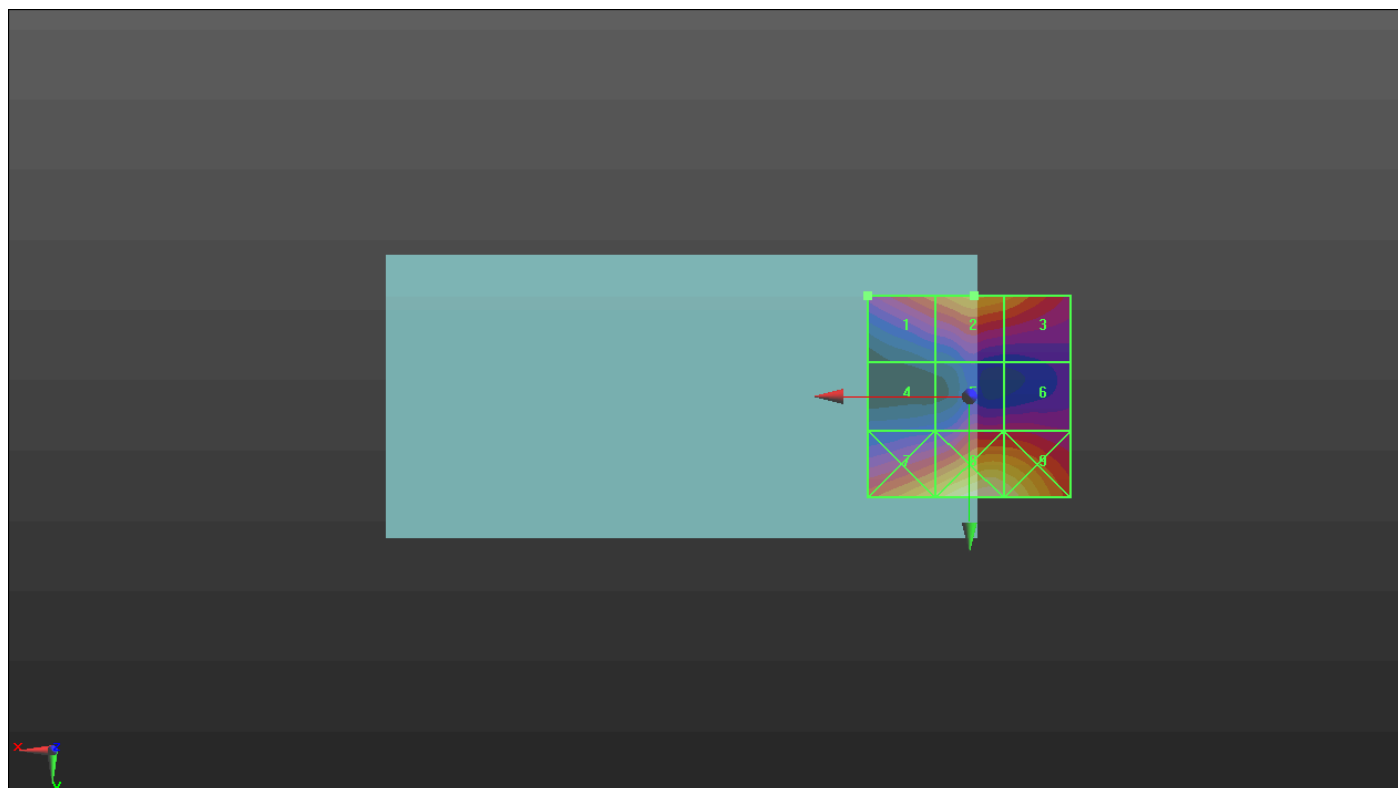

GSM1900

Communication System: UID 10021 - DAB, GSM-FDD (TDMA, GMSK); Frequency: 1880 MHz;
Medium parameters used: $\sigma = 0$ S/m, $\epsilon_r = 1$; $\rho = 0$ kg/m³
Phantom section: RF Section

DASY Configuration:

- Probe: ER3DV6 - SN2368; ConvF(1, 1, 1); Calibrated: 2020/10/23;
- Sensor-Surface: (Fix Surface)
- Electronics: DAE4 Sn720; Calibrated: 2020.09.30
- Phantom: HAC Test Arch; Type: SD HAC P01 BA;
- DASY52 52.8.8(1258); SEMCAD X 14.6.10(7373)

Device E-Field measurement (E-field scan for ANSI C63.192011 compliance)/E Scan - ER3D: 15 mm from Probe Center to the Device 661/Hearing Aid Compatibility Test (101x101x1): Interpolated grid: dx=0.5000 mm, dy=0.5000 mm

Device Reference Point: 0, 0, -6.3 mm

Reference Value = 8.171 V/m; Power Drift = -4.25 dB

Applied MIF = 3.63 dB

RF audio interference level = 29.38 dBV/m

Emission category: M4

MIF scaled E-field

Grid 1 M4 28.47 dBV/m	Grid 2 M4 29.13 dBV/m	Grid 3 M4 28.53 dBV/m
Grid 4 M4 29.38 dBV/m	Grid 5 M4 24.88 dBV/m	Grid 6 M4 25.09 dBV/m
Grid 7 M4 28.73 dBV/m	Grid 8 M4 29.75 dBV/m	Grid 9 M4 29.57 dBV/m

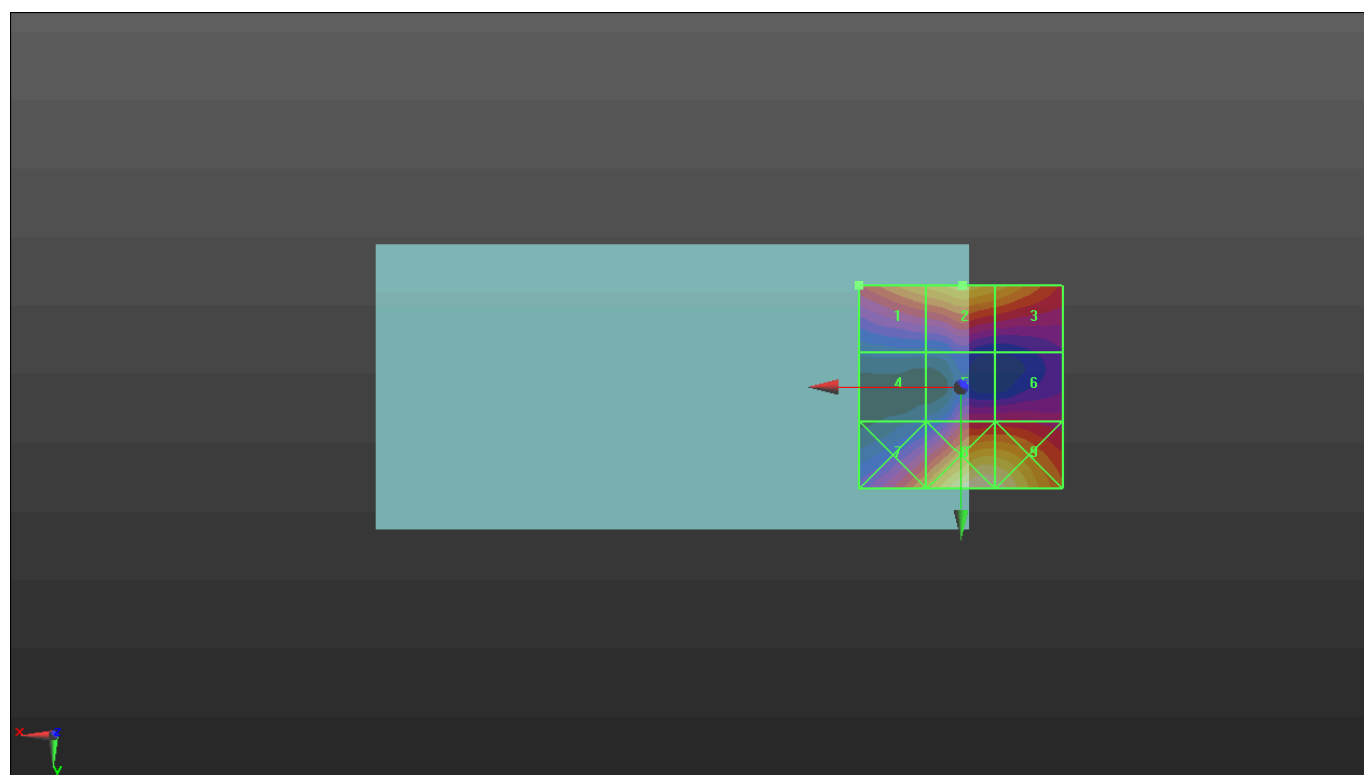

GSM1900

Communication System: UID 10021 - DAB, GSM-FDD (TDMA, GMSK); Frequency: 1909.8 MHz;
Medium parameters used: $\sigma = 0$ S/m, $\epsilon_r = 1$; $\rho = 0$ kg/m³
Phantom section: RF Section

DASY Configuration:

- Probe: ER3DV6 - SN2368; ConvF(1, 1, 1); Calibrated: 2020/10/23;
- Sensor-Surface: (Fix Surface)
- Electronics: DAE4 Sn720; Calibrated: 2020.09.30
- Phantom: HAC Test Arch; Type: SD HAC P01 BA;
- DASY52 52.8.8(1258); SEMCAD X 14.6.10(7373)

Device E-Field measurement (E-field scan for ANSI C63.192011 compliance)/E Scan - ER3D: 15 mm from Probe Center to the Device 810/Hearing Aid Compatibility Test (101x101x1): Interpolated grid: dx=0.5000 mm, dy=0.5000 mm

Device Reference Point: 0, 0, -6.3 mm

Reference Value = 6.891 V/m; Power Drift = -1.03 dB

Applied MIF = 3.63 dB

RF audio interference level = 28.04 dBV/m

Emission category: M4

MIF scaled E-field

Grid 1 M4 27.32 dBV/m	Grid 2 M4 28.04 dBV/m	Grid 3 M4 27.53 dBV/m
Grid 4 M4 20.27 dBV/m	Grid 5 M4 24.71 dBV/m	Grid 6 M4 24.76 dBV/m
Grid 7 M4 26.97 dBV/m	Grid 8 M4 29.13 dBV/m	Grid 9 M4 28.94 dBV/m

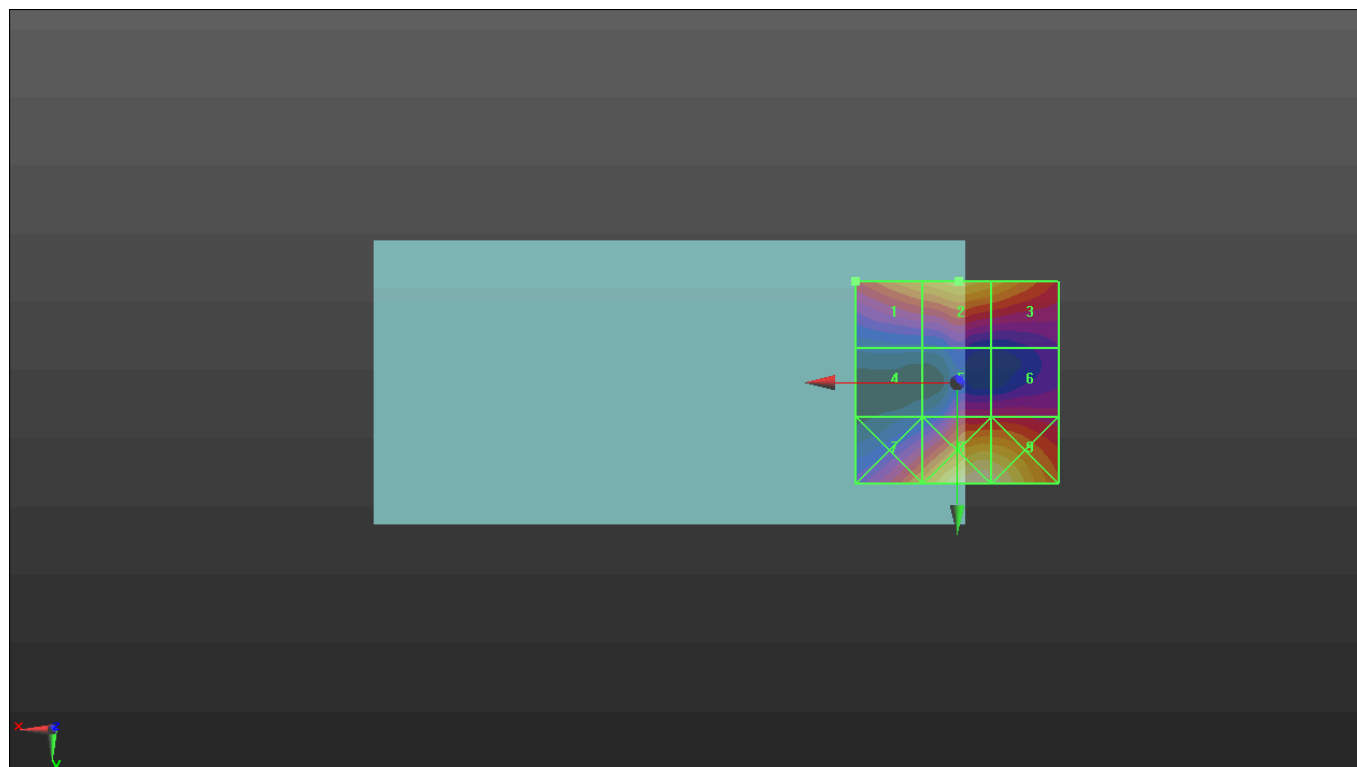

LTE Band41

Communication System: UID 10172 - CAB, LTE-TDD (SC-FDMA, 1 RB, 20 MHz, QPSK); Frequency: 2506 MHz; Duty Cycle: 1:8.33681
Medium parameters used: $\sigma = 0$ S/m, $\epsilon_r = 1$; $\rho = 0$ kg/m³
Phantom section: RF Section

DASY5 Configuration:

- Probe: ER3DV6 - SN2368; ConvF(1, 1, 1); Calibrated: 2020/10/23;
- Sensor-Surface: (Fix Surface)
- Electronics: DAE4 Sn720; Calibrated: 2020.09.30
- Phantom: HAC Test Arch; Type: SD HAC P01 BA;
- Measurement SW: DASY52, Version 52.8 (8); SEMCAD X Version 14.6.10 (7373)

Device E-Field measurement (E-field scan for ANSI C63.192011 compliance)/E Scan - ER3D: 15 mm from Probe Center to the Device TDD-Band41 PC2 L/Hearing Aid Compatibility Test (101x101x1): Interpolated grid: dx=0.5000 mm, dy=0.5000 mm

Device Reference Point: 0, 0, -6.3 mm

Reference Value = 16.58 V/m; Power Drift = -0.08 dB

Applied MIF = -1.62 dB

RF audio interference level = 23.04 dBV/m

Emission category: M4

MIF scaled E-field

Grid 1 M4 25.38 dBV/m	Grid 2 M4 23.64 dBV/m	Grid 3 M4 23.71 dBV/m
Grid 4 M4 21.18 dBV/m	Grid 5 M4 22.92 dBV/m	Grid 6 M4 23.04 dBV/m
Grid 7 M4 17.3 dBV/m	Grid 8 M4 21.96 dBV/m	Grid 9 M4 22.04 dBV/m

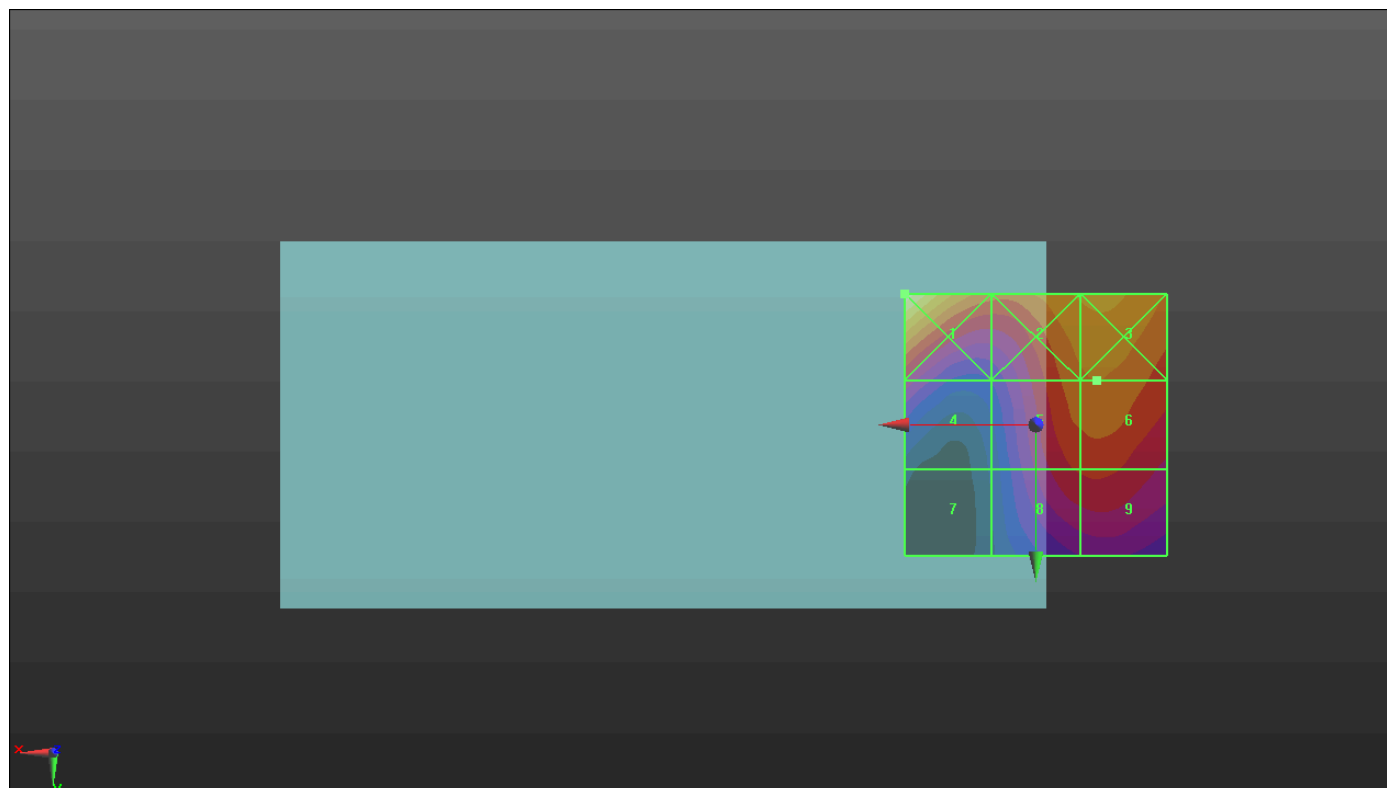

LTE Band41

Communication System: UID 10172 - CAB, LTE-TDD (SC-FDMA, 1 RB, 20 MHz, QPSK); Frequency: 2593 MHz; Duty Cycle: 1:8.33681
Medium parameters used: $\sigma = 0$ S/m, $\epsilon_r = 1$; $\rho = 0$ kg/m³
Phantom section: RF Section

DASY5 Configuration:

- Probe: ER3DV6 - SN2368; ConvF(1, 1, 1); Calibrated: 2020/10/23;
- Sensor-Surface: (Fix Surface)
- Electronics: DAE4 Sn720; Calibrated: 2020.09.30
- Phantom: HAC Test Arch; Type: SD HAC P01 BA;
- Measurement SW: DASY52, Version 52.8 (8); SEMCAD X Version 14.6.10 (7373)

Device E-Field measurement (E-field scan for ANSI C63.192011 compliance)/E Scan - ER3D: 15 mm from Probe Center to the Device TDD-Band41 PC2 M/Hearing Aid Compatibility Test (101x101x1): Interpolated grid: dx=0.5000 mm, dy=0.5000 mm

Device Reference Point: 0, 0, -6.3 mm

Reference Value = 14.33 V/m; Power Drift = 0.04 dB

Applied MIF = -1.62 dB

RF audio interference level = 22.02 dBV/m

Emission category: M4

MIF scaled E-field

Grid 1 M4 22.63 dBV/m	Grid 2 M4 23.06 dBV/m	Grid 3 M4 23.06 dBV/m
Grid 4 M4 19.01 dBV/m	Grid 5 M4 21.98 dBV/m	Grid 6 M4 22.02 dBV/m
Grid 7 M4 17.21 dBV/m	Grid 8 M4 19.83 dBV/m	Grid 9 M4 19.96 dBV/m

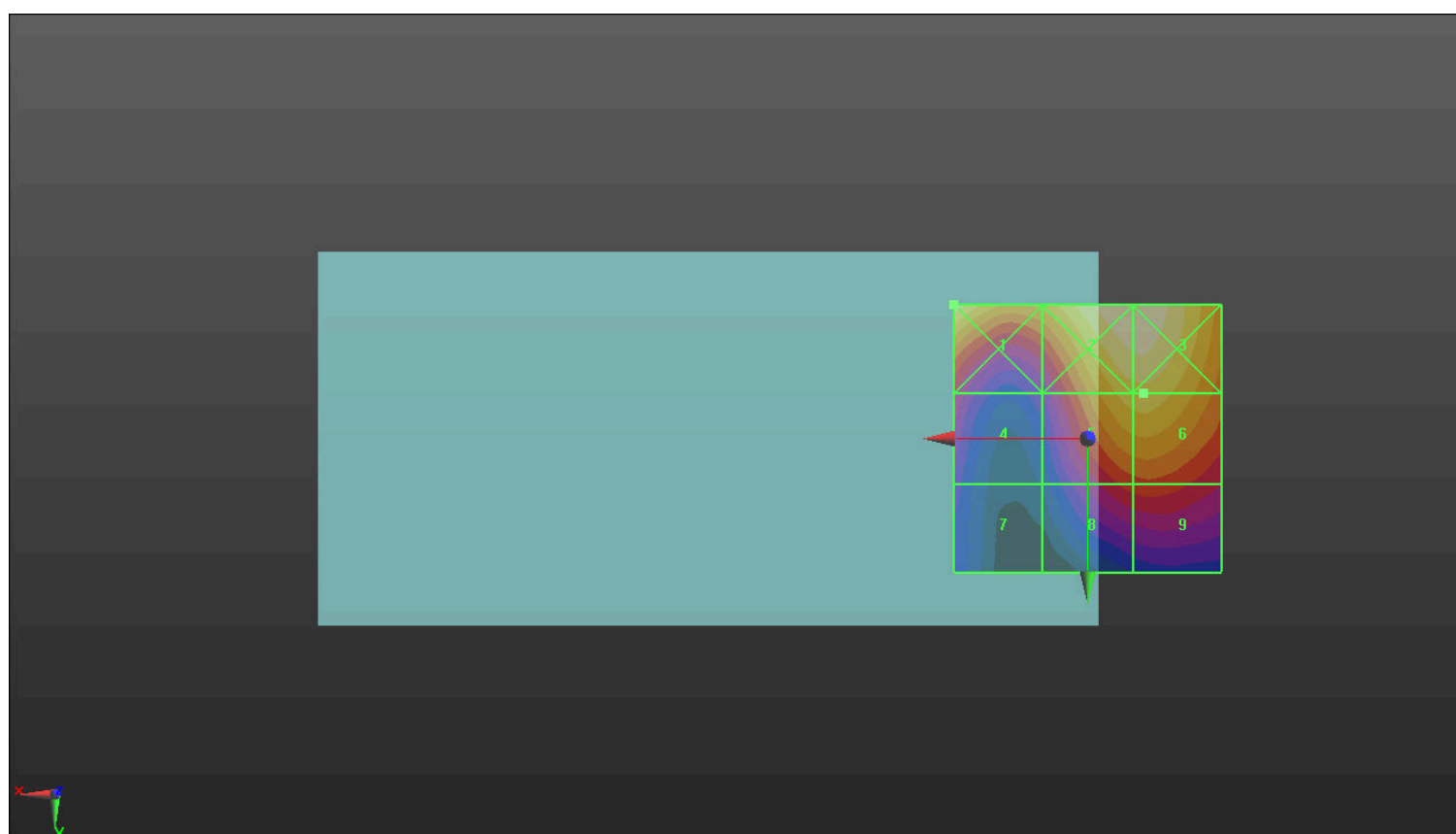

LTE Band41

Communication System: UID 10172 - CAB, LTE-TDD (SC-FDMA, 1 RB, 20 MHz, QPSK); Frequency: 2680 MHz; Duty Cycle: 1:8.33681
Medium parameters used: $\sigma = 0$ S/m, $\epsilon_r = 1$; $\rho = 0$ kg/m³
Phantom section: RF Section

DASY5 Configuration:

- Probe: ER3DV6 - SN2368; ConvF(1, 1, 1); Calibrated: 2020/10/23;
- Sensor-Surface: (Fix Surface)
- Electronics: DAE4 Sn720; Calibrated: 2020.09.30
- Phantom: HAC Test Arch; Type: SD HAC P01 BA;
- Measurement SW: DASY52, Version 52.8 (8); SEMCAD X Version 14.6.10 (7373)

Device E-Field measurement (E-field scan for ANSI C63.192011 compliance)/E Scan - ER3D: 15 mm from Probe Center to the Device TDD-Band41 PC2 H/Hearing Aid Compatibility Test (101x101x1): Interpolated grid: dx=0.5000 mm, dy=0.5000 mm
Device Reference Point: 0, 0, -6.3 mm

Reference Value = 17.31 V/m; Power Drift = -0.04 dB

Applied MIF = -1.62 dB

RF audio interference level = 23.31 dBV/m

Emission category: M4

MIF scaled E-field

Grid 1 M4 21.93 dBV/m	Grid 2 M4 23.44 dBV/m	Grid 3 M4 23.54 dBV/m
Grid 4 M4 18.89 dBV/m	Grid 5 M4 23.31 dBV/m	Grid 6 M4 23.4 dBV/m
Grid 7 M4 20.48 dBV/m	Grid 8 M4 21.31 dBV/m	Grid 9 M4 21.61 dBV/m

