



FCC RF Test Report

APPLICANT : ZTE CORPORATION
EQUIPMENT : LTE/WCDMA/GSM(GPRS) Multi-Mode Digital Mobile Phone
BRAND NAME : ZTE
MODEL NAME : Z3353CA
FCC ID : SRQ-Z3353CA
STANDARD : 47 CFR Part 2, 24(E), 27(L)
CLASSIFICATION : PCS Licensed Transmitter Held to Ear (PCE)
TEST DATE(S) : Dec. 30, 2021 ~ Jan. 10, 2022

We, Sporton International Inc. (Kunshan), would like to declare that the tested sample has been evaluated in accordance with the procedures given in ANSI C63.26-2015 and shown compliance with the applicable technical standards.

The test results in this report apply exclusively to the tested model / sample. Without written approval of Sporton International Inc. (Kunshan), the test report shall not be reproduced except in full.

Reviewed by: Jason Jia / Supervisor

Approved by: Alex Wang / Manager



Sporton International Inc. (Kunshan)

**No. 1098, Pengxi North Road, Kunshan Economic Development Zone Jiangsu Province 215300
People's Republic of China**



TABLE OF CONTENTS

REVISION HISTORY... 3
SUMMARY OF TEST RESULT ... 4
1 GENERAL DESCRIPTION ... 6
1.1 Applicant ... 6
1.2 Manufacturer ... 6
1.3 Product Feature of Equipment Under Test ... 6
1.4 Product Specification of Equipment Under Test ... 6
1.5 Modification of EUT ... 7
1.6 Maximum ERP/EIRP Power and Emission Designator ... 7
1.7 Testing Location ... 8
1.8 Test Software ... 8
1.9 Applicable Standards ... 8
2 TEST CONFIGURATION OF EQUIPMENT UNDER TEST ... 9
2.1 Test Mode ... 9
2.2 Connection Diagram of Test System ... 10
2.3 Support Unit used in test configuration and system ... 10
2.4 Measurement Results Explanation Example ... 10
2.5 Frequency List of Low/Middle/High Channels ... 11
3 CONDUCTED TEST ITEMS ... 12
3.1 Measuring Instruments ... 12
3.2 Test Setup ... 12
3.3 Test Result of Conducted Test ... 12
3.4 Conducted Output Power and ERP/EIRP ... 13
3.5 Peak-to-Average Ratio ... 14
3.6 Occupied Bandwidth ... 15
3.7 Conducted Band Edge ... 16
3.8 Conducted Spurious Emission ... 18
3.9 Frequency Stability ... 19
4 RADIATED TEST ITEMS ... 20
4.1 Measuring Instruments ... 20
4.2 Test Setup ... 20
4.3 Test Result of Radiated Test ... 21
4.4 Radiated Spurious Emission ... 22
5 LIST OF MEASURING EQUIPMENT ... 23
6 UNCERTAINTY OF EVALUATION ... 24
APPENDIX A. TEST RESULTS OF CONDUCTED TEST
APPENDIX B. TEST RESULTS OF RADIATED TEST
APPENDIX C. TEST SETUP PHOTOGRAPHS



SUMMARY OF TEST RESULT

Report Section	FCC Rule	Description	Limit	Result	Remark
3.4	§2.1046	Conducted Output Power	-	Report Only	-
	§24.232(c)	Equivalent Isotropic Radiated Power (Band 2)	EIRP < 2Watt	PASS	-
	§27.50(d)(4)	Equivalent Isotropic Radiated Power (Band 4)	EIRP < 1Watt		-
3.5	§24.232(d)	Peak-to-Average Ratio	<13 dB	PASS	-
3.6	§2.1049	Occupied Bandwidth	-	Report Only	-
3.7	§2.1051 §24.238(a) §27.53(h)	Conducted Band Edge Measurement (Band 2) (Band 4)	< 43+10log10(P[Watts])	PASS	-
3.8	§2.1051 §24.238(a) §27.53(h)	Conducted Spurious Emission (Band 2) (Band 4)	< 43+10log10(P[Watts])	PASS	-
3.9	§2.1055 §22.355	Frequency Stability Temperature & Voltage	< 2.5 ppm for Part 22	PASS	-
	§2.1055 §24.235 §27.54		Within Authorized Band		



Report Section	FCC Rule	Description	Limit	Result	Remark
4.4	§2.1053 §24.238(a) §27.53(h)	Radiated Spurious Emission (Band 2) (Band 4)	$< 43 + 10 \log_{10}(P[\text{Watts}])$	PASS	Under limit 32.72 dB at 5550.000 MHz

Declaration of Conformity:

The test results with all measurement uncertainty excluded are presented in accordance with the regulation limits or requirements declared by manufacturers.

Comments and Explanations:

The declared of product specification for EUT presented in the report are provided by the manufacturer, and the manufacturer takes all the responsibilities for the accuracy of product specification.



1 General Description

1.1 Applicant

ZTE CORPORATION

ZTE Plaza, Keji Road South, Hi-Tech, Industrial Park, Nanshan District, Shenzhen, Guangdong, 518057, P.R.China

1.2 Manufacturer

ZTE CORPORATION

ZTE Plaza, Keji Road South, Hi-Tech, Industrial Park, Nanshan District, Shenzhen, Guangdong, 518057, P.R.China

1.3 Product Feature of Equipment Under Test

Product Feature	
Equipment	LTE/WCDMA/GSM(GPRS) Multi-Mode Digital Mobile Phone
Brand Name	ZTE
Model Name	Z3353CA
FCC ID	SRQ-Z3353CA
IMEI Code	Conducted: 862829060000600 Radiation: 004402543180974
HW Version	Z3353CAHW1.0
SW Version	Z3353CAV1.0.0B01
EUT Stage	Production Unit

Remark: This is a C2PC report for Z3353CA, based on change FCC ID report (original FCC ID: SRQ-Z3352CA, change FCC ID: SRQ-Z3353CA). The difference refer to the Z3353CA_Class II Permissive Change letter exhibit separately. According to the differences, only the related test cases were verified from original report which can be referred to Sporton Report Number FG010610B(original FCC ID: SRQ-Z3352CA).

1.4 Product Specification of Equipment Under Test

Standards-related Product Specification	
Tx Frequency	LTE Band 2 : 1850 MHz ~ 1910 MHz LTE Band 4 : 1710 MHz ~ 1755 MHz
Rx Frequency	LTE Band 2 : 1930 MHz ~ 1990 MHz LTE Band 4 : 2110 MHz ~ 2155 MHz
Bandwidth	LTE Band 2 : 1.4MHz / 3MHz / 5MHz / 10MHz / 15MHz / 20MHz LTE Band 4 : 1.4MHz / 3MHz / 5MHz / 10MHz / 15MHz / 20MHz
Maximum Output Power to Antenna	LTE Band 2 : 22.70 dBm LTE Band 4 : 22.75 dBm
Antenna Gain	LTE Band 2 : -0.67 dBi LTE Band 4 : -0.50 dBi



Type of Modulation	QPSK / 16QAM / 64QAM
--------------------	----------------------

1.5 Modification of EUT

No modifications are made to the EUT during all test items.

1.6 Maximum ERP/EIRP Power and Emission Designator

LTE Band 2		QPSK	16QAM/64QAM
BW (MHz)	Frequency Range (MHz)	Maximum EIRP(W)	Maximum EIRP(W)
1.4	1850.7 ~ 1909.3	0.1592	0.1371
3	1851.5 ~ 1908.5	0.1535	0.1309
5	1852.5 ~ 1907.5	0.1581	0.1358
10	1855.0 ~ 1905.0	0.1574	0.1343
15	1857.5 ~ 1902.5	0.1592	0.1349
20	1860.0 ~ 1900.0	0.1596	0.1352
LTE Band 4		QPSK	16QAM/64QAM
BW (MHz)	Frequency Range (MHz)	Maximum EIRP(W)	Maximum EIRP(W)
1.4	1710.7 ~ 1754.3	0.1667	0.1400
3	1711.5 ~ 1753.5	0.1614	0.1343
5	1712.5 ~ 1752.5	0.1629	0.1510
10	1715.0 ~ 1750.0	0.1626	0.1355
15	1717.5 ~ 1747.5	0.1667	0.1403
20	1720.0 ~ 1745.0	0.1679	0.1365



1.7 Testing Location

<FCC>-KS

Sporton International Inc. (Kunshan) is accredited to ISO/IEC 17025:2017 by American Association for Laboratory Accreditation with Certificate Number 5145.02.

Test Firm	Sporton International Inc. (Kunshan)		
Test Site Location	No. 1098, Pengxi North Road, Kunshan Economic Development Zone Jiangsu Province 215300 People's Republic of China TEL : +86-512-57900158 FAX : +86-512-57900958		
Test Site No.	Sporton Site No.	FCC Designation No.	FCC Test Firm Registration No.
	03CH04-KS TH01-KS	CN1257	314309

1.8 Test Software

Item	Site	Manufacture	Name	Version
1.	03CH04-KS	AUDIX	E3	6.2009-8-24a

1.9 Applicable Standards

According to the specifications of the manufacturer, the EUT must comply with the requirements of the following standards:

- ♦ 47 CFR Part 2, 24(E), 27(L)
- ♦ ANSI C63.26-2015
- ♦ FCC KDB 971168 D01 Power Meas License Digital Systems v03r01
- ♦ FCC KDB 412172 D01 Determining ERP and EIRP v01r01

Remark:

1. All test items were verified and recorded according to the standards and without any deviation during the test.
2. This EUT has also been tested and complied with the requirements of FCC Part 15, Subpart B, recorded in a separate test report.



2 Test Configuration of Equipment Under Test

2.1 Test Mode

Antenna port conducted and radiated test items listed below are performed according to KDB 971168 D01 Power Meas License Digital Systems v03r01 with maximum output power.

Radiated measurements are performed by rotating the EUT in three different orthogonal test planes to find the maximum emission.

Test Items	Band	Bandwidth (MHz)						Modulation			RB #			Test Channel		
		1.4	3	5	10	15	20	QPSK	16QAM	64QAM	1	Half	Full	L	M	H
Max. Output Power	2	v	v	v	v	v	v	v	v	v	v	v	v	v	v	v
	4	v	v	v	v	v	v	v	v	v	v	v	v	v	v	v
Conducted Band Edge	2	v	v	v	v	v	v	v	v	v	v		v	v		v
	4	v	v	v	v	v	v	v	v	v	v		v	v		v
Conducted Spurious Emission	2	v	v	v	v	v	v	v	v	v	v			v	v	v
	4	v	v	v	v	v	v	v	v	v	v			v	v	v
Frequency Stability	2				v			v					v		v	
	4				v			v					v		v	
E.R.P / E.I.R.P	2	v	v	v	v	v	v	v	v	v	v			v	v	v
	4	v	v	v	v	v	v	v	v	v	v			v	v	v
Radiated Spurious Emission	2	Worst Case												v		
	4	Worst Case												v		
Note	1. The mark "v " means that this configuration is chosen for testing 2. The mark "-" means that this bandwidth is not supported. 3. The device is investigated from 30MHz to 10 times of fundamental signal for radiated spurious emission test under different RB size/offset and modulations in exploratory test. Subsequently, only the worst case emissions are reported.															

2.2 Connection Diagram of Test System

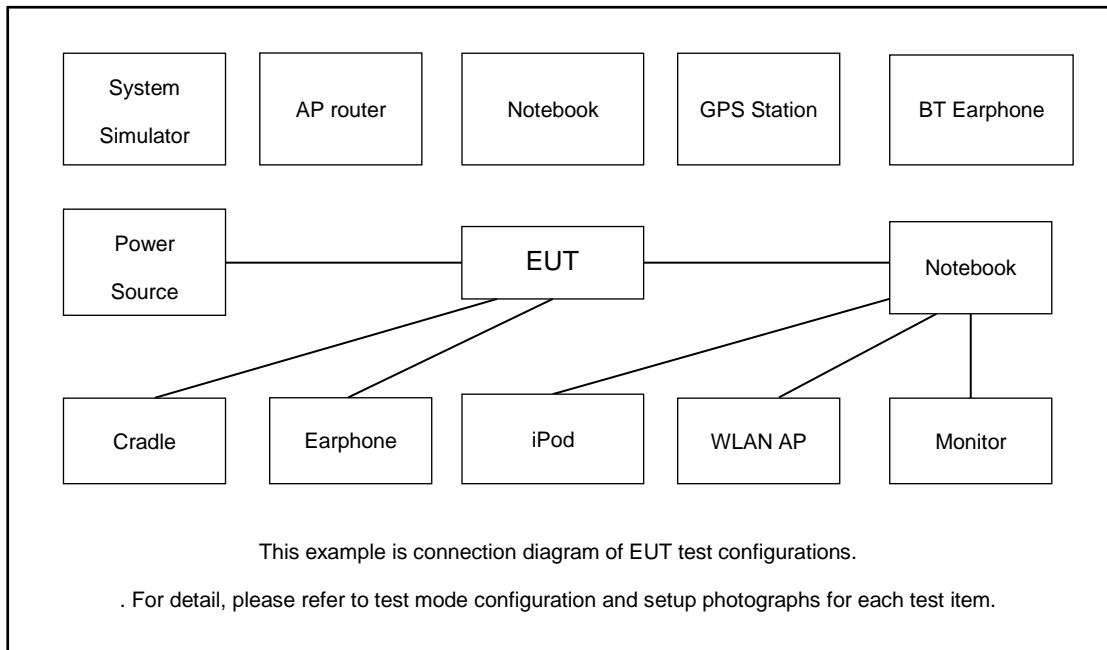

2.3 Support Unit used in test configuration and system

Item	Equipment	Trade Name	Model No.	FCC ID	Data Cable	Power Cord
1.	Power Supply	GWINSTEK	PSS-2002	N/A	N/A	Unshielded, 1.8 m
2.	LTE Base Station	Anritsu	MT8820C	N/A	N/A	Unshielded, 1.8 m

2.4 Measurement Results Explanation Example

For all conducted test items:

The offset level is set in the spectrum analyzer to compensate the RF cable loss between EUT conducted output port and spectrum analyzer. With the offset compensation, the spectrum analyzer reading level is exactly the EUT RF output level.

The spectrum analyzer offset is derived from RF cable loss.

Offset = RF cable loss.

Following shows an offset computation example with cable loss 5.40 dB.

Example :

$$\begin{aligned} \text{Offset(dB)} &= \text{RF cable loss(dB)} \\ &= 5.40 \text{ (dB)} \end{aligned}$$



2.5 Frequency List of Low/Middle/High Channels

LTE Band 2 Channel and Frequency List				
BW [MHz]	Channel/Frequency(MHz)	Lowest	Middle	Highest
20	Channel	18700	18900	19100
	Frequency	1860	1880	1900
15	Channel	18675	18900	19125
	Frequency	1857.5	1880	1902.5
10	Channel	18650	18900	19150
	Frequency	1855	1880	1905
5	Channel	18625	18900	19175
	Frequency	1852.5	1880	1907.5
3	Channel	18615	18900	19185
	Frequency	1851.5	1880	1908.5
1.4	Channel	18607	18900	19193
	Frequency	1850.7	1880	1909.3

LTE Band 4 Channel and Frequency List				
BW [MHz]	Channel/Frequency(MHz)	Lowest	Middle	Highest
20	Channel	20050	20175	20300
	Frequency	1720	1732.5	1745
15	Channel	20025	20175	20325
	Frequency	1717.5	1732.5	1747.5
10	Channel	20000	20175	20350
	Frequency	1715	1732.5	1750
5	Channel	19975	20175	20375
	Frequency	1712.5	1732.5	1752.5
3	Channel	19965	20175	20385
	Frequency	1711.5	1732.5	1753.5
1.4	Channel	19957	20175	20393
	Frequency	1710.7	1732.5	1754.3

3 Conducted Test Items

3.1 Measuring Instruments

See list of measuring instruments of this test report.

3.2 Test Setup

3.2.1 Conducted Output Power



3.2.2 Peak-to-Average Ratio, Occupied Bandwidth ,Conducted Band-Edge and Conducted Spurious Emission

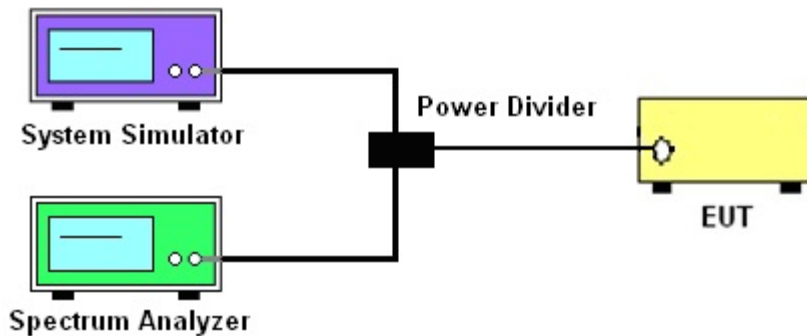

3.2.3 Frequency Stability

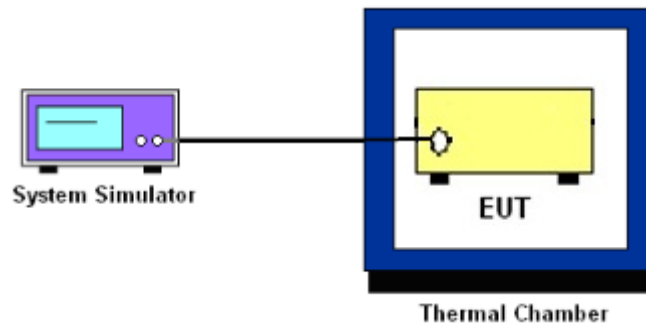

3.3 Test Result of Conducted Test

Please refer to Appendix A.



3.4 Conducted Output Power and ERP/EIRP

3.4.1 Description of the Conducted Output Power Measurement and ERP/EIRP Measurement

A system simulator was used to establish communication with the EUT. Its parameters were set to force the EUT transmitting at maximum output power. The measured power in the radio frequency on the transmitter output terminals shall be reported.

The EIRP of mobile transmitters must not exceed 2 Watts for LTE Band 2.

The EIRP of mobile transmitters must not exceed 1 Watts for LTE Band 4.

According to KDB 412172 D01 Power Approach,

$EIRP = P_T + G_T - L_C$, $ERP = EIRP - 2.15$, where

P_T = transmitter output power in dBm

G_T = gain of the transmitting antenna in dBi

L_C = signal attenuation in the connecting cable between the transmitter and antenna in dB

3.4.2 Test Procedures

1. The testing follows ANSI C63.26 Section 5.2
2. The transmitter output port was connected to the system simulator.
3. Set EUT at maximum power through the system simulator.
4. Select lowest, middle, and highest channels for each band and different modulation.
5. Measure and record the power level from the system simulator.



3.5 Peak-to-Average Ratio

3.5.1 Description of the PAR Measurement

Power Complementary Cumulative Distribution Function (CCDF) curves provide a means for characterizing the power peaks of a digitally modulated signal on a statistical basis. A CCDF curve depicts the probability of the peak signal amplitude exceeding the average power level. Most contemporary measurement instrumentation include the capability to produce CCDF curves for an input signal provided that the instrument's resolution bandwidth can be set wide enough to accommodate the entire input signal bandwidth. In measuring transmissions in this band using an average power technique, the peak-to-average ratio (PAR) of the transmission may not exceed 13 dB.

3.5.2 Test Procedures

1. The testing follows ANSI C63.26 Section 5.2.3.4 (CCDF).
2. The EUT was connected to spectrum and system simulator via a power divider.
3. Set the CCDF (Complementary Cumulative Distribution Function) option in spectrum analyzer.
4. The highest RF powers were measured and recorded the maximum PAPR level associated with a probability of 0.1 %.
5. Record the deviation as Peak to Average Ratio.



3.6 Occupied Bandwidth

3.6.1 Description of Occupied Bandwidth Measurement

The occupied bandwidth is the width of a frequency band such that, below the lower and above the upper frequency limits, the mean powers emitted are each equal to a specified percentage 0.5% of the total mean transmitted power.

The 26 dB emission bandwidth is defined as the frequency range between two points, one above and one below the carrier frequency, at which the spectral density of the emission is attenuated 26 dB below the maximum in-band spectral density of the modulated signal. Spectral density (power per unit bandwidth) is to be measured with a detector of resolution bandwidth equal to approximately 1.0% of the emission bandwidth.

3.6.2 Test Procedures

1. The testing follows ANSI C63.26 Section 5.4
2. The EUT was connected to spectrum analyzer and system simulator via a power divider.
3. The spectrum analyzer center frequency is set to the nominal EUT channel center frequency. The span range for the spectrum analyzer shall be between two and five times the anticipated OBW.
4. The nominal resolution bandwidth (RBW) shall be in the range of 1 to 5 % of the anticipated OBW, and the VBW shall be at least 3 times the RBW.
5. Set the detection mode to peak, and the trace mode to max hold.
6. Determine the reference value: Set the EUT to transmit a modulated signal. Allow the trace to stabilize. Set the spectrum analyzer marker to the highest level of the displayed trace.
(this is the reference value)
7. Determine the “-26 dB down amplitude” as equal to (Reference Value – X).
8. Place two markers, one at the lowest and the other at the highest frequency of the envelope of the spectral display such that each marker is at or slightly below the “-X dB down amplitude” determined in step 6. If a marker is below this “-X dB down amplitude” value it shall be placed as close as possible to this value. The OBW is the positive frequency difference between the two markers.
9. Use the 99 % power bandwidth function of the spectrum analyzer and report the measured bandwidth.



3.7 Conducted Band Edge

3.7.1 Description of Conducted Band Edge Measurement

24.238 (a)

For operations in the 1850-1910 and 1930-1990 MHz band, the FCC limit is $43 + 10\log_{10}(P[\text{Watts}])$ dB below the transmitter power $P(\text{Watts})$ in a 1MHz bandwidth. However, in the 1 MHz bands immediately outside and adjacent to the frequency block a resolution bandwidth of at least one percent of the emission bandwidth of the fundamental emission of the transmitter may be employed.

27.53 (h)

For operations in the 1710 – 1755 MHz band, the FCC limit is $43 + 10\log_{10}(P[\text{Watts}])$ dB below the transmitter power $P(\text{Watts})$ in a 1 MHz bandwidth. However, in the 1MHz bands immediately outside and adjacent to the licensee's frequency block, a resolution bandwidth of at least one percent of the emission bandwidth of the fundamental emission of the transmitter may be employed.



3.7.2 Test Procedures

1. The testing follows ANSI C63.26 section 5.7
2. The EUT was connected to spectrum analyzer and system simulator via a power divider.
3. The band edges of low and high channels for the highest RF powers were measured.
4. Set RBW \geq 1% EBW in the 1MHz band immediately outside and adjacent to the band edge.
5. Beyond the 1 MHz band from the band edge, RBW=1MHz was used or a narrower RBW was used and the measured power was integrated over the full required measurement bandwidth of 1 MHz.
6. Set spectrum analyzer with RMS detector.
7. The RF fundamental frequency should be excluded against the limit line in the operating frequency band.
8. Checked that all the results comply with the emission limit line.

Example:

The limit line is derived from $43 + 10\log(P)$ dB below the transmitter power P(Watts)

$$= P(W) - [43 + 10\log(P)] \text{ (dB)}$$

$$= [30 + 10\log(P)] \text{ (dBm)} - [43 + 10\log(P)] \text{ (dB)} = -13\text{dBm}.$$

9. When using the integration method, the starting frequency of the integration shall be centered at one-half of the RBW away from the band edge.



3.8 Conducted Spurious Emission

3.8.1 Description of Conducted Spurious Emission Measurement

The power of any emission outside of the authorized operating frequency ranges must be lower than the transmitter power (P) by a factor of at least $43 + 10 \log (P)$ dB.

It is measured by means of a calibrated spectrum analyzer and scanned from 30 MHz up to a frequency including its 10th harmonic.

3.8.2 Test Procedures

1. The testing follows ANSI C63.26 section 5.7
2. The EUT was connected to spectrum analyzer and system simulator via a power divider.
3. The RF output of EUT was connected to the spectrum analyzer by RF cable and attenuator. The path loss was compensated to the results for each measurement.
4. The middle channel for the highest RF power within the transmitting frequency was measured.
5. The conducted spurious emission for the whole frequency range was taken.
6. Make the measurement with the spectrum analyzer's RBW = 1MHz, VBW = 3MHz.
7. Set spectrum analyzer with RMS detector.
8. Taking the record of maximum spurious emission.
9. The RF fundamental frequency should be excluded against the limit line in the operating frequency band.
10. The limit line is derived from $43 + 10\log(P)$ dB below the transmitter power P(Watts)
= P(W)- [43 + 10log(P)] (dB)
= [30 + 10log(P)] (dBm) - [43 + 10log(P)] (dB)
= -13dBm.



3.9 Frequency Stability

3.9.1 Description of Frequency Stability Measurement

The frequency stability shall be measured by variation of ambient temperature and variation of primary supply voltage to ensure that the fundamental emission stays within the authorized frequency block. The frequency stability of the transmitter shall be maintained within $\pm 0.00025\%$ ($\pm 2.5\text{ppm}$) of the center frequency.

3.9.2 Test Procedures for Temperature Variation

1. The testing follows ANSI C63.26 section 5.6.4
2. The EUT was set up in the thermal chamber and connected with the system simulator.
3. With power OFF, the temperature was decreased to -30°C and the EUT was stabilized before testing. Power was applied and the maximum change in frequency was recorded within one minute.
4. With power OFF, the temperature was raised in 10°C step up to 50°C . The EUT was stabilized at each step for at least half an hour. Power was applied and the maximum frequency change was recorded within one minute.

3.9.3 Test Procedures for Voltage Variation

1. The testing follows ANSI C63.26 section 5.6.5
2. The EUT was placed in a temperature chamber at $20\pm 5^{\circ}\text{C}$ and connected with the system simulator.
3. The power supply voltage to the EUT was varied from 85% to 115% of the nominal value for other than hand carried battery equipment.
4. For hand carried, battery powered equipment, reduce the primary ac or dc supply voltage to the battery operating end point, which shall be specified by the manufacturer.
5. The variation in frequency was measured for the worst case.

4 Radiated Test Items

4.1 Measuring Instruments

See list of measuring instruments of this test report.

4.2 Test Setup

4.2.1 For radiated test below 30MHz

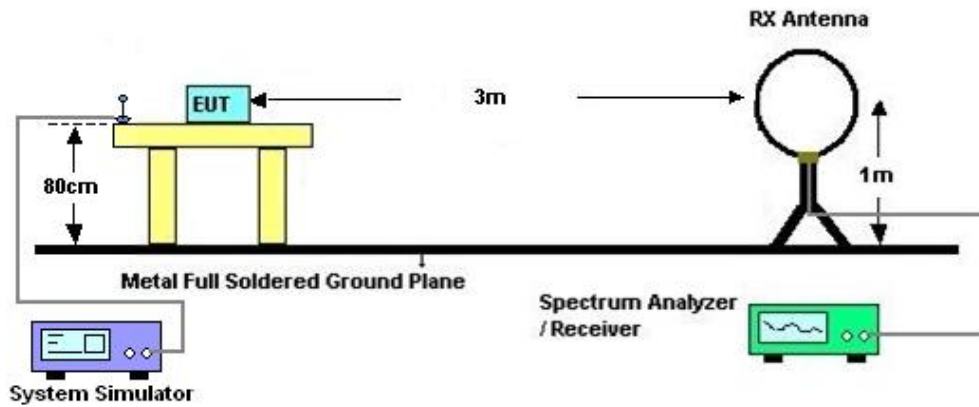

4.2.2 For radiated test from 30MHz to 1GHz

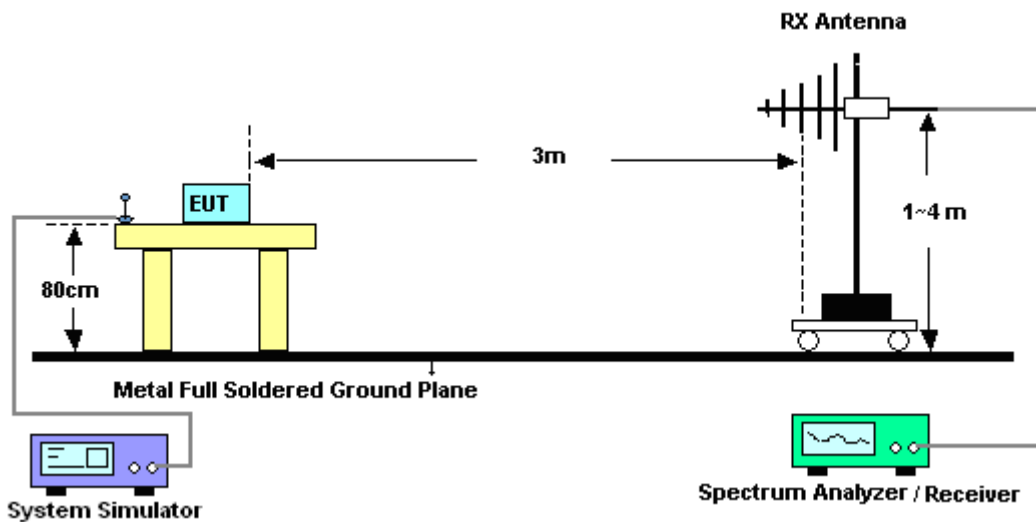

4.2.3 For radiated test above 1GHz

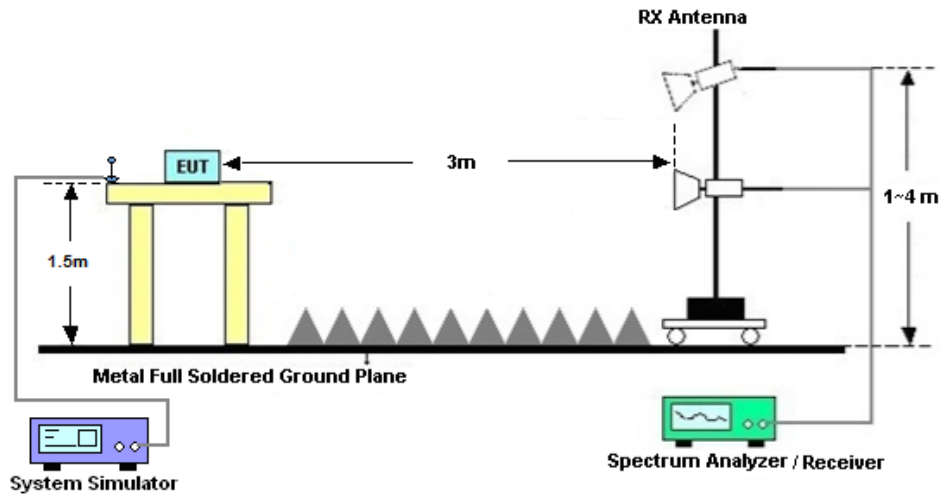

4.3 Test Result of Radiated Test

The low frequency, which started from 9 kHz to 30MHz, was pre-scanned and the result which was 20dB lower than the limit line was not reported.

Please refer to Appendix B.



4.4 Radiated Spurious Emission

4.4.1 Description of Radiated Spurious Emission

The radiated spurious emission was measured by substitution method according to ANSI C63.26. The power of any emission outside of the authorized operating frequency ranges must be attenuated below the transmitter power (P) by a factor of at least $43 + 10 \log (P)$ dB.

The spectrum is scanned from 30 MHz up to a frequency including its 10th harmonic.

4.4.2 Test Procedures

1. The testing follows ANSI C63.26 Section 5.5
2. The EUT was placed on a turntable with 0.8 meter height for frequency below 1GHz and 1.5 meter height for frequency above 1GHz respectively above ground.
3. The EUT was set 3 meters from the receiving antenna mounted on the antenna tower.
4. The table was rotated 360 degrees to determine the position of the highest spurious emission.
5. The height of the receiving antenna is varied between 1m to 4m to search the maximum spurious emission for both horizontal and vertical polarizations.
6. During the measurement, the system simulator parameters were set to force the EUT transmitting at maximum output power.
7. Make the measurement with the spectrum analyzer's RBW = 1MHz, VBW = 3MHz, taking the record of maximum spurious emission.
8. A horn antenna was substituted in place of the EUT and was driven by a signal generator.
9. Tune the output power of signal generator to the same emission level with EUT maximum spurious emission.
10. $EIRP \text{ (dBm)} = S.G. \text{ Power} - Tx \text{ Cable Loss} + Tx \text{ Antenna Gain}$
11. $ERP \text{ (dBm)} = EIRP - 2.15$
12. The RF fundamental frequency should be excluded against the limit line in the operating frequency band.

The limit line is derived from $43 + 10\log(P)$ dB below the transmitter power P(Watts)
= $P(W) - [43 + 10\log(P)] \text{ (dB)}$
= $[30 + 10\log(P)] \text{ (dBm)} - [43 + 10\log(P)] \text{ (dB)}$
= -13dBm.



5 List of Measuring Equipment

Instrument	Manufacturer	Model No.	Serial No.	Characteristics	Calibration Date	Test Date	Due Date	Remark
Spectrum Analyzer	R&S	FSV40	101040	10Hz~40GHz	Oct. 14, 2021	Dec. 30, 2021~ Dec. 31, 2021	Oct. 13, 2022	Conducted (TH01-KS)
Power divider	STI	STI08-0055	-	0.5~40GHz	Aug. 26, 2021	Dec. 30, 2021~ Dec. 31, 2021	Aug. 25, 2022	Conducted (TH01-KS)
Temperature & humidity chamber	Hongzhan	LP-150U	H2014011440	-40~+150°C 20%~95%RH	Jul. 12, 2021	Dec. 30, 2021~ Dec. 31, 2021	Jul. 11, 2022	Conducted (TH01-KS)
EXA Spectrum Analyzer	Keysight	N9010A	MY55150244	10Hz~44G,MAX 30dB	Apr. 13, 2021	Jan. 10, 2022	Apr. 12, 2022	Radiation (03CH04-KS)
Loop Antenna	R&S	HFH2-Z2	100321	9kHz~30MHz	Oct. 30, 2021	Jan. 10, 2022	Oct. 29, 2022	Radiation (03CH04-KS)
Bilog Antenna	TeseQ	CBL6111D	49922	30MHz~1GHz	May 30, 2021	Jan. 10, 2022	May 29, 2022	Radiation (03CH04-KS)
Horn Antenna	Schwarzbeck	BBHA9120D	1356	1GHz~18GHz	Apr. 18, 2021	Jan. 10, 2022	Apr. 17, 2022	Radiation (03CH04-KS)
SHF-EHF Horn	Com-power	AH-840	101070	18GHz~40GHz	Jan. 05, 2022	Jan. 10, 2022	Jan. 04, 2023	Radiation (03CH04-KS)
Amplifier	SONOMA	310N	187289	9KHz~1GHz	Jan. 05, 2022	Jan. 10, 2022	Jan. 04, 2023	Radiation (03CH04-KS)
Amplifier	MITEQ	EM18G40G GA	060728	18~40GHz	Jan. 06, 2022	Jan. 10, 2022	Jan. 05, 2023	Radiation (03CH04-KS)
high gain Amplifier	MITEQ	AMF-7D-00 101800-30-1 0P	2025788	1Ghz~18Ghz	Jan. 05, 2022	Jan. 10, 2022	Jan. 04, 2023	Radiation (03CH04-KS)
Amplifier	Keysight	83017A	MY57280106	500MHz~26.5GHz	Oct. 13, 2021	Jan. 10, 2022	Oct. 12, 2022	Radiation (03CH04-KS)
AC Power Source	Chroma	61601	F104090004	N/A	NCR	Jan. 10, 2022	NCR	Radiation (03CH04-KS)
Turn Table	ChamPro	EM 1000-T	060762-T	0~360 degree	NCR	Jan. 10, 2022	NCR	Radiation (03CH04-KS)
Antenna Mast	ChamPro	EM 1000-A	060762-A	1 m~4 m	NCR	Jan. 10, 2022	NCR	Radiation (03CH04-KS)

NCR: No Calibration Required



6 Uncertainty of Evaluation

The measurement uncertainties shown below were calculated in accordance with the requirements of ANSI 63.26-2015. All the measurement uncertainty value were shown with a coverage K=2 to indicate 95% level of confidence. The measurement data show herein meets or exceeds the CISPR measurement uncertainty values specified in CISPR 16-4-2 and can be compared directly to specified limit to determine compliance.

Uncertainty of Radiated Emission Measurement (30 MHz ~ 1000 MHz)

Measuring Uncertainty for a Level of Confidence of 95% (U = 2Uc(y))	3.3dB
---	-------

Uncertainty of Radiated Emission Measurement (1 GHz ~ 40 GHz)

Measuring Uncertainty for a Level of Confidence of 95% (U = 2Uc(y))	2.8dB
---	-------



Appendix A. Test Results of Conducted Test

Test Engineer :	Simle Wang	Temperature :	22~23°C
		Relative Humidity :	40~42%

Conducted Output Power(Average power)

LTE Band 2 Maximum Average Power [dBm]						
BW [MHz]	RB Size	RB Offset	Mod	Lowest	Middle	Highest
20	1	0	QPSK	22.30	22.25	22.29
20	1	49		22.62	22.70	22.65
20	1	99		22.24	22.25	22.27
20	50	0		21.60	21.67	21.69
20	50	24		21.66	21.67	21.71
20	50	50		21.54	21.60	21.66
20	100	0		21.55	21.66	21.66
20	1	0	16-QAM	21.63	21.57	21.62
20	1	49		21.90	21.96	21.98
20	1	99		21.51	21.49	21.53
20	50	0		20.56	20.65	20.66
20	50	24		20.59	20.65	20.66
20	50	50		20.51	20.57	20.57
20	100	0		20.50	20.60	20.61
20	1	0	64QAM	20.53	20.45	20.49
20	1	49		20.79	20.82	20.84
20	1	99		20.34	20.38	20.42
20	50	0		19.54	19.63	19.63
20	50	24		19.58	19.61	19.63
20	50	50		19.49	19.57	19.58
20	100	0		19.48	19.62	19.58
15	1	0	QPSK	22.48	22.44	22.45
15	1	37		22.67	22.69	22.66
15	1	74		22.38	22.37	22.42
15	36	0		21.60	21.63	21.63



15	36	20		21.62	21.61	21.65
15	36	39		21.56	21.57	21.63
15	75	0		21.58	21.63	21.64
15	1	0	16-QAM	21.81	21.75	21.79
15	1	37		21.94	21.94	21.97
15	1	74		21.71	21.71	21.70
15	36	0		20.56	20.64	20.61
15	36	20		20.61	20.63	20.63
15	36	39		20.55	20.58	20.61
15	75	0		20.55	20.61	20.59
15	1	0	64QAM	20.77	20.67	20.66
15	1	37		20.87	20.90	20.84
15	1	74		20.59	20.58	20.64
15	36	0		19.57	19.61	19.60
15	36	20		19.58	19.61	19.62
15	36	39		19.55	19.59	19.60
15	75	0		19.54	19.59	19.60



LTE Band 2 Maximum Average Power [dBm]						
BW [MHz]	RB Size	RB Offset	Mod	Lowest	Middle	Highest
10	1	0	QPSK	22.50	22.50	22.49
10	1	25		22.60	22.63	22.64
10	1	49		22.42	22.43	22.48
10	25	0		21.55	21.61	21.63
10	25	12		21.60	21.64	21.63
10	25	25		21.59	21.56	21.60
10	50	0		21.60	21.61	21.60
10	1	0	16-QAM	21.83	21.80	21.78
10	1	25		21.90	21.95	21.87
10	1	49		21.74	21.77	21.78
10	25	0		20.51	20.59	20.59
10	25	12		20.59	20.59	20.58
10	25	25		20.55	20.55	20.54
10	50	0		20.54	20.58	20.56
10	1	0	64QAM	20.73	20.72	20.65
10	1	25		20.81	20.82	20.79
10	1	49		20.62	20.61	20.67
10	25	0		19.53	19.59	19.56
10	25	12		19.57	19.59	19.59
10	25	25		19.56	19.55	19.57
10	50	0		19.53	19.56	19.55
5	1	0	QPSK	22.41	22.39	22.35
5	1	12		22.64	22.66	22.65
5	1	24		22.33	22.36	22.37
5	12	0		21.50	21.56	21.53
5	12	7		21.59	21.59	21.62
5	12	13		21.58	21.56	21.58
5	25	0		21.54	21.53	21.56
5	1	0	16-QAM	21.74	21.75	21.65
5	1	12		22.00	21.93	21.95
5	1	24		21.68	21.65	21.67
5	12	0		20.50	20.56	20.54
5	12	7		20.62	20.60	20.62



5	12	13		20.58	20.57	20.58
5	25	0		20.51	20.51	20.51
5	1	0	64QAM	20.62	20.61	20.55
5	1	12		20.89	20.88	20.86
5	1	24		20.58	20.55	20.55
5	12	0		19.53	19.54	19.50
5	12	7		19.60	19.57	19.61
5	12	13		19.56	19.55	19.55
5	25	0		19.52	19.52	19.51



LTE Band 2 Maximum Average Power [dBm]						
BW [MHz]	RB Size	RB Offset	Mod	Lowest	Middle	Highest
3	1	0	QPSK	22.53	22.45	22.45
3	1	8		22.51	22.49	22.49
3	1	14		22.47	22.46	22.47
3	8	0		21.61	21.58	21.60
3	8	4		21.62	21.59	21.62
3	8	7		21.57	21.57	21.58
3	15	0		21.58	21.56	21.57
3	1	0	16-QAM	21.83	21.77	21.72
3	1	8		21.84	21.83	21.77
3	1	14		21.80	21.80	21.74
3	8	0		20.63	20.60	20.60
3	8	4		20.63	20.61	20.63
3	8	7		20.59	20.56	20.56
3	15	0		20.54	20.53	20.56
3	1	0	64QAM	20.73	20.68	20.64
3	1	8		20.76	20.70	20.72
3	1	14		20.69	20.69	20.65
3	8	0		19.58	19.55	19.56
3	8	4		19.58	19.58	19.57
3	8	7		19.56	19.55	19.55
3	15	0		19.54	19.53	19.52
1.4	1	0	QPSK	22.62	22.62	22.35
1.4	1	3		22.63	22.66	22.39
1.4	1	5		22.63	22.54	22.30
1.4	3	0		22.69	22.53	22.37
1.4	3	1		22.64	22.66	22.42
1.4	3	3		22.60	22.49	22.39
1.4	6	0		21.80	21.69	21.47
1.4	1	0	16-QAM	21.96	21.71	21.58
1.4	1	3		22.04	21.87	21.74
1.4	1	5		21.95	21.86	21.61
1.4	3	0		21.79	21.61	21.42
1.4	3	1		21.81	21.55	21.49



1.4	3	3	64QAM	21.78	21.60	21.42
1.4	6	0		20.84	20.72	20.47
1.4	1	0		20.85	20.60	20.48
1.4	1	3		20.89	20.67	20.56
1.4	1	5		20.89	20.49	20.48
1.4	3	0		20.80	20.66	20.48
1.4	3	1		20.87	20.59	20.50
1.4	3	3		20.80	20.52	20.46
1.4	6	0		19.77	19.61	19.43



LTE Band 4 Maximum Average Power [dBm]						
BW [MHz]	RB Size	RB Offset	Mod	Lowest	Middle	Highest
20	1	0	QPSK	22.36	22.33	22.29
20	1	49		22.64	22.75	22.60
20	1	99		22.29	22.28	22.28
20	50	0		21.62	21.64	21.65
20	50	24		21.62	21.63	21.61
20	50	50		21.62	21.50	21.51
20	100	0		21.58	21.55	21.55
20	1	0	16-QAM	21.58	21.53	21.52
20	1	49		21.85	21.82	21.80
20	1	99		21.40	21.53	21.54
20	50	0		20.57	20.58	20.61
20	50	24		20.54	20.54	20.53
20	50	50		20.58	20.46	20.46
20	100	0		20.53	20.47	20.46
20	1	0	64-QAM	20.51	20.44	20.38
20	1	49		20.75	20.71	20.72
20	1	99		20.26	20.32	20.34
20	50	0		19.54	19.56	19.59
20	50	24		19.54	19.54	19.53
20	50	50		19.56	19.43	19.45
20	100	0		19.53	19.48	19.48
15	1	0	QPSK	22.54	22.52	22.46
15	1	37		22.72	22.68	22.61
15	1	74		22.41	22.37	22.34
15	36	0		21.58	21.58	21.58
15	36	20		21.57	21.56	21.56
15	36	39		21.54	21.51	21.44
15	75	0		21.55	21.56	21.55
15	1	0	16-QAM	21.79	21.68	21.66
15	1	37		21.97	21.88	21.84
15	1	74		21.61	21.53	21.56
15	36	0		20.53	20.54	20.57
15	36	20		20.54	20.54	20.51



15	36	39	64-QAM	20.49	20.44	20.41
15	75	0		20.50	20.50	20.48
15	1	0		20.69	20.61	20.56
15	1	37		20.86	20.77	20.70
15	1	74		20.53	20.48	20.46
15	36	0		19.52	19.53	19.54
15	36	20		19.53	19.53	19.51
15	36	39		19.50	19.43	19.41
15	75	0		19.52	19.49	19.50



LTE Band 4 Maximum Average Power [dBm]						
BW [MHz]	RB Size	RB Offset	Mod	Lowest	Middle	Highest
10	1	0	QPSK	22.53	22.51	22.47
10	1	25		22.61	22.58	22.50
10	1	49		22.47	22.42	22.37
10	25	0		21.49	21.55	21.55
10	25	12		21.55	21.53	21.50
10	25	25		21.52	21.49	21.45
10	50	0		21.52	21.53	21.51
10	1	0	16-QAM	21.76	21.70	21.66
10	1	25		21.82	21.76	21.73
10	1	49		21.61	21.59	21.59
10	25	0		20.45	20.48	20.48
10	25	12		20.48	20.47	20.44
10	25	25		20.48	20.42	20.42
10	50	0		20.48	20.43	20.43
10	1	0	64-QAM	20.68	20.63	20.59
10	1	25		20.73	20.63	20.62
10	1	49		20.56	20.49	20.47
10	25	0		19.48	19.45	19.47
10	25	12		19.48	19.46	19.45
10	25	25		19.47	19.43	19.41
10	50	0		19.46	19.43	19.44
5	1	0	QPSK	22.29	22.22	22.31
5	1	12		22.62	22.43	22.62
5	1	24		22.31	22.16	22.25
5	12	0		21.84	21.76	21.88
5	12	7		21.81	21.84	21.79
5	12	13		21.76	21.83	21.69
5	25	0		21.84	21.82	21.51
5	1	0	16-QAM	22.14	21.97	21.88
5	1	12		22.29	22.23	21.91
5	1	24		22.16	21.99	21.93
5	12	0		20.97	20.97	20.54
5	12	7		20.95	20.98	20.61



5	12	13	64-QAM	20.85	20.81	20.59
5	25	0		20.97	20.73	20.53
5	1	0		21.04	20.83	21.09
5	1	12		21.33	21.19	21.13
5	1	24		20.83	20.95	21.09
5	12	0		19.75	19.92	19.53
5	12	7		19.81	19.91	19.61
5	12	13		19.79	19.76	19.57
5	25	0		19.73	19.73	19.52



LTE Band 4 Maximum Average Power [dBm]						
BW [MHz]	RB Size	RB Offset	Mod	Lowest	Middle	Highest
3	1	0	QPSK	22.58	22.52	22.45
3	1	8		22.54	22.52	22.47
3	1	14		22.51	22.50	22.45
3	8	0		21.56	21.53	21.50
3	8	4		21.58	21.56	21.51
3	8	7		21.38	21.52	21.48
3	15	0		21.35	21.49	21.47
3	1	0	16-QAM	21.61	21.70	21.70
3	1	8		21.65	21.72	21.73
3	1	14		21.78	21.70	21.67
3	8	0		20.58	20.50	20.51
3	8	4		20.56	20.54	20.54
3	8	7		20.43	20.51	20.48
3	15	0		20.48	20.46	20.46
3	1	0	64-QAM	20.69	20.62	20.57
3	1	8		20.70	20.65	20.61
3	1	14		20.48	20.61	20.59
3	8	0		19.32	19.48	19.46
3	8	4		19.34	19.52	19.48
3	8	7		19.33	19.49	19.44
3	15	0		19.29	19.47	19.43
1.4	1	0	QPSK	22.53	22.51	22.45
1.4	1	3		22.68	22.66	22.62
1.4	1	5		22.55	22.52	22.48
1.4	3	0		22.65	22.60	22.55
1.4	3	1		22.72	22.67	22.62
1.4	3	3		22.65	22.62	22.57
1.4	6	0		21.69	21.62	21.60
1.4	1	0	16-QAM	21.82	21.74	21.71
1.4	1	3		21.96	21.84	21.85
1.4	1	5		21.84	21.76	21.71
1.4	3	0		21.66	21.59	21.56
1.4	3	1		21.71	21.54	21.65



1.4	3	3	64-QAM	21.65	21.59	21.55
1.4	6	0		20.71	20.59	20.59
1.4	1	0		20.70	20.60	20.59
1.4	1	3		20.86	20.76	20.73
1.4	1	5		20.74	20.61	20.61
1.4	3	0		20.71	20.64	20.61
1.4	3	1		20.73	20.69	20.66
1.4	3	3		20.69	20.63	20.59
1.4	6	0		19.64	19.55	19.53



ERP/EIRP

LTE Band 2 (GT - LC = -0.67 dB) QPSK									
Bandwidth	1.4M			3M			5M		
Channel	18607	18900	19193	18615	18900	19185	18625	18900	19175
	(Low)	(Mid)	(High)	(Low)	(Mid)	(High)	(Low)	(Mid)	(High)
Frequency	1850.7	1880	1909.3	1851.5	1880	1908.5	1852.5	1880	1907.5
(MHz)									
Conducted Power (dBm)	22.69	22.53	22.37	22.53	22.45	22.45	22.64	22.66	22.65
Conducted Power (Watts)	0.1858	0.1791	0.1726	0.1791	0.1758	0.1758	0.1837	0.1845	0.1841
EIRP(dBm)	22.02	21.86	21.70	21.86	21.78	21.78	21.97	21.99	21.98
EIRP(Watts)	0.1592	0.1535	0.1479	0.1535	0.1507	0.1507	0.1574	0.1581	0.1578

LTE Band 2 (GT - LC = -0.67 dB) QPSK									
Bandwidth	10M			15M			20M		
Channel	18650	18900	19150	18675	18900	19125	18650	18900	19100
	(Low)	(Mid)	(High)	(Low)	(Mid)	(High)	(Low)	(Mid)	(High)
Frequency	1855	1880	1905	1857.5	1880	1902.5	1860	1880	1900
(MHz)									
Conducted Power (dBm)	22.60	22.63	22.64	22.67	22.69	22.66	22.62	22.70	22.65
Conducted Power (Watts)	0.1820	0.1832	0.1837	0.1849	0.1858	0.1845	0.1828	0.1862	0.1841
EIRP(dBm)	21.93	21.96	21.97	22.00	22.02	21.99	21.95	22.03	21.98
EIRP(Watts)	0.1560	0.1570	0.1574	0.1585	0.1592	0.1581	0.1567	0.1596	0.1578



LTE Band 2 (GT - LC = -0.67 dB) 16QAM									
Bandwidth	1.4M			3M			5M		
Channel	18607	18900	19193	18615	18900	19185	18625	18900	19175
	(Low)	(Mid)	(High)	(Low)	(Mid)	(High)	(Low)	(Mid)	(High)
Frequency (MHz)	1850.7	1880	1909.3	1851.5	1880	1908.5	1852.5	1880	1907.5
Conducted Power (dBm)	22.04	21.87	21.74	21.84	21.83	21.77	22.00	21.93	21.95
Conducted Power (Watts)	0.1600	0.1538	0.1493	0.1528	0.1524	0.1503	0.1585	0.1560	0.1567
EIRP(dBm)	21.37	21.20	21.07	21.17	21.16	21.10	21.33	21.26	21.28
EIRP(Watts)	0.1371	0.1318	0.1279	0.1309	0.1306	0.1288	0.1358	0.1337	0.1343

LTE Band 2 (GT - LC = -0.67 dB) 16QAM									
Bandwidth	10M			15M			20M		
Channel	18650	18900	19150	18675	18900	19125	18650	18900	19100
	(Low)	(Mid)	(High)	(Low)	(Mid)	(High)	(Low)	(Mid)	(High)
Frequency (MHz)	1855	1880	1905	1857.5	1880	1902.5	1860	1880	1900
Conducted Power (dBm)	21.90	21.95	21.87	21.94	21.94	21.97	21.90	21.96	21.98
Conducted Power (Watts)	0.1549	0.1567	0.1538	0.1563	0.1563	0.1574	0.1549	0.1570	0.1578
EIRP(dBm)	21.23	21.28	21.20	21.27	21.27	21.30	21.23	21.29	21.31
EIRP(Watts)	0.1327	0.1343	0.1318	0.1340	0.1340	0.1349	0.1327	0.1346	0.1352



LTE Band 2 (GT - LC = -0.67 dB) 64QAM									
Bandwidth	1.4M			3M			5M		
Channel	18607	18900	19193	18615	18900	19185	18625	18900	19175
	(Low)	(Mid)	(High)	(Low)	(Mid)	(High)	(Low)	(Mid)	(High)
Frequency (MHz)	1850.7	1880	1909.3	1851.5	1880	1908.5	1852.5	1880	1907.5
Conducted Power (dBm)	20.89	20.67	20.56	20.76	20.70	20.72	20.89	20.88	20.86
Conducted Power (Watts)	0.1227	0.1167	0.1138	0.1191	0.1175	0.1180	0.1227	0.1225	0.1219
EIRP(dBm)	20.22	20.00	19.89	20.09	20.03	20.05	20.22	20.21	20.19
EIRP(Watts)	0.1052	0.1000	0.0975	0.1021	0.1007	0.1012	0.1052	0.1050	0.1045

LTE Band 2 (GT - LC = -0.67 dB) 64QAM									
Bandwidth	10M			15M			20M		
Channel	18650	18900	19150	18675	18900	19125	18650	18900	19100
	(Low)	(Mid)	(High)	(Low)	(Mid)	(High)	(Low)	(Mid)	(High)
Frequency (MHz)	1855	1880	1905	1857.5	1880	1902.5	1860	1880	1900
Conducted Power (dBm)	20.81	20.82	20.79	20.87	20.90	20.84	20.79	20.82	20.84
Conducted Power (Watts)	0.1205	0.1208	0.1199	0.1222	0.1230	0.1213	0.1199	0.1208	0.1213
EIRP(dBm)	20.14	20.15	20.12	20.20	20.23	20.17	20.12	20.15	20.17
EIRP(Watts)	0.1033	0.1035	0.1028	0.1047	0.1054	0.1040	0.1028	0.1035	0.1040



LTE Band 4 (GT - LC = -0.50 dB) QPSK									
Bandwidth	1.4M			3M			5M		
Channel	19957	20175	20393	19965	20175	20385	19975	20175	20375
	(Low)	(Mid)	(High)	(Low)	(Mid)	(High)	(Low)	(Mid)	(High)
Frequency (MHz)	1710.7	1732.5	1754.3	1711.5	1732.5	1753.5	1712.5	1732.5	1752.5
Conducted Power (dBm)	22.72	22.67	22.62	22.58	22.52	22.45	22.62	22.43	22.62
Conducted Power (Watts)	0.1871	0.1849	0.1828	0.1811	0.1786	0.1758	0.1828	0.1750	0.1828
EIRP(dBm)	22.22	22.17	22.12	22.08	22.02	21.95	22.12	21.93	22.12
EIRP(Watts)	0.1667	0.1648	0.1629	0.1614	0.1592	0.1567	0.1629	0.1560	0.1629

LTE Band 4 (GT - LC = -0.50 dB) QPSK									
Bandwidth	10M			15M			20M		
Channel	20000	20175	20350	20025	20175	20325	20050	20175	20300
	(Low)	(Mid)	(High)	(Low)	(Mid)	(High)	(Low)	(Mid)	(High)
Frequency (MHz)	1715	1732.5	1750	1717.5	1732.5	1747.5	1720	1732.5	1745
Conducted Power (dBm)	22.61	22.58	22.50	22.72	22.68	22.61	22.64	22.75	22.60
Conducted Power (Watts)	0.1824	0.1811	0.1778	0.1871	0.1854	0.1824	0.1837	0.1884	0.1820
EIRP(dBm)	22.11	22.08	22.00	22.22	22.18	22.11	22.14	22.25	22.10
EIRP(Watts)	0.1626	0.1614	0.1585	0.1667	0.1652	0.1626	0.1637	0.1679	0.1622



LTE Band 4 (GT - LC = -0.50 dB) 16QAM									
Bandwidth	1.4M			3M			5M		
Channel	19957	20175	20393	19965	20175	20385	19975	20175	20375
	(Low)	(Mid)	(High)	(Low)	(Mid)	(High)	(Low)	(Mid)	(High)
Frequency (MHz)	1710.7	1732.5	1754.3	1711.5	1732.5	1753.5	1712.5	1732.5	1752.5
Conducted Power (dBm)	21.96	21.84	21.85	21.78	21.70	21.67	22.29	22.23	21.91
Conducted Power (Watts)	0.1570	0.1528	0.1531	0.1507	0.1479	0.1469	0.1694	0.1671	0.1552
EIRP(dBm)	21.46	21.34	21.35	21.28	21.20	21.17	21.79	21.73	21.41
EIRP(Watts)	0.1400	0.1361	0.1365	0.1343	0.1318	0.1309	0.1510	0.1489	0.1384

LTE Band 4 (GT - LC = -0.50 dB) 16QAM									
Bandwidth	10M			15M			20M		
Channel	20000	20175	20350	20025	20175	20325	20050	20175	20300
	(Low)	(Mid)	(High)	(Low)	(Mid)	(High)	(Low)	(Mid)	(High)
Frequency (MHz)	1715	1732.5	1750	1717.5	1732.5	1747.5	1720	1732.5	1745
Conducted Power (dBm)	21.82	21.76	21.73	21.97	21.88	21.84	21.85	21.82	21.80
Conducted Power (Watts)	0.1521	0.1500	0.1489	0.1574	0.1542	0.1528	0.1531	0.1521	0.1514
EIRP(dBm)	21.32	21.26	21.23	21.47	21.38	21.34	21.35	21.32	21.30
EIRP(Watts)	0.1355	0.1337	0.1327	0.1403	0.1374	0.1361	0.1365	0.1355	0.1349



LTE Band 4 (GT - LC = -0.50 dB) 64QAM									
Bandwidth	1.4M			3M			5M		
Channel	19957	20175	20393	19965	20175	20385	19975	20175	20375
	(Low)	(Mid)	(High)	(Low)	(Mid)	(High)	(Low)	(Mid)	(High)
Frequency	1710.7	1732.5	1754.3	1711.5	1732.5	1753.5	1712.5	1732.5	1752.5
(MHz)									
Conducted Power (dBm)	20.86	20.76	20.73	20.70	20.65	20.61	21.33	21.19	21.13
Conducted Power (Watts)	0.1219	0.1191	0.1183	0.1175	0.1161	0.1151	0.1358	0.1315	0.1297
EIRP(dBm)	20.36	20.26	20.23	20.20	20.15	20.11	20.83	20.69	20.63
EIRP(Watts)	0.1086	0.1062	0.1054	0.1047	0.1035	0.1026	0.1211	0.1172	0.1156

LTE Band 4 (GT - LC = -0.50 dB) 64QAM									
Bandwidth	10M			15M			20M		
Channel	20000	20175	20350	20025	20175	20325	20050	20175	20300
	(Low)	(Mid)	(High)	(Low)	(Mid)	(High)	(Low)	(Mid)	(High)
Frequency	1715	1732.5	1750	1717.5	1732.5	1747.5	1720	1732.5	1745
(MHz)									
Conducted Power (dBm)	20.73	20.63	20.62	20.86	20.77	20.70	20.75	20.71	20.72
Conducted Power (Watts)	0.1183	0.1156	0.1153	0.1219	0.1194	0.1175	0.1189	0.1178	0.1180
EIRP(dBm)	20.23	20.13	20.12	20.36	20.27	20.20	20.25	20.21	20.22
EIRP(Watts)	0.1054	0.1030	0.1028	0.1086	0.1064	0.1047	0.1059	0.1050	0.1052



LTE Band 2

Conducted Band Edge

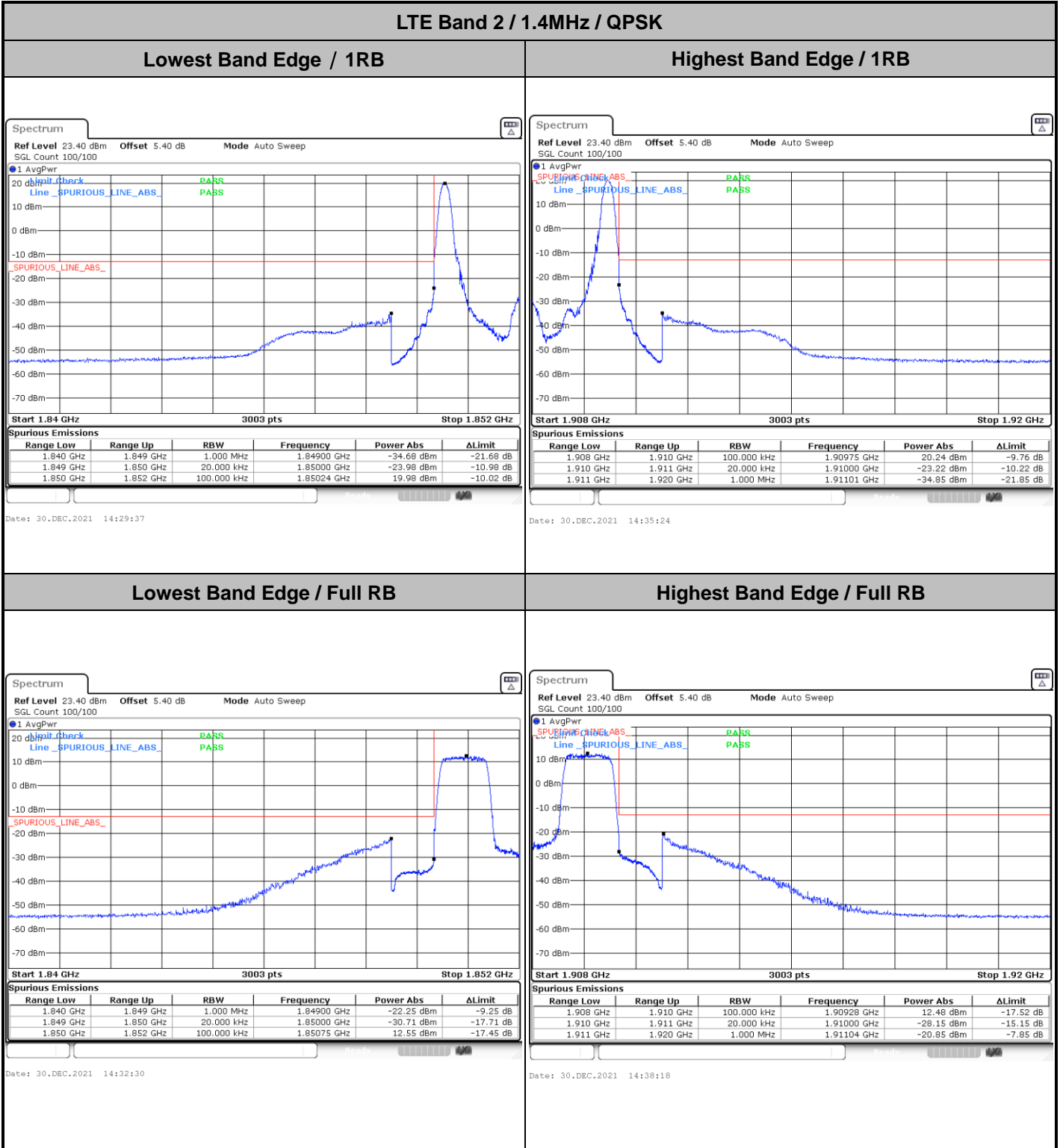



LTE Band 2 / 1.4MHz / 16QAM

Lowest Band Edge / 1 RB

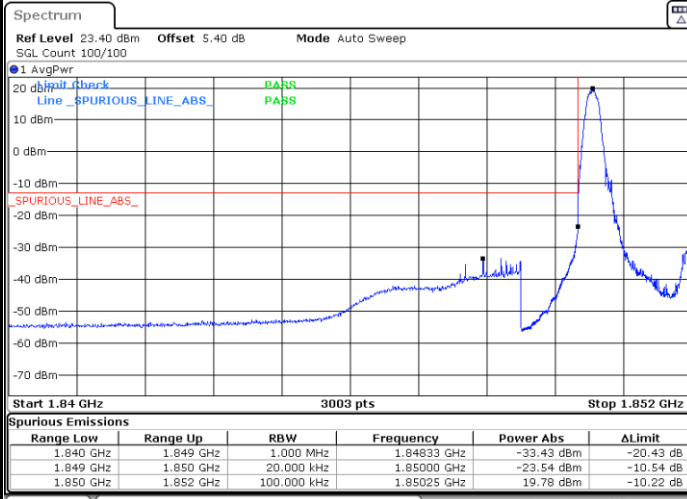

Date: 30.DEC.2021 14:31:02

Highest Band Edge / 1 RB

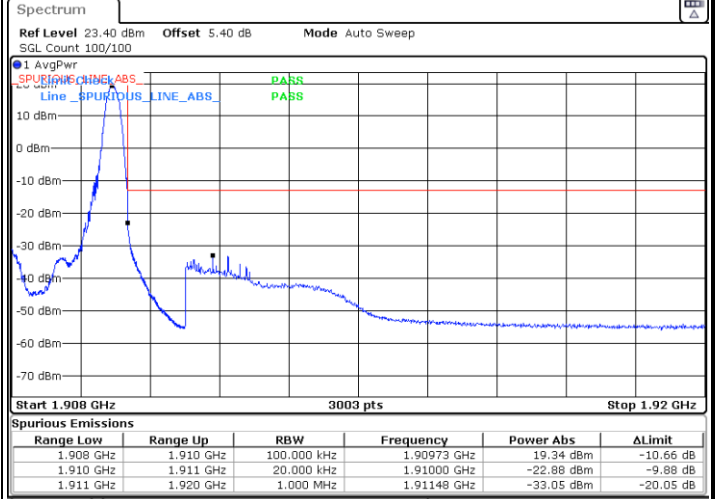

Date: 30.DEC.2021 14:36:51

Lowest Band Edge / Full RB

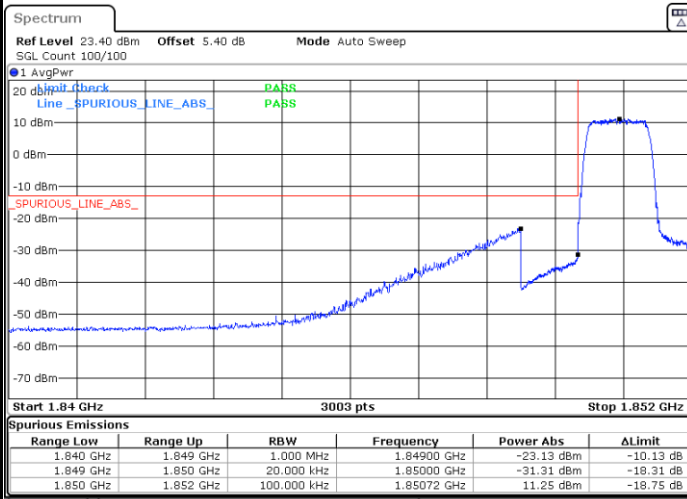

Date: 30.DEC.2021 14:33:57

Highest Band Edge / Full RB

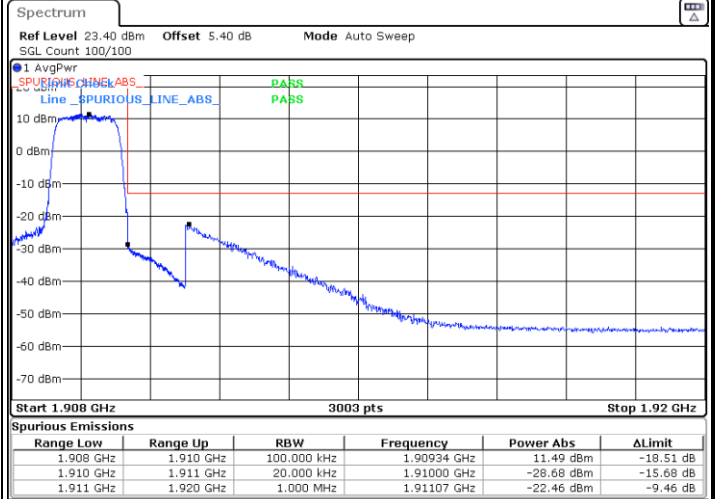

Date: 30.DEC.2021 14:39:46



LTE Band 2 / 1.4MHz / 64QAM

Lowest Band Edge / 1 RB

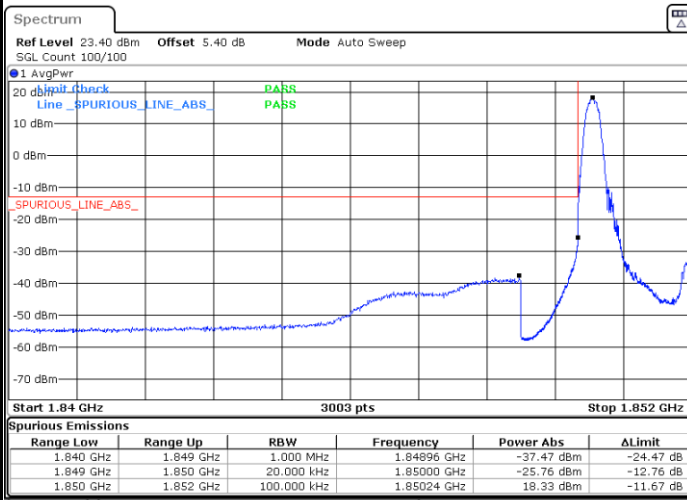

Date: 30.DEC.2021 17:27:29

Highest Band Edge / 1 RB

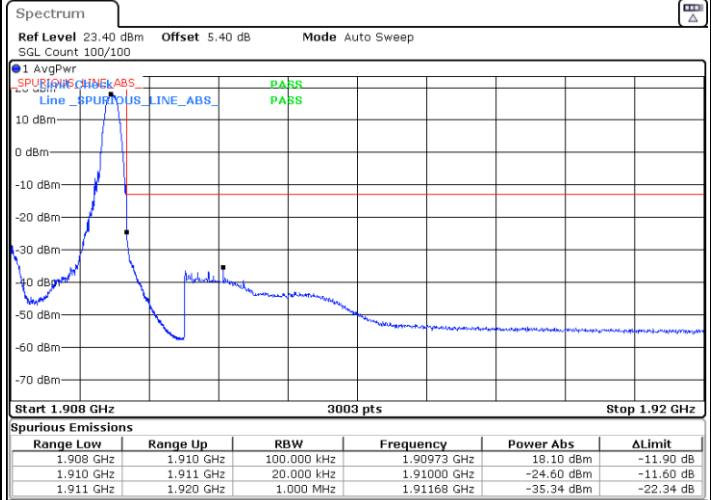

Date: 30.DEC.2021 17:30:22

Lowest Band Edge / Full RB

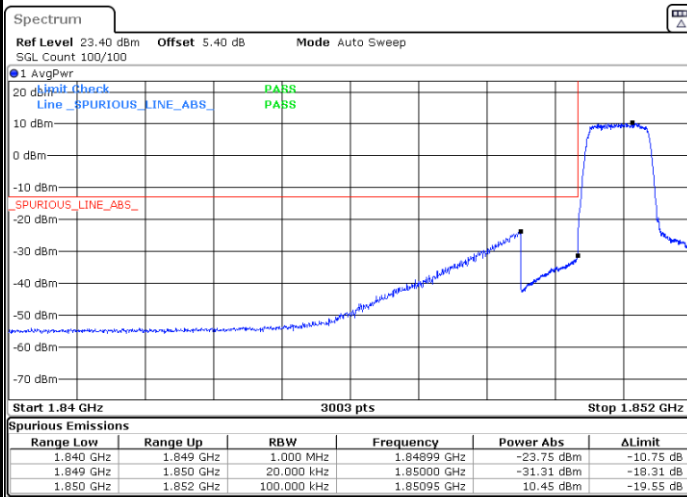

Date: 30.DEC.2021 17:28:55

Highest Band Edge / Full RB

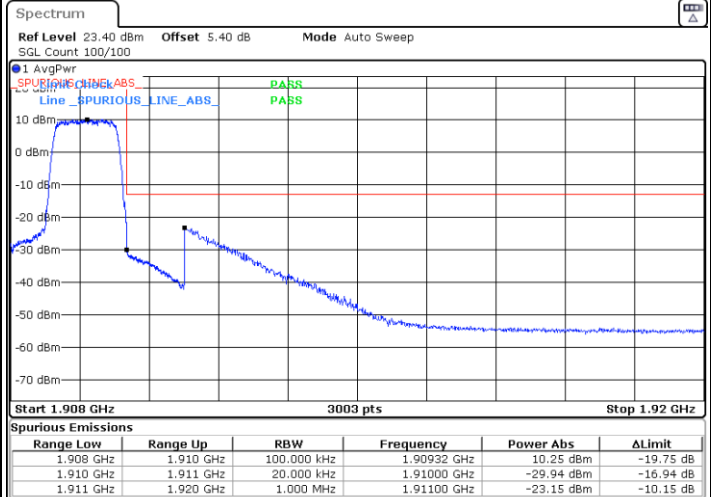

Date: 30.DEC.2021 17:31:49



LTE Band 2 / 3MHz / QPSK

Lowest Band Edge / 1RB

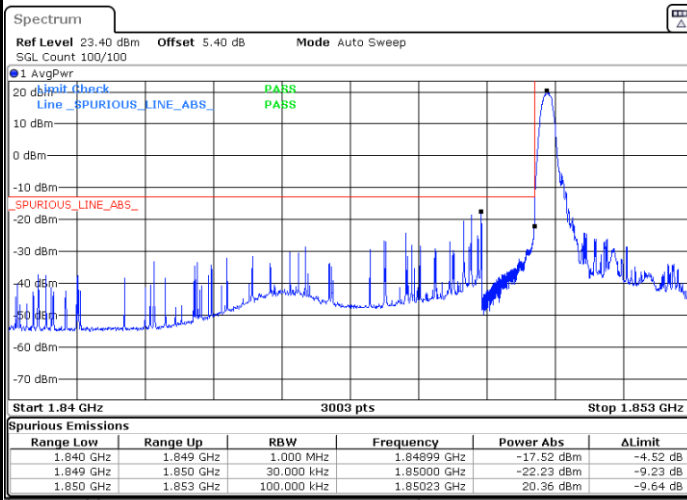

Date: 30.DEC.2021 14:41:14

Highest Band Edge / 1 RB

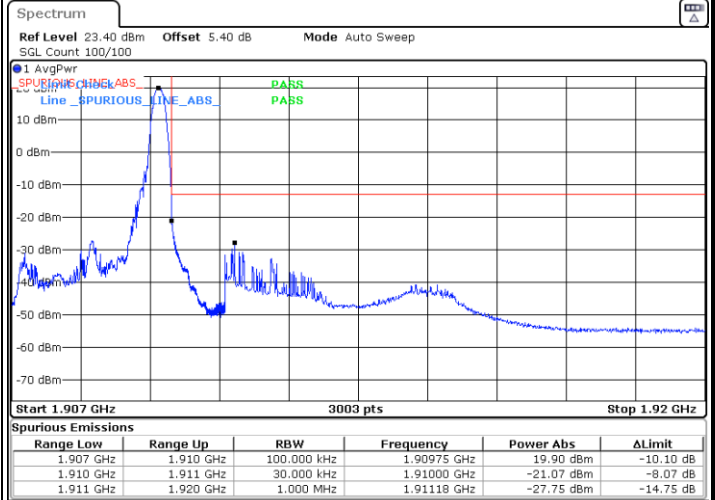

Date: 30.DEC.2021 14:47:03

Lowest Band Edge / Full RB

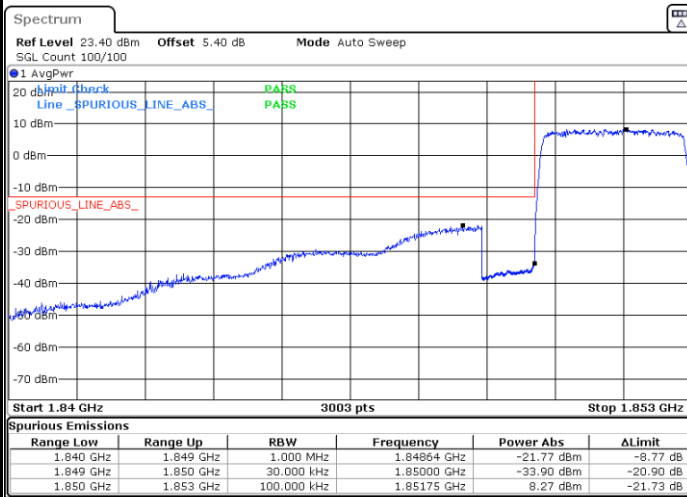

Date: 30.DEC.2021 14:44:09

Highest Band Edge / Full RB



Date: 30.DEC.2021 14:49:57



LTE Band 2 / 3MHz / 16QAM

Lowest Band Edge / 1 RB

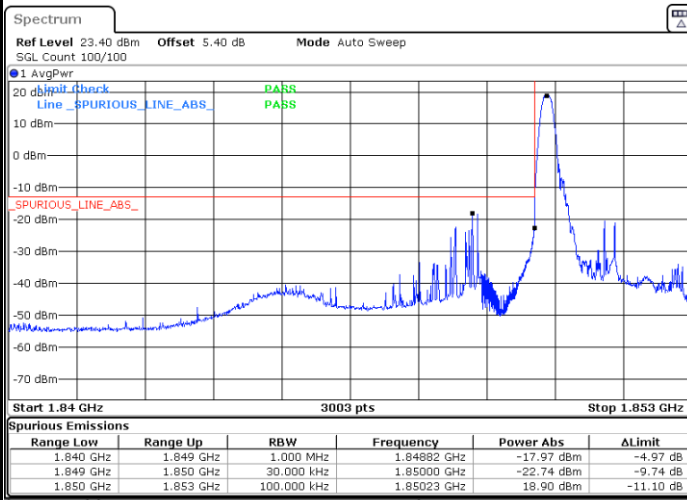

Date: 30.DEC.2021 14:42:41

Highest Band Edge / 1 RB

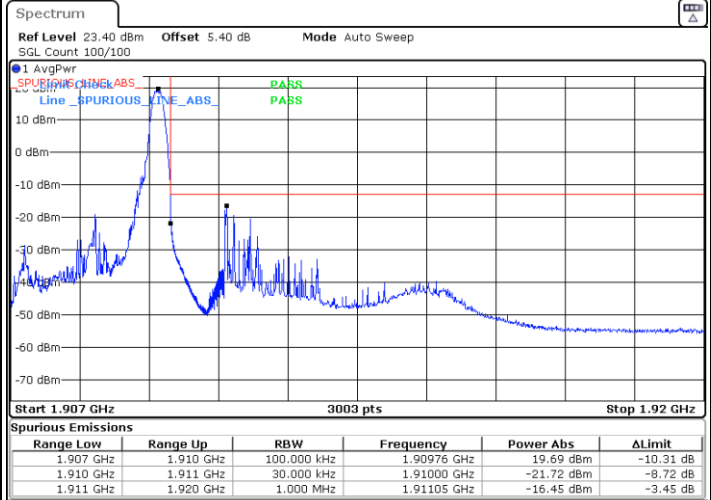

Date: 30.DEC.2021 14:48:30

Lowest Band Edge / Full RB

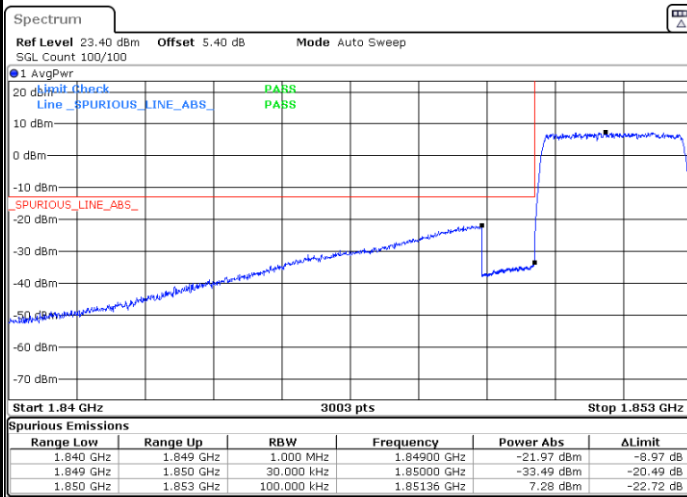

Date: 30.DEC.2021 14:45:36

Highest Band Edge / Full RB



Date: 30.DEC.2021 14:51:25



LTE Band 2 / 3MHz / 64QAM

Lowest Band Edge / 1 RB

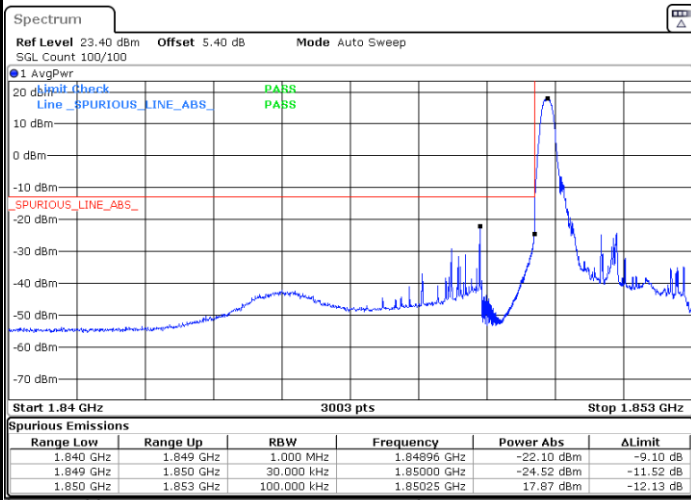

Date: 30.DEC.2021 17:33:15

Highest Band Edge / 1 RB

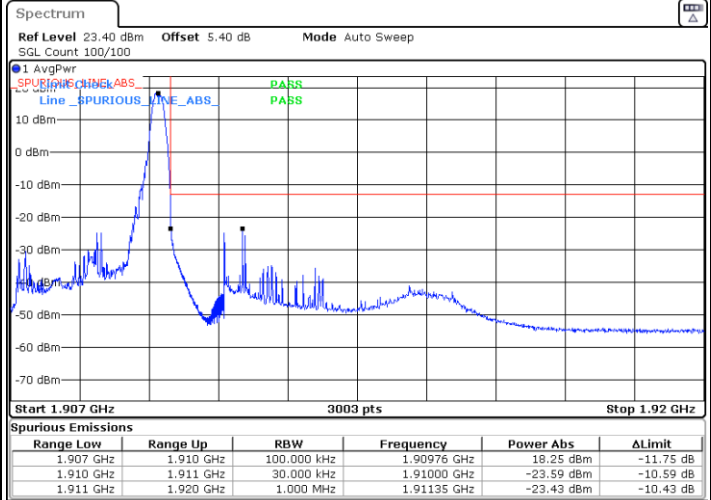

Date: 30.DEC.2021 17:36:09

Lowest Band Edge / Full RB

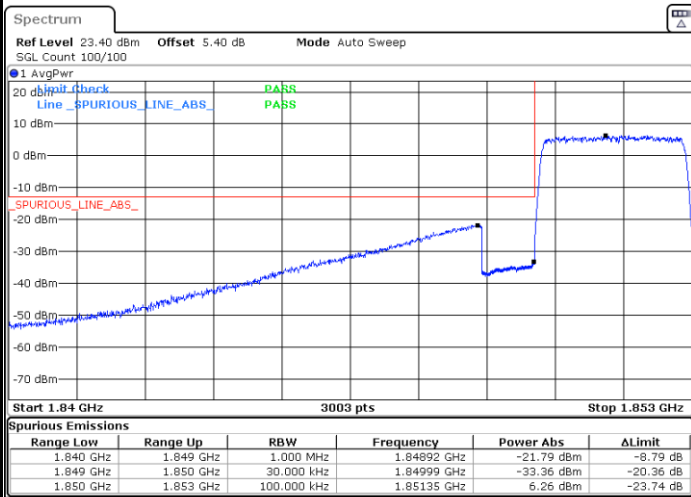

Date: 30.DEC.2021 17:34:42

Highest Band Edge / Full RB

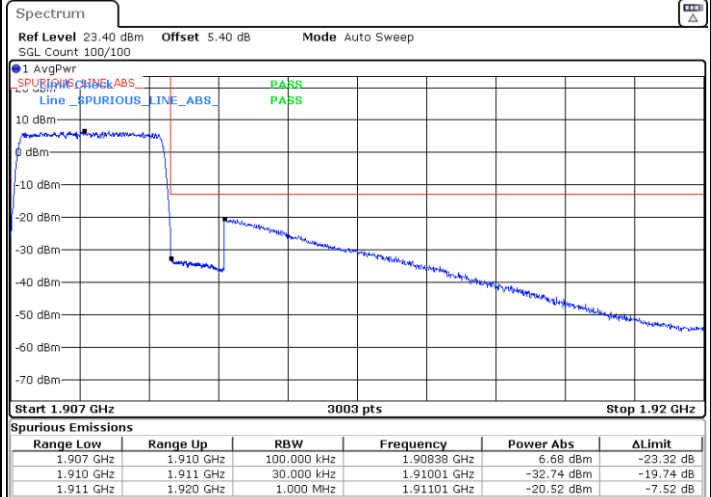

Date: 30.DEC.2021 17:37:35



LTE Band 2 / 5MHz / QPSK

Lowest Band Edge / 1 RB

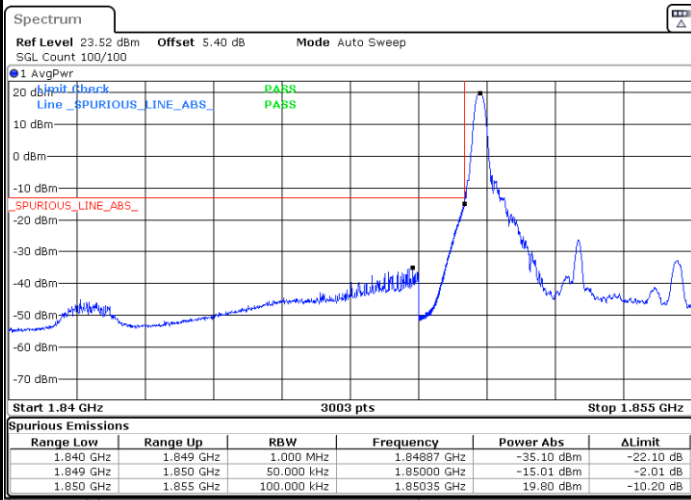

Date: 30.DEC.2021 14:52:52

Highest Band Edge / 1 RB

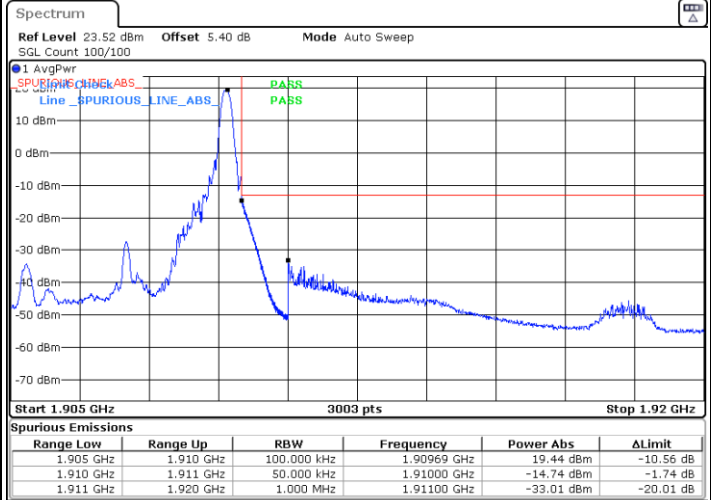

Date: 30.DEC.2021 14:58:41

Lowest Band Edge / Full RB

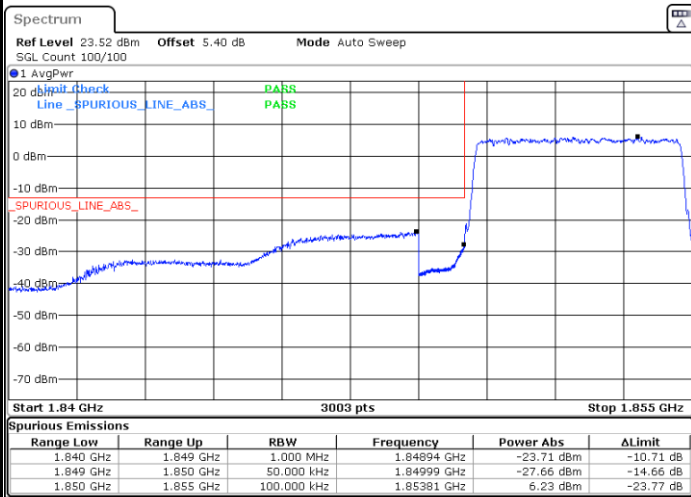

Date: 30.DEC.2021 14:55:47

Highest Band Edge / Full RB

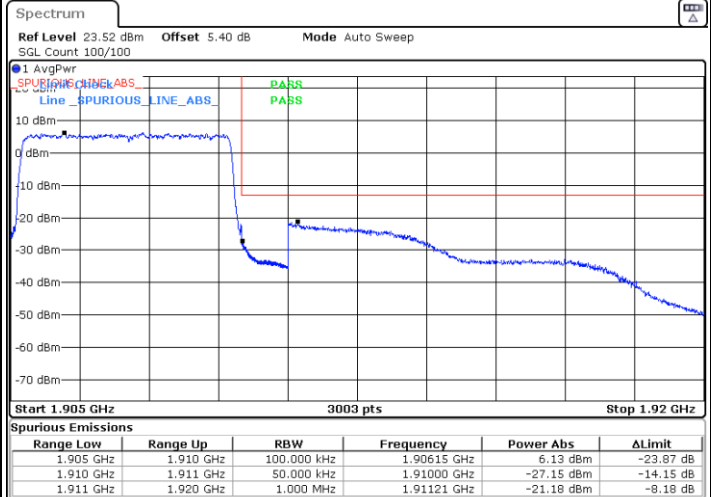

Date: 30.DEC.2021 16:49:47



LTE Band 2 / 5MHz / 16QAM

Lowest Band Edge / 1RB

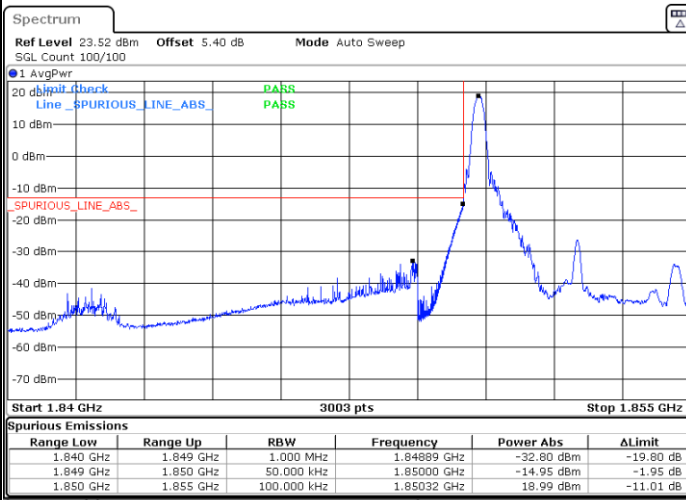

Date: 30.DEC.2021 14:54:20

Highest Band Edge / 1 RB

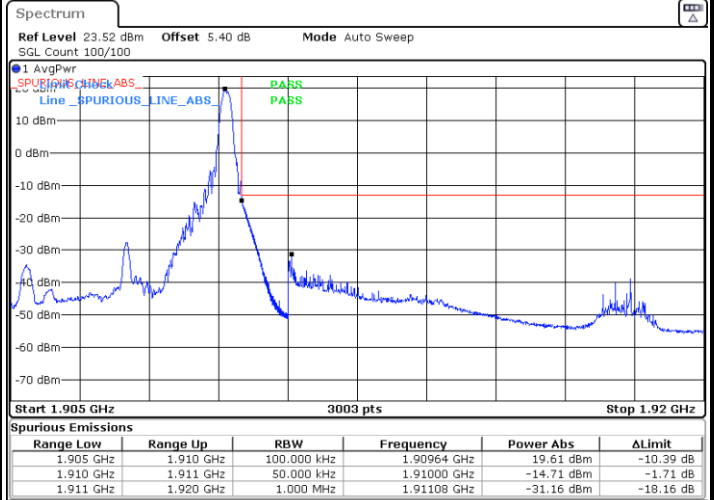

Date: 30.DEC.2021 16:48:20

Lowest Band Edge / Full RB

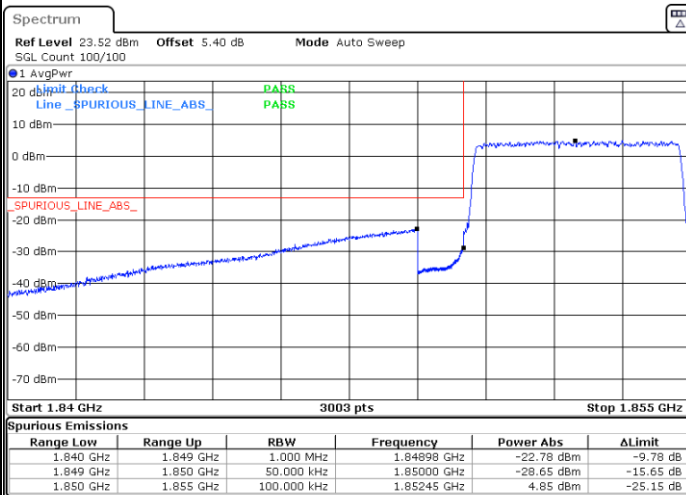

Date: 30.DEC.2021 14:57:14

Highest Band Edge / Full RB

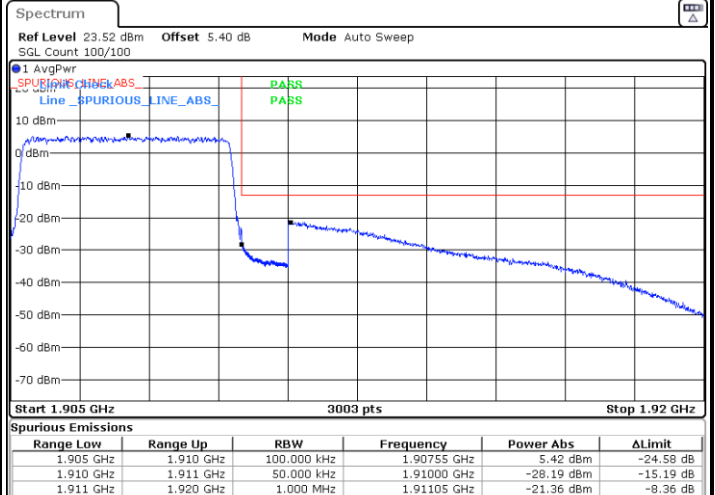

Date: 30.DEC.2021 16:51:15



LTE Band 2 / 5MHz / 64QAM

Lowest Band Edge / 1RB

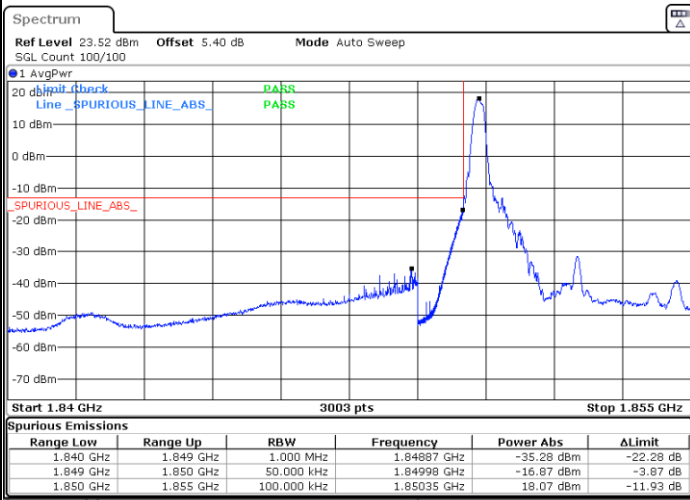

Date: 30.DEC.2021 17:39:02

Highest Band Edge / 1 RB

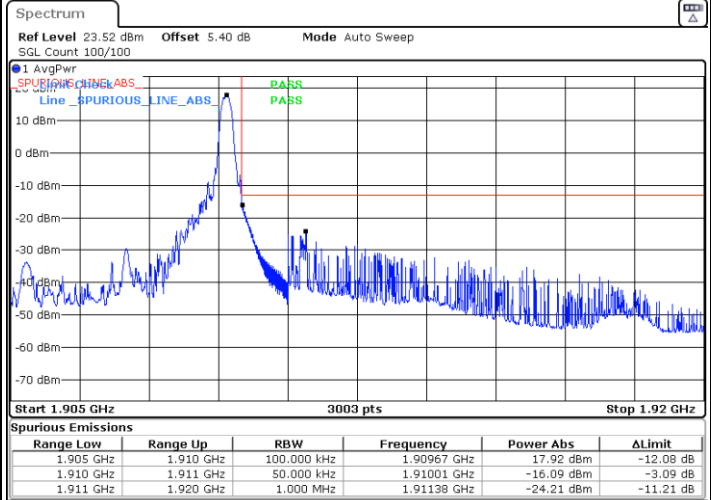

Date: 30.DEC.2021 17:41:55

Lowest Band Edge / Full RB

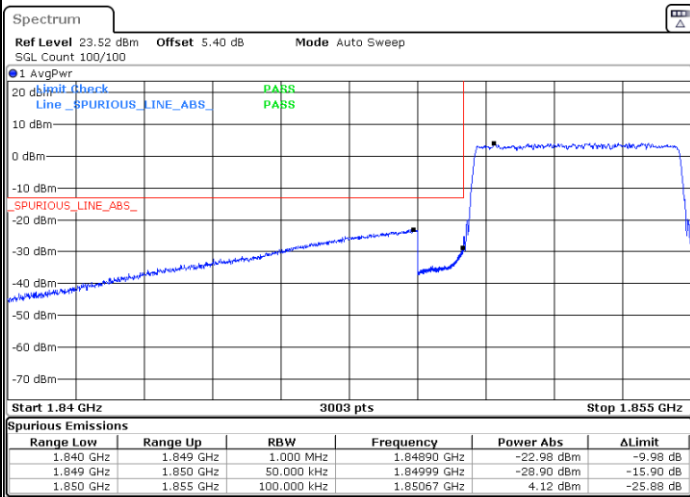

Date: 30.DEC.2021 17:40:28

Highest Band Edge / Full RB

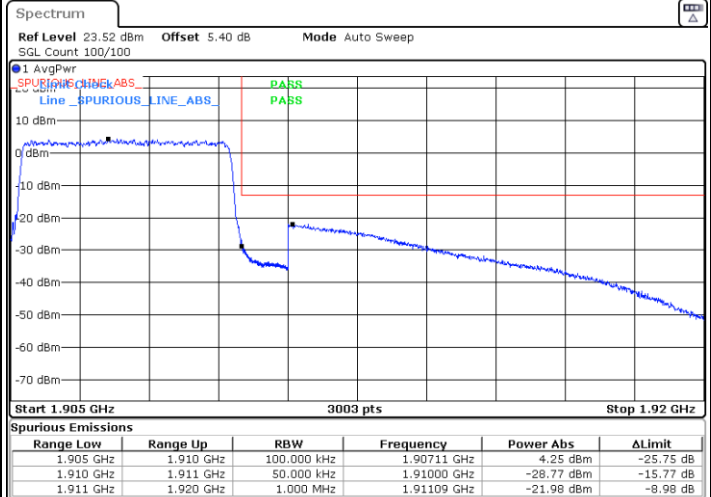

Date: 30.DEC.2021 17:43:22



LTE Band 2 / 10MHz / QPSK

Lowest Band Edge / 1 RB

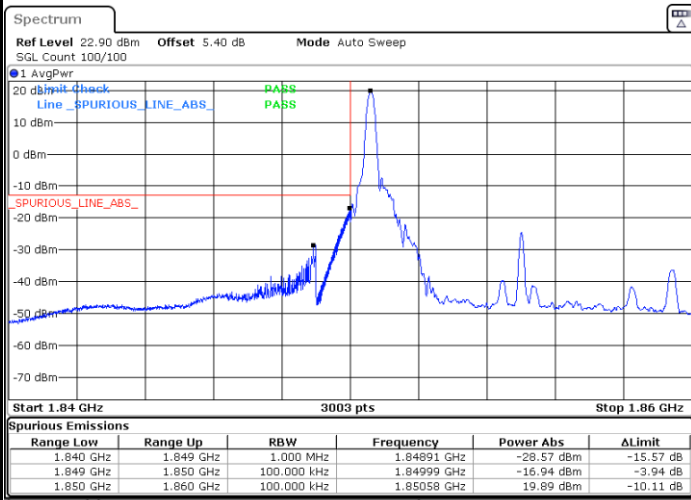

Date: 30.DEC.2021 16:52:42

Highest Band Edge / 1 RB

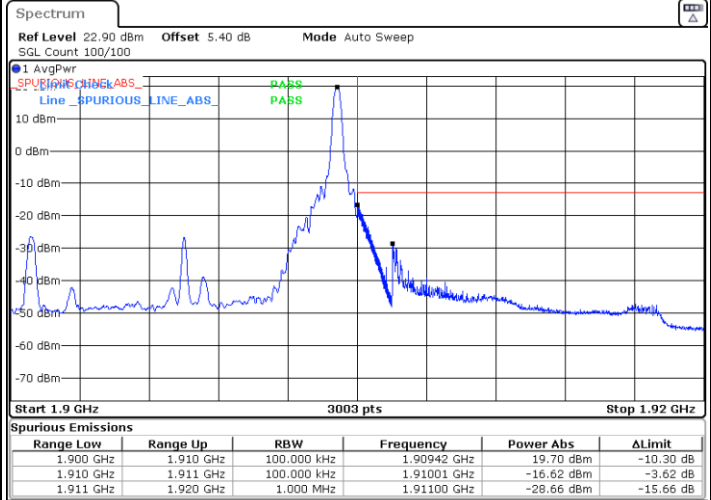

Date: 30.DEC.2021 16:58:30

Lowest Band Edge / Full RB

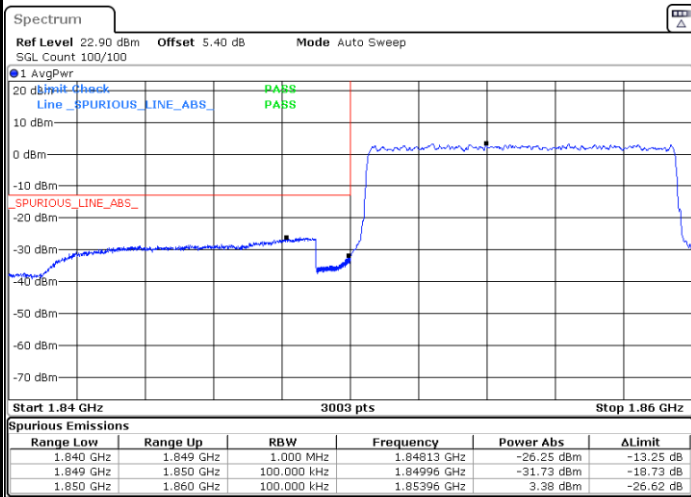

Date: 30.DEC.2021 16:55:36

Highest Band Edge / Full RB

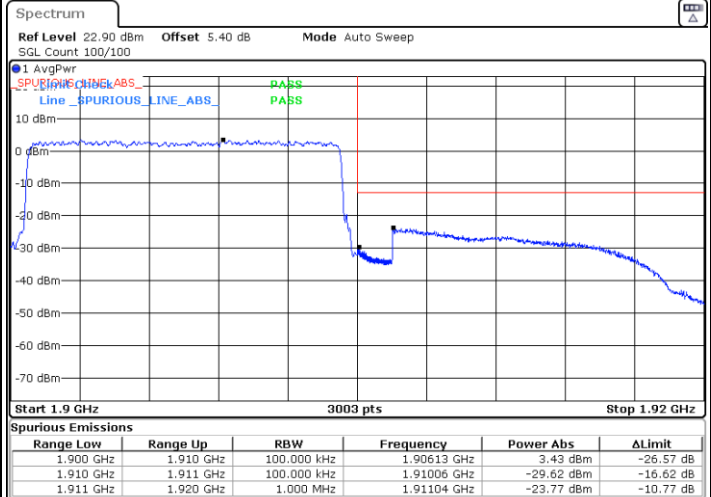

Date: 30.DEC.2021 17:01:23



LTE Band 2 / 10MHz / 16QAM

Lowest Band Edge / 1 RB

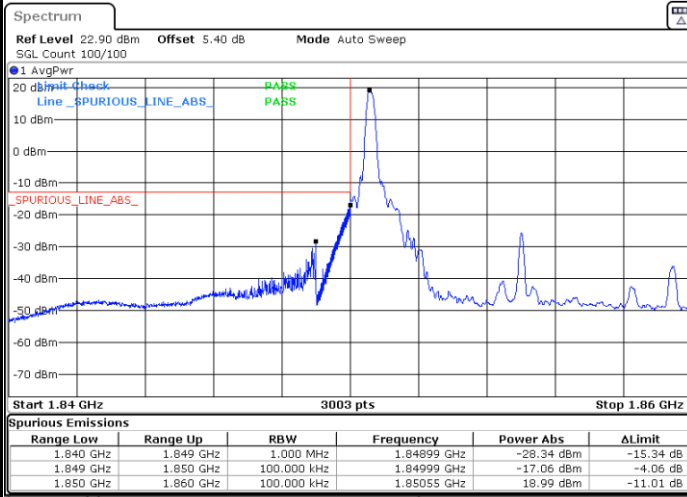

Date: 30.DEC.2021 16:54:09

Highest Band Edge / 1 RB

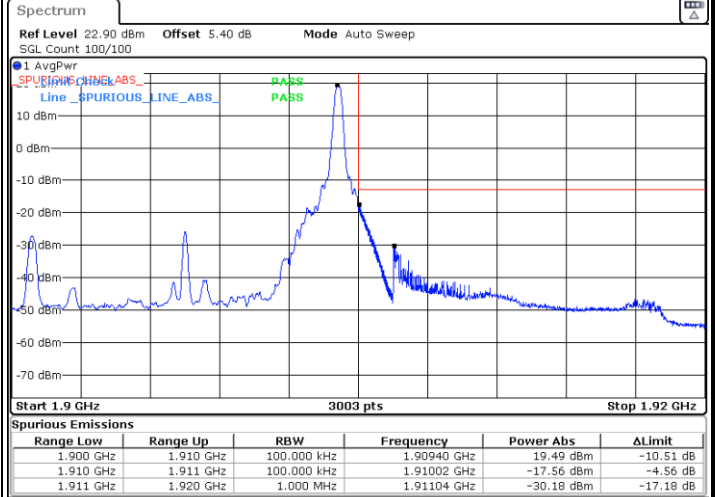

Date: 30.DEC.2021 16:59:56

Lowest Band Edge / Full RB

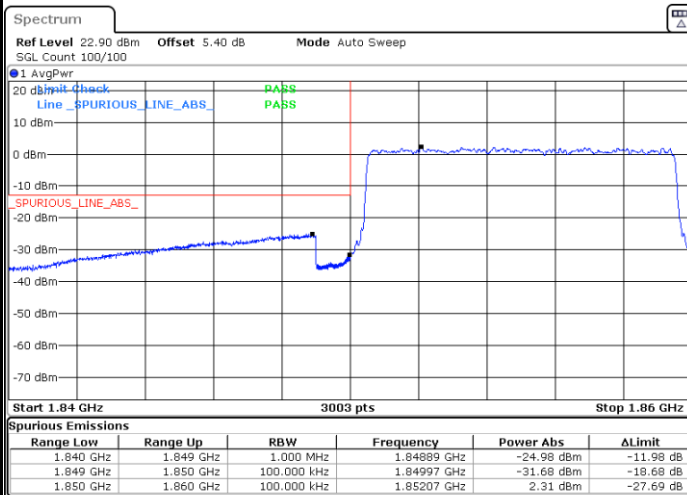

Date: 30.DEC.2021 16:57:03

Highest Band Edge / Full RB

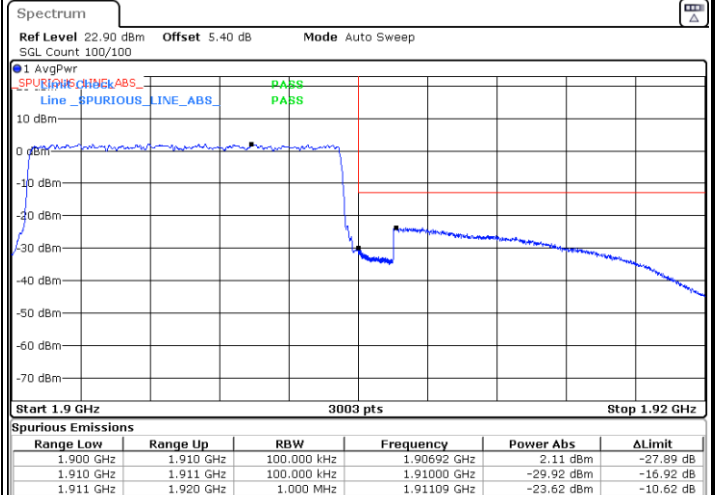

Date: 30.DEC.2021 17:02:50



LTE Band 2 / 10MHz / 64QAM

Lowest Band Edge / 1 RB

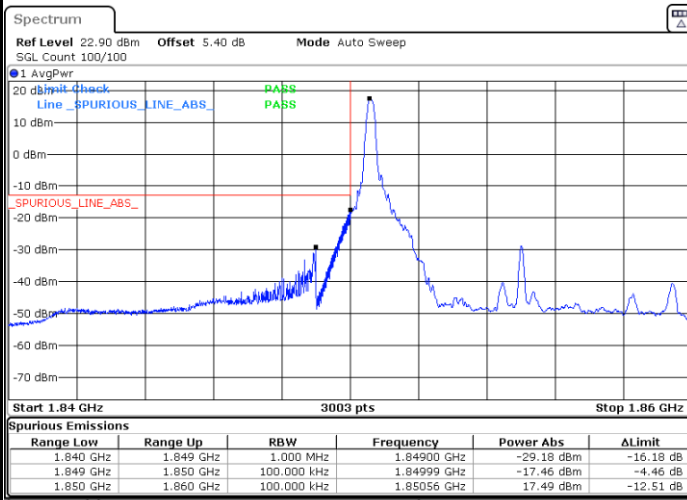

Date: 30.DEC.2021 17:44:48

Highest Band Edge / 1 RB

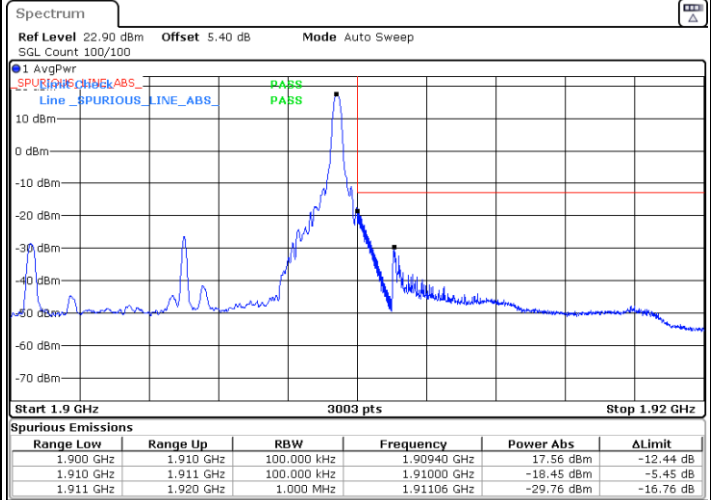

Date: 30.DEC.2021 17:47:41

Lowest Band Edge / Full RB

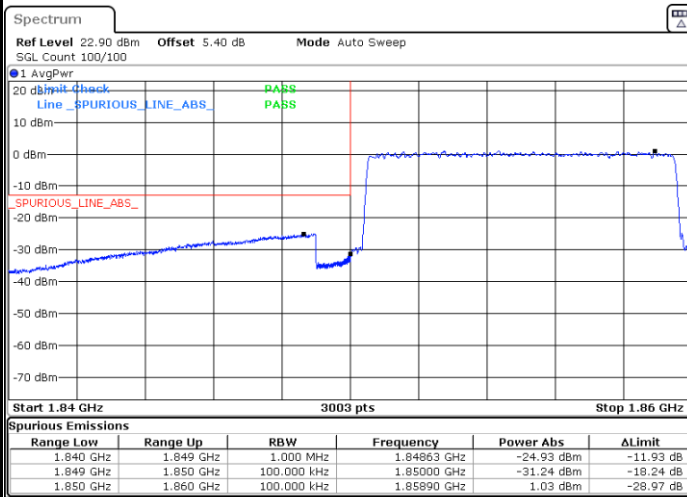

Date: 30.DEC.2021 17:46:15

Highest Band Edge / Full RB

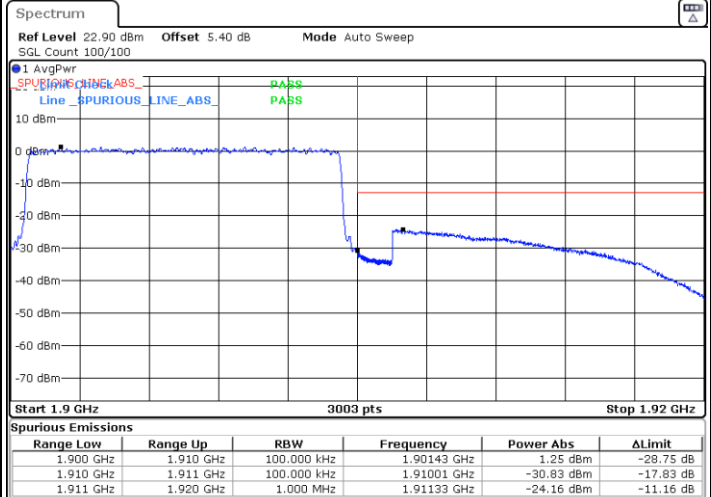

Date: 30.DEC.2021 17:49:08



LTE Band 2 / 15MHz / QPSK

Lowest Band Edge / 1 RB

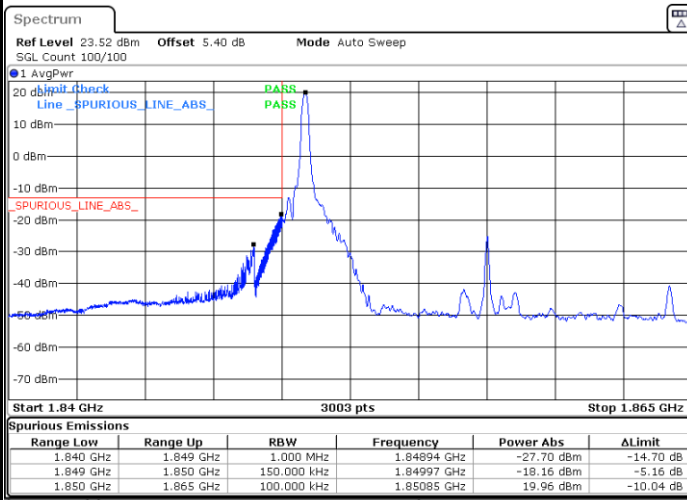

Date: 30.DEC.2021 17:04:17

Highest Band Edge / 1 RB

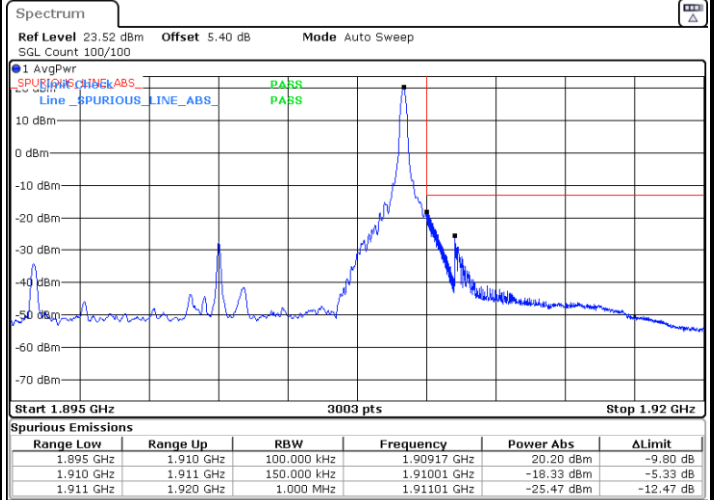

Date: 30.DEC.2021 17:10:05

Lowest Band Edge / Full RB

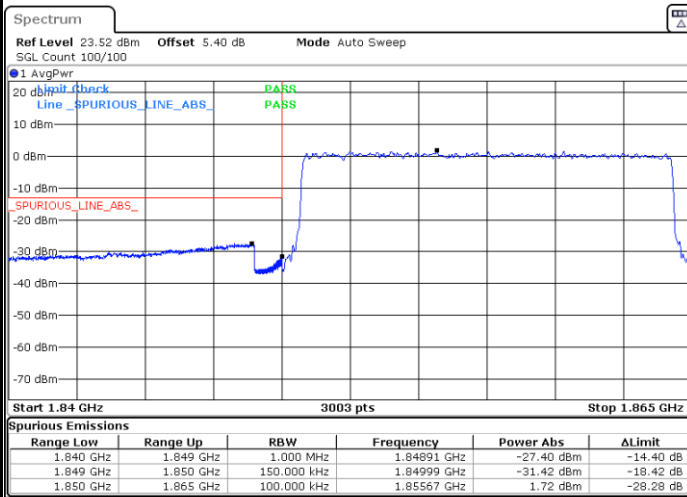

Date: 30.DEC.2021 17:07:12

Highest Band Edge / Full RB

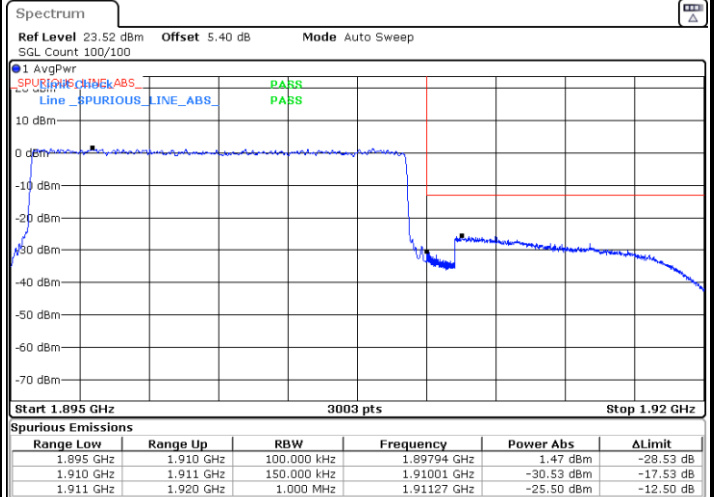

Date: 30.DEC.2021 17:13:00



LTE Band 2 / 15MHz / 16QAM

Lowest Band Edge / 1 RB

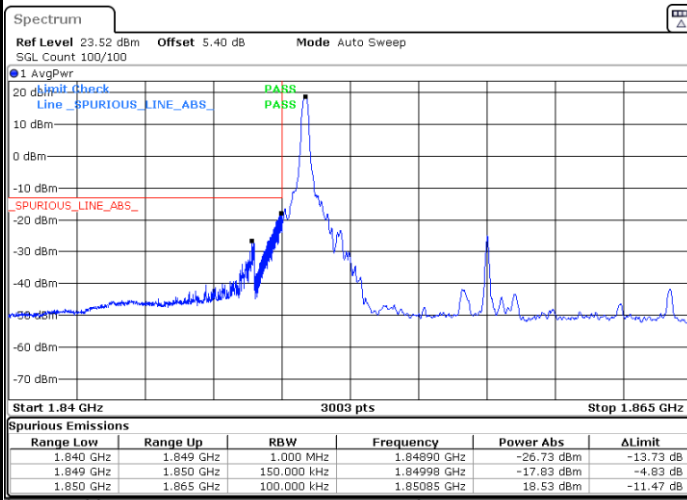

Date: 30.DEC.2021 17:05:44

Highest Band Edge / 1 RB

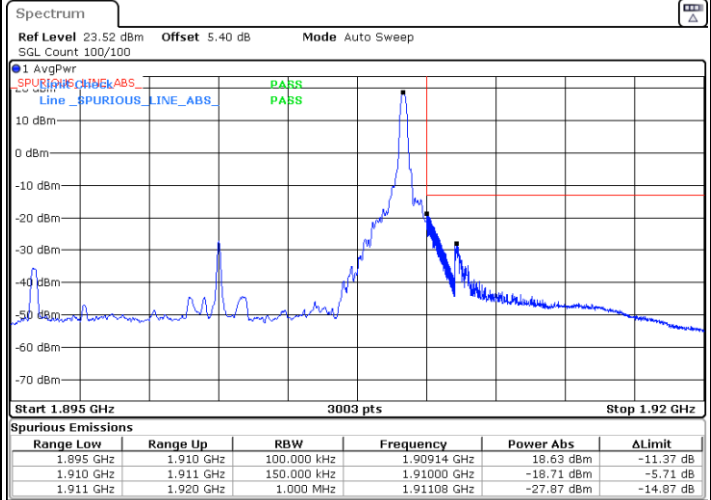

Date: 30.DEC.2021 17:11:32

Lowest Band Edge / Full RB

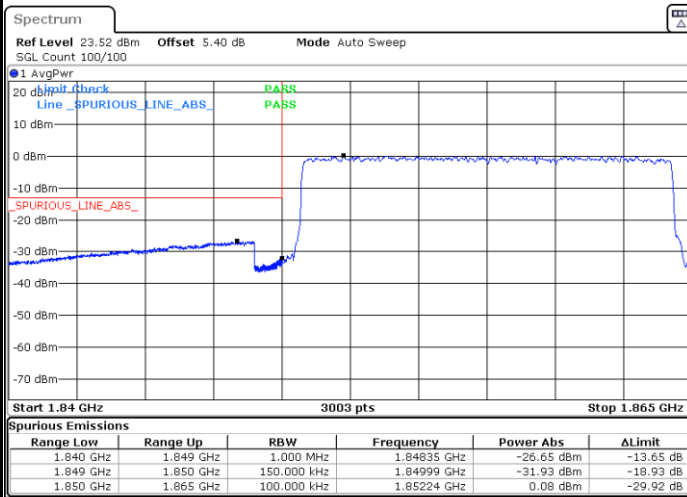

Date: 30.DEC.2021 17:08:39

Highest Band Edge / Full RB

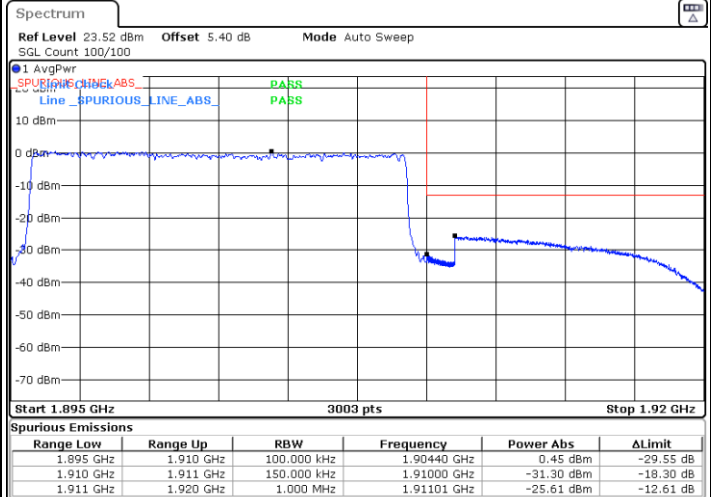

Date: 30.DEC.2021 17:14:27



LTE Band 2 / 15MHz / 64QAM

Lowest Band Edge / 1 RB

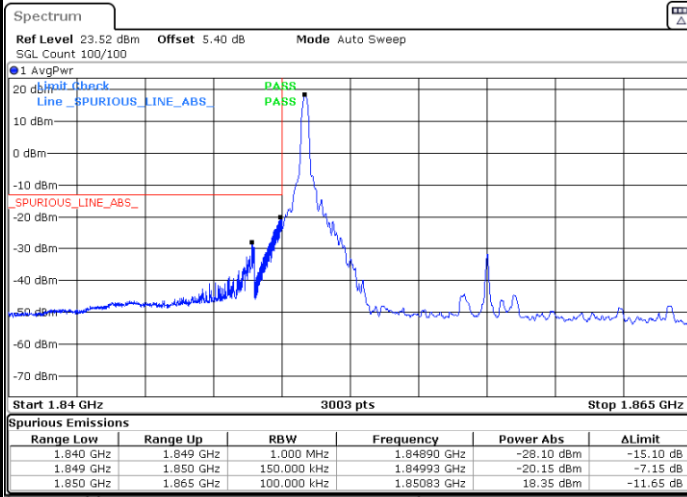

Date: 30.DEC.2021 17:50:34

Highest Band Edge / 1 RB

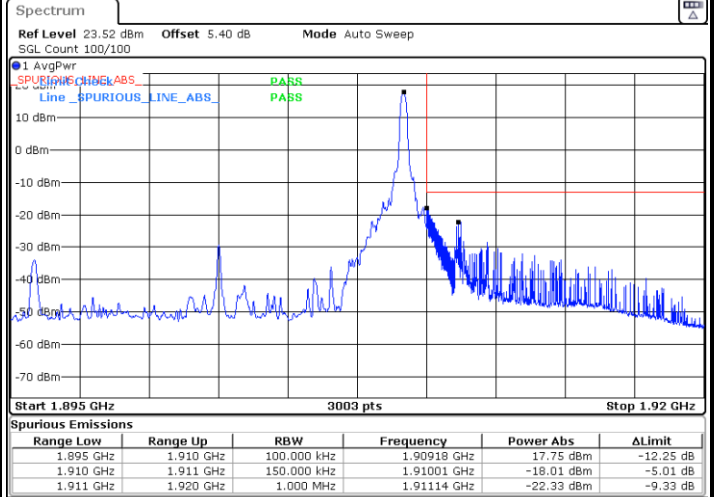

Date: 30.DEC.2021 17:53:27

Lowest Band Edge / Full RB

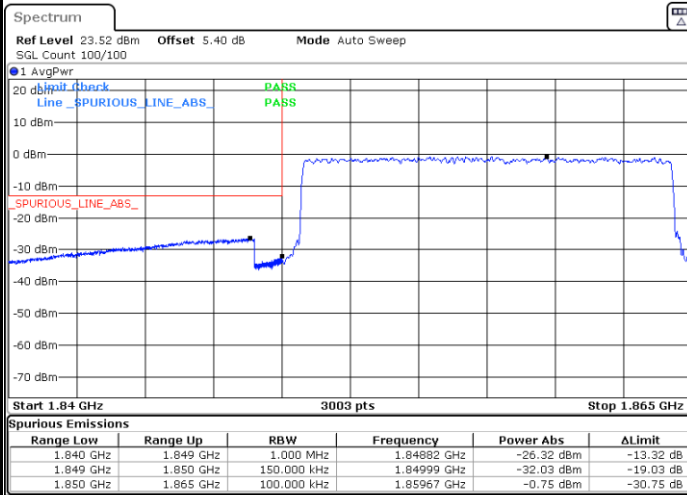

Date: 30.DEC.2021 17:52:00

Highest Band Edge / Full RB

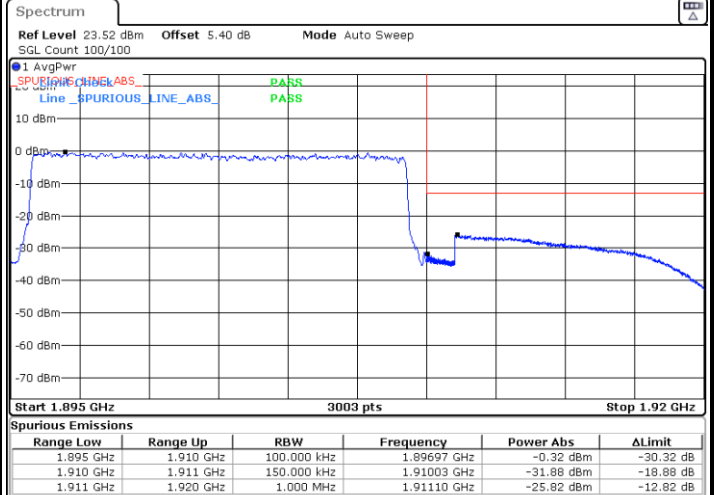

Date: 30.DEC.2021 17:54:53



LTE Band 2 / 20MHz / QPSK

Lowest Band Edge / 1 RB

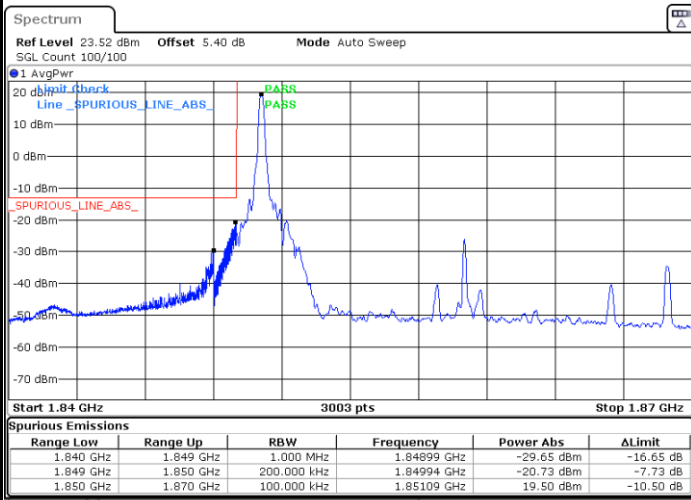

Date: 30.DEC.2021 17:15:55

Highest Band Edge / 1 RB

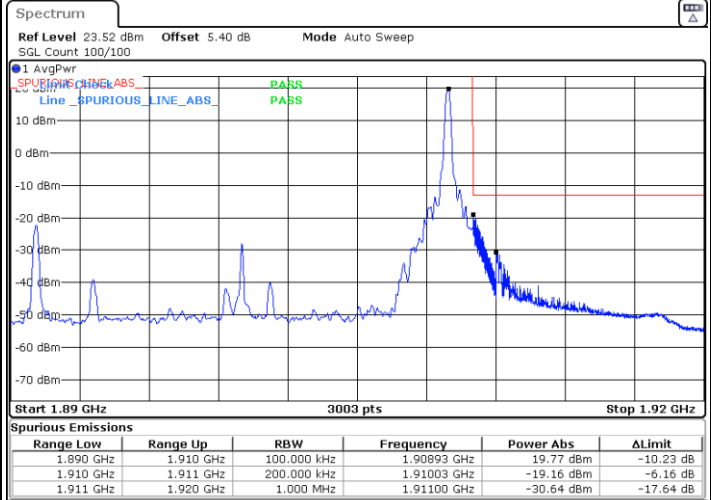

Date: 30.DEC.2021 17:21:42

Lowest Band Edge / Full RB

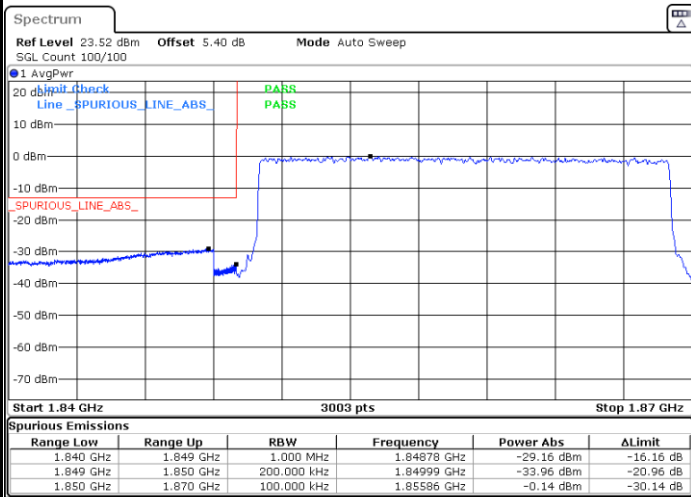

Date: 30.DEC.2021 17:18:49

Highest Band Edge / Full RB

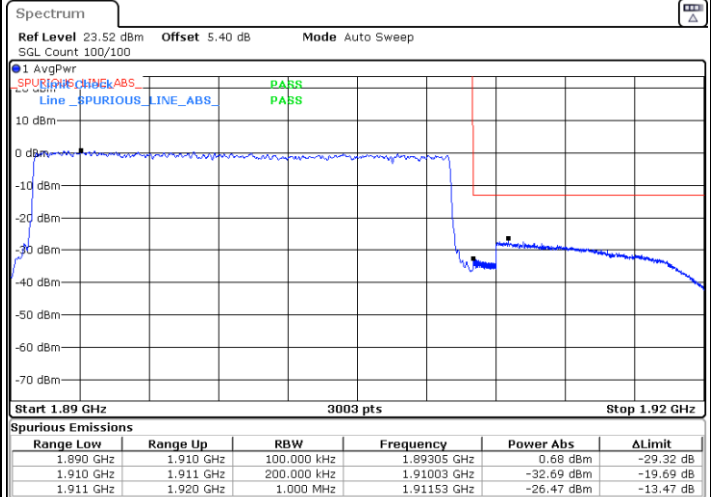

Date: 30.DEC.2021 17:24:35



LTE Band 2 / 20MHz / 16QAM

Lowest Band Edge / 1 RB

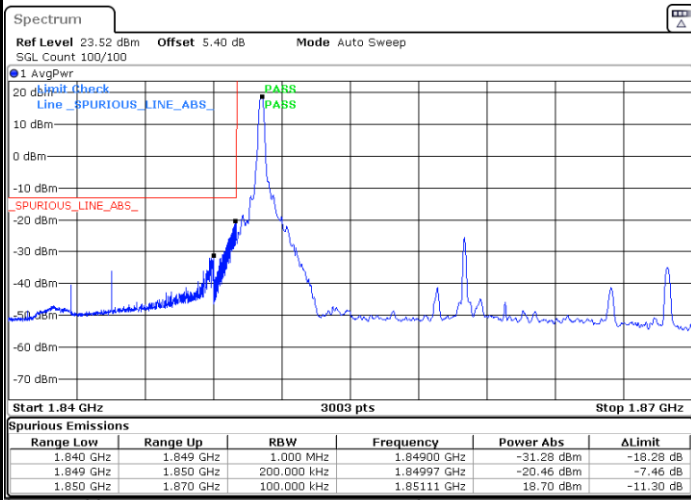

Date: 30.DEC.2021 17:17:22

Highest Band Edge / 1 RB

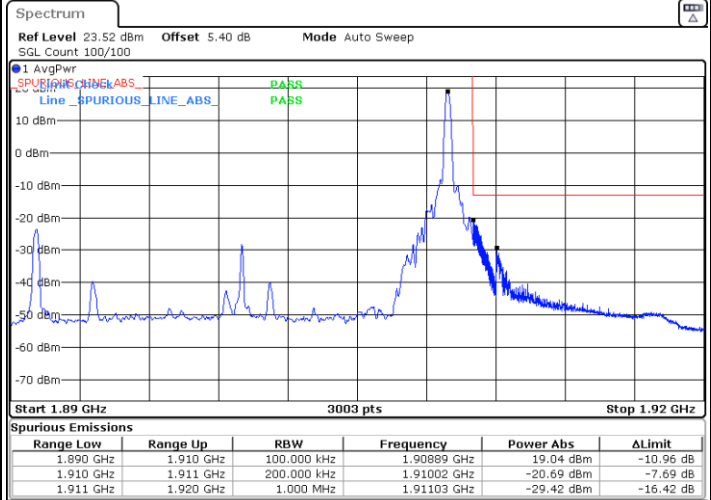

Date: 30.DEC.2021 17:23:09

Lowest Band Edge / Full RB

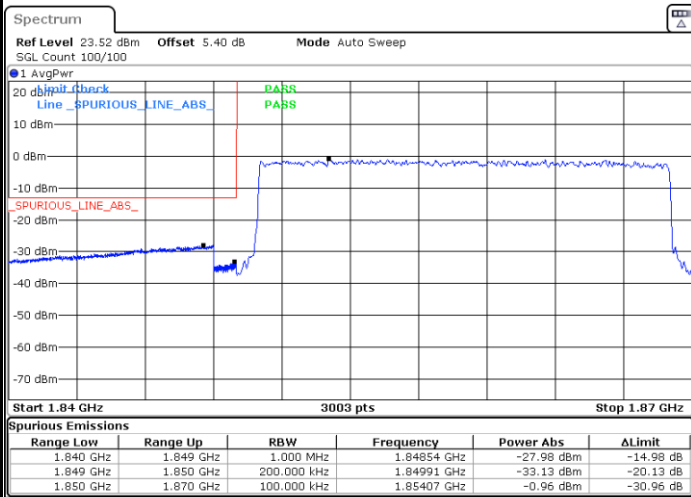

Date: 30.DEC.2021 17:20:15

Highest Band Edge / Full RB

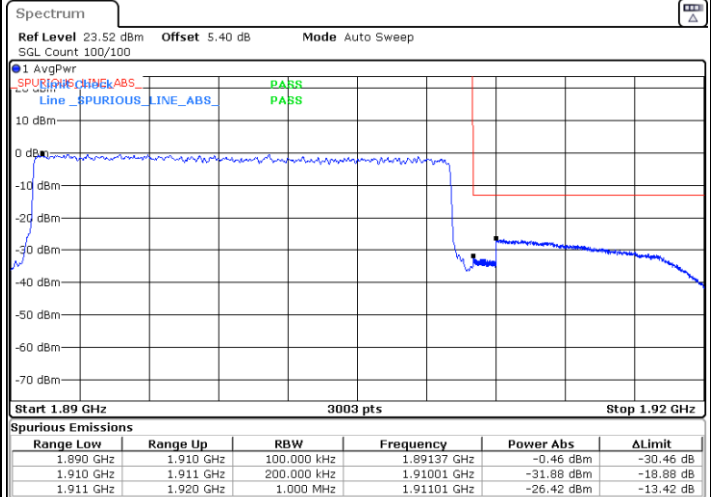

Date: 30.DEC.2021 17:26:01



LTE Band 2 / 20MHz / 64QAM

Lowest Band Edge / 1 RB

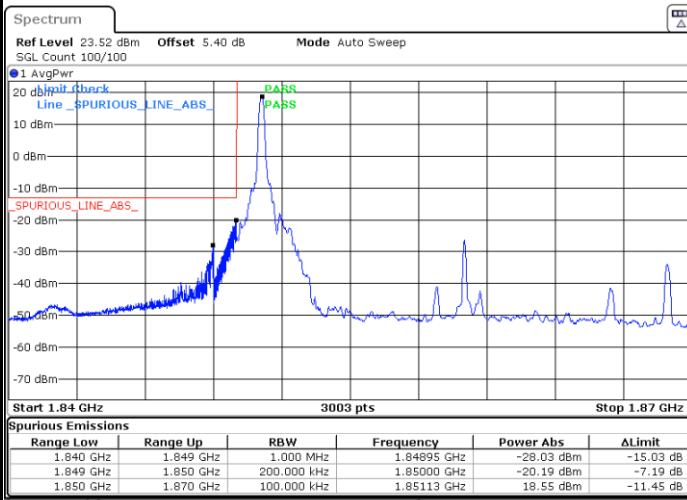

Date: 31.DEC.2021 05:33:02

Highest Band Edge / 1 RB

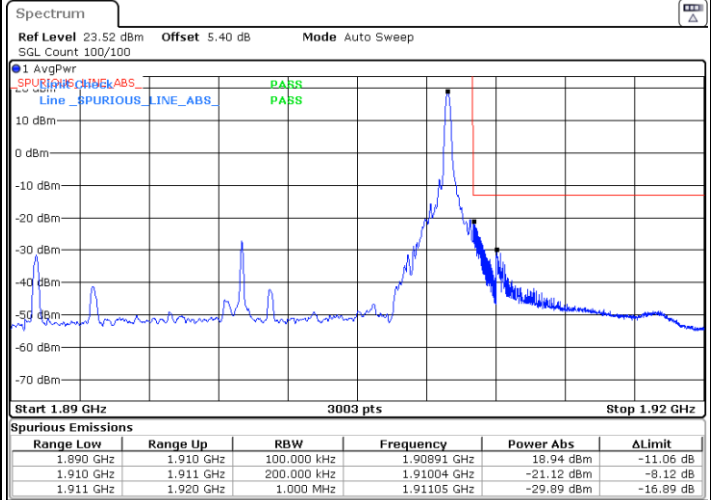

Date: 30.DEC.2021 20:13:45

Lowest Band Edge / Full RB

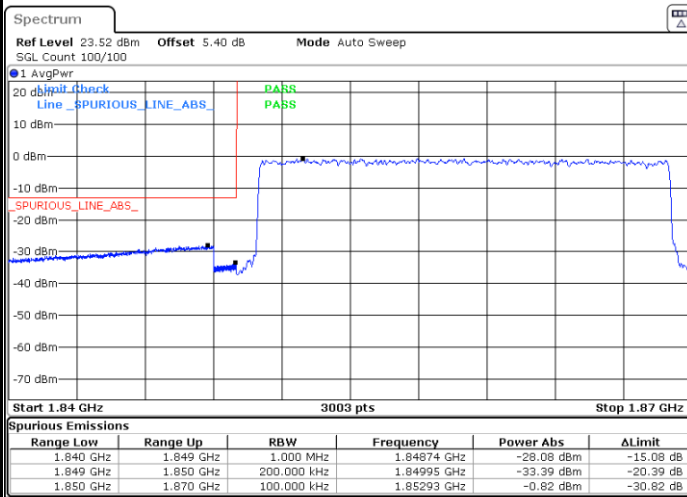

Date: 30.DEC.2021 20:12:19

Highest Band Edge / Full RB

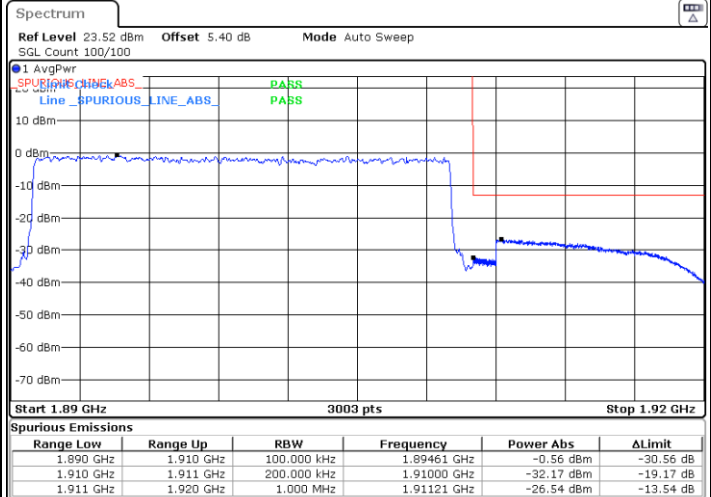

Date: 30.DEC.2021 20:15:12



Conducted Spurious Emission

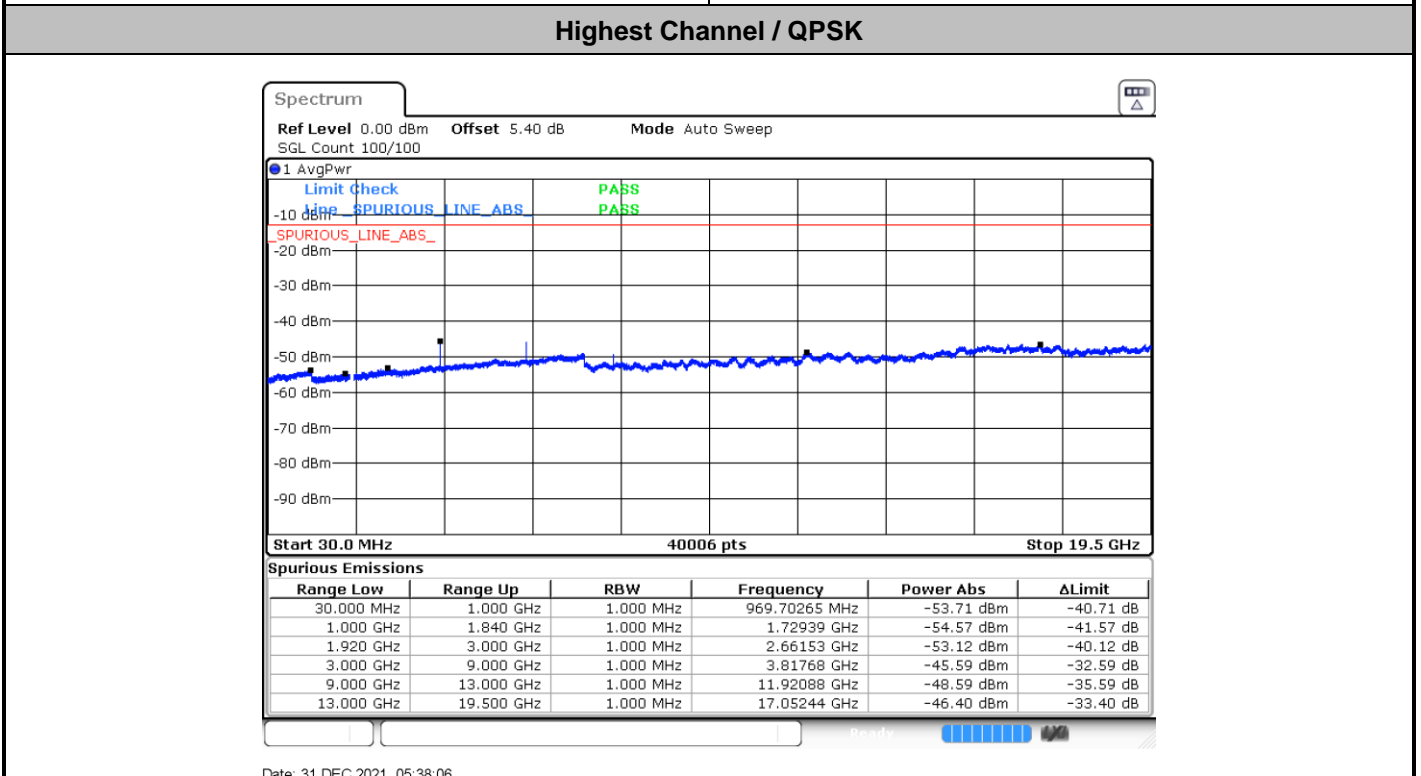
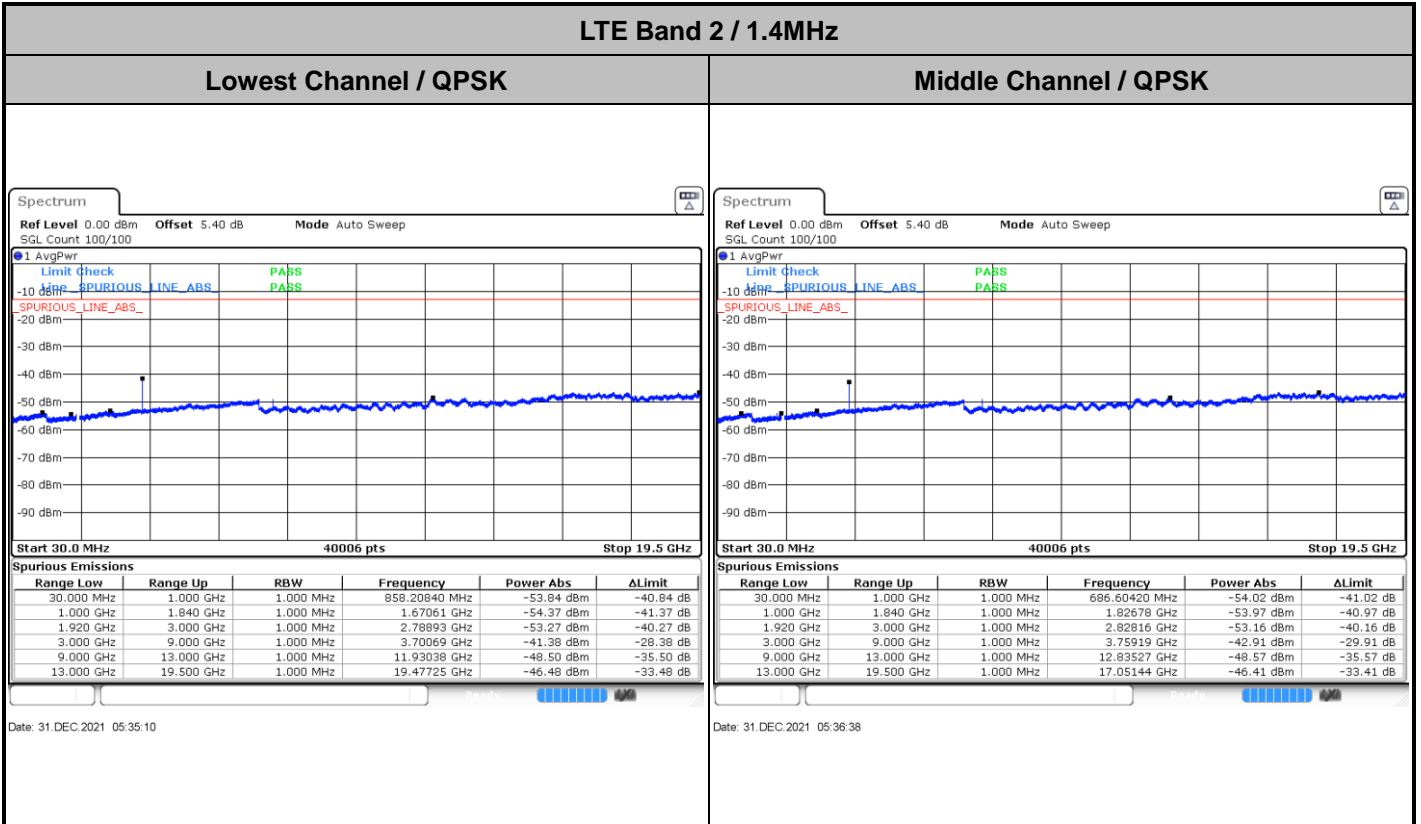



LTE Band 2 / 3MHz

Lowest Channel / QPSK

Middle Channel / QPSK

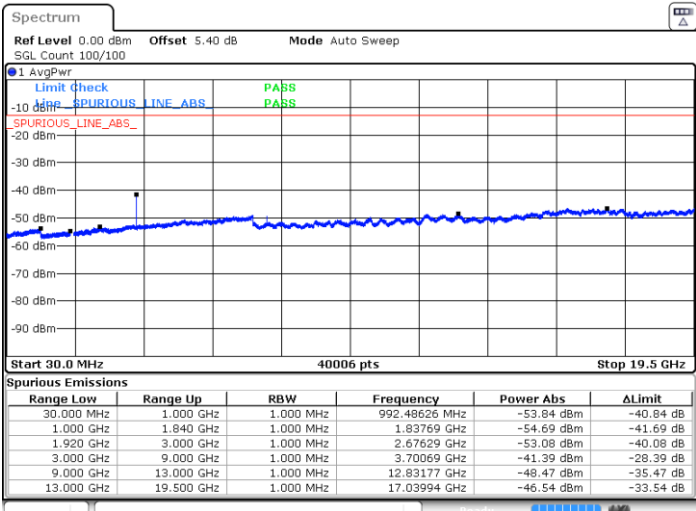

Date: 31 DEC 2021 05:39:35

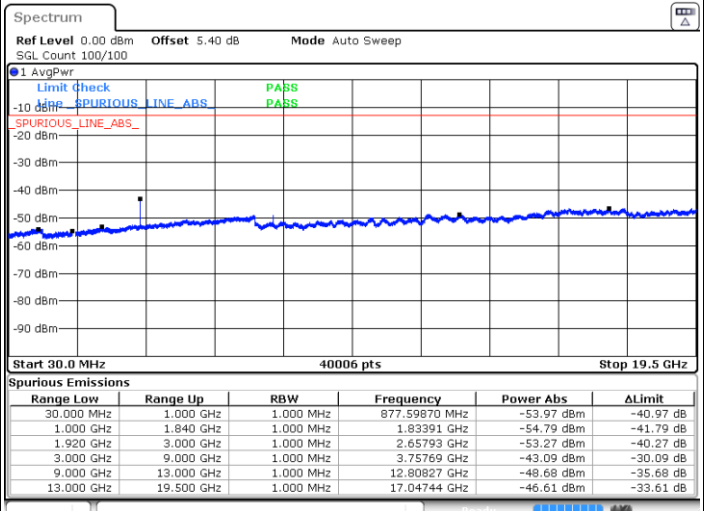

Date: 31 DEC 2021 05:41:04

Highest Channel / QPSK

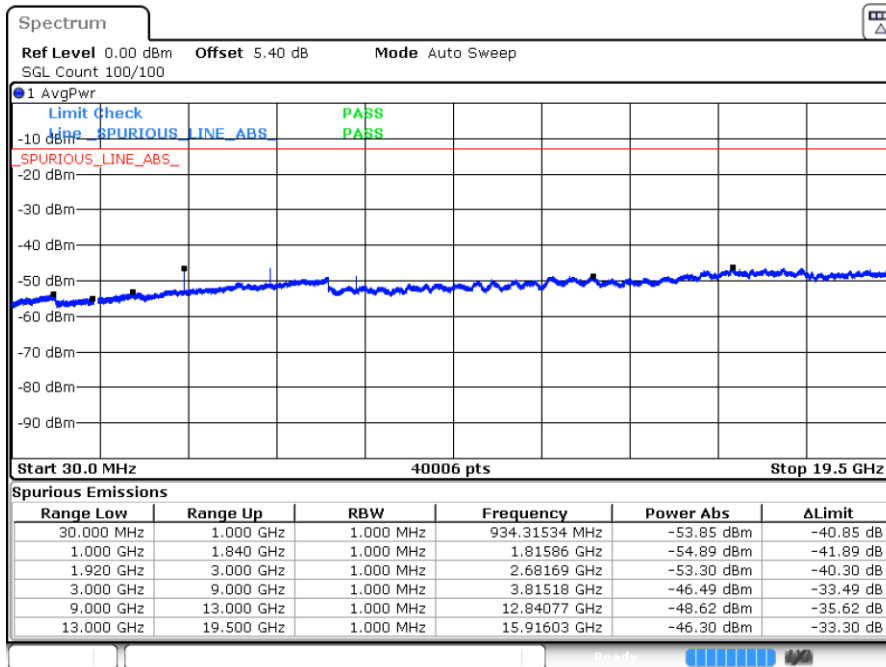

Date: 31 DEC 2021 05:42:32



LTE Band 2 / 5MHz

Lowest Channel / QPSK

Middle Channel / QPSK

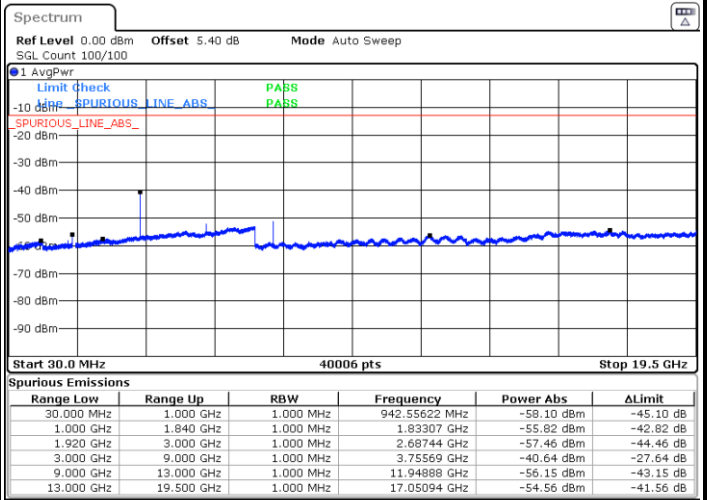
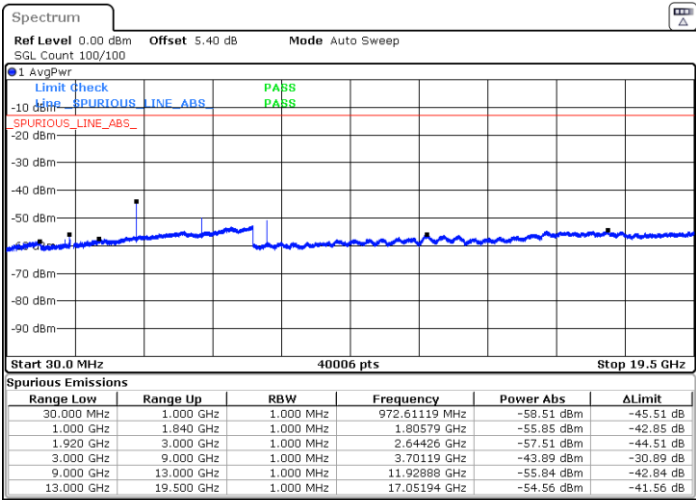

Date: 31 DEC 2021 05:44:01

Date: 31 DEC 2021 05:45:29

Highest Channel / QPSK

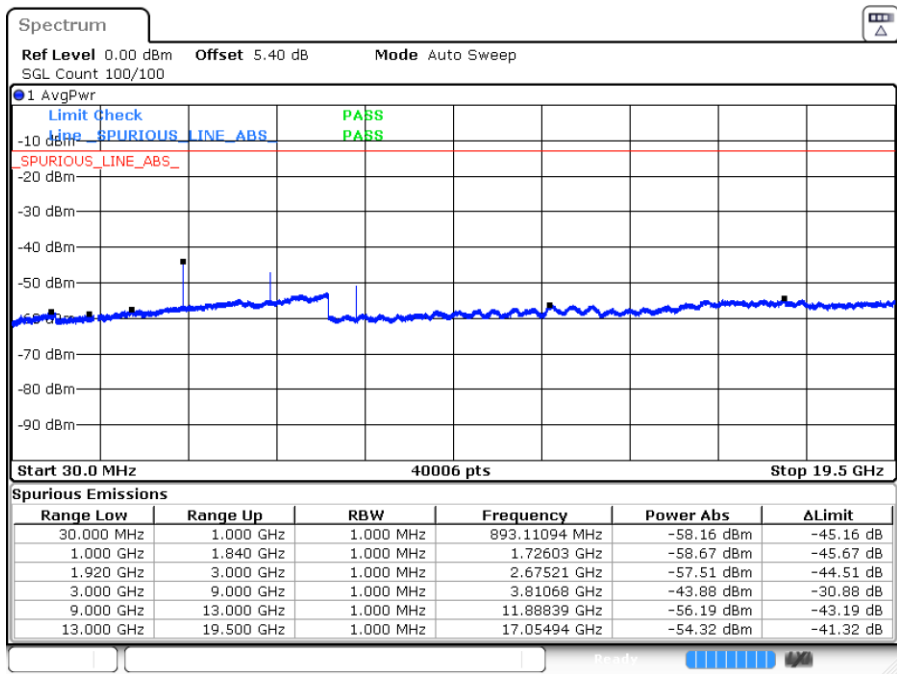

Date: 31 DEC 2021 05:46:57



LTE Band 2 / 10MHz

Lowest Channel / QPSK

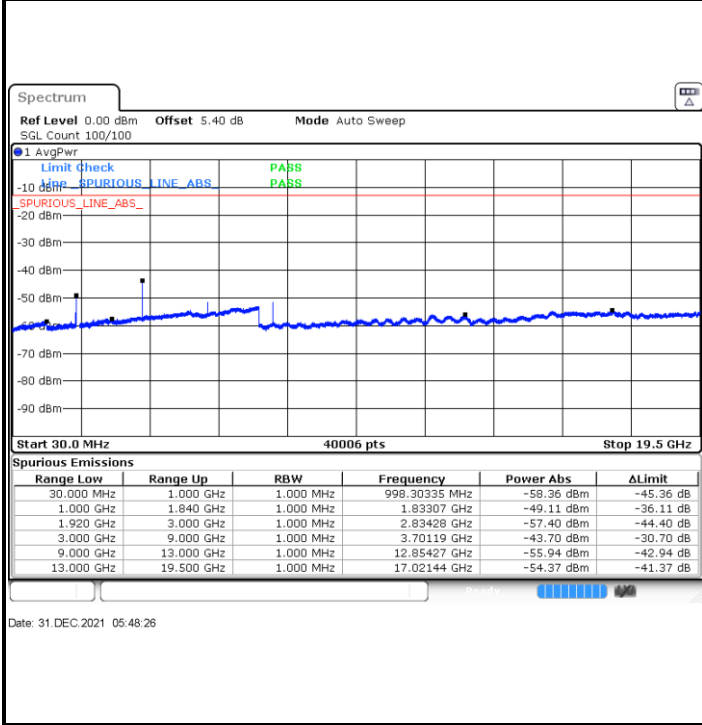

Middle Channel / QPSK

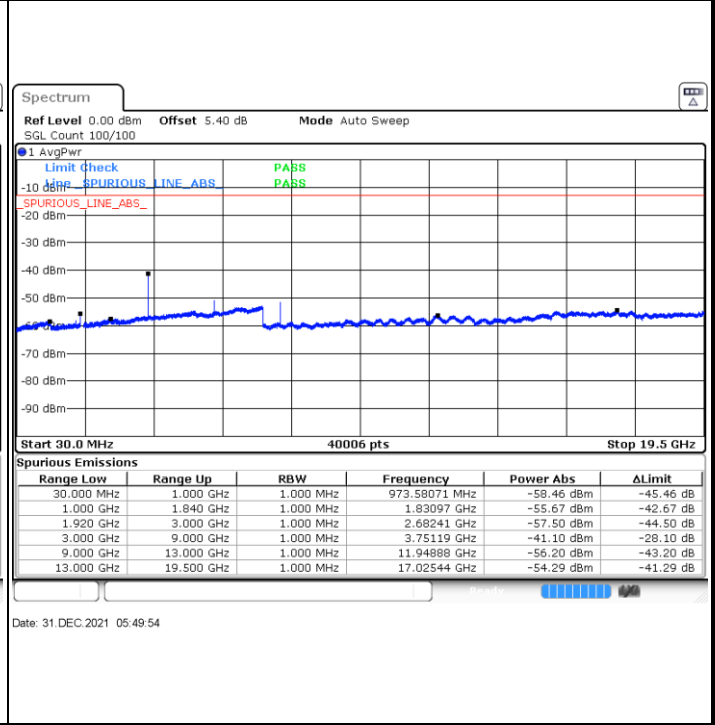

Highest Channel / QPSK

